



PCTEST ENGINEERING LABORATORY, INC.

6660-B Dobbin Road, Columbia, MD 21045 USA
Tel. 410.290.6652 / Fax 410.290.6554
<http://www.pctestlab.com>



SAR COMPLIANCE EVALUATION REPORT

Applicant Name:
Samsung Electronics, Co. Ltd.
18600 Broadwick St.
Rancho Dominguez, CA 90220
United States

Date of Testing:
11/10/09 - 11/11/09
Test Site/Location:
PCTEST Lab, Columbia, MD, USA
Test Report Serial No.:
0911092037.A3L

FCC ID: A3LGTI6500U

APPLICANT: SAMSUNG ELECTRONICS, CO. LTD.

EUT Type: 850/1900 GSM/GPRS/EDGE and 850 WCDMA/HSPA Phone with Bluetooth and WLAN
Application Type: Certification
FCC Rule Part(s): CFR §2.1093; FCC/OET Bulletin 65 Supplement C [July 2001]
FCC Classification: Licensed Transmitter Held to Ear (PCE)
Digital Transmission System (DTS)
Model(s): GT-I6500U
Tx Frequency: 824.20 - 848.80 MHz (GSM 850)
1850.20 - 1909.80 MHz (GSM 1900)
826.40 - 846.60 MHz (UMTS V)
2412 - 2462 MHz (WLAN)
Conducted Power: 31.83 dBm GSM 850 / 29.47 dBm GSM 1900
22.55 dBm UMTS V / 18.62 dBm 2.4 GHz WLAN
Max. SAR Measurement: 0.15 W/kg GSM 850 Head SAR / 0.26 W/kg GSM 850 Body SAR
0.35 W/kg GSM 1900 Head SAR / 0.29 W/kg GSM 1900 Body SAR
0.15 W/kg UMTS V Head SAR / 0.14 W/kg UMTS V Body SAR
0.1 W/kg 2.4 GHz WLAN Body SAR
Test Device Serial No.: Pre-Production [S/N: FG-316-A]

This wireless portable device has been shown to be capable of compliance for localized specific absorption rate (SAR) for uncontrolled environment/general population exposure limits specified in ANSI/IEEE C95.1-1992 and has been tested in accordance with the measurement procedures specified in FCC/OET Bulletin 65 Supplement C (2001), IEEE 1528-2003 and in applicable Industry Canada Radio Standards Specifications (RSS); for North American frequency bands only.

I attest to the accuracy of data. All measurements reported herein were performed by me or were made under my supervision and are correct to the best of my knowledge and belief. I assume full responsibility for the completeness of these measurements and vouch for the qualifications of all persons taking them. Test results reported herein relate only to the item(s) tested.

PCTEST certifies that no party to this application has been denied the FCC benefits pursuant to Section 5301 of the Anti-Drug Abuse Act of 1988, 21 U.S.C. 862.



Randy Ortanez
President



FCC ID: A3LGTI6500U		SAR COMPLIANCE REPORT		Reviewed by: Quality Manager
Filename: 0911092037.A3L	Test Dates: 11/10/09 - 11/11/09	EUT Type: 850/1900 GSM/GPRS/EDGE and 850 WCDMA/HSPA Phone with Bluetooth and WLAN		Page 1 of 37

TABLE OF CONTENTS

1	INTRODUCTION	3
2	TEST SITE LOCATION	4
3	SAR MEASUREMENT SETUP	5
4	DASY E-FIELD PROBE SYSTEM	7
5	PROBE CALIBRATION PROCESS	8
6	PHANTOM AND EQUIVALENT TISSUES.....	9
7	DOSIMETRIC ASSESSMENT & PHANTOM SPECS.....	10
8	DEFINITION OF REFERENCE POINTS	11
9	TEST CONFIGURATION POSITIONS	12
10	RF EXPOSURE LIMITS	16
11	MEASUREMENT UNCERTAINTIES	17
12	SYSTEM VERIFICATION.....	18
13	FCC MULTI-TX AND ANTENNA SAR CONSIDERATIONS.....	20
14	FCC 3G MEASUREMENT PROCEDURES.....	21
15	SAR DATA SUMMARY	24
16	EQUIPMENT LIST.....	29
17	CONCLUSION.....	30
18	REFERENCES	31
19	SAR TEST SETUP PHOTOGRAPHS.....	33

FCC ID: A3LGT16500U		SAR COMPLIANCE REPORT		Reviewed by: Quality Manager
Filename: 0911092037.A3L	Test Dates: 11/10/09 - 11/11/09	EUT Type: 850/1900 GSM/GPRS/EDGE and 850 WCDMA/HSPA Phone with Bluetooth and WLAN		Page 2 of 37

1 INTRODUCTION

The FCC has adopted the guidelines for evaluating the environmental effects of radio frequency (RF) radiation in ET Docket 93-62 on Aug. 6, 1996 to protect the public and workers from the potential hazards of RF emissions due to FCC-regulated portable devices.[1]

The safety limits used for the environmental evaluation measurements are based on the criteria published by the American National Standards Institute (ANSI) for localized specific absorption rate (SAR) in IEEE/ANSI C95.1-1992 Standard for Safety Levels with Respect to Human Exposure to Radio Frequency Electromagnetic Fields, 3 kHz to 300 GHz[2] and Health Canada RF Exposure Guidelines Safety Code 6 [26]. The measurement procedure described in IEEE/ANSI C95.3-2002 Recommended Practice for the Measurement of Potentially Hazardous Electromagnetic Fields - RF and Microwave [3] is used for guidance in measuring the Specific Absorption Rate (SAR) due to the RF radiation exposure from the Equipment Under Test (EUT). These criteria for SAR evaluation are similar to those recommended by the International Committee for Non-Ionizing Radiation Protection (ICNIRP) in "Biological Effects and Exposure Criteria for Radiofrequency Electromagnetic Fields," Report No. Vol 74. SAR is a measure of the rate of energy absorption due to exposure to an RF transmitting source. SAR values have been related to threshold levels for potential biological hazards.

1.1 SAR Definition

Specific Absorption Rate is defined as the time derivative (rate) of the incremental energy (dU) absorbed by (dissipated in) an incremental mass (dm) contained in a volume element (dV) of a given density (ρ). It is also defined as the rate of RF energy absorption per unit mass at a point in an absorbing body (see Fig. 1-1).

$$SAR = \frac{d}{dt} \left(\frac{dU}{dm} \right) = \frac{d}{dt} \left(\frac{dU}{\rho dV} \right)$$

Figure 1-1
SAR Mathematical Equation



SAR is expressed in units of Watts per Kilogram (W/kg).

$$SAR = \frac{\sigma \cdot E^2}{\rho}$$

where:

- σ = conductivity of the tissue-simulating material (S/m)
- ρ = mass density of the tissue-simulating material (kg/m^3)
- E = Total RMS electric field strength (V/m)

NOTE: The primary factors that control rate of energy absorption were found to be the wavelength of the incident field in relation to the dimensions and geometry of the irradiated organism, the orientation of the organism in relation to the polarity of field vectors, the presence of reflecting surfaces, and whether conductive contact is made by the organism with a ground plane.[6]

FCC ID: A3LGT16500U		 PCTEST ENGINEERING LABORATORY, INC.		SAR COMPLIANCE REPORT				Reviewed by: Quality Manager
Filename: 0911092037.A3L	Test Dates: 11/10/09 - 11/11/09	EUT Type: 850/1900 GSM/GPRS/EDGE and 850 WCDMA/HSPA Phone with Bluetooth and WLAN		Page 3 of 37				

2 TEST SITE LOCATION

2.1 INTRODUCTION

The map at the right shows the location of the PCTEST LABORATORY in Columbia, Maryland. It is in proximity to the FCC Laboratory, the Baltimore-Washington International (BWI) airport, the city of Baltimore and Washington, DC (See Figure 2).

These measurement tests were conducted at the PCTEST Engineering Laboratory, Inc. facility in New Concept Business Park, Guilford Industrial Park, Columbia, Maryland. The site address is 6660-B Dobbin Road, Columbia, MD 21045. The test site is one of the highest points in the Columbia area with an elevation of 390 feet above mean sea level. The site coordinates are 39° 11'15" N latitude and 76° 49' 38" W longitude. The facility is 1.5 miles north of the FCC laboratory, and the ambient signal and ambient signal strength are approximately equal to those of the FCC laboratory. There are no FM or TV transmitters within 15 miles of the site. The detailed description of the measurement facility was found to be in compliance with the requirements of § 2.948 according to ANSI C63.4 on January 27, 2006 and Industry Canada.

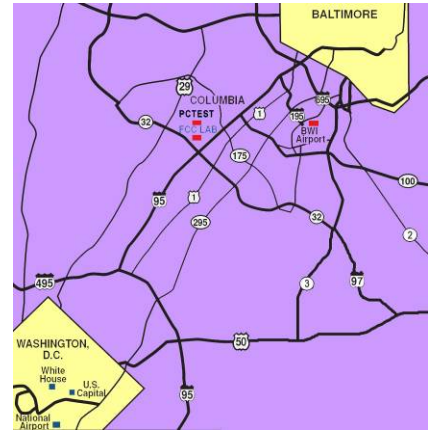



Figure 2-1
Map of the Greater Baltimore and Metropolitan Washington, D.C. area

2.2 Test Facility / Accreditations:

Measurements were performed at an independent accredited PCTEST Engineering Lab located in Columbia, MD 21045, U.S.A.



- PCTEST Lab is accredited to ISO 17025-2005 by the American Association for Laboratory Accreditation (A2LA) in Specific Absorption Rate (SAR) testing, Hearing-Aid Compatibility (HAC), CTIA Test Plans, and wireless testing for FCC and Industry Canada Rules.
- PCTEST Lab is accredited to ISO 17025 by U.S. National Institute of Standards and Technology (NIST) under the National Voluntary Laboratory Accreditation Program (NVLAP Lab code: 100431-0) in EMC, FCC and Telecommunications.
- PCTEST facility is an FCC registered (PCTEST Reg. No. 90864) test facility with the site description report on file and has met all the requirements specified in Section 2.948 of the FCC Rules and Industry Canada (IC-2451).
- PCTEST Lab is a recognized U.S. Conformity Assessment Body (CAB) in EMC and R&TTE (n.b. 0982) under the U.S.-EU Mutual Recognition Agreement (MRA).
- PCTEST TCB is a Telecommunication Certification Body (TCB) accredited to ISO/IEC Guide 65 by the American National Standards Institute (ANSI) in all scopes of FCC Rules and all Industry Canada Standards (RSS).
- PCTEST facility is an IC registered (IC-2451) test laboratory with the site description on file at Industry Canada.
- PCTEST is a CTIA Authorized Test Laboratory (CATL) for AMPS and CDMA, and EvDO mobile phones.
- PCTEST is a CTIA Authorized Test Laboratory (CATL) for Over-the-Air (OTA) Antenna Performance testing for AMPS, CDMA, GSM, GPRS, EGPRS, UMTS (W-CDMA), CDMA 1xEVDO Data, CDMA 1xRTT Data

FCC ID: A3LGT16500U		 SAR COMPLIANCE REPORT 		Reviewed by: Quality Manager
Filename: 0911092037.A3L	Test Dates: 11/10/09 - 11/11/09	EUT Type: 850/1900 GSM/GPRS/EDGE and 850 WCDMA/HSPA Phone with Bluetooth and WLAN		Page 4 of 37

3 SAR MEASUREMENT SETUP

3.1 Robotic System

Measurements are performed using the DASY4 automated dosimetric assessment system. The DASY4 is made by Schmid & Partner Engineering AG (SPEAG) in Zurich, Switzerland and consists of high precision robotics system (Staubli), robot controller, Pentium 4 computer, near-field probe, probe alignment sensor, and the generic twin phantom containing the brain equivalent material. The robot is a six-axis industrial robot performing precise movements to position the probe to the location (points) of maximum electromagnetic field (EMF) (see Figure 3-1).

3.2 System Hardware

A cell controller system contains the power supply, robot controller, teach pendant (Joystick), and a remote control used to drive the robot motors. The PC consists of the Gateway Pentium 4 2.53 GHz computer with Windows XP system and SAR Measurement Software DASY4, A/D interface card, monitor, mouse, and keyboard. The Staubli Robot is connected to the cell controller to allow software manipulation of the robot. A data acquisition electronic (DAE) circuit that performs the signal amplification, signal multiplexing, AD-conversion, offset measurements, mechanical surface detection, collision detection, etc. is connected to the Electro-optical coupler (EOC). The EOC performs the conversion from the optical into digital electric signal of the DAE and transfers data to the PC plug-in card.

3.3 System Electronics

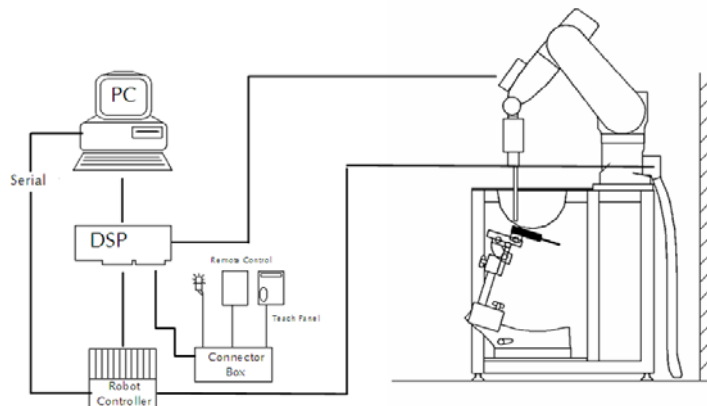



Figure 3-1
SAR Measurement System Setup

The DAE4 consists of a highly sensitive electrometer-grade preamplifier with auto-zeroing, a channel and gain-switching multiplexer, a fast 16 bit AD-converter and a command decoder and control logic unit. Transmission to the PC-card is accomplished through an optical downlink for data and status information and an optical uplink for commands and clock lines. The mechanical probe mounting device includes two different sensor systems for frontal and sidewise probe contacts. They are also used for mechanical surface detection and probe collision detection. The robot uses its own controller with a built in VME-bus computer. The system is described in detail in [7].

FCC ID: A3LGT16500U				SAR COMPLIANCE REPORT				Reviewed by: Quality Manager	
Filename: 0911092037.A3L	Test Dates: 11/10/09 - 11/11/09	EUT Type: 850/1900 GSM/GPRS/EDGE and 850 WCDMA/HSPA Phone with Bluetooth and WLAN							Page 5 of 37

3.4 Automated Test System Specifications

Positioner

Robot: Stäubli Unimation Corp. Robot RX60L
 Repeatability: 0.02 mm
 No. of Axes: 6

Data Acquisition Electronic System (DAE)

Cell Controller

Processor: Pentium 4
 Clock Speed: 2.53 GHz
 Operating System: Windows XP Professional

Data Converter

Features: Signal Amplifier, multiplexer, A/D converter & control logic
 Software: DASY4, SEMCAD software
 Connecting Lines: Optical Downlink for data and status info
 Optical upload for commands and clock

PC Interface Card



Function: 166MHz low power Pentium MMX 32MB chipdisk
 Link to DAE
 16-bit A/D converter for surface detection system
 Two Serial & Ethernet link to robotics
 Direct emergency stop output for robot

Phantom

Type: SAM Twin Phantom (V4.0)
 Shell Material: Composite
 Thickness: 2.0 ± 0.2 mm



**Figure 3-2
 DASY4 SAR Measurement System**

FCC ID: A3LGT16500U				SAR COMPLIANCE REPORT				Reviewed by: Quality Manager	
Filename: 0911092037.A3L	Test Dates: 11/10/09 - 11/11/09	EUT Type: 850/1900 GSM/GPRS/EDGE and 850 WCDMA/HSPA Phone with Bluetooth and WLAN							Page 6 of 37

4.1 Probe Measurement System



Figure 4-1
SAR System

The SAR measurements were conducted with the dosimetric probe EX3DV4, designed in the classical triangular configuration [7] (see Figure 4-3) and optimized for dosimetric evaluation. The probe is constructed using the thick film technique; with printed resistive lines on ceramic substrates. The probe is equipped with an optical multi-fiber line ending at the front of the probe tip. It is connected to the EOC box on the robot arm and provides an automatic detection of the phantom surface. Half of the fibers are connected to a pulsed infrared transmitter, the other half to a synchronized receiver. As the probe approaches the surface, the reflection from the surface produces a coupling from the transmitting to the receiving fibers. This reflection increases first during the approach, reaches maximum and then decreases. If the probe is flatly touching the surface, the coupling is zero. The distance of the coupling maximum to the surface is independent of the surface reflectivity and largely independent of the surface to probe angle. The DASY4 software reads the reflection during a software approach

and looks for the maximum using a 2nd order fitting (see Figure 5-1). The approach is stopped at reaching the maximum.

4.2 Probe Specifications



Model:	ES3DV3, EX3DV4
Frequency Range:	10 MHz – 6.0 GHz (EX3DV4) 10 MHz – 4 GHz (ES3DV3)
Calibration:	In brain and muscle simulating tissue at Frequencies from 835 up to 5800MHz
Linearity:	± 0.2 dB (30 MHz to 6 GHz) for EX3DV4 ± 0.2 dB (30 MHz to 4 GHz) for ES3DV3
Dynamic Range:	10 mW/kg – 100 W/kg
Probe Length:	330 mm
Probe Tip Length:	20 mm
Body Diameter:	12 mm
Tip Diameter:	2.5 mm (3.9mm for ES3DV3)
Tip-Center:	1 mm (2.0 mm for ES3DV3)
Application:	SAR Dosimetry Testing Compliance tests of mobile phones Dosimetry in strong gradient fields



Figure 4-2
Near-Field Probe



Figure 4-3
Triangular Probe
Configuration

FCC ID: A3LGT16500U				SAR COMPLIANCE REPORT				Reviewed by: Quality Manager	
Filename: 0911092037.A3L	Test Dates: 11/10/09 - 11/11/09	EUT Type: 850/1900 GSM/GPRS/EDGE and 850 WCDMA/HSPA Phone with Bluetooth and WLAN							Page 7 of 37

5 PROBE CALIBRATION PROCESS

5.1 Dosimetric Assessment Procedure

Each E-Probe/Probe amplifier combination has unique calibration parameters. A TEM cell calibration procedure is conducted to determine the proper amplifier settings to enter in the probe parameters. The amplifier settings are determined for a given frequency by subjecting the probe to a known E-field density (1 mW/cm²) using an RF Signal generator, TEM cell, and RF Power Meter.

5.2 Free Space Assessment

The free space E-field from amplified probe outputs is determined in a test chamber. This calibration can be performed in a TEM cell if the frequency is below 1 GHz and in a waveguide or other methodologies above 1 GHz for free space. For the free space calibration, the probe is placed in the volumetric center of the cavity and at the proper orientation with the field. The probe is rotated 360 degrees until the three channels show the maximum reading. The power density readings equates to 1 mW/cm².

5.3 Temperature Assessment

E-field temperature correlation calibration is performed in a flat phantom filled with the appropriate simulated brain tissue. The E-field in the medium correlates with the temperature rise in the dielectric medium. For temperature correlation calibration a RF transparent thermistor-based temperature probe is used in conjunction with the E-field probe.

$$SAR = C \frac{\Delta T}{\Delta t}$$

where:

- Δt = exposure time (30 seconds),
- C = heat capacity of tissue (brain or muscle),
- ΔT = temperature increase due to RF exposure.

$$SAR = \frac{|E|^2 \cdot \sigma}{\rho}$$

where:

- σ = simulated tissue conductivity,
- ρ = Tissue density (1.25 g/cm³ for brain tissue)



SAR is proportional to $\Delta T/\Delta t$, the initial rate of tissue heating, before thermal diffusion takes place. Now it's possible to quantify the electric field in the simulated tissue by equating the thermally derived SAR to the E- field;



Figure 5-1 E-Field and Temperature measurements at 900MHz [7]



Figure 5-2 E-Field and temperature measurements at 1.9GHz [7]

FCC ID: A3LGT16500U				SAR COMPLIANCE REPORT				Reviewed by: Quality Manager	
Filename: 0911092037.A3L	Test Dates: 11/10/09 - 11/11/09	EUT Type: 850/1900 GSM/GPRS/EDGE and 850 WCDMA/HSPA Phone with Bluetooth and WLAN							Page 8 of 37

6

PHANTOM AND EQUIVALENT TISSUES

6.1 SAM Phantoms



Figure 6-1
SAM Phantoms

The SAM Twin Phantom V4.0 is constructed of a fiberglass shell integrated in a wooden table. The shape of the shell is based on data from an anatomical study designed to determine the maximum exposure in at least 90% of all users [11][12]. It enables the dosimetric evaluation of left and right hand phone usage as well as body mounted usage at the flat phantom region. A cover prevents the evaporation of the liquid. Reference markings on the Phantom allow the complete setup of all predefined phantom positions and measurement grids by manually teaching three points in the robot. (see Fig. 5.1)

6.2 Brain & Muscle Simulating Mixture Characterization

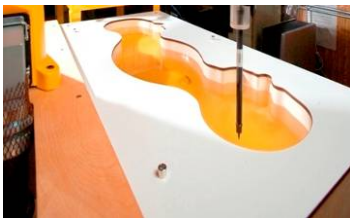

Figure 6-2
Head Simulated

The brain and muscle mixtures consist of a viscous gel using hydroxethylcellulose (HEC) gelling agent and saline solution (see Table 6-1). Preservation with a bactericide is added and visual inspection is made to make sure air bubbles are not trapped during the mixing process. The mixture is calibrated to obtain proper dielectric constant (permittivity) and conductivity of the desired tissue. The head tissue dielectric parameters recommended by the IEEE SCC-34/SC-2 have been incorporated in the following table. Other head and body tissue parameters that have not been specified in IEEE-1528 are derived from the tissue dielectric parameters computed from the 4-Cole-Cole equations. The mixture characterizations used for the brain and muscle tissue simulating liquids are according to the data by C. Gabriel and G. Hartsgrove [13].(See Table 6-1)

Table 6-1
Composition of the Brain & Muscle Tissue Equivalent Matter

Frequency (MHz)	300			450			835			900			1450			1800				1900		1950	2000	2100		2450		3000
Recipe #	1	1	3	1	1	2	3	1	1	2	2	3	1	2	2	3	1	2	4	1	1	2	2	3	2			
Ingredients: (% by weight)																												
1,2-Propanediol								64.81																				
Bactericide	0.19	0.19	0.50	0.10	0.10		0.50										0.50									0.50		
Diacerin			48.90				49.20									49.43											49.73	
DGBE									45.41	47.00	13.84	44.92			44.94	13.84	45.00	50.00	50.00	7.99	7.99					7.99		
HEC	0.98	0.98		1.00	1.00																							
NaCl	5.95	3.95	1.70	1.45	1.48	0.79	1.10	0.67	0.36	0.35	0.18	0.64	0.18	0.35										0.16	0.16	0.16		
Sucrose	55.32	56.32		57.00	56.50																							
Triton X-100											30.45						30.45							19.97	19.97	19.97		
Water	37.56	38.56	48.90	40.45	40.92	34.40	49.20	53.80	52.64	55.36	54.90	49.43	54.90	55.36	55.00	50.00	50.00	50.00	71.88	71.88				49.73	71.88			
Measured dielectric parameters																												
ϵ'_r	46.00	43.4	44.3	41.6	41.2	41.8	42.7	40.9	39.3	41	40.4	39.2	39.9	41	40.1	37	36.6	41.1	40.3	39.2	37.9							
σ (S/m)	0.86	0.85	0.9	0.9	0.98	0.97	0.99	1.21	1.39	1.38	1.4	1.4	1.42	1.38	1.41	1.4	1.51	1.55	1.88	1.82	2.46							
Temp. (°C)	22	22	20	22	22	22	20	22	22	21	22	20	21	21	20	22	22	20	20	20	20							
Target dielectric parameters (Table 2)																												
ϵ'_r	45.30	43.50	41.5		41.50		40.5						40.0						39.80		39.2	38.3						
σ (S/m)	0.87	0.87	0.9		0.97		1.2					1.4						1.49		1.8	2.4							

NOTE—Multiple columns for any single frequency are optional recipes. Recipe #, reference: 1 (Kanda et al. [B85]), 2 (Vignone [B145]), 3 (Oppman and Gabriel [B159]), 4 (Furuta et al. [B59]).

*The formulas containing Triton X-100 and corresponding measured parameters are under review and verification.

FCC ID: A3LGT16500U				SAR COMPLIANCE REPORT				Reviewed by: Quality Manager	
Filename: 0911092037.A3L	Test Dates: 11/10/09 - 11/11/09	EUT Type: 850/1900 GSM/GPRS/EDGE and 850 WCDMA/HSPA Phone with Bluetooth and WLAN							Page 9 of 37

7.1 Measurement Procedure

The evaluation was performed using the following procedure:

1. The SAR measurement was taken at a selected spatial reference point to monitor power variations during testing. This fixed point was measured and used as a reference value.
2. The SAR distribution at the exposed side of the head was measured at a distance of 3.0mm from the inner surface of the shell. The area covered the entire dimension of the head and the horizontal grid spacing was 15mm x 15mm.
3. Based on the area scan data, the area of the maximum absorption was determined by spline interpolation. Around this point, a volume of 32mm x 32mm x 30mm (fine resolution volume scan, zoom scan) was assessed by measuring 5 x 5 x 7 points. On this basis of this data set, the spatial peak SAR value was evaluated with the following procedure (see Figure 7-1):
 - a. The data at the surface was extrapolated, since the center of the dipoles is 2.7mm away from the tip of the probe and the distance between the surface and the lowest measuring point is 1.2mm. The extrapolation was based on a least square algorithm [15]. A polynomial of the fourth order was calculated through the points in z-axes. This polynomial was then used to evaluate the points between the surface and the probe tip.
 - b. The maximum interpolated value was searched with a straight-forward algorithm. Around this maximum the SAR values averaged over the spatial volumes (1g or 10g) were computed using the 3D-Spline interpolation algorithm. The 3D-spline is composed of three one-dimensional splines with the "Not a knot" condition (in x, y, and z directions) [15][16]. The volume was integrated with the trapezoidal algorithm. One thousand points (10 x 10 x 10) were interpolated to calculate the average.
 - c. All neighboring volumes were evaluated until no neighboring volume with a higher average value was found.
4. The SAR reference value, at the same location as step 1, was re-measured. If the value changed by more than 5%, the evaluation is repeated.

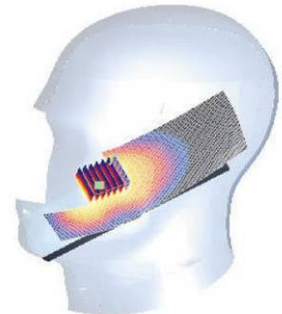



Figure 7-1
Sample SAR Area Scan

7.2 Specific Anthropomorphic Mannequin (SAM) Specifications

The phantom for handset SAR assessment testing is a low-loss dielectric shell, with shape and dimensions derived from the anthropometric data of the 90th percentile adult male head dimensions as tabulated by the US Army. The SAM Twin Phantom shell is bisected along the mid-sagittal plane into right and left halves (see Figure 7-2). The perimeter sidewalls of each phantom halves are extended to allow filling with liquid to a depth that is sufficient to minimized reflections from the upper surface. The liquid depth is maintained at a minimum depth of 15cm to minimize reflections from the upper surface.



Figure 7-2
SAM Twin Phantom Shell

FCC ID: A3LGT16500U				SAR COMPLIANCE REPORT				Reviewed by: Quality Manager	
Filename: 0911092037.A3L	Test Dates: 11/10/09 - 11/11/09	EUT Type: 850/1900 GSM/GPRS/EDGE and 850 WCDMA/HSPA Phone with Bluetooth and WLAN							Page 10 of 37

8.1 EAR REFERENCE POINT

Figure 8-1 shows the front, back and side views of the SAM Twin Phantom. The point “M” is the reference point for the center of the mouth, “LE” is the left ear reference point (ERP), and “RE” is the right ERP. The ERP is 15mm posterior to the entrance to the ear canal (EEC) along the B-M line (Back-Mouth), as shown in Figure 8-1. The plane passing through the two ear canals and M is defined as the Reference Plane. The line N-F (Neck-Front) is perpendicular to the reference plane and passing through the RE (or LE) is called the Reference Pivoting Line (see Figure 8-2). Line B-M is perpendicular to the N-F line. Both N-F and B-M lines are marked on the external phantom shell to facilitate handset positioning [5].

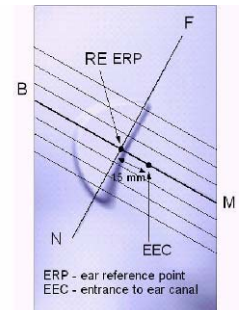

Figure 8-1
Close-Up Side view
of ERP

8.2 HANDSET REFERENCE POINTS

Two imaginary lines on the handset were established: the vertical centerline and the horizontal line. The test device was placed in a normal operating position with the “test device reference point” located along the “vertical centerline” on the front of the device aligned to the “ear reference point” (See Figure 8-3). The “test device reference point” was then located at the same level as the center of the ear reference point. The test device was positioned so that the “vertical centerline” was bisecting the front surface of the handset at its top and bottom edges, positioning the “ear reference point” on the outer surface of the both the left and right head phantoms on the ear reference point.



Figure 8-2
Front, back and side view of SAM Twin Phantom

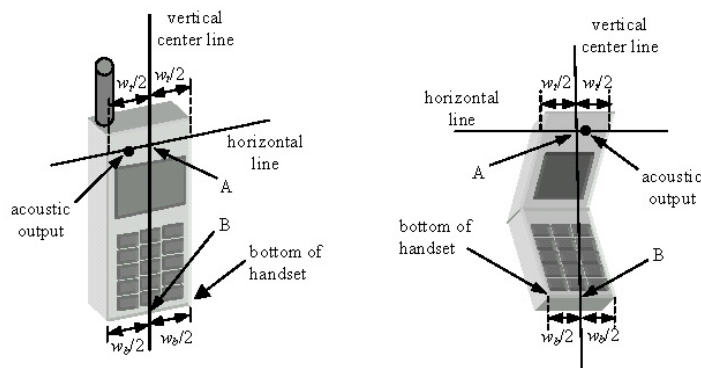



Figure 8-3
Handset Vertical Center & Horizontal Line Reference Points

FCC ID: A3LGT16500U				SAR COMPLIANCE REPORT				Reviewed by: Quality Manager	
Filename: 0911092037.A3L	Test Dates: 11/10/09 - 11/11/09	EUT Type: 850/1900 GSM/GPRS/EDGE and 850 WCDMA/HSPA Phone with Bluetooth and WLAN							Page 11 of 37

9

TEST CONFIGURATION POSITIONS

9.1 Positioning for Cheek/Touch

1. The test device was positioned with the handset close to the surface of the phantom such that point A is on the (virtual) extension of the line passing through points RE and LE on the phantom (see Figure 9-1), such that the plane defined by the vertical center line and the horizontal line of the phone is approximately parallel to the sagittal plane of the phantom.





Figure 9-1 Front, Side and Top View of Cheek/Touch Position

2. The handset was translated towards the phantom along the line passing through RE & LE until the handset touches the ear.
3. While maintaining the handset in this plane, the handset was rotated around the LE-RE line until the vertical centerline was in the plane normal to MB-NF including the line MB (reference plane).
4. The phone was then rotated around the vertical centerline until the phone (horizontal line) was symmetrical with respect to the line NF.
5. While maintaining the vertical centerline in the reference plane, keeping point A on the line passing through RE and LE, and maintaining the phone contact with the ear, the handset was rotated about the line NF until any point on the handset made contact with a phantom point below the ear (cheek). See Figure 9-2)

9.2 Positioning for Ear / 15° Tilt

With the test device aligned in the “Cheek/Touch Position”:

1. While maintaining the orientation of the phone, the phone was retracted parallel to the reference plane far enough to enable a rotation of the phone by 15 degree.
2. The phone was then rotated around the horizontal line by 15 degree.
3. While maintaining the orientation of the phone, the phone was moved parallel to the reference plane until any part of the phone touches the head. (In this position, point A was located on the line RE-LE). The tilted position is obtained when the contact is on the pinna. If the contact was at any location other than the pinna, the angle of the phone would then be reduced. The tilted position was obtained when any part of the phone was in contact of the ear as well as a second part of the phone was in contact with the head (see Figure 9-3).

FCC ID: A3LGT16500U				SAR COMPLIANCE REPORT				Reviewed by: Quality Manager	
Filename: 0911092037.A3L	Test Dates: 11/10/09 - 11/11/09	EUT Type: 850/1900 GSM/GPRS/EDGE and 850 WCDMA/HSPA Phone with Bluetooth and WLAN							Page 12 of 37

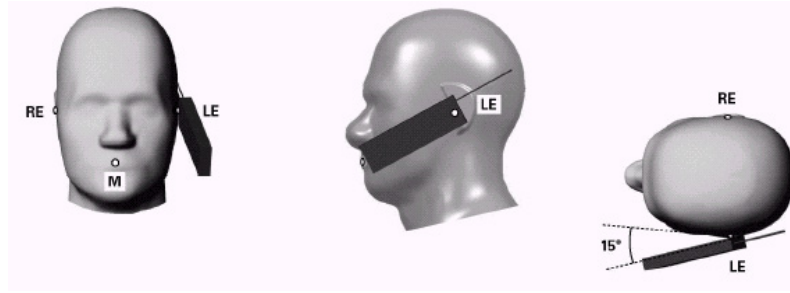

Figure 9-2 Front, Side and Top View of Ear/15° Tilt Position



Figure 9-3 Side view w/ relevant markings



Figure 9-4 Body SAR Sample Photo (Not Actual EUT)



9.3 SAR Evaluations near the Mouth/Jaw Regions of the SAM Phantom

Antennas located near the bottom of a phone may require SAR measurements around the mouth and jaw regions of the SAM head phantom. This typically applies to clam-shell style phones that are generally longer in the unfolded normal use positions or to certain older style long rectangular phones. It has been known for some time that there are SAR measurement difficulties in these regions of the SAM phantom. SAR probes are calibrated in tissue equivalent liquids with sufficient separation between the probe sensors and nearby physical boundaries to ensure scattering does not affect probe calibration. When the probe tip is moved into tight regions with multiple boundaries surrounding its sensors, probe calibration and measurement accuracy can become questionable. In addition, these measurement locations often require a probe to be tilted at steep angles, where it may no longer comply with calibration requirements and measurement protocols, or satisfy the required measurement uncertainty. In some situations it is not feasible to tilt the probe or rotate the phantom, as suggested by measurement standards, to conduct these measurements.



Figure 9-5 SAR Scans near the Jaw/Mouth

In order to ensure there is sufficient conservativeness for ensuring compliance until practical solutions are available, additional measurement considerations are necessary to address these technical difficulties.

FCC ID: A3LGT16500U				SAR COMPLIANCE REPORT				Reviewed by: Quality Manager	
Filename: 0911092037.A3L	Test Dates: 11/10/09 - 11/11/09	EUT Type: 850/1900 GSM/GPRS/EDGE and 850 WCDMA/HSPA Phone with Bluetooth and WLAN							Page 13 of 37

When measurements are required near the mouth, nose, jaw or similar tight regions of the SAM phantom, area or zoom scans are often unable to fully enclose the peak SAR location as required by IEEE 1528 and Supplement C, due to probe orientation and positioning difficulties. Even when limited measurements are possible, the test results could be questionable due to probe calibration and measurement uncertainty issues. Under these circumstances, the following procedures apply, adopted from the FCC guidance on SAR handsets document publication 648474. The SAR required in these regions of SAM should be measured using a flat phantom. **Rectangular shaped phones** should be positioned with its bottom edge positioned from the flat phantom with the same distance provided by the cheek touching position using SAM. The ear reference point (ERP, as defined for SAM) of the phone should be positioned ½ cm from the flat phantom shell. **Clam-shell phones** should be positioned with the hinge against a smooth edge of the flat phantom where the upper half of the phone is unfolded and extended beyond the phantom side wall. The lower half of the phone is secured in the test device holder at a fixed distance below the flat phantom determined by the minimum separation along the lower edge of the phone in the cheek touching position using SAM. Any case with substantial variation in separation distance along the lower edge of a clam shell is discussed with the FCC for best-to-use methodology.



The flat phantom data should allow test results to be compared uniformly across measurement systems, until suitable solutions are available in measurement standards to address certain probe calibration and positioning issues, due to implementation differences between horizontal and upright SAM configurations. These flat phantom procedures are only applicable for stand-alone SAR evaluation in tight regions of the SAM phantom, where measurement is not feasible or test results can be questionable due to probe calibration and accessibility issues. Details on device positioning and photos showing how separation distances are determined are included in the SAR report Photographs. SAR for other regions of the head must be evaluated using SAM; therefore, a phone with antennas at different locations may require flat and SAM phantom evaluation for the different antennas.

9.4 Body Holster /Belt Clip Configurations

Body-worn operating configurations are tested with the belt-clips and holsters attached to the device and positioned against a flat phantom in a normal use configuration (see Figure 9-5). A device with a headset output is tested with a headset connected to the device.

Accessories for Body-worn operation configurations are divided into two categories: those that do not contain metallic components and those that do contain metallic components. When multiple accessories that do not contain metallic components are supplied with the device, the device is tested with only the accessory that dictates the closest spacing to the body. Then multiple accessories that contain metallic components are tested with the device with each accessory. If multiple accessories share an identical metallic component (i.e. the same metallic belt-clip used with different holsters with no other metallic components) only the accessory that dictates the closest spacing to the body is tested.

Body-worn accessories may not always be supplied or available as options for some devices intended to be authorized for body-worn use. In this case, a test configuration with a separation distance between the back of the device and the flat phantom is used. Test position spacing was documented. Transmitters that are designed to operate in front of a person's face, as in push-to-talk configurations, are tested for SAR compliance with the front of the device positioned to face the flat phantom in brain fluid. For devices that are carried next to the body such as a shoulder, waist or chest-worn transmitters, SAR compliance is tested with the accessories, including headsets and microphones, attached to the device and positioned against a flat phantom in a normal use configuration.

FCC ID: A3LGT16500U				SAR COMPLIANCE REPORT				Reviewed by: Quality Manager	
Filename: 0911092037.A3L	Test Dates: 11/10/09 - 11/11/09	EUT Type: 850/1900 GSM/GPRS/EDGE and 850 WCDMA/HSPA Phone with Bluetooth and WLAN							Page 14 of 37

9.5 SAR Testing with IEEE 802.11 a/b/g Transmitters (if applicable)

Normal network operating configurations are not suitable for measuring the SAR of 802.11 a/b/g transmitters. Unpredictable fluctuations in network traffic and antenna diversity conditions can introduce undesirable variations in SAR results. The SAR for these devices should be measured using chipset based test mode software to ensure the results are consistent and reliable.

9.5.1 General Device Setup

Chipset based test mode software is hardware dependent and generally varies among manufacturers. The device operating parameters established in test mode for SAR measurements must be identical to those programmed in production units, including output power levels, amplifier gain settings and other RF performance tuning parameters. The test frequencies should correspond to actual channel frequencies defined for domestic use. SAR for devices with switched diversity should be measured with only one antenna transmitting at a time during each SAR measurement, according to a fixed modulation and data rate. The same data pattern should be used for all measurements.





9.5.2 Frequency Channel Configurations²²

802.11 a/b/g and 4.9 GHz operating modes are tested independently according to the service requirements in each frequency band. 802.11 b/g modes are tested on channels 1, 6 and 11. 802.11a is tested for UNII operations on channels 36 and 48 in the 5.15-5.25 GHz band; channels 52 and 64 in the 5.25-5.35 GHz band; channels 104, 116, 124 and 136 in the 5.470-5.725 GHz band; and channels 149 and 161 in the 5.8 GHz band. When 5.8 GHz §15.247 is also available, channels 149, 157 and 165 should be tested instead of the UNII channels. 4.9 GHz is tested on channels 1, 10 and 5 or 6, whichever has the higher output power, for 5 MHz channels; channels 11, 15 and 19 for 10 MHz channels; and channels 21 and 25 for 20 MHz channels. These are referred to as the “default test channels”. 802.11g mode was evaluated only if the output power was 0.25 dB higher than the 802.11b mode.

**Table 9-1
802.11 Test Channels per FCC Requirements**

Mode	GHz	Channel	Turbo Channel	“Default Test Channels”		
				§15.247	UNII	
				802.11b	802.11g	
802.11 b/g	2.412	1		√	∇	
	2.437	6	6	√	∇	
	2.462	11		√	∇	
802.11a	5.18	36				√
	5.20	40	42 (5.21 GHz)			*
	5.22	44				*
	5.24	48	50 (5.25 GHz)			√
	5.26	52				√
	5.28	56	58 (5.29 GHz)			*
	5.30	60				*
	5.32	64				√
	5.500	100	Unknown			*
	5.520	104				√
	5.540	108				*
	5.560	112				*
	5.580	116				√
	5.600	120				*
	5.620	124				√
	5.640	128				*
	5.660	132				*
	5.680	136				√
	5.700	140			*	
	UNII or §15.247	5.745	149		√	
5.765		153	152 (5.76 GHz)		*	*
5.785		157		√		*
5.805		161	160 (5.80 GHz)		*	√
§15.247		5.825	165		√	

FCC ID: A3LGT16500U		 SAR COMPLIANCE REPORT 		Reviewed by: Quality Manager
Filename: 0911092037.A3L	Test Dates: 11/10/09 - 11/11/09	EUT Type: 850/1900 GSM/GPRS/EDGE and 850 WCDMA/HSPA Phone with Bluetooth and WLAN		Page 15 of 37

10 RF EXPOSURE LIMITS

10.1 Uncontrolled Environment

UNCONTROLLED ENVIRONMENTS are defined as locations where there is the exposure of individuals who have no knowledge or control of their exposure. The general population/uncontrolled exposure limits are applicable to situations in which the general public may be exposed or in which persons who are exposed as a consequence of their employment may not be made fully aware of the potential for exposure or cannot exercise control over their exposure. Members of the general public would come under this category when exposure is not employment-related; for example, in the case of a wireless transmitter that exposes persons in its vicinity.



10.2 Controlled Environment

CONTROLLED ENVIRONMENTS are defined as locations where there is exposure that may be incurred by persons who are aware of the potential for exposure, (i.e. as a result of employment or occupation). In general, occupational/controlled exposure limits are applicable to situations in which persons are exposed as a consequence of their employment, who have been made fully aware of the potential for exposure and can exercise control over their exposure. This exposure category is also applicable when the exposure is of a transient nature due to incidental passage through a location where the exposure levels may be higher than the general population/uncontrolled limits, but the exposed person is fully aware of the potential for exposure and can exercise control over his or her exposure by leaving the area or by some other appropriate means.

Table 10-1
SAR Human Exposure Specified in ANSI/IEEE C95.1-1992 and Health Canada Safety Code 6

HUMAN EXPOSURE LIMITS		
	UNCONTROLLED ENVIRONMENT <i>General Population</i> (W/kg) or (mW/g)	CONTROLLED ENVIRONMENT <i>Occupational</i> (W/kg) or (mW/g)
SPATIAL PEAK SAR Brain	1.6	8.0
SPATIAL AVERAGE SAR Whole Body	0.08	0.4
SPATIAL PEAK SAR Hands, Feet, Ankles, Wrists	4.0	20



- 1 The Spatial Peak value of the SAR averaged over any 1 gram of tissue (defined as a tissue volume in the shape of a cube) and over the appropriate averaging time.
- 2 The Spatial Average value of the SAR averaged over the whole body.
- 3 The Spatial Peak value of the SAR averaged over any 10 grams of tissue (defined as a tissue volume in the shape of a cube) and over the appropriate averaging time.

FCC ID: A3LGT16500U		 SAR COMPLIANCE REPORT 		Reviewed by: Quality Manager
Filename: 0911092037.A3L	Test Dates: 11/10/09 - 11/11/09	EUT Type: 850/1900 GSM/GPRS/EDGE and 850 WCDMA/HSPA Phone with Bluetooth and WLAN		Page 16 of 37

11 MEASUREMENT UNCERTAINTIES

a	b	c	d	e= f(d,k)	f	g	h = c x f/e	i = c x g/e	k
Uncertainty Component	IEEE 1528 Sec.	Tol. (± %)	Prob. Dist.	Div.	c _i 1gm	c _i 10 gms	1gm u _i (± %)	10gms u _i (± %)	v _i
Measurement System									
Probe Calibration	E2.1	6.6	N	1	1.0	1.0	6.6	6.6	∞
Axial Isotropy	E2.2	0.25	N	1	0.7	0.7	0.2	0.2	∞
Hemishperical Isotropy	E2.2	1.3	N	1	1.0	1.0	1.3	1.3	∞
Boundary Effect	E2.3	0.4	N	1	1.0	1.0	0.4	0.4	∞
Linearity	E2.4	0.3	N	1	1.0	1.0	0.3	0.3	∞
System Detection Limits	E2.5	5.1	N	1	1.0	1.0	5.1	5.1	∞
Readout Electronics	E2.6	1.0	N	1	1.0	1.0	1.0	1.0	∞
Response Time	E2.7	0.8	R	1.73	1.0	1.0	0.5	0.5	∞
Integration Time	E2.8	2.6	R	1.73	1.0	1.0	1.5	1.5	∞
RF Ambient Conditions	E6.1	3.0	R	1.73	1.0	1.0	1.7	1.7	∞
Probe Positioner Mechanical Tolerance	E6.2	0.4	R	1.73	1.0	1.0	0.2	0.2	∞
Probe Positioning w/ respect to Phantom	E6.3	2.9	R	1.73	1.0	1.0	1.7	1.7	∞
Extrapolation, Interpolation & Integration algorithms for Max. SAR Evaluation	E5	1.0	R	1.73	1.0	1.0	0.6	0.6	∞
Test Sample Related									
Test Sample Positioning	E4.2	6.0	N	1	1.0	1.0	6.0	6.0	287
Device Holder Uncertainty	E4.1	3.32	R	1.73	1.0	1.0	1.9	1.9	∞
Output Power Variation - SAR drift measurement	6.6.2	5.0	R	1.73	1.0	1.0	2.9	2.9	∞
Phantom & Tissue Parameters									
Phantom Uncertainty (Shape & Thickness tolerances)	E3.1	4.0	R	1.73	1.0	1.0	2.3	2.3	∞
Liquid Conductivity - deviation from target values	E3.2	5.0	R	1.73	0.64	0.43	1.8	1.2	∞
Liquid Conductivity - measurement uncertainty	E3.3	3.8	N	1	0.64	0.43	2.4	1.6	6
Liquid Permittivity - deviation from target values	E3.2	5.0	R	1.73	0.60	0.49	1.7	1.4	∞
Liquid Permittivity - measurement uncertainty	E3.3	4.5	N	1	0.60	0.49	2.7	2.2	6
Combined Standard Uncertainty (k=1)	RSS						12.4	12.0	299
Expanded Uncertainty (95% CONFIDENCE LEVEL)	k=2						24.7	24.0	

The above measurement uncertainties are according to IEEE Std. 1528-2003

FCC ID: A3LGT16500U				SAR COMPLIANCE REPORT				Reviewed by: Quality Manager	
Filename: 0911092037.A3L	Test Dates: 11/10/09 - 11/11/09	EUT Type: 850/1900 GSM/GPRS/EDGE and 850 WCDMA/HSPA Phone with Bluetooth and WLAN							
© 2009 PCTEST Engineering Laboratory, Inc.								Page 17 of 37	

12 SYSTEM VERIFICATION

12.1 Tissue Verification

Table 12-1
Measured Tissue Properties

Calibrated Date:	Tissue Type	Measured Frequency (MHz)	Measured Conductivity, σ (S/m)	Measured Dielectric Constant, ϵ	TARGET Conductivity, σ (S/m)	TARGET Dielectric Constant, ϵ	% dev σ	% dev ϵ
11/09/2009	835H	820	0.856	39.99	0.90	41.50	-4.89%	-3.64%
		835	0.883	39.86	0.90	41.50	-1.89%	-3.95%
		850	0.898	39.64	0.90	41.50	-0.22%	-4.48%
11/09/2009	835M	820	0.965	54.32	0.97	55.20	-0.52%	-1.59%
		835	0.979	54.19	0.97	55.20	0.93%	-1.83%
		850	0.994	54.02	0.97	55.20	2.47%	-2.14%
11/09/2009	1900H	1850	1.404	38.99	1.40	40.00	0.29%	-2.52%
		1880	1.436	38.87	1.40	40.00	2.57%	-2.83%
		1910	1.468	38.75	1.40	40.00	4.86%	-3.13%
11/09/2009	1900M	1850	1.524	51.06	1.52	53.30	0.26%	-4.20%
		1880	1.560	50.92	1.52	53.30	2.62%	-4.47%
		1910	1.587	50.83	1.52	53.30	4.41%	-4.63%
11/09/2009	2450M	2401	1.861	51.96	1.95	52.70	-4.56%	-1.40%
		2450	1.930	51.80	1.95	52.70	-1.03%	-1.71%
		2499	1.997	51.42	1.95	52.70	2.41%	-2.43%

Note: KDB 450824 was ensured to be applied for probe calibration frequencies greater than or equal to 50 MHz of the DUT frequencies.



The above measured tissue parameters were used in the DASY software to perform interpolation via the DASY software to determine actual dielectric parameters at the test frequencies (per IEEE 1528 6.6.1.2).

12.2 Measurement Procedure for Tissue verification

- 1) The network analyzer and probe system was configured and calibrated.
- 2) The probe was immersed in the sample which was placed in a nonmetallic container. Trapped air bubbles beneath the flange were minimized by placing the probe at a slight angle.
- 3) The complex admittance with respect to the probe aperture was measured
- 4) The complex relative permittivity, for example from the below equation (Pournaropoulos and Misra):

$$Y = \frac{j2\omega\epsilon'_r\epsilon_0}{[\ln(b/a)]^2} \int_a^b \int_a^b \int_0^\pi \cos\phi' \frac{\exp[-j\omega r(\mu_0\epsilon'_r\epsilon_0)^{1/2}]}{r} d\phi' d\rho' d\rho$$

where Y is the admittance of the probe in contact with the sample, the primed and unprimed coordinates refer to source and observation points, respectively, $r^2 = \rho^2 + \rho'^2 - 2\rho\rho' \cos\phi'$, ω is the angular frequency, and $j = \sqrt{-1}$.

FCC ID: A3LGT16500U				SAR COMPLIANCE REPORT				Reviewed by: Quality Manager	
Filename: 0911092037.A3L	Test Dates: 11/10/09 - 11/11/09	EUT Type: 850/1900 GSM/GPRS/EDGE and 850 WCDMA/HSPA Phone with Bluetooth and WLAN							Page 18 of 37

12.3 Test System Verification

Prior to assessment, the system is verified to $\pm 10\%$ of the manufacturer SAR result on the reference dipole at the time of calibration, by using the below system validation kit(s).

**Table 12-2
System Verification Results**

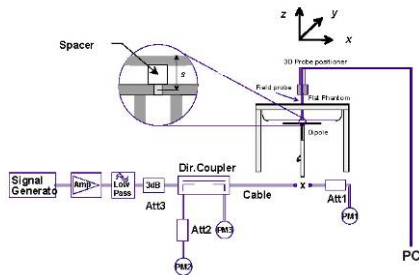

System Verification TARGET & MEASURED									
Date:	Amb. Temp (°C)	Liquid Temp (°C)	Input Power (W)	Tissue Frequency (MHz)	Dipole SN	Tissue Type	Targeted SAR _{1g} (mW)	Measured SAR _{1g} (mW)	Deviation (%)
11/10/2009	22.9	21.2	0.100	835	4d047	Brain	0.97	0.964	-0.62%
11/10/2009	23.5	21.8	0.100	1900	502	Muscle	4.15	4.35	4.82%
11/11/2009	23.8	22.1	0.010	2450	719	Muscle	0.51	0.49	-4.67%



**Figure 12-1
System Verification Setup Diagram**



**Figure 12-2
System Verification Setup Photo**

FCC ID: A3LGT16500U				SAR COMPLIANCE REPORT				Reviewed by: Quality Manager	
Filename: 0911092037.A3L	Test Dates: 11/10/09 - 11/11/09	EUT Type: 850/1900 GSM/GPRS/EDGE and 850 WCDMA/HSPA Phone with Bluetooth and WLAN							Page 19 of 37

13 FCC MULTI-TX AND ANTENNA SAR CONSIDERATIONS

13.1 Introduction

The following procedures adopted from “FCC SAR Considerations for Cell Phones with Multiple Transmitters” v01r03 from May 2008 are applicable to handsets with built-in unlicensed transmitters such as 802.11a/b/g and Bluetooth devices which may simultaneously transmit with the licensed transmitter.

13.2 FCC Power Tables & Conditions

	2.45	5.15 - 5.35	5.47 - 5.85	GHz
P_{Ref}	12	6	5	mW

Device output power should be rounded to the nearest mW to compare with values specified in this table.

Figure 13-1
Output Power Thresholds for Unlicensed Transmitters

	Individual Transmitter	Simultaneous Transmission
Licensed Transmitters	<u>Routine evaluation required</u>	SAR not required: <u>Unlicensed only</u>
Unlicensed Transmitters	<p>When there is no simultaneous transmission –</p> <ul style="list-style-type: none"> output ≤ 60/f: SAR not required output > 60/f: stand-alone SAR required <p>When there is simultaneous transmission –</p> <p><u>Stand-alone SAR not required when</u></p> <ul style="list-style-type: none"> output $\leq 2 \cdot P_{Ref}$ and antenna is ≥ 5.0 cm from other antennas output $\leq P_{Ref}$ and antenna is ≥ 2.5 cm from other antennas <p>o output $\leq P_{Ref}$ and antenna is < 2.5 cm from other antennas, each with either output power $\leq P_{Ref}$ or 1-g SAR < 1.2 W/kg</p> <p><u>Otherwise stand-alone SAR is required</u></p> <p>When stand-alone SAR is required</p> <ul style="list-style-type: none"> test SAR on highest output channel for each wireless mode and exposure condition if SAR for highest output channel is $> 50\%$ of SAR limit, evaluate all channels according to normal procedures 	<ul style="list-style-type: none"> when stand-alone 1-g SAR is not required and antenna is ≥ 5 cm from other antennas <p><u>Licensed & Unlicensed</u></p> <ul style="list-style-type: none"> when the sum of the 1-g SAR is < 1.6 W/kg for all simultaneous transmitting antennas when SAR to peak location separation ratio of simultaneous transmitting antenna pair is < 0.3 <p>SAR required:</p> <p><u>Licensed & Unlicensed</u></p> <p>antenna pairs with SAR to peak location separation ratio ≥ 0.3; test is only required for the configuration that results in the highest SAR in stand-alone configuration for each wireless mode and exposure condition</p> <p>Note: simultaneous transmission exposure conditions for head and body can be different for different style phones; therefore, different test requirements may apply</p>

Figure 13-2
SAR Evaluation Requirements for Multiple Transmitter Handsets

13.3 Multiple Antenna/Transmission Information for GT-I6500U



Separation Distance of Antennas: 9.16 cm for Bluetooth and 9.16 cm for WLAN
RF Conducted Power of Bluetooth Tx is 2.630 mW. RF Conducted Power of WLAN is 72.78 mW

13.4 Conclusion

Based on the output power, antenna separation distance and the Body SAR of the dominant transmitter, a stand-alone Bluetooth SAR test is not required while it is required for WLAN.

The summation of BT SAR and Licensed Transmitter SAR is $0.29 \text{ W/kg} + 0 \text{ W/kg} = 0.29 \text{ W/kg}$, which is less than 1.6 W/kg , therefore, a simultaneous SAR evaluation is not required.

The summation of WLAN SAR and Licensed transmitter SAR is $0.29 \text{ W/kg} + 0.1 \text{ W/kg} = 0.39 \text{ W/kg}$, which is less than 1.6 W/kg ; therefore a simultaneous SAR evaluation is not required.

FCC ID: A3LGTI6500U		 SAR COMPLIANCE REPORT 		Reviewed by: Quality Manager
Filename: 0911092037.A3L	Test Dates: 11/10/09 - 11/11/09	EUT Type: 850/1900 GSM/GPRS/EDGE and 850 WCDMA/HSPA Phone with Bluetooth and WLAN		Page 20 of 37

14 FCC 3G MEASUREMENT PROCEDURES

Power measurements were performed using a base station simulator under digital average power.

14.1 Procedures Used to Establish RF Signal for SAR

The device was placed into a simulated call using a base station simulator in a shielded chamber. Such test signals offer a consistent means for testing SAR and are recommended for evaluating SAR [4]. SAR measurements were taken with a fully charged battery. In order to verify that the device was tested and maintained at full power, it was configured with the base station simulator. The SAR measurement software calculates a reference point at the start and end of the test to check for power drifts. If conducted power deviations of more than 5% occurred, the tests were repeated.

14.2 SAR Measurement Conditions for UMTS

14.2.1 Output Power Verification

Maximum output power is verified on the High, Middle and Low channels according to the general descriptions in section 5.2 of 3GPP TS 34.121, using the appropriate RMC or AMR with TPC (transmit power control) set to all "1s".

14.2.2 Head SAR Measurements



SAR for head exposure configurations is measured using the 12.2 kbps RMC with TPC bits configured to all "1s". SAR in AMR configurations is not required when the maximum average output of each RF channel for 12.2 kbps AMR is less than ¼ dB higher than that measured in 12.2 kbps RMC. Otherwise, SAR is measured on the maximum output channel in 12.2 AMR with a 3.4 kbps SRB (signaling radio bearer) using the exposure configuration that results in the highest SAR for that RF channel in 12.2 RMC.

14.2.3 Body SAR Measurements

SAR for body exposure configurations is measured using the 12.2 kbps RMC with the TPC bits all "1s".

14.2.4 Handsets with HSDPA

Body SAR is not required for handsets with HSDPA capabilities when the maximum average output of each RF channel with HSDPA active is less than ¼ dB higher than that measured without HSDPA using 12.2 kbps RMC and the maximum SAR for 12.2 kbps RMC is ≤ 75% of the SAR limit. Otherwise, SAR is measured for HSDPA, using an FRC with H-Set 1 in Sub-test 1 and a 12.2 kbps RMC configured in Test Loop Mode 1, using the highest body SAR configuration in 12.2 kbps RMC without HSDPA, on the maximum output channel with the body exposure configuration that results in the highest SAR in 12.2 kbps RMC for that RF channel.

FCC ID: A3LGT16500U		 SAR COMPLIANCE REPORT 		Reviewed by: Quality Manager
Filename: 0911092037.A3L	Test Dates: 11/10/09 - 11/11/09	EUT Type: 850/1900 GSM/GPRS/EDGE and 850 WCDMA/HSPA Phone with Bluetooth and WLAN		Page 21 of 37

14.3 RF Conducted Powers:

14.3.1 GSM Conducted Powers



		RF Conducted Power Table								
		Voice	GPRS Data				EDGE Data			
Band	Channel	GSM [dBm]	GPRS [dBm] 1 Tx Slot	GPRS [dBm] 2 Tx Slot	GPRS [dBm] 3 Tx Slot	GPRS [dBm] 4 Tx Slot	EDGE [dBm] 1 Tx Slot	EDGE [dBm] 2 Tx Slot	EDGE [dBm] 3 Tx Slot	EDGE [dBm] 4 Tx Slot
Cellular	128	31.75	31.65	31.57	28.26	27.38	27.04	26.00	22.98	21.93
	190	31.83	31.70	31.62	28.41	27.44	27.15	26.08	23.05	22.06
	251	31.74	31.54	31.53	28.32	27.35	26.99	25.96	22.97	21.95
PCS	512	29.22	29.11	29.06	25.96	24.37	26.09	25.02	22.62	21.61
	661	29.47	29.36	29.33	26.13	24.64	26.34	25.33	22.80	21.82
	810	29.45	29.37	29.34	26.07	24.51	26.35	25.24	22.72	21.70

14.3.2 WCDMA (UMTS) Conducted Powers

3GPP Release Version	Mode	3GPP 34.121 Subtest	Cellular Band [dBm]			β_c	β_d	β_c/β_d	HSDPA FRC	MPR
			4132	4183	4233					
99	WCDMA	12.2 kbps RMC	22.14	22.53	22.55	-	-	-	-	-
99		12.2 kbps AMR	22.03	22.36	22.47	-	-	-	-	-
6	HSDPA	Subtest 1	22.14	22.45	22.50	2/15	15/15	2/15	H-SET 1	0
6		Subtest 2	21.86	22.33	22.23	12/15	15/15	12/15	H-SET 1	0
6		Subtest 3	21.41	21.80	21.82	15/15	8/15	15/8	H-SET 1	0.5
6		Subtest 4	21.63	22.11	22.14	15/15	4/15	15/4	H-SET 1	0.5
6	HSUPA	Subtest 1	21.83	22.30	22.28	11/15	15/15	11/15	H-SET 1	0
6		Subtest 2	19.87	20.20	20.46	6/15	15/15	6/15	H-SET 1	2
6		Subtest 3	20.46	20.80	20.97	15/15	9/15	15/9	H-SET 1	1
6		Subtest 4	20.07	20.50	20.49	2/15	15/15	2/15	H-SET 1	2
6		Subtest 5	22.10	22.66	22.79	15/15	15/15	15/15	H-SET 1	0

14.3.3 IEEE 802.11b Conducted Powers

Freq [MHz]	Channel	Data Rate [Mbps]	Measured Average Power [dBm]
2412	1	1	16.85
		2	17.01
		5.5	16.85
		11	17.01
		22	17.35
2437	6	1	17.46
		2	17.47
		5.5	17.38
		11	17.46
		22	18.25
2462	11	1	18.07
		2	17.78
		5.5	17.8
		11	18.28
		22	18.62

FCC ID: A3LGT16500U				SAR COMPLIANCE REPORT				Reviewed by: Quality Manager	
Filename: 0911092037.A3L	Test Dates: 11/10/09 - 11/11/09	EUT Type: 850/1900 GSM/GPRS/EDGE and 850 WCDMA/HSPA Phone with Bluetooth and WLAN							
								Page 22 of 37	



14.3.4

IEEE 802.11g Conducted Powers

Freq [MHz]	Channel	Data Rate [Mbps]	Measured Average Power [dBm]
2412	1	6	15.11
		9	15.16
		12	15.81
		18	15.11
		24	15.09
		36	14.46
		48	13.72
		54	13.28
2437	6	6	14.67
		9	14.65
		12	14.62
		18	14.74
		24	14.62
		36	14.17
		48	13.11
		54	12.56
2462	11	6	13.98
		9	13.95
		12	14.28
		18	14.28
		24	14.31
		36	13.99
		48	12.94
		54	12.58



Figure 14-1
Power Measurement Setup

FCC ID: A3LGT16500U				SAR COMPLIANCE REPORT				Reviewed by: Quality Manager	
Filename: 0911092037.A3L	Test Dates: 11/10/09 - 11/11/09	EUT Type: 850/1900 GSM/GPRS/EDGE and 850 WCDMA/HSPA Phone with Bluetooth and WLAN							Page 23 of 37



15 SAR DATA SUMMARY

15.1 GSM 850 Head SAR Results

MEASUREMENT RESULTS								
FREQUENCY		Mode/Band	C_Power[dBm]		Side	Test Position	Battery Type	SAR (1g)
MHz	Ch.		Start	End				(W/kg)
836.60	190	GSM 850	31.83	31.97	Right	Touch	Standard	0.135
836.60	190	GSM 850	31.83	31.92	Right	Tilt	Standard	0.092
836.60	190	GSM 850	31.83	32.01	Left	Touch	Standard	0.145
836.60	190	GSM 850	31.83	31.95	Left	Tilt	Standard	0.082
ANSI / IEEE C95.1 1992 - SAFETY LIMIT						Brain		
Spatial Peak						1.6 W/kg (mW/g)		
Uncontrolled Exposure/General Population						averaged over 1 gram		

Notes:

1. The test data reported are the worst-case SAR value with the position set in a typical configuration. Test procedures used are according to FCC/OET Bulletin 65, Supplement C [July 2001].
2. All modes of operation were investigated, and worst-case results are reported.
3. Batteries are fully charged for all readings.
4. Tissue parameters and temperatures are listed on the SAR plots.
5. Liquid tissue depth is 15.1 cm. ± 0.1.
6. Justification for reduced test configurations: Per FCC/OET Bulletin 65 Supplement C (July, 2001) and Public Notice DA-02-1438, if the SAR measured at the middle channel for each test configuration (left, right, cheek/touch, tilt/ear, extended and retracted) is at least 3.0 dB lower than the SAR limit, testing at the high and low channels is optional for such test configuration(s).



FCC ID: A3LGT16500U				SAR COMPLIANCE REPORT				Reviewed by: Quality Manager	
Filename: 0911092037.A3L	Test Dates: 11/10/09 - 11/11/09	EUT Type: 850/1900 GSM/GPRS/EDGE and 850 WCDMA/HSPA Phone with Bluetooth and WLAN							Page 24 of 37

15.2 GSM 1900 Head SAR Results

MEASUREMENT RESULTS								
FREQUENCY		Mode/Band	C_Power[dBm]		Side	Test Position	Battery Type	SAR (1g)
MHz	Ch.		Start	End				(W/kg)
1880.00	661	GSM 1900	29.47	29.49	Right	Touch	Standard	0.258
1880.00	661	GSM 1900	29.47	29.50	Right	Tilt	Standard	0.147
1880.00	661	GSM 1900	29.47	29.46	Left	Touch	Standard	0.345
1880.00	661	GSM 1900	29.47	29.40	Left	Tilt	Standard	0.114
ANSI / IEEE C95.1 1992 - SAFETY LIMIT						Brain		
Spatial Peak						1.6 W/kg (mW/g)		
Uncontrolled Exposure/General Population						averaged over 1 gram		

Notes:

1. The test data reported are the worst-case SAR value with the position set in a typical configuration. Test procedures used are according to FCC/OET Bulletin 65, Supplement C [July 2001].
2. All modes of operation were investigated, and worst-case results are reported.
3. Batteries are fully charged for all readings.
4. Tissue parameters and temperatures are listed on the SAR plots.
5. Liquid tissue depth is 15.1 cm. \pm 0.1.
6. Justification for reduced test configurations: Per FCC/OET Bulletin 65 Supplement C (July, 2001) and Public Notice DA-02-1438, if the SAR measured at the middle channel for each test configuration (left, right, cheek/touch, tilt/ear, extended and retracted) is at least 3.0 dB lower than the SAR limit, testing at the high and low channels is optional for such test configuration(s).



FCC ID: A3LGT16500U				SAR COMPLIANCE REPORT				Reviewed by: Quality Manager	
Filename: 0911092037.A3L	Test Dates: 11/10/09 - 11/11/09	EUT Type: 850/1900 GSM/GPRS/EDGE and 850 WCDMA/HSPA Phone with Bluetooth and WLAN							Page 25 of 37

15.3 UMTS V Head SAR Results

MEASUREMENT RESULTS								
FREQUENCY		Mode/Band	C_Power[dBm]		Side	Test Position	Battery Type	SAR (1g)
MHz	Ch.		Start	End				(W/kg)
836.60	4183	UMTS V	22.53	22.60	Right	Touch	Standard	0.125
836.60	4183	UMTS V	22.53	22.56	Right	Tilt	Standard	0.086
836.60	4183	UMTS V	22.53	22.57	Left	Touch	Standard	0.145
836.60	4183	UMTS V	22.53	22.56	Left	Tilt	Standard	0.082
ANSI / IEEE C95.1 1992 - SAFETY LIMIT						Brain		
Spatial Peak						1.6 W/kg (mW/g)		
Uncontrolled Exposure/General Population						averaged over 1 gram		

Notes:

1. The test data reported are the worst-case SAR value with the position set in a typical configuration. Test procedures used are according to FCC/OET Bulletin 65, Supplement C [July 2001].
2. All modes of operation were investigated, and worst-case results are reported.
3. Batteries are fully charged for all readings.
4. Tissue parameters and temperatures are listed on the SAR plots.
5. Liquid tissue depth is 15.1 cm. ± 0.1.
6. Justification for reduced test configurations: Per FCC/OET Bulletin 65 Supplement C (July, 2001) and Public Notice DA-02-1438, if the SAR measured at the middle channel for each test configuration (left, right, cheek/touch, tilt/ear, extended and retracted) is at least 3.0 dB lower than the SAR limit, testing at the high and low channels is optional for such test configuration(s).
7. WCDMA mode was tested under RMC 12.2 kbps with HSDPA Inactive



FCC ID: A3LGT16500U		 SAR COMPLIANCE REPORT 		Reviewed by: Quality Manager
Filename: 0911092037.A3L	Test Dates: 11/10/09 - 11/11/09	EUT Type: 850/1900 GSM/GPRS/EDGE and 850 WCDMA/HSPA Phone with Bluetooth and WLAN		Page 26 of 37

15.4 Body SAR Results

MEASUREMENT RESULTS											
FREQUENCY		Mode	Service	C_Power[dBm]		Position	Spacing	Battery	Slots	Side	SAR (1g)
MHz	Ch.			Start	End						(W/kg)
836.60	190	GSM 850	GPRS	31.62	31.48	Body	1.5 cm	Standard	2	back	0.261
836.60	190	GSM 850	GPRS	31.62	31.67	Body	1.5 cm	Standard	2	front	0.175
1880.00	661	GSM 1900	GPRS	29.33	29.45	Body	1.5 cm	Standard	2	back	0.233
1880.00	661	GSM 1900	GPRS	29.33	29.24	Body	1.5 cm	Standard	2	front	0.291
836.60	4183	UMTS V	RMC	22.53	22.57	Body	1.5 cm	Standard	N/A	back	0.135
836.60	4183	UMTS V	RMC	22.53	22.56	Body	1.5 cm	Standard	N/A	front	0.095
ANSI / IEEE C95.1 1992 - SAFETY LIMIT Spatial Peak Uncontrolled Exposure/General Population							Body 1.6 W/kg (mW/g) averaged over 1 gram				

Notes:

1. The test data reported are the worst-case SAR value with the position set in a typical configuration. Test procedures used are according to FCC/OET Bulletin 65, Supplement C [July 2001].
2. All modes of operation were investigated, and worst-case results are reported.
3. Tissue parameters and temperatures are listed on the SAR plots.
4. Batteries are fully charged for all readings.
5. Liquid tissue depth is 15.1 cm. \pm 0.1.
6. Device was tested using a fixed spacing.
7. WCDMA mode in Body SAR was tested under RMC 12.2 kbps with HSDPA Inactive
8. All other time averaged powers for the other multi-slot modes were evaluated to be significantly lower than that of the other GPRS multi-slot time-averaged powers. The worst-case results are reported.



FCC ID: A3LGT16500U				SAR COMPLIANCE REPORT				Reviewed by: Quality Manager		
Filename: 0911092037.A3L	Test Dates: 11/10/09 - 11/11/09	EUT Type: 850/1900 GSM/GPRS/EDGE and 850 WCDMA/HSPA Phone with Bluetooth and WLAN								Page 27 of 37

15.5 2.4 GHz Body SAR Results

MEASUREMENT RESULTS											
FREQUENCY		Mode	C_Power[dBm]		Position	Service	Spacing	Battery	Data Rate	Side	SAR
MHz	Ch.		Start	End							(W/kg)
2412	1	2.4 GHz WLAN	16.85	16.89	Body	DSSS	1.5 cm	Standard	1	back	0.099
2437	6	2.4 GHz WLAN	17.46	17.52	Body	DSSS	1.5 cm	Standard	1	back	0.089
2462	11	2.4 GHz WLAN	18.07	19.31	Body	DSSS	1.5 cm	Standard	1	back	0.059
2412	1	2.4 GHz WLAN	17.35	17.36	Body	DSSS	1.5 cm	Standard	22	back	0.075
2437	6	2.4 GHz WLAN	18.25	18.29	Body	DSSS	1.5 cm	Standard	22	back	0.087
2462	11	2.4 GHz WLAN	18.62	18.75	Body	DSSS	1.5 cm	Standard	22	back	0.060
2412	1	2.4 GHz WLAN	16.85	16.91	Body	DSSS	1.5 cm	Standard	1	front	0.058
ANSI / IEEE C95.1 1992 - SAFETY LIMIT							Body				
Spatial Peak							1.6 W/kg (mW/g)				
Uncontrolled Exposure/General Population							averaged over 1 gram				

Notes:

1. The test data reported are the worst-case SAR value with the position set in a typical configuration. Test procedures used are according to FCC/OET Bulletin 65, Supplement C [July 2001].
2. All modes of operation were investigated, and worst-case results are reported.
3. Batteries are fully charged for all readings.
4. Tissue parameters and temperatures are listed on the SAR plots.
5. Liquid tissue depth is 15.1 cm. \pm 0.1.
6. Device was tested using a fixed spacing.
7. IEEE 802.11g modes are to be investigated if the conducted output powers are greater than 0.25 dB than that of the IEEE 802.11b mode.
8. IEEE 802.11b mode was tested under 1 and 22 Mbps.
9. WLAN is not capable of held-to-ear operations per the applicant; therefore only Body-Worn conditions apply to this device.



FCC ID: A3LGT16500U				SAR COMPLIANCE REPORT				Reviewed by: Quality Manager	
Filename: 0911092037.A3L	Test Dates: 11/10/09 - 11/11/09	EUT Type: 850/1900 GSM/GPRS/EDGE and 850 WCDMA/HSPA Phone with Bluetooth and WLAN							
								Page 28 of 37	

16 EQUIPMENT LIST

Manufacturer	Model	Description	Cal Date	Cal Interval	Cal Due	Serial Number
Agilent	8648D	(9kHz-4GHz) Signal Generator	9/19/2009	Biennial	9/19/2011	3613A00315
Agilent	8753E	(30kHz-6GHz) Network Analyzer	3/25/2009	Annual	3/25/2010	JP38020182
Agilent	E5515C	Wireless Communications Test Set	9/10/2009	Annual	9/10/2010	GB46110872
Agilent	E5515C	Wireless Communications Test Set	9/11/2009	Annual	9/11/2010	GB46310798
Agilent	E5515C	Wireless Communications Test Set	8/25/2009	Annual	8/25/2010	GB41450275
Agilent	E8257D	(250kHz-20GHz) Signal Generator	3/25/2009	Biennial	3/25/2011	MY45470194
Gigatronics	80701A	(0.05-18GHz) Power Sensor	9/9/2009	Annual	9/9/2010	1833460
Gigatronics	8651A	Universal Power Meter	9/9/2009	Annual	9/9/2010	8650319
Index SAR	IXTL-010	Dielectric Measurement Kit	N/A		N/A	N/A
Index SAR	IXTL-030	30MM TEM line for 6 GHz	N/A		N/A	N/A
Rohde & Schwarz	CMU200	Base Station Simulator	9/11/2009	Annual	9/11/2010	836371/0079
Rohde & Schwarz	CMU200	Base Station Simulator	4/6/2009	Annual	4/6/2010	833855/0010
Rohde & Schwarz	CMU200	Base Station Simulator	9/4/2009	Annual	9/4/2010	109892
Rohde & Schwarz	NRVD	Dual Channel Power Meter	8/20/2008	Biennial	8/20/2010	101695
Rohde & Schwarz	NRV-Z32	Peak Power Sensor (100uW-2W)	12/5/2008	Biennial	12/5/2010	100155
Rohde & Schwarz	NRV-Z33	Peak Power Sensor (1mW-20W)	12/5/2008	Biennial	12/5/2010	100004
SPEAG	D1450V2	1450 MHz SAR Dipole	5/20/2009	Biennial	5/20/2011	1025
SPEAG	D1765V2	1765 MHz SAR Dipole	5/19/2009	Biennial	5/19/2011	1008
SPEAG	D1900V2	1900 MHz SAR Dipole	1/20/2009	Biennial	1/20/2011	502
SPEAG	D1900V2	1900 MHz SAR Dipole	8/18/2009	Biennial	8/18/2011	5d080
SPEAG	D2300V2	2300 MHz SAR Dipole	3/6/2008	Biennial	3/6/2010	1008
SPEAG	D2450V2	2450 MHz SAR Dipole	8/27/2009	Biennial	8/27/2011	719
SPEAG	D2450V2	2450 MHz SAR Dipole	1/8/2009	Biennial	1/8/2011	797
SPEAG	D2600V2	2600 MHz SAR Dipole	8/12/2009	Biennial	8/12/2011	1004
SPEAG	D5GHzV2	5 GHz SAR Dipole	8/19/2009	Biennial	8/19/2011	1007
SPEAG	D5GHzV2	5 GHz SAR Dipole	1/15/2009	Biennial	1/15/2011	1057
SPEAG	D835V2	835 MHz SAR Dipole	1/19/2009	Biennial	1/19/2011	4d047
SPEAG	D835V2	835 MHz SAR Dipole	8/24/2009	Biennial	8/24/2011	4d026
SPEAG	DAE4	Dasy Data Acquisition Electronics	5/14/2009	Annual	5/14/2010	704
SPEAG	DAE4	Dasy Data Acquisition Electronics	5/25/2009	Annual	5/25/2010	665
SPEAG	DAE4	Dasy Data Acquisition Electronics	1/21/2009	Annual	1/21/2010	649
SPEAG	ES3DV2	SAR Probe	9/18/2009	Annual	9/18/2010	3022
SPEAG	EX3DV4	SAR Probe	1/21/2009	Annual	1/21/2010	3550
SPEAG	DAE4	Dasy Data Acquisition Electronics	7/21/2009	Annual	7/21/2010	859
SPEAG	D750V3	750 MHz Dipole	2/19/2009	Biennial	2/19/2011	1003
Rohde & Schwarz	CMU200	Base Station Simulator	6/12/2009	Annual	6/12/2010	836536/0005
Speag	ES3DV3	SAR Probe	4/15/2009	Annual	4/15/2010	3213
Speag	ES3DV3	SAR Probe	4/15/2009	Annual	4/15/2010	3209
Rohde & Schwarz	SMIQ03B	Signal Generator	5/21/2009	Annual	5/21/2010	832810/021
Speag	D1640V2	1640 MHz Dipole	8/21/2008	Biennial	8/21/2010	321
Rohde & Schwarz	CMW500	LTE Base Station Simulator	8/25/2009	Annual	8/25/2010	100976

Notes:

The E-field probe was calibrated by SPEAG, by the waveguide technique procedure. Dipole Validation measurement is performed by PCTEST prior to SAR evaluation. The brain simulating material is calibrated by PCTEST using the dielectric probe system and network analyzer to determine the conductivity and permittivity (dielectric constant) of the brain-equivalent material.



FCC ID: A3LGT16500U				SAR COMPLIANCE REPORT				Reviewed by: Quality Manager
Filename: 0911092037.A3L	Test Dates: 11/10/09 - 11/11/09	EUT Type: 850/1900 GSM/GPRS/EDGE and 850 WCDMA/HSPA Phone with Bluetooth and WLAN						
© 2009 PCTEST Engineering Laboratory, Inc.								Page 29 of 37

17 CONCLUSION

17.1 Measurement Conclusion



The SAR evaluation indicates that the EUT complies with the RF radiation exposure limits of the FCC and Industry Canada, with respect to all parameters subject to this test. These measurements were taken to simulate the RF effects of RF exposure under worst-case conditions. Precise laboratory measures were taken to assure repeatability of the tests. The results and statements relate only to the item(s) tested.

Please note that the absorption and distribution of electromagnetic energy in the body are very complex phenomena that depend on the mass, shape, and size of the body, the orientation of the body with respect to the field vectors, and the electrical properties of both the body and the environment. Other variables that may play a substantial role in possible biological effects are those that characterize the environment (e.g. ambient temperature, air velocity, relative humidity, and body insulation) and those that characterize the individual (e.g. age, gender, activity level, debilitation, or disease). Because various factors may interact with one another to vary the specific biological outcome of an exposure to electromagnetic fields, any protection guide should consider maximal amplification of biological effects as a result of field-body interactions, environmental conditions, and physiological variables. [3]

FCC ID: A3LGT16500U		 PCTEST ENGINEERING LABORATORY, INC.		SAR COMPLIANCE REPORT				Reviewed by: Quality Manager
Filename: 0911092037.A3L	Test Dates: 11/10/09 - 11/11/09	EUT Type: 850/1900 GSM/GPRS/EDGE and 850 WCDMA/HSPA Phone with Bluetooth and WLAN		Page 30 of 37				

18 REFERENCES

- [1] Federal Communications Commission, ET Docket 93-62, Guidelines for Evaluating the Environmental Effects of Radiofrequency Radiation, Aug. 1996.
- [2] ANSI/IEEE C95.1-2005, American National Standard safety levels with respect to human exposure to radio frequency electromagnetic fields, 300kHz to 100GHz, New York: IEEE, 2006.
- [3] ANSI/IEEE C95.3-2002, IEEE Recommended Practice for the Measurement of Potentially Hazardous Electromagnetic Fields - RF and Microwave, New York: IEEE, December 2002.
- [4] Federal Communications Commission, OET Bulletin 65 (Edition 97-01), Supplement C (Edition 01-01), Evaluating Compliance with FCC Guidelines for Human Exposure to Radiofrequency Electromagnetic Fields, July 2001.
- [5] IEEE Standards Coordinating Committee 34 – IEEE Std. 1528-2003, Recommended Practice for Determining the Peak Spatial-Average Specific Absorption Rate (SAR) in the Human Body Due to Wireless Communications Devices.
- [6] NCRP, National Council on Radiation Protection and Measurements, Biological Effects and Exposure Criteria for RadioFrequency Electromagnetic Fields, NCRP Report No. 86, 1986. Reprinted Feb. 1995.
- [7] T. Schmid, O. Egger, N. Kuster, Automated E-field scanning system for dosimetric assessments, IEEE Transaction on Microwave Theory and Techniques, vol. 44, Jan. 1996, pp. 105-113.
- [8] K. Pokovic, T. Schmid, N. Kuster, Robust setup for precise calibration of E-field probes in tissue simulating liquids at mobile communications frequencies, ICECOM97, Oct. 1997, pp. 120-124.
- [9] K. Pokovic, T. Schmid, and N. Kuster, E-field Probe with improved isotropy in brain simulating liquids, Proceedings of the ELMAR, Zadar, Croatia, June 23-25, 1996, pp. 172-175.
- [10] Schmid & Partner Engineering AG, Application Note: Data Storage and Evaluation, June 1998, p2.
- [11] V. Hombach, K. Meier, M. Burkhardt, E. Kuhn, N. Kuster, The Dependence of EM Energy Absorption upon Human Head Modeling at 900 MHz, IEEE Transaction on Microwave Theory and Techniques, vol. 44 no. 10, Oct. 1996, pp. 1865-1873.
- [12] N. Kuster and Q. Balzano, Energy absorption mechanism by biological bodies in the near field of dipole antennas above 300MHz, IEEE Transaction on Vehicular Technology, vol. 41, no. 1, Feb. 1992, pp. 17-23.
- [13] G. Hartsgrrove, A. Kraszewski, A. Surowiec, Simulated Biological Materials for Electromagnetic Radiation Absorption Studies, University of Ottawa, Bioelectromagnetics, Canada: 1987, pp. 29-36.
- [14] Q. Balzano, O. Garay, T. Manning Jr., Electromagnetic Energy Exposure of Simulated Users of Portable Cellular Telephones, IEEE Transactions on Vehicular Technology, vol. 44, no.3, Aug. 1995.
- [15] W. Gander, Computermathematick, Birkhaeuser, Basel, 1992.
- [16] W.H. Press, S.A. Teukolsky, W.T. Vetterling, and B.P. Flannery, Numerical Receptions in C, The Art of Scientific Computing, Second edition, Cambridge University Press, 1992.

FCC ID: A3LGT16500U				SAR COMPLIANCE REPORT				Reviewed by: Quality Manager
Filename:	Test Dates:	EUT Type:		Page 31 of 37				
0911092037.A3L	11/10/09 - 11/11/09	850/1900 GSM/GPRS/EDGE and 850 WCDMA/HSPA Phone with Bluetooth and WLAN						

[17] Federal Communications Commission, OET Bulletin 65, Evaluating Compliance with FCC Guidelines for Human Exposure to Radiofrequency Electromagnetic Fields. Supplement C, Dec. 1997.

[18] N. Kuster, R. Kastle, T. Schmid, Dosimetric evaluation of mobile communications equipment with known precision, IEEE Transaction on Communications, vol. E80-B, no. 5, May 1997, pp. 645-652.

[19] CENELEC CLC/SC111B, European Prestandard (prENV 50166-2), Human Exposure to Electromagnetic Fields High-frequency: 10kHz-300GHz, Jan. 1995.

[20] Prof. Dr. Niels Kuster, ETH, Eidgenössische Technische Hochschule Zürich, Dosimetric Evaluation of the Cellular Phone.

[21] FCC SAR Measurement Procedures for 3G Devices v2.0, October 2007

[22] SAR Measurement procedures for IEEE 802.11a/b/g rev 1.2, May 2007

[23] IEC 62209-1, Human exposure to radio frequency fields from hand-held and body-mounted wireless communication devices - Human models, instrumentation, and procedures - Part 1: Procedure to determine the specific absorption rate (SAR) for hand-held devices used in close proximity to the ear (frequency range of 300 MHz to 3 GHz), Feb. 2005.

[24] FCC Public Notice DA-02-1438. Office of Engineering and Technology Announces a Transition Period for the Phantom Requirements of Supplement C to OET Bulletin 65, June 19, 2002

[25] Industry Canada RSS-102 Radio Frequency Exposure Compliance of Radiocommunication Apparatus (All Frequency Bands) Issue 2, November 2005

[26] Health Canada Safety Code 6 Limits of Human Exposure to Radio Frequency Electromagnetic Fields in the Frequency Range from 3 kHz – 300 GHz, 1999

[27] FCC SAR Considerations for Handsets with Multiple Transmitters and Antennas v01r05 #648474, September 2008

[28] FCC Application Note for SAR Probe Calibration and System Verification Consideration for Measurements at 150 MHz – 3 GHz, Rev 1.1, January 2007



[29] FCC SAR Evaluation Considerations for Laptop Computers with Antennas Built-in on Display Screens, #616217, v01r01, April 2008

[30] FCC SAR Measurement Requirements for 3 – 6 GHz Rev1.1, October 2006

[31] FCC Mobile Portable RF Exposure Procedure D01 v03r03, KDB 447498, Jan. 2009

[32] FCC SAR Procedures for Dongle Transmitters D02 v01, KDB 447498, Dec. 2008

[33] ANSI/IEEE C95.1-1992, American National Standard safety levels with respect to human exposure to radio frequency electromagnetic fields, 300kHz to 100GHz, New York: IEEE, Sept. 1992.

FCC ID: A3LGT16500U				SAR COMPLIANCE REPORT				Reviewed by: Quality Manager
Filename:	Test Dates:	EUT Type:						Page 32 of 37
0911092037.A3L	11/10/09 - 11/11/09	850/1900 GSM/GPRS/EDGE and 850 WCDMA/HSPA Phone with Bluetooth and WLAN						

APPENDIX A: SAR TEST DATA

PCTEST ENGINEERING LABORATORY, INC.

DUT: GT-I6500U; Type: 850/1900 GSM/GPRS/EDGE and 850 WCDMA/HSPA Phone with Bluetooth and WLAN; Serial: FG-316-A

Communication System: GSM850; Frequency: 836.6 MHz; Duty Cycle: 1:8.3

Medium: 835 Brain Medium parameters used (interpolated):

$f = 836.6 \text{ MHz}$; $s = 0.885 \text{ mho/m}$; $\epsilon_r = 39.8$; $\rho = 1000 \text{ kg/m}^3$

Phantom section: Right Section

Test Date: 11-10-2009; Ambient Temp: 22.9 °C; Tissue Temp: 21.2 °C

Probe: ES3DV3 - SN3213; ConvF(5.94, 5.94, 5.94); Calibrated: 4/15/2009

Sensor-Surface: 3mm (Mechanical Surface Detection)

Electronics: DAE4 Sn649; Calibrated: 1/21/2009

Phantom: SAM Main; Type: SAM 4.0; Serial: TP-1114

Measurement SW: DASY4, V4.7 Build 71; Postprocessing SW: SEMCAD, V1.8 Build 184

Mode: GSM 850, Right Head, Touch, Mid.ch

Area Scan (7x14x1): Measurement grid: $dx=15\text{mm}$, $dy=15\text{mm}$

Zoom Scan (5x5x7)/Cube 0: Measurement grid: $dx=8\text{mm}$, $dy=8\text{mm}$, $dz=5\text{mm}$

Reference Value = 3.78 V/m

Peak SAR (extrapolated) = 0.167 W/kg

SAR(1 g) = 0.135 mW/g; SAR(10 g) = 0.102 mW/g

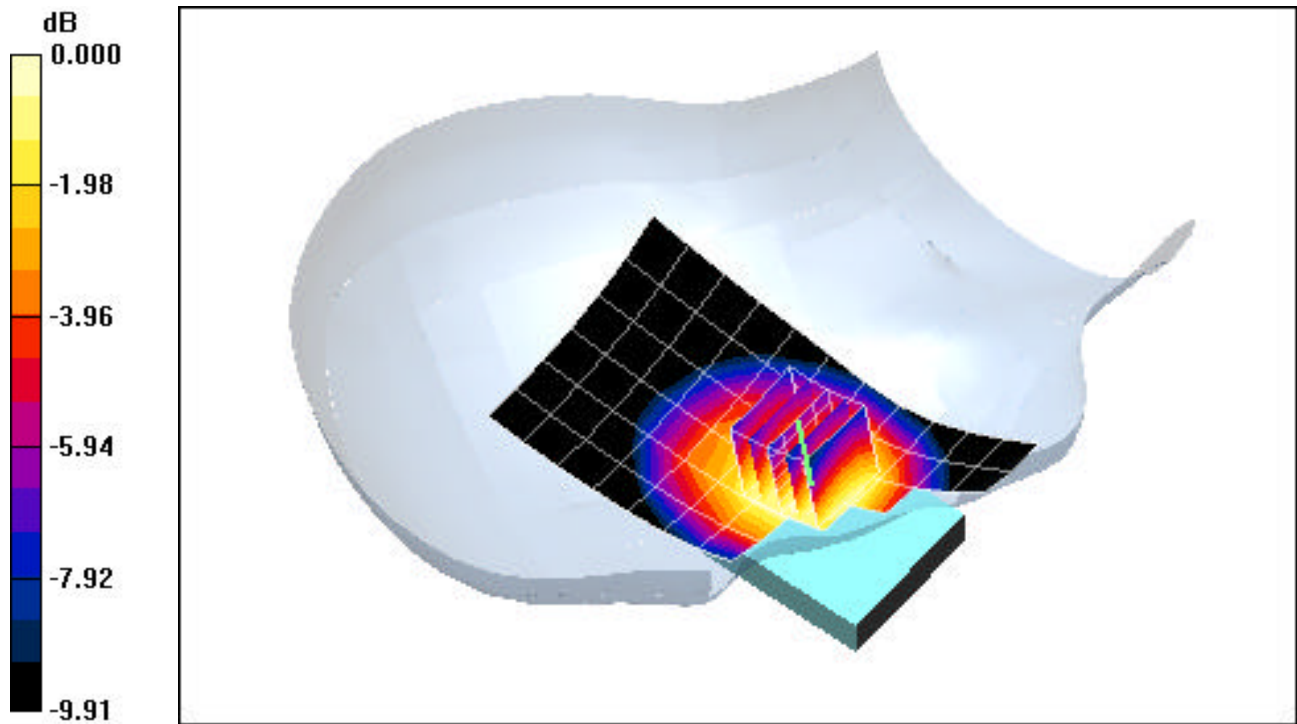

0 dB = 0.146mW/g

PCTEST ENGINEERING LABORATORY, INC.

DUT: GT-I6500U; Type: 850/1900 GSM/GPRS/EDGE and 850 WCDMA/HSPA Phone with Bluetooth and WLAN; Serial: FG-316-A

Communication System: GSM850; Frequency: 836.6 MHz; Duty Cycle: 1:8.3

Medium: 835 Brain Medium parameters used (interpolated):

$f = 836.6 \text{ MHz}$; $s = 0.885 \text{ mho/m}$; $\epsilon_r = 39.8$; $p = 1000 \text{ kg/m}^3$

Phantom section: Right Section

Test Date: 11-10-2009; Ambient Temp: 22.9 °C; Tissue Temp: 21.2 °C

Probe: ES3DV3 - SN3213; ConvF(5.94, 5.94, 5.94); Calibrated: 4/15/2009

Sensor-Surface: 3mm (Mechanical Surface Detection)

Electronics: DAE4 Sn649; Calibrated: 1/21/2009

Phantom: SAM Main; Type: SAM 4.0; Serial: TP-1114

Measurement SW: DASY4, V4.7 Build 71; Postprocessing SW: SEMCAD, V1.8 Build 184

Mode: GSM 850, Right Head, Tilt, Mid.ch

Area Scan (7x14x1): Measurement grid: $dx=15\text{mm}$, $dy=15\text{mm}$

Zoom Scan (5x5x7)/Cube 0: Measurement grid: $dx=8\text{mm}$, $dy=8\text{mm}$, $dz=5\text{mm}$

Reference Value = 7.02 V/m

Peak SAR (extrapolated) = 0.116 W/kg

SAR(1 g) = 0.092 mW/g; SAR(10 g) = 0.071 mW/g

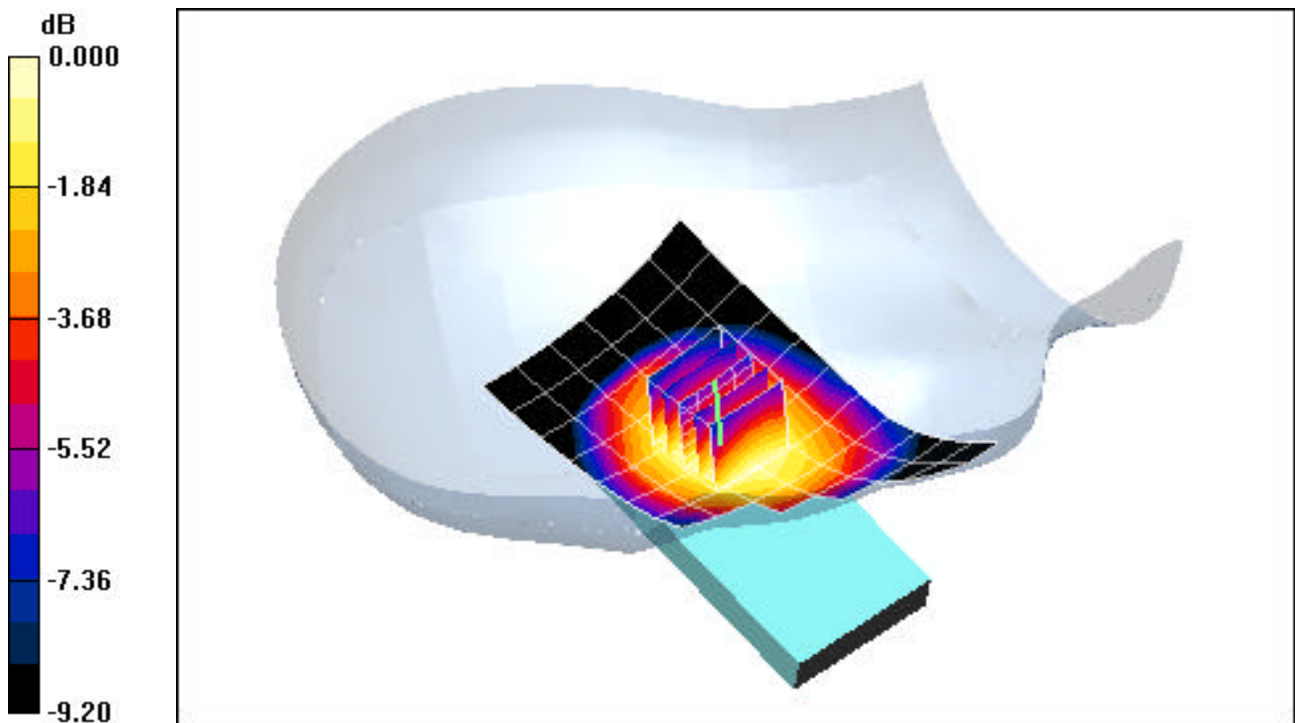

0 dB = 0.100mW/g

PCTEST ENGINEERING LABORATORY, INC.

DUT: GT-I6500U; Type: 850/1900 GSM/GPRS/EDGE and 850 WCDMA/HSPA Phone with Bluetooth and WLAN; Serial: FG-316-A

Communication System: GSM850; Frequency: 836.6 MHz; Duty Cycle: 1:8.3

Medium: 835 Brain Medium parameters used (interpolated):

$f = 836.6 \text{ MHz}$; $s = 0.885 \text{ mho/m}$; $\epsilon_r = 39.8$; $p = 1000 \text{ kg/m}^3$

Phantom section: Left Section

Test Date: 11-10-2009; Ambient Temp: 22.9 °C; Tissue Temp: 21.2 °C

Probe: ES3DV3 - SN3213; ConvF(5.94, 5.94, 5.94); Calibrated: 4/15/2009

Sensor-Surface: 3mm (Mechanical Surface Detection)

Electronics: DAE4 Sn649; Calibrated: 1/21/2009

Phantom: SAM Main; Type: SAM 4.0; Serial: TP-1114

Measurement SW: DASY4, V4.7 Build 71; Postprocessing SW: SEMCAD, V1.8 Build 184

Mode: GSM 850, Left Head, Touch, Mid.ch

Area Scan (7x14x1): Measurement grid: dx=15mm, dy=15mm

Zoom Scan (5x5x7)/Cube 0: Measurement grid: dx=8mm, dy=8mm, dz=5mm

Reference Value = 4.04 V/m

Peak SAR (extrapolated) = 0.206 W/kg

SAR(1 g) = 0.145 mW/g; SAR(10 g) = 0.105 mW/g

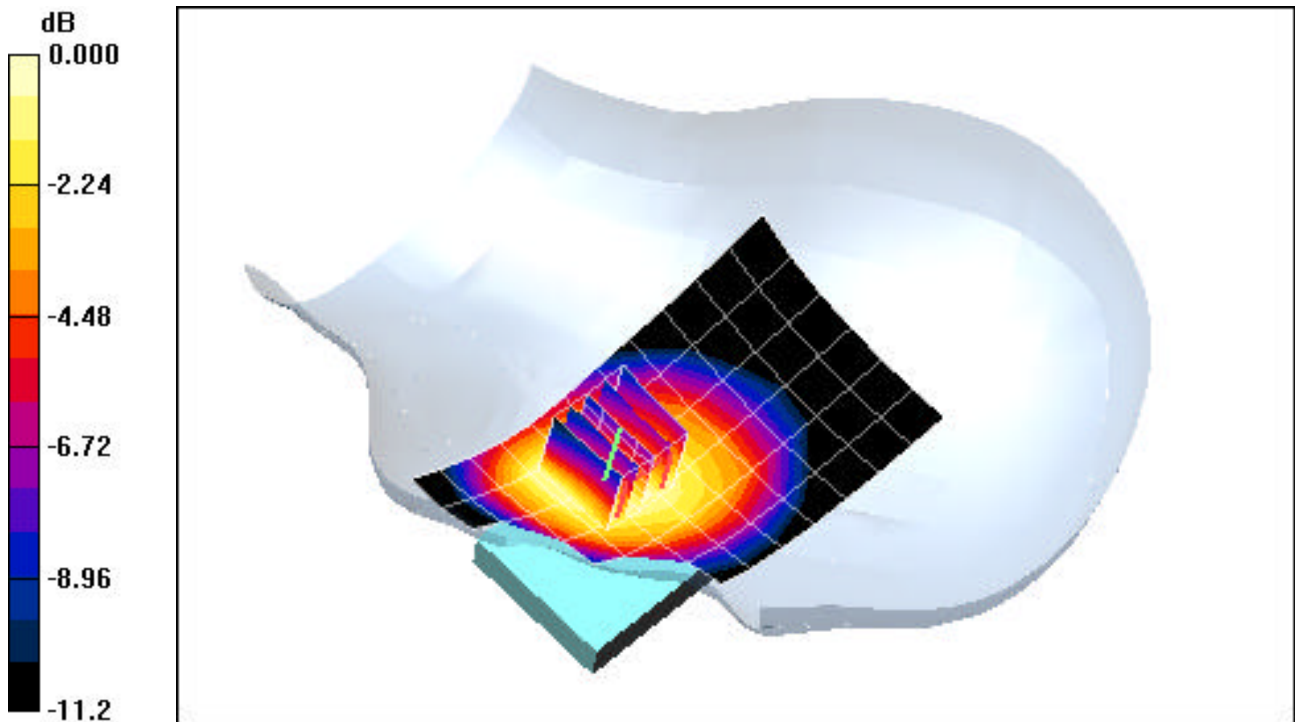

0 dB = 0.163mW/g

PCTEST ENGINEERING LABORATORY, INC.

DUT: GT-I6500U; Type: 850/1900 GSM/GPRS/EDGE and 850 WCDMA/HSPA Phone with Bluetooth and WLAN; Serial: FG-316-A

Communication System: GSM850; Frequency: 836.6 MHz; Duty Cycle: 1:8.3

Medium: 835 Brain Medium parameters used (interpolated):

$f = 836.6 \text{ MHz}$; $s = 0.885 \text{ mho/m}$; $\epsilon_r = 39.8$; $p = 1000 \text{ kg/m}^3$

Phantom section: Left Section

Test Date: 11-10-2009; Ambient Temp: 22.9 °C; Tissue Temp: 21.2 °C

Probe: ES3DV3 - SN3213; ConvF(5.94, 5.94, 5.94); Calibrated: 4/15/2009

Sensor-Surface: 3mm (Mechanical Surface Detection)

Electronics: DAE4 Sn649; Calibrated: 1/21/2009

Phantom: SAM Main; Type: SAM 4.0; Serial: TP-1114

Measurement SW: DASY4, V4.7 Build 71; Postprocessing SW: SEMCAD, V1.8 Build 184

Mode: GSM 850, Left Head, Tilt, Mid.ch

Area Scan (7x14x1): Measurement grid: $dx=15\text{mm}$, $dy=15\text{mm}$

Zoom Scan (5x5x7)/Cube 0: Measurement grid: $dx=8\text{mm}$, $dy=8\text{mm}$, $dz=5\text{mm}$

Reference Value = 6.67 V/m

Peak SAR (extrapolated) = 0.102 W/kg

SAR(1 g) = 0.082 mW/g; SAR(10 g) = 0.062 mW/g

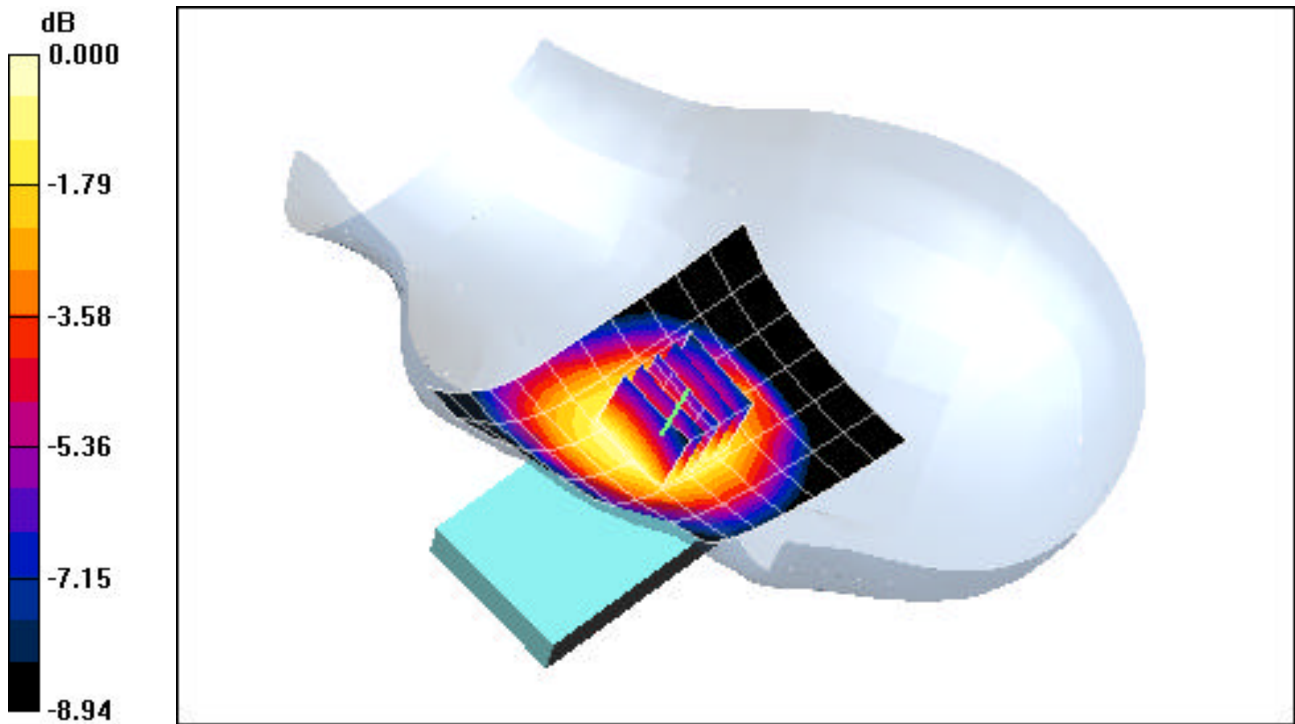

0 dB = 0.090mW/g

PCTEST ENGINEERING LABORATORY, INC.

DUT: GT-I6500U; Type: 850/1900 GSM/GPRS/EDGE and 850 WCDMA/HSPA Phone with Bluetooth and WLAN; Serial: FG-316-A

Communication System: GSM850 GPRS; 2 Tx slots; Frequency: 836.6 MHz; Duty Cycle: 1:4.15
Medium: 835 Muscle Medium parameters used (interpolated):
 $f = 836.6 \text{ MHz}$; $s = 0.981 \text{ mho/m}$; $\epsilon_r = 54.2$; $\rho = 1000 \text{ kg/m}^3$
Phantom section: Flat Section; Space: 1.5 cm

Test Date: 11-10-2009; Ambient Temp: 23.1 °C; Tissue Temp: 21.8 °C

Probe: ES3DV3 - SN3213; ConvF(5.92, 5.92, 5.92); Calibrated: 4/15/2009
Sensor-Surface: 3mm (Mechanical Surface Detection)
Electronics: DAE4 Sn649; Calibrated: 1/21/2009
Phantom: SAM Sub; Type: SAM 4.0; Serial: TP-1357

Measurement SW: DASY4, V4.7 Build 71; Postprocessing SW: SEMCAD, V1.8 Build 184

Mode: GPRS 850, Body SAR, Back side, Mid.ch, 2 Tx Slots

Area Scan (7x10x1): Measurement grid: dx=15mm, dy=15mm

Zoom Scan (5x5x7)/Cube 0: Measurement grid: dx=8mm, dy=8mm, dz=5mm

Reference Value = 15.1 V/m

Peak SAR (extrapolated) = 0.349 W/kg

SAR(1 g) = 0.261 mW/g; SAR(10 g) = 0.188 mW/g

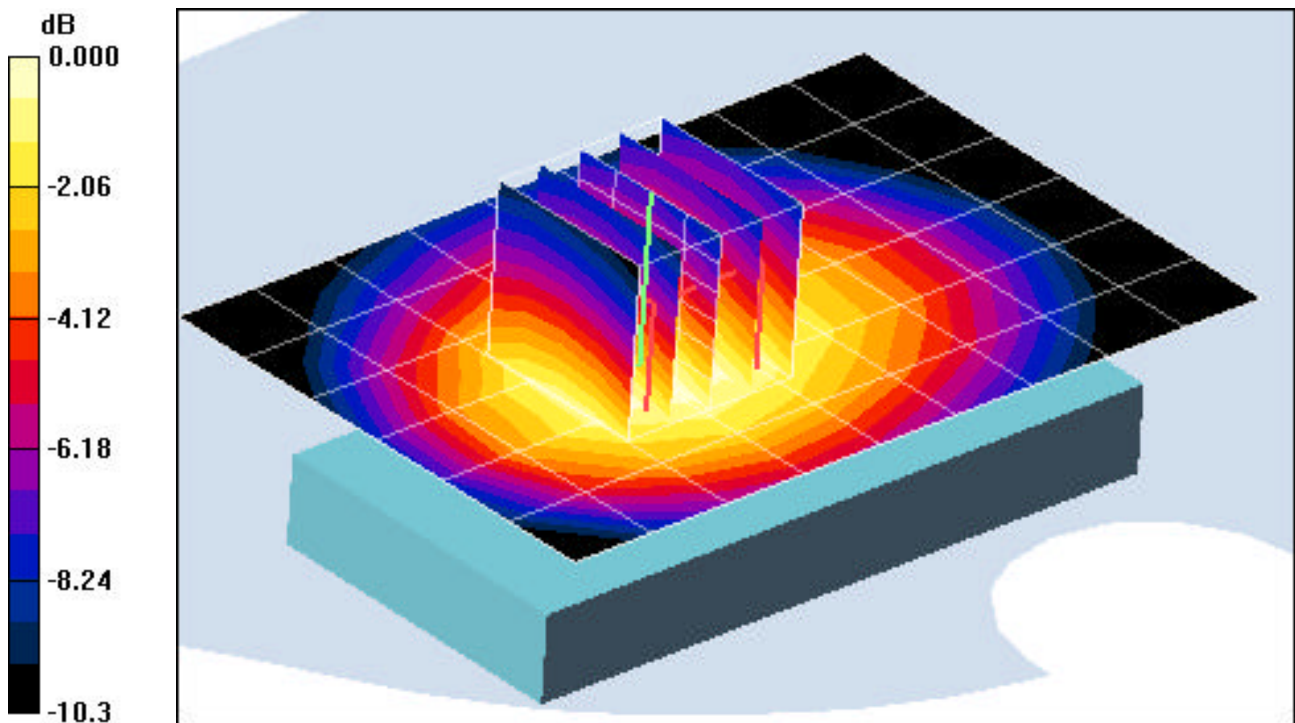

0 dB = 0.293mW/g

PCTEST ENGINEERING LABORATORY, INC.

DUT: GT-I6500U; Type: 850/1900 GSM/GPRS/EDGE and 850 WCDMA/HSPA Phone with Bluetooth and WLAN; Serial: FG-316-A

Communication System: WCDMA850; Frequency: 836.6 MHz; Duty Cycle: 1:1
Medium: 835 Brain Medium parameters used (interpolated):
 $f = 836.6 \text{ MHz}$; $s = 0.885 \text{ mho/m}$; $\epsilon_r = 39.8$; $p = 1000 \text{ kg/m}^3$
Phantom section: Right Section

Test Date: 11-10-2009; Ambient Temp: 22.9 °C; Tissue Temp: 21.2 °C

Probe: ES3DV3 - SN3213; ConvF(5.94, 5.94, 5.94); Calibrated: 4/15/2009
Sensor-Surface: 3mm (Mechanical Surface Detection)
Electronics: DAE4 Sn649; Calibrated: 1/21/2009
Phantom: SAM Main; Type: SAM 4.0; Serial: TP-1114
Measurement SW: DASY4, V4.7 Build 71; Postprocessing SW: SEMCAD, V1.8 Build 184

Mode: WCDMA 850, Right Head, Touch, Mid.ch

Area Scan (7x10x1): Measurement grid: $dx=15\text{mm}$, $dy=15\text{mm}$
Zoom Scan (5x5x7)/Cube 0: Measurement grid: $dx=8\text{mm}$, $dy=8\text{mm}$, $dz=5\text{mm}$
Reference Value = 12.2 V/m
Peak SAR (extrapolated) = 0.156 W/kg
SAR(1 g) = 0.125 mW/g; SAR(10 g) = 0.094 mW/g

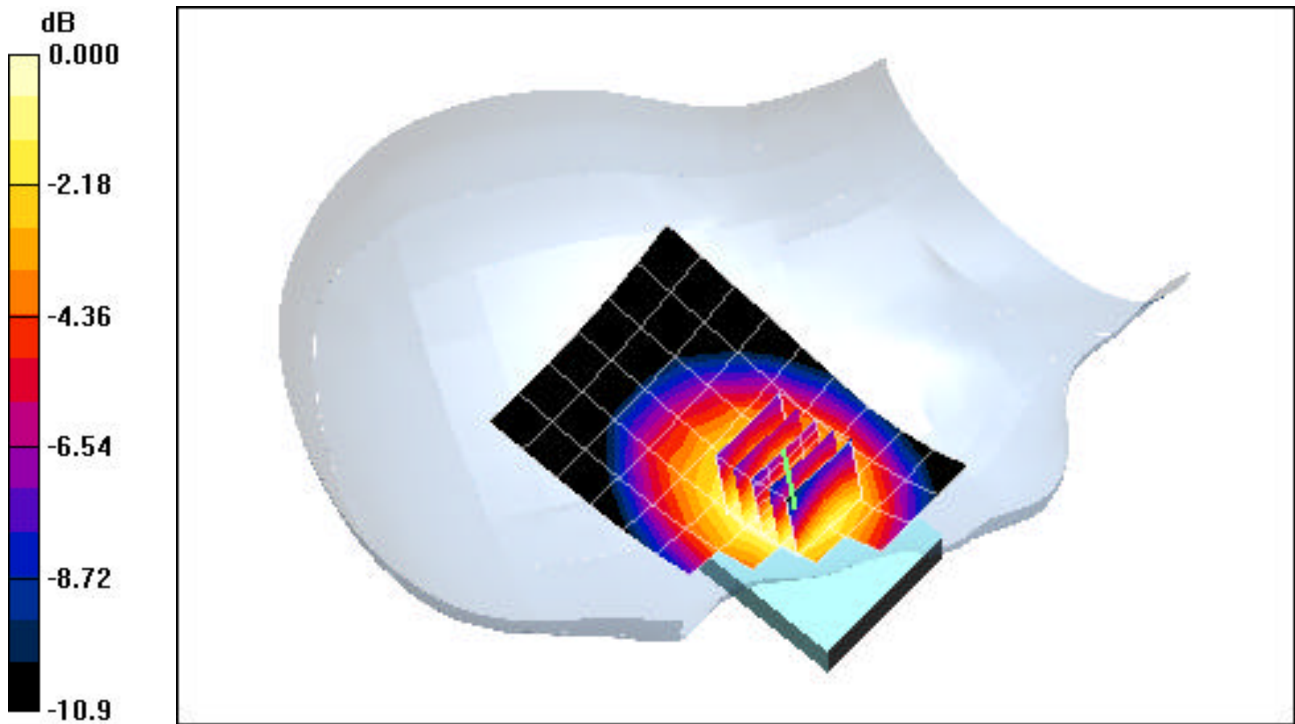

0 dB = 0.137mW/g

PCTEST ENGINEERING LABORATORY, INC.

DUT: GT-I6500U; Type: 850/1900 GSM/GPRS/EDGE and 850 WCDMA/HSPA Phone with Bluetooth and WLAN; Serial: FG-316-A

Communication System: WCDMA850; Frequency: 836.6 MHz; Duty Cycle: 1:1

Medium: 835 Brain Medium parameters used (interpolated):

$f = 836.6 \text{ MHz}$; $s = 0.885 \text{ mho/m}$; $\epsilon_r = 39.8$; $p = 1000 \text{ kg/m}^3$

Phantom section: Right Section

Test Date: 11-10-2009; Ambient Temp: 22.9 °C; Tissue Temp: 21.2 °C

Probe: ES3DV3 - SN3213; ConvF(5.94, 5.94, 5.94); Calibrated: 4/15/2009

Sensor-Surface: 3mm (Mechanical Surface Detection)

Electronics: DAE4 Sn649; Calibrated: 1/21/2009

Phantom: SAM Main; Type: SAM 4.0; Serial: TP-1114

Measurement SW: DASY4, V4.7 Build 71; Postprocessing SW: SEMCAD, V1.8 Build 184

Mode: WCDMA 850, Right Head, Tilt, Mid.ch

Area Scan (7x10x1): Measurement grid: $dx=15\text{mm}$, $dy=15\text{mm}$

Zoom Scan (5x5x7)/Cube 0: Measurement grid: $dx=8\text{mm}$, $dy=8\text{mm}$, $dz=5\text{mm}$

Reference Value = 10.2 V/m

Peak SAR (extrapolated) = 0.108 W/kg

SAR(1 g) = 0.086 mW/g; SAR(10 g) = 0.065 mW/g

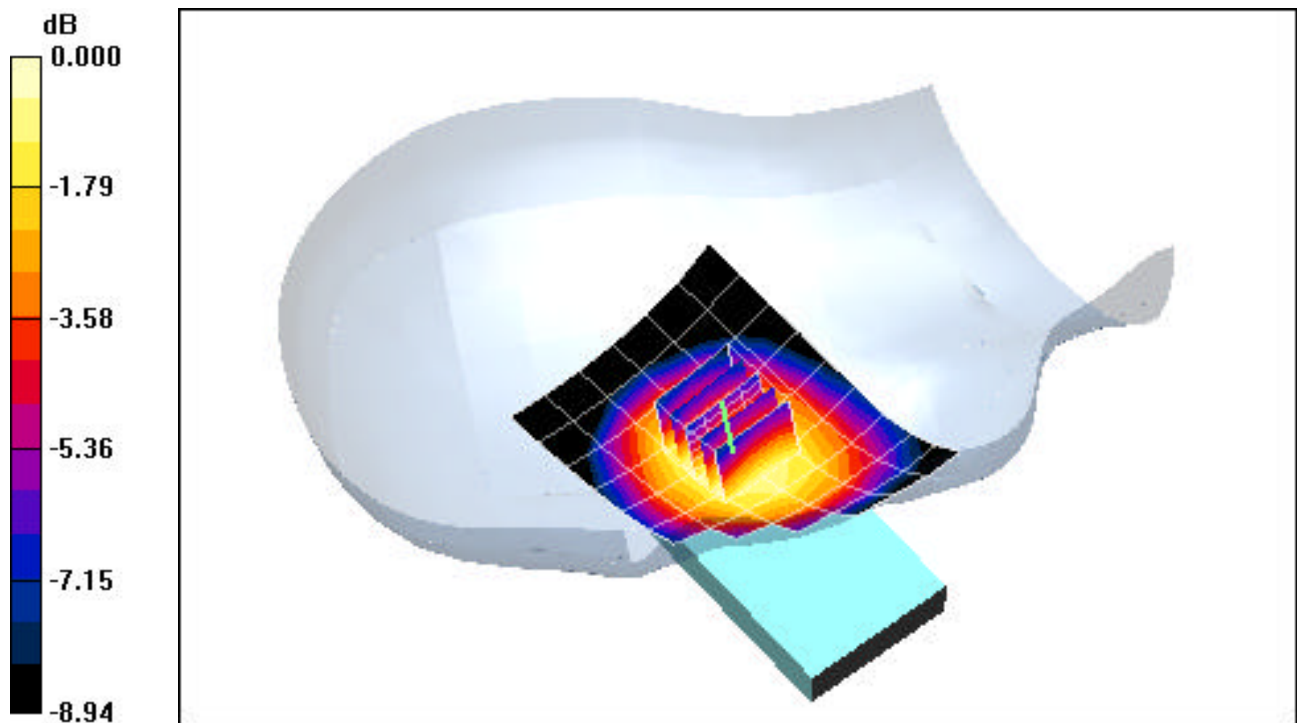

0 dB = 0.095mW/g

PCTEST ENGINEERING LABORATORY, INC.

DUT: GT-I6500U; Type: 850/1900 GSM/GPRS/EDGE and 850 WCDMA/HSPA Phone with Bluetooth and WLAN; Serial: FG-316-A

Communication System: WCDMA850; Frequency: 836.6 MHz; Duty Cycle: 1:1
Medium: 835 Brain Medium parameters used (interpolated):
 $f = 836.6 \text{ MHz}$; $s = 0.885 \text{ mho/m}$; $\epsilon_r = 39.8$; $p = 1000 \text{ kg/m}^3$
Phantom section: Left Section

Test Date: 11-10-2009; Ambient Temp: 22.9 °C; Tissue Temp: 21.2 °C

Probe: ES3DV3 - SN3213; ConvF(5.94, 5.94, 5.94); Calibrated: 4/15/2009
Sensor-Surface: 3mm (Mechanical Surface Detection)
Electronics: DAE4 Sn649; Calibrated: 1/21/2009
Phantom: SAM Main; Type: SAM 4.0; Serial: TP-1114
Measurement SW: DASY4, V4.7 Build 71; Postprocessing SW: SEMCAD, V1.8 Build 184

Mode: WCDMA 850, Left Head, Touch, Mid.ch

Area Scan (7x10x1): Measurement grid: $dx=15\text{mm}$, $dy=15\text{mm}$
Zoom Scan (5x5x7)/Cube 0: Measurement grid: $dx=8\text{mm}$, $dy=8\text{mm}$, $dz=5\text{mm}$
Reference Value = 13.2 V/m
Peak SAR (extrapolated) = 0.208 W/kg
SAR(1 g) = 0.145 mW/g; SAR(10 g) = 0.104 mW/g

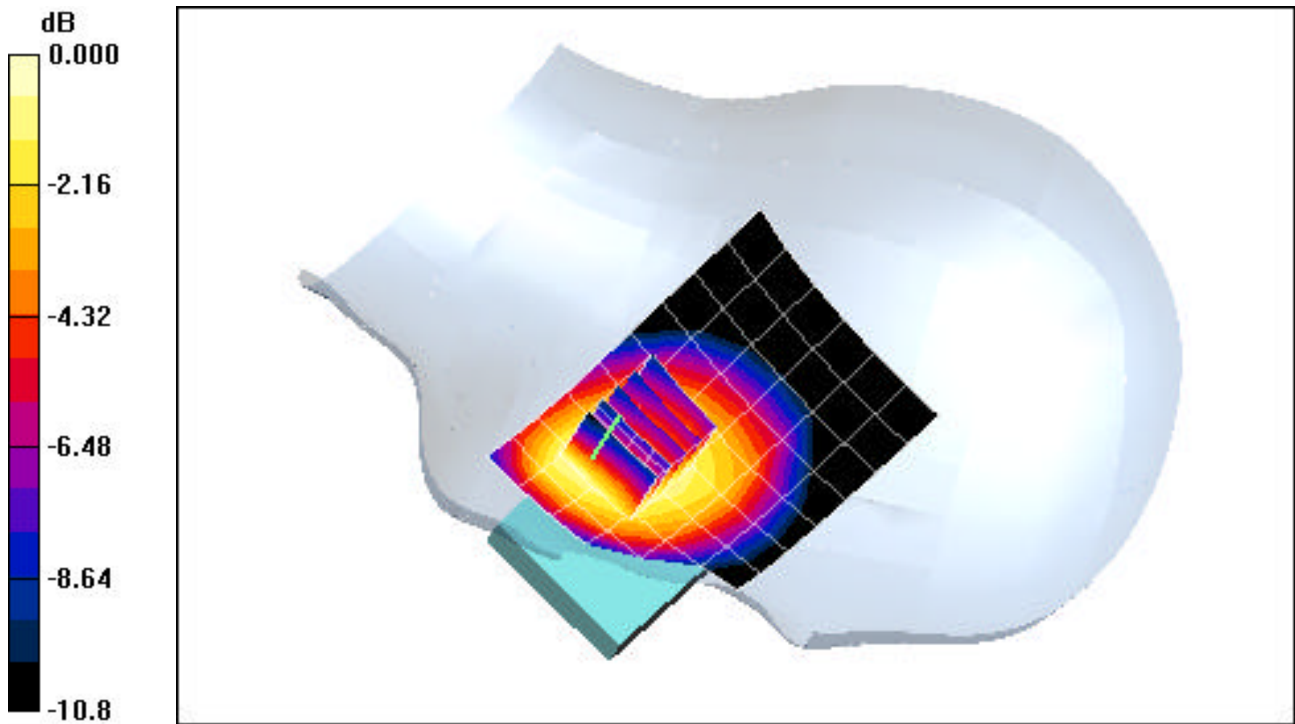

0 dB = 0.163mW/g

PCTEST ENGINEERING LABORATORY, INC.

DUT: GT-I6500U; Type: 850/1900 GSM/GPRS/EDGE and 850 WCDMA/HSPA Phone with Bluetooth and WLAN; Serial: FG-316-A

Communication System: WCDMA850; Frequency: 836.6 MHz; Duty Cycle: 1:1
Medium: 835 Brain Medium parameters used (interpolated):
 $f = 836.6 \text{ MHz}$; $s = 0.885 \text{ mho/m}$; $\epsilon_r = 39.8$; $p = 1000 \text{ kg/m}^3$
Phantom section: Left Section

Test Date: 11-10-2009; Ambient Temp: 22.9 °C; Tissue Temp: 21.2 °C

Probe: ES3DV3 - SN3213; ConvF(5.94, 5.94, 5.94); Calibrated: 4/15/2009
Sensor-Surface: 3mm (Mechanical Surface Detection)
Electronics: DAE4 Sn649; Calibrated: 1/21/2009
Phantom: SAM Main; Type: SAM 4.0; Serial: TP-1114
Measurement SW: DASY4, V4.7 Build 71; Postprocessing SW: SEMCAD, V1.8 Build 184

Mode: WCDMA 850, Left Head, Tilt, Mid.ch

Area Scan (7x10x1): Measurement grid: $dx=15\text{mm}$, $dy=15\text{mm}$
Zoom Scan (5x5x7)/Cube 0: Measurement grid: $dx=8\text{mm}$, $dy=8\text{mm}$, $dz=5\text{mm}$
Reference Value = 9.98 V/m
Peak SAR (extrapolated) = 0.102 W/kg
SAR(1 g) = 0.082 mW/g; SAR(10 g) = 0.061 mW/g

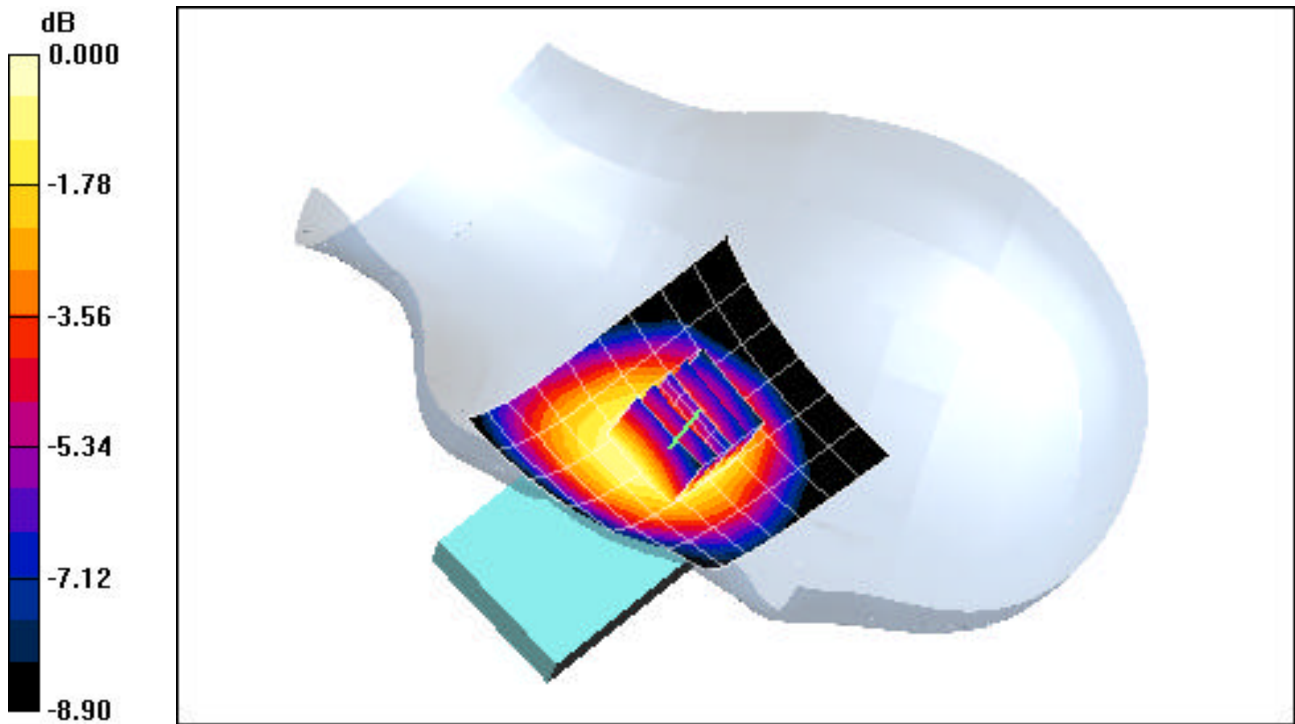

0 dB = 0.090mW/g

PCTEST ENGINEERING LABORATORY, INC.

DUT: GT-I6500U; Type: 850/1900 GSM/GPRS/EDGE and 850 WCDMA/HSPA Phone with Bluetooth and WLAN; Serial: FG-316-A

Communication System: WCDMA850; Frequency: 836.6 MHz; Duty Cycle: 1:1
Medium: 835 Muscle Medium parameters used (interpolated):
 $f = 836.6 \text{ MHz}$; $s = 0.981 \text{ mho/m}$; $\epsilon_r = 54.2$; $\rho = 1000 \text{ kg/m}^3$
Phantom section: Flat Section; Space: 1.5 cm

Test Date: 11-10-2009; Ambient Temp: 23.1 °C; Tissue Temp: 21.8 °C

Probe: ES3DV3 - SN3213; ConvF(5.92, 5.92, 5.92); Calibrated: 4/15/2009
Sensor-Surface: 3mm (Mechanical Surface Detection)
Electronics: DAE4 Sn649; Calibrated: 1/21/2009
Phantom: SAM Sub; Type: SAM 4.0; Serial: TP-1357
Measurement SW: DASY4, V4.7 Build 71; Postprocessing SW: SEMCAD, V1.8 Build 184

Mode: WCDMA 850, Body SAR, Back side, Mid.ch

Area Scan (7x10x1): Measurement grid: $dx=15\text{mm}$, $dy=15\text{mm}$
Zoom Scan (5x5x7)/Cube 0: Measurement grid: $dx=8\text{mm}$, $dy=8\text{mm}$, $dz=5\text{mm}$
Reference Value = 11.9 V/m
Peak SAR (extrapolated) = 0.180 W/kg
SAR(1 g) = 0.135 mW/g; SAR(10 g) = 0.097 mW/g

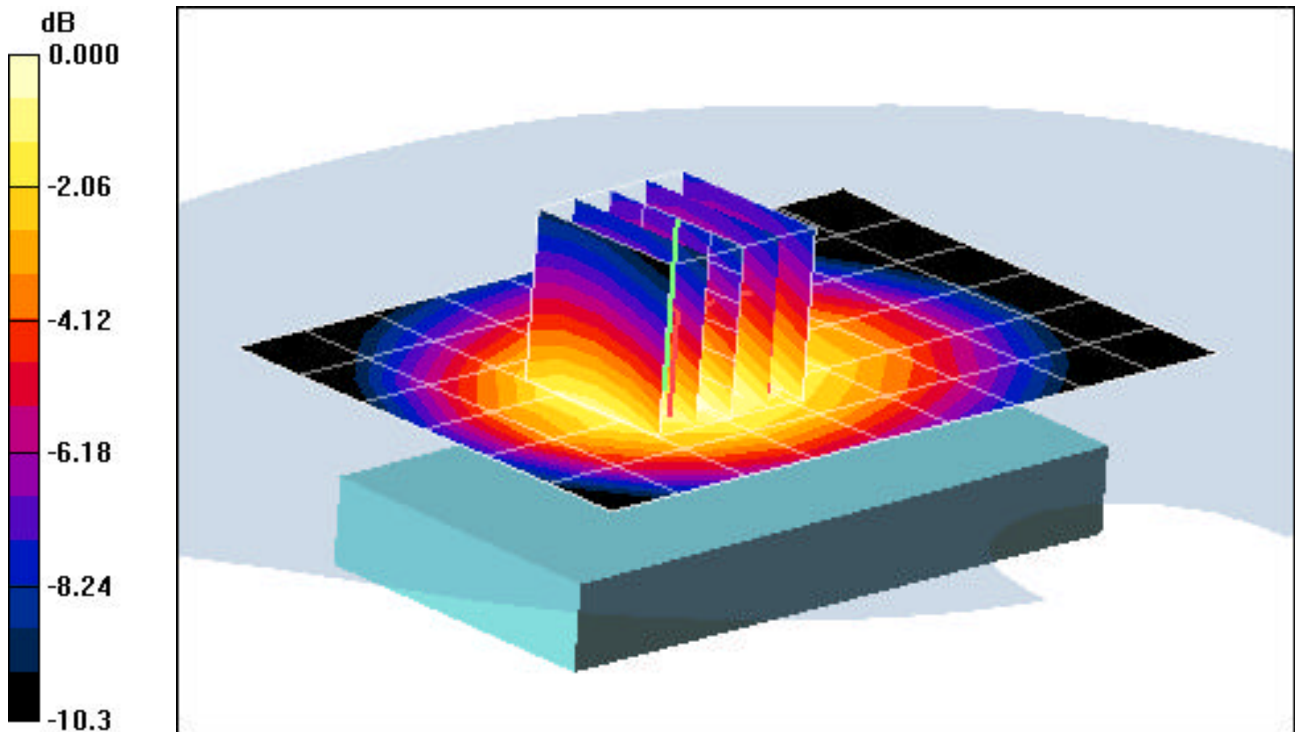

0 dB = 0.152mW/g

PCTEST ENGINEERING LABORATORY, INC.

DUT: GT-I6500U; Type: 850/1900 GSM/GPRS/EDGE and 850 WCDMA/HSPA Phone with Bluetooth and WLAN; Serial: FG-316-B

Communication System: GSM1900; Frequency: 1880 MHz; Duty Cycle: 1:8.3

Medium: 1900 Brain Medium parameters used:

$f = 1880 \text{ MHz}$; $\sigma = 1.44 \text{ mho/m}$; $\epsilon_r = 38.9$; $\rho = 1000 \text{ kg/m}^3$

Phantom section: Right Section

Test Date: 11-10-2009; Ambient Temp: 23.8 °C; Tissue Temp: 22.0 °C

Probe: ES3DV3 - SN3209; ConvF(5.1, 5.1, 5.1); Calibrated: 4/15/2009

Sensor-Surface: 3mm (Mechanical Surface Detection)

Electronics: DAE4 Sn665; Calibrated: 5/25/2009

Phantom: SAM with CRP; Type: SAM; Serial: TP1375

Measurement SW: DASY4, V4.7 Build 71; Postprocessing SW: SEMCAD, V1.8 Build 172

Mode: GSM 1900, Right Head, Touch, Mid.ch

Area Scan (7x14x1): Measurement grid: dx=15mm, dy=15mm

Zoom Scan (5x5x7)/Cube 0: Measurement grid: dx=8mm, dy=8mm, dz=5mm

Reference Value = 6.59 V/m

Peak SAR (extrapolated) = 0.372 W/kg

SAR(1 g) = 0.258 mW/g; SAR(10 g) = 0.166 mW/g

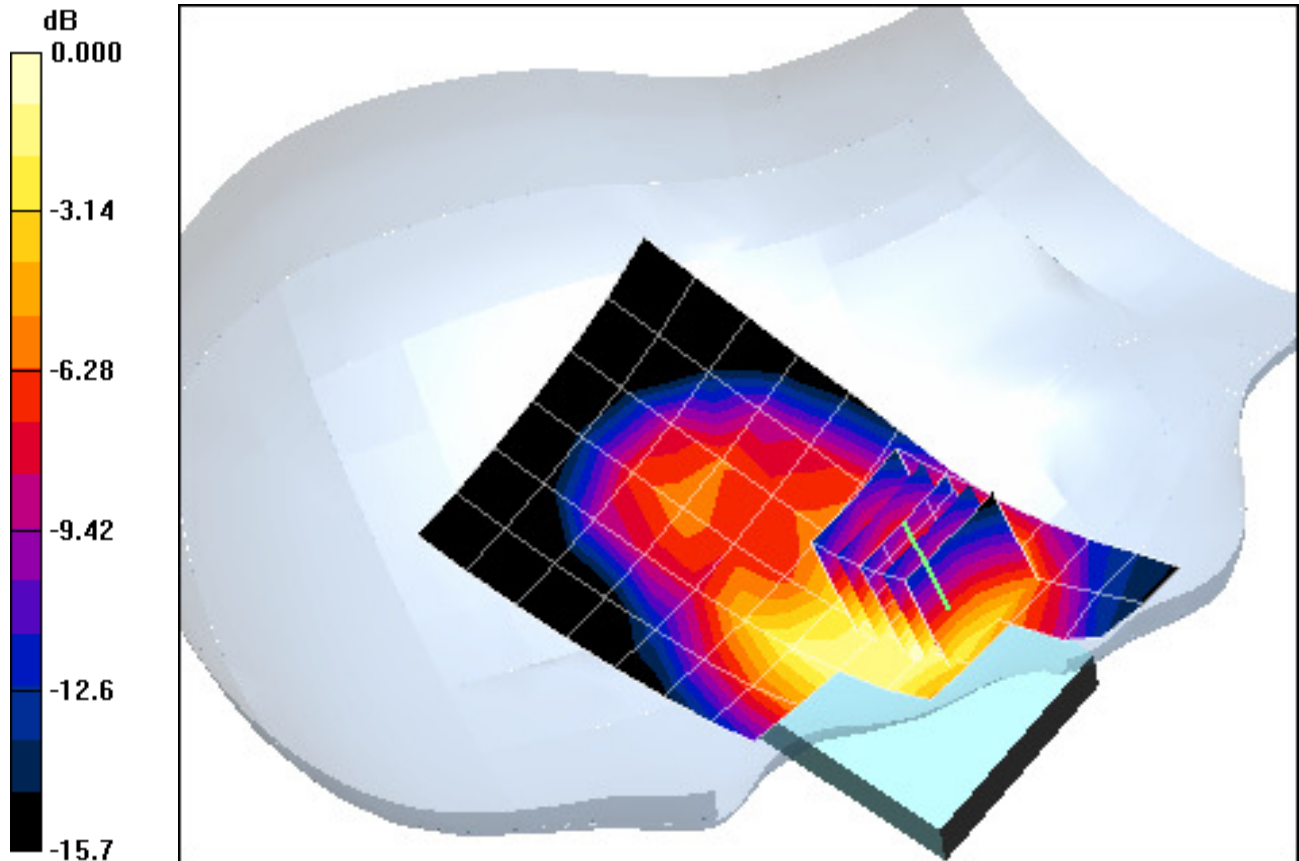

0 dB = 0.296mW/g

PCTEST ENGINEERING LABORATORY, INC.

DUT: GT-I6500U; Type: 850/1900 GSM/GPRS/EDGE and 850 WCDMA/HSPA Phone with Bluetooth and WLAN; Serial: FG-316-B

Communication System: GSM1900; Frequency: 1880 MHz; Duty Cycle: 1:8.3

Medium: 1900 Brain Medium parameters used:

$f = 1880 \text{ MHz}$; $\sigma = 1.44 \text{ mho/m}$; $\epsilon_r = 38.9$; $\rho = 1000 \text{ kg/m}^3$

Phantom section: Right Section

Test Date: 11-10-2009; Ambient Temp: 23.8 °C; Tissue Temp: 22.0 °C

Probe: ES3DV3 - SN3209; ConvF(5.1, 5.1, 5.1); Calibrated: 4/15/2009

Sensor-Surface: 3mm (Mechanical Surface Detection)

Electronics: DAE4 Sn665; Calibrated: 5/25/2009

Phantom: SAM with CRP; Type: SAM; Serial: TP1375

Measurement SW: DASY4, V4.7 Build 71; Postprocessing SW: SEMCAD, V1.8 Build 172

Mode: GSM 1900, Right Head, Tilt, Mid.ch

Area Scan (7x14x1): Measurement grid: dx=15mm, dy=15mm

Zoom Scan (5x5x7)/Cube 0: Measurement grid: dx=8mm, dy=8mm, dz=5mm

Reference Value = 10.1 V/m

Peak SAR (extrapolated) = 0.244 W/kg

SAR(1 g) = 0.147 mW/g; SAR(10 g) = 0.083 mW/g

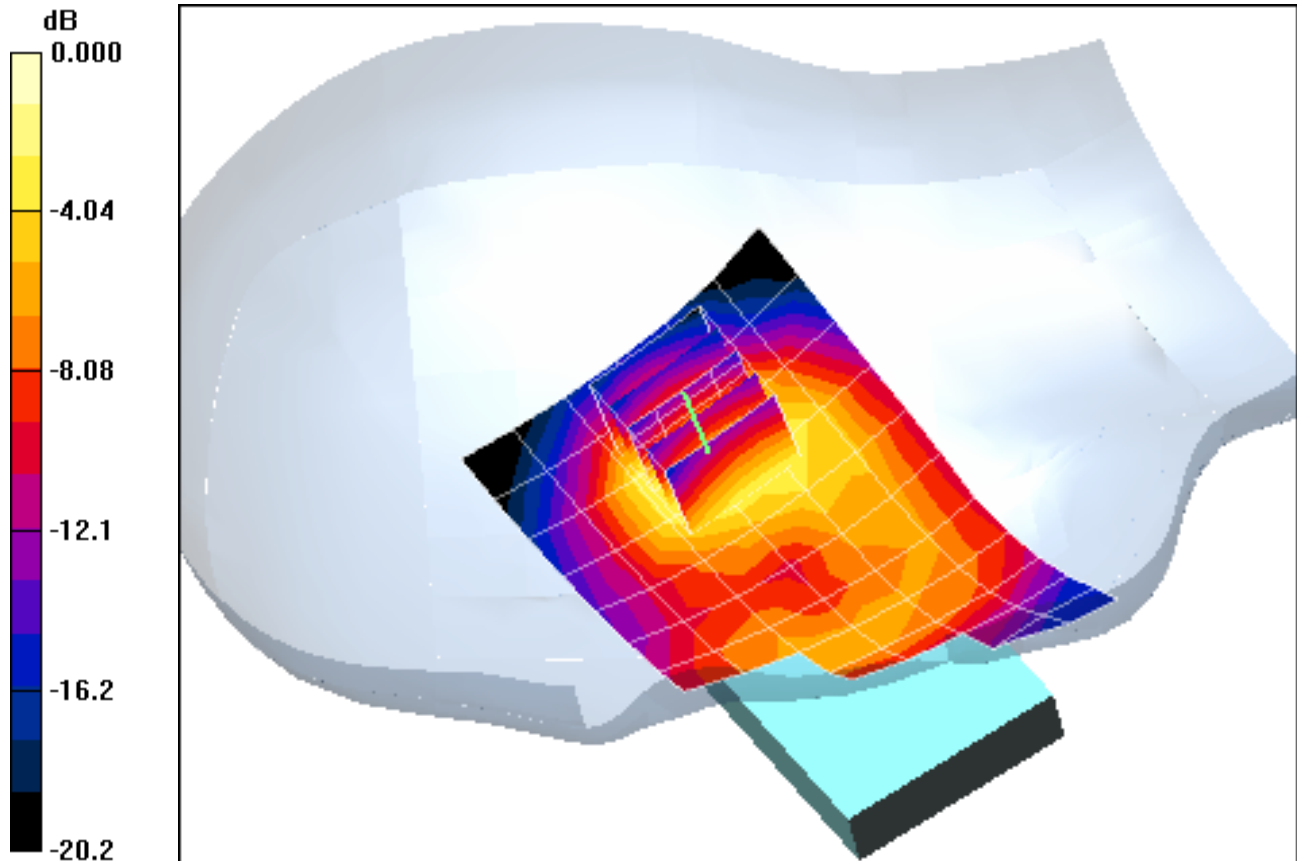

0 dB = 0.181mW/g

PCTEST ENGINEERING LABORATORY, INC.

DUT: GT-I6500U; Type: 850/1900 GSM/GPRS/EDGE and 850 WCDMA/HSPA Phone with Bluetooth and WLAN; Serial: FG-316-B

Communication System: GSM1900; Frequency: 1880 MHz; Duty Cycle: 1:8.3

Medium: 1900 Brain Medium parameters used:

$f = 1880 \text{ MHz}$; $\sigma = 1.44 \text{ mho/m}$; $\epsilon_r = 38.9$; $\rho = 1000 \text{ kg/m}^3$

Phantom section: Left Section

Test Date: 11-10-2009; Ambient Temp: 23.8 °C; Tissue Temp: 22.0 °C

Probe: ES3DV3 - SN3209; ConvF(5.1, 5.1, 5.1); Calibrated: 4/15/2009

Sensor-Surface: 3mm (Mechanical Surface Detection)

Electronics: DAE4 Sn665; Calibrated: 5/25/2009

Phantom: SAM with CRP; Type: SAM; Serial: TP1375

Measurement SW: DASY4, V4.7 Build 71; Postprocessing SW: SEMCAD, V1.8 Build 172

Mode: GSM 1900, Left Head, Touch, Mid.ch

Area Scan (7x14x1): Measurement grid: dx=15mm, dy=15mm

Zoom Scan (5x5x7)/Cube 0: Measurement grid: dx=8mm, dy=8mm, dz=5mm

Reference Value = 6.13 V/m

Peak SAR (extrapolated) = 0.605 W/kg

SAR(1 g) = 0.345 mW/g; SAR(10 g) = 0.193 mW/g

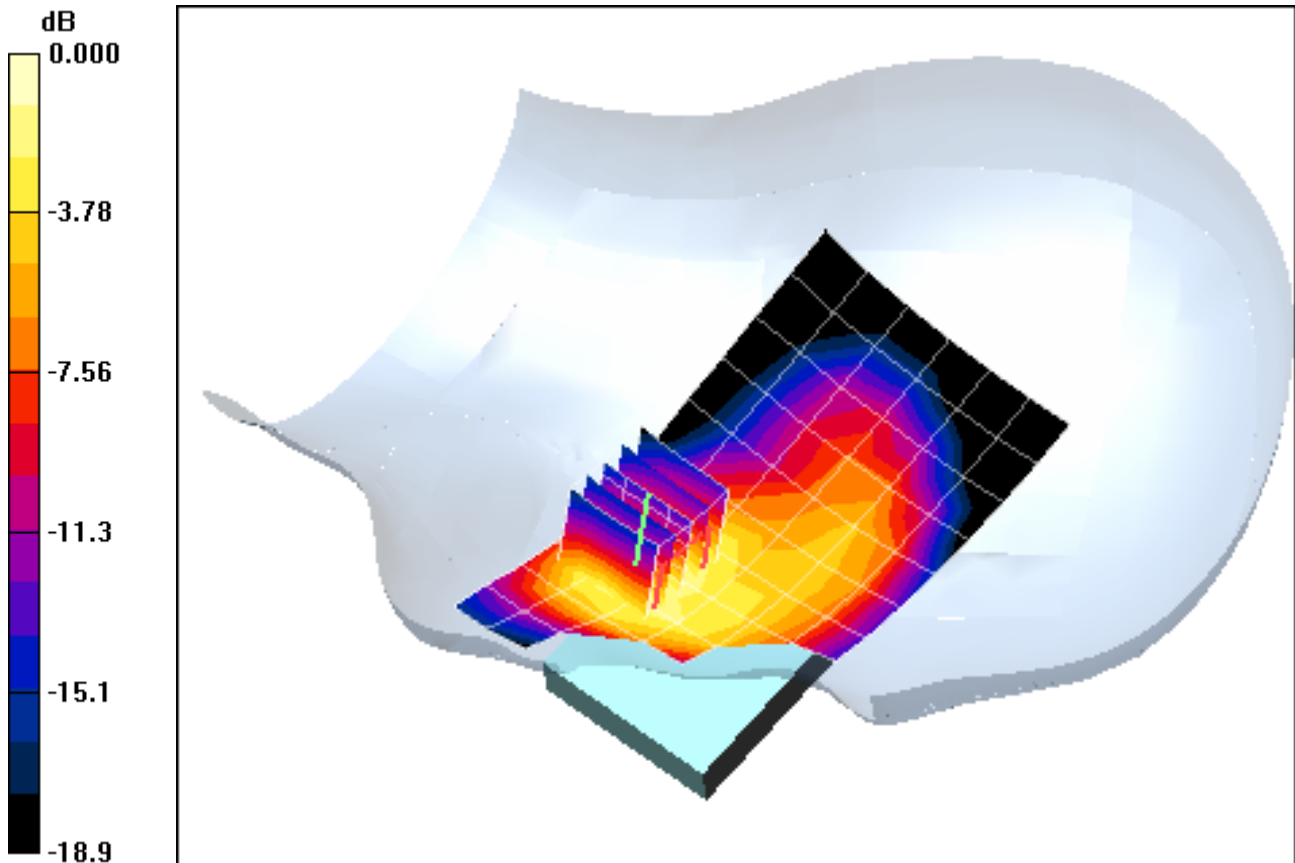

0 dB = 0.431mW/g

PCTEST ENGINEERING LABORATORY, INC.

DUT: GT-I6500U; Type: 850/1900 GSM/GPRS/EDGE and 850 WCDMA/HSPA Phone with Bluetooth and WLAN; Serial: FG-316-B

Communication System: GSM1900; Frequency: 1880 MHz; Duty Cycle: 1:8.3

Medium: 1900 Brain Medium parameters used:

$f = 1880 \text{ MHz}$; $\sigma = 1.44 \text{ mho/m}$; $\epsilon_r = 38.9$; $\rho = 1000 \text{ kg/m}^3$

Phantom section: Left Section

Test Date: 11-10-2009; Ambient Temp: 23.8 °C; Tissue Temp: 22.0 °C

Probe: ES3DV3 - SN3209; ConvF(5.1, 5.1, 5.1); Calibrated: 4/15/2009

Sensor-Surface: 3mm (Mechanical Surface Detection)

Electronics: DAE4 Sn665; Calibrated: 5/25/2009

Phantom: SAM with CRP; Type: SAM; Serial: TP1375

Measurement SW: DASY4, V4.7 Build 71; Postprocessing SW: SEMCAD, V1.8 Build 172

Mode: GSM 1900, Left Head, Tilt, Mid.ch

Area Scan (7x14x1): Measurement grid: dx=15mm, dy=15mm

Zoom Scan (5x5x7)/Cube 0: Measurement grid: dx=8mm, dy=8mm, dz=5mm

Reference Value = 9.35 V/m

Peak SAR (extrapolated) = 0.179 W/kg

SAR(1 g) = 0.114 mW/g; SAR(10 g) = 0.070 mW/g

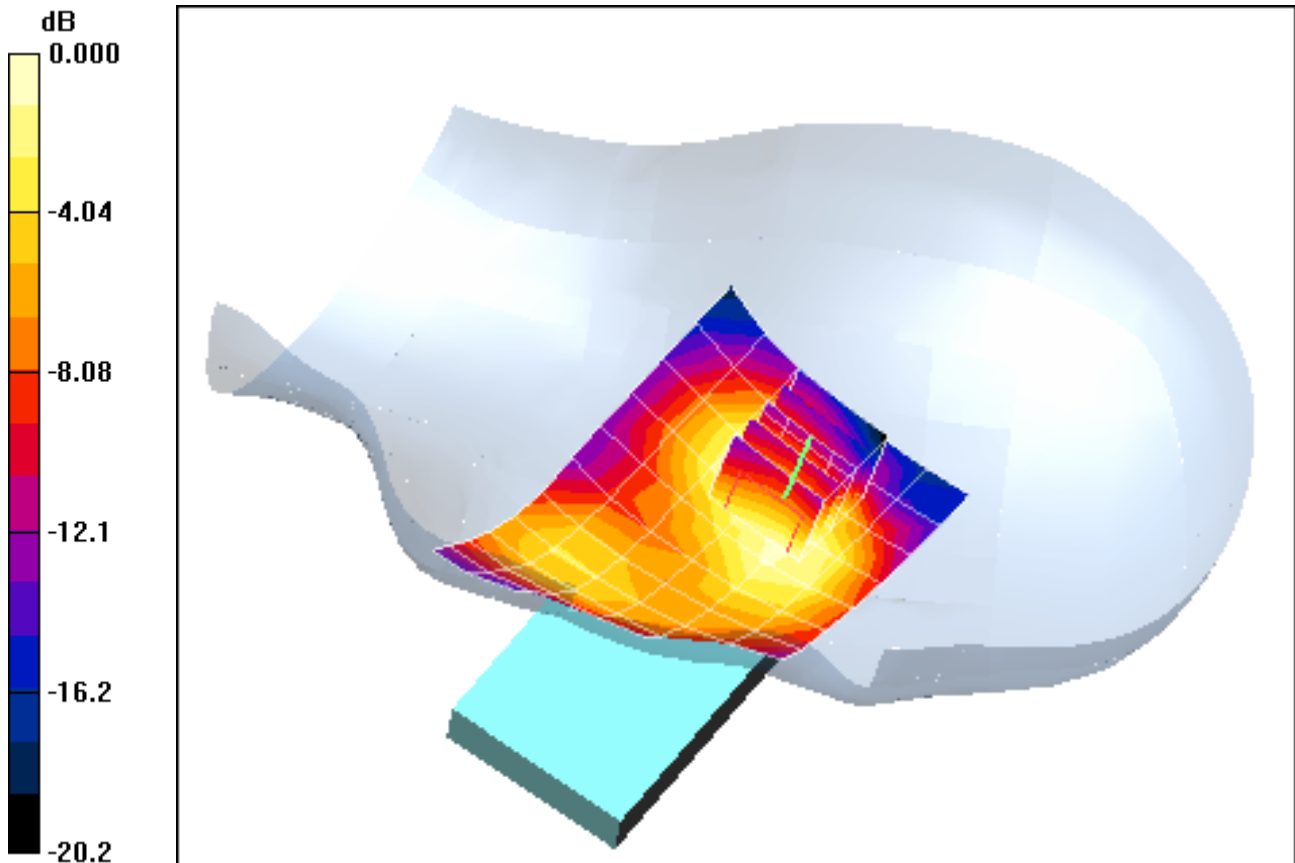

0 dB = 0.134mW/g

PCTEST ENGINEERING LABORATORY, INC.

DUT: GT-I6500U; Type: 850/1900 GSM/GPRS/EDGE and 850 WCDMA/HSPA Phone with Bluetooth and WLAN; Serial: FG-316-B

Communication System: GSM1900 GPRS; 2 Tx slots; Frequency: 1880 MHz; Duty Cycle: 1:4.15
Medium: 1900 Muscle Medium parameters used:

$$f = 1880 \text{ MHz}; \sigma = 1.56 \text{ mho/m}; \epsilon_r = 50.9; \rho = 1000 \text{ kg/m}^3$$

Phantom section: Flat Section; Space: 1.5 cm

Test Date: 11-10-2009; Ambient Temp: 23.5 °C; Tissue Temp: 21.8 °C

Probe: ES3DV3 - SN3209; ConvF(4.55, 4.55, 4.55); Calibrated: 4/15/2009

Sensor-Surface: 3mm (Mechanical Surface Detection)

Electronics: DAE4 Sn665; Calibrated: 5/25/2009

Phantom: SAM with CRP; Type: SAM; Serial: TP1375

Measurement SW: DASY4, V4.7 Build 71; Postprocessing SW: SEMCAD, V1.8 Build 172

Mode: GPRS 1900, Body SAR, Front side, Mid.ch, 2 Tx Slots

Area Scan (7x10x1): Measurement grid: dx=15mm, dy=15mm

Zoom Scan (5x5x7)/Cube 0: Measurement grid: dx=8mm, dy=8mm, dz=5mm

Reference Value = 5.99 V/m

Peak SAR (extrapolated) = 0.473 W/kg

SAR(1 g) = 0.291 mW/g; SAR(10 g) = 0.182 mW/g

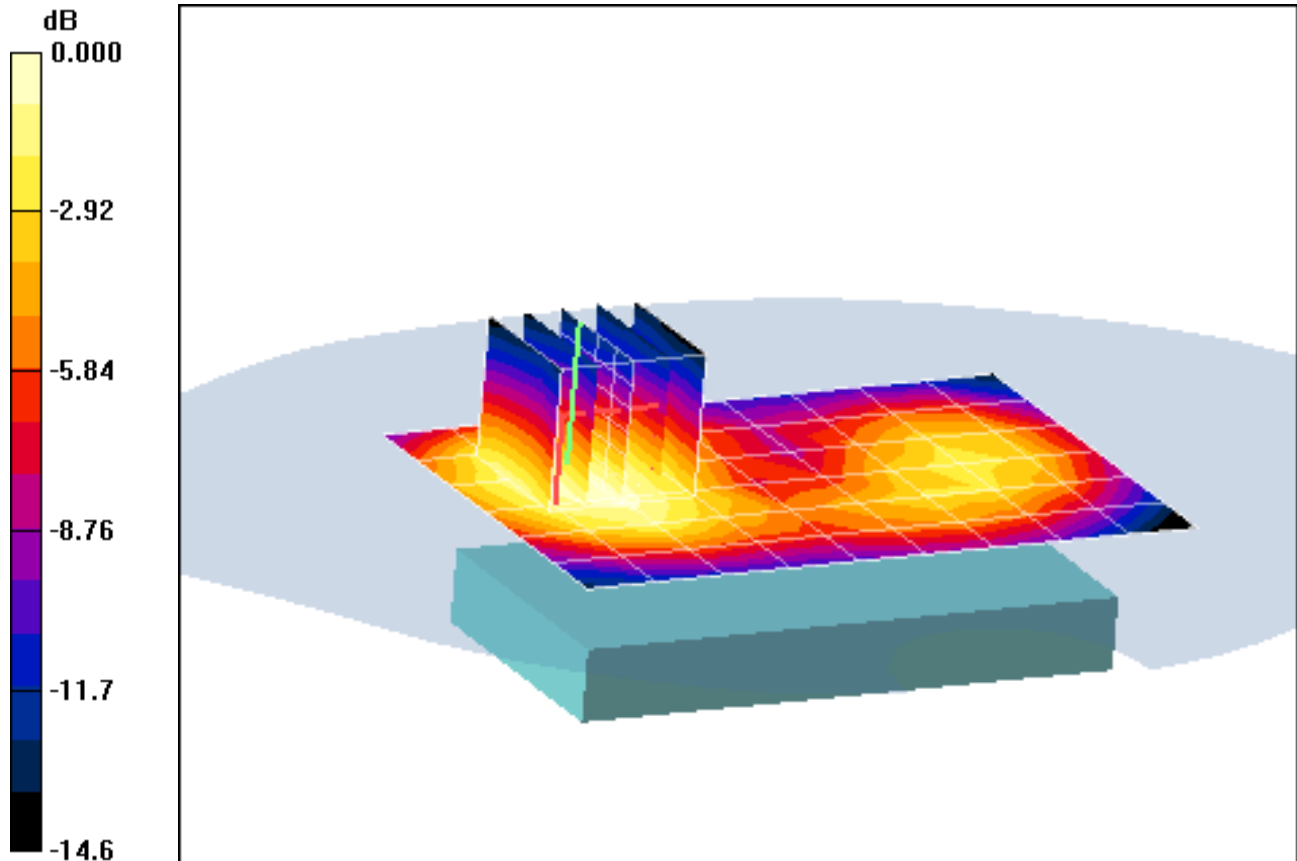

0 dB = 0.351mW/g

PCTEST ENGINEERING LABORATORY, INC.

DUT: GT-I6500U; Type: 850/1900 GSM/GPRS/EDGE and 850 WCDMA/HSPA Phone with Bluetooth and WLAN; Serial: FG-316-A

Communication System: IEEE 802.11b; Frequency: 2412 MHz; Duty Cycle: 1:1
Medium: 2450 Muscle Medium parameters used (interpolated):
 $f = 2412 \text{ MHz}$; $s = 1.88 \text{ mho/m}$; $\epsilon_r = 51.9$; $p = 1000 \text{ kg/m}^3$
Phantom section: Flat Section; Space 1.5 cm

Test Date: 11-11-2009; Ambient Temp: 23.8 °C; Tissue Temp: 22.1 °C

Probe: ES3DV2 - SN3022; ConvF(4.05, 4.05, 4.05); Calibrated: 9/18/2009
Sensor-Surface: 3mm (Mechanical Surface Detection)
Electronics: DAE4 Sn704; Calibrated: 5/14/2009
Phantom: SAM Sub; Type: SAM 4.0; Serial: TP-1403

Measurement SW: DASY4, V4.7 Build 71; Postprocessing SW: SEMCAD, V1.8 Build 184

Mode: IEEE 802.11b, Body SAR, Ch.01, 1Mbps, Back Side

Area Scan (7x11x1): Measurement grid: dx=15mm, dy=15mm

Zoom Scan (5x5x7)/Cube 0: Measurement grid: dx=8mm, dy=8mm, dz=5mm

Reference Value = 3.83 V/m;

Peak SAR (extrapolated) = 0.186 W/kg

SAR(1 g) = 0.099 mW/g; SAR(10 g) = 0.054 mW/g

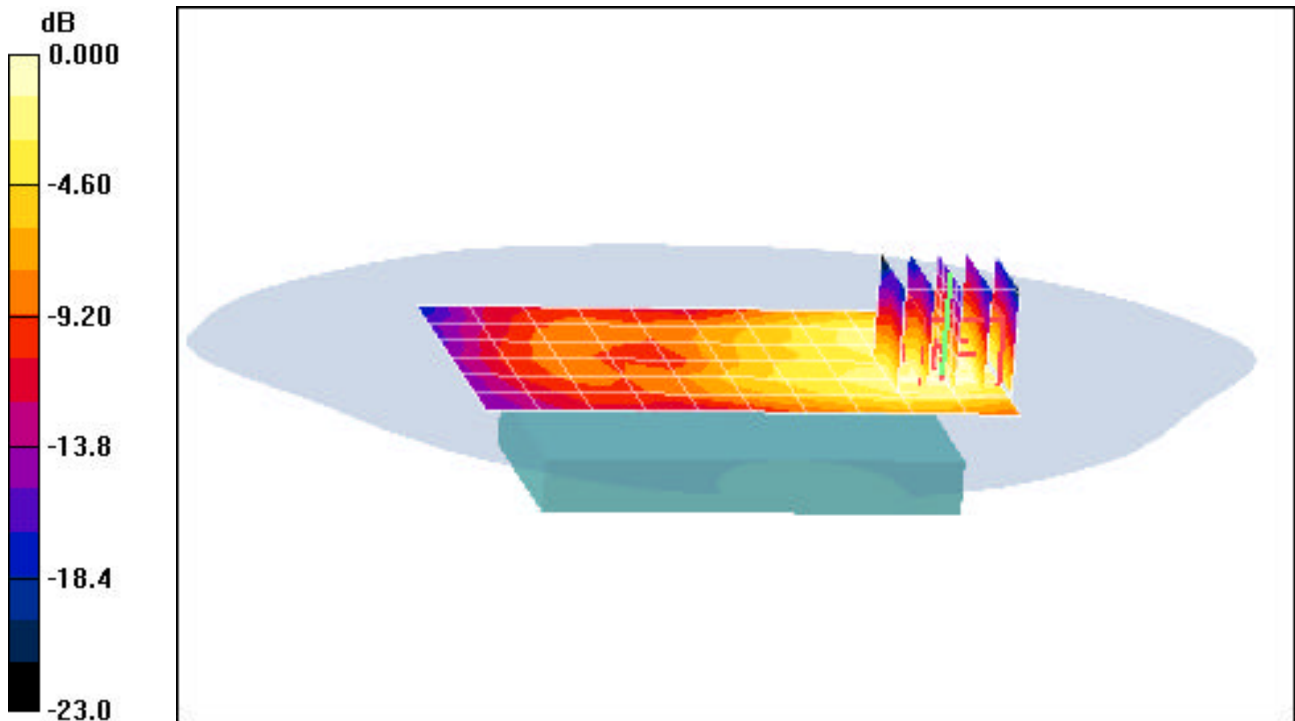

0 dB = 0.121mW/g

PCTEST ENGINEERING LABORATORY, INC.

DUT: GT-I6500U; Type: 850/1900 GSM/GPRS/EDGE and 850 WCDMA/HSPA Phone with Bluetooth and WLAN; Serial: FG-316-A

Communication System: GSM850; Frequency: 836.6 MHz; Duty Cycle: 1:8.3

Medium: 835 Brain Medium parameters used (interpolated):

$f = 836.6 \text{ MHz}$; $s = 0.885 \text{ mho/m}$; $\epsilon_r = 39.8$; $p = 1000 \text{ kg/m}^3$

Phantom section: Right Section

Test Date: 11-10-2009; Ambient Temp: 22.9 °C; Tissue Temp: 21.2 °C

Probe: ES3DV3 - SN3213; ConvF(5.94, 5.94, 5.94); Calibrated: 4/15/2009

Sensor-Surface: 3mm (Mechanical Surface Detection)

Electronics: DAE4 Sn649; Calibrated: 1/21/2009

Phantom: SAM Main; Type: SAM 4.0; Serial: TP-1114

Measurement SW: DASY4, V4.7 Build 71; Postprocessing SW: SEMCAD, V1.8 Build 184

Mode: GSM 850, Right Head, Touch, Mid.ch

Area Scan (7x14x1): Measurement grid: dx=15mm, dy=15mm

Zoom Scan (5x5x7)/Cube 0: Measurement grid: dx=8mm, dy=8mm, dz=5mm

Reference Value = 3.78 V/m

Peak SAR (extrapolated) = 0.167 W/kg

SAR(1 g) = 0.135 mW/g; SAR(10 g) = 0.102 mW/g

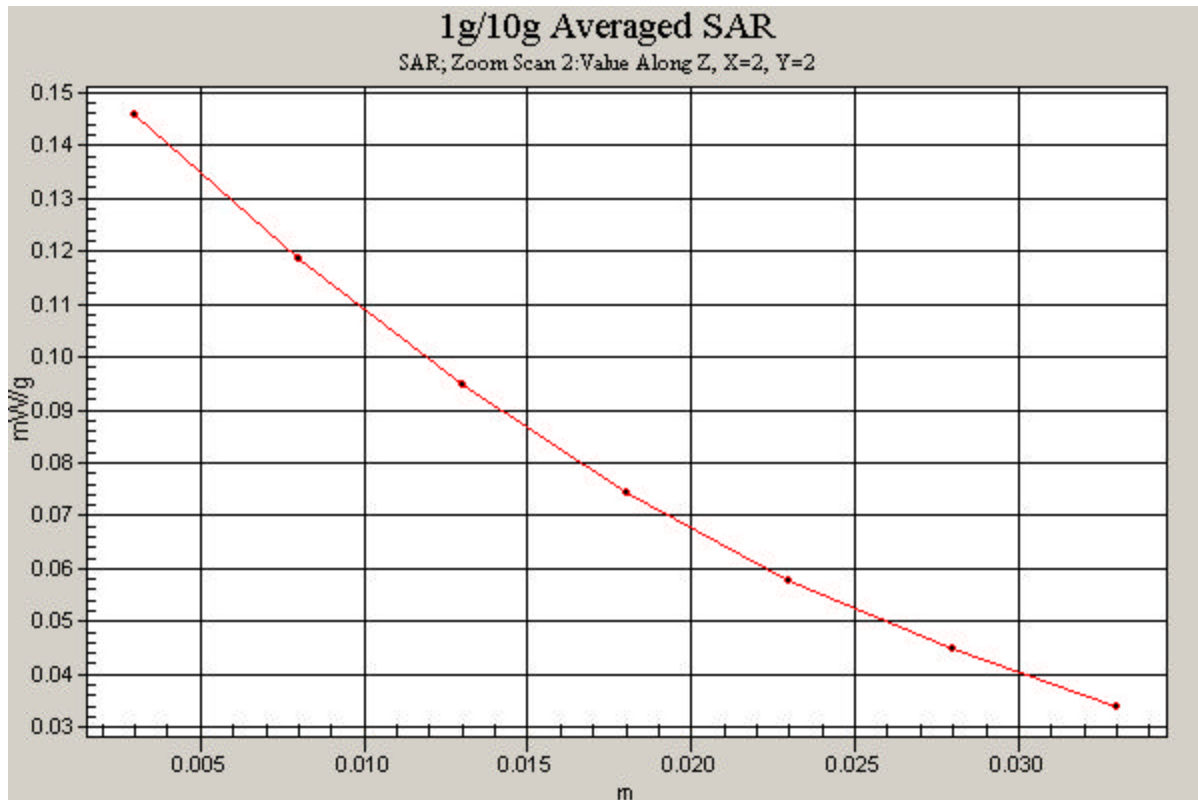

PCTEST ENGINEERING LABORATORY, INC.

DUT: GT-I6500U; Type: 850/1900 GSM/GPRS/EDGE and 850 WCDMA/HSPA Phone with Bluetooth and WLAN; Serial: FG-316-A

Communication System: GSM850 GPRS; 2 Tx slots; Frequency: 836.6 MHz; Duty Cycle: 1:4.15
Medium: 835 Muscle Medium parameters used (interpolated):
 $f = 836.6 \text{ MHz}$; $s = 0.981 \text{ mho/m}$; $\epsilon_r = 54.2$; $p = 1000 \text{ kg/m}^3$
Phantom section: Flat Section; Space: 1.5 cm

Test Date: 11-10-2009; Ambient Temp: 23.1 °C; Tissue Temp: 21.8 °C

Probe: ES3DV3 - SN3213; ConvF(5.92, 5.92, 5.92); Calibrated: 4/15/2009
Sensor-Surface: 3mm (Mechanical Surface Detection)
Electronics: DAE4 Sn649; Calibrated: 1/21/2009
Phantom: SAM Sub; Type: SAM 4.0; Serial: TP-1357

Measurement SW: DASY4, V4.7 Build 71; Postprocessing SW: SEMCAD, V1.8 Build 184

Mode: GPRS 850, Body SAR, Back side, Mid.ch, 2 Tx Slots

Area Scan (7x10x1): Measurement grid: dx=15mm, dy=15mm

Zoom Scan (5x5x7)/Cube 0: Measurement grid: dx=8mm, dy=8mm, dz=5mm

Reference Value = 15.1 V/m

Peak SAR (extrapolated) = 0.349 W/kg

SAR(1 g) = 0.261 mW/g; SAR(10 g) = 0.188 mW/g

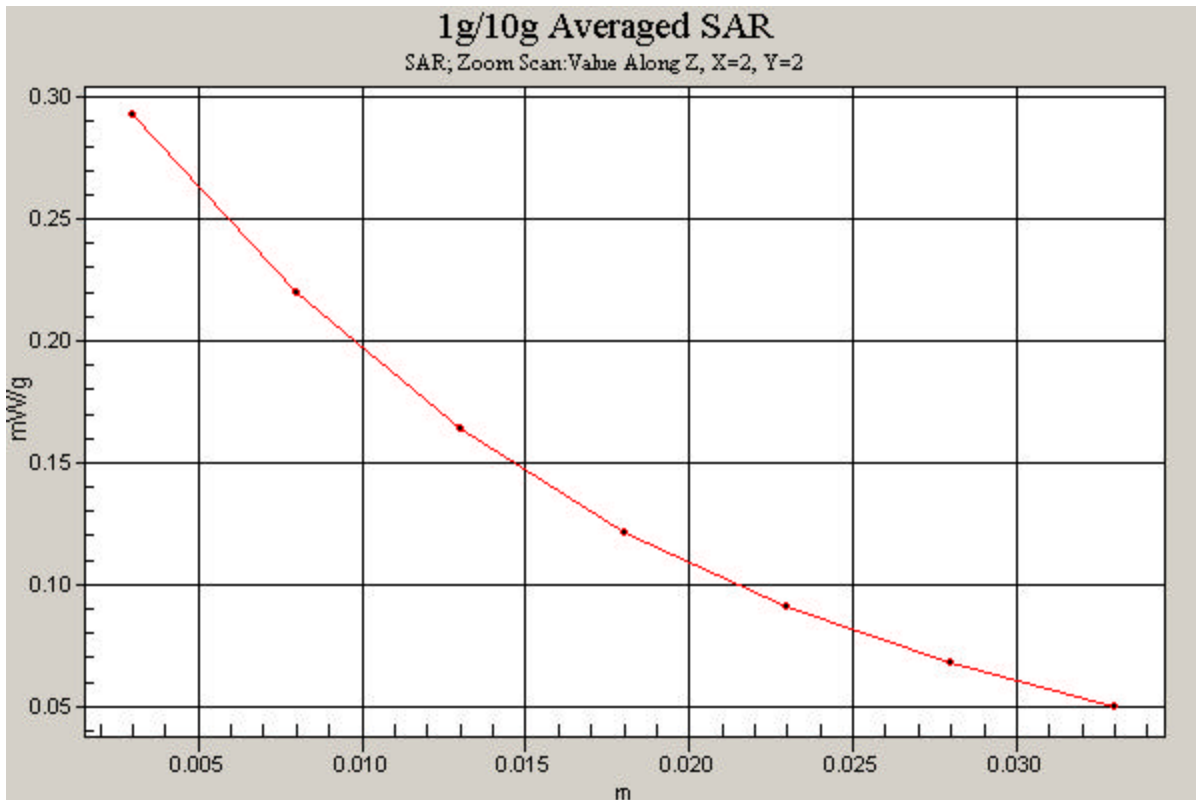

PCTEST ENGINEERING LABORATORY, INC.

DUT: GT-I6500U; Type: 850/1900 GSM/GPRS/EDGE and 850 WCDMA/HSPA Phone with Bluetooth and WLAN; Serial: FG-316-B

Communication System: GSM1900; Frequency: 1880 MHz; Duty Cycle: 1:8.3

Medium: 1900 Brain Medium parameters used:

$f = 1880 \text{ MHz}$; $\sigma = 1.44 \text{ mho/m}$; $\epsilon_r = 38.9$; $\rho = 1000 \text{ kg/m}^3$

Phantom section: Left Section

Test Date: 11-10-2009; Ambient Temp: 23.8 °C; Tissue Temp: 22.0 °C

Probe: ES3DV3 - SN3209; ConvF(5.1, 5.1, 5.1); Calibrated: 4/15/2009

Sensor-Surface: 3mm (Mechanical Surface Detection)

Electronics: DAE4 Sn665; Calibrated: 5/25/2009

Phantom: SAM with CRP; Type: SAM; Serial: TP1375

Measurement SW: DASY4, V4.7 Build 71; Postprocessing SW: SEMCAD, V1.8 Build 172

Mode: GSM 1900, Left Head, Touch, Mid.ch

Area Scan (7x14x1): Measurement grid: dx=15mm, dy=15mm

Zoom Scan (5x5x7)/Cube 0: Measurement grid: dx=8mm, dy=8mm, dz=5mm

Reference Value = 6.13 V/m

Peak SAR (extrapolated) = 0.605 W/kg

SAR(1 g) = 0.345 mW/g; SAR(10 g) = 0.193 mW/g

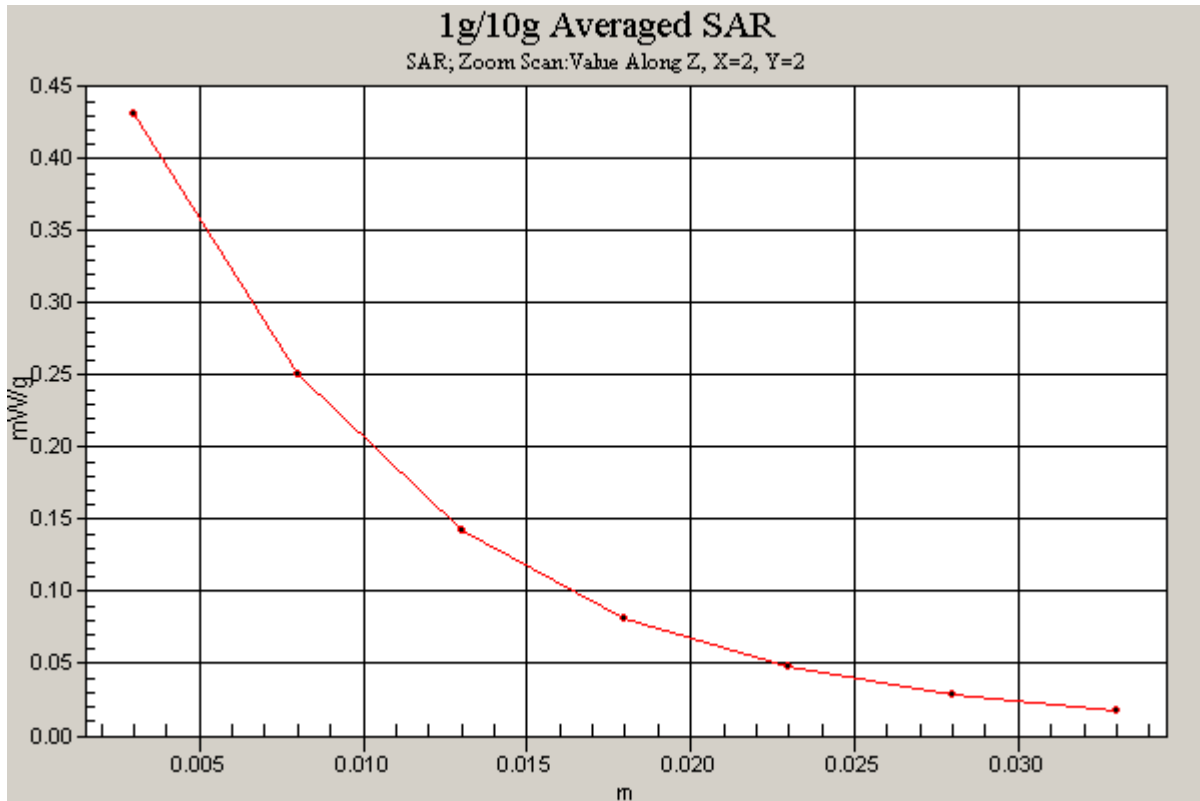

PCTEST ENGINEERING LABORATORY, INC.

DUT: GT-I6500U; Type: 850/1900 GSM/GPRS/EDGE and 850 WCDMA/HSPA Phone with Bluetooth and WLAN; Serial: FG-316-B

Communication System: GSM1900 GPRS; 2 Tx slots; Frequency: 1880 MHz; Duty Cycle: 1:4.15
Medium: 1900 Muscle Medium parameters used:

$$f = 1880 \text{ MHz}; \sigma = 1.56 \text{ mho/m}; \epsilon_r = 50.9; \rho = 1000 \text{ kg/m}^3$$

Phantom section: Flat Section; Space: 1.5 cm

Test Date: 11-10-2009; Ambient Temp: 23.5 °C; Tissue Temp: 21.8 °C

Probe: ES3DV3 - SN3209; ConvF(4.55, 4.55, 4.55); Calibrated: 4/15/2009

Sensor-Surface: 3mm (Mechanical Surface Detection)

Electronics: DAE4 Sn665; Calibrated: 5/25/2009

Phantom: SAM with CRP; Type: SAM; Serial: TP1375

Measurement SW: DASY4, V4.7 Build 71; Postprocessing SW: SEMCAD, V1.8 Build 172

Mode: GPRS 1900, Body SAR, Front side, Mid.ch, 2 Tx Slots

Area Scan (7x10x1): Measurement grid: dx=15mm, dy=15mm

Zoom Scan (5x5x7)/Cube 0: Measurement grid: dx=8mm, dy=8mm, dz=5mm

Reference Value = 5.99 V/m

Peak SAR (extrapolated) = 0.473 W/kg

SAR(1 g) = 0.291 mW/g; SAR(10 g) = 0.182 mW/g

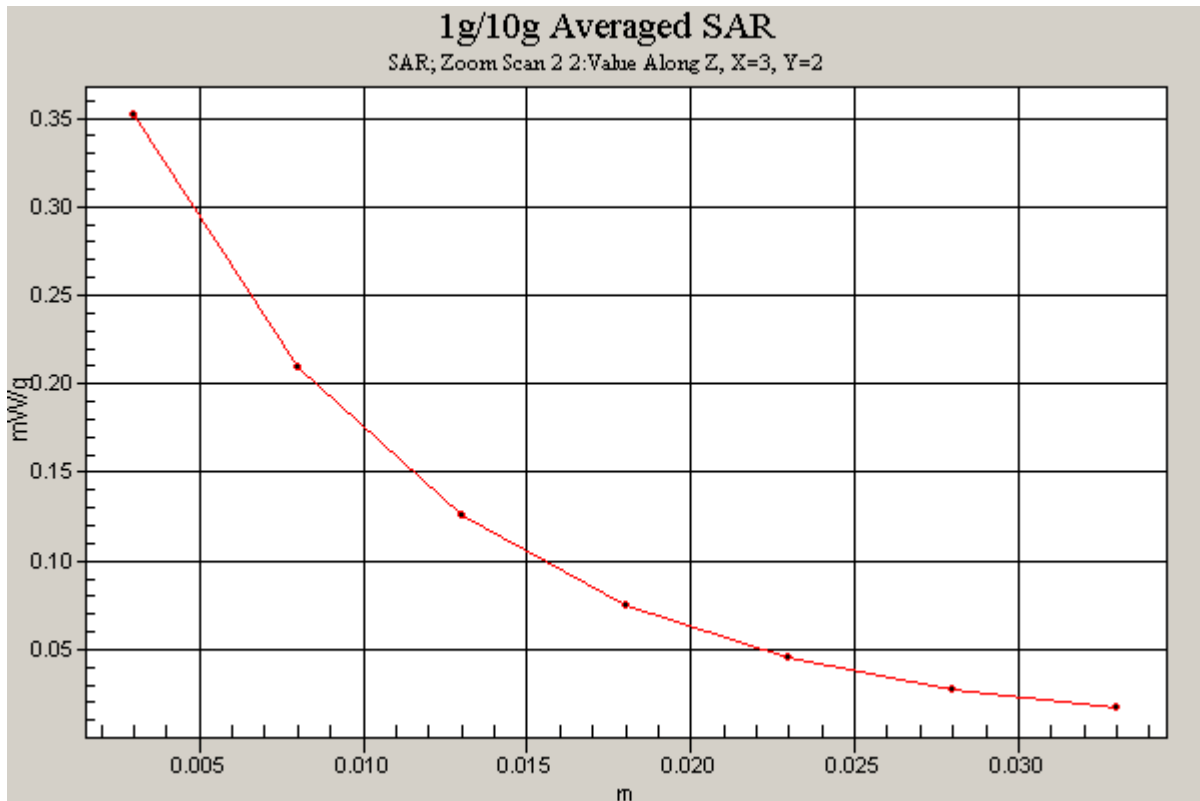

PCTEST ENGINEERING LABORATORY, INC.

DUT: GT-I6500U; Type: 850/1900 GSM/GPRS/EDGE and 850 WCDMA/HSPA Phone with Bluetooth and WLAN; Serial: FG-316-A

Communication System: IEEE 802.11b; Frequency: 2412 MHz; Duty Cycle: 1:1

Medium: 2450 Muscle Medium parameters used (interpolated):

$f = 2412 \text{ MHz}$; $s = 1.88 \text{ mho/m}$; $\epsilon_r = 51.9$; $\rho = 1000 \text{ kg/m}^3$

Phantom section: Flat Section

Test Date: 11-11-2009; Ambient Temp: 23.8 °C; Tissue Temp: 22.1 °C

Probe: ES3DV2 - SN3022; ConvF(4.05, 4.05, 4.05); Calibrated: 9/18/2009

Sensor-Surface: 3mm (Mechanical Surface Detection)

Electronics: DAE4 Sn704; Calibrated: 5/14/2009

Phantom: SAM Sub; Type: SAM 4.0; Serial: TP-1403

Measurement SW: DASY4, V4.7 Build 71; Postprocessing SW: SEMCAD, V1.8 Build 184

Mode: IEEE 802.11b, Body SAR, Ch.01, 1Mbps, Back Side

Area Scan (7x11x1): Measurement grid: dx=15mm, dy=15mm

Zoom Scan (5x5x7)/Cube 0: Measurement grid: dx=8mm, dy=8mm, dz=5mm

Reference Value = 3.83 V/m;

Peak SAR (extrapolated) = 0.186 W/kg

SAR(1 g) = 0.099 mW/g; SAR(10 g) = 0.054 mW/g

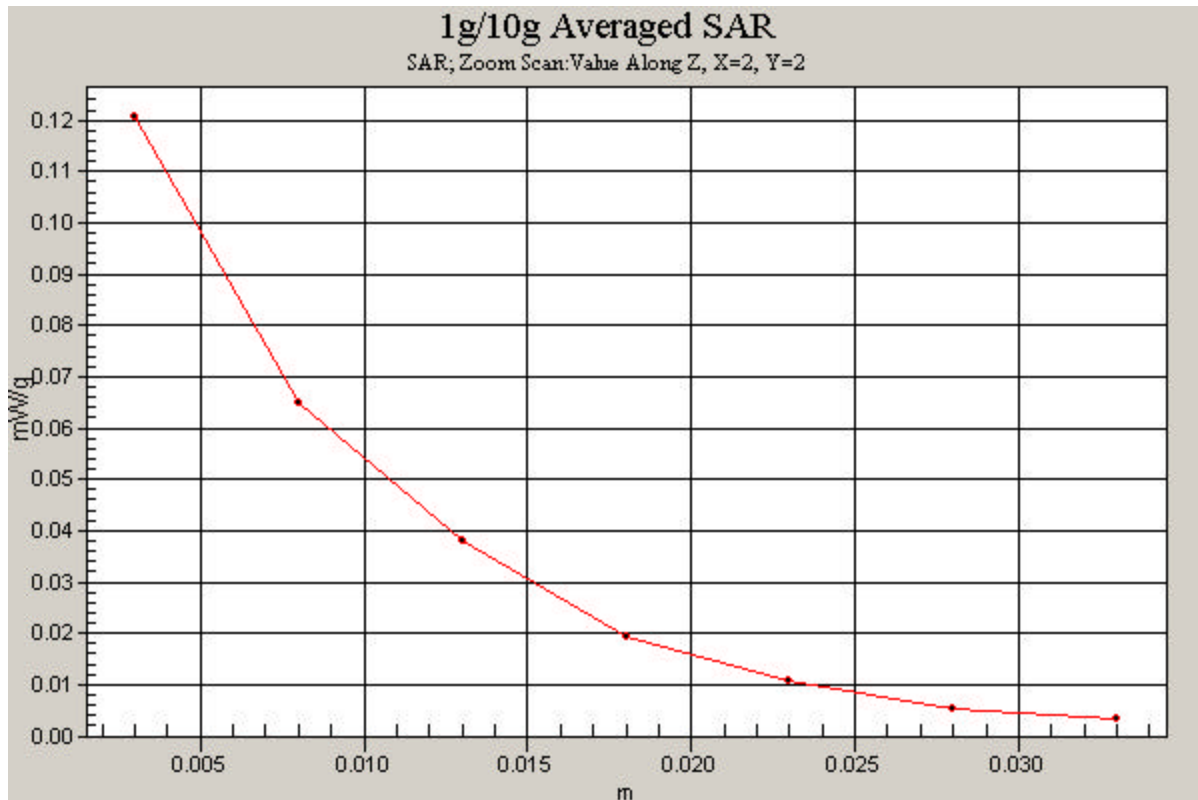

APPENDIX B: DIPOLE VALIDATION

PCTEST ENGINEERING LABORATORY, INC.

DUT: 835MHz SAR Validation Dipole; Type: D835V2; Serial: 4d047

Communication System: CW; Frequency: 835 MHz; Duty Cycle: 1:1

Medium: 835 Brain Medium parameters used:

$f = 835 \text{ MHz}$; $\sigma = 0.883 \text{ mho/m}$; $\epsilon_r = 39.9$; $\rho = 1000 \text{ kg/m}^3$

Phantom section: Flat Section; Space: 1.5 cm

Test Date: 11-10-2009; Ambient Temp: 22.9 °C; Tissue Temp: 21.2 °C

Probe: ES3DV3 - SN3213; ConvF(5.94, 5.94, 5.94); Calibrated: 4/15/2009

Sensor-Surface: 3mm (Mechanical Surface Detection)

Electronics: DAE4 Sn649; Calibrated: 1/21/2009

Phantom: SAM Main; Type: SAM 4.0; Serial: TP-1114

Measurement SW: DASY4, V4.7 Build 71; Postprocessing SW: SEMCAD, V1.8 Build 172

835MHz Dipole Validation

Area Scan (7x13x1): Measurement grid: dx=15mm, dy=15mm

Zoom Scan (5x5x7)/Cube 0: Measurement grid: dx=8mm, dy=8mm, dz=5mm

Input Power = 20 dBm (100 mW)

SAR(1 g) = 0.964 mW/g; SAR(10 g) = 0.626 mW/g

Deviation = -0.62%

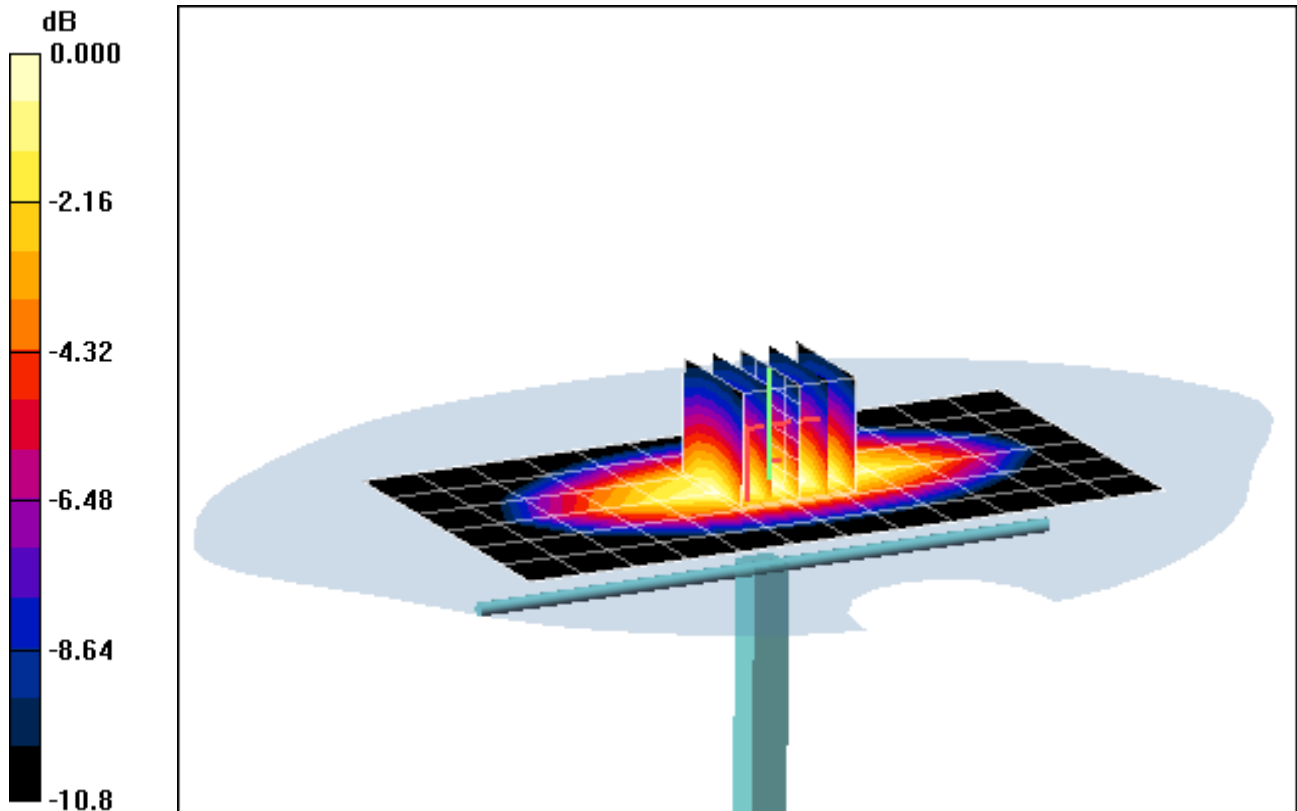

0 dB = 1.13mW/g

PCTEST ENGINEERING LABORATORY, INC.

DUT: SAR Dipole 1900 MHz; Type: D1900V2; Serial: 502

Communication System: CW; Frequency: 1900 MHz; Duty Cycle: 1:1

Medium: 1900 Muscle Medium parameters used (interpolated):

$f = 1900 \text{ MHz}$; $\sigma = 1.58 \text{ mho/m}$; $\epsilon_r = 50.86$; $\rho = 1000 \text{ kg/m}^3$

Phantom section: Flat Section; Space: 1.0 cm

Test Date: 11-10-2009; Ambient Temp: 23.5 °C; Tissue Temp: 21.8 °C

Probe: ES3DV3 - SN3209; ConvF(4.55, 4.55, 4.55); Calibrated: 4/15/2009

Sensor-Surface: 3mm (Mechanical Surface Detection)

Electronics: DAE4 Sn665; Calibrated: 5/25/2009

Phantom: SAM with CRP; Type: SAM; Serial: TP1375

Measurement SW: DASY4, V4.7 Build 71; Postprocessing SW: SEMCAD, V1.8 Build 172

1900MHz Dipole Validation

Area Scan (5x7x1): Measurement grid: dx=15mm, dy=15mm

Zoom Scan (5x5x7)/Cube 0: Measurement grid: dx=8mm, dy=8mm, dz=5mm

Input Power = 20 dBm (100 mW)

SAR(1 g) = 4.35 mW/g; SAR(10 g) = 2.24 mW/g

Deviation = 4.82 %

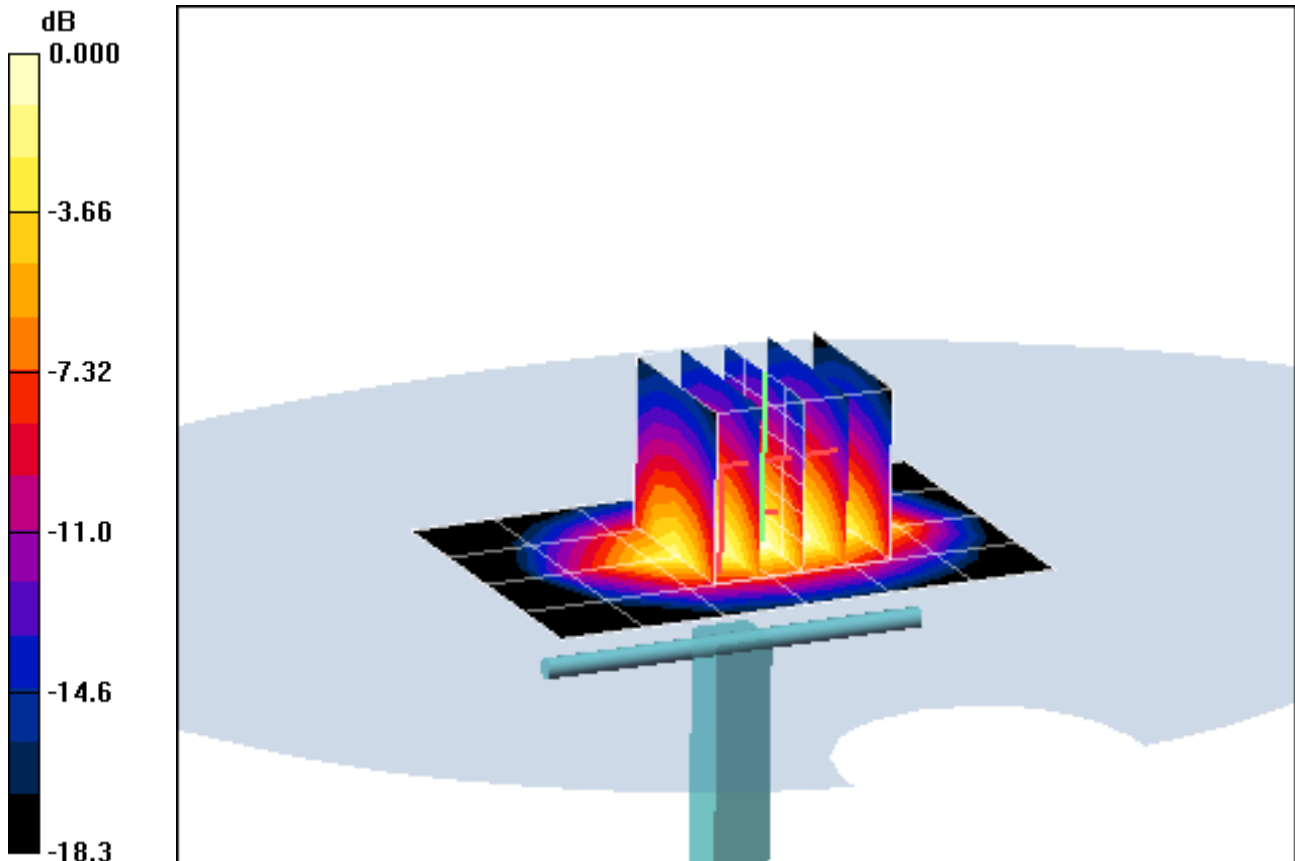

0 dB = 5.53mW/g

PCTEST ENGINEERING LABORATORY, INC.

DUT: Dipole 2450 MHz; Type: D2450V2; Serial: D2450V2 - SN:719

Communication System: CW; Frequency: 2450 MHz; Duty Cycle: 1:1

Medium: 2450 Muscle Medium parameters used:

$f = 2450 \text{ MHz}$; $s = 1.93 \text{ mho/m}$; $\epsilon_r = 51.8$; $\rho = 1000 \text{ kg/m}^3$

Phantom section: Flat Section; Space: 1.5 cm

Test Date: 11-11-2009; Ambient Temp: 23.8 °C; Tissue Temp: 22.1 °C

Probe: ES3DV2 - SN3022; ConvF(4.05, 4.05, 4.05); Calibrated: 9/18/2009

Sensor-Surface: 3mm (Mechanical Surface Detection)

Electronics: DAE4 Sn704; Calibrated: 5/14/2009

Phantom: SAM Sub; Type: SAM 4.0; Serial: TP-1403

Measurement SW: DASY4, V4.7 Build 71; Postprocessing SW: SEMCAD, V1.8 Build 184

2450MHz Dipole Validation

Area Scan (5x7x1): Measurement grid: dx=15mm, dy=15mm

Zoom Scan (5x5x7)/Cube 0: Measurement grid: dx=8mm, dy=8mm, dz=5mm

Input Power = 10.02 dBm (10 mW)

SAR(1 g) = 0.490 mW/g; SAR(10 g) = 0.226 mW/g

Deviation = -4.67%

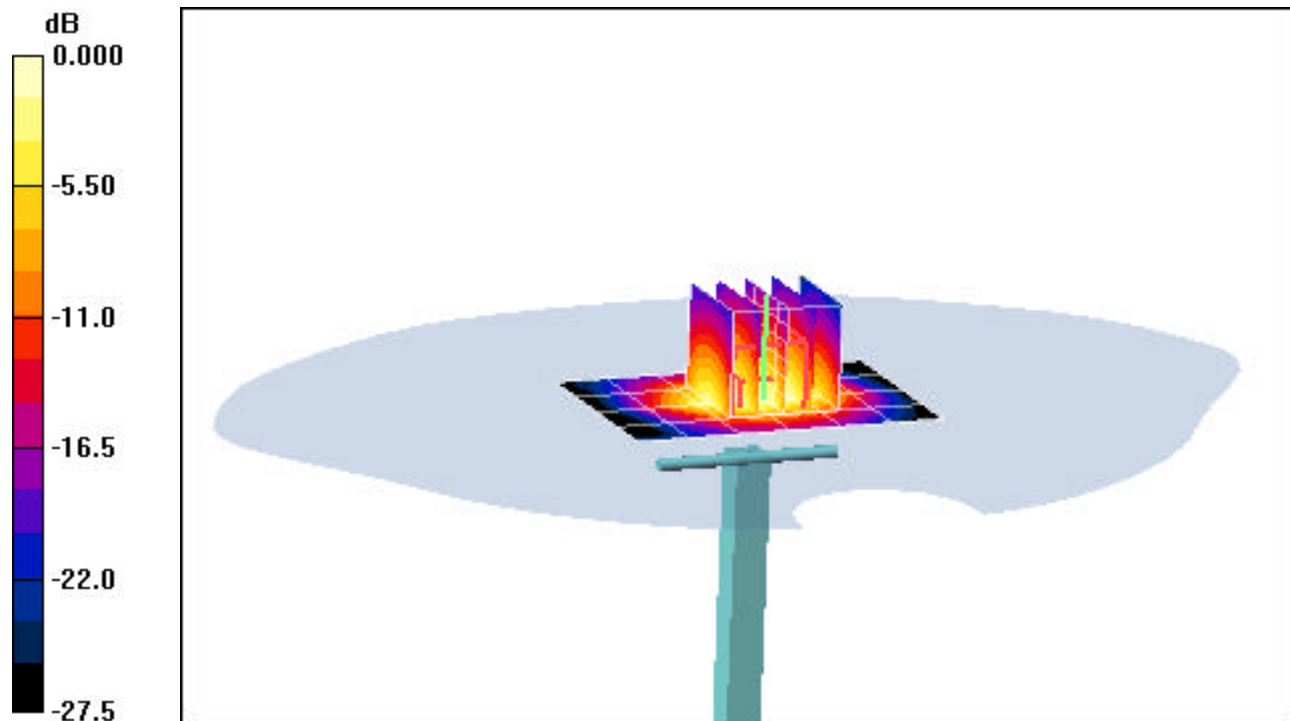

0 dB = 0.631mW/g