



SAMSUNG ELECTRONICS Co., Ltd.,  
Regulatory Compliance Group  
IT R&D Center

416, Maetan-3dong,  
Yeongtong-gu, Suwon-si,  
Gyeonggi-do, Korea 443-742

# TEST REPORT ON SAR

Model Tested: GT-B6520L  
FCC ID (Requested): A3LGTB6520L  
Job No: FH-154  
Report No: FH-154-S1

- Abstract -


This document reports on SAR Tests carried out in accordance with FCC/OET Bulletin 65, Supplement C(July 2001).

Prepared By

\_\_\_\_\_  
MK YOUN - Test Engineer


Authorized By

\_\_\_\_\_  
JADE JANG – Technical Manager

FCC ID: A3LGTB6520L	Report Number: FH-154-S1	Page :	1 of 38
 SAMSUNG Electronics CO. LTD	EUT Type: Dual-Band GSM850/1900 and Dual-Band WCDMA850/1900 Phone with Bluetooth, EDGE RX Only and WLAN	Issue Date :	Jul.22, 2010

# Contents

1. GENERAL INFORMATION .....	3
2. DESCRIPTION OF DEVICE .....	3
3. DESCRIPTION OF TEST EQUIPMENT .....	4
3.1 SAR Measurement Setup .....	4
3.2 E-field Probe .....	5
3.3 Phantom.....	7
3.4 Brain Simulating Mixture Characterization .....	9
3.5 Device Holder for Transmitters.....	9
3.6 Validation Dipole .....	10
3.7 Equipment Calibration.....	11
4. SAR MEASUREMENT PROCEDURE .....	12
5. DESCRIPTION OF TEST POSITION .....	13
5.1 SAM Phantom Shape.....	13
5.2 “cheek” Position .....	13
5.3 “tilted” Position .....	15
5.4 Body Holster/Belt Clip Configurations .....	16
6. MEASUREMENT UNCERTAINTY .....	18
7. SYSTEM VERIFICATION.....	21
7.1 Tissue Verification .....	21
7.2 Test System Validation .....	21
8. SAR MEASUREMENT RESULTS.....	22
8.1 GSM850 Head SAR Results .....	26
8.2 GPRS850 Body SAR Results(Without Holster).....	27
8.3 GSM1900 Head SAR Results .....	28
8.4 GPRS1900 Body SAR Results(Without Holster).....	29
8.5 WCDMA850 Head SAR Results .....	30
8.6 WCDMA850 Body SAR Results(Without Holster).....	31
8.7 WCDMA1900 Head SAR Results .....	32
8.8 WCDMA1900 Body SAR Results(Without Holster).....	33
8.9 WLAN Head SAR Results.....	34
8.10 WLAN Body SAR Results(Without Holster) .....	35
9. CONCLUSION .....	36
10. REFERENCES .....	37
APPENDIX A SAR Definition .....	39
APPENDIX B Probe Calibration Process .....	40
APPENDIX C ANSI/IEEE C95.1 – 2005 RF EXPOSURE LIMITS.....	41
APPENDIX D The Validation Measurements .....	42
APPENDIX E Plots of The SAR Measurements.....	46
APPENDIX F Probe Calibration .....	82
APPENDIX G Calibration of The Validation Dipole .....	94


FCC ID: A3LGTB6520L	Report Number: FH-154-S1	Page :	2 of 38
 SAMSUNG Electronics CO. LTD	EUT Type: Dual-Band GSM850/1900 and Dual-Band WCDMA850/1900 Phone with Bluetooth, EDGE RX Only and WLAN	Issue Date :	Jul.22, 2010

## 1. GENERAL INFORMATION

Test Dates : Jul.13, 2010 ~ Jul.16, 2010  
Manufacturer : SAMSUNG ELECTRONICS Co., Ltd.  
Address : 416 Maetan3-Dong, Suwon City, Korea  
Test Standard : §2.1093; FCC/OET Bulletin 65, Supplement C(July 2001)  
FCC Classification : Licensed Portable Transmitter Held to Ear (PCE)  
Tested for : FCC/TCB Certification

## 2. DESCRIPTION OF DEVICE

Test Sample : Dual-Band GSM850/1900 and Dual-Band WCDMA850/1900  
Phone with Bluetooth and WLAN  
Model Number : GT-B6520L  
Serial Number : Identical prototype (S/N : # FH-154-C)  
Tx Freq.Range: 824.2 ~ 848.8 MHz (GSM850)  
1850.20 ~ 1909.80 MHz (GSM1900)  
826.4 ~ 846.6 MHz (WCDMA850)  
1852.4 ~ 1907.6 MHz (WCDMA1900)  
2400 ~ 2483.5 MHz (WLAN)  
Rx Freq.Range: 869.2 ~ 893.8 MHz (GSM850)  
1930.20 ~ 1989.80 MHz (GSM1900)  
871.4 ~ 891.6 MHz (WCDMA850)  
1932.4 ~ 1987.6 MHz (WCDMA1900)  
2400 ~ 2483.5 MHz (WLAN)  
Antenna Manufacturer : Furukawa  
Model No.: GT-B6520L  
GPRS Class 12  
Antenna Dimensions : 50.2 \* 13.1 \* 7.3(mm)  
Separation distance between Main and Bluetooth antenna : 10 (mm)

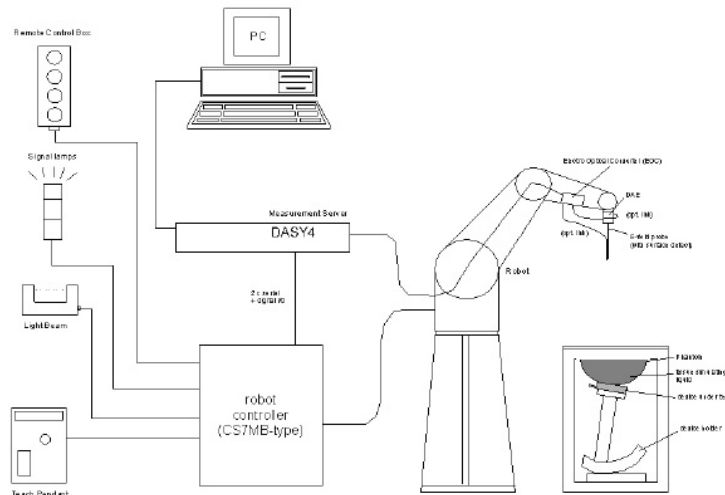
FCC ID: A3LGTB6520L	Report Number: FH-154-S1		Page :	3 of 38
 SAMSUNG Electronics CO. LTD	EUT Type:	Dual-Band GSM850/1900 and Dual-Band WCDMA850/1900 Phone with Bluetooth, EDGE RX Only and WLAN	Issue Date :	Jul.22, 2010

### 3. DESCRIPTION OF TEST EQUIPMENT

#### 3.1 SAR Measurement Setup

##### Robotic System


Measurements are performed using the DASY4 (or DASY5) automated dosimetric assessment system. Which is made by Schmid & Partner Engineering AG (SPEAG) in Zurich, Switzerland and consists of high precision robotics system (Stäubli), robot controller, measurement server, Samsung computer, near-field probe, probe alignment sensor, and the SAM twin phantom containing the brain equivalent material. The robot is a six-axis industrial robot performing precise movements to position the probe to the location (points) of maximum electromagnetic field (EMF) (see Fig. 3.1).



**Figure 3.1 SAR Measurement System Setup**

##### System Hardware

A cell controller system contains the power supply, robot controller, teach pendant (Joystick), and a remote control is used to drive the robot motors. The PC consists of the Samsung computer with Windows XP system and SAR Measurement Software DASY4 (or DASY5), LCD monitor, mouse and keyboard. The Stäubli Robot is connected to the cell controller to allow software manipulation of the robot. A data acquisition electronic (DAE) circuit that performs the signal amplification, signal multiplexing, AD-conversion, offset measurements, mechanical surface detection, collision detection, etc. is connected to the Electro-optical coupler (EOC). The EOC performs the conversion from the optical into digital electric signal of the DAE and transfers data to the measurement server.

FCC ID: A3LGTB6520L	Report Number: FH-154-S1	Page :	4 of 38
 SAMSUNG Electronics CO. LTD	EUT Type: Dual-Band GSM850/1900 and Dual-Band WCDMA850/1900 Phone with Bluetooth, EDGE RX Only and WLAN	Issue Date :	Jul.22, 2010

**System Electronics**

The DAE4(or DAE3) consists of a highly sensitive electrometer-grade preamplifier with auto-zeroing, a channel and gain-switching multiplexer, a fast 16-bit AD-converter and a command decoder and control logic unit. Transmission to the measurement server is accomplished through an optical downlink for data and status information and an optical uplink for commands and clock lines. The mechanical probe mounting device includes two different sensor systems for frontal and sidewise probe contacts. They are also used for mechanical surface detection and probe collision detection. The robot uses its own controller with a built in VME-bus computer.

**3.2 E-field Probe**

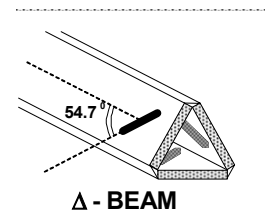


The SAR measurement were conducted with the dosimetric probe ES3DV2, ES3DV3, EX3DV4 and ET3DV6, designed in the classical triangular configuration (see Fig.3.3) and optimized for dosimetric evaluation. The probe is constructed using the thick film technique; with printed resistive lines on ceramic substrates. If the probe is flatly touching the surface, the coupling is zero. The distance of the coupling maximum to the surface is independent of the surface reflectivity and largely independent of the surface to probe angle. The DASY4 software reads the reflection during a software approach and looks for the maximum using a 2<sup>nd</sup> order fitting (see Fig.3.2). The approach is

**Figure 3.2 DAE System** stopped at reaching the maximum.


**Probe Specifications**

- Construction      Symmetrical design with triangular core
- Interleaved sensors
- Built-in shielding against static charges
- PEEK enclosure material (resistant to organic solvents, e.g., DGBE)
- Calibration        Basic Broad Band Calibration in air: 10-3000 MHz
- Conversion Factors (CF) for HSL 900 and HSL 1800



**Figure 3.3 Triangular Probe Configuration**

Additional CF for other liquids and frequencies upon request

FCC ID: A3LGTB6520L	Report Number: FH-154-S1		Page :	5 of 38
 SAMSUNG Electronics CO. LTD	EUT Type:	Dual-Band GSM850/1900 and Dual-Band WCDMA850/1900 Phone with Bluetooth, EDGE RX Only and WLAN	Issue Date :	Jul.22, 2010

Frequency 10 MHz to > 6 GHz; Linearity:  $\pm 0.2$  dB (30 MHz to 3 GHz)

Directivity **[ES3DV3], [ET3DV6]**  
 $\pm 0.2$  dB in HSL (rotation around probe axis)  
 $\pm 0.3$  dB in tissue material (rotation normal to probe axis)  
**[EX3DV4]**  
 $\pm 0.3$  dB in HSL (rotation around probe axis)  
 $\pm 0.5$  dB in tissue material (rotation normal to probe axis)

Dynamic Range **[ES3DV3], [ET3DV6]**  
 $5\mu\text{W/g}$  to  $> 100\text{mW/g}$ ; Linearity:  $\pm 0.2\text{dB}$   
**[EX3DV4]**  
 $10\ \mu\text{W/g}$  to  $> 100\ \text{mW/g}$ ; Linearity:  $\pm 0.2\ \text{dB}$

Dimensions **[ES3DV3], [ES3DV2]**  
Overall length: 330 mm (Tip: 20 mm)  
Tip diameter: 3.9 mm (Body: 12 mm)  
Distance from probe tip to dipole centers: 2.1 mm  
**[EX3DV4]**  
Overall length: 330 mm (Tip: 20 mm)  
Tip diameter: 2.5 mm (Body: 12 mm)  
Typical distance from probe tip to dipole centers: 1 mm




[ES3DV3] , [ES3DV2]

**[ET3DV6]**  
Overall length: 330mm  
Tip length: 16mm  
Body diameter: 12mm  
Tip diameter: 6.8mm  
Distance from probe tip to dipole centers: 2.7mm

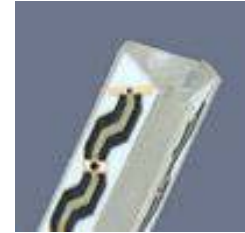


[EX3DV4]

Application **[ES3DV3], [ES3DV2]**

FCC ID: A3LGTB6520L	Report Number: FH-154-S1		Page :	6 of 38
 SAMSUNG Electronics CO. LTD	EUT Type:	Dual-Band GSM850/1900 and Dual-Band WCDMA850/1900 Phone with Bluetooth, EDGE RX Only and WLAN	Issue Date :	Jul.22, 2010

General dosimetry up to 5 GHz  
 Dosimetry in strong gradient fields  
 Compliance tests of mobile phones



**[EX3DV4]**

High precision dosimetric measurements in any exposure scenario (e.g., very strong gradient fields). Only probe which enables compliance testing for frequencies up to 6 GHz with precision of better 30 %.

[ET3DV6]

**[ET3DV6]**

General dosimetry up to 3 GHz  
 Compliance tests of mobile phones  
 Fast automatic scanning in arbitrary phantoms

Optical  
 Surface  
 Detection

**[ET3DV6]**

± 0.2 mm repeatability in air and clear liquids over diffuse reflecting surfaces

**3.3 Phantom**


**SAM Twin Phantom**

The SAM Twin Phantom V4.0 is constructed of a fiberglass shell integrated in a wooden table. The shape of the shell is based on data from an anatomical study designed to determine the maximum exposure in at least 90% of all users. It enables the dosimetric evaluation of left and right hand phone usage as well as body mounted usage at the flat phantom region. A cover prevents the evaporation of the liquid.

Reference markings on the phantom allow the complete setup of all predefined phantom positions and measurement grids by manually teaching three points in the robot. (See Figure 3.5)



**Figure3.5 SAM Twin Phantom**

FCC ID: A3LGTB6520L	Report Number: FH-154-S1		Page :	7 of 38
 SAMSUNG Electronics CO. LTD	EUT Type:	Dual-Band GSM850/1900 and Dual-Band WCDMA850/1900 Phone with Bluetooth, EDGE RX Only and WLAN	Issue Date :	Jul.22, 2010

### SAM Twin Phantom Specification

Construction	The shell corresponds to the specifications of the Specific Anthropomorphic Mannequin (SAM) phantom defined in IEEE 1528-2003, EN 50361:2001 and IEC 62209. It enables the dosimetric evaluation of left and right hand phone usage as well as body mounted usage at the flat phantom region. A cover prevents evaporation of the liquid.
Shell Thickness	2 ± 0.2 mm
Filling Volume	Approx. 25 liters
Dimensions	Height: 810 mm; Length: 1000 mm; Width: 500 mm

### Modular Flat Phantom

The Modular Flat Phantom V5.1 is constructed of a fiberglass shell integrated in a wooden table. Also It consists of three identical flat phantoms (modules) which can be installed and removed separately without emptying the liquid, as well as a wooden support.. It enables the dosimetric evaluation of body mounted usage at the flat phantom region. A cover prevents the evaporation of the liquid.


Reference markings on the phantom allow the complete setup of all predefined phantom positions and measurement grids by manually teaching three points in the robot. (See Figure 3.6)



**Figure 3.6 Modular Flat Phantom**

### Modular Flat Phantom Specification

Construction	The shell corresponds to the specifications of IEEE 1528-2003. It enables the dosimetric evaluation of body mounted usage above 800 MHz at the flat phantom region. A cover prevents evaporation of the liquid
Shell Thickness	2 ± 0.2 mm
Filling Volume	Approx. 10 liters
Dimension	Wooden support - Height: 810 mm; Length: 830 mm; Width: 500 mm Each Module - Height:190 mm; Length: 200 mm; width: 300 mm

FCC ID: A3LGTB6520L	Report Number: FH-154-S1		Page :	8 of 38
 SAMSUNG Electronics CO. LTD	EUT Type:	Dual-Band GSM850/1900 and Dual-Band WCDMA850/1900 Phone with Bluetooth, EDGE RX Only and WLAN	Issue Date :	Jul.22, 2010

### 3.4 Brain Simulating Mixture Characterization

The brain mixtures consist of a viscous gel using hydroxethylcellulose (HEC) gelling agent and saline solution (see Table 3.1). Preservation with a bactericide is added and visual inspection is made to make sure air bubbles are not trapped during the mixing process. The mixture is calibrated to obtain proper dielectric constant (permittivity) and conductivity of the desired tissue.

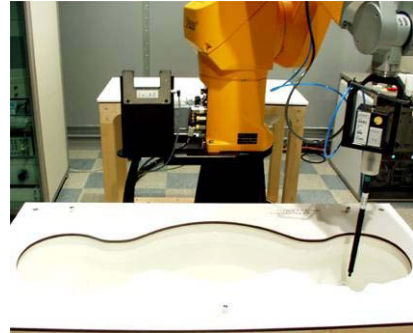


Figure 3.7 Simulated Tissue

Table 3.1 Composition of the Brain Tissue Equivalent Matter

INGREDIENTS	835MHz Brain	835MHz Muscle	1900MHz Brain	1900MHz Muscle	2450MHz Brain	2450MHz Muscle
WATER	40.29%	50.75%	55.24%	70.23%	71.88%	73.2%
SUGAR	57.90%	48.21%	-	-	-	-
SALT	1.38%	0.94%	0.31%	0.29%	0.16%	0.04%
DGBE	-	-	44.45%	29.47%	7.99%	26.7%
Triton X-100	-	-	-	-	19.97%	-
BACTERIACIDE	0.18%	0.10%	-	-	-	-
HEC	0.24%	-	-	-	-	-
Dielectric Constant Target	41.5	55.2	40	53.3	39.2	52.7
Conductivity Target (S/m)	0.9	0.97	1.4	1.52	1.8	1.95

### 3.5 Device Holder for Transmitters


In combination with the Twin SAM Phantom V4.0, the Mounting Device (see Fig. 3.7) enables the rotation of the mounted transmitter in spherical coordinates whereby the rotation points is



Figure 3.8 Device Holder

the ear opening. The devices can be easily, accurately and repeatedly be positioned according to the EN 50360:2001 and FCC specifications. The device holder can be locked at different phantom locations (left head, right head, flat phantom).

\*Note: A simulating human hand is not used due to the complex anatomical and geometrical structure of the hand that may produced infinite number of configuration. To produce worst-case condition (the hand absorbs antenna output power), the hand is omitted during the tests.

FCC ID: A3LGTB6520L	Report Number: FH-154-S1		Page :	9 of 38
 SAMSUNG Electronics CO. LTD	EUT Type:	Dual-Band GSM850/1900 and Dual-Band WCDMA850/1900 Phone with Bluetooth, EDGE RX Only and WLAN	Issue Date :	Jul.22, 2010

### 3.6 Validation Dipole

The reference dipole should have a return loss better than  $-20$  dB (measured in the setup) at the resonant frequency to reduce the uncertainty in the power measurement.

Frequency	835, 1900, 2450 MHz
Return Loss	< -20 dB at specified validation position
Dimensions	D835V2: dipole length: 161 mm; overall height: 330 mm D1900V2: dipole length: 68 mm; overall height: 300 mm D2450V2: dipole length: 51.8 mm; overall height: 300 mm

**Note:**


Usage of SAR dipoles calibrated less than 2 years ago but more than 1 year ago were confirmed in maintaining return loss (< -20dB, within 20% of prior calibration) and impedance (within 5 ohm from prior calibration) requirements per extended calibration in KDB 450824

D835V2 S/N:4d050	Parameters				
	Date of Cal	Return loss (dB)	Deviation (%)	Impedance ( $\Omega$ )	Deviation (%)
	2007.04.10	-30.8	0	52.3	0
	2009.03.16	-26.7	13.3	51.5	1.5

D1900V2 S/N:5d082	Parameters				
	Date of Cal	Return loss (dB)	Deviation (%)	Impedance ( $\Omega$ )	Deviation (%)
	2007.04.11	-23.3	0	52.7	0
	2009.03.17	-25.7	-10.3	52.9	0.38

D2450V2 S/N:708	Parameters				
	Date of Cal	Return loss (dB)	Deviation (%)	Impedance ( $\Omega$ )	Deviation (%)
	2008.07.16	-30.2	0	53.1	0
	2010.05.25	-27.1	10.3	53.5	0.75

- End of page -

FCC ID: A3LGTB6520L	Report Number: FH-154-S1		Page :	10 of 38
 SAMSUNG Electronics CO. LTD	EUT Type:	Dual-Band GSM850/1900 and Dual-Band WCDMA850/1900 Phone with Bluetooth, EDGE RX Only and WLAN	Issue Date :	Jul.22, 2010

### 3.7 Equipment Calibration


**Table 3.2 Test Equipment Calibration**

Type	Calibration Due Date	Serial No.
SPEAG E-Field Probe ES3DV3	Jan.27, 2011	3080
SPEAG DAE4	May.19, 2011	468
SPEAG Validation Dipole D835V2	Mar.16, 2011	4d050
SPEAG Validation Dipole D1900V2	Mar.17, 2011	5d082
SPEAG Validation Dipole D2450V2	May.25, 2012	708
Stäubli Robot RX90BL	Not Required	F01/5N19A1/A/01
SPEAG SAM Twin Phantom V4.0	Not Required	TP-1141
SPEAG SAM Twin Phantom V4.0	Not Required	TP-1143
E4421B Signal Generator	Oct.23, 2010	MY41000654
BBS3Q7ECK Power Amp	Dec.11, 2010	1024
E4419B Power meter	May.14, 2011	MY45101765
E9300B Power sensor	Jun.09, 2011	MY41495872
HP-8753ES Network Analyzer	Apr.23, 2011	US39173712
HP85070C Dielectric Probe Kit	Not Required	US99360087
NRVD Power Meter	Mar.23, 2011	836416/030
NRV-Z55 Power Sensor	Mar.23, 2011	834558/012
NRV-Z55 Power Sensor	Mar.23, 2011	834558/014
DASY4 S/W (ver 4.7)	Not Required	-
Directional Coupler	Mar.26, 2011	20412
Base Station Simulator	Feb.08, 2011	GB43460148
Modular Phantom	Not Required	MP-1001

**NOTE:**

The E-field probe was calibrated by SPEAG, by temperature measurement procedure. Dipole Validation measurement is performed by Samsung Lab. before each test. (see § 7.2) The brain simulating material is calibrated by Samsung using the dielectric probe system and network analyzer to determine the conductivity and permittivity (dielectric constant) of the brain-equivalent material. (see § 7.1)

- End of page -

FCC ID: A3LGTB6520L	Report Number: FH-154-S1		Page :	11 of 38
 SAMSUNG Electronics CO. LTD	EUT Type:	Dual-Band GSM850/1900 and Dual-Band WCDMA850/1900 Phone with Bluetooth, EDGE RX Only and WLAN	Issue Date :	Jul.22, 2010

## 4. SAR MEASUREMENT PROCEDURE

The evaluation was performed using the following procedure.

### STEP 1

The SAR measurement was taken at a selected spatial reference point to monitor power variations during testing. This fixed location point was measured and used as a reference value.

### STEP 2

The SAR distribution at the exposed side of the head was measured at a distance of 3.9mm from the inner surface of the shell. The area covered the entire dimension of the head and the horizontal grid spacing was 20mm x 20mm. Based on the area scan data, the area of the maximum absorption was determined by spline interpolation.

### STEP 3


Around this point, a volume of 32mm x 32mm x 30mm (fine resolution volume scan, zoom scan) was assessed by measuring 5 x 5 x 7 points. On this basis of this data set, the spatial peak SAR value was evaluated with the following procedure:

The data at the surface was extrapolated, since the center of the dipoles is 2.7mm away from the tip of the probe and the distance between the surface and the lowest measuring point is 1.2mm. The extrapolation was based on a least square algorithm. A polynomial of the fourth order was calculated through the points in z-axes. This polynomial was then used to evaluate the points between the surface and the probe tip. The maximum interpolated value was searched with a straight-forward algorithm. Around this maximum the SAR values averaged over the spatial volumes (1g or 10g) were computed using the 3D-Spline interpolation algorithm. The 3D-spline is composed of three one-dimensional splines with the "Not a knot" condition (in x, y, and z directions). The volume was integrated with the trapezoidal algorithm. One thousand points (10 x 10 x 10) were interpolated to calculate the average. All neighboring volumes were evaluated until no neighboring volume with a higher average value was found.

### STEP 4

The SAR value at the same location as in step 1 was again measured.

(If the value changed by more than 5%, the evaluation is repeated.)

FCC ID: A3LGTB6520L	Report Number: FH-154-S1		Page :	12 of 38
 SAMSUNG Electronics CO. LTD	EUT Type:	Dual-Band GSM850/1900 and Dual-Band WCDMA850/1900 Phone with Bluetooth, EDGE RX Only and WLAN	Issue Date :	Jul.22, 2010

## 5. DESCRIPTION OF TEST POSITION

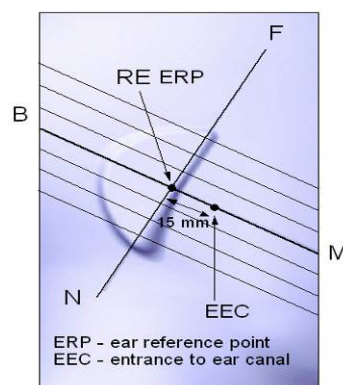
### 5.1 SAM Phantom Shape

Figure 5.1 shows the front, back and side views of SAM. The point “M” is the reference point for the center of mouth, “LE” is the left ear reference point (ERP), and “RE” is the right ERP. The ERPs are 15 mm posterior to the entrance to ear canal (EEC) along the B-M line (Back-Mouth), as shown in Figure 5.2.



**Figure 5.1 Front, back and side view of SAM**


The plane passing through the two ear canals and M is defined as the Reference Plane. The line N-F (Neck-Front) perpendicular to the reference plane and passing through the RE (or LE) is called the Reference Pivoting Line (see Figure 5.3). Line B-M is perpendicular to the N-F line. Both N-F and B-M lines should be marked on the external phantom shell to facilitate handset positioning. Posterior to the N-F line, the thickness of the phantom shell with the shape of an ear is a flat surface 6 mm thick at the ERPs.



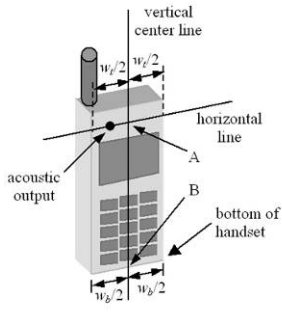
**Figure 5.2 Close up side view**

### 5.2 “cheek” Position

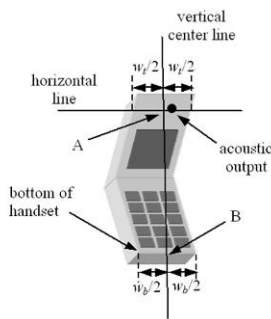
Two imaginary lines on the handset were established: the vertical centerline and the horizontal line. The test device was placed in a normal operating position with the “test device reference point” located along the “vertical centerline” on the front of the device aligned to the “ear reference point” (see Fig. 5.4). The “test device reference point” was then located at the same level as the center of the ear reference point. The test device was positioned so that the “vertical centerline” was bisecting the front surface of the handset at its tip and bottom edges, positioning the “ear reference point” on the outer surface of the both the left and right head

FCC ID: A3LGTB6520L	Report Number: FH-154-S1		Page :	13 of 38
 SAMSUNG Electronics CO. LTD	EUT Type:	Dual-Band GSM850/1900 and Dual-Band WCDMA850/1900 Phone with Bluetooth, EDGE RX Only and WLAN	Issue Date :	Jul.22, 2010

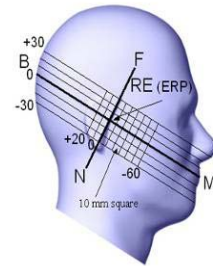
phantoms on the ear reference point



**Figure 5.4 Handset vertical and horizontal reference lines**

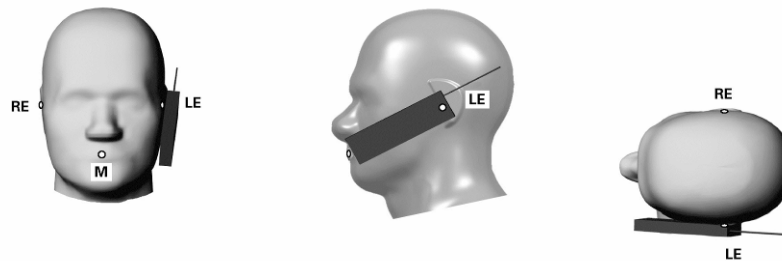


**Figure 5.3 Side view of the phantom showing relevant markings**



**Step 1**

The test device was positioned with the handset close to the surface of the phantom such that point A is on the (virtual) extension of the line passing through points RE and LE on the phantom (see Figure 5.5), such that the plane defined by the vertical center line and the horizontal line of the phone is approximately parallel to the sagittal plane of the phantom



**Figure 5.5 Front, Side and Top View of Cheek/Touch Position**


**Step 2**

The handset was translated towards the phantom along the line passing through RE & LE until the handset touches the ear.

**Step 3**

While maintaining the handset in this plane, the handset was rotated around the LE-RE line until the vertical centerline was in the plane normal to MB-NF including the line MB (reference plane).

**Step 4**

FCC ID: A3LGTB6520L	Report Number: FH-154-S1		Page :	14 of 38
 SAMSUNG Electronics CO. LTD	EUT Type:	Dual-Band GSM850/1900 and Dual-Band WCDMA850/1900 Phone with Bluetooth, EDGE RX Only and WLAN	Issue Date :	Jul.22, 2010

Rotate the handset around the vertical centerline until the phone (horizontal line) was symmetrical with respect to the line NF.

**Step 5**

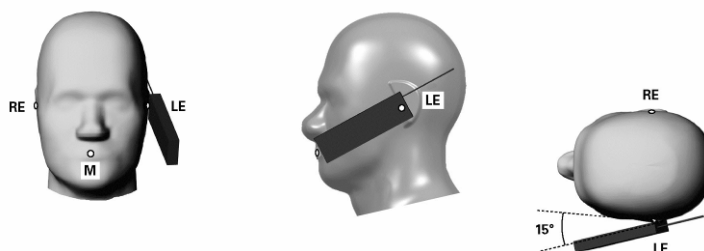
While maintaining the vertical centerline in the reference plane, keeping point A on the line passing through RE and LE, and maintaining the phone contact with the ear, the handset was rotated about the line NF until any point on the handset made contact with a phantom point below the ear (cheek). See Figure 5.2.

**5.3 “tilted” Position**

With the test device aligned in the “cheek” position :

**Step 1**

Repeat steps 1 to 5 of 5.2 to place the device in the “Cheek/Touch Position”



**Figure 5.6 Front, side and Top View of Ear/Tilt 15° Position**

**Step 2**


While maintaining the orientation of the phone, the phone was retracted parallel to the reference plane far enough to enable a rotation of the phone by 15 degree.

**Step 3**

The phone was then rotated around the horizontal line by 15 degree.

**Step 4**

While maintaining the orientation of the phone, the phone was moved parallel to the reference plane until any part of the phone touches the head. (In this position, point A was located on the line RE-LE). The tilted position is obtained when the contact is on the pinna. If the contact was

FCC ID: A3LGTB6520L	Report Number: FH-154-S1		Page :	15 of 38
 SAMSUNG Electronics CO. LTD	EUT Type:	Dual-Band GSM850/1900 and Dual-Band WCDMA850/1900 Phone with Bluetooth, EDGE RX Only and WLAN	Issue Date :	Jul.22, 2010

at any location other than the pinna, the angle of the phone would then be reduced. The tilted position was obtained when any part of the phone was in contact of the ear as well as a second part of the phone was in contact with the head.

#### 5.4 Body Holster/Belt Clip Configurations

Body-worn operating configurations are tested with the belt-clips and holsters attached to the device and positioned against a flat phantom in a normal use configuration (see Figure 5.7). A device with a headset output is tested with a headset connected to the device. Body dielectric parameters are used.




**Figure 5.7 Body Belt Clip and Holster Configurations**

Accessories for Body-worn operation configurations are divided into two categories: those that do not contain metallic components and those that contain metallic components. When multiple accessories that do not contain metallic components are supplied with the device, the device is tested with only the accessory that dictates the closest spacing to the body. Then multiple accessories that contain metallic components are supplied with the device, the device is tested with each accessory that contains unique metallic component. If multiple accessory share an identical metallic component (i.e. the same metallic belt-clip used with different holsters with no other metallic components) only the accessory that dictates the closest spacing to the body is tested.

Body-worn accessories may not always be supplied or available as options for some Devices intended to be authorized for body-worn use. In this case, a test configuration where a separation distance between the back of the device and the flat phantom is used.

Transmitters that are designed to operate in front of a person's face, as in push-to-talk


FCC ID: A3LGTB6520L	Report Number: FH-154-S1		Page :	16 of 38
 SAMSUNG Electronics CO. LTD	EUT Type:	Dual-Band GSM850/1900 and Dual-Band WCDMA850/1900 Phone with Bluetooth, EDGE RX Only and WLAN	Issue Date :	Jul.22, 2010

configurations, are tested for SAR compliance with the front of the device positioned to face the flat phantom. For devices that are carried next to the body such as a shoulder, waist or chest-worn transmitters, SAR compliance is tested with the accessory(ies), including headsets and microphones, attached to the device and positioned against a flat phantom in a normal use configuration.

In all cases SAR measurements are performed to investigate the worst-case positioning. Worst-case positioning is then documented and used to perform Body SAR testing.

In order for users to be aware of the body-worn operating requirements for meeting RF exposure compliance, operating instructions and cautions statements must be included in the user's manual.


- End of page -

FCC ID: A3LGTB6520L	Report Number: FH-154-S1		Page :	17 of 38
 SAMSUNG Electronics CO. LTD	EUT Type:	Dual-Band GSM850/1900 and Dual-Band WCDMA850/1900 Phone with Bluetooth, EDGE RX Only and WLAN	Issue Date :	Jul.22, 2010

## 6. MEASUREMENT UNCERTAINTY


**Table 6.1 Uncertainty Budget at 835MHz (June 2009)**

Error Description	Uncertainty Value (±%)	Probability Distribution	Divisor	$c_i$	Standard uncertainty (±%)	$v_i^2$ or $v_{eff}$
<b>Measurement System</b>						
Probe Calibration	11.00	normal	2.000	1	5.50	∞
Axial Isotropy	4.70	rectangular	1.732	0.7	1.90	∞
Hemispherical Isotropy	9.60	rectangular	1.732	0.7	3.88	∞
Linearity	4.70	rectangular	1.732	1	2.71	∞
System Detection Limits	0.25	rectangular	1.732	1	0.14	∞
Boundary effects	1.00	rectangular	1.732	1	0.58	∞
Readout electronics	0.30	normal	1.000	1	0.30	∞
Response time	0.80	rectangular	1.732	1	0.46	∞
RF ambient conditions	3.00	rectangular	1.732	1	1.73	∞
Integration time	1.73	rectangular	1.732	1	1.00	∞
Mechanical constrains of robot	1.50	rectangular	1.732	1	0.87	∞
Probe positioning	2.90	rectangular	1.732	1	1.67	∞
Extrapolation and integration	1.00	rectangular	1.732	1	0.58	∞
<b>Test Sample Related</b>						
Test Sample positioning	1.12	normal	1.000	1	1.12	14
Device holded uncertainty	3.44	normal	1.000	1	3.44	∞
Power Drift	5.00	rectangular	1.732	1	2.89	∞
<b>Phantom and Setup</b>						
Modular Phantom uncertainty	5.62	normal	1.000	1	5.62	2
Phantom uncertainty	4.00	rectangular	1.732	1	2.31	∞
Liquid conductivity (deviation from target)	5.00	rectangular	1.732	0.64	1.85	∞
Liquid conductivity (measurement error)	0.38	normal	1.000	0.64	0.24	∞
Liquid permittivity (deviation from target)	5.00	rectangular	1.732	0.6	1.73	∞
Liquid permittivity (measurement error)	5.44	normal	1.000	0.6	3.26	∞
<b>Combined Standard Uncertainty</b>		Normal	-	-	<b>11.84</b>	<b>172776</b>
<b>Extended Standard Uncertainty(K=2.00)</b>					<b>23.69</b>	<b>172776</b>

FCC ID: A3LGTB6520L	Report Number: FH-154-S1		Page :	18 of 38
 SAMSUNG Electronics CO. LTD	EUT Type:	Dual-Band GSM850/1900 and Dual-Band WCDMA850/1900 Phone with Bluetooth, EDGE RX Only and WLAN	Issue Date :	Jul.22, 2010


**Table 6.2 Uncertainty Budget at 1900MHz (June 2009)**

Error Description	Uncertainty Value (±%)	Probability Distribution	Divisor	c <sub>i</sub>	Standard uncertainty (±%)	v <sub>i</sub> <sup>2</sup> or v <sub>eff</sub>
<b>Measurement System</b>						
Probe Calibration	11.00	normal	2.000	1	5.50	∞
Axial Isotropy	4.70	rectangular	1.732	0.7	1.90	∞
Hemispherical Isotropy	9.60	rectangular	1.732	0.7	3.88	∞
Linearity	4.70	rectangular	1.732	1	2.71	∞
System Detection Limits	0.25	rectangular	1.732	1	0.14	∞
Boundary effects	1.00	rectangular	1.732	1	0.58	∞
Readout electronics	0.30	normal	1.000	1	0.30	∞
Response time	0.80	rectangular	1.732	1	0.46	∞
RF ambient conditions	3.00	rectangular	1.732	1	1.73	∞
Integration time	0.00	rectangular	1.732	1	0.00	∞
Mechanical constrains of robot	1.50	rectangular	1.732	1	0.87	∞
Probe positioning	2.90	rectangular	1.732	1	1.67	∞
Extrapolation and integration	1.00	rectangular	1.732	1	0.58	∞
<b>Test Sample Related</b>						
Test Sample positioning	1.50	normal	1.000	1	1.50	14
Device holded uncertainty	3.44	normal	1.000	1	3.44	∞
Power Drift	5.00	rectangular	1.732	1	2.89	∞
<b>Phantom and Setup</b>						
Modular Phantom uncertainty	6.02	normal	1.000	1	6.02	2
Phantom uncertainty	4.00	rectangular	1.732	1	2.31	∞
Liquid conductivity (deviation from target)	5.00	rectangular	1.732	0.64	1.85	∞
Liquid conductivity (measurement error)	1.84	normal	1.000	0.64	1.18	∞
Liquid permittivity (deviation from target)	5.00	rectangular	1.732	0.6	1.73	∞
Liquid permittivity (measurement error)	4.54	normal	1.000	0.6	2.73	∞
<b>Combined Standard Uncertainty</b>		Normal	-	-	<b>12.00</b>	<b>60176</b>
<b>Extended Standard Uncertainty(K=2.00)</b>					<b>24.00</b>	<b>60176</b>

FCC ID: A3LGTB6520L	Report Number: FH-154-S1		Page :	19 of 38
 SAMSUNG Electronics CO. LTD	EUT Type:	Dual-Band GSM850/1900 and Dual-Band WCDMA850/1900 Phone with Bluetooth, EDGE RX Only and WLAN	Issue Date :	Jul.22, 2010

**Table 6.3 Uncertainty Budget at 2450MHz (June 2009)**

Error Description	Uncertainty Value (±%)	Probability Distribution	Divisor	C <sub>i</sub>	Standard uncertainty (±%)	v <sub>i</sub> <sup>2</sup> or v <sub>eff</sub>
<b>Measurement System</b>						
Probe Calibration	11.00	normal	2.000	1	5.00	∞
Axial Isotropy	4.70	rectangular	1.732	0.7	1.90	∞
Hemispherical Isotropy	9.60	rectangular	1.732	0.7	3.88	∞
Linearity	4.70	rectangular	1.732	1	2.71	∞
System Detection Limits	0.25	rectangular	1.732	1	0.14	∞
Boundary effects	1.00	rectangular	1.732	1	0.58	∞
Readout electronics	0.30	normal	1.000	1	0.30	∞
Response time	0.80	rectangular	1.732	1	0.46	∞
RF ambient conditions	3.00	rectangular	1.732	1	1.73	∞
Integration time	0.00	rectangular	1.732	1	0.00	∞
Mechanical constrains of robot	1.50	rectangular	1.732	1	0.87	∞
Probe positioning	2.90	rectangular	1.732	1	1.67	∞
Extrapolation and integration	1.00	rectangular	1.732	1	0.58	∞
<b>Test Sample Related</b>						
Test Sample positioning	4.22	normal	1.000	1	4.22	14
Device holded uncertainty	3.44	normal	1.000	1	3.44	∞
Power Drift	5.00	rectangular	1.732	1	2.89	∞
<b>Phantom and Setup</b>						
Modular Phantom uncertainty	2.32	Normal	1.0001	1	2.32	2
Phantom uncertainty	4.00	rectangular	1.732	1	2.31	∞
Liquid conductivity (deviation from target)	5.00	rectangular	1.732	0.64	1.85	∞
Liquid conductivity (measurement error)	2.04	normal	1.000	0.64	1.30	∞
Liquid permittivity (deviation from target)	5.00	rectangular	1.732	0.6	1.73	∞
Liquid permittivity (measurement error)	4.27	normal	1.000	0.6	2.56	∞
<b>Combined Standard Uncertainty</b>		Normal	-	-	<b>11.32</b>	<b>728</b>
<b>Extended Standard Uncertainty(K=2.00)</b>					<b>22.64</b>	<b>728</b>

FCC ID: A3LGTB6520L	Report Number: FH-154-S1		Page :	20 of 38
 SAMSUNG Electronics CO. LTD	EUT Type:	Dual-Band GSM850/1900 and Dual-Band WCDMA850/1900 Phone with Bluetooth, EDGE RX Only and WLAN	Issue Date :	Jul.22, 2010

## 7. SYSTEM VERIFICATION

### 7.1 Tissue Verification

**Table 7.1 MEASURED TISSUE PARAMETERS**

	835MHz Head		835MHz Body		1900MHz Head		1900MHz Body		2450MHz Head		2450MHz Body	
	Target	Measured	Target	Measured	Target	Measured	Target	Measured	Target	Measured	Target	Measured
Date	Jul.13,2010		Jul.13,2010		Jul.14,2010		Jul.14,2010		Jul.16,2010		Jul.16,2010	
Liquid Temperature(°C)	222		221		225		225		225		223	
Dielectric Constant: $\hat{\epsilon}'$	415	408	552	552	40	39	53.3	54.2	392	38.3	527	534
Conductivity:	0.9	0.91	0.97	1	1.4	1.42	1.52	1.56	1.8	1.82	1.95	1.93
Tissue Batch Number	835DF1001N		835B2001E		1900F1001U		1900B1001L		2450MF1001L		2450B1001E	

The measured value must be within  $\pm 5\%$  of the target value.

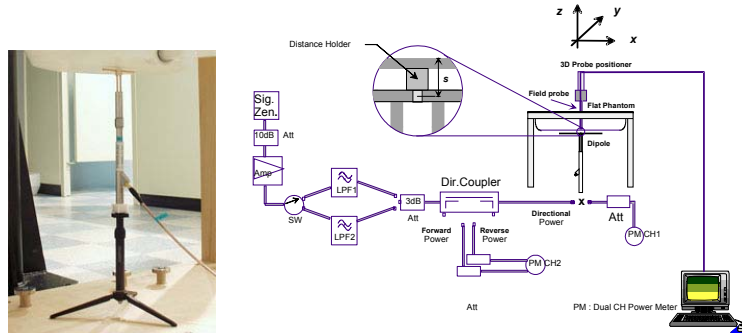
### 7.2 Test System Validation

Prior to assessment, the system is verified to the  $\pm 10\%$  of the specification at 835MHz, 1900MHz and 2450MHz by using the system validation kit(s). (see Appendix E, Graphic Plot Attached)


**Table 7.2 System Validation Results**

System Validation Kit	Tissue	Targeted SAR <sub>1g</sub> (mW/g)	Measured SAR <sub>1g</sub> (mW/g)	Deviation (%)	Date	Liquid Temperature(°C)	Ambient Temperature(°C)
4d050	835MHz Brain	9.49	9.48	-0.11	Jul.13, 2010	22.3	22.7
5d082	1900MHz Brain	39.4	40.8	3.55	Jul.14, 2010	22.4	22.8
708	2450MHz Brain	52.1	50.8	-2.50	Jul.16, 2010	22.6	22.7

\*Validation was measured with input power 250 mW and normalized to 1W.



**Figure 7.1 Dipole Validation Test Setup**

FCC ID: A3LGTB6520L	Report Number: FH-154-S1	Page :	21 of 38
 SAMSUNG Electronics CO. LTD	EUT Type: Dual-Band GSM850/1900 and Dual-Band WCDMA850/1900 Phone with Bluetooth, EDGE RX Only and WLAN	Issue Date :	Jul.22, 2010

## 8. SAR MEASUREMENT RESULTS

### Procedures Used To Establish Test Signal

The handset was placed into simulated call mode using manufacturers test codes. Such test signals offer a consistent means for testing SAR and are recommended for evaluating SAR. When test modes are not available or inappropriate for testing a handset, the actual transmission is activated through a base station simulator or similar equipment. See data pages for actual procedure used in measurement.

### SAR Measurement Conditions for WCDMA

These procedures were followed according to FCC "SAR Measurement Procedures for 3G Devices", May 2006.

### Output Power Verification


Maximum output power is verified on the High, Middle and Low channels according to the general descriptions in section 5.2 of 3GPP TS 34.121, using the appropriate RMC or AMR with TPC (transmit power control) set to all "1s". Results for all applicable physical channel configurations (DPCCH, DPDCHn and spreading codes) should be tabulated in the test report. All configurations that are not supported by the DUT or cannot be measured due to technical or equipment limitations should be clearly identified.

### Head SAR Measurements

SAR for head exposure configurations is measured using the 12.2 kbps RMC with TPC bits configured to all "1s". SAR in AMR configurations is not required when the maximum average output of each RF channel for 12.2 kbps AMR is less than ¼ dB higher than that measured in 12.2kbps RMC. Otherwise, SAR is measured on the maximum output channel in 12.2 AMR with a 3.4kbps SRB (signaling radio bearer) using the exposure configuration that results in the highest SAR for that RF channel in 12.2 RMC.

### Body SAR Measurements

SAR for body exposure configurations is measured using the 12.2 kbps RMC with the TPC bits configured to all "1s". SAR for other spreading codes and multiple DPDCHn, when supported by the DUT, are not required when the maximum average outputs of each RF channel, for each spreading code and DPDCHn configuration, are less than ¼ dB higher than those measured in

FCC ID: A3LGTB6520L	Report Number: FH-154-S1		Page :	22 of 38
 SAMSUNG Electronics CO. LTD	EUT Type:	Dual-Band GSM850/1900 and Dual-Band WCDMA850/1900 Phone with Bluetooth, EDGE RX Only and WLAN	Issue Date :	Jul.22, 2010

12.2 RMC. Otherwise, SAR is measured on the maximum output channel with an applicable RMC configuration for the corresponding spreading code or DPDCHn using the exposure configuration that results in the highest SAR with 12.2 RMC. When more than 2 DPDCHn are supported by the DUT, it may be necessary to configure the additional DPDCHn for the DUT using FTM(Factory Test Mode) with parameters similar to those used in 384 kbps and 768 kbps RMC.

**Table 81. Max. Power Output Table for GT-B6520L**


Operation Band Channel	Channel	12.2 Kbps RMC		12.2 Kbps AMR
		HSDPA Inactive	HSDPA Active	
Cellular WCDMA	4132	22.12	22.14	21.39
	4183	22.22	22.09	21.39
	4233	22.33	22.24	21.41
PCS WCDMA	9262	21.64	21.56	20.88
	9400	22.08	22.01	21.35
	9538	22.31	22.10	21.50

**Device Test Conditions**

The handset is battery operated. Each SAR measurement was taken with a fully charged battery. In order to verify that the device was tested at full power, conducted output power measurements were performed before and after each SAR measurement to confirm the output power. If a conducted power deviation of more than 5% occurred, the test was repeated. And all Tx(1~4Tx) conducted power were also investigated for Body-Worn SAR Measurement

**Table 8.2 GPRS Power Table for GT-B6520L**

Band	Channel	Voice	1Tx	2Tx	3Tx	4Tx
850	128	32.41	32.38	32.42	30.05	27.52
	190	32.33	32.32	32.37	30.03	27.49
	251	32.31	32.25	32.31	29.95	27.42
1900	512	29.72	29.77	29.62	27.26	24.80
	661	29.29	29.26	29.16	26.84	24.40
	810	28.92	28.90	28.79	26.53	24.05


FCC ID: A3LGTB6520L	Report Number: FH-154-S1		Page :	23 of 38
 SAMSUNG Electronics CO. LTD	EUT Type:	Dual-Band GSM850/1900 and Dual-Band WCDMA850/1900 Phone with Bluetooth, EDGE RX Only and WLAN	Issue Date :	Jul.22, 2010

### Simultaneous Transmission

Refer to the FCC OET document, 'SAR Evaluation Considerations for Handsets with Multiple Transmitters and Antennas' (Feb 2008)

**Table 8.3 Output Power Thresholds for Unlicensed Transmitters**

	2.45	5.15 - 5.35	5.47 - 5.85	GHz
P Ref	12	6	5	mW
Device output power should be rounded to the nearest mW to compare with values specified in this table				


FCC ID: A3LGTB6520L	Report Number: FH-154-S1		Page :	24 of 38
 SAMSUNG Electronics CO. LTD	EUT Type:	Dual-Band GSM850/1900 and Dual-Band WCDMA850/1900 Phone with Bluetooth, EDGE RX Only and WLAN	Issue Date :	Jul.22, 2010

**Table 8.4 Summary of SAR Evaluation Requirements for Cell phones with Multiple Transmitters**

	<b>Individual Transmitter</b>	<b>Simultaneous Transmission</b>
<b>Licensed Transmitters</b>	<b><u>Routine evaluation required</u></b>	<p><b>SAR not required:</b></p> <p><b><u>Unlicensed only</u></b></p> <ul style="list-style-type: none"> <li>o when stand-alone 1-g SAR is not required and antenna is &gt; 5 cm from other antennas</li> </ul> <p><b><u>Licensed &amp; Unlicensed</u></b></p> <ul style="list-style-type: none"> <li>o when the sum of the 1-g SAR is &lt;1.6 W/kg for all simultaneous transmitting antennas</li> <li>o when SAR to antenna separation ratio of simultaneous transmitting antenna pair is &lt; 0.3</li> </ul> <p><b>SAR required:</b></p> <p><b><u>Licensed &amp; Unlicensed</u></b></p> <p>antenna pairs with SAR to antenna separation ratio <math>\geq 0.3</math>; test is only required for the configuration that results in the highest SAR in standalone configuration for each wireless mode and exposure condition</p> <p>Note: simultaneous transmission exposure conditions for head and body can be different for different style phones; therefore, different test requirements may apply</p>
<b>Unlicensed Transmitters</b>	<p><b>When there is no simultaneous transmission –</b></p> <ul style="list-style-type: none"> <li>o output &lt; 60/f: SAR not required</li> <li>o output <math>\geq 60/f</math>: stand-alone SAR required</li> </ul> <p><b>When there is simultaneous transmission –</b></p> <p><b><u>Stand-alone SAR not required when</u></b></p> <ul style="list-style-type: none"> <li>o output <math>\leq 2.P_{Ref}</math> and antenna is &gt; 5.0 cm from other antennas</li> <li>o output <math>\leq P_{Ref}</math> and antenna is &gt; 2.5 cm from other antennas, each either output power output <math>\leq P_{Ref}</math> or 1-g SAR &lt; 1.2 W/Kg</li> </ul> <p><b><u>Otherwise stand-alone SAR is required</u></b></p> <p><b>When stand-alone SAR is required</b></p> <ul style="list-style-type: none"> <li>o test SAR on highest output channel for each wireless mode and exposure condition</li> <li>o if SAR for highest output channel is &gt; 50% of SAR limit, evaluate all channels according to normal procedures</li> </ul>	

**Conclusion**

Based on the output power, antenna separation distance, and Body SAR, a stand-alone BT SAR test is not required. The summation of BT SAR and Licensed Transmitter SAR is  $0.787 + 0 = 0.787$ , which is less than 1.6 W/Kg, therefore, a simultaneous SAR evaluation is not required. The summation of WLAN SAR and Licensed Transmitter SAR is  $0.787 + 0.061 = 0.848$ , which is less than 1.6 W/Kg, Therefore, a simultaneous SAR evaluation is not required.


FCC ID: A3LGTB6520L	Report Number: FH-154-S1	Page :	25 of 38
 SAMSUNG Electronics CO. LTD	EUT Type: Dual-Band GSM850/1900 and Dual-Band WCDMA850/1900 Phone with Bluetooth, EDGE RX Only and WLAN	Issue Date :	Jul.22, 2010

## 8.1 GSM850 Head SAR Results

Frequency		Mode	Conducted		Side	Test Position	Antenna Type	Battery	SAR Level (W/kg)
MHz	Ch		Start	End					
836.6	190	GSM850	32.31	32.42	Right	Cheek/Touch	Intenna	Standard	0.318
836.6	190	GSM850	32.43	32.43	Right	Ear/Tilt 15°	Intenna	Standard	0.255
836.6	190	GSM850	32.35	32.39	Left	Cheek/Touch	Intenna	Standard	<b>0.373</b>
836.6	190	GSM850	32.30	32.34	Left	Ear/Tilt 15°	Intenna	Standard	0.263
<b>ANSI / IEEE C95.1 2005 – SAFETY LIMIT Spatial Peak Uncontrolled Exposure / General Population</b>						<b>1.6W/kg (mW/g) averaged over 1 gram</b>			

### NOTES:

1. The test data reported are the worst-case SAR value with the antenna-head position set in a typical configuration. Test procedures used are according to FCC/OET Bulletin 65, Supp.C [July 2001].
2. All modes of operation were investigated, and the worst-case results are reported.
3. Tissue parameters and temperatures are listed on the SAR plot.
4. Liquid tissue depth is  $15.2 \pm 0.2$ cm
5. Battery is fully charged for all readings.
6. Test Configuration  Manu. Test Codes  Base Station Simulator
7. Justification for reduced test configurations: Per FCC/OET Bulletin 65 Supplement C (July, 2001), if the SAR measured at the middle channel for each test configuration (left, right, cheek/touch, tilt/ear, extended and retracted) is least 3.0 dB lower than the SAR limit, testing at the high and low channels is optional for such test configuration(s).


FCC ID: A3LGTB6520L	Report Number: FH-154-S1		Page :	26 of 38
 SAMSUNG Electronics CO. LTD	EUT Type:	Dual-Band GSM850/1900 and Dual-Band WCDMA850/1900 Phone with Bluetooth, EDGE RX Only and WLAN	Issue Date :	Jul.22, 2010

## 8.2 GPRS850 Body SAR Results(Without Holster)

Frequency		Mode	Conducted Power		Test Position	Antenna Type	Battery	Bar	SAR Level (W/kg)
MHz	Ch		Start	End					
824.2	128	GSM850	32.39	32.43	1.5 cm [w/o Holster]	Intenna	Standard	Body	<b>0.787</b>
836.6	190	GSM850	32.41	32.37	1.5 cm [w/o Holster]	Intenna	Standard	Body	0.733
848.8	251	GSM850	32.29	32.33	1.5 cm [w/o Holster]	Intenna	Standard	Body	0.656
836.6	190	GSM850	32.43	32.38	1.5 cm [w/o Holster]	Intenna	Standard	Body	1) 0.669
836.6	190	GSM850	32.38	32.41	1.5 cm [w/o Holster]	Intenna	Standard	Body	2) 0.526
<b>ANSI / IEEE C95.1 2005 – SAFETY LIMIT</b> Spatial Peak <b>Uncontrolled Exposure / General Population</b>						<b>1.6W/kg (mW/g)</b> averaged over 1 gram			

### NOTES:

- The test data reported are the worst-case SAR value with the antenna-head position set in a typical configuration. Test procedures used are according to FCC/OET Bulletin 65, Supp.C [July 2001].
- All modes of operation were investigated, and the worst-case results are reported.
- Tissue parameters and temperatures are listed on the SAR plot.
- Liquid tissue depth is  $15.2 \pm 0.2$ cm
- Battery is fully charged for all readings.
- Test Configuration  With Holster  Without Holster
- Justification for reduced test configurations: This model supports GPRS CLASS "12" (4Tx) So the burst power and timing period is more than 2dB higher in GPRS mode than in GSM850 mode. Hence, the GSM850 mode was not measured.
- 1) GPRS Class11(3Tx)
- 2) GPRS Class12(4Tx)


FCC ID: A3LGTB6520L	Report Number: FH-154-S1		Page :	27 of 38
 SAMSUNG Electronics CO. LTD	EUT Type:	Dual-Band GSM850/1900 and Dual-Band WCDMA850/1900 Phone with Bluetooth, EDGE RX Only and WLAN	Issue Date :	Jul.22, 2010

### 8.3 GSM1900 Head SAR Results

Frequency		Mode	Conducted		Side	Test Position	Antenna Type	Battery	SAR Level (W/kg)
MHz	Ch		Start	End					
1880	661	GSM1900	29.20	29.34	Right	Cheek/Touch	Intenna	Standard	<b>0.368</b>
1880	661	GSM1900	29.38	29.22	Right	Ear/Tilt 15°	Intenna	Standard	0.143
1880	661	GSM1900	29.34	29.31	Left	Cheek/Touch	Intenna	Standard	0.315
1880	661	GSM1900	29.37	29.21	Left	Ear/Tilt 15°	Intenna	Standard	0.143
<b>ANSI / IEEE C95.1 2005 – SAFETY LIMIT Spatial Peak Uncontrolled Exposure / General Population</b>						<b>1.6W/kg (mW/g) averaged over 1 gram</b>			

#### NOTES:

1. The test data reported are the worst-case SAR value with the antenna-head position set in a typical configuration. Test procedures used are according to FCC/OET Bulletin 65, Supp.C [July 2001].
2. All modes of operation were investigated, and the worst-case results are reported.
3. Tissue parameters and temperatures are listed on the SAR plot.
4. Liquid tissue depth is  $15.2 \pm 0.2$ cm
5. Battery is fully charged for all readings.
6. Test Configuration  Manu. Test Codes  Base Station Simulator
7. Justification for reduced test configurations: Per FCC/OET Bulletin 65 Supplement C (July, 2001), if the SAR measured at the middle channel for each test configuration (left, right, cheek/touch, tilt/ear, extended and retracted) is least 3.0 dB lower than the SAR limit, testing at the high and low channels is optional for such test configuration(s).


FCC ID: A3LGTB6520L	Report Number: FH-154-S1		Page :	28 of 38
 SAMSUNG Electronics CO. LTD	EUT Type:	Dual-Band GSM850/1900 and Dual-Band WCDMA850/1900 Phone with Bluetooth, EDGE RX Only and WLAN	Issue Date :	Jul.22, 2010

### 8.4 GPRS1900 Body SAR Results(Without Holster)

Frequency		Mode	Conducted Power		Test Position	Antenna Type	Battery	Bar	SAR Level (W/kg)
MHz	Ch		Start	End					
1850.2	512	GSM1900	29.61	29.68	1.5 cm [w/o Holster]	Intenna	Standard	Body	<b>0.408</b>
1880	661	GSM1900	29.13	29.10	1.5 cm [w/o Holster]	Intenna	Standard	Body	0.371
1909.8	810	GSM1900	28.70	28.74	1.5 cm [w/o Holster]	Intenna	Standard	Body	0.351
1880	661	GSM1900	29.24	29.08	1.5 cm [w/o Holster]	Intenna	Standard	Body	1) 0.333
1880	661	GSM1900	29.23	29.18	1.5 cm [w/o Holster]	Intenna	Standard	Body	2) 0.254
<b>ANSI / IEEE C95.1 2005 – SAFETY LIMIT</b> Spatial Peak <b>Uncontrolled Exposure / General Population</b>						<b>1.6W/kg (mW/g)</b> averaged over 1 gram			

**NOTES:**

1. The test data reported are the worst-case SAR value with the antenna-head position set in a typical configuration. Test procedures used are according to FCC/OET Bulletin 65, Supp.C [July 2001].
2. All modes of operation were investigated, and the worst-case results are reported.
3. Tissue parameters and temperatures are listed on the SAR plot.
4. Liquid tissue depth is 15.2 ± 0.2cm
5. Battery is fully charged for all readings.
6. Test Configuration                     With Holster                     Without Holster
7. Justification for reduced test configurations: This model supports GPRS CLASS "12" (4Tx) So the burst power and timing period is more than 2dB higher in GPRS mode than in GSM1900 mode. Hence, the GSM1900 mode was not measured.
8. 1) GPRS Class11(3Tx)
9. 2) GPRS Class12(4Tx)


FCC ID: A3LGTB6520L	Report Number: FH-154-S1		Page :	29 of 38
 SAMSUNG Electronics CO. LTD	EUT Type:	Dual-Band GSM850/1900 and Dual-Band WCDMA850/1900 Phone with Bluetooth, EDGE RX Only and WLAN	Issue Date :	Jul.22, 2010

## 8.5 WCDMA850 Head SAR Results

Frequency		Mode	Conducted		Side	Test Position	Antenna Type	Battery	SAR Level (W/kg)
MHz	Ch		Start	End					
836.6	4183	WCDMA850	22.19	22.31	Right	Cheek/Touch	Intenna	Standard	0.253
836.6	4183	WCDMA850	22.14	22.23	Right	Ear/Tilt 15°	Intenna	Standard	0.204
836.6	4183	WCDMA850	22.27	22.21	Left	Cheek/Touch	Intenna	Standard	<b>0.296</b>
836.6	4183	WCDMA850	22.35	22.24	Left	Ear/Tilt 15°	Intenna	Standard	0.222
<b>ANSI / IEEE C95.1 2005 – SAFETY LIMIT Spatial Peak Uncontrolled Exposure / General Population</b>						<b>1.6W/kg (mW/g) averaged over 1 gram</b>			

### NOTES:

1. The test data reported are the worst-case SAR value with the antenna-head position set in a typical configuration. Test procedures used are according to FCC/OET Bulletin 65, Supp.C [July 2001].
2. All modes of operation were investigated, and the worst-case results are reported.
3. Tissue parameters and temperatures are listed on the SAR plot.
4. Liquid tissue depth is  $15.2 \pm 0.2$ cm
5. Battery is fully charged for all readings.
6. Test Configuration  Manu. Test Codes  Base Station Simulator
7. Justification for reduced test configurations: Per FCC/OET Bulletin 65 Supplement C (July, 2001), if the SAR measured at the middle channel for each test configuration (left, right, cheek/touch, tilt/ear, extended and retracted) is least 3.0 dB lower than the SAR limit, testing at the high and low channels is optional for such test configuration(s).


FCC ID: A3LGTB6520L	Report Number: FH-154-S1		Page :	30 of 38
 SAMSUNG Electronics CO. LTD	EUT Type:	Dual-Band GSM850/1900 and Dual-Band WCDMA850/1900 Phone with Bluetooth, EDGE RX Only and WLAN	Issue Date :	Jul.22, 2010

## 8.6 WCDMA850 Body SAR Results(Without Holster)

Frequency		Mode	Conducted Power		Test Position	Antenna Type	Battery	Bar	SAR Level (W/kg)
MHz	Ch		Start	End					
826.4	4132	WCDMA850	22.21	22.26	1.5 cm [w/o Holster]	Intenna	Standard	Body	0.185
836.6	4183	WCDMA850	22.37	22.28	1.5 cm [w/o Holster]	Intenna	Standard	Body	<b>0.334</b>
846.6	4233	WCDMA850	22.12	22.28	1.5 cm [w/o Holster]	Intenna	Standard	Body	0.286
<b>ANSI / IEEE C95.1 2005 – SAFETY LIMIT</b> Spatial Peak <b>Uncontrolled Exposure / General Population</b>						<b>1.6W/kg (mW/g)</b> averaged over 1 gram			

### NOTES:

1. The test data reported are the worst-case SAR value with the antenna-head position set in a typical configuration. Test procedures used are according to FCC/OET Bulletin 65, Supp.C [July 2001].
2. All modes of operation were investigated, and the worst-case results are reported.
3. Tissue parameters and temperatures are listed on the SAR plot.
4. Liquid tissue depth is  $15.2 \pm 0.2$ cm
5. Battery is fully charged for all readings.
6. Test Configuration  With Holster  Without Holster


FCC ID: A3LGTB6520L	Report Number: FH-154-S1		Page :	31 of 38
 SAMSUNG Electronics CO. LTD	EUT Type:	Dual-Band GSM850/1900 and Dual-Band WCDMA850/1900 Phone with Bluetooth, EDGE RX Only and WLAN	Issue Date :	Jul.22, 2010

## 8.7 WCDMA1900 Head SAR Results

Frequency		Mode	Conducted		Side	Test Position	Antenna Type	Battery	SAR Level (W/kg)
MHz	Ch		Start	End					
1852.4	9262	WCDMA1900	21.55	21.69	Right	Cheek/Touch	Intenna	Standard	<b>0.945</b>
1880	9400	WCDMA1900	22.05	22.17	Right	Cheek/Touch	Intenna	Standard	0.899
1907.6	9538	WCDMA1900	22.40	22.32	Right	Cheek/Touch	Intenna	Standard	0.858
1880	9400	WCDMA1900	22.09	21.96	Right	Ear/Tilt 15°	Intenna	Standard	0.337
1880	9400	WCDMA1900	22.04	21.91	Left	Cheek/Touch	Intenna	Standard	0.702
1880	9400	WCDMA1900	22.05	21.08	Left	Ear/Tilt 15°	Intenna	Standard	0.322
<b>ANSI / IEEE C95.1 2005 – SAFETY LIMIT Spatial Peak Uncontrolled Exposure / General Population</b>						<b>1.6W/kg (mW/g) averaged over 1 gram</b>			

### NOTES:

1. The test data reported are the worst-case SAR value with the antenna-head position set in a typical configuration. Test procedures used are according to FCC/OET Bulletin 65, Supp.C [July 2001].
2. All modes of operation were investigated, and the worst-case results are reported.
3. Tissue parameters and temperatures are listed on the SAR plot.
4. Liquid tissue depth is  $15.2 \pm 0.2$ cm
5. Battery is fully charged for all readings.
6. Test Configuration  Manu. Test Codes  Base Station Simulator
7. Justification for reduced test configurations: Per FCC/OET Bulletin 65 Supplement C (July, 2001), if the SAR measured at the middle channel for each test configuration (left, right, cheek/touch, tilt/ear, extended and retracted) is least 3.0 dB lower than the SAR limit, testing at the high and low channels is optional for such test configuration(s).


FCC ID: A3LGTB6520L	Report Number: FH-154-S1		Page :	32 of 38
 SAMSUNG Electronics CO. LTD	EUT Type:	Dual-Band GSM850/1900 and Dual-Band WCDMA850/1900 Phone with Bluetooth, EDGE RX Only and WLAN	Issue Date :	Jul.22, 2010

## 8.8 WCDMA1900 Body SAR Results(Without Holster)

Frequency		Mode	Conducted		Test Position	Antenna Type	Battery	Bar	SAR Level (W/kg)
MHz	Ch		Start	End					
1852.4	9262	WCDMA1900	22.09	22.01	1.5 cm [w/o Holster]	Intenna	Standard	Body	0.423
1880	9400	WCDMA1900	22.05	22.18	1.5 cm [w/o Holster]	Intenna	Standard	Body	0.431
1907.6	9538	WCDMA1900	22.07	22.14	1.5 cm [w/o Holster]	Intenna	Standard	Body	<b>0.448</b>
<b>ANSI / IEEE C95.1 2005 – SAFETY LIMIT Spatial Peak Uncontrolled Exposure / General Population</b>						<b>1.6W/kg (mW/g) averaged over 1 gram</b>			

### NOTES:

1. The test data reported are the worst-case SAR value with the antenna-head position set in a typical configuration. Test procedures used are according to FCC/OET Bulletin 65, Supp.C [July 2001].
2. All modes of operation were investigated, and the worst-case results are reported.
3. Tissue parameters and temperatures are listed on the SAR plot.
4. Liquid tissue depth is  $15.2 \pm 0.2$ cm
5. Battery is fully charged for all readings.
6. Test Configuration  With Holster  Without Holster


FCC ID: A3LGTB6520L	Report Number: FH-154-S1		Page :	33 of 38
 SAMSUNG Electronics CO. LTD	EUT Type:	Dual-Band GSM850/1900 and Dual-Band WCDMA850/1900 Phone with Bluetooth, EDGE RX Only and WLAN	Issue Date :	Jul.22, 2010

## 8.9 WLAN Head SAR Results

Frequency		Mode	Conducted		Side	Test Position	Antenna Type	Battery	SAR Level (W/kg)
MHz	Ch		Start	End					
2437	6	WLAN	16.11	16.25	Right	Cheek/Touch	Intenna	Standard	0.088
2437	6	WLAN	16.16	16.09	Right	Ear/Tilt 15°	Intenna	Standard	0.047
2437	6	WLAN	16.22	16.06	Left	Cheek/Touch	Intenna	Standard	<b>0.155</b>
2437	6	WLAN	16.13	16.24	Left	Ear/Tilt 15°	Intenna	Standard	0.023
<b>ANSI / IEEE C95.1 2005 – SAFETY LIMIT Spatial Peak Uncontrolled Exposure / General Population</b>						<b>1.6W/kg (mW/g) averaged over 1 gram</b>			

### NOTES:

1. The test data reported are the worst-case SAR value with the antenna-head position set in a typical configuration. Test procedures used are according to FCC/OET Bulletin 65, Supp.C [July 2001].
2. All modes of operation were investigated, and the worst-case results are reported.
3. Tissue parameters and temperatures are listed on the SAR plot.
4. Liquid tissue depth is  $15.2 \pm 0.2$ cm
5. Battery is fully charged for all readings.
6. Test Configuration  Manu. Test Codes  Base Station Simulator
7. Justification for reduced test configurations: Per FCC/OET Bulletin 65 Supplement C (July, 2001), if the SAR measured at the middle channel for each test configuration (left, right, cheek/touch, tilt/ear, extended and retracted) is least 3.0 dB lower than the SAR limit, testing at the high and low channels is optional for such test configuration(s).
8. SAR is not required for 802.11.g channels when the maximum average out power is less than 1/4 dB higher than that measured on the corresponding 802.11.b channels.
9. Data rate for WLAN(802.11.b) testing was 1Mbps.


FCC ID: A3LGTB6520L	Report Number: FH-154-S1		Page :	34 of 38
 SAMSUNG Electronics CO. LTD	EUT Type:	Dual-Band GSM850/1900 and Dual-Band WCDMA850/1900 Phone with Bluetooth, EDGE RX Only and WLAN	Issue Date :	Jul.22, 2010

### 8.10 WLAN Body SAR Results(Without Holster)

Frequency		Mode	Conducted Power		Test Position	Antenna Type	Battery	Bar	SAR Level (W/kg)
MHz	Ch		Start	End					
2412	1	WLAN	15.31	15.43	1.5 cm [w/o Holster]	Intenna	Standard	Body	<b>0.061</b>
2437	6	WLAN	16.22	16.09	1.5 cm [w/o Holster]	Intenna	Standard	Body	0.018
2462	11	WLAN	15.99	15.85	1.5 cm [w/o Holster]	Intenna	Standard	Body	0.056
<b>ANSI / IEEE C95.1 2005 – SAFETY LIMIT</b> Spatial Peak Uncontrolled Exposure / General Population						<b>1.6W/kg (mW/g)</b> averaged over 1 gram			

**NOTES:**

1. The test data reported are the worst-case SAR value with the antenna-head position set in a typical configuration. Test procedures used are according to FCC/OET Bulletin 65, Supp.C [July 2001].
2. All modes of operation were investigated, and the worst-case results are reported.
3. Tissue parameters and temperatures are listed on the SAR plot.
4. Liquid tissue depth is 15.2 ± 0.2cm
5. Battery is fully charged for all readings.
6. Test Configuration       With Holster       Without Holster
7. SAR is not required for 802.11.g channels when the maximum average out power is less than 1/4 dB higher than that measured on the corresponding 802.11.b channels.
8. Data rate for WLAN(802.11.b) testing was 1Mbps.

FCC ID: A3LGTB6520L	Report Number: FH-154-S1		Page :	35 of 38
 SAMSUNG Electronics CO. LTD	EUT Type:	Dual-Band GSM850/1900 and Dual-Band WCDMA850/1900 Phone with Bluetooth, EDGE RX Only and WLAN	Issue Date :	Jul.22, 2010

## 9. CONCLUSION

The SAR measurement indicates that the EUT complies with the RF radiation exposure limits of the FCC. These measurements are taken to simulate the RF effects exposure under worst-case conditions. Precise laboratory measures were taken to assure repeatability of the tests. The test results and statements relate only to the item(s) tested.

Please note that the absorption and distribution of electromagnetic energy in the body are very complex phenomena that depend on the mass, shape, and size of the body, the orientation of the body with respect to the field vectors, and the electrical properties of both the body and the environment. Other variables that may play a substantial role in possible biological effects are those that characterize the environment (e.g. ambient temperature, air velocity, relative humidity, and body insulation) and those that characterize the individual (e.g. age, gender, activity level, debilitation, or disease). Because innumerable factors may interact to determine the specific biological outcome of an exposure to electromagnetic fields, any protection guide shall consider maximal amplification of biological effects as a result of field-body interactions, environmental conditions, and physiological variables.

The highest reported SAR values are as follows:


GSM850: Head: 0.373W/Kg : Body-worn: 0.787W/Kg

GSM1900: Head: 0.368W/Kg : Body-worn: 0.408W/Kg

WCDMA850: Head: 0.296W/Kg : Body-worn: 0.334W/Kg


WCDMA1900: Head: 0.945W/Kg : Body-worn: 0.448W/Kg

WLAN: Head: 0.155 W/Kg : Body-worn: 0.061W/Kg

FCC ID: A3LGTB6520L	Report Number: FH-154-S1		Page :	36 of 38
 SAMSUNG Electronics CO. LTD	EUT Type:	Dual-Band GSM850/1900 and Dual-Band WCDMA850/1900 Phone with Bluetooth, EDGE RX Only and WLAN	Issue Date :	Jul.22, 2010

## 10. REFERENCES

- [1] IEEE Standards Coordinating Committee 34 – IEEE Std. 1528-2003 (Draft 6.1 – July 2001), *IEE Recommended Practice for Determining the Peak Spatial-Average Specific Absorption Rate (SAR) in the Human Head from Wireless Communications Devices: Measurement Techniques.*
- [2] Federal Communications Commission, OET Bulletin 65 (Edition 97-01), Supplement C (Edition 01-01), *Evaluating Compliance with FCC Guidelines for Human Exposure to Radiofrequency Electromagnetic Fields*, July 2001.
- [3] ANSI/IEEE C95.3 – 1991, *IEEE Recommended Practice for the Measurement of Potentially Hazardous Electromagnetic Fields – RF and Microwave*, New York: IEEE, 1992.
- [4] Federal Communications Commission, OET Bulletin 65, *Evaluating Compliance with FCC Guidelines for Human Exposure to Radiofrequency Electromagnetic Fields.* Supplement C, Dec. 1997.
- [5] ANSI/IEEE C95.1 – 1991, *American National Standard Safety levels with respect to human exposure to radio frequency electromagnetic fields, 300kHz to 100GHz*, New York: : IEEE, Aug. 1992.
- [6] Federal Communications Commission, ET Docket 93-62, *Guidelines for Evaluating the Environmental Effects of Radiofrequency Radiation*, Aug. 1996.
- [7] NCRP, National Council on Radiation Protection and Measurements, *Biological Effects and Exposure Criteria for RadioFrequency Electromagnetic Fields*, NCRP Report No. 86, 1986. Reprinted Feb. 1995.
- [8] T. Schmid, O. Egger, N. Kuster, *Automated E-field scanning system for dosimetric assessments*, IEEE Transaction on Microwave Theory and Techniques, vol. 44, Jan. 1996, pp. 105-113.
- [9] K. Pokovic, T.Schmid, N. Kuster, *Robust setup for precise calibration of E-field probes in tissue simulating liquids at mobile communications frequencies*, ICECOM97, Oct. 1997, pp. 120-124.
- [10] G.Hartsgrove, A. raszewski, A. Surowiec, *Simulated Biological Materials for Electromagnetic Radiation Absorption Studies*, University of Ottawa, Bioelectromagnetics, Canada: 1987, pp. 29-36
- [11] Q. Balzano, O. Garay, T. Manning Jr., *Electromagnetic Energy Exposure of Simulated Users of Portable Cellular Telephones*, IEEE Transactions on Vehicular Technology, vol. 44, no.3, Aug. 1995.
- [12] W.H. Press, S.A. Teukolsky, W.T. Vetterling, and B.P. Flannery, *Numerical Recipes in C*, The Art of Scientific Computing, Second edition, Cambridge University Press, 1992.
- [13] K. Pokovic, T.Schmid, N. Kuster, *E-field Probe with improved isotropy in brain simulating liquids*, Proceedings of the ELMAR, Zadar, June 23-25, 1996, pp. 172-175.
- [14] Schmid & Partner Engineering AG, Application Note: Data Storage and Evaluation, June 1998, p2.
- [15] V. Hombach, K.Meier, M. Burkhardt, E. Kuhn, N. Kuster, *The Dependence of EM Energy Absorption upon Human Head Modeling at 900MHz*, IEEE Transaction on Microwave Theory and Techniques, vol 44 no. 10, Oct. 1996, pp. 1865-1873.
- [16] N. Kuster and Q. Balzano, *Energy absorption mechanism by biological bodies in the near field of dipole antennas above 300MHz*, IEEE Transaction on Vehicular Technology, vol. 41, no.1, Feb.1992, pp. 17-23.
- [17] N. Kuster, R. Kastle, T. Schmid, *Dosimetric evaluation of mobile communications equipment with known precision*, IEEE Transaction on Communications, vol. E80-B, no. 5, May 1997, pp.645-652.
- [18] ANSI/IEEE C95.1-2005, *American National Standard safety levels with respect to human exposure to radio frequency electromagnetic fields, 300kHz to 100GHz*, New York: IEEE, April 2006.

FCC ID: A3LGTB6520L	Report Number: FH-154-S1		Page :	37 of 38
 SAMSUNG Electronics CO. LTD	EUT Type:	Dual-Band GSM850/1900 and Dual-Band WCDMA850/1900 Phone with Bluetooth, EDGE RX Only and WLAN	Issue Date :	Jul.22, 2010

[19] CENELEC CLC/SC111B, European Prestandard (prENV 50166-2), Human Exposure to Electromagnetic Fields High-frequency: 10kHz-300GHz, Jan. 1995.

[20] Prof. Dr. Niels Kuster, ETH, Eidgenössische Technische Hochschule Zürich, Dosimetric Evaluation of the Cellular Phone.


[21] FCC SAR Measurement Procedures for 3G Devices, June 2006

[22] SAR Measurement procedures for IEEE 802.11a/b/g rev 1.1, Oct 2006

[23] IEC 62209-1, Human exposure to radio frequency fields from hand-held and body-mounted wireless communication devices - Human models, instrumentation, and procedures - Part 1: Procedure to determine the specific absorption rate (SAR) for hand-held devices used in close proximity to the ear (frequency range of 300 MHz to 3 GHz), Feb. 2005.

[24] FCC Public Notice DA-02-1438. Office of Engineering and Technology Announces a Transition Period for the Phantom Requirements of Supplement C to OET Bulletin 65, June 19, 2002.

[25] FCC SAR Evaluation Considerations for Handsets with Multiple Transmitters and Antennas. Feb 2008

FCC ID: A3LGTB6520L	Report Number: FH-154-S1		Page :	38 of 38
 SAMSUNG Electronics CO. LTD	EUT Type:	Dual-Band GSM850/1900 and Dual-Band WCDMA850/1900 Phone with Bluetooth, EDGE RX Only and WLAN	Issue Date :	Jul.22, 2010

## APPENDIX A

### SAR Definition

Specific Absorption Rate (SAR) is defined as the time derivative (rate) of the incremental energy (dU) absorbed by (dissipated in ) an incremental mass (dm) contained in a volume element (dV) of a given density (p). It is also defined as the rate of RF energy absorption per unit mass at a point in an absorbing body (see Fig. A.1) .

$$SAR = \frac{d}{dt} \left( \frac{dU}{dm} \right) = \frac{d}{dt} \left( \frac{dU}{p dv} \right)$$

Figure A.1 SAR Mathematical Equation

**SAR is expressed in units of Watts per Kilogram (W/kg).**

$$SAR = \sigma E^2 / \rho$$

**Where :**

- $\sigma$  = conductivity of the tissue-simulant material (S/m)
- $\rho$  = mass density of the tissue-simulant material (kg/m<sup>3</sup>)
- $E$  = Total RMS electric field strength (V/m)

**Note:** The primary factors that control rate or energy absorption were found to be the wavelength of the incident field in relations to the dimensions and geometry of the irradiated organism, the orientation of the organism in relation to the polarity of field vectors, the presence of reflecting surfaces, and whether conductive contact is made by the organism with a ground plane.

## APPENDIX B

### Probe Calibration Process

#### Dosimetric Assessment Procedure

Each probe is calibrated according to a dosimetric assessment procedure described in **K. Pokovic, T.Schmid, N. Kuster, *Robust setup for precise calibration of E-field probes in tissue simulating liquids at mobile communications frequencies*, ICECOM97, Oct. 1997, pp. 120-124** with an accuracy better than +/-10%. The spherical isotropy was evaluated with the procedure described in **K. Pokovic, T.Schmid, N. Kuster, *E-field Probe with improved isotropy in brain simulating liquids*, Proceedings of the ELMAR, Zadar, June 23-25, 1996, pp. 172-175** and found to be better than +/-0.25dB. The sensitivity parameters (NormX, NormY, NormZ), the diode compression parameter (DCP) and the conversion factor (ConvF) of the probe is tested.

#### Free Space Assessment

The free space E-field from amplified probe outputs is determined in a test chamber. This is performed in a TEM cell for frequencies below 1 GHz (see Fig. B.1), and in a waveguide above 1 GHz for free space. For the free space calibration, the probe is placed in the volumetric center of the cavity and at the proper orientation with the field. The probe is then rotated 360 degrees.

#### Temperature Assessment

E-field temperature correlation calibration is performed in a flat phantom flat phantom filled with the appropriate simulated brain tissue. The measured free space E-field in the medium correlates to temperature rise in a dielectric medium. For temperature correlation calibration a RF transparent thermistor-based temperature probe is used in conjunction with the E-field probe (see Fig. B.2).

$$SAR = C \frac{\Delta T}{\Delta t}$$

$$SAR = \frac{|E|^2 \cdot \sigma}{\rho}$$

where:

$\Delta t$  = exposure time (30 seconds)

$C$  = heat capacity of tissue (brain or muscle).

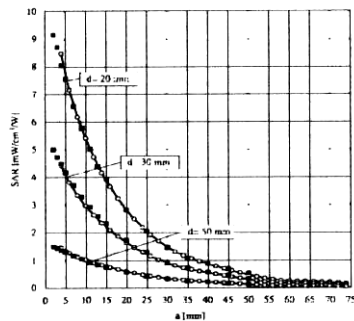
$\Delta T$  = temperature increase due to RF exposure.

SAR is proportional to  $\Delta T / \Delta t$ , the initial rate of tissue heating, before thermal diffusion takes place. Now it's possible to quantify the electric field in the simulated tissue by equating the thermally derived SAR to the E-field;

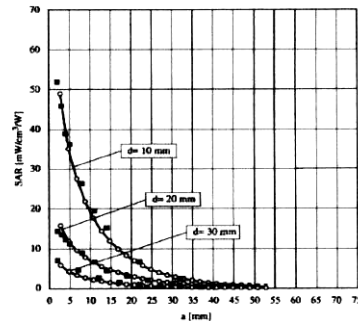
where:

$\sigma$  = simulated tissue conductivity

$\rho$  = Tissue density (1.25 g/cm<sup>3</sup> for brain tissue)



**Figure B.1. E-Field and Temperature measurements at 900MHz**



**Figure B.2. E-Field and temperature measurements at 1.9GHz**

## APPENDIX C

### ANSI/IEEE C95.1 – 2005 RF EXPOSURE LIMITS

#### Uncontrolled Environment

UNCONTROLLED ENVIRONMENTS are defined as locations where there is the exposure of individuals who have no knowledge or control of their exposure. The general population/uncontrolled exposure limits are applicable to situations in which the general public may be exposed or in which persons who are exposed as a consequence of their employment may not be made fully aware of the potential for exposure or cannot exercise control over their exposure. Members of the general public would come under this category when exposure is not employment-related; for example, in the case of a wireless transmitter that exposes persons in its vicinity.

#### Controlled Environment

CONTROLLED ENVIRONMENTS are defined as locations where there is the exposure that may be incurred by persons who are aware of the potential for exposure, (i.e. as a result of employment or occupation). In general, occupational/controlled exposure limits are applicable to situations in which persons are exposed as a consequence of their employment, who have been made fully aware of the potential for exposure and can exercise control over their exposure. This exposure category is also applicable when the exposure is of a transient nature due to incidental passage through a location where the exposure levels may be higher than the general population/uncontrolled limits, but the exposed person is fully aware of the potential for exposure and can exercise control over his or her exposure by leaving the area or by some other appropriate means.

**Table C.1 Safety Limits for Partial Body Exposure**

	UNCONTROLLED ENVIRONMENT General Population (W/kg) or (mW/g)	CONTROLLED ENVIRONMENT General Population (W/kg) or (mW/g)
SPATIAL PEAK SAR <sup>1</sup> Brain	1.60	8.00
SPATIAL PEAK SAR <sup>2</sup> Whole Body	0.08	0.40
SPATIAL PEAK SAR <sup>3</sup> Hands, Feet, Ankles, Wrists	4.00	20.00

<sup>1</sup> The Spatial Peak value of the SAR averaged over any 1 gram of tissue (defined as tissue volume in the shape of a cube) and over the appropriate averaging time.

<sup>2</sup> The Spatial Average value of the SAR averaged over the whole body.

<sup>3</sup> The Spatial Peak value of the SAR averaged over any 10 grams of tissue (defined as a tissue volume in the shape of a cube) and over the appropriate averaging time.

## **APPENDIX D**

### **The Validation Measurements**

**DUT: Dipole 835 MHz; Serial: 4d050**

**Program Name: 835MHz Dipole Validation 2010.07.13**

**Procedure Name: 835MHz @ 250mW**

**Meas. Ambient Temp(celsius)-22.7,Tissue Temp(celsius)-22.3;Test Date-13/Jul/2010**

Communication System: CW; Frequency: 835 MHz;Duty Cycle: 1:1

Medium parameters used:  $f = 835 \text{ MHz}$ ;  $\sigma = 0.91 \text{ mho/m}$ ;  $\epsilon_r = 40.8$ ;  $\rho = 1000 \text{ kg/m}^3$

Phantom section: Flat Section

DASY4 Configuration:

- Probe: ES3DV3 - SN3080; ConvF(5.77, 5.77, 5.77); Calibrated: 2010-01-27
- Sensor-Surface: 4mm (Mechanical Surface Detection)
- Electronics: DAE4 Sn468; Calibrated: 2010-05-19
- Phantom: PHANTOM #2; Type: SAM; Serial: TP-1141
- Measurement SW: DASY4, V4.7 Build 80; Postprocessing SW: SEMCAD, V1.8 Build 184

**835MHz @ 250mW/Area Scan (51x51x1):** Measurement grid:  $dx=20\text{mm}$ ,  $dy=20\text{mm}$

Maximum value of SAR (interpolated) = 2.49 mW/g

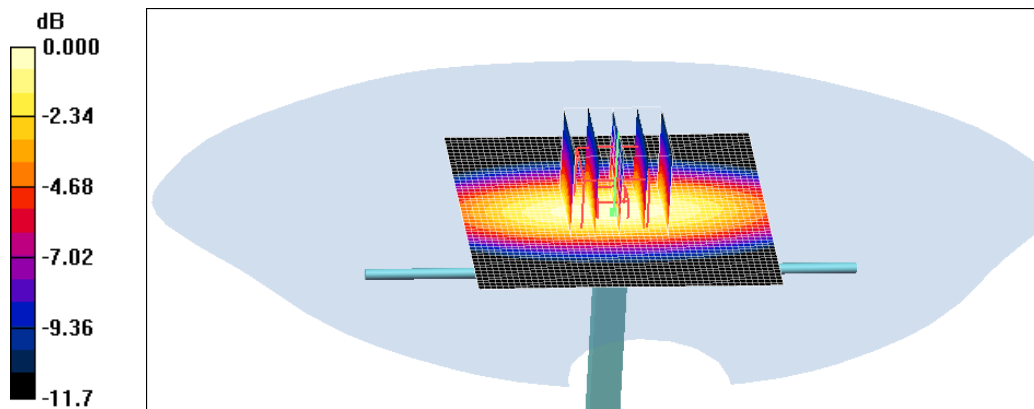
**835MHz @ 250mW/Zoom Scan (5x5x7)/Cube 0:** Measurement grid:  $dx=8\text{mm}$ ,  $dy=8\text{mm}$ ,  $dz=5\text{mm}$

Reference Value = 54.1 V/m; Power Drift = 0.020 dB

Peak SAR (extrapolated) = 3.86 W/kg

**SAR(1 g) = 2.37 mW/g; SAR(10 g) = 1.45 mW/g**

Maximum value of SAR (measured) = 2.61 mW/g



0 dB = 2.61mW/g

**DUT: Dipole 1900 MHz; Serial: 5d082**

**Program Name: 1900MHz Dipole Validation 2010.07.15**

**Procedure Name: 1900MHz @ 250mW**

**Meas. Ambient Temp(celsius)-22.8,Tissue Temp(celsius)-22.4;Test Date-14/Jul/2010**

Communication System: CW; Frequency: 1900 MHz;Duty Cycle: 1:1

Medium parameters used:  $f = 1900$  MHz;  $\sigma = 1.42$  mho/m;  $\epsilon_r = 39$ ;  $\rho = 1000$  kg/m<sup>3</sup>

Phantom section: Flat Section

DASY4 Configuration:

- Probe: ES3DV3 - SN3080; ConvF(4.87, 4.87, 4.87); Calibrated: 2010-01-27
- Sensor-Surface: 4mm (Mechanical Surface Detection)
- Electronics: DAE4 Sn468; Calibrated: 2010-05-19
- Phantom: PHANTOM #1; Type: SAM; Serial: TP-1143
- Measurement SW: DASY4, V4.7 Build 80; Postprocessing SW: SEMCAD, V1.8 Build 184

**1900MHz @ 250mW/Area Scan (51x51x1):** Measurement grid: dx=20mm, dy=20mm

Maximum value of SAR (interpolated) = 15.9 mW/g

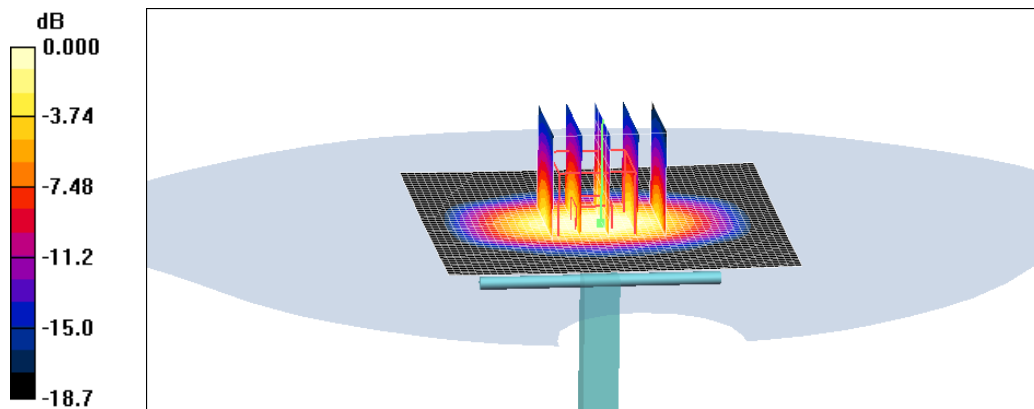
**1900MHz @ 250mW/Zoom Scan (5x5x7)/Cube 0:** Measurement grid: dx=8mm, dy=8mm, dz=5mm

Reference Value = 91.0 V/m; Power Drift = 0.012 dB

Peak SAR (extrapolated) = 19.1 W/kg

**SAR(1 g) = 10.2 mW/g; SAR(10 g) = 5.21 mW/g**

Maximum value of SAR (measured) = 11.4 mW/g



0 dB = 11.4mW/g

**DUT: Dipole 2450 MHz; Serial: 708**

**Program Name: 2450MHz Dipole Validation 2010.07.16**

**Procedure Name: 2450MHz @ 250mW**

**Meas. Ambient Temp(celsius)-22.7;Tissue Temp(celsius)-22.6;Test Date-16/Jul/2010**

Communication System: CW; Frequency: 2450 MHz;Duty Cycle: 1:1

Medium parameters used:  $f = 2450$  MHz;  $\sigma = 1.82$  mho/m;  $\epsilon_r = 38.3$ ;  $\rho = 1000$  kg/m<sup>3</sup>

Phantom section: Flat Section

DASY4 Configuration:

- Probe: ES3DV3 - SN3080; ConvF(4.38, 4.38, 4.38); Calibrated: 2010-01-27
- Sensor-Surface: 4mm (Mechanical Surface Detection)
- Electronics: DAE4 Sn468; Calibrated: 2010-05-19
- Phantom: PHANTOM #1; Type: SAM; Serial: TP-1143
- Measurement SW: DASY4, V4.7 Build 80; Postprocessing SW: SEMCAD, V1.8 Build 184

**2450MHz @ 250mW/Area Scan (51x51x1):** Measurement grid: dx=20mm, dy=20mm

Maximum value of SAR (interpolated) = 20.1 mW/g

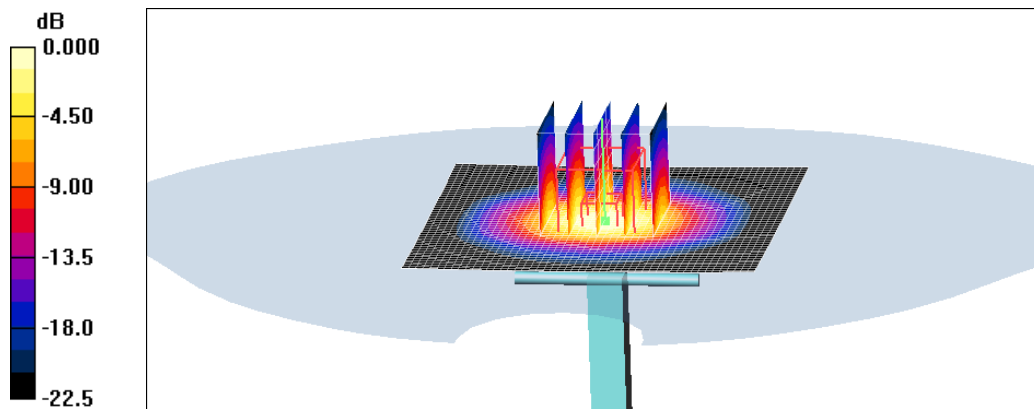
**2450MHz @ 250mW/Zoom Scan (5x5x7)/Cube 0:** Measurement grid: dx=8mm, dy=8mm, dz=5mm

Reference Value = 90.4 V/m; Power Drift = 0.026 dB

Peak SAR (extrapolated) = 26.6 W/kg

**SAR(1 g) = 12.7 mW/g; SAR(10 g) = 5.83 mW/g**

Maximum value of SAR (measured) = 14.4 mW/g



0 dB = 14.4mW/g

## **APPENDIX E**

### **Plots of The SAR Measurements**

**DUT: GT-B6520L; Serial: FH-154-C**

**Program Name: GT-B6520L GSM850 Right (Job No. : FH-154)**

**Procedure Name: Cheek/Touch, Ch.190, Ant.Intenna, Bat.Standard**

**Meas. Ambient Temp(celsius)-22.7,Tissue Temp(celsius)-22.3;Test Date-13/Jul/2010**

Communication System: GSM 850; Frequency: 836.6 MHz;Duty Cycle: 1:8.3

Medium parameters used:  $f = 836.6$  MHz;  $\sigma = 0.91$  mho/m;  $\epsilon_r = 40.8$ ;  $\rho = 1000$  kg/m<sup>3</sup>

Phantom section: Right Section

DASY4 Configuration:

- Probe: ES3DV3 - SN3080; ConvF(5.77, 5.77, 5.77); Calibrated: 2010-01-27
- Sensor-Surface: 4mm (Mechanical Surface Detection)
- Electronics: DAE4 Sn468; Calibrated: 2010-05-19
- Phantom: PHANTOM #2; Type: SAM; Serial: TP-1141
- Measurement SW: DASY4, V4.7 Build 80; Postprocessing SW: SEMCAD, V1.8 Build 184

**Cheek/Touch, Ch.190, Ant.Intenna, Bat.Standard/Area Scan (51x71x1):** Measurement grid: dx=20mm, dy=20mm

Maximum value of SAR (interpolated) = 0.331 mW/g

**Cheek/Touch, Ch.190, Ant.Intenna, Bat.Standard/Zoom Scan (5x5x7)/Cube 0:**

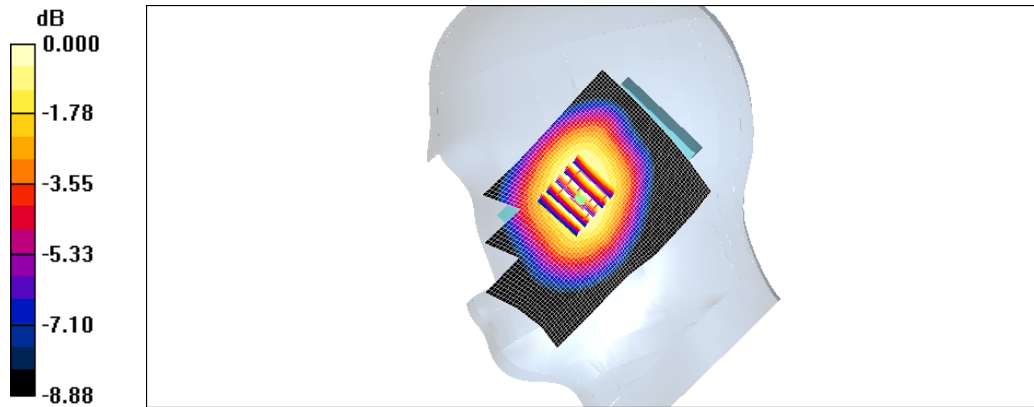
Measurement grid: dx=8mm, dy=8mm, dz=5mm

Reference Value = 19.3 V/m; Power Drift = -0.054 dB

Peak SAR (extrapolated) = 0.408 W/kg

**SAR(1 g) = 0.318 mW/g; SAR(10 g) = 0.239 mW/g**

Maximum value of SAR (measured) = 0.335 mW/g



0 dB = 0.335mW/g

**DUT: GT-B6520L; Serial: FH-154-C**

**Program Name: GT-B6520L GSM850 Right (Job No. : FH-154)**

**Procedure Name: Ear/Tilt, Ch.190, Ant.Intenna, Bat.Standard**

**Meas. Ambient Temp(celsius)-22.7,Tissue Temp(celsius)-22.3;Test Date-13/Jul/2010**

Communication System: GSM 850; Frequency: 836.6 MHz;Duty Cycle: 1:8.3

Medium parameters used:  $f = 836.6$  MHz;  $\sigma = 0.91$  mho/m;  $\epsilon_r = 40.8$ ;  $\rho = 1000$  kg/m<sup>3</sup>

Phantom section: Right Section

DASY4 Configuration:

- Probe: ES3DV3 - SN3080; ConvF(5.77, 5.77, 5.77); Calibrated: 2010-01-27
- Sensor-Surface: 4mm (Mechanical Surface Detection)
- Electronics: DAE4 Sn468; Calibrated: 2010-05-19
- Phantom: PHANTOM #2; Type: SAM; Serial: TP-1141
- Measurement SW: DASY4, V4.7 Build 80; Postprocessing SW: SEMCAD, V1.8 Build 184

**Ear/Tilt, Ch.190, Ant.Intenna, Bat.Standard/Area Scan (51x71x1):** Measurement grid:

$dx=20$ mm,  $dy=20$ mm

Maximum value of SAR (interpolated) = 0.272 mW/g

**Ear/Tilt, Ch.190, Ant.Intenna, Bat.Standard/Zoom Scan (5x5x7)/Cube 0:** Measurement

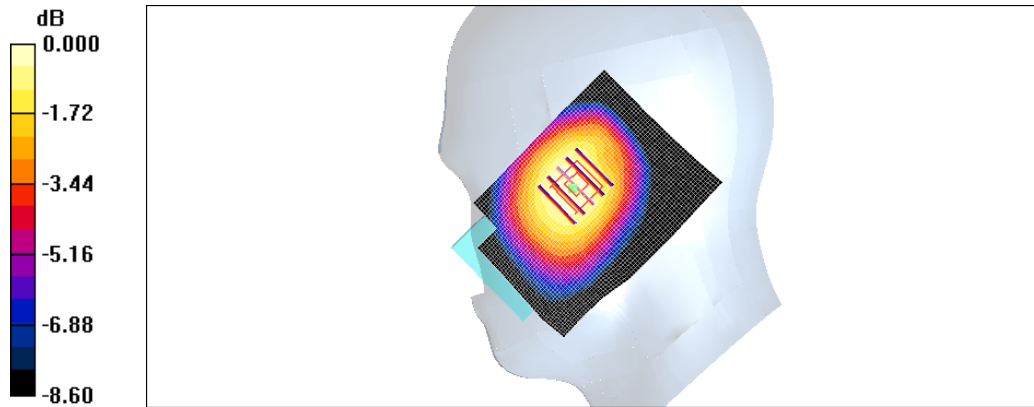
grid:  $dx=8$ mm,  $dy=8$ mm,  $dz=5$ mm

Reference Value = 12.3 V/m; Power Drift = -0.111 dB

Peak SAR (extrapolated) = 0.324 W/kg

**SAR(1 g) = 0.255 mW/g; SAR(10 g) = 0.191 mW/g**

Maximum value of SAR (measured) = 0.268 mW/g



0 dB = 0.268mW/g

**DUT: GT-B6520L; Serial: FH-154-C**

**Program Name: GT-B6520L GSM850 Left (Job No. : FH-154)**

**Procedure Name: Cheek/Touch, Ch.190, Ant.Intenna, Bat.Standard**

**Meas. Ambient Temp(celsius)-22.7,Tissue Temp(celsius)-22.3;Test Date-13/Jul/2010**

Communication System: GSM 850; Frequency: 836.6 MHz;Duty Cycle: 1:8.3

Medium parameters used:  $f = 836.6$  MHz;  $\sigma = 0.91$  mho/m;  $\epsilon_r = 40.8$ ;  $\rho = 1000$  kg/m<sup>3</sup>

Phantom section: Left Section

DASY4 Configuration:

- Probe: ES3DV3 - SN3080; ConvF(5.77, 5.77, 5.77); Calibrated: 2010-01-27
- Sensor-Surface: 4mm (Mechanical Surface Detection)
- Electronics: DAE4 Sn468; Calibrated: 2010-05-19
- Phantom: PHANTOM #2; Type: SAM; Serial: TP-1141
- Measurement SW: DASY4, V4.7 Build 80; Postprocessing SW: SEMCAD, V1.8 Build 184

**Cheek/Touch, Ch.190, Ant.Intenna, Bat.Standard/Area Scan (51x71x1):** Measurement grid: dx=20mm, dy=20mm

Maximum value of SAR (interpolated) = 0.402 mW/g

**Cheek/Touch, Ch.190, Ant.Intenna, Bat.Standard/Zoom Scan (5x5x7)/Cube 0:**

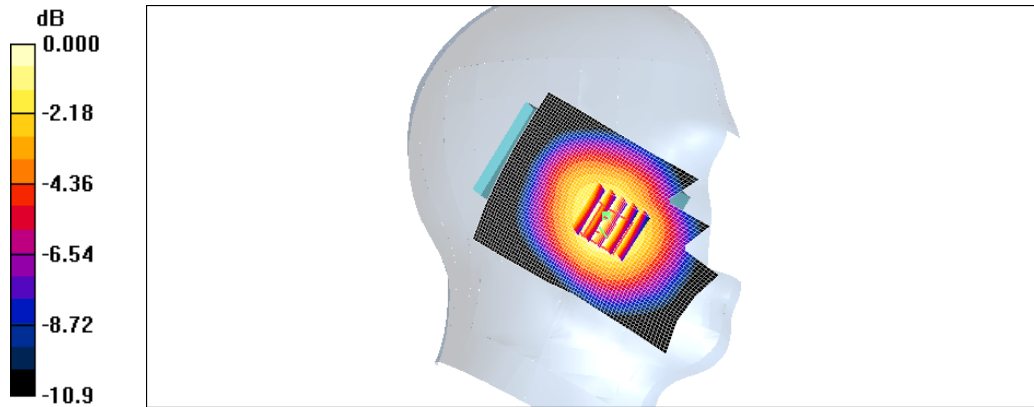
Measurement grid: dx=8mm, dy=8mm, dz=5mm

Reference Value = 20.7 V/m; Power Drift = -0.117 dB

Peak SAR (extrapolated) = 0.487 W/kg

**SAR(1 g) = 0.373 mW/g; SAR(10 g) = 0.271 mW/g**

Maximum value of SAR (measured) = 0.400 mW/g



0 dB = 0.400mW/g

**DUT: GT-B6520L; Serial: FH-154-C**

**Program Name: GT-B6520L GSM850 Left (Job No. : FH-154)**

**Procedure Name: Ear/Tilt, Ch.190, Ant.Intenna, Bat.Standard**

**Meas. Ambient Temp(celsius)-22.7,Tissue Temp(celsius)-22.3;Test Date-13/Jul/2010**

Communication System: GSM 850; Frequency: 836.6 MHz;Duty Cycle: 1:8.3

Medium parameters used:  $f = 836.6$  MHz;  $\sigma = 0.91$  mho/m;  $\epsilon_r = 40.8$ ;  $\rho = 1000$  kg/m<sup>3</sup>

Phantom section: Left Section

DASY4 Configuration:

- Probe: ES3DV3 - SN3080; ConvF(5.77, 5.77, 5.77); Calibrated: 2010-01-27
- Sensor-Surface: 4mm (Mechanical Surface Detection)
- Electronics: DAE4 Sn468; Calibrated: 2010-05-19
- Phantom: PHANTOM #2; Type: SAM; Serial: TP-1141
- Measurement SW: DASY4, V4.7 Build 80; Postprocessing SW: SEMCAD, V1.8 Build 184

**Ear/Tilt, Ch.190, Ant.Intenna, Bat.Standard/Area Scan (51x71x1):** Measurement grid:

dx=20mm, dy=20mm

Maximum value of SAR (interpolated) = 0.282 mW/g

**Ear/Tilt, Ch.190, Ant.Intenna, Bat.Standard/Zoom Scan (5x5x7)/Cube 0:** Measurement

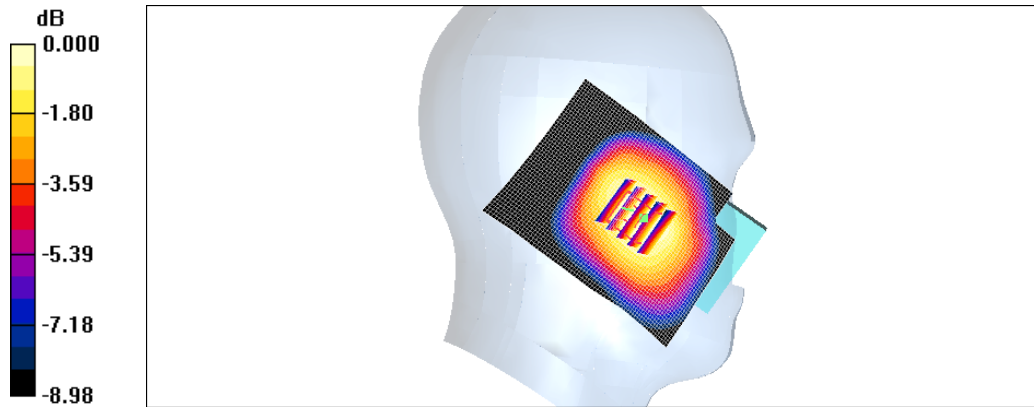
grid: dx=8mm, dy=8mm, dz=5mm

Reference Value = 15.8 V/m; Power Drift = -0.027 dB

Peak SAR (extrapolated) = 0.330 W/kg

**SAR(1 g) = 0.263 mW/g; SAR(10 g) = 0.200 mW/g**

Maximum value of SAR (measured) = 0.276 mW/g



0 dB = 0.276mW/g

**DUT: GT-B6520L; Serial: FH-154-C**

**Program Name: GT-B6520L GSM850 Left (Job No. : FH-154)**

**Procedure Name: Cheek/Touch, Ch.190, Ant.Intenna, Bat.Standard**

**Meas. Ambient Temp(celsius)-22.7,Tissue Temp(celsius)-22.3;Test Date-13/Jul/2010**

Communication System: GSM 850; Frequency: 836.6 MHz;Duty Cycle: 1:8.3

Medium parameters used:  $f = 836.6$  MHz;  $\sigma = 0.91$  mho/m;  $\epsilon_r = 40.8$ ;  $\rho = 1000$  kg/m<sup>3</sup>

Phantom section: Left Section

DASY4 Configuration:

- Probe: ES3DV3 - SN3080; ConvF(5.77, 5.77, 5.77); Calibrated: 2010-01-27
- Sensor-Surface: 4mm (Mechanical Surface Detection)
- Electronics: DAE4 Sn468; Calibrated: 2010-05-19
- Phantom: PHANTOM #2; Type: SAM; Serial: TP-1141
- Measurement SW: DASY4, V4.7 Build 80; Postprocessing SW: SEMCAD, V1.8 Build 184

**Cheek/Touch, Ch.190, Ant.Intenna, Bat.Standard/Area Scan (51x71x1):** Measurement grid: dx=20mm, dy=20mm

Maximum value of SAR (interpolated) = 0.402 mW/g

**Cheek/Touch, Ch.190, Ant.Intenna, Bat.Standard/Zoom Scan (5x5x7)/Cube 0:**

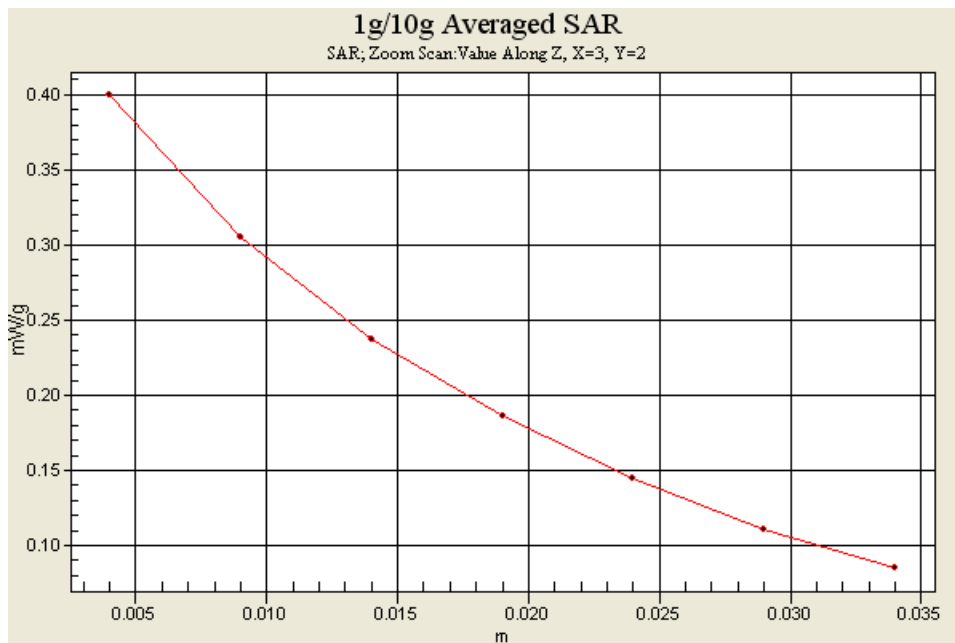
Measurement grid: dx=8mm, dy=8mm, dz=5mm

Reference Value = 20.7 V/m; Power Drift = -0.117 dB

Peak SAR (extrapolated) = 0.487 W/kg

**SAR(1 g) = 0.373 mW/g; SAR(10 g) = 0.271 mW/g**

Maximum value of SAR (measured) = 0.400 mW/g



**DUT: GT-B6520L; Serial: EH-084-B**

**Program Name: GT-B6520L GPRS850 Body (Job No. : FH-154)**

**Procedure Name: Body, Ch. 128, Ant. Intenna, Bat. Standard**

**Meas. Ambient Temp(celsius)-22.7,Tissue Temp(celsius)-22.3;Test Date-13/Jul/2010**

Communication System: GPRS 850; Frequency: 824.2 MHz;Duty Cycle: 1:4.15

Medium parameters used:  $f = 824.2$  MHz;  $\sigma = 1$  mho/m;  $\epsilon_r = 55.2$ ;  $\rho = 1000$  kg/m<sup>3</sup>

Phantom section: Left Section

DASY4 Configuration:

- Probe: ES3DV3 - SN3080; ConvF(5.7, 5.7, 5.7); Calibrated: 2010-01-27

- Sensor-Surface: 4mm (Mechanical Surface Detection)

- Electronics: DAE4 Sn468; Calibrated: 2010-05-19

- Phantom: Triple Flat Phantom 5.1; Type: Triple Flat Phantom 5.1; Serial: 1001

- Measurement SW: DASY4, V4.7 Build 80; Postprocessing SW: SEMCAD, V1.8 Build 184

**Body, Ch. 128, Ant. Intenna, Bat. Standard/Area Scan (51x71x1):** Measurement grid:

dx=20mm, dy=20mm

Maximum value of SAR (interpolated) = 0.852 mW/g

**Body, Ch. 128, Ant. Intenna, Bat. Standard/Zoom Scan (5x5x7)/Cube 0:** Measurement

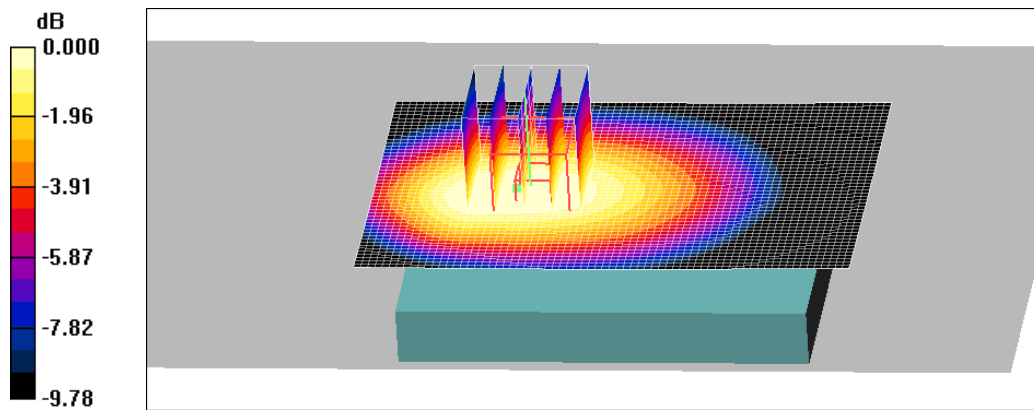
grid: dx=8mm, dy=8mm, dz=5mm

Reference Value = 29.4 V/m; Power Drift = -0.057 dB

Peak SAR (extrapolated) = 1.02 W/kg

**SAR(1 g) = 0.787 mW/g; SAR(10 g) = 0.574 mW/g**

Maximum value of SAR (measured) = 0.827 mW/g



0 dB = 0.827mW/g

**DUT: GT-B6520L; Serial: EH-084-B**

**Program Name: GT-B6520L GPRS850 Body (Job No. : FH-154)**

**Procedure Name: Body, Ch. 128, Ant. Intenna, Bat. Standard**

**Meas. Ambient Temp(celsius)-22.7,Tissue Temp(celsius)-22.3;Test Date-13/Jul/2010**

Communication System: GPRS 850; Frequency: 824.2 MHz;Duty Cycle: 1:4.15

Medium parameters used:  $f = 824.2$  MHz;  $\sigma = 1$  mho/m;  $\epsilon_r = 55.2$ ;  $\rho = 1000$  kg/m<sup>3</sup>

Phantom section: Left Section

DASY4 Configuration:

- Probe: ES3DV3 - SN3080; ConvF(5.7, 5.7, 5.7); Calibrated: 2010-01-27
- Sensor-Surface: 4mm (Mechanical Surface Detection)
- Electronics: DAE4 Sn468; Calibrated: 2010-05-19
- Phantom: Triple Flat Phantom 5.1; Type: Triple Flat Phantom 5.1; Serial: 1001
- Measurement SW: DASY4, V4.7 Build 80; Postprocessing SW: SEMCAD, V1.8 Build 184

**Body, Ch. 128, Ant. Intenna, Bat. Standard/Area Scan (51x71x1):** Measurement grid:

dx=20mm, dy=20mm

Maximum value of SAR (interpolated) = 0.852 mW/g

**Body, Ch. 128, Ant. Intenna, Bat. Standard/Zoom Scan (5x5x7)/Cube 0:** Measurement

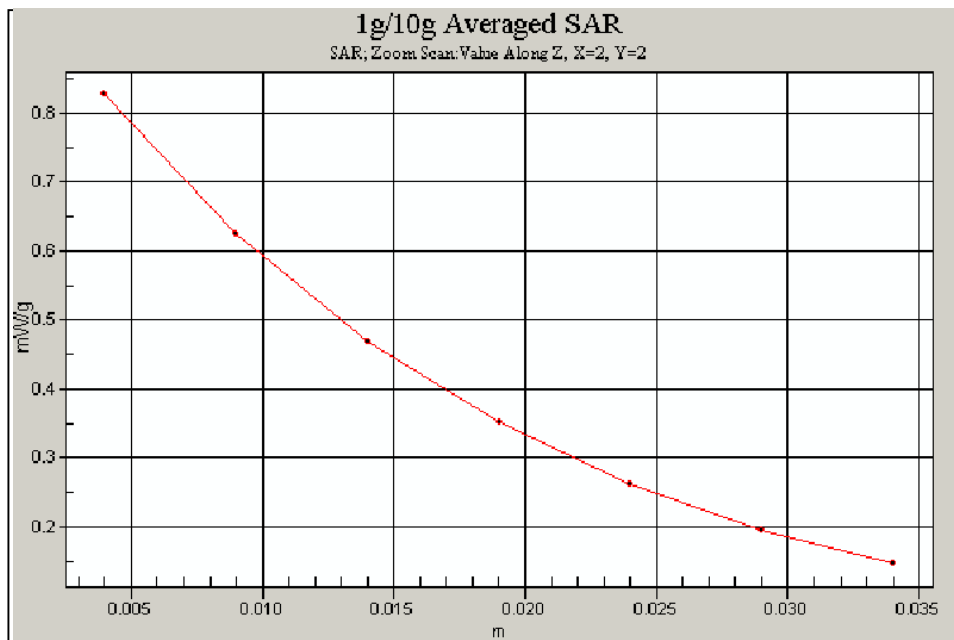
grid: dx=8mm, dy=8mm, dz=5mm

Reference Value = 29.4 V/m; Power Drift = -0.057 dB

Peak SAR (extrapolated) = 1.02 W/kg

**SAR(1 g) = 0.787 mW/g; SAR(10 g) = 0.574 mW/g**

Maximum value of SAR (measured) = 0.827 mW/g



**DUT: GT-B6520L; Serial: FH-154-C**

**Program Name: GT-B6520L GSM1900 Right (Job No. : FH-154)**

**Procedure Name: Cheek/Touch, Ch.661, Ant.Intenna, Bat.Standard**

**Meas. Ambient Temp(celsius)-22.8,Tissue Temp(celsius)-22.4;Test Date-14/Jul/2010**

Communication System: GSM 1900; Frequency: 1880 MHz;Duty Cycle: 1:8.3

Medium parameters used:  $f = 1880$  MHz;  $\sigma = 1.42$  mho/m;  $\epsilon_r = 39$ ;  $\rho = 1000$  kg/m<sup>3</sup>

Phantom section: Right Section

DASY4 Configuration:

- Probe: ES3DV3 - SN3080; ConvF(4.87, 4.87, 4.87); Calibrated: 2010-01-27
- Sensor-Surface: 4mm (Mechanical Surface Detection)
- Electronics: DAE4 Sn468; Calibrated: 2010-05-19
- Phantom: PHANTOM #1; Type: SAM; Serial: TP-1143
- Measurement SW: DASY4, V4.7 Build 80; Postprocessing SW: SEMCAD, V1.8 Build 184

**Cheek/Touch, Ch.661, Ant.Intenna, Bat.Standard/Area Scan (51x71x1):** Measurement grid: dx=20mm, dy=20mm

Maximum value of SAR (interpolated) = 0.428 mW/g

**Cheek/Touch, Ch.661, Ant.Intenna, Bat.Standard/Zoom Scan (5x5x7)/Cube 0:**

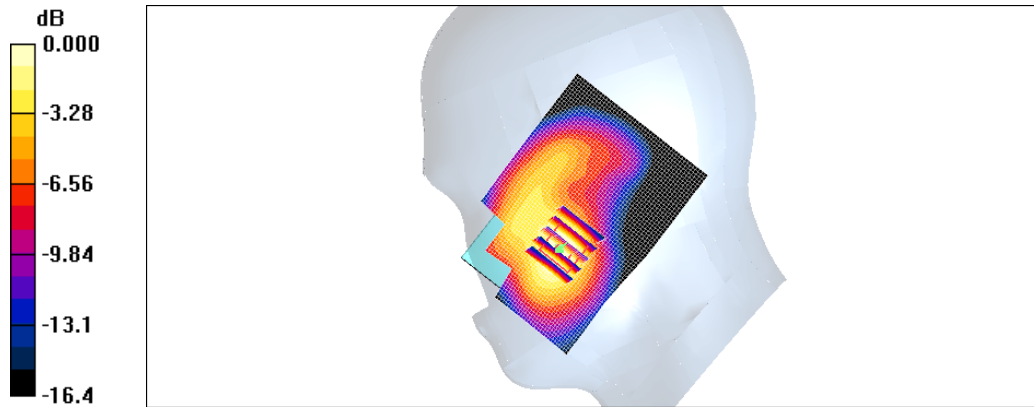
Measurement grid: dx=8mm, dy=8mm, dz=5mm

Reference Value = 14.6 V/m; Power Drift = -0.008 dB

Peak SAR (extrapolated) = 0.536 W/kg

**SAR(1 g) = 0.368 mW/g; SAR(10 g) = 0.225 mW/g**

Maximum value of SAR (measured) = 0.394 mW/g



0 dB = 0.394mW/g

**DUT: GT-B6520L; Serial: FH-154-C**

**Program Name: GT-B6520L GSM1900 Right (Job No. : FH-154)**

**Procedure Name: Ear/Tilt, Ch.661, Ant.Intenna, Bat.Standard**

**Meas. Ambient Temp(celsius)-22.8,Tissue Temp(celsius)-22.4;Test Date-14/Jul/2010**

Communication System: GSM 1900; Frequency: 1880 MHz;Duty Cycle: 1:8.3

Medium parameters used:  $f = 1880$  MHz;  $\sigma = 1.42$  mho/m;  $\epsilon_r = 39$ ;  $\rho = 1000$  kg/m<sup>3</sup>

Phantom section: Right Section

DASY4 Configuration:

- Probe: ES3DV3 - SN3080; ConvF(4.87, 4.87, 4.87); Calibrated: 2010-01-27
- Sensor-Surface: 4mm (Mechanical Surface Detection)
- Electronics: DAE4 Sn468; Calibrated: 2010-05-19
- Phantom: PHANTOM #1; Type: SAM; Serial: TP-1143
- Measurement SW: DASY4, V4.7 Build 80; Postprocessing SW: SEMCAD, V1.8 Build 184

**Ear/Tilt, Ch.661, Ant.Intenna, Bat.Standard/Area Scan (51x71x1):** Measurement grid:

$dx=20$ mm,  $dy=20$ mm

Maximum value of SAR (interpolated) = 0.169 mW/g

**Ear/Tilt, Ch.661, Ant.Intenna, Bat.Standard/Zoom Scan (5x5x7)/Cube 0:** Measurement

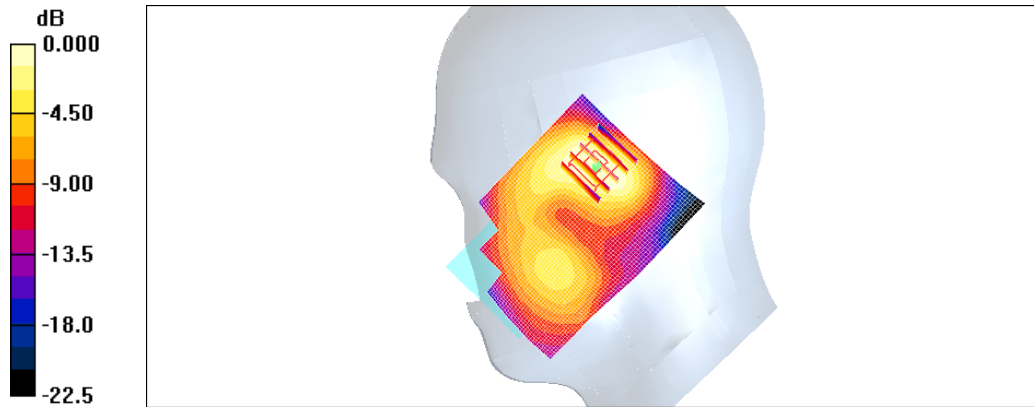
grid:  $dx=8$ mm,  $dy=8$ mm,  $dz=5$ mm

Reference Value = 10.1 V/m; Power Drift = -0.049 dB

Peak SAR (extrapolated) = 0.234 W/kg

**SAR(1 g) = 0.143 mW/g; SAR(10 g) = 0.085 mW/g**

Maximum value of SAR (measured) = 0.151 mW/g



0 dB = 0.151mW/g

**DUT: GT-B6520L; Serial: FH-154-C**

**Program Name: GT-B6520L GSM1900 Left (Job No. : FH-154)**

**Procedure Name: Cheek/Touch, Ch.661, Ant.Intenna, Bat.Standard**

**Meas. Ambient Temp(celsius)-22.8,Tissue Temp(celsius)-22.4;Test Date-14/Jul/2010**

Communication System: GSM 1900; Frequency: 1880 MHz;Duty Cycle: 1:8.3

Medium parameters used:  $f = 1880$  MHz;  $\sigma = 1.42$  mho/m;  $\epsilon_r = 39$ ;  $\rho = 1000$  kg/m<sup>3</sup>

Phantom section: Left Section

DASY4 Configuration:

- Probe: ES3DV3 - SN3080; ConvF(4.87, 4.87, 4.87); Calibrated: 2010-01-27
- Sensor-Surface: 4mm (Mechanical Surface Detection)
- Electronics: DAE4 Sn468; Calibrated: 2010-05-19
- Phantom: PHANTOM #1; Type: SAM; Serial: TP-1143
- Measurement SW: DASY4, V4.7 Build 80; Postprocessing SW: SEMCAD, V1.8 Build 184

**Cheek/Touch, Ch.661, Ant.Intenna, Bat.Standard/Area Scan (51x71x1):** Measurement grid: dx=20mm, dy=20mm

Maximum value of SAR (interpolated) = 0.350 mW/g

**Cheek/Touch, Ch.661, Ant.Intenna, Bat.Standard/Zoom Scan (5x5x7)/Cube 0:**

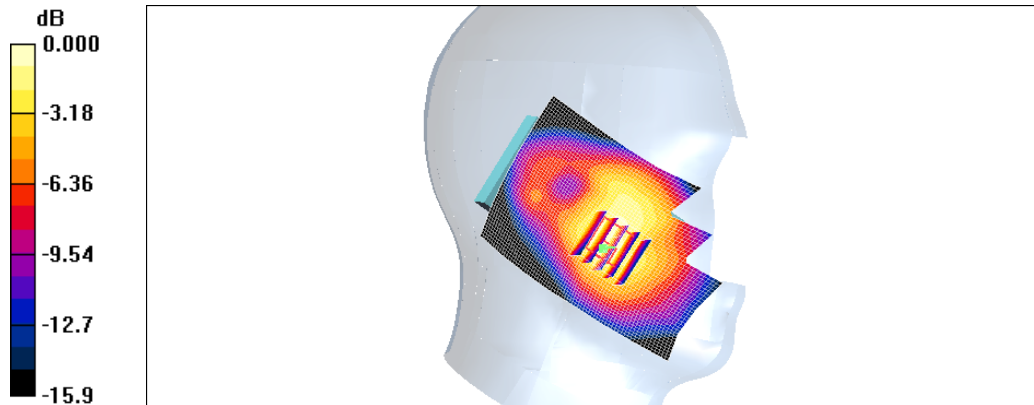
Measurement grid: dx=8mm, dy=8mm, dz=5mm

Reference Value = 14.7 V/m; Power Drift = -0.018 dB

Peak SAR (extrapolated) = 0.469 W/kg

**SAR(1 g) = 0.315 mW/g; SAR(10 g) = 0.197 mW/g**

Maximum value of SAR (measured) = 0.337 mW/g



0 dB = 0.337mW/g

**DUT: GT-B6520L; Serial: FH-154-C**

**Program Name: GT-B6520L GSM1900 Left (Job No. : FH-154)**

**Procedure Name: Ear/Tilt, Ch.661, Ant.Intenna, Bat.Standard**

**Meas. Ambient Temp(celsius)-22.8,Tissue Temp(celsius)-22.4;Test Date-14/Jul/2010**

Communication System: GSM 1900; Frequency: 1880 MHz;Duty Cycle: 1:8.3

Medium parameters used:  $f = 1880$  MHz;  $\sigma = 1.42$  mho/m;  $\epsilon_r = 39$ ;  $\rho = 1000$  kg/m<sup>3</sup>

Phantom section: Left Section

DASY4 Configuration:

- Probe: ES3DV3 - SN3080; ConvF(4.87, 4.87, 4.87); Calibrated: 2010-01-27
- Sensor-Surface: 4mm (Mechanical Surface Detection)
- Electronics: DAE4 Sn468; Calibrated: 2010-05-19
- Phantom: PHANTOM #1; Type: SAM; Serial: TP-1143
- Measurement SW: DASY4, V4.7 Build 80; Postprocessing SW: SEMCAD, V1.8 Build 184

**Ear/Tilt, Ch.661, Ant.Intenna, Bat.Standard/Area Scan (51x71x1):** Measurement grid:

dx=20mm, dy=20mm

Maximum value of SAR (interpolated) = 0.156 mW/g

**Ear/Tilt, Ch.661, Ant.Intenna, Bat.Standard/Zoom Scan (5x5x7)/Cube 0:** Measurement

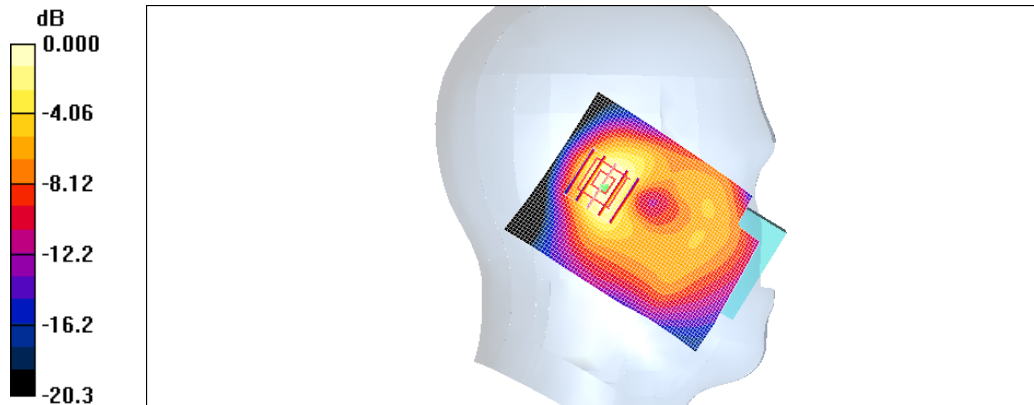
grid: dx=8mm, dy=8mm, dz=5mm

Reference Value = 10.6 V/m; Power Drift = 0.028 dB

Peak SAR (extrapolated) = 0.232 W/kg

**SAR(1 g) = 0.143 mW/g; SAR(10 g) = 0.082 mW/g**

Maximum value of SAR (measured) = 0.156 mW/g



0 dB = 0.156mW/g

**DUT: GT-B6520L; Serial: FH-154-C**

**Program Name: GT-B6520L GPRS1900 Body (Job No. : FH-154)**

**Procedure Name: Body, Ch.512, Ant.Intenna, Bat.Standard**

**Meas. Ambient Temp(celsius)-22.6,Tissue Temp(celsius)-22.3;Test Date-14/Jul/2010**

Communication System: GPRS 1900; Frequency: 1850.2 MHz;Duty Cycle: 1:4.15  
Medium parameters used:  $f = 1850.2$  MHz;  $\sigma = 1.56$  mho/m;  $\epsilon_r = 54.2$ ;  $\rho = 1000$  kg/m<sup>3</sup>  
Phantom section: Right Section

DASY4 Configuration:

- Probe: ES3DV3 - SN3080; ConvF(4.55, 4.55, 4.55); Calibrated: 2010-01-27
- Sensor-Surface: 4mm (Mechanical Surface Detection)
- Electronics: DAE4 Sn468; Calibrated: 2010-05-19
- Phantom: Triple Flat Phantom 5.1; Type: Triple Flat Phantom 5.1; Serial: 1001
- Measurement SW: DASY4, V4.7 Build 80; Postprocessing SW: SEMCAD, V1.8 Build 184

**Body, Ch.512, Ant.Intenna, Bat.Standard/Area Scan (51x71x1):** Measurement grid:

dx=20mm, dy=20mm

Maximum value of SAR (interpolated) = 0.464 mW/g

**Body, Ch.512, Ant.Intenna, Bat.Standard/Zoom Scan (5x5x7)/Cube 0:** Measurement grid:

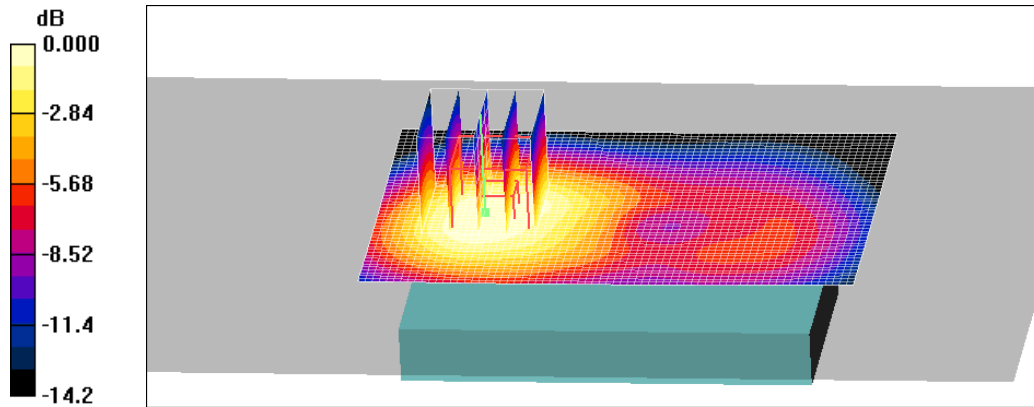
dx=8mm, dy=8mm, dz=5mm

Reference Value = 16.9 V/m; Power Drift = 0.016 dB

Peak SAR (extrapolated) = 0.628 W/kg

**SAR(1 g) = 0.408 mW/g; SAR(10 g) = 0.257 mW/g**

Maximum value of SAR (measured) = 0.434 mW/g



0 dB = 0.434mW/g

**DUT: GT-B6520L; Serial: FH-154-C**

**Program Name: GT-B6520L GPRS1900 Body (Job No. : FH-154)**

**Procedure Name: Body, Ch.512, Ant.Intenna, Bat.Standard**

**Meas. Ambient Temp(celsius)-22.6,Tissue Temp(celsius)-22.3;Test Date-14/Jul/2010**

Communication System: GPRS 1900; Frequency: 1850.2 MHz;Duty Cycle: 1:4.15  
Medium parameters used:  $f = 1850.2$  MHz;  $\sigma = 1.56$  mho/m;  $\epsilon_r = 54.2$ ;  $\rho = 1000$  kg/m<sup>3</sup>  
Phantom section: Right Section

DASY4 Configuration:

- Probe: ES3DV3 - SN3080; ConvF(4.55, 4.55, 4.55); Calibrated: 2010-01-27
- Sensor-Surface: 4mm (Mechanical Surface Detection)
- Electronics: DAE4 Sn468; Calibrated: 2010-05-19
- Phantom: Triple Flat Phantom 5.1; Type: Triple Flat Phantom 5.1; Serial: 1001
- Measurement SW: DASY4, V4.7 Build 80; Postprocessing SW: SEMCAD, V1.8 Build 184

**Body, Ch.512, Ant.Intenna, Bat.Standard/Area Scan (51x71x1):** Measurement grid:

dx=20mm, dy=20mm

Maximum value of SAR (interpolated) = 0.464 mW/g

**Body, Ch.512, Ant.Intenna, Bat.Standard/Zoom Scan (5x5x7)/Cube 0:** Measurement grid:

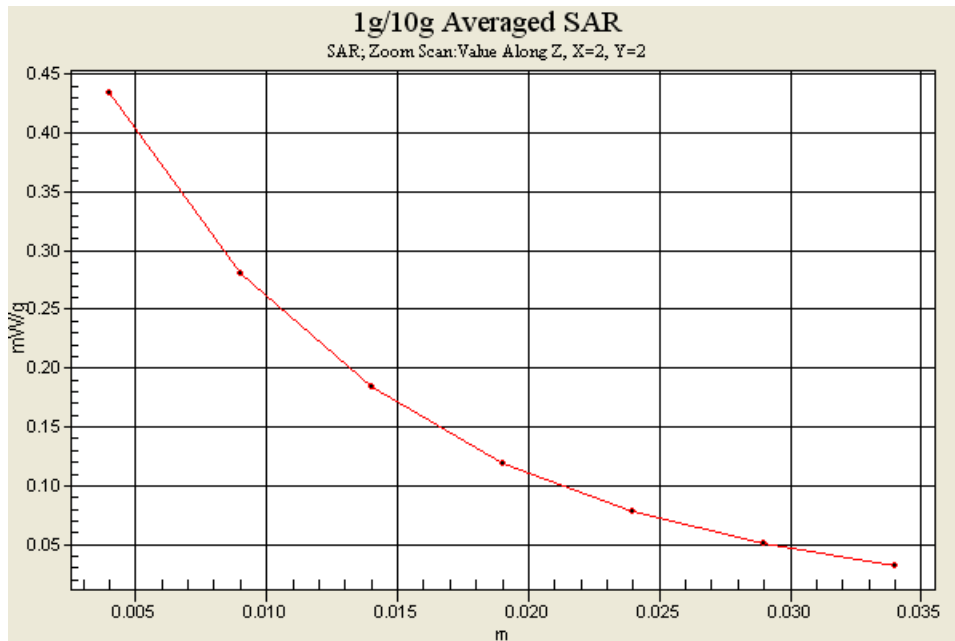
dx=8mm, dy=8mm, dz=5mm

Reference Value = 16.9 V/m; Power Drift = 0.016 dB

Peak SAR (extrapolated) = 0.628 W/kg

**SAR(1 g) = 0.408 mW/g; SAR(10 g) = 0.257 mW/g**

Maximum value of SAR (measured) = 0.434 mW/g



**DUT: GT-B6520L; Serial: FH-154-C**

**Program Name: GT-B6520L WCDMA 850 Right (Job No. : FH-154)**

**Procedure Name: Cheek/Touch, Ch.4183, Ant.Intenna, Bat.Standard**

**Meas. Ambient Temp(celsius)-22.7,Tissue Temp(celsius)-22.3;Test Date-13/Jul/2010**

Communication System: W-CDMA 850; Frequency: 836.6 MHz;Duty Cycle: 1:1  
Medium parameters used:  $f = 836.6$  MHz;  $\sigma = 0.91$  mho/m;  $\epsilon_r = 40.8$ ;  $\rho = 1000$  kg/m<sup>3</sup>  
Phantom section: Right Section

DASY4 Configuration:

- Probe: ES3DV3 - SN3080; ConvF(5.77, 5.77, 5.77); Calibrated: 2010-01-27
- Sensor-Surface: 4mm (Mechanical Surface Detection)
- Electronics: DAE4 Sn468; Calibrated: 2010-05-19
- Phantom: PHANTOM #2; Type: SAM; Serial: TP-1141
- Measurement SW: DASY4, V4.7 Build 80; Postprocessing SW: SEMCAD, V1.8 Build 184

**Cheek/Touch, Ch.4183, Ant.Intenna, Bat.Standard/Area Scan (51x71x1):** Measurement grid: dx=20mm, dy=20mm

Maximum value of SAR (interpolated) = 0.255 mW/g

**Cheek/Touch, Ch.4183, Ant.Intenna, Bat.Standard/Zoom Scan (5x5x7)/Cube 0:**

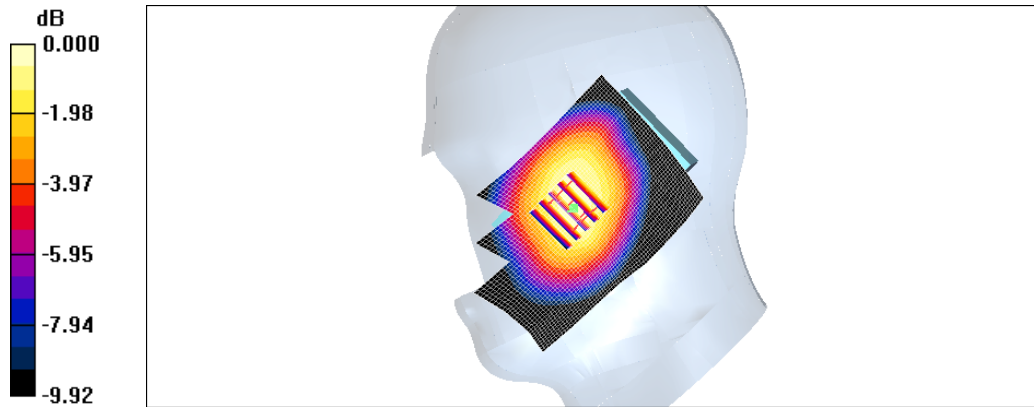
Measurement grid: dx=8mm, dy=8mm, dz=5mm

Reference Value = 17.1 V/m; Power Drift = 0.031 dB

Peak SAR (extrapolated) = 0.332 W/kg

**SAR(1 g) = 0.253 mW/g; SAR(10 g) = 0.186 mW/g**

Maximum value of SAR (measured) = 0.268 mW/g



0 dB = 0.268mW/g

**DUT: GT-B6520L; Serial: FH-154-C**

**Program Name: GT-B6520L WCDMA 850 Right (Job No. : FH-154)**

**Procedure Name: Ear/Tilt, Ch.4183, Ant.Intenna, Bat.Standard**

**Meas. Ambient Temp(celsius)-22.7,Tissue Temp(celsius)-22.3;Test Date-13/Jul/2010**

Communication System: W-CDMA 850; Frequency: 836.6 MHz;Duty Cycle: 1:1  
Medium parameters used:  $f = 836.6$  MHz;  $\sigma = 0.91$  mho/m;  $\epsilon_r = 40.8$ ;  $\rho = 1000$  kg/m<sup>3</sup>  
Phantom section: Right Section

DASY4 Configuration:

- Probe: ES3DV3 - SN3080; ConvF(5.77, 5.77, 5.77); Calibrated: 2010-01-27
- Sensor-Surface: 4mm (Mechanical Surface Detection)
- Electronics: DAE4 Sn468; Calibrated: 2010-05-19
- Phantom: PHANTOM #2; Type: SAM; Serial: TP-1141
- Measurement SW: DASY4, V4.7 Build 80; Postprocessing SW: SEMCAD, V1.8 Build 184

**Ear/Tilt, Ch.4183, Ant.Intenna, Bat.Standard/Area Scan (51x71x1):** Measurement grid:  
dx=20mm, dy=20mm

Maximum value of SAR (interpolated) = 0.216 mW/g

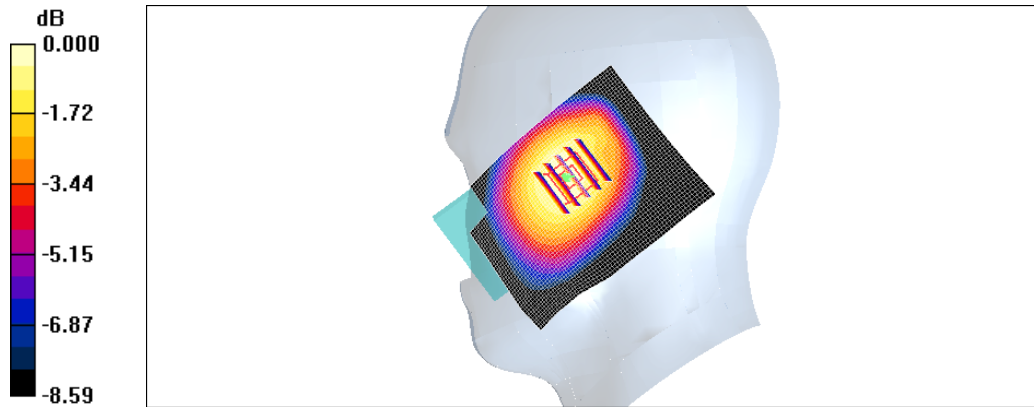
**Ear/Tilt, Ch.4183, Ant.Intenna, Bat.Standard/Zoom Scan (5x5x7)/Cube 0:** Measurement grid:  
dx=8mm, dy=8mm, dz=5mm

Reference Value = 11.0 V/m; Power Drift = 0.052 dB

Peak SAR (extrapolated) = 0.259 W/kg

**SAR(1 g) = 0.204 mW/g; SAR(10 g) = 0.153 mW/g**

Maximum value of SAR (measured) = 0.215 mW/g



0 dB = 0.215mW/g

**DUT: GT-B6520L; Serial: FH-154-C**

**Program Name: GT-B6520L WCDMA850 Left (Job No. : FH-154)**

**Procedure Name: Cheek/Touch, Ch.4183, Ant.Intenna, Bat.Standard**

**Meas. Ambient Temp(celsius)-22.7,Tissue Temp(celsius)-22.3;Test Date-13/Jul/2010**

Communication System: W-CDMA 850; Frequency: 836.6 MHz;Duty Cycle: 1:1  
Medium parameters used:  $f = 836.6$  MHz;  $\sigma = 0.91$  mho/m;  $\epsilon_r = 40.8$ ;  $\rho = 1000$  kg/m<sup>3</sup>  
Phantom section: Left Section

DASY4 Configuration:

- Probe: ES3DV3 - SN3080; ConvF(5.77, 5.77, 5.77); Calibrated: 2010-01-27
- Sensor-Surface: 4mm (Mechanical Surface Detection)
- Electronics: DAE4 Sn468; Calibrated: 2010-05-19
- Phantom: PHANTOM #2; Type: SAM; Serial: TP-1141
- Measurement SW: DASY4, V4.7 Build 80; Postprocessing SW: SEMCAD, V1.8 Build 184

**Cheek/Touch, Ch.4183, Ant.Intenna, Bat.Standard/Area Scan (51x71x1):** Measurement grid: dx=20mm, dy=20mm

Maximum value of SAR (interpolated) = 0.310 mW/g

**Cheek/Touch, Ch.4183, Ant.Intenna, Bat.Standard/Zoom Scan (5x5x7)/Cube 0:**

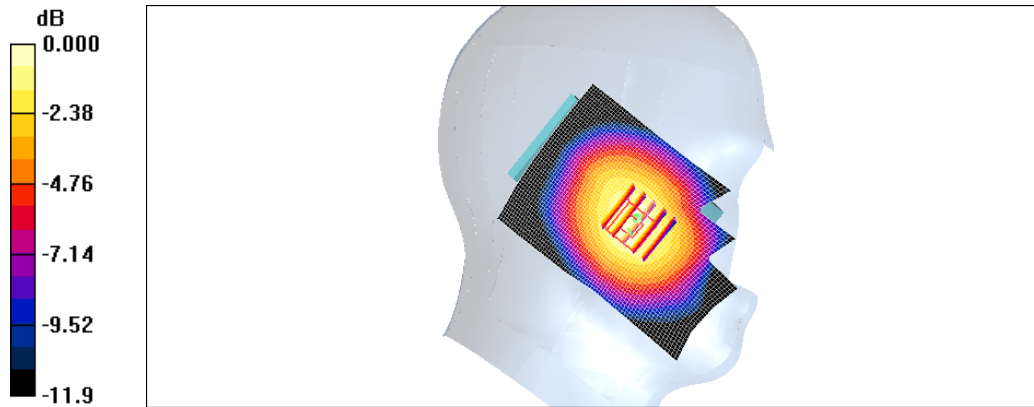
Measurement grid: dx=8mm, dy=8mm, dz=5mm

Reference Value = 18.2 V/m; Power Drift = -0.004 dB

Peak SAR (extrapolated) = 0.384 W/kg

**SAR(1 g) = 0.296 mW/g; SAR(10 g) = 0.216 mW/g**

Maximum value of SAR (measured) = 0.318 mW/g



0 dB = 0.318mW/g

**DUT: GT-B6520L; Serial: FH-154-C**

**Program Name: GT-B6520L WCDMA850 Left (Job No. : FH-154)**

**Procedure Name: Ear/Tilt, Ch.4183, Ant.Intenna, Bat.Standard**

**Meas. Ambient Temp(celsius)-22.7,Tissue Temp(celsius)-22.3;Test Date-13/Jul/2010**

Communication System: W-CDMA 850; Frequency: 836.6 MHz;Duty Cycle: 1:1  
Medium parameters used:  $f = 836.6$  MHz;  $\sigma = 0.91$  mho/m;  $\epsilon_r = 40.8$ ;  $\rho = 1000$  kg/m<sup>3</sup>  
Phantom section: Left Section

DASY4 Configuration:

- Probe: ES3DV3 - SN3080; ConvF(5.77, 5.77, 5.77); Calibrated: 2010-01-27
- Sensor-Surface: 4mm (Mechanical Surface Detection)
- Electronics: DAE4 Sn468; Calibrated: 2010-05-19
- Phantom: PHANTOM #2; Type: SAM; Serial: TP-1141
- Measurement SW: DASY4, V4.7 Build 80; Postprocessing SW: SEMCAD, V1.8 Build 184

**Ear/Tilt, Ch.4183, Ant.Intenna, Bat.Standard/Area Scan (51x71x1):** Measurement grid:  
dx=20mm, dy=20mm

Maximum value of SAR (interpolated) = 0.233 mW/g

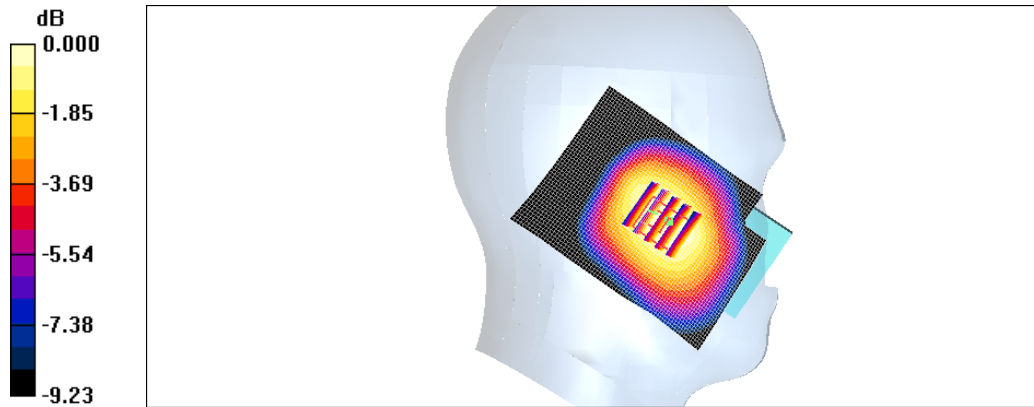
**Ear/Tilt, Ch.4183, Ant.Intenna, Bat.Standard/Zoom Scan (5x5x7)/Cube 0:** Measurement grid:  
dx=8mm, dy=8mm, dz=5mm

Reference Value = 14.0 V/m; Power Drift = 0.089 dB

Peak SAR (extrapolated) = 0.281 W/kg

**SAR(1 g) = 0.222 mW/g; SAR(10 g) = 0.167 mW/g**

Maximum value of SAR (measured) = 0.232 mW/g



0 dB = 0.232mW/g

**DUT: GT-B6520L; Serial: FH-154-C**

**Program Name: GT-B6520L WCDMA850 Left (Job No. : FH-154)**

**Procedure Name: Cheek/Touch, Ch.4183, Ant.Intenna, Bat.Standard**

**Meas. Ambient Temp(celsius)-22.7,Tissue Temp(celsius)-22.3;Test Date-13/Jul/2010**

Communication System: W-CDMA 850; Frequency: 836.6 MHz;Duty Cycle: 1:1  
Medium parameters used:  $f = 836.6$  MHz;  $\sigma = 0.91$  mho/m;  $\epsilon_r = 40.8$ ;  $\rho = 1000$  kg/m<sup>3</sup>  
Phantom section: Left Section

DASY4 Configuration:

- Probe: ES3DV3 - SN3080; ConvF(5.77, 5.77, 5.77); Calibrated: 2010-01-27
- Sensor-Surface: 4mm (Mechanical Surface Detection)
- Electronics: DAE4 Sn468; Calibrated: 2010-05-19
- Phantom: PHANTOM #2; Type: SAM; Serial: TP-1141
- Measurement SW: DASY4, V4.7 Build 80; Postprocessing SW: SEMCAD, V1.8 Build 184

**Cheek/Touch, Ch.4183, Ant.Intenna, Bat.Standard/Area Scan (51x71x1):** Measurement grid: dx=20mm, dy=20mm

Maximum value of SAR (interpolated) = 0.310 mW/g

**Cheek/Touch, Ch.4183, Ant.Intenna, Bat.Standard/Zoom Scan (5x5x7)/Cube 0:**

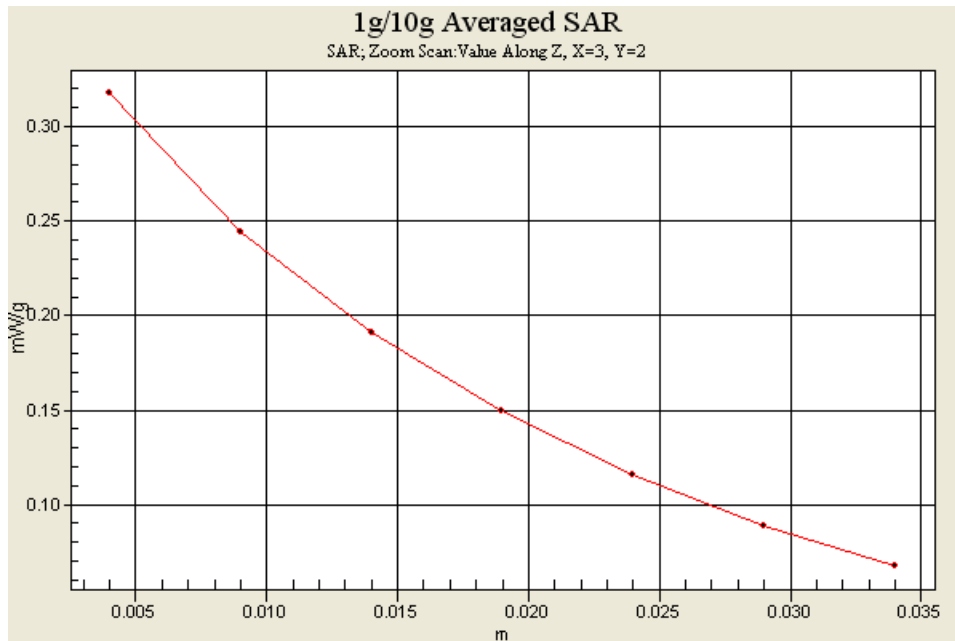
Measurement grid: dx=8mm, dy=8mm, dz=5mm

Reference Value = 18.2 V/m; Power Drift = -0.004 dB

Peak SAR (extrapolated) = 0.384 W/kg

**SAR(1 g) = 0.296 mW/g; SAR(10 g) = 0.216 mW/g**

Maximum value of SAR (measured) = 0.318 mW/g



**DUT: GT-B6520L; Serial: FH-154-C**

**Program Name: GT-B6520L WCDMA850 Body (Job No. : FH-154)**

**Procedure Name: Body, Ch.4183, Ant.Intenna, Bat.Standard**

**Meas. Ambient Temp(celsius)-22.7,Tissue Temp(celsius)-22.3;Test Date-13/Jul/2010**

Communication System: W-CDMA 850; Frequency: 836.6 MHz;Duty Cycle: 1:1  
Medium parameters used:  $f = 836.6$  MHz;  $\sigma = 1$  mho/m;  $\epsilon_r = 55.2$ ;  $\rho = 1000$  kg/m<sup>3</sup>  
Phantom section: Left Section

DASY4 Configuration:

- Probe: ES3DV3 - SN3080; ConvF(5.7, 5.7, 5.7); Calibrated: 2010-01-27
- Sensor-Surface: 4mm (Mechanical Surface Detection)
- Electronics: DAE4 Sn468; Calibrated: 2010-05-19
- Phantom: Triple Flat Phantom 5.1; Type: Triple Flat Phantom 5.1; Serial: 1001
- Measurement SW: DASY4, V4.7 Build 80; Postprocessing SW: SEMCAD, V1.8 Build 184

**Body, Ch.4183, Ant.Intenna, Bat.Standard/Area Scan (51x71x1):** Measurement grid:

dx=20mm, dy=20mm

Maximum value of SAR (interpolated) = 0.361 mW/g

**Body, Ch.4183, Ant.Intenna, Bat.Standard/Zoom Scan (5x5x7)/Cube 0:** Measurement grid:

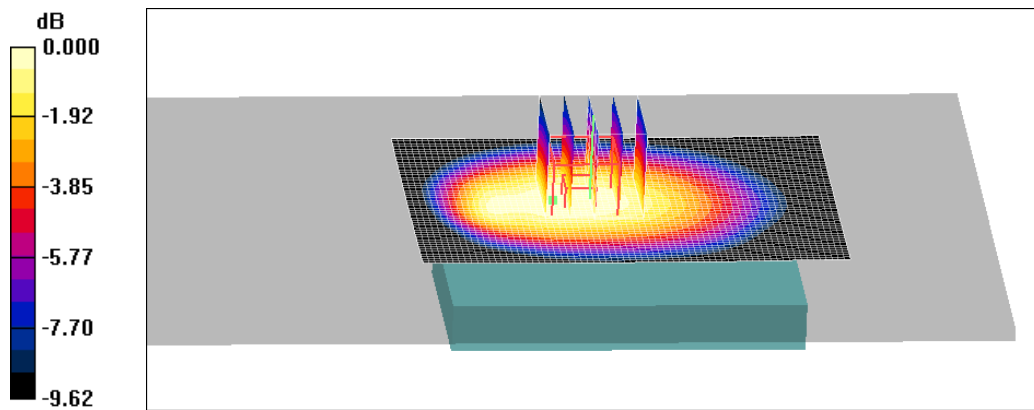
dx=8mm, dy=8mm, dz=5mm

Reference Value = 18.1 V/m; Power Drift = 0.009 dB

Peak SAR (extrapolated) = 0.445 W/kg

**SAR(1 g) = 0.334 mW/g; SAR(10 g) = 0.241 mW/g**

Maximum value of SAR (measured) = 0.352 mW/g



0 dB = 0.352mW/g

**DUT: GT-B6520L; Serial: FH-154-C**

**Program Name: GT-B6520L WCDMA850 Body (Job No. : FH-154)**

**Procedure Name: Body, Ch.4183, Ant.Intenna, Bat.Standard**

**Meas. Ambient Temp(celsius)-22.7,Tissue Temp(celsius)-22.3;Test Date-13/Jul/2010**

Communication System: W-CDMA 850; Frequency: 836.6 MHz;Duty Cycle: 1:1  
Medium parameters used:  $f = 836.6$  MHz;  $\sigma = 1$  mho/m;  $\epsilon_r = 55.2$ ;  $\rho = 1000$  kg/m<sup>3</sup>  
Phantom section: Left Section

DASY4 Configuration:

- Probe: ES3DV3 - SN3080; ConvF(5.7, 5.7, 5.7); Calibrated: 2010-01-27
- Sensor-Surface: 4mm (Mechanical Surface Detection)
- Electronics: DAE4 Sn468; Calibrated: 2010-05-19
- Phantom: Triple Flat Phantom 5.1; Type: Triple Flat Phantom 5.1; Serial: 1001
- Measurement SW: DASY4, V4.7 Build 80; Postprocessing SW: SEMCAD, V1.8 Build 184

**Body, Ch.4183, Ant.Intenna, Bat.Standard/Area Scan (51x71x1):** Measurement grid:

dx=20mm, dy=20mm

Maximum value of SAR (interpolated) = 0.361 mW/g

**Body, Ch.4183, Ant.Intenna, Bat.Standard/Zoom Scan (5x5x7)/Cube 0:** Measurement grid:

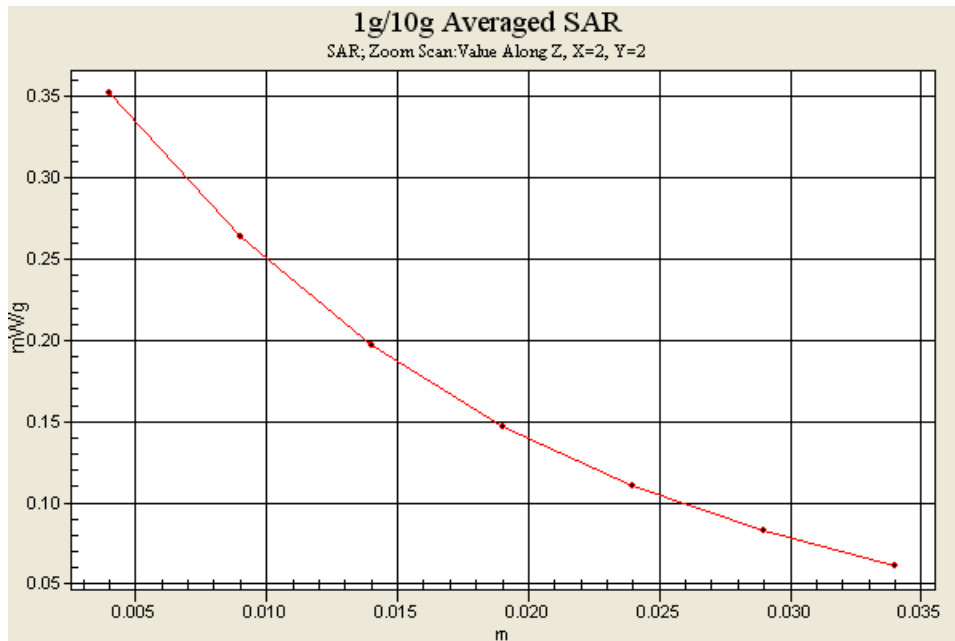
dx=8mm, dy=8mm, dz=5mm

Reference Value = 18.1 V/m; Power Drift = 0.009 dB

Peak SAR (extrapolated) = 0.445 W/kg

**SAR(1 g) = 0.334 mW/g; SAR(10 g) = 0.241 mW/g**

Maximum value of SAR (measured) = 0.352 mW/g



**DUT: GT-B6520L; Serial: FH-154-C**

**Program Name: GT-B6520L WCDMA1900 Right (Job No.: FH-154)**

**Procedure Name: Cheek/Touch, Ch.9262, Ant.Intenna, Bat.Standard**

**Meas. Ambient Temp(celsius)-22.8,Tissue Temp(celsius)-22.4;Test Date-14/Jul/2010**

Communication System: WCDMA1900; Frequency: 1852.4 MHz;Duty Cycle: 1:1  
Medium parameters used:  $f = 1852.4$  MHz;  $\sigma = 1.42$  mho/m;  $\epsilon_r = 39$ ;  $\rho = 1000$  kg/m<sup>3</sup>  
Phantom section: Right Section

DASY4 Configuration:

- Probe: ES3DV3 - SN3080; ConvF(4.87, 4.87, 4.87); Calibrated: 2010-01-27
- Sensor-Surface: 4mm (Mechanical Surface Detection)
- Electronics: DAE4 Sn468; Calibrated: 2010-05-19
- Phantom: PHANTOM #1; Type: SAM; Serial: TP-1143
- Measurement SW: DASY4, V4.7 Build 80; Postprocessing SW: SEMCAD, V1.8 Build 184

**Cheek/Touch, Ch.9262, Ant.Intenna, Bat.Standard/Area Scan (51x71x1):** Measurement grid: dx=20mm, dy=20mm

Maximum value of SAR (interpolated) = 1.04 mW/g

**Cheek/Touch, Ch.9262, Ant.Intenna, Bat.Standard/Zoom Scan (5x5x7)/Cube 0:**

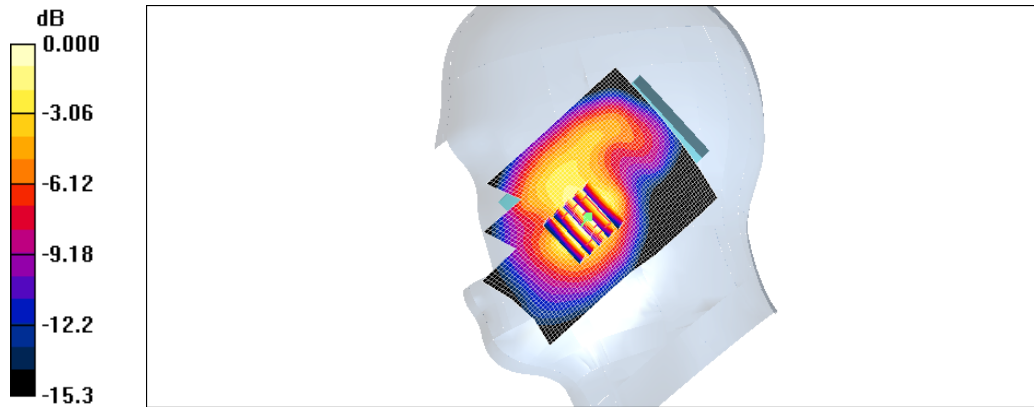
Measurement grid: dx=8mm, dy=8mm, dz=5mm

Reference Value = 23.9 V/m; Power Drift = 0.052 dB

Peak SAR (extrapolated) = 1.37 W/kg

**SAR(1 g) = 0.945 mW/g; SAR(10 g) = 0.585 mW/g**

Maximum value of SAR (measured) = 1.01 mW/g



0 dB = 1.01mW/g

**DUT: GT-B6520L; Serial: FH-154-C**

**Program Name: GT-B6520L WCDMA1900 Right (Job No.: FH-154)**

**Procedure Name: Ear/Tilt, Ch.9400, Ant.Intenna, Bat.Standard**

**Meas. Ambient Temp(celsius)-22.8,Tissue Temp(celsius)-22.4;Test Date-14/Jul/2010**

Communication System: WCDMA1900; Frequency: 1880 MHz;Duty Cycle: 1:1  
Medium parameters used:  $f = 1880$  MHz;  $\sigma = 1.42$  mho/m;  $\epsilon_r = 39$ ;  $\rho = 1000$  kg/m<sup>3</sup>  
Phantom section: Right Section

DASY4 Configuration:

- Probe: ES3DV3 - SN3080; ConvF(4.87, 4.87, 4.87); Calibrated: 2010-01-27
- Sensor-Surface: 4mm (Mechanical Surface Detection)
- Electronics: DAE4 Sn468; Calibrated: 2010-05-19
- Phantom: PHANTOM #1; Type: SAM; Serial: TP-1143
- Measurement SW: DASY4, V4.7 Build 80; Postprocessing SW: SEMCAD, V1.8 Build 184

**Ear/Tilt, Ch.9400, Ant.Intenna, Bat.Standard/Area Scan (51x71x1):** Measurement grid:  
dx=20mm, dy=20mm

Maximum value of SAR (interpolated) = 0.356 mW/g

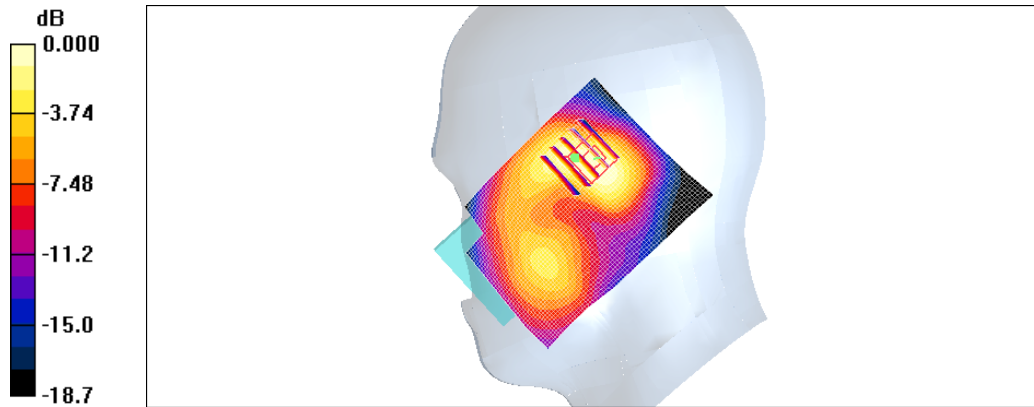
**Ear/Tilt, Ch.9400, Ant.Intenna, Bat.Standard/Zoom Scan (5x5x7)/Cube 0:** Measurement grid:  
dx=8mm, dy=8mm, dz=5mm

Reference Value = 15.9 V/m; Power Drift = -0.011 dB

Peak SAR (extrapolated) = 0.524 W/kg

**SAR(1 g) = 0.337 mW/g; SAR(10 g) = 0.202 mW/g**

Maximum value of SAR (measured) = 0.364 mW/g



0 dB = 0.364mW/g

**DUT: GT-B6520L; Serial: FH-154-C**

**Program Name: GT-B6520L WCDMA1900 Left (Job No.:FH-154)**

**Procedure Name: Cheek/Touch, Ch.9400, Ant.Intenna, Bat.Standard**

**Meas. Ambient Temp(celsius)-22.8,Tissue Temp(celsius)-22.4;Test Date-14/Jul/2010**

Communication System: WCDMA1900; Frequency: 1880 MHz;Duty Cycle: 1:1  
Medium parameters used:  $f = 1880$  MHz;  $\sigma = 1.42$  mho/m;  $\epsilon_r = 39$ ;  $\rho = 1000$  kg/m<sup>3</sup>  
Phantom section: Left Section

DASY4 Configuration:

- Probe: ES3DV3 - SN3080; ConvF(4.87, 4.87, 4.87); Calibrated: 2010-01-27
- Sensor-Surface: 4mm (Mechanical Surface Detection)
- Electronics: DAE4 Sn468; Calibrated: 2010-05-19
- Phantom: PHANTOM #1; Type: SAM; Serial: TP-1143
- Measurement SW: DASY4, V4.7 Build 80; Postprocessing SW: SEMCAD, V1.8 Build 184

**Cheek/Touch, Ch.9400, Ant.Intenna, Bat.Standard/Area Scan (51x71x1):** Measurement grid: dx=20mm, dy=20mm

Maximum value of SAR (interpolated) = 0.757 mW/g

**Cheek/Touch, Ch.9400, Ant.Intenna, Bat.Standard/Zoom Scan (5x5x7)/Cube 0:**

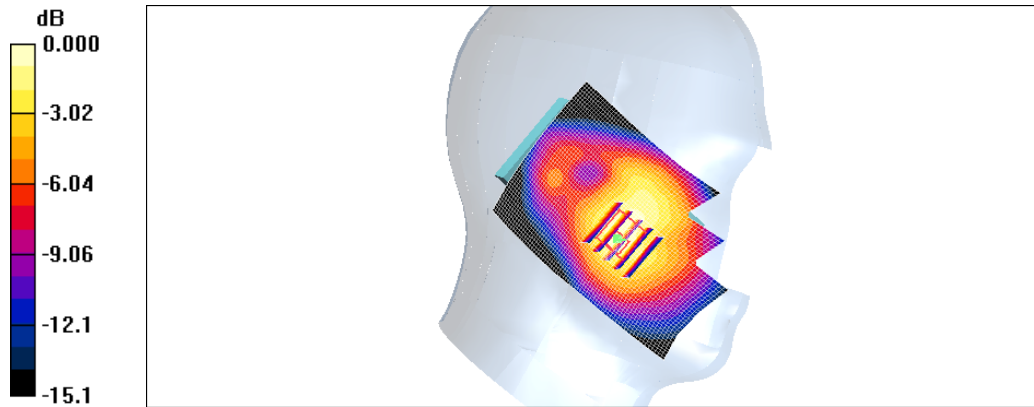
Measurement grid: dx=8mm, dy=8mm, dz=5mm

Reference Value = 21.7 V/m; Power Drift = 0.023 dB

Peak SAR (extrapolated) = 1.03 W/kg

**SAR(1 g) = 0.702 mW/g; SAR(10 g) = 0.441 mW/g**

Maximum value of SAR (measured) = 0.748 mW/g



0 dB = 0.748mW/g

**DUT: GT-B6520L; Serial: FH-154-C**

**Program Name: GT-B6520L WCDMA1900 Left (Job No.:FH-154)**

**Procedure Name: Ear/Tilt, Ch.9400, Ant.Intenna, Bat.Standard**

**Meas. Ambient Temp(celsius)-22.8,Tissue Temp(celsius)-22.4;Test Date-14/Jul/2010**

Communication System: WCDMA1900; Frequency: 1880 MHz;Duty Cycle: 1:1  
Medium parameters used:  $f = 1880$  MHz;  $\sigma = 1.42$  mho/m;  $\epsilon_r = 39$ ;  $\rho = 1000$  kg/m<sup>3</sup>  
Phantom section: Left Section

DASY4 Configuration:

- Probe: ES3DV3 - SN3080; ConvF(4.87, 4.87, 4.87); Calibrated: 2010-01-27
- Sensor-Surface: 4mm (Mechanical Surface Detection)
- Electronics: DAE4 Sn468; Calibrated: 2010-05-19
- Phantom: PHANTOM #1; Type: SAM; Serial: TP-1143
- Measurement SW: DASY4, V4.7 Build 80; Postprocessing SW: SEMCAD, V1.8 Build 184

**Ear/Tilt, Ch.9400, Ant.Intenna, Bat.Standard/Area Scan (51x71x1):** Measurement grid:  
dx=20mm, dy=20mm

Maximum value of SAR (interpolated) = 0.367 mW/g

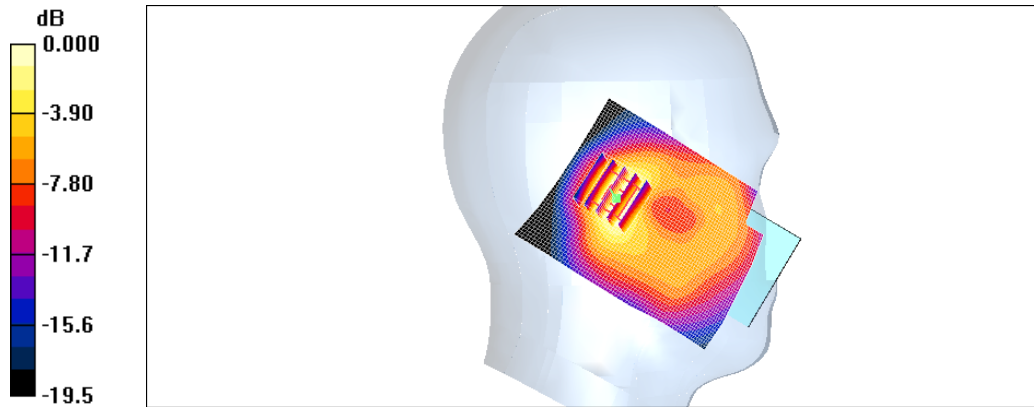
**Ear/Tilt, Ch.9400, Ant.Intenna, Bat.Standard/Zoom Scan (5x5x7)/Cube 0:** Measurement grid:  
dx=8mm, dy=8mm, dz=5mm

Reference Value = 15.1 V/m; Power Drift = -0.006 dB

Peak SAR (extrapolated) = 0.517 W/kg

**SAR(1 g) = 0.322 mW/g; SAR(10 g) = 0.186 mW/g**

Maximum value of SAR (measured) = 0.354 mW/g



0 dB = 0.354mW/g

**DUT: GT-B6520L; Serial: FH-154-C**

**Program Name: GT-B6520L WCDMA1900 Right (Job No.: FH-154)**

**Procedure Name: Cheek/Touch, Ch.9262, Ant.Intenna, Bat.Standard**

**Meas. Ambient Temp(celsius)-22.8,Tissue Temp(celsius)-22.4;Test Date-14/Jul/2010**

Communication System: WCDMA1900; Frequency: 1852.4 MHz;Duty Cycle: 1:1  
Medium parameters used:  $f = 1852.4$  MHz;  $\sigma = 1.42$  mho/m;  $\epsilon_r = 39$ ;  $\rho = 1000$  kg/m<sup>3</sup>  
Phantom section: Right Section

DASY4 Configuration:

- Probe: ES3DV3 - SN3080; ConvF(4.87, 4.87, 4.87); Calibrated: 2010-01-27
- Sensor-Surface: 4mm (Mechanical Surface Detection)
- Electronics: DAE4 Sn468; Calibrated: 2010-05-19
- Phantom: PHANTOM #1; Type: SAM; Serial: TP-1143
- Measurement SW: DASY4, V4.7 Build 80; Postprocessing SW: SEMCAD, V1.8 Build 184

**Cheek/Touch, Ch.9262, Ant.Intenna, Bat.Standard/Area Scan (51x71x1):** Measurement grid: dx=20mm, dy=20mm

Maximum value of SAR (interpolated) = 1.04 mW/g

**Cheek/Touch, Ch.9262, Ant.Intenna, Bat.Standard/Zoom Scan (5x5x7)/Cube 0:**

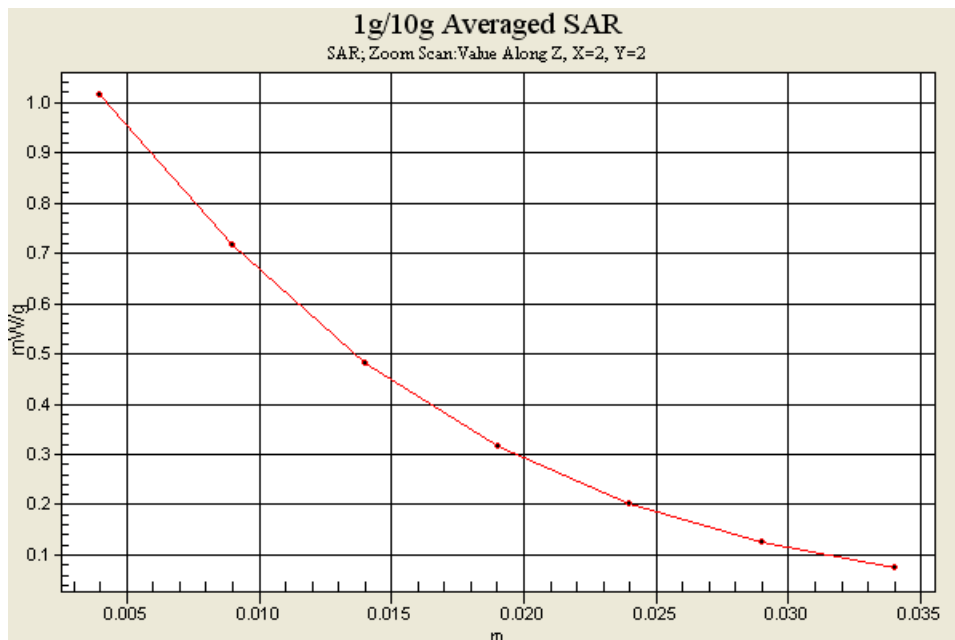
Measurement grid: dx=8mm, dy=8mm, dz=5mm

Reference Value = 23.9 V/m; Power Drift = 0.052 dB

Peak SAR (extrapolated) = 1.37 W/kg

**SAR(1 g) = 0.945 mW/g; SAR(10 g) = 0.585 mW/g**

Maximum value of SAR (measured) = 1.01 mW/g



**DUT: GT-B6520L; Serial: FH-084-C**

**Program Name: GT-B6520L WCDMA1900 Body (Job No. : FH-154)**

**Procedure Name: Body, Ch.9538, Ant.Intenna, Bat.Standard**

**Meas. Ambient Temp(celsius)-22.6,Tissue Temp(celsius)-22.3;Test Date-14/Jul/2010**

Communication System: WCDMA; Frequency: 1907.6 MHz;Duty Cycle: 1:1

Medium parameters used:  $f = 1907.6$  MHz;  $\sigma = 1.56$  mho/m;  $\epsilon_r = 54.2$ ;  $\rho = 1000$  kg/m<sup>3</sup>

Phantom section: Right Section

DASY4 Configuration:

- Probe: ES3DV3 - SN3080; ConvF(4.55, 4.55, 4.55); Calibrated: 2010-01-27
- Sensor-Surface: 4mm (Mechanical Surface Detection)
- Electronics: DAE4 Sn468; Calibrated: 2010-05-19
- Phantom: Triple Flat Phantom 5.1; Type: Triple Flat Phantom 5.1; Serial: 1001
- Measurement SW: DASY4, V4.7 Build 80; Postprocessing SW: SEMCAD, V1.8 Build 184

**Body, Ch.9538, Ant.Intenna, Bat.Standard/Area Scan (51x71x1):** Measurement grid:

dx=20mm, dy=20mm

Maximum value of SAR (interpolated) = 0.453 mW/g

**Body, Ch.9538, Ant.Intenna, Bat.Standard/Zoom Scan (5x5x7)/Cube 0:** Measurement grid:

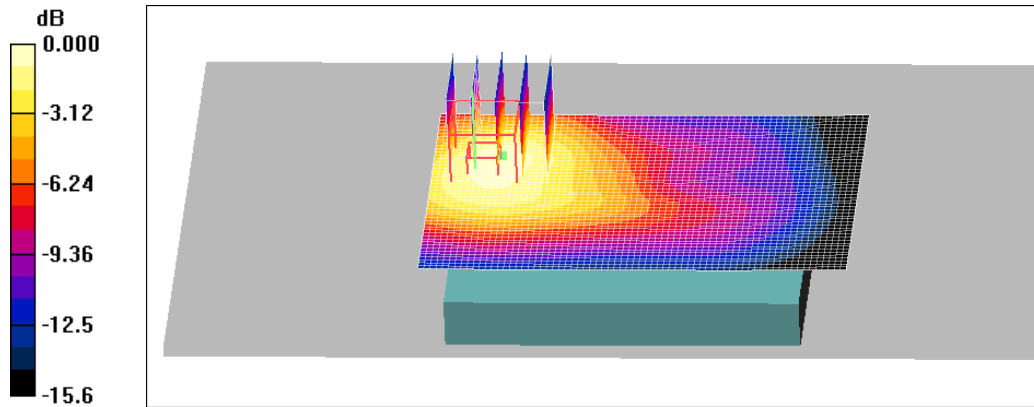
dx=8mm, dy=8mm, dz=5mm

Reference Value = 9.12 V/m; Power Drift = -0.075 dB

Peak SAR (extrapolated) = 0.693 W/kg

**SAR(1 g) = 0.448 mW/g; SAR(10 g) = 0.274 mW/g**

Maximum value of SAR (measured) = 0.485 mW/g



0 dB = 0.485mW/g

**DUT: GT-B6520L; Serial: FH-084-C**

**Program Name: GT-B6520L WCDMA1900 Body (Job No. : FH-154)**

**Procedure Name: Body, Ch.9538, Ant.Intenna, Bat.Standard**

**Meas. Ambient Temp(celsius)-22.6,Tissue Temp(celsius)-22.3;Test Date-14/Jul/2010**

Communication System: WCDMA; Frequency: 1907.6 MHz;Duty Cycle: 1:1

Medium parameters used:  $f = 1907.6$  MHz;  $\sigma = 1.56$  mho/m;  $\epsilon_r = 54.2$ ;  $\rho = 1000$  kg/m<sup>3</sup>

Phantom section: Right Section

DASY4 Configuration:

- Probe: ES3DV3 - SN3080; ConvF(4.55, 4.55, 4.55); Calibrated: 2010-01-27
- Sensor-Surface: 4mm (Mechanical Surface Detection)
- Electronics: DAE4 Sn468; Calibrated: 2010-05-19
- Phantom: Triple Flat Phantom 5.1; Type: Triple Flat Phantom 5.1; Serial: 1001
- Measurement SW: DASY4, V4.7 Build 80; Postprocessing SW: SEMCAD, V1.8 Build 184

**Body, Ch.9538, Ant.Intenna, Bat.Standard/Area Scan (51x71x1):** Measurement grid:

dx=20mm, dy=20mm

Maximum value of SAR (interpolated) = 0.453 mW/g

**Body, Ch.9538, Ant.Intenna, Bat.Standard/Zoom Scan (5x5x7)/Cube 0:** Measurement grid:

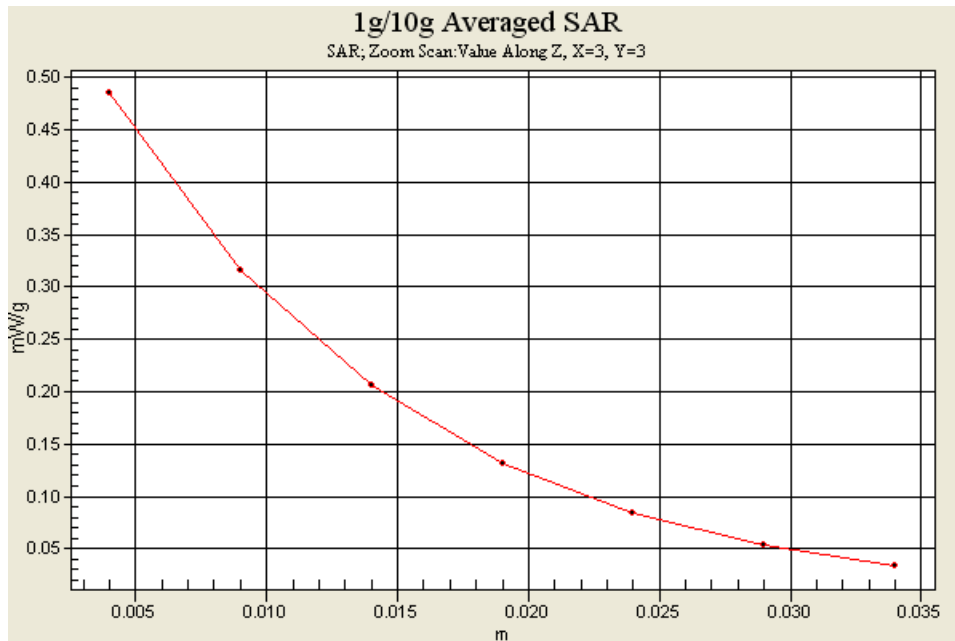
dx=8mm, dy=8mm, dz=5mm

Reference Value = 9.12 V/m; Power Drift = -0.075 dB

Peak SAR (extrapolated) = 0.693 W/kg

**SAR(1 g) = 0.448 mW/g; SAR(10 g) = 0.274 mW/g**

Maximum value of SAR (measured) = 0.485 mW/g



**DUT: GT-B6520L; Serial: FH-154-C**

**Program Name: GT-B6520L WLAN Right(Job No. : FH-154)**

**Procedure Name: Cheek, Ch.06, Ant.Intenna, Bat.Standard**

**Meas. Ambient Temp(celsius)-22.7,Tissue Temp(celsius)-22.6;Test Date-16/Jul/2010**

Communication System: WLAN; Frequency: 2437 MHz;Duty Cycle: 1:1

Medium parameters used:  $f = 2437$  MHz;  $\sigma = 1.82$  mho/m;  $\epsilon_r = 38.3$ ;  $\rho = 1000$  kg/m<sup>3</sup>

Phantom section: Right Section

DASY4 Configuration:

- Probe: ES3DV3 - SN3080; ConvF(4.38, 4.38, 4.38); Calibrated: 2010-01-27
- Sensor-Surface: 4mm (Mechanical Surface Detection)
- Electronics: DAE4 Sn468; Calibrated: 2010-05-19
- Phantom: PHANTOM #1; Type: SAM; Serial: TP-1143
- Measurement SW: DASY4, V4.7 Build 80; Postprocessing SW: SEMCAD, V1.8 Build 184

**Cheek, Ch.06, Ant.Intenna, Bat.Standard/Area Scan (51x71x1):** Measurement grid:

dx=20mm, dy=20mm

Maximum value of SAR (interpolated) = 0.105 mW/g

**Cheek, Ch.06, Ant.Intenna, Bat.Standard/Zoom Scan (5x5x7)/Cube 0:** Measurement grid:

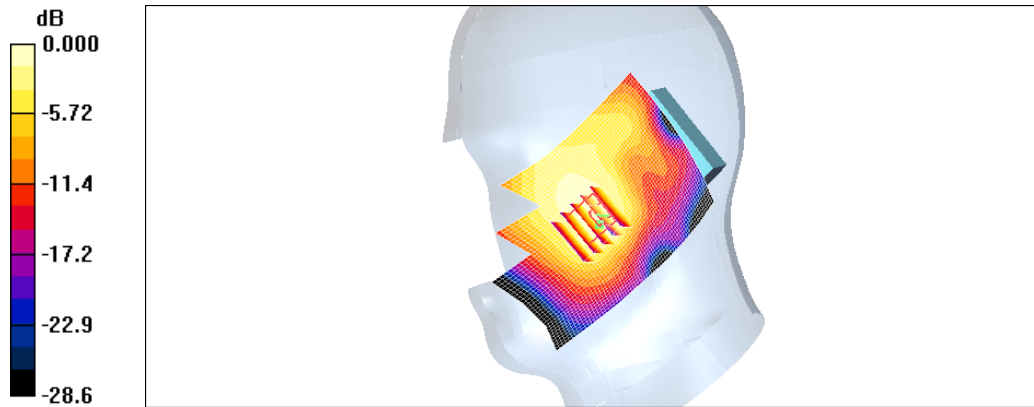
dx=8mm, dy=8mm, dz=5mm

Reference Value = 7.02 V/m; Power Drift = 0.197 dB

Peak SAR (extrapolated) = 0.152 W/kg

**SAR(1 g) = 0.088 mW/g; SAR(10 g) = 0.050 mW/g**

Maximum value of SAR (measured) = 0.094 mW/g



0 dB = 0.094mW/g

**DUT: GT-B6520L; Serial: FH-154-C**

**Program Name: GT-B6520L WLAN Right(Job No. : FH-154)**

**Procedure Name: Tilted, Ch.06, Ant.Intenna, Bat.Standard**

**Meas. Ambient Temp(celsius)-22.7,Tissue Temp(celsius)-22.6;Test Date-16/Jul/2010**

Communication System: WLAN; Frequency: 2437 MHz;Duty Cycle: 1:1

Medium parameters used:  $f = 2437$  MHz;  $\sigma = 1.82$  mho/m;  $\epsilon_r = 38.3$ ;  $\rho = 1000$  kg/m<sup>3</sup>

Phantom section: Right Section

DASY4 Configuration:

- Probe: ES3DV3 - SN3080; ConvF(4.38, 4.38, 4.38); Calibrated: 2010-01-27
- Sensor-Surface: 4mm (Mechanical Surface Detection)
- Electronics: DAE4 Sn468; Calibrated: 2010-05-19
- Phantom: PHANTOM #1; Type: SAM; Serial: TP-1143
- Measurement SW: DASY4, V4.7 Build 80; Postprocessing SW: SEMCAD, V1.8 Build 184

**Tilted, Ch.06, Ant.Intenna, Bat.Standard/Area Scan (51x71x1):** Measurement grid:

dx=20mm, dy=20mm

Maximum value of SAR (interpolated) = 0.049 mW/g

**Tilted, Ch.06, Ant.Intenna, Bat.Standard/Zoom Scan (5x5x7)/Cube 0:** Measurement grid:

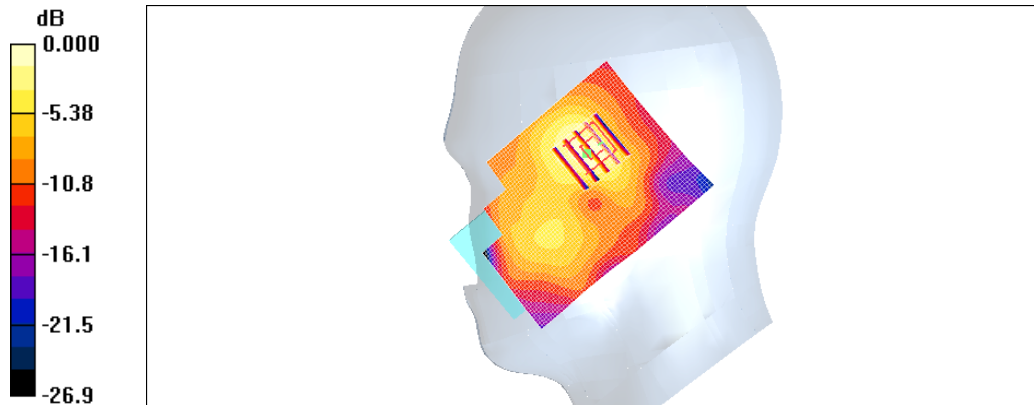
dx=8mm, dy=8mm, dz=5mm

Reference Value = 3.16 V/m; Power Drift = -0.089 dB

Peak SAR (extrapolated) = 0.089 W/kg

**SAR(1 g) = 0.047 mW/g; SAR(10 g) = 0.023 mW/g**

Maximum value of SAR (measured) = 0.050 mW/g



0 dB = 0.050mW/g

**DUT: GT-B6520L; Serial: FH-154-C**

**Program Name: GT-B6520L WLAN Left(Job No. : FH-154)**

**Procedure Name: Cheek, Ch.06, Ant.Intenna, Bat.Standard**

**Meas. Ambient Temp(celsius)-22.7,Tissue Temp(celsius)-22.6;Test Date-16/Jul/2010**

Communication System: WLAN; Frequency: 2437 MHz;Duty Cycle: 1:1

Medium parameters used:  $f = 2437$  MHz;  $\sigma = 1.82$  mho/m;  $\epsilon_r = 38.3$ ;  $\rho = 1000$  kg/m<sup>3</sup>

Phantom section: Left Section

DASY4 Configuration:

- Probe: ES3DV3 - SN3080; ConvF(4.38, 4.38, 4.38); Calibrated: 2010-01-27
- Sensor-Surface: 4mm (Mechanical Surface Detection)
- Electronics: DAE4 Sn468; Calibrated: 2010-05-19
- Phantom: PHANTOM #1; Type: SAM; Serial: TP-1143
- Measurement SW: DASY4, V4.7 Build 80; Postprocessing SW: SEMCAD, V1.8 Build 184

**Cheek, Ch.06, Ant.Intenna, Bat.Standard/Area Scan (51x71x1):** Measurement grid:

dx=20mm, dy=20mm

Maximum value of SAR (interpolated) = 0.168 mW/g

**Cheek, Ch.06, Ant.Intenna, Bat.Standard/Zoom Scan (5x5x7)/Cube 0:** Measurement grid:

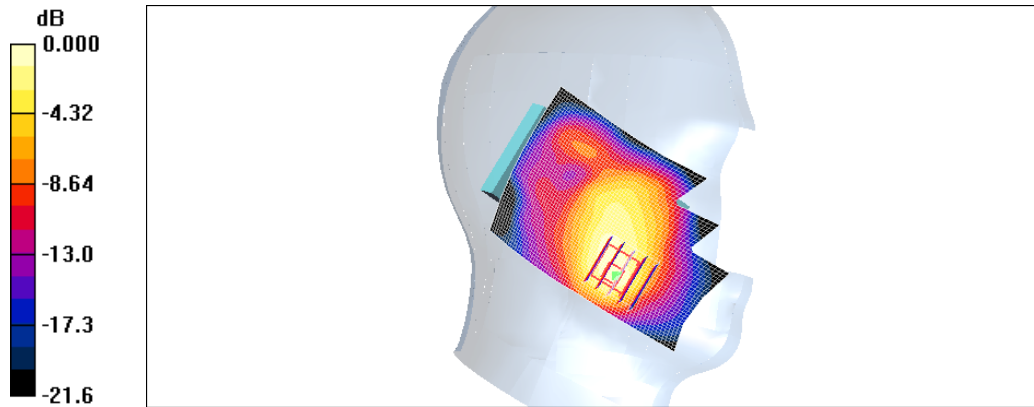
dx=8mm, dy=8mm, dz=5mm

Reference Value = 8.04 V/m; Power Drift = -0.148 dB

Peak SAR (extrapolated) = 0.302 W/kg

SAR(1 g) = 0.155 mW/g; SAR(10 g) = 0.078 mW/g

Maximum value of SAR (measured) = 0.170 mW/g



0 dB = 0.170mW/g

**DUT: GT-B6520L; Serial: FH-154-C**

**Program Name: GT-B6520L WLAN Left(Job No. : FH-154)**

**Procedure Name: Tilted, Ch.06, Ant.Intenna, Bat.Standard**

**Meas. Ambient Temp(celsius)-22.7,Tissue Temp(celsius)-22.6;Test Date-16/Jul/2010**

Communication System: WLAN; Frequency: 2437 MHz;Duty Cycle: 1:1

Medium parameters used:  $f = 2437$  MHz;  $\sigma = 1.82$  mho/m;  $\epsilon_r = 38.3$ ;  $\rho = 1000$  kg/m<sup>3</sup>

Phantom section: Left Section

DASY4 Configuration:

- Probe: ES3DV3 - SN3080; ConvF(4.38, 4.38, 4.38); Calibrated: 2010-01-27
- Sensor-Surface: 4mm (Mechanical Surface Detection)
- Electronics: DAE4 Sn468; Calibrated: 2010-05-19
- Phantom: PHANTOM #1; Type: SAM; Serial: TP-1143
- Measurement SW: DASY4, V4.7 Build 80; Postprocessing SW: SEMCAD, V1.8 Build 184

**Tilted, Ch.06, Ant.Intenna, Bat.Standard/Area Scan (51x71x1):** Measurement grid:

dx=20mm, dy=20mm

Maximum value of SAR (interpolated) = 0.024 mW/g

**Tilted, Ch.06, Ant.Intenna, Bat.Standard/Zoom Scan (5x5x7)/Cube 0:** Measurement grid:

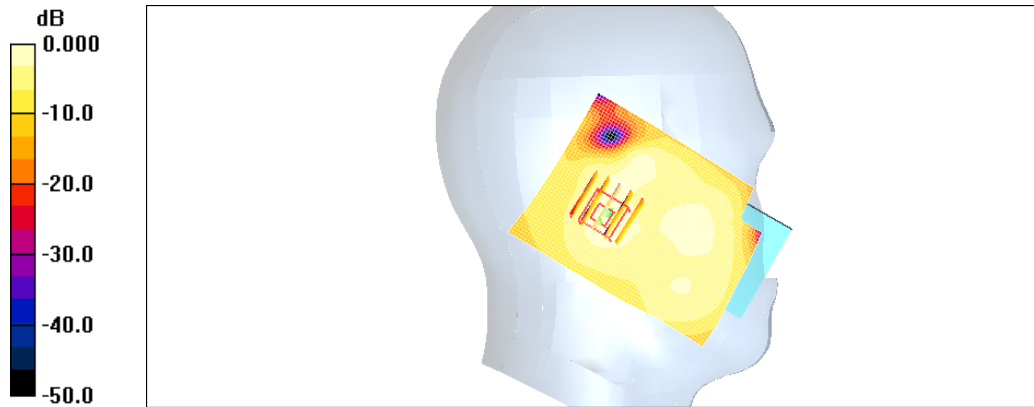
dx=8mm, dy=8mm, dz=5mm

Reference Value = 3.09 V/m; Power Drift = -0.079 dB

Peak SAR (extrapolated) = 0.043 W/kg

**SAR(1 g) = 0.023 mW/g; SAR(10 g) = 0.012 mW/g**

Maximum value of SAR (measured) = 0.025 mW/g



0 dB = 0.025mW/g

**DUT: GT-B6520L; Serial: FH-154-C**

**Program Name: GT-B6520L WLAN Left(Job No. : FH-154)**

**Procedure Name: Cheek, Ch.06, Ant.Intenna, Bat.Standard**

**Meas. Ambient Temp(celsius)-22.7,Tissue Temp(celsius)-22.6;Test Date-16/Jul/2010**

Communication System: WLAN; Frequency: 2437 MHz;Duty Cycle: 1:1

Medium parameters used:  $f = 2437$  MHz;  $\sigma = 1.82$  mho/m;  $\epsilon_r = 38.3$ ;  $\rho = 1000$  kg/m<sup>3</sup>

Phantom section: Left Section

DASY4 Configuration:

- Probe: ES3DV3 - SN3080; ConvF(4.38, 4.38, 4.38); Calibrated: 2010-01-27
- Sensor-Surface: 4mm (Mechanical Surface Detection)
- Electronics: DAE4 Sn468; Calibrated: 2010-05-19
- Phantom: PHANTOM #1; Type: SAM; Serial: TP-1143
- Measurement SW: DASY4, V4.7 Build 80; Postprocessing SW: SEMCAD, V1.8 Build 184

**Cheek, Ch.06, Ant.Intenna, Bat.Standard/Area Scan (51x71x1):** Measurement grid:

dx=20mm, dy=20mm

Maximum value of SAR (interpolated) = 0.168 mW/g

**Cheek, Ch.06, Ant.Intenna, Bat.Standard/Zoom Scan (5x5x7)/Cube 0:** Measurement grid:

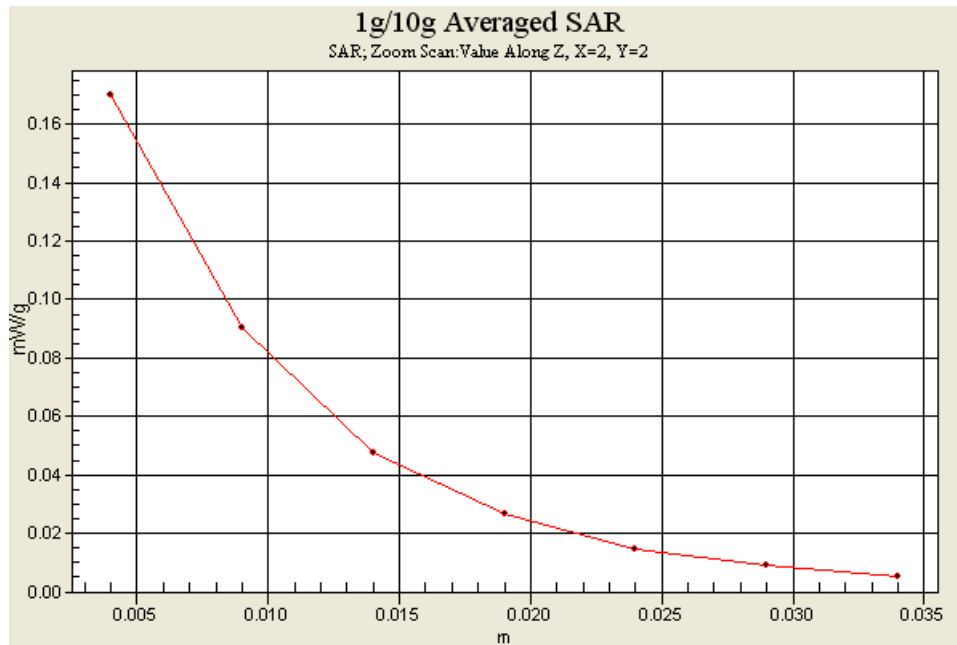
dx=8mm, dy=8mm, dz=5mm

Reference Value = 8.04 V/m; Power Drift = -0.148 dB

Peak SAR (extrapolated) = 0.302 W/kg

SAR(1 g) = 0.155 mW/g; SAR(10 g) = 0.078 mW/g

Maximum value of SAR (measured) = 0.170 mW/g



**DUT: GT-B6520L; Serial: FH-154-C**

**Program Name: GT-B6520L WLAN Body (Job No. : FH-154)**

**Procedure Name: Body, Ch.01, Ant.Intenna, Bat.Standard**

**Meas. Ambient Temp(celsius)-22.5,Tissue Temp(celsius)-22.2;Test Date-16/Jul/2010**

Communication System: WLAN; Frequency: 2412 MHz;Duty Cycle: 1:1

Medium parameters used:  $f = 2412$  MHz;  $\sigma = 1.93$  mho/m;  $\epsilon_r = 53.4$ ;  $\rho = 1000$  kg/m<sup>3</sup>

Phantom section: Center Section

DASY4 Configuration:

- Probe: ES3DV3 - SN3080; ConvF(4.2, 4.2, 4.2); Calibrated: 2010-01-27
- Sensor-Surface: 4mm (Mechanical Surface Detection)
- Electronics: DAE4 Sn468; Calibrated: 2010-05-19
- Phantom: Triple Flat Phantom 5.1; Type: Triple Flat Phantom 5.1; Serial: 1001
- Measurement SW: DASY4, V4.7 Build 80; Postprocessing SW: SEMCAD, V1.8 Build 184

**Body, Ch.01, Ant.Intenna, Bat.Standard/Area Scan (61x81x1):** Measurement grid:

dx=15mm, dy=15mm

Maximum value of SAR (interpolated) = 0.066 mW/g

**Body, Ch.01, Ant.Intenna, Bat.Standard/Zoom Scan (5x5x7)/Cube 0:** Measurement grid:

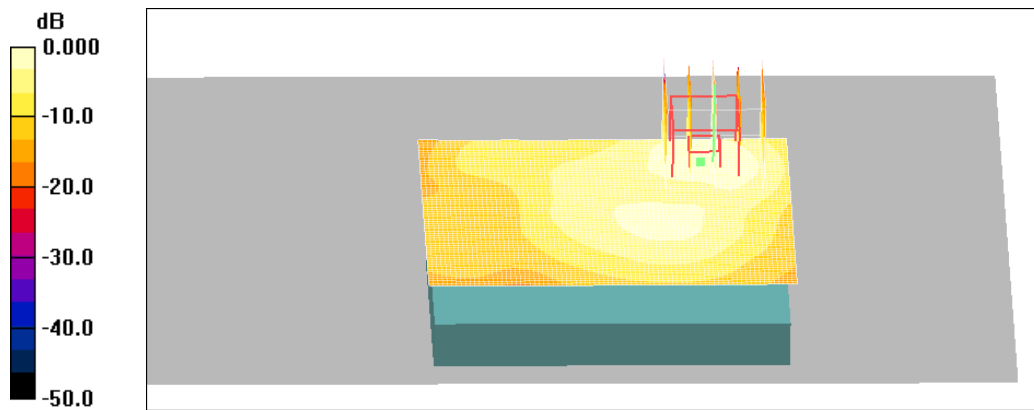
dx=8mm, dy=8mm, dz=5mm

Reference Value = 2.64 V/m; Power Drift = -0.030 dB

Peak SAR (extrapolated) = 0.114 W/kg

**SAR(1 g) = 0.061 mW/g; SAR(10 g) = 0.031 mW/g**

Maximum value of SAR (measured) = 0.065 mW/g



0 dB = 0.065mW/g

**DUT: GT-B6520L; Serial: FH-154-C**

**Program Name: GT-B6520L WLAN Body (Job No. : FH-154)**

**Procedure Name: Body, Ch.01, Ant.Intenna, Bat.Standard**

**Meas. Ambient Temp(celsius)-22.5,Tissue Temp(celsius)-22.2;Test Date-16/Jul/2010**

Communication System: WLAN; Frequency: 2412 MHz;Duty Cycle: 1:1

Medium parameters used:  $f = 2412$  MHz;  $\sigma = 1.93$  mho/m;  $\epsilon_r = 53.4$ ;  $\rho = 1000$  kg/m<sup>3</sup>

Phantom section: Center Section

DASY4 Configuration:

- Probe: ES3DV3 - SN3080; ConvF(4.2, 4.2, 4.2); Calibrated: 2010-01-27
- Sensor-Surface: 4mm (Mechanical Surface Detection)
- Electronics: DAE4 Sn468; Calibrated: 2010-05-19
- Phantom: Triple Flat Phantom 5.1; Type: Triple Flat Phantom 5.1; Serial: 1001
- Measurement SW: DASY4, V4.7 Build 80; Postprocessing SW: SEMCAD, V1.8 Build 184

**Body, Ch.01, Ant.Intenna, Bat.Standard/Area Scan (61x81x1):** Measurement grid:

dx=15mm, dy=15mm

Maximum value of SAR (interpolated) = 0.066 mW/g

**Body, Ch.01, Ant.Intenna, Bat.Standard/Zoom Scan (5x5x7)/Cube 0:** Measurement grid:

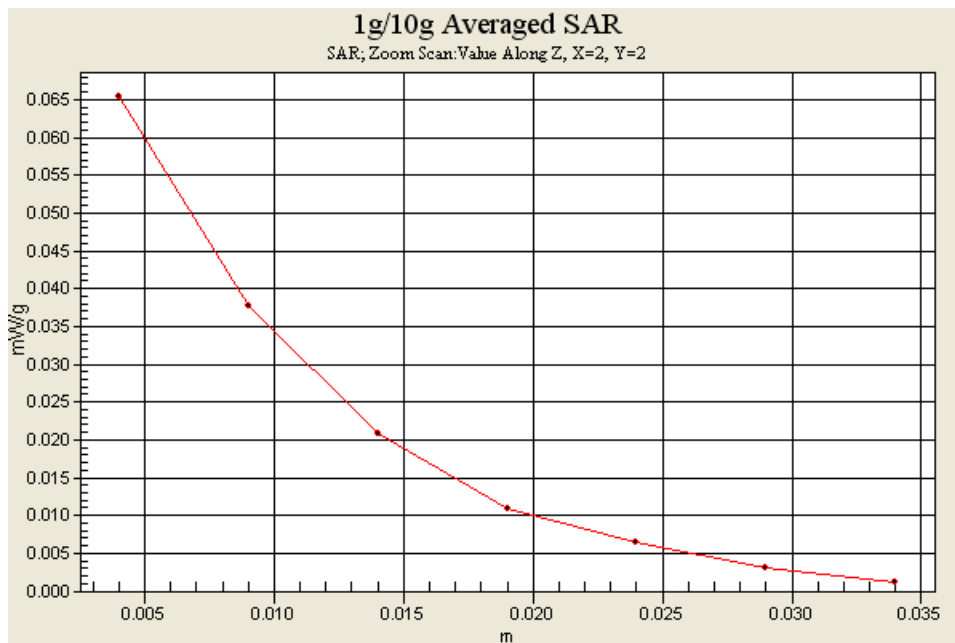
dx=8mm, dy=8mm, dz=5mm

Reference Value = 2.64 V/m; Power Drift = -0.030 dB

Peak SAR (extrapolated) = 0.114 W/kg

**SAR(1 g) = 0.061 mW/g; SAR(10 g) = 0.031 mW/g**

Maximum value of SAR (measured) = 0.065 mW/g



## **APPENDIX F**

### **Probe Calibration**



Accredited by the Swiss Accreditation Service (SAS)  
The Swiss Accreditation Service is one of the signatories to the EA  
Multilateral Agreement for the recognition of calibration certificates

Accreditation No.: SCS 108

Client **Samsung (Dymstec)**

Certificate No: **ES3-3080\_Jan10**

## CALIBRATION CERTIFICATE

Object **ES3DV3 - SN:3080**

Calibration procedure(s) **QA CAL-01.v6, QA CAL-23.v3 and QA CAL-25.v2  
Calibration procedure for dosimetric E-field probes**

Calibration date: **January 27, 2010**

This calibration certificate documents the traceability to national standards, which realize the physical units of measurements (SI).  
The measurements and the uncertainties with confidence probability are given on the following pages and are part of the certificate.

All calibrations have been conducted in the closed laboratory facility: environment temperature  $(22 \pm 3)^\circ\text{C}$  and humidity  $< 70\%$ .

Calibration Equipment used (M&TE critical for calibration)

Primary Standards	ID #	Cal Date (Certificate No.)	Scheduled Calibration
Power meter E4419B	GB41293874	1-Apr-09 (No. 217-01030)	Apr-10
Power sensor E4412A	MY41495277	1-Apr-09 (No. 217-01030)	Apr-10
Power sensor E4412A	MY41498087	1-Apr-09 (No. 217-01030)	Apr-10
Reference 3 dB Attenuator	SN: S5054 (3c)	31-Mar-09 (No. 217-01026)	Mar-10
Reference 20 dB Attenuator	SN: S5086 (20b)	31-Mar-09 (No. 217-01028)	Mar-10
Reference 30 dB Attenuator	SN: S5129 (30b)	31-Mar-09 (No. 217-01027)	Mar-10
Reference Probe ES3DV2	SN: 3013	30-Dec-09 (No. ES3-3013_Dec09)	Dec-10
DAE4	SN: 660	29-Sep-09 (No. DAE4-660_Sep09)	Sep-10
Secondary Standards	ID #	Check Date (in house)	Scheduled Check
RF generator HP 8648C	US3642U01700	4-Aug-99 (in house check Oct-09)	In house check: Oct-11
Network Analyzer HP 8753E	US37390585	18-Oct-01 (in house check Oct-09)	In house check: Oct10

	Name	Function	Signature
Calibrated by:	<b>Jeton Kastrati</b>	<b>Laboratory Technician</b>	
Approved by:	<b>Katja Pokovic</b>	<b>Technical Manager</b>	

Issued: January 27, 2010

This calibration certificate shall not be reproduced except in full without written approval of the laboratory.

2010.1.18



Accredited by the Swiss Accreditation Service (SAS)

The Swiss Accreditation Service is one of the signatories to the EA  
Multilateral Agreement for the recognition of calibration certificates

Accreditation No.: SCS 108

### Glossary:

TSL	tissue simulating liquid
NORM <sub>x,y,z</sub>	sensitivity in free space
ConvF	sensitivity in TSL / NORM <sub>x,y,z</sub>
DCP	diode compression point
CF	crest factor (1/duty_cycle) of the RF signal
A, B, C	modulation dependent linearization parameters
Polarization $\varphi$	$\varphi$ rotation around probe axis
Polarization $\vartheta$	$\vartheta$ rotation around an axis that is in the plane normal to probe axis (at measurement center), i.e., $\vartheta = 0$ is normal to probe axis

### Calibration is Performed According to the Following Standards:

- IEEE Std 1528-2003, "IEEE Recommended Practice for Determining the Peak Spatial-Averaged Specific Absorption Rate (SAR) in the Human Head from Wireless Communications Devices: Measurement Techniques", December 2003
- IEC 62209-1, "Procedure to measure the Specific Absorption Rate (SAR) for hand-held devices used in close proximity to the ear (frequency range of 300 MHz to 3 GHz)", February 2005

### Methods Applied and Interpretation of Parameters:

- NORM<sub>x,y,z</sub>:** Assessed for E-field polarization  $\vartheta = 0$  ( $f \leq 900$  MHz in TEM-cell;  $f > 1800$  MHz: R22 waveguide). NORM<sub>x,y,z</sub> are only intermediate values, i.e., the uncertainties of NORM<sub>x,y,z</sub> does not effect the E<sup>2</sup>-field uncertainty inside TSL (see below ConvF).
- NORM(f)<sub>x,y,z</sub> = NORM<sub>x,y,z</sub> \* frequency\_response** (see Frequency Response Chart). This linearization is implemented in DASY4 software versions later than 4.2. The uncertainty of the frequency response is included in the stated uncertainty of ConvF.
- DCP<sub>x,y,z</sub>:** DCP are numerical linearization parameters assessed based on the data of power sweep with CW signal (no uncertainty required). DCP does not depend on frequency nor media.
- A<sub>x,y,z</sub>; B<sub>x,y,z</sub>; C<sub>x,y,z</sub>; VR<sub>x,y,z</sub>:** A, B, C are numerical linearization parameters assessed based on the data of power sweep for specific modulation signal. The parameters do not depend on frequency nor media. VR is the maximum calibration range expressed in RMS voltage across the diode.
- ConvF and Boundary Effect Parameters:** Assessed in flat phantom using E-field (or Temperature Transfer Standard for  $f \leq 800$  MHz) and inside waveguide using analytical field distributions based on power measurements for  $f > 800$  MHz. The same setups are used for assessment of the parameters applied for boundary compensation (alpha, depth) of which typical uncertainty values are given. These parameters are used in DASY4 software to improve probe accuracy close to the boundary. The sensitivity in TSL corresponds to NORM<sub>x,y,z</sub> \* ConvF whereby the uncertainty corresponds to that given for ConvF. A frequency dependent ConvF is used in DASY version 4.4 and higher which allows extending the validity from  $\pm 50$  MHz to  $\pm 100$  MHz.
- Spherical Isotropy (3D deviation from isotropy):** in a field of low gradients realized using a flat phantom exposed by a patch antenna.
- Sensor Offset:** The sensor offset corresponds to the offset of virtual measurement center from the probe tip (on probe axis). No tolerance required.

# Probe ES3DV3

## SN:3080

Manufactured:	March 14, 2005
Last calibrated:	January 20, 2009
Recalibrated:	January 27, 2010

Calibrated for DASY Systems

(Note: non-compatible with DASY2 system!)

**DASY - Parameters of Probe: ES3DV3 SN:3080****Basic Calibration Parameters**

	Sensor X	Sensor Y	Sensor Z	Unc (k=2)
Norm ( $\mu\text{V}/(\text{V}/\text{m})^2$ ) <sup>A</sup>	1.24	1.13	1.18	± 10.1%
DCP (mV) <sup>B</sup>	93.7	92.4	96.5	

**Modulation Calibration Parameters**

UID	Communication System Name	PAR		A dB	B dBuV	C	VR mV	Unc <sup>E</sup> (k=2)
10000	CW	0.00	X	0.00	0.00	1.00	300.0	± 1.5%
			Y	0.00	0.00	1.00	300.0	
			Z	0.00	0.00	1.00	300.0	

The reported uncertainty of measurement is stated as the standard uncertainty of measurement multiplied by the coverage factor k=2, which for a normal distribution corresponds to a coverage probability of approximately 95%.

<sup>A</sup> The uncertainties of NormX,Y,Z do not affect the E<sup>2</sup>-field uncertainty inside TSL (see Pages 5 and 6).

<sup>B</sup> Numerical linearization parameter: uncertainty not required.

<sup>E</sup> Uncertainty is determined using the maximum deviation from linear response applying rectangular distribution and is expressed for the square of the field value.

## DASY - Parameters of Probe: ES3DV3 SN:3080

### Calibration Parameter Determined in Head Tissue Simulating Media

f [MHz]	Validity [MHz] <sup>C</sup>	Permittivity	Conductivity	ConvF X	ConvF Y	ConvF Z	Alpha	Depth Unc (k=2)
850	± 50 / ± 100	41.5 ± 5%	0.90 ± 5%	5.77	5.77	5.77	0.99	1.10 ± 11.0%
1750	± 50 / ± 100	40.1 ± 5%	1.37 ± 5%	5.04	5.04	5.04	0.84	1.18 ± 11.0%
1900	± 50 / ± 100	40.0 ± 5%	1.40 ± 5%	4.87	4.87	4.87	0.52	1.50 ± 11.0%
2450	± 50 / ± 100	39.2 ± 5%	1.80 ± 5%	4.38	4.38	4.38	0.60	1.47 ± 11.0%

<sup>C</sup> The validity of ± 100 MHz only applies for DASY v4.4 and higher (see Page 2). The uncertainty is the RSS of the ConvF uncertainty at calibration frequency and the uncertainty for the indicated frequency band.

## DASY - Parameters of Probe: ES3DV3 SN:3080

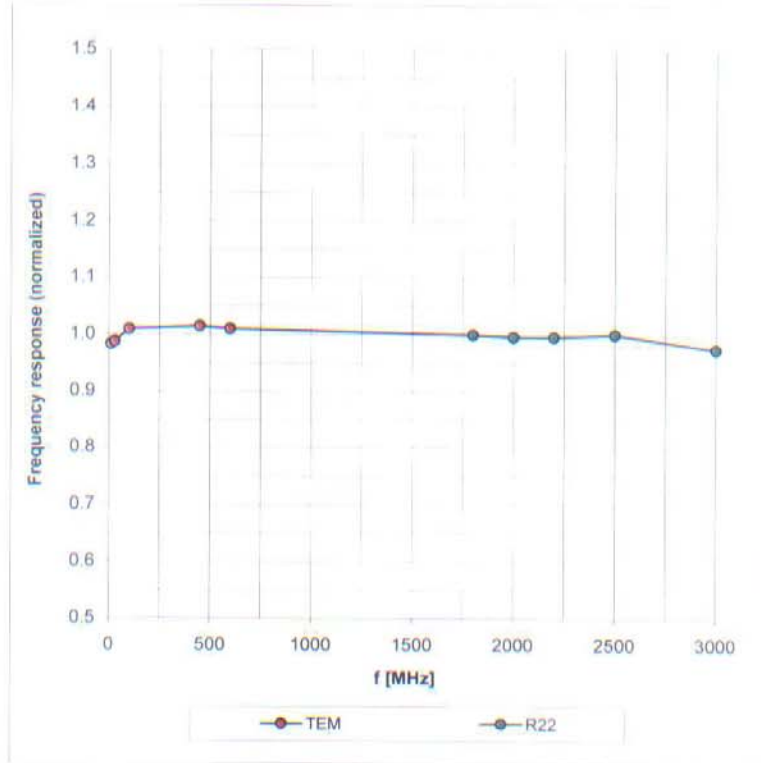
### Calibration Parameter Determined in Body Tissue Simulating Media

f [MHz]	Validity [MHz] <sup>c</sup>	Permittivity	Conductivity	ConvF X	ConvF Y	ConvF Z	Alpha	Depth Unc (k=2)
850	± 50 / ± 100	55.2 ± 5%	0.99 ± 5%	5.70	5.70	5.70	0.99	1.12 ± 11.0%
1750	± 50 / ± 100	53.4 ± 5%	1.49 ± 5%	4.85	4.85	4.85	0.60	1.50 ± 11.0%
1900	± 50 / ± 100	53.3 ± 5%	1.52 ± 5%	4.55	4.55	4.55	0.42	1.96 ± 11.0%
2450	± 50 / ± 100	52.7 ± 5%	1.95 ± 5%	4.20	4.20	4.20	0.99	1.12 ± 11.0%

<sup>c</sup> The validity of ± 100 MHz only applies for DASY v4.4 and higher (see Page 2). The uncertainty is the RSS of the ConvF uncertainty at calibration frequency and the uncertainty for the indicated frequency band.

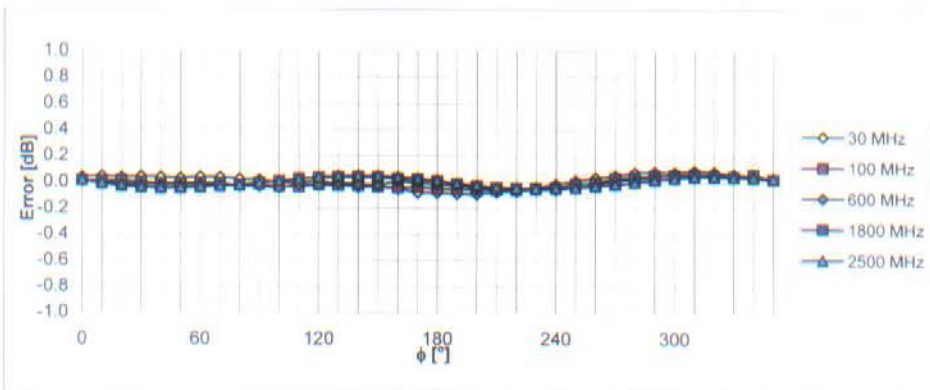
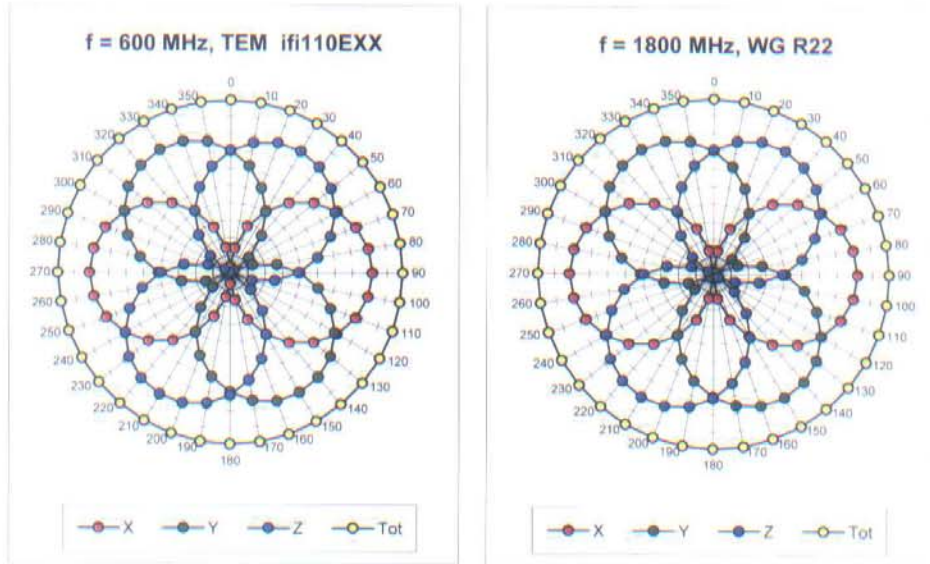
### Frequency Response of E-Field

(TEM-Cell: ifi110 EXX, Waveguide: R22)



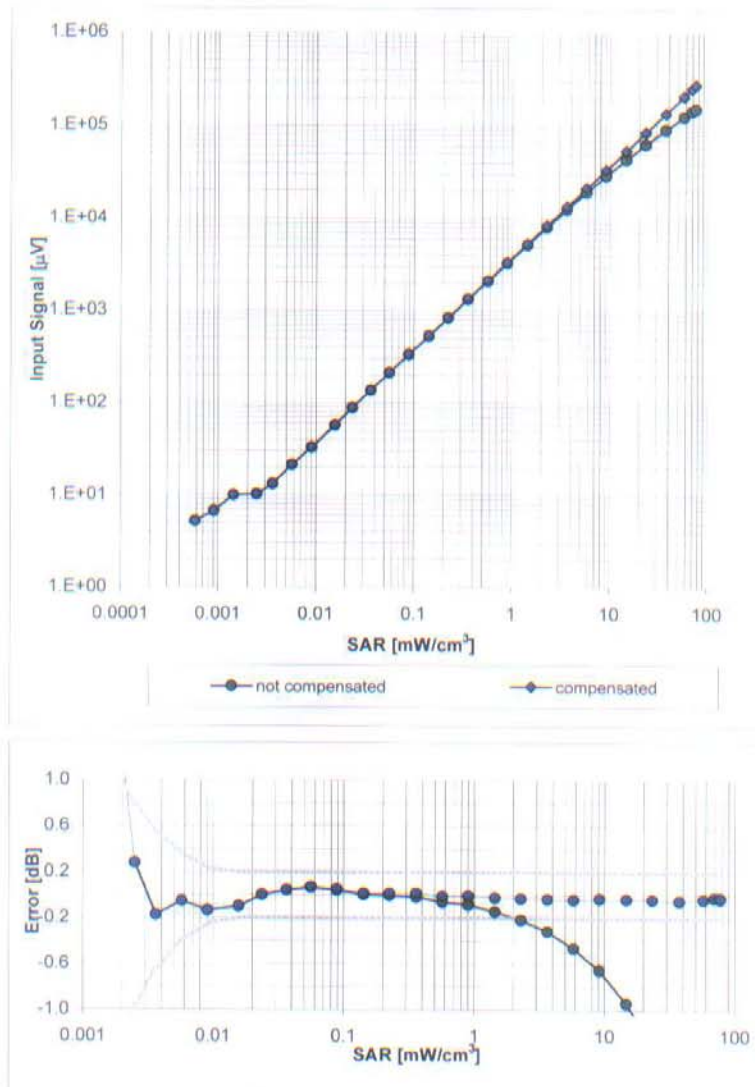
Uncertainty of Frequency Response of E-field:  $\pm 6.3\%$  (k=2)

### Receiving Pattern ( $\phi$ ), $\vartheta = 0^\circ$



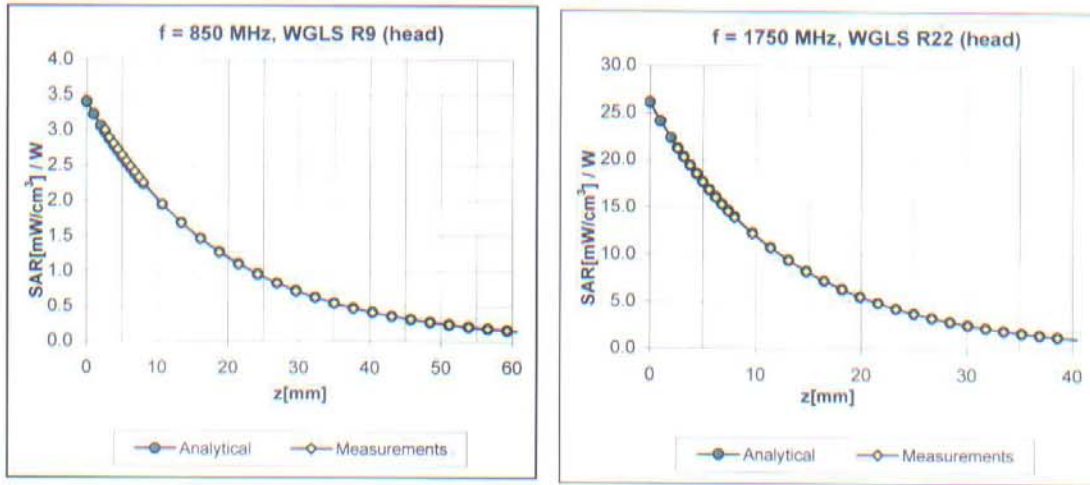
Uncertainty of Axial Isotropy Assessment:  $\pm 0.5\%$  ( $k=2$ )

### Dynamic Range $f(SAR_{head})$ (Waveguide R22, $f = 1800$ MHz)



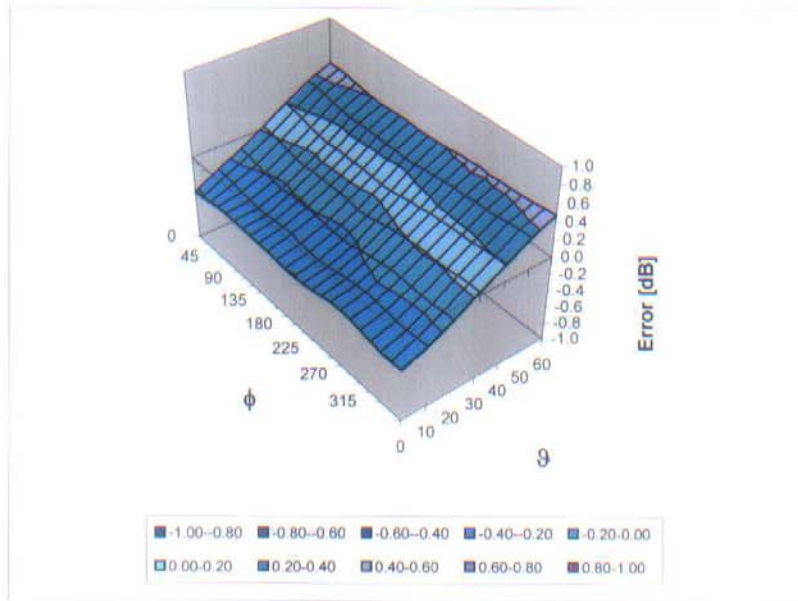
Uncertainty of Linearity Assessment:  $\pm 0.6\%$  ( $k=2$ )

### Conversion Factor Assessment



### Deviation from Isotropy in HSL

Error ( $\phi, \theta$ ), f = 900 MHz



Uncertainty of Spherical Isotropy Assessment:  $\pm 2.6\%$  (k=2)

## Other Probe Parameters

Sensor Arrangement	Triangular
Connector Angle (°)	Not applicable
Mechanical Surface Detection Mode	enabled
Optical Surface Detection Mode	disabled
Probe Overall Length	337 mm
Probe Body Diameter	10 mm
Tip Length	10 mm
Tip Diameter	4.0 mm
Probe Tip to Sensor X Calibration Point	2 mm
Probe Tip to Sensor Y Calibration Point	2 mm
Probe Tip to Sensor Z Calibration Point	2 mm
Recommended Measurement Distance from Surface	3 mm

## **APPENDIX G**

### **Calibration of The Validation Dipole**



Accredited by the Swiss Accreditation Service (SAS)  
The Swiss Accreditation Service is one of the signatories to the EA  
Multilateral Agreement for the recognition of calibration certificates

Accreditation No.: **SCS 108**

Client **Samsung (Dymstec)**

Certificate No: **D835V2-4d050\_Mar09**

## CALIBRATION CERTIFICATE

Object **D835V2 - SN: 4d050**

Calibration procedure(s) **QA CAL-05.v7  
Calibration procedure for dipole validation kits**

Calibration date: **March 16, 2009**

Condition of the calibrated item **In Tolerance**

This calibration certificate documents the traceability to national standards, which realize the physical units of measurements (SI).  
The measurements and the uncertainties with confidence probability are given on the following pages and are part of the certificate.

All calibrations have been conducted in the closed laboratory facility: environment temperature (22 ± 3)°C and humidity < 70%.

Calibration Equipment used (M&TE critical for calibration)

Primary Standards	ID #	Cal Date (Certificate No.)	Scheduled Calibration
Power meter EPM-442A	GB37480704	08-Oct-08 (No. 217-00898)	Oct-09
Power sensor HP 8481A	US37292783	08-Oct-08 (No. 217-00898)	Oct-09
Reference 20 dB Attenuator	SN: 5086 (20g)	01-Jul-08 (No. 217-00864)	Jul-09
Type-N mismatch combination	SN: 5047.2 / 06327	01-Jul-08 (No. 217-00867)	Jul-09
Reference Probe ES3DV2	SN: 3025	28-Apr-08 (No. ES3-3025_Apr08)	Apr-09
DAE4	SN: 601	07-Mar-09 (No. DAE4-601_Mar09)	Mar-10
Secondary Standards	ID #	Check Date (in house)	Scheduled Check
Power sensor HP 8481A	MY41092317	18-Oct-02 (in house check Oct-07)	In house check: Oct-09
RF generator R&S SMT-06	100005	4-Aug-99 (in house check Oct-07)	In house check: Oct-09
Network Analyzer HP 8753E	US37390585 S4206	18-Oct-01 (in house check Oct-08)	In house check: Oct-09

	Name	Function	Signature
Calibrated by:	Jeton Kastrati	Laboratory Technician	
Approved by:	Katja Pokovic	Technical Manager	

Issued: March 17, 2009

This calibration certificate shall not be reproduced except in full without written approval of the laboratory.

2009.4.8



Accredited by the Swiss Accreditation Service (SAS)  
The Swiss Accreditation Service is one of the signatories to the EA  
Multilateral Agreement for the recognition of calibration certificates

Accreditation No.: **SCS 108**

**Glossary:**

TSL	tissue simulating liquid
ConvF	sensitivity in TSL / NORM x,y,z
N/A	not applicable or not measured

**Calibration is Performed According to the Following Standards:**

- IEEE Std 1528-2003, "IEEE Recommended Practice for Determining the Peak Spatial-Averaged Specific Absorption Rate (SAR) in the Human Head from Wireless Communications Devices: Measurement Techniques", December 2003
- IEC 62209-1, "Procedure to measure the Specific Absorption Rate (SAR) for hand-held devices used in close proximity to the ear (frequency range of 300 MHz to 3 GHz)", February 2005
- Federal Communications Commission Office of Engineering & Technology (FCC OET), "Evaluating Compliance with FCC Guidelines for Human Exposure to Radiofrequency Electromagnetic Fields; Additional Information for Evaluating Compliance of Mobile and Portable Devices with FCC Limits for Human Exposure to Radiofrequency Emissions", Supplement C (Edition 01-01) to Bulletin 65

**Additional Documentation:**

- DASY4/5 System Handbook

**Methods Applied and Interpretation of Parameters:**

- Measurement Conditions:* Further details are available from the Validation Report at the end of the certificate. All figures stated in the certificate are valid at the frequency indicated.
- Antenna Parameters with TSL:* The dipole is mounted with the spacer to position its feed point exactly below the center marking of the flat phantom section, with the arms oriented parallel to the body axis.
- Feed Point Impedance and Return Loss:* These parameters are measured with the dipole positioned under the liquid filled phantom. The impedance stated is transformed from the measurement at the SMA connector to the feed point. The Return Loss ensures low reflected power. No uncertainty required.
- Electrical Delay:* One-way delay between the SMA connector and the antenna feed point. No uncertainty required.
- SAR measured:* SAR measured at the stated antenna input power.
- SAR normalized:* SAR as measured, normalized to an input power of 1 W at the antenna connector.
- SAR for nominal TSL parameters:* The measured TSL parameters are used to calculate the nominal SAR result.

## Measurement Conditions

DASY system configuration, as far as not given on page 1.

DASY Version	DASY5	V5.0
Extrapolation	Advanced Extrapolation	
Phantom	Modular Flat Phantom V4.9	
Distance Dipole Center - TSL	15 mm	with Spacer
Zoom Scan Resolution	dx, dy, dz = 5 mm	
Frequency	835 MHz $\pm$ 1 MHz	

## Head TSL parameters

The following parameters and calculations were applied.

	Temperature	Permittivity	Conductivity
Nominal Head TSL parameters	22.0 °C	41.5	0.90 mho/m
Measured Head TSL parameters	(22.0 $\pm$ 0.2) °C	40.3 $\pm$ 6 %	0.87 mho/m $\pm$ 6 %
Head TSL temperature during test	(21.5 $\pm$ 0.2) °C	---	---

## SAR result with Head TSL

SAR averaged over 1 cm <sup>3</sup> (1 g) of Head TSL	Condition	
SAR measured	250 mW input power	2.33 mW / g
SAR normalized	normalized to 1W	9.32 mW / g
SAR for nominal Head TSL parameters <sup>1</sup>	normalized to 1W	<b>9.49 mW / g <math>\pm</math> 17.0 % (k=2)</b>

SAR averaged over 10 cm <sup>3</sup> (10 g) of Head TSL	condition	
SAR measured	250 mW input power	1.53 mW / g
SAR normalized	normalized to 1W	6.12 mW / g
SAR for nominal Head TSL parameters <sup>1</sup>	normalized to 1W	<b>6.21 mW / g <math>\pm</math> 16.5 % (k=2)</b>

<sup>1</sup> Correction to nominal TSL parameters according to d), chapter "SAR Sensitivities"

## Appendix

### Antenna Parameters with Head TSL

Impedance, transformed to feed point	51.5 $\Omega$ - 4.5 j $\Omega$
Return Loss	- 26.7 dB

### General Antenna Parameters and Design

Electrical Delay (one direction)	1.387 ns
----------------------------------	----------

After long term use with 100W radiated power, only a slight warming of the dipole near the feedpoint can be measured.

The dipole is made of standard semirigid coaxial cable. The center conductor of the feeding line is directly connected to the second arm of the dipole. The antenna is therefore short-circuited for DC-signals.

No excessive force must be applied to the dipole arms, because they might bend or the soldered connections near the feedpoint may be damaged.

### Additional EUT Data

Manufactured by	SPEAG
Manufactured on	August 16, 2006

## DASY5 Validation Report for Head TSL

Date/Time: 16.03.2009 11:58:06

Test Laboratory: SPEAG, Zurich, Switzerland

**DUT: Dipole 835 MHz; Type: D835V2; Serial: D835V2 - SN:4d050**

Communication System: CW-835; Frequency: 835 MHz; Duty Cycle: 1:1

Medium: HSL 900 MHz

Medium parameters used:  $f = 835$  MHz;  $\sigma = 0.87$  mho/m;  $\epsilon_r = 40.1$ ;  $\rho = 1000$  kg/m<sup>3</sup>

Phantom section: Flat Section

Measurement Standard: DASY5 (IEEE/IEC)

DASY5 Configuration:

- Probe: ES3DV2 - SN3025; ConvF(5.97, 5.97, 5.97); Calibrated: 28.04.2008
- Sensor-Surface: 3.4mm (Mechanical Surface Detection)
- Electronics: DAE4 Sn601; Calibrated: 07.03.2009
- Phantom: Flat Phantom 4.9L; Type: QD000P49AA; Serial: 1001
- Measurement SW: DASY5, V5.0 Build 120; SEMCAD X Version 13.4 Build 45

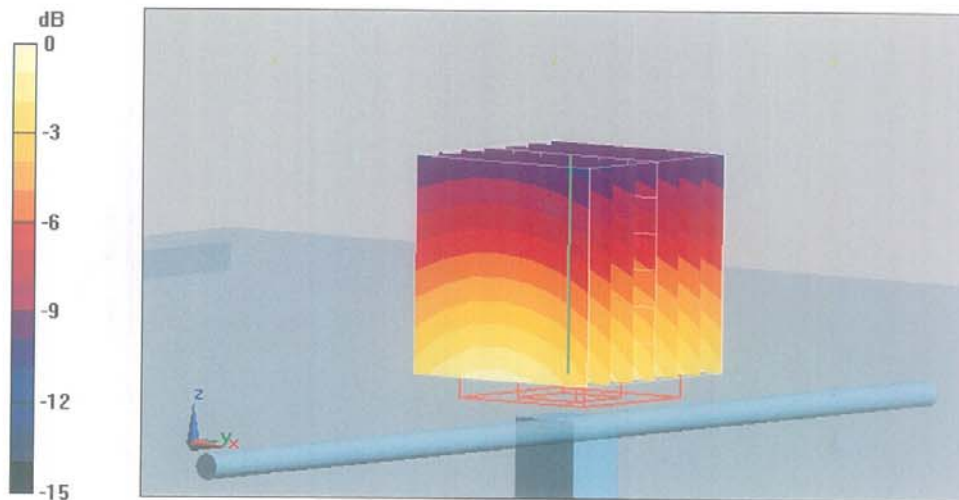
**Pin=250mW; dip=15mm; dist=3.4mm/Zoom Scan (7x7x7)/Cube 0:** Measurement grid:  
dx=5mm, dy=5mm, dz=5mm

Reference Value = 56.4 V/m; Power Drift = -0.032 dB

Peak SAR (extrapolated) = 3.41 W/kg

**SAR(1 g) = 2.33 mW/g; SAR(10 g) = 1.53 mW/g**

Maximum value of SAR (measured) = 2.63 mW/g

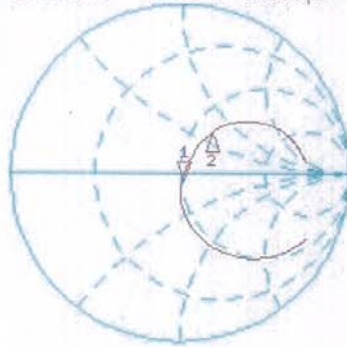


0 dB = 2.63mW/g

# Impedance Measurement Plot for Head TSL

16 Mar 2009 11:19:34  
 CH1 S11 1 U FS 1: 51.510  $\Omega$  -4.4707  $\Omega$  42.634 pF 835.000 000 MHz

\*  
 Del  
 Cor



CH1 Markers  
 2: 63.172  $\Omega$   
 30.328  $\Omega$   
 900.000 MHz

Avg  
 16

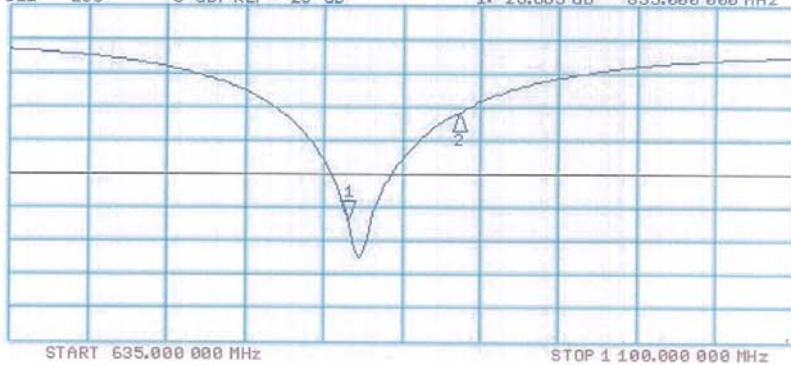
↑

CH2 S11 L06 5 dB/REF -20 dB 1: -26.665 dB 835.000 000 MHz

Cor

Avg  
 16

↑



CH2 Markers  
 2: -10.988 dB  
 900.000 MHz

START 635.000 000 MHz

STOP 1 100.000 000 MHz



Accredited by the Swiss Accreditation Service (SAS)  
The Swiss Accreditation Service is one of the signatories to the EA  
Multilateral Agreement for the recognition of calibration certificates

Accreditation No.: SCS 108

Client **Samsung (Dymstec)**

Certificate No: **D1900V2-5d082-Mar09**

## CALIBRATION CERTIFICATE

Object: **D1900V2 - SN: 5d082**

Calibration procedure(s): **QA CAL-05.v7  
Calibration procedure for dipole validation kits**

Calibration date: **March 17, 2009**

Condition of the calibrated item: **In Tolerance**

This calibration certificate documents the traceability to national standards, which realize the physical units of measurements (SI).  
The measurements and the uncertainties with confidence probability are given on the following pages and are part of the certificate.

All calibrations have been conducted in the closed laboratory facility: environment temperature (22 ± 3)°C and humidity < 70%.

Calibration Equipment used (M&TE critical for calibration)

Primary Standards	ID #	Cal Date (Calibrated by, Certificate No.)	Scheduled Calibration
Power meter EPM-442A	GB37480704	08-Oct-08 (No. 217-00898)	Oct-09
Power sensor HP 8481A	US37292783	08-Oct-08 (No. 217-00898)	Oct-09
Reference 20 dB Attenuator	SN: 5086 (20g)	01-Jul-08 (No. 217-00864)	Jul-09
Type-N mismatch combination	SN: 5047.2 / 06327	01-Jul-08 (No. 217-00867)	Jul-09
Reference Probe ES3DV2	SN: 3025	28-Apr-08 (No. ES3-3025_Apr08)	Apr-09
DAE4	SN: 601	07-Mar-09 (No. DAE4-601_Mar09)	Mar-10
Secondary Standards	ID #	Check Date (in house)	Scheduled Check
Power sensor HP 8481A	MY41092317	18-Oct-02 (in house check Oct-07)	In house check: Oct-09
RF generator R&S SMT-06	100005	4-Aug-99 (in house check Oct-07)	In house check: Oct-09
Network Analyzer HP 8753E	US37390585 S4206	18-Oct-01 (in house check Oct-08)	In house check: Oct-09

Calibrated by: **Claudio Leubler** (Name), **Laboratory Technician** (Function), *[Signature]* (Signature)

Approved by: **Katja Pokovic** (Name), **Technical Manager** (Function), *[Signature]* (Signature)

Issued: March 18, 2009

*[Handwritten Signature]*  
2009.5.11



**Glossary:**

TSL	tissue simulating liquid
ConvF	sensitivity in TSL / NORM x,y,z
N/A	not applicable or not measured

**Calibration is Performed According to the Following Standards:**

- a) IEEE Std 1528-2003, "IEEE Recommended Practice for Determining the Peak Spatial-Averaged Specific Absorption Rate (SAR) in the Human Head from Wireless Communications Devices: Measurement Techniques", December 2003
- b) CENELEC EN 50361, "Basic standard for the measurement of Specific Absorption Rate related to human exposure to electromagnetic fields from mobile phones (300 MHz - 3 GHz), July 2001
- c) Federal Communications Commission Office of Engineering & Technology (FCC OET), "Evaluating Compliance with FCC Guidelines for Human Exposure to Radiofrequency Electromagnetic Fields; Additional Information for Evaluating Compliance of Mobile and Portable Devices with FCC Limits for Human Exposure to Radiofrequency Emissions", Supplement C (Edition 01-01) to Bulletin 65

**Additional Documentation:**

- d) DASY4/5 System Handbook

**Methods Applied and Interpretation of Parameters:**

- *Measurement Conditions:* Further details are available from the Validation Report at the end of the certificate. All figures stated in the certificate are valid at the frequency indicated.
- *Antenna Parameters with TSL:* The dipole is mounted with the spacer to position its feed point exactly below the center marking of the flat phantom section, with the arms oriented parallel to the body axis.
- *Feed Point Impedance and Return Loss:* These parameters are measured with the dipole positioned under the liquid filled phantom. The impedance stated is transformed from the measurement at the SMA connector to the feed point. The Return Loss ensures low reflected power. No uncertainty required.
- *Electrical Delay:* One-way delay between the SMA connector and the antenna feed point. No uncertainty required.
- *SAR measured:* SAR measured at the stated antenna input power.
- *SAR normalized:* SAR as measured, normalized to an input power of 1 W at the antenna connector.
- *SAR for nominal TSL parameters:* The measured TSL parameters are used to calculate the nominal SAR result.

### Measurement Conditions

DASY system configuration, as far as not given on page 1.

DASY Version	DASY5	V5.0
Extrapolation	Advanced Extrapolation	
Phantom	Modular Flat Phantom V5.0	
Distance Dipole Center - TSL	10 mm	with Spacer
Zoom Scan Resolution	dx, dy, dz = 5 mm	
Frequency	1900 MHz ± 1 MHz	

### Head TSL parameters

The following parameters and calculations were applied.

	Temperature	Permittivity	Conductivity
Nominal Head TSL parameters	22.0 °C	40.0	1.40 mho/m
Measured Head TSL parameters	(22.0 ± 0.2) °C	38.8 ± 6 %	1.47 mho/m ± 6 %
Head TSL temperature during test	(21.5 ± 0.2) °C	----	----

### SAR result with Head TSL

SAR averaged over 1 cm <sup>3</sup> (1 g) of Head TSL	condition	
SAR measured	250 mW input power	10.2 mW / g
SAR normalized	normalized to 1W	40.8 mW / g
SAR for nominal Head TSL parameters <sup>1</sup>	normalized to 1W	<b>39.4 mW / g ± 17.0 % (k=2)</b>

SAR averaged over 10 cm <sup>3</sup> (10 g) of Head TSL	Condition	
SAR measured	250 mW input power	5.27 mW / g
SAR normalized	normalized to 1W	21.1 mW / g
SAR for nominal Head TSL parameters <sup>1</sup>	normalized to 1W	<b>20.7 mW / g ± 16.5 % (k=2)</b>

<sup>1</sup> Correction to nominal TSL parameters according to d), chapter "SAR Sensitivities"

## Appendix

### Antenna Parameters with Head TSL

Impedance, transformed to feed point	$52.9 \Omega + 4.5 j\Omega$
Return Loss	- 25.7 dB

### General Antenna Parameters and Design

Electrical Delay (one direction)	1.195 ns
----------------------------------	----------

After long term use with 100W radiated power, only a slight warming of the dipole near the feedpoint can be measured.

The dipole is made of standard semirigid coaxial cable. The center conductor of the feeding line is directly connected to the second arm of the dipole. The antenna is therefore short-circuited for DC-signals.

No excessive force must be applied to the dipole arms, because they might bend or the soldered connections near the feedpoint may be damaged.

### Additional EUT Data

Manufactured by	SPEAG
Manufactured on	June 28, 2006

## DASY5 Validation Report for Head TSL

Date/Time: 17.03.2009 14:52:19

Test Laboratory: SPEAG, Zurich, Switzerland

**DUT: Dipole 1900 MHz; Type: D1900V2; Serial: D1900V2 - SN:5d082**

Communication System: CW; Frequency: 1900 MHz; Duty Cycle: 1:1

Medium: HSL U10 BB

Medium parameters used:  $f = 1900$  MHz;  $\sigma = 1.47$  mho/m;  $\epsilon_r = 38.8$ ;  $\rho = 1000$  kg/m<sup>3</sup>

Phantom section: Flat Section

Measurement Standard: DASY5 (IEEE/IEC)

DASY5 Configuration:

- Probe: ES3DV2 - SN3025; ConvF(4.9, 4.9, 4.9); Calibrated: 28.04.2008
- Sensor-Surface: 3.4mm (Mechanical Surface Detection)
- Electronics: DAE4 Sn601; Calibrated: 07.03.2009
- Phantom: Flat Phantom 5.0 (front); Type: QD000P50AA; Serial: 1001
- Measurement SW: DASY5, V5.0 Build 120; SEMCAD X Version 13.4 Build 45

**Pin = 250 mW; dip = 10 mm, scan at 3.4mm/Zoom Scan (dist=3.4mm, probe 0deg)  
(7x7x7)/Cube 0:**

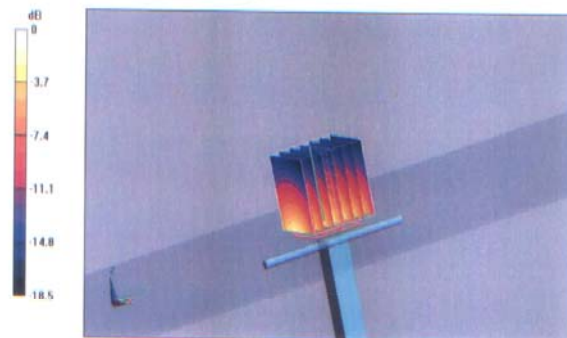
Measurement grid: dx=5mm, dy=5mm, dz=5mm

Reference Value = 91.3 V/m; Power Drift = 0.022 dB

Peak SAR (extrapolated) = 19.3 W/kg

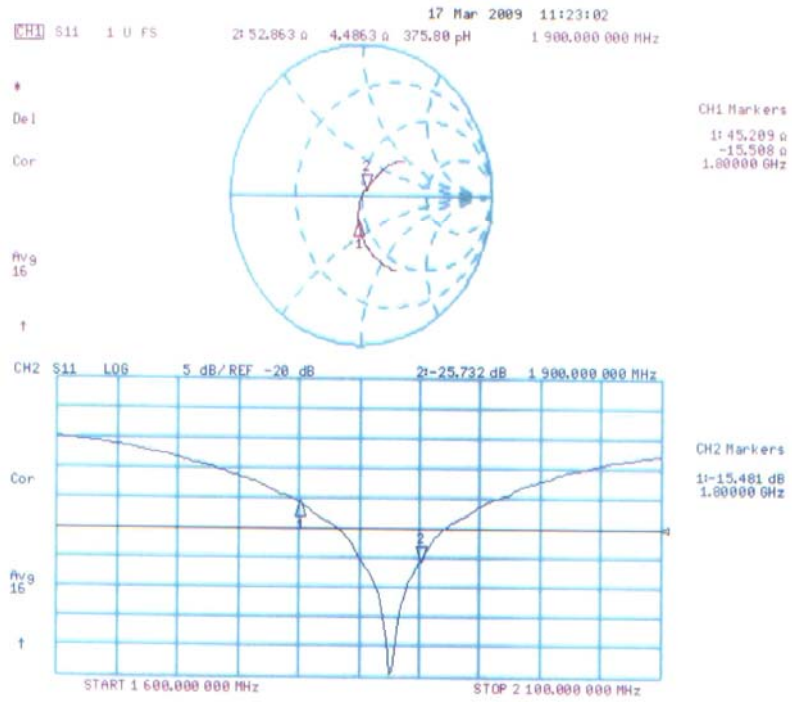
**SAR(1 g) = 10.2 mW/g; SAR(10 g) = 5.27 mW/g**

Maximum value of SAR (measured) = 12.2 mW/g



0 dB = 12.2mW/g

# Impedance Measurement Plot for Head TSL





Accredited by the Swiss Accreditation Service (SAS)  
The Swiss Accreditation Service is one of the signatories to the EA  
Multilateral Agreement for the recognition of calibration certificates

Accreditation No.: **SCS 108**

Client **Samsung (Dymstec)**

Certificate No: **D2450V2-708\_May10**

**CALIBRATION CERTIFICATE**

Object: **D2450V2 - SN: 708**

Calibration procedure(s): **QA CAL-05.v7  
Calibration procedure for dipole validation kits**

Calibration date: **May 25, 2010**

This calibration certificate documents the traceability to national standards, which realize the physical units of measurements (SI).  
The measurements and the uncertainties with confidence probability are given on the following pages and are part of the certificate.

All calibrations have been conducted in the closed laboratory facility: environment temperature (22 ± 3)°C and humidity < 70%.

Calibration Equipment used (M&TE critical for calibration)

Primary Standards	ID #	Cal Date (Certificate No.)	Scheduled Calibration
Power meter EPM-442A	GB37480704	06-Oct-09 (No. 217-01086)	Oct-10
Power sensor HP 8481A	US37292783	06-Oct-09 (No. 217-01086)	Oct-10
Reference 20 dB Attenuator	SN: 5086 (20g)	30-Mar-10 (No. 217-01158)	Mar-11
Type-N mismatch combination	SN: 5047.2 / 06327	30-Mar-10 (No. 217-01162)	Mar-11
Reference Probe ES3DV3	SN: 3205	30-Apr-10 (No. ES3-3205_Apr10)	Apr-11
DAE4	SN: 601	02-Mar-10 (No. DAE4-601_Mar10)	Mar-11

Secondary Standards	ID #	Check Date (in house)	Scheduled Check
Power sensor HP 8481A	MY41092317	18-Oct-02 (in house check Oct-09)	In house check: Oct-11
RF generator R&S SMT-06	100005	4-Aug-99 (in house check Oct-09)	In house check: Oct-11
Network Analyzer HP 8753E	US37390585 S4206	18-Oct-01 (in house check Oct-09)	In house check: Oct-10

Calibrated by:	Name	Function	Signature
	<b>Claudio Leubler</b>	<b>Laboratory Technician</b>	
Approved by:	<b>Katja Pokovic</b>	<b>Technical Manager</b>	

Issued: May 27, 2010

This calibration certificate shall not be reproduced except in full without written approval of the laboratory.



Accredited by the Swiss Accreditation Service (SAS)

The Swiss Accreditation Service is one of the signatories to the EA  
Multilateral Agreement for the recognition of calibration certificates

Accreditation No.: **SCS 108**

### Glossary:

TSL	tissue simulating liquid
ConvF	sensitivity in TSL / NORM x,y,z
N/A	not applicable or not measured

### Calibration is Performed According to the Following Standards:

- IEEE Std 1528-2003, "IEEE Recommended Practice for Determining the Peak Spatial-Averaged Specific Absorption Rate (SAR) in the Human Head from Wireless Communications Devices: Measurement Techniques", December 2003
- IEC 62209-1, "Procedure to measure the Specific Absorption Rate (SAR) for hand-held devices used in close proximity to the ear (frequency range of 300 MHz to 3 GHz)", February 2005
- Federal Communications Commission Office of Engineering & Technology (FCC OET), "Evaluating Compliance with FCC Guidelines for Human Exposure to Radiofrequency Electromagnetic Fields; Additional Information for Evaluating Compliance of Mobile and Portable Devices with FCC Limits for Human Exposure to Radiofrequency Emissions", Supplement C (Edition 01-01) to Bulletin 65

### Additional Documentation:

- DASY4/5 System Handbook

### Methods Applied and Interpretation of Parameters:

- Measurement Conditions:* Further details are available from the Validation Report at the end of the certificate. All figures stated in the certificate are valid at the frequency indicated.
- Antenna Parameters with TSL:* The dipole is mounted with the spacer to position its feed point exactly below the center marking of the flat phantom section, with the arms oriented parallel to the body axis.
- Feed Point Impedance and Return Loss:* These parameters are measured with the dipole positioned under the liquid filled phantom. The impedance stated is transformed from the measurement at the SMA connector to the feed point. The Return Loss ensures low reflected power. No uncertainty required.
- Electrical Delay:* One-way delay between the SMA connector and the antenna feed point. No uncertainty required.
- SAR measured:* SAR measured at the stated antenna input power.
- SAR normalized:* SAR as measured, normalized to an input power of 1 W at the antenna connector.
- SAR for nominal TSL parameters:* The measured TSL parameters are used to calculate the nominal SAR result.

## Measurement Conditions

DASY system configuration, as far as not given on page 1.

DASY Version	DASY5	V5.2
Extrapolation	Advanced Extrapolation	
Phantom	Modular Flat Phantom V4.9	
Distance Dipole Center - TSL	10 mm	with Spacer
Zoom Scan Resolution	dx, dy, dz = 5 mm	
Frequency	2450 MHz $\pm$ 1 MHz	

## Head TSL parameters

The following parameters and calculations were applied.

	Temperature	Permittivity	Conductivity
Nominal Head TSL parameters	22.0 °C	39.2	1.80 mho/m
Measured Head TSL parameters	(22.0 $\pm$ 0.2) °C	39.0 $\pm$ 6 %	1.76 mho/m $\pm$ 6 %
Head TSL temperature during test	(21.5 $\pm$ 0.2) °C	----	----

## SAR result with Head TSL

SAR averaged over 1 cm <sup>3</sup> (1 g) of Head TSL	Condition	
SAR measured	250 mW input power	12.9 mW / g
SAR normalized	normalized to 1W	51.6 mW / g
SAR for nominal Head TSL parameters	normalized to 1W	<b>52.1 mW / g <math>\pm</math> 17.0 % (k=2)</b>

SAR averaged over 10 cm <sup>3</sup> (10 g) of Head TSL	condition	
SAR measured	250 mW input power	6.05 mW / g
SAR normalized	normalized to 1W	24.2 mW / g
SAR for nominal Head TSL parameters	normalized to 1W	<b>24.3 mW / g <math>\pm</math> 16.5 % (k=2)</b>

## Appendix

### Antenna Parameters with Head TSL

Impedance, transformed to feed point	53.5 $\Omega$ - 2.9 $j\Omega$
Return Loss	- 27.1 dB

### General Antenna Parameters and Design

Electrical Delay (one direction)	1.161 ns
----------------------------------	----------

After long term use with 100W radiated power, only a slight warming of the dipole near the feedpoint can be measured.

The dipole is made of standard semirigid coaxial cable. The center conductor of the feeding line is directly connected to the second arm of the dipole. The antenna is therefore short-circuited for DC-signals. No excessive force must be applied to the dipole arms, because they might bend or the soldered connections near the feedpoint may be damaged.

### Additional EUT Data

Manufactured by	SPEAG
Manufactured on	July 05, 2002

## DASY5 Validation Report for Head TSL

Date/Time: 25.05.2010 14:22:09

Test Laboratory: SPEAG, Zurich, Switzerland

**DUT: Dipole 2450 MHz; Type: D2450V2; Serial: D2450V2 - SN:708**

Communication System: CW; Frequency: 2450 MHz; Duty Cycle: 1:1

Medium: HSL U11 BB

Medium parameters used:  $f = 2450$  MHz;  $\sigma = 1.76$  mho/m;  $\epsilon_r = 39$ ;  $\rho = 1000$  kg/m<sup>3</sup>

Phantom section: Flat Section

Measurement Standard: DASY5 (IEEE/IEC/ANSI C63.19-2007)

DASY5 Configuration:

- Probe: ES3DV3 - SN3205; ConvF(4.53, 4.53, 4.53); Calibrated: 30.04.2010
- Sensor-Surface: 3mm (Mechanical Surface Detection)
- Electronics: DAE4 Sn601; Calibrated: 02.03.2010
- Phantom: Flat Phantom 5.0 (front); Type: QD000P50AA; Serial: 1001
- Measurement SW: DASY5, V5.2 Build 162; SEMCAD X Version 14.0 Build 61

**Head/d=10mm, Pin=250 mW, dist=3.0mm (ES-Probe)/Zoom Scan (7x7x7) (7x7x7)/Cube 0:**

Measurement grid: dx=5mm, dy=5mm, dz=5mm

Reference Value = 101.9 V/m; Power Drift = 0.028 dB

Peak SAR (extrapolated) = 26.3 W/kg

**SAR(1 g) = 12.9 mW/g; SAR(10 g) = 6.05 mW/g**

Maximum value of SAR (measured) = 17 mW/g



0 dB = 17mW/g

# Impedance Measurement Plot for Head TSL

