

Nemko Korea Co., Ltd.

165-51, Yurim-ro, Cheoin-gu, Yongin-si, Gyeonggi-do, 17042, Republic of Korea
TEL:+82 31 330-1700 FAX:+82 31 322 2332

FCC RF Exposure

Project No. : NK-24-R-082	Dates of receipt : February 20, 2024
Applicant : Samsung Electronics Co., Ltd. 129, Samsung-ro, Yeongtong-gu, Suwon-si, Gyeonggi-do, 16677, Korea, Republic of	Dates of Issue : May 22, 2024 Test Site : Nemko Korea Co., Ltd.

FCC ID :	A3LEPQQ503
Applicant :	Samsung Electronics Co., Ltd.
Brand Name :	SAMSUNG

Model:	EP-QQ503
Additional Model(s):	EP-QQ505, EP-QQ506, EP-QQ507, EP-QQ508, EP-QQ509, EP-QQ500, EP-QQ501, EP-QQ502
EUT Type:	Cradle
Classification:	FCC Part 15 Low Power Communication Device Transmitter
Date of Test:	April 19, 2024 ~ May 8, 2024
Applied Standard:	FCC 47 CFR Part 1.1307

TABLE OF CONTENTS

1. INTRODUCTION.....	3
1.1 Test facility	3
1.2 Accreditation and listing	3
2. EUT INFORMATION & TEST CONDITIONS	4
2.1 EUT Information	4
2.2 Operation During Test.....	5
2.3 Support Equipment	6
2.4 Setup Drawing.....	6
3. RF Exposure Test Exemptions	7







1. INTRODUCTION

1.1 Test facility

The measurement procedure described in American National Standard for Methods of Measurement of Radio-Noise Emissions from Low-Voltage Electrical and Electronic Equipment in the Range of 9 kHz to 40 GHz (ANSI C63.4-2014), the American National Standard for Testing Unlicensed Wireless Devices (ANSI C63.10-2013) was used in determining radiated and conducted emissions emanating.

These measurement tests were conducted at **Nemko Korea Co., Ltd.**
 The site address 165-51, Yurim-ro, Cheoin-gu, Yongin-si, Gyeonggi-do, 17042, Rep. of Korea.

1.2 Accreditation and listing

Accreditation type		Accreditation number
	CAB Accreditation for DOC	Designation No. KR0026
	KOLAS Accredited Lab. (Korea Laboratory Accreditation Scheme)	Registration No. KT155
	Canada IC Registered site	Site No. 29506
	VCCI registration site(RE/CE/Telecom CE)	Member No. 2118
	EMC CBTL	TL124
	KCC(RRL)Designated Lab.	Registration No. KR0026

2. EUT INFORMATION & TEST CONDITIONS

2.1 EUT Information

2.1.1 Specifications

EUT Type	Cradle
Model Name	EP-QQ503
Frequency of Operation	13.56 MHz
Modulation type	ASK
Number of Channels	1 CH
Antenna Specification	Internal type
EUT Rated Voltage	DC 3.88 V Power Supply: DC 5 V
Remarks	-

2.2 Operation During Test

During the test, the Galaxy ring was charged on the EUT to ensure continuous measurement of the RFID signal.

2.2.1 Additional model covered by this report

- The variant models shall use materials and electric circuits that are the same as the basic model except for the difference as below table.
- The difference between basic and variant models:

Variant model name	Description
EP-QQ505	Ring mounting size: 5, Antenna length(A): 14.6
EP-QQ506	Ring mounting size: 6, Antenna length(A): 15.1
EP-QQ507	Ring mounting size: 7, Antenna length(A): 15.1
EP-QQ508	Ring mounting size: 8, Antenna length(A): 15.8
EP-QQ509	Ring mounting size: 9, Antenna length(A): 15.8
EP-QQ500	Ring mounting size: 10, Antenna length(A): 16.6
EP-QQ501	Ring mounting size: 11, Antenna length(A): 16.6
EP-QQ502	Ring mounting size: 12, Antenna length(A): 17.2

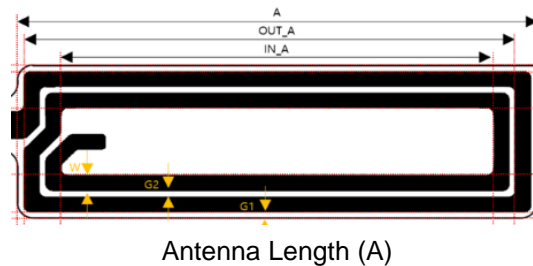

2.2.2 List of test reduction and EUT models covering other models

- Basic model and variant models were tested for each RFID antenna pattern size, and only representative models were tested for the same antenna size.
- The Fundamental emission on covered EUT's cradle models are equal to or less than one reference.

EUT Model	Galaxy Ring Model	Covered by
EP-QQ503 (Basic model)	SM-Q503	
EP-QQ505	SM-Q505	
EP-QQ506	SM-Q506	SM-Q507 & EP-QQ507
EP-QQ507	SM-Q507	
EP-QQ508	SM-Q508	SM-Q509 & EP-QQ509
EP-QQ509	SM-Q509	
EP-QQ500	SM-Q500	SM-Q501 & EP-QQ501
EP-QQ501	SM-Q501	
EP-QQ502	SM-Q502	SM-Q503 & EP-QQ503

2.3 Support Equipment

EUT	Samsung Electronics Co., Ltd. Model : SM-Q503	S/N: N/A Identical Proto-type
TRAVEL ADAPTER	Samsung Electronics Co., Ltd. Model : EP-TA800	FCC DOC S/N : N/A
Galaxy Ring	Samsung Electronics Co., Ltd. Model : SM-Q505, SM-Q507, SM-Q509, SM-Q501, SM-Q503	-

2.4 Setup Drawing

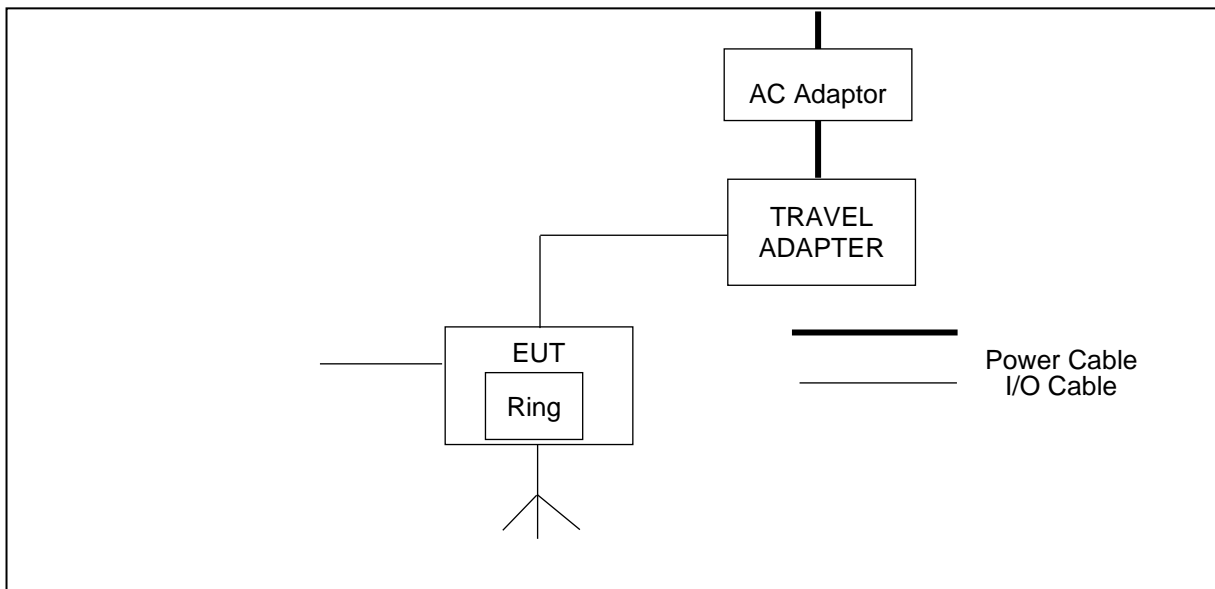

3. RF Exposure Test Exemptions

Exemptions for Single RF Sources

- 13.56 MHz - (Cradle: A3LEPQQ503)
 Power Thresholds (mW) = **1 mW**
 Maximum Field strength Level : 53.5 dBμV/m @ 3 m
 EIRP = 10log((Distance x 10^{((53.5 dBμV/m[Maximum Field strength Level]-120)/20)})²/30)/10⁻³
 = -41.73 dBm (**0.00007 mW**) (Exempted under § 1.1307(b)(3)(i)(A))

- Bluetooth LE - Companion device (Galaxy Ring: A3LSMQ503)
 Power Thresholds (mW) = **2.79 mW**
 Maximum Average power (mW) = **2.6 mW** (Exempted under § 1.1307(b)(3)(i)(C))

RF Exposure Test Exemptions for Simultaneous Transmission Sources

Simultaneous Transmission Limit

According to KDB 447498 D04, This case is described in detail in § 1.1307(b)(3)(ii)(B) and covers the situations where both SAR-based and MPE-based exemption may be considered for test exemption in fixed, mobile, or portable device exposure conditions. For these cases, a device with multiple RF sources transmitting simultaneously will be considered an RF exempt device if the condition of Formula (1) is satisfied.

$$\sum_{i=1}^a \frac{P_i}{P_{th,i}} + \sum_{j=1}^b \frac{ERP_j}{ERP_{th,j}} + \sum_{k=1}^c \frac{Evaluated_k}{Exposure Limit_k} \leq 1$$

Simultaneous Transmission Configuration

No	Scenario
1	Bluetooth LE(Galaxy Ring: A3LSMQ503) + 13.56 MHz(Cradle: A3LEPQQ503)

Simultaneous Transmission result

- Ratio Summation
 Bluetooth LE ratio (2.6 / 2.79= 0.93) + 13.56 MHz ratio (0.00007 / 1 = 0.00007) = **0.93**

- When the sum of ratios of simultaneously transmitting antennas in an operating mode and exposure condition combination is within the 1.0 the additional equipment approval is not required.