

TEST REPORT

of

FCC Part 15 Subpart C §15.209

FCC ID: A3LEPP4300

Equipment Under Test : WIRELESS CHARGER
Model Name : EP-P4300
Variant Model Name(s) : -
Applicant : Samsung Electronics Co., Ltd.
Manufacturer : Samsung Electronics Co., Ltd.
Date of Receipt : 2020.11.04
Date of Test(s) : 2020.11.27 ~ 2020.12.07
Date of Issue : 2020.12.16

In the configuration tested, the EUT complied with the standards specified above. This test report does not assure KOLAS accreditation.

- 1) The results of this test report are effective only to the items tested.
- 2) The SGS Korea is not responsible for the sampling, the results of this test report apply to the sample as received.
- 3) This test report cannot be reproduced, except in full, without prior written permission of the Company.

Tested by:



Nancy Park

Technical
Manager:



Hyunchoe You

SGS Korea Co., Ltd. Gunpo Laboratory



SGS Korea Co., Ltd.

4, LS-ro 182beon-gil, Gunpo-si, Gyeonggi-do, Korea, 15807
Tel. +82 31 428 5700 / Fax. +82 31 427 2370
<http://www.sgsgroup.kr>

INDEX

Table of Contents

1. General Information	3
2. Field Strength of Fundamental and Spurious Emission	7
3. 20 dB Bandwidth	34
4. AC Power Line Conducted Emission	39

1. General Information

1.1. Testing Laboratory

- SGS Korea Co., Ltd. (Gunpo Laboratory)
- 10-2, LS-ro 182beon-gil, Gunpo-si, Gyeonggi-do, Korea, 15807
 - 4, LS-ro 182beon-gil, Gunpo-si, Gyeonggi-do, Korea, 15807
 - Designation number: KR0150

All SGS services are rendered in accordance with the applicable SGS conditions of service available on request and accessible at <http://www.sgs.com/en/Terms-and-Conditions.aspx>.

Phone No. : +82 31 688 0901
 Fax No. : +82 31 688 0921

1.2. Details of Applicant

Applicant : Samsung Electronics Co., Ltd.
 Address : 19 Chapin Rd., Building D, Pine Brook, New Jersey, United States, 07058
 Contact Person : Chun, Jenni
 Phone No. : +1 973 808 6362

1.3. Details of Manufacturer

Company : Samsung Electronics Co., Ltd.
 Address : Yen Phong 1 Industrial park, Yen Phong District Bac Ninh Province, VIETNAM

1.4. Description of EUT

Kind of Product	WIRELESS CHARGER
Model Name	EP-P4300
Power Supply	DC 9.0 V
Operation Mode	2 W, 4.5 W, 7.5 W, 9W
Frequency Range	Ant. 1: 126.2 ~ 129.2 kHz
	Ant. 2: 144.5 ~ 147.5 kHz
Antenna Type	Loop Coil Antenna
H/W Version	1.3
S/W Version_MCU	EP-P4300_20201125_17C0
S/W Version_Tx IC	P43_PRA_OFFI_1208

1.5. Declaration of Manufacturer

- The EUT has 2 Loop coil antennas.
- Antenna 2 can only operate 2 W with Smart Wearable Device.
- Antennas operating maximum at the same time are 2 antennas.

1.6. Test Equipment List

Equipment	Manufacturer	Model	S/N	Cal. Date	Cal. Interval	Cal. Due
Spectrum Analyzer	R&S	FSV30	103100	Jun. 18, 2020	Annual	Jun. 18, 2021
Signal Generator	R&S	SMBV100A	255834	Jun. 03, 2020	Annual	Jun. 03, 2021
Amplifier	H.P.	8447F	2944A03909	Aug. 06, 2020	Annual	Aug. 06, 2021
Loop Antenna	Schwarzbeck Mess-Elektronik	FMZB 1519	1519-039	Aug. 22, 2019	Biennial	Aug. 22, 2021
Bilog Antenna	Schwarzbeck Mess-Elektronik	VULB9163	396	Mar. 21, 2019	Biennial	Mar. 21, 2021
Test Receiver	R&S	ESU26	100109	Feb. 18, 2020	Annual	Feb. 18, 2021
Turn Table	Innco systems GmbH	DS 1200 S	N/A	N.C.R.	N/A	N.C.R.
Controller	Innco systems GmbH	CONTROLLER CO3000-4P	CO3000/963/38 330516/L	N.C.R.	N/A	N.C.R.
Anechoic Chamber	SY Corporation	L x W x H (9.6 m x 6.4 m x 6.6 m)	N/A	N.C.R.	N/A	N.C.R.
Coaxial Cable	RFONE	SFX086-NMNM-5M (5 m)	20200324001	Aug. 10, 2020	Semi-annual	Feb. 10, 2021
Coaxial Cable	RFONE	MWX221-NMSNMS (4 m)	J1023142	Dec. 01, 2020	Semi-annual	Jun. 01, 2021
Coaxial Cable	RFONE	PL520-NMNM-10M (10 m)	20200324001	Aug. 10, 2020	Semi-Annual	Feb. 10, 2021
Test Receiver	R&S	ESCI 7	100911	Feb. 19, 2020	Annual	Feb. 19, 2021
Two-Line V-Network	R&S	ENV216	100190	May 08, 2020	Annual	May 08, 2021
Shield Room	SY Corporation	L x W x H (6.5 m x 3.5 m x 3.5 m)	N/A	N.C.R.	N/A	N.C.R.

► Support Equipment

Description	Manufacturer	Model	FCC ID
Samsung Mobile Phone	Samsung Electronics Co., Ltd.	SM-G970	A3LSMG970U
Samsung Mobile Phone	Samsung Electronics Co., Ltd.	SM-G973U	A3LSMG973U
Bluetooth Headset	Samsung Electronics Co., Ltd.	SM-R170	A3LSMR170L, A3LSMR170R
Smart Wearable Device	Samsung Electronics Co., Ltd.	SM-R500	A3LSMR500
C type USB Cable	Samsung Electronics Co., Ltd.	EP-DG970BBE_1.5M	-
TRAVEL ADAPTER	DONGYANG E&P	EP-TA200	-

1.7. Sample Calculation

Where relevant, the following sample calculation is provided:

$$\text{Field strength level (dB}\mu\text{V/m)} = \text{Measured level (dB}\mu\text{V)} + \text{Antenna factor (dB)} + \text{Cable loss (dB)} + (\text{AMP (dB)})$$

1.8. Worst Case of Test Configurations

Charging mode with client device	Mode					Description
Model: SM-G970U FCC ID: A3LSMG970U	2 W	4.5 W	7.5 W	9 W	2 W & 9 W	1 % of battery 50 % of battery 99 % of battery
Model: SM-G973U FCC ID: A3LSMG973U	Ant. 1: 126.2 ~ 129.2 kHz	Ant. 1: 126.2 ~ 129.2 kHz	Ant. 1: 126.2 ~ 129.2 kHz	Ant. 1: 126.2 ~ 129.2 kHz	Ant. 1: 126.2 ~ 129.2 kHz	
Model: SM-R170 FCC ID: A3LSMR170L, A3LSMR170R	Ant. 2: 144.5 ~ 147.5 kHz				Ant. 2: 144.5 ~ 147.5 kHz	
Model: SM-R500 FCC ID: A3LSMR500	SM-R170, SM-R500	SM-G970U (Normal)	SM-G970U (Fast)	SM-G973U	SM-G973U, SM-R500	

Note;

- The 4.5 W and 7.5 W modes are controlled by the software on the client device.
- EUT was investigated with client device under normal charging condition as above then worst value was only reported.

1.9. Summary of Test Results

The EUT has been tested according to the following specifications:

APPLIED STANDARD: FCC Part 15 Subpart C		
Section	Test Item(s)	Result
15.209	Radiated Emission, Spurious Emission and Field Strength of Fundamental	Complied
2.1049	20 dB Bandwidth	Complied
15.207	AC Power Line Conducted Emission	Complied

Note;

Due to the frequency range of the device is less than 1 MHz, so we perform Middle frequency according to 15.31 requirement.

1.10. Measurement Uncertainty

Where relevant, the following measurement uncertainty levels have been estimated for tests performed on the apparatus:

Parameter	Uncertainty
20 dB Bandwidth	± 9.66 kHz
AC Conducted Emission	± 3.45 dB
Radiated Disturbance, 9 kHz to 30 MHz	± 3.59 dB
Radiated Disturbance, below 1 GHz	± 5.88 dB

Uncertainty figures are valid to a confidence level of 95 %.

1.11. Test Report Revision

Revision	Report Number	Date of Issue	Description
0	F690501-RF-RTL001431	2020.12.09	Initial
1	F690501-RF-RTL001431-1	2020.12.14	Added the information of H/W Version and S/W Version.
2	F690501-RF-RTL001431-2	2020.12.16	Added the test mode to indicate what kind of client device is used.

2. Field Strength of Fundamental and Spurious Emission

2.1. Test Setup

The diagram below shows the test setup that is utilized to make the measurements for emission from 9 MHz to 30 MHz.

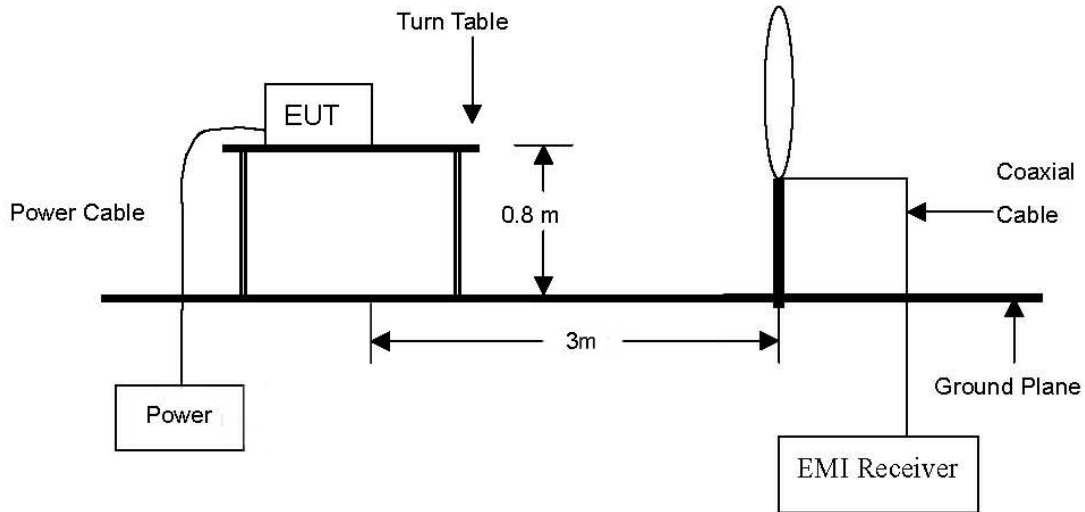

The diagram below shows the test setup that is utilized to make the measurements for emission from 30 MHz to 1 GHz.

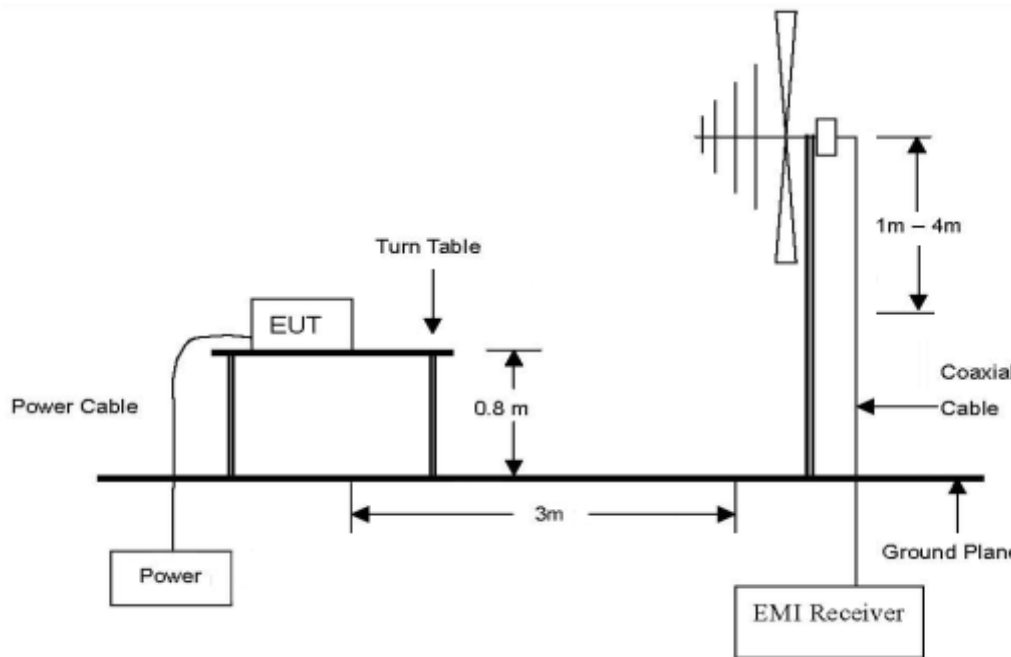

2.2. Limit

2.2.1. Radiated emission limits, general requirements

According to §15.209(a), except as provided elsewhere in this subpart, the emissions from an intentional radiator shall not exceed the field strength levels specified in the following table:

Frequency (MHz)	Field Strength (microvolts/meter)	Measurement Distance (meter)
0.009-0.490	2 400/F(kHz)	300
0.490-1.705	24 000/F(kHz)	30
1.705-30.0	30	30
30-88	100**	3
88-216	150**	3
216-960	200**	3
Above 960	500	3

** Except as provided in paragraph (g), fundamental emissions from intentional radiators operating under this section shall not be located in the frequency bands 54-72 MHz, 76-88 MHz, 174-216 MHz or 470-806 MHz. however, operation within these frequency bands is permitted under other sections of this part, e.g., §§15.231 and 15.241

2.3. Test Procedures

Radiated emissions from the EUT were measured according to the dictates of ANSI C63.10:2013.

2.3.1. Test Procedures for emission from 9 kHz to 30 MHz

- a. The EUT was placed on the top of a rotating table 0.8 meters above the ground at a 3 meter anechoic chamber test site. The table was rotated 360 degrees to determine the position of the highest radiation.
- b. Then antenna is a loop antenna is fixed at one meter above the ground to determine the maximum value of the field strength. Both parallel and perpendicular of the antenna are set to make the measurement.
- c. For each suspected emission, the EUT was arranged to its worst case and then the table was turned from 0 degrees to 360 degrees to find the maximum reading.
- d. The test-receiver system was set to Quasi Peak and Average Detect Function and Specified Bandwidth with Maximum Hold Mode.

2.3.2. Test Procedures for emission from 30 MHz to 1 000 MHz

- a. The EUT was placed on the top of a rotating table 0.8 meters above the ground at a 3 meter anechoic chamber test site. The table was rotated 360 degrees to determine the position of the highest radiation.
- b. During performing radiated emission below 1 GHz, the EUT was set 3 meters away from the interference receiving antenna, which was mounted on the top of a variable-height antenna tower. During performing radiated emission above 1 GHz, the EUT was set 3 meter away from the interference-receiving antenna.
- c. The antenna is a broadband antenna, and its height is varied from one meter to four meters above the ground to determine the maximum value of the field strength. Both horizontal and vertical polarizations of the antenna are set to make the measurement.
- d. For each suspected emission, the EUT was arranged to its worst case and then the antenna was tuned to heights from 1 meter to 4 meters and the table was turned from 0 degrees to 360 degrees to find the maximum reading.
- e. The test-receiver system was set to Peak Detect Function and Specified Bandwidth with Maximum Hold Mode.

2.4. Field Strength of Fundamental Test Result

Ambient temperature : (23 ± 1) °C
 Relative humidity : 47 % R.H.

The following table shows the highest levels of radiated emissions on between polarizations of horizontal and vertical.

Test Condition: 2 W Operating mode with client device (1 % battery status of client device)

Radiated Emissions			Ant.	Correction Factors		Total		Limit	
Frequency (MHz)	Reading (dB μ V)	Detect Mode	Pol.	AF (dB/m)	CL (dB)	Actual (dB μ V/m) at 3 m	Actual (dB μ V/m) at 300 m	Limit (dB μ V/m) at 300 m	Margin (dB)
Ant. 1 (126.2 kHz ~ 129.2 kHz)									
0.128	56.42	Average	H	17.80	0.05	74.27	-5.73	25.46	31.19
Ant. 2 (144.5 kHz ~ 147.5 kHz)									
0.146	50.20	Average	H	17.80	0.06	68.06	-11.94	24.32	36.26

Test Condition: 4.5 W Operating mode with client device (1 % battery status of client device)

Radiated Emissions			Ant.	Correction Factors		Total		Limit	
Frequency (MHz)	Reading (dB μ V)	Detect Mode	Pol.	AF (dB/m)	CL (dB)	Actual (dB μ V/m) at 3 m	Actual (dB μ V/m) at 300 m	Limit (dB μ V/m) at 300 m	Margin (dB)
Ant. 1 (126.2 kHz ~ 129.2 kHz)									
0.128	63.50	Average	H	17.80	0.05	81.35	1.35	25.46	24.11

Test Condition: 7.5 W Operating mode with client device (1 % battery status of client device)

Radiated Emissions			Ant.	Correction Factors		Total		Limit	
Frequency (MHz)	Reading (dB μ V)	Detect Mode	Pol.	AF (dB/m)	CL (dB)	Actual (dB μ V/m) at 3 m	Actual (dB μ V/m) at 300 m	Limit (dB μ V/m) at 300 m	Margin (dB)
Ant. 1 (126.2 kHz ~ 129.2 kHz)									
0.128	57.60	Average	H	17.80	0.05	75.45	-4.55	25.46	30.01

Test Condition: 9 W Operating mode with client device (1 % battery status of client device)

Radiated Emissions			Ant.	Correction Factors		Total		Limit	
Frequency (MHz)	Reading (dB μ V)	Detect Mode	Pol.	AF (dB/m)	CL (dB)	Actual (dB μ V/m) at 3 m	Actual (dB μ V/m) at 300 m	Limit (dB μ V/m) at 300 m	Margin (dB)
Ant. 1 (126.2 kHz ~ 129.2 kHz)									
0.128	63.60	Average	H	17.80	0.05	81.45	1.45	25.46	24.01

Test Condition: 2 W & 9 W Operating mode with client device (1 % battery status of client device)

Radiated Emissions			Ant.	Correction Factors		Total		Limit	
Frequency (MHz)	Reading (dB μ V)	Detect Mode	Pol.	AF (dB/m)	CL (dB)	Actual (dB μ V/m) at 3 m	Actual (dB μ V/m) at 300 m	Limit (dB μ V/m) at 300 m	Margin (dB)
Ant. 1 (126.2 kHz ~ 129.2 kHz) & Ant. 2 (144.5 kHz ~ 147.5 kHz)									
0.128	64.40	Average	H	17.80	0.15	82.35	2.35	25.46	23.11
0.146	53.30	Average	H	17.80	0.15	71.25	-8.75	24.32	33.07

Remark;

1. According to §15.31(f)(2),
 - 300 m Result (dB μ V/m) = 3 m Result (dB μ V/m) - 40log (300/3) (dB μ V/m).
2. According to field strength table of general requirement in §15.209(a), field strength limits below 1.705 MHz were calculated as below.
 - 9 kHz to 490 kHz: 20log (2 400 / F (kHz)) at 300 m (dB μ V/m)
 - 490 kHz to 1.705 MHz: 20log (24 000/F (kHz)) at 30 m (dB μ V/m)
3. According to §15.209(d), the measurements were tested by using Quasi peak detector except for the frequency bands 9-90 kHz, 110-490 kHz and above 1 GHz in these three bands on measurements employing an average detector.
4. The limit above was calculated based on table of §15.209(a).

- Test plots

Test Condition: 2 W Operating mode with client device (1 % battery status of client device)

Ant. 1 (126.2 kHz ~ 129.2 kHz)

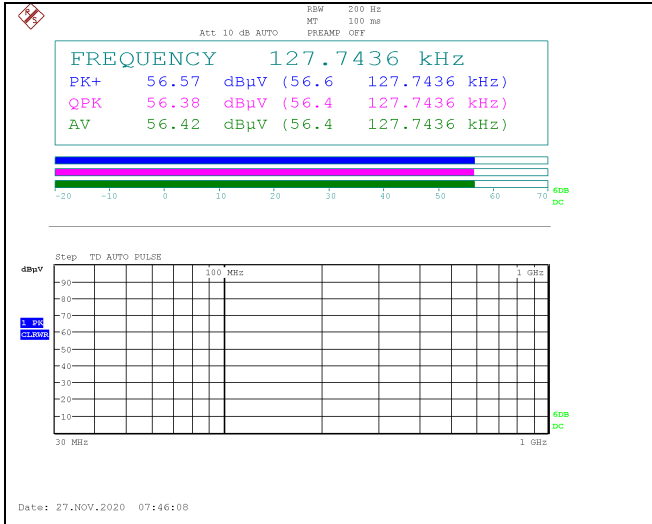

Ant. 2 (144.5 kHz ~ 147.5 kHz)

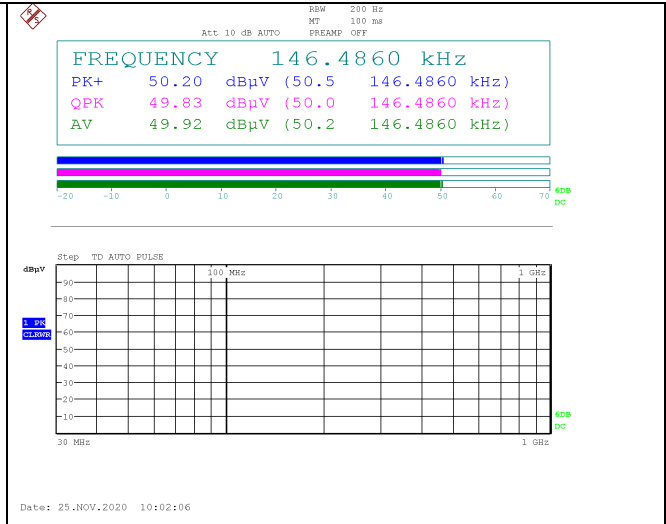

Test Condition: 4.5 W Operating mode with client device (1 % battery status of client device)

Ant. 1 (126.2 kHz ~ 129.2 kHz)

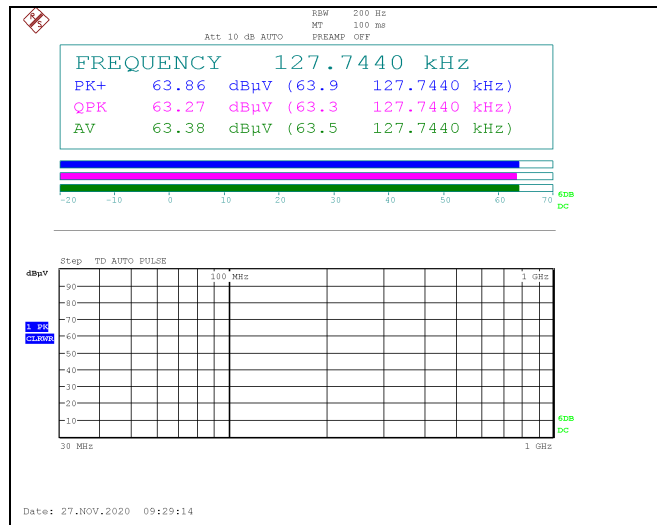

Test Condition: 7.5 W Operating mode with client device (1 % battery status of client device)

Ant. 1 (126.2 kHz ~ 129.2 kHz)

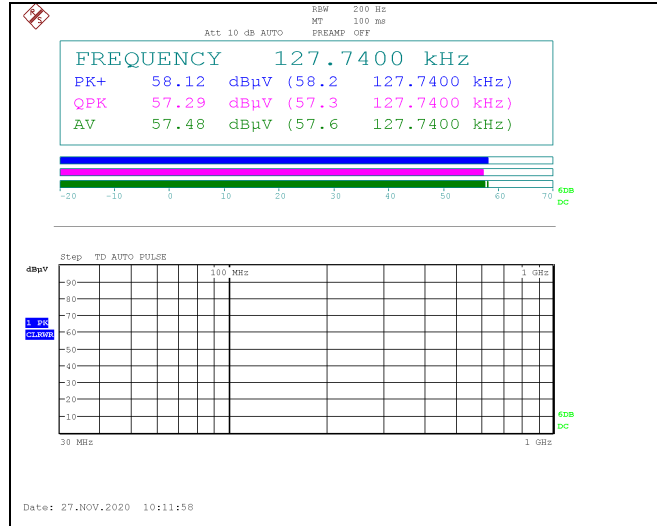

Test Condition: 9 W Operating mode with client device (1 % battery status of client device)

Ant. 1 (126.2 kHz ~ 129.2 kHz)

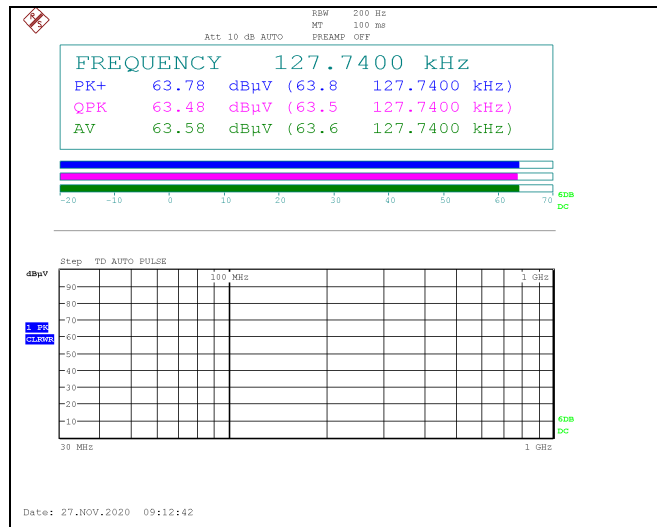

Test Condition: 2 W & 9 W Operating mode with client device (1 % battery status of client device)

Ant. 1 (126.2 kHz ~ 129.2 kHz)

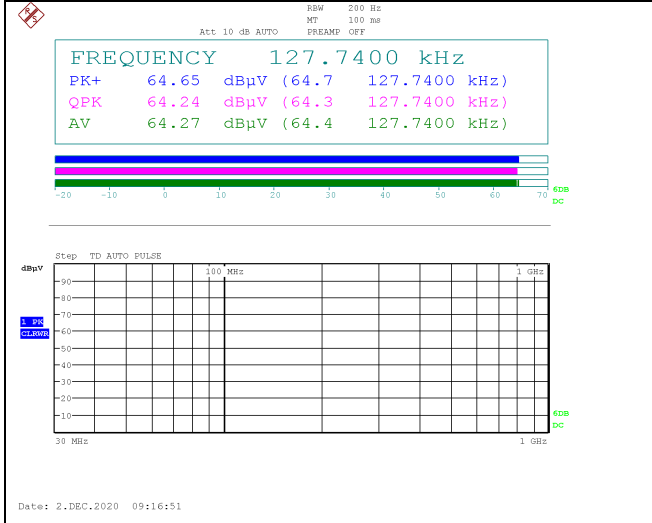

Ant. 2 (144.5 kHz ~ 147.5 kHz)

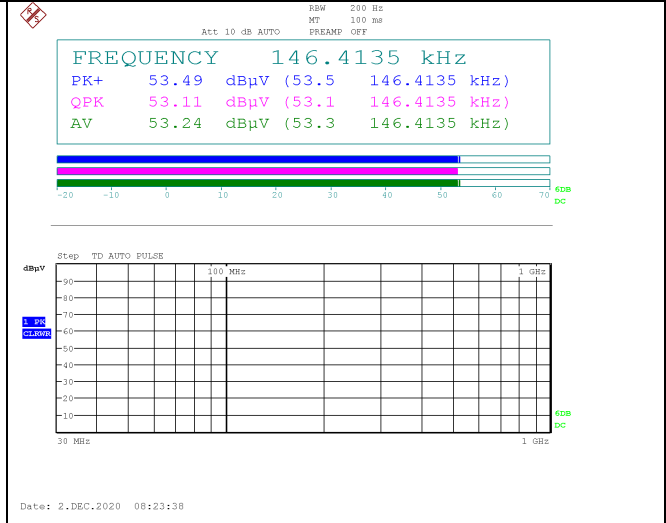

2.5. Spurious Emission Test Result

Ambient temperature : (23 ± 1) °C
 Relative humidity : 47 % R.H.

The following table shows the highest levels of radiated emissions on between polarizations of horizontal and vertical.

Test Condition: 2 W Operating mode with client device (1 % battery status of client device)

Ant. 1 (126.2 kHz ~ 129.2 kHz)

Below 30 MHz

Radiated Emissions			Ant.	Correction Factors		Total		Limit	
Frequency (MHz)	Reading (dBµV)	Detect Mode	Pol.	AF (dB/m)	CL (dB)	Actual (dBµV/m) at 3 m	Actual (dBµV/m) at 300 m or 30 m	Limit (dBµV/m) at 300 m or 30 m	Margin (dB)
0.019	25.30	Average	H	18.23	0.02	43.55	-36.45	42.03	78.48
0.036	29.20	Average	H	17.89	0.02	47.11	-32.89	36.48	69.37
0.383	34.40	Average	H	17.76	0.13	52.29	-27.71	15.94	43.65
0.639	25.30	Quasi Peak	H	17.81	0.16	43.27	-36.73	11.49	48.22

Above 30 MHz

Radiated Emissions			Ant	Correction Factors		Total	Limit	
Frequency (MHz)	Reading (dBµV)	Detect Mode	Pol.	AF (dB/m)	AMP + CL (dB)	Actual (dBµV/m)	Limit (dBµV/m)	Margin (dB)
39.33	35.10	Peak	V	19.70	-27.31	27.49	40.00	12.51
95.29	42.70	Peak	H	16.43	-26.75	32.38	43.50	11.12
222.76	38.10	Peak	V	17.47	-25.53	30.04	46.00	15.96
227.42	39.90	Peak	H	17.65	-25.51	32.04	46.00	13.96
354.89	34.30	Peak	H	20.81	-25.19	29.92	46.00	16.08
588.06	30.80	Peak	V	24.88	-25.82	29.86	46.00	16.14
Above 600.00	Not detected	-	-	-	-	-	-	-

Ant. 2 (144.5 kHz ~ 147.5 kHz)

Below 30 MHz

Radiated Emissions			Ant.	Correction Factors		Total		Limit	
Frequency (MHz)	Reading (dB μ V)	Detect Mode	Pol.	AF (dB/m)	CL (dB)	Actual (dB μ V/m) at 3 m	Actual (dB μ V/m) at 300 m or 30 m	Limit (dB μ V/m) at 300 m or 30 m	Margin (dB)
0.019	28.90	Average	H	18.23	0.02	47.15	-32.85	42.03	74.88
0.036	35.70	Average	H	17.89	0.02	53.61	-26.39	36.48	62.87
0.438	26.80	Average	H	17.73	0.13	44.66	-35.34	14.77	50.11

Above 30 MHz

Radiated Emissions			Ant	Correction Factors		Total	Limit	
Frequency (MHz)	Reading (dB μ V)	Detect Mode	Pol.	AF (dB/m)	AMP + CL (dB)	Actual (dB μ V/m)	Limit (dB μ V/m)	Margin (dB)
68.86	38.20	Peak	V	14.96	-27.03	26.13	40.00	13.87
193.22	34.20	Peak	H	16.64	-25.75	25.09	43.50	18.41
213.43	34.90	Peak	V	16.91	-25.58	26.23	43.50	17.27
330.02	33.10	Peak	V	20.00	-25.11	27.99	46.00	18.01
427.95	30.80	Peak	H	22.06	-25.61	27.25	46.00	18.75
Above 500.00	Not detected	-	-	-	-	-	-	-

Test Condition: 4.5 W Operating mode with client device (1 % battery status of client device)

Ant. 1 (126.2 kHz ~ 129.2 kHz)

Below 30 MHz

Radiated Emissions			Ant.	Correction Factors		Total		Limit	
Frequency (MHz)	Reading (dB μ V)	Detect Mode	Pol.	AF (dB/m)	CL (dB)	Actual (dB μ V/m) at 3 m	Actual (dB μ V/m) at 300 m or 30 m	Limit (dB μ V/m) at 300 m or 30 m	Margin (dB)
0.019	30.10	Average	H	18.23	0.02	48.35	-31.65	42.03	73.68
0.036	35.10	Average	H	17.89	0.02	53.01	-26.99	36.48	63.47
0.384	39.60	Average	H	17.76	0.13	57.49	-22.51	15.92	38.43
0.638	27.50	Quasi Peak	H	17.81	0.16	45.47	5.47	31.51	26.04

Above 30 MHz

Radiated Emissions			Ant	Correction Factors		Total	Limit	
Frequency (MHz)	Reading (dB μ V)	Detect Mode	Pol.	AF (dB/m)	AMP + CL (dB)	Actual (dB μ V/m)	Limit (dB μ V/m)	Margin (dB)
61.09	40.40	Peak	V	17.77	-27.13	31.04	40.00	8.96
67.31	42.50	Peak	V	15.58	-27.05	31.03	40.00	8.97
194.78	37.00	Peak	H	16.88	-25.74	28.14	43.50	15.36
227.42	35.80	Peak	H	17.65	-25.51	27.94	46.00	18.06
354.89	33.80	Peak	H	20.81	-25.19	29.42	46.00	16.58
Above 400.00	Not detected	-	-	-	-	-	-	-

Test Condition: 7.5 W Operating mode with client device (1 % battery status of client device)

Ant. 1 (126.2 kHz ~ 129.2 kHz)

Below 30 MHz

Radiated Emissions			Ant.	Correction Factors		Total		Limit	
Frequency (MHz)	Reading (dB μ V)	Detect Mode	Pol.	AF (dB/m)	CL (dB)	Actual (dB μ V/m) at 3 m	Actual (dB μ V/m) at 300 m or 30 m	Limit (dB μ V/m) at 300 m or 30 m	Margin (dB)
0.019	29.60	Average	H	18.23	0.02	47.85	-32.15	42.03	74.18
0.036	35.50	Average	H	17.89	0.02	53.41	-26.59	36.48	63.07
0.383	38.20	Average	H	17.76	0.13	56.09	-23.91	15.94	39.85
0.639	25.60	Quasi Peak	H	17.81	0.16	43.57	-36.43	11.49	47.92

Above 30 MHz

Radiated Emissions			Ant	Correction Factors		Total	Limit	
Frequency (MHz)	Reading (dB μ V)	Detect Mode	Pol.	AF (dB/m)	AMP + CL (dB)	Actual (dB μ V/m)	Limit (dB μ V/m)	Margin (dB)
39.33	42.90	Peak	V	19.70	-27.31	35.29	40.00	4.71
67.31	43.80	Peak	V	15.58	-27.05	32.33	40.00	7.67
211.88	38.70	Peak	H	16.81	-25.59	29.92	43.50	13.58
227.42	40.40	Peak	H	17.65	-25.51	32.54	46.00	13.46
330.02	32.80	Peak	V	20.00	-25.11	27.69	46.00	18.31
353.33	34.50	Peak	H	20.90	-25.18	30.22	46.00	15.78
Above 400.00	Not detected	-	-	-	-	-	-	-

Test Condition: 9 W Operating mode with client device (1 % battery status of client device)

Ant. 1 (126.2 kHz ~ 129.2 kHz)

Below 30 MHz

Radiated Emissions			Ant.	Correction Factors		Total		Limit	
Frequency (MHz)	Reading (dB μ V)	Detect Mode	Pol.	AF (dB/m)	CL (dB)	Actual (dB μ V/m) at 3 m	Actual (dB μ V/m) at 300 m or 30 m	Limit (dB μ V/m) at 300 m or 30 m	Margin (dB)
0.019	30.70	Average	H	18.23	0.02	48.95	-31.05	42.03	73.08
0.036	36.20	Average	H	17.89	0.02	54.11	14.11	56.48	42.37
0.383	42.30	Average	H	17.76	0.13	60.19	-19.81	15.94	35.75
0.639	33.94	Quasi Peak	H	17.81	0.16	51.91	11.91	31.49	19.58
0.894	27.90	Quasi Peak	H	18.02	0.20	46.12	6.12	28.58	22.46

Above 30 MHz

Radiated Emissions			Ant	Correction Factors		Total	Limit	
Frequency (MHz)	Reading (dB μ V)	Detect Mode	Pol.	AF (dB/m)	AMP + CL (dB)	Actual (dB μ V/m)	Limit (dB μ V/m)	Margin (dB)
67.31	41.40	Peak	V	15.58	-27.05	29.93	40.00	10.07
118.61	40.70	Peak	V	15.64	-26.52	29.82	43.50	13.68
126.38	39.50	Peak	V	14.76	-26.44	27.82	43.50	15.68
210.32	36.80	Peak	H	16.72	-25.60	27.92	43.50	15.58
227.42	36.90	Peak	H	17.65	-25.51	29.04	46.00	16.96
354.89	34.80	Peak	H	20.81	-25.19	30.42	46.00	15.58
Above 400.00	Not detected	-	-	-	-	-	-	-

Test Condition: 2 W & 9 W Operating mode with client device (1 % battery status of client device)

Ant. 1 (126.2 kHz ~ 129.2 kHz) & Ant. 2 (144.5 kHz ~ 147.5 kHz)

Below 30 MHz

Radiated Emissions			Ant.	Correction Factors		Total		Limit	
Frequency (MHz)	Reading (dB μ V)	Detect Mode	Pol.	AF (dB/m)	CL (dB)	Actual (dB μ V/m) at 3 m	Actual (dB μ V/m) at 300 m or 30 m	Limit (dB μ V/m) at 300 m or 30 m	Margin (dB)
0.019	29.80	Average	H	18.23	0.10	48.13	-31.87	42.03	73.90
0.036	34.10	Average	H	17.89	0.11	52.10	-27.90	36.48	64.38
0.383	42.00	Average	H	17.76	0.17	59.93	-20.07	15.94	36.01
0.438	31.70	Average	H	17.73	0.17	49.60	-30.40	14.77	45.17
0.639	32.40	Quasi Peak	H	17.81	0.18	50.39	10.39	31.49	21.10
0.894	25.60	Quasi Peak	H	18.02	0.19	43.81	3.81	28.58	24.77

Above 30 MHz

Radiated Emissions			Ant	Correction Factors		Total	Limit	
Frequency (MHz)	Reading (dB μ V)	Detect Mode	Pol.	AF (dB/m)	AMP + CL (dB)	Actual (dB μ V/m)	Limit (dB μ V/m)	Margin (dB)
39.33	42.90	Peak	V	19.70	-27.31	35.29	40.00	4.71
68.86	43.50	Peak	V	14.96	-27.03	31.43	40.00	8.57
107.72	34.30	Peak	V	16.76	-26.64	24.42	43.50	19.08
213.43	34.40	Peak	H	16.91	-25.58	25.73	43.50	17.77
333.13	33.70	Peak	H	20.19	-25.13	28.76	46.00	17.24
415.51	31.70	Peak	H	21.91	-25.55	28.06	46.00	17.94
Above 500.00	Not detected	-	-	-	-	-	-	-

Remark;

1. According to §15.31 (f)(2),
 - 300 m Result (dB μ V/m) = 3 m Result (dB μ V/m) - 40log (300/3) (dB μ V/m)
 - 30 m Result (dB μ V/m) = 3 m Result (dB μ V/m) - 40log (30/3) (dB μ V/m)
2. According to field strength table of general requirement in §15.209 (a), field strength limits below 1.705 MHz were calculated as below.
 - 9 kHz to 490 kHz: 20log (2 400 / F (kHz)) at 300 m (dB μ V/m)
 - 490 kHz to 1.705 MHz: 20log (24 000 / F (kHz)) at 30 m (dB μ V/m)
3. According to §15.209 (d), the measurements were tested by using Quasi peak detector except for the frequency bands 9-90 kHz, 110-490 kHz and above 1 GHz in these three bands on measurements employing an average detector.
4. The limit above was calculated based on table of §15.209 (a).
5. Radiated spurious emission measurement as below 30 MHz.
 (Actual (dB μ A/m) at 3m = Reading (dB μ V) + AF (dB/m) + CL (dB))
6. Radiated spurious emission measurement as above 30 MHz.
 (Actual (dB μ A/m) = Reading (dB μ V) + AF (dB/m) + CL (dB) + AMP (dB))
7. According to §15.31(o), emission levels are not report much lower than the limits by over 20 dB.

- Test plots

Test Condition: 2 W Operating mode with client device (1 % battery status of client device)

Ant. 1 (126.2 kHz ~ 129.2 kHz)

Below 30 MHz



Above 30 MHz

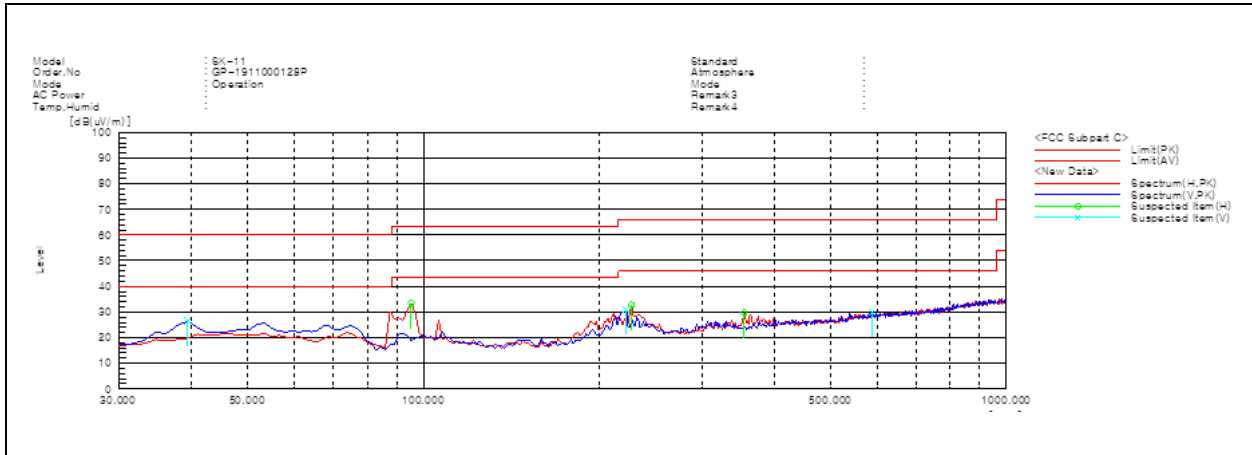

Remark;

- Traces shown in the plot were made by using a peak detector.

Ant. 2 (144.5 kHz ~ 147.5 kHz)

Below 30 MHz



Above 30 MHz

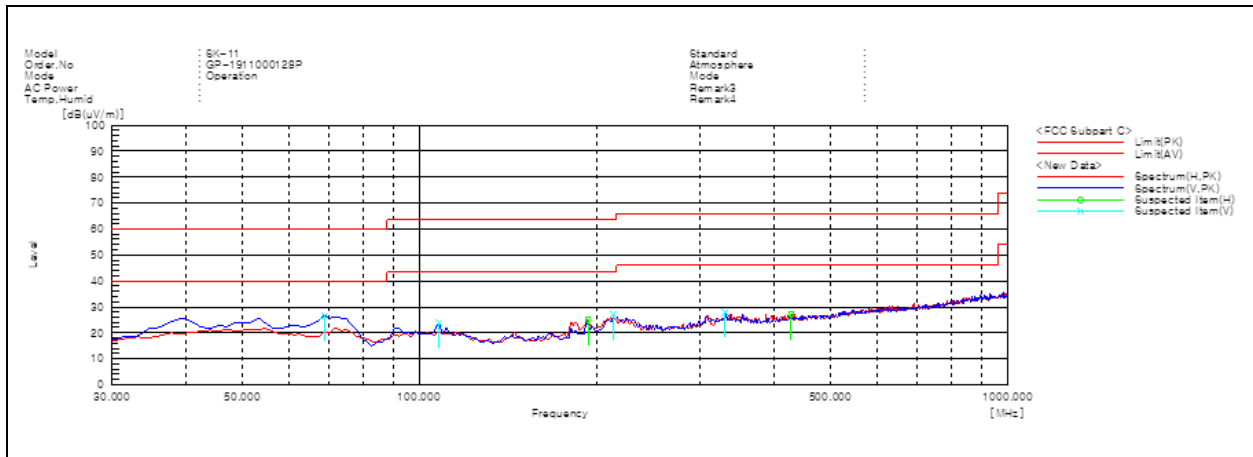

Remark;

- Traces shown in the plot were made by using a peak detector.

Test Condition: 4.5 W Operating mode with client device (1 % battery status of client device)

Ant. 1 (126.2 kHz ~ 129.2 kHz)

Below 30 MHz



Above 30 MHz

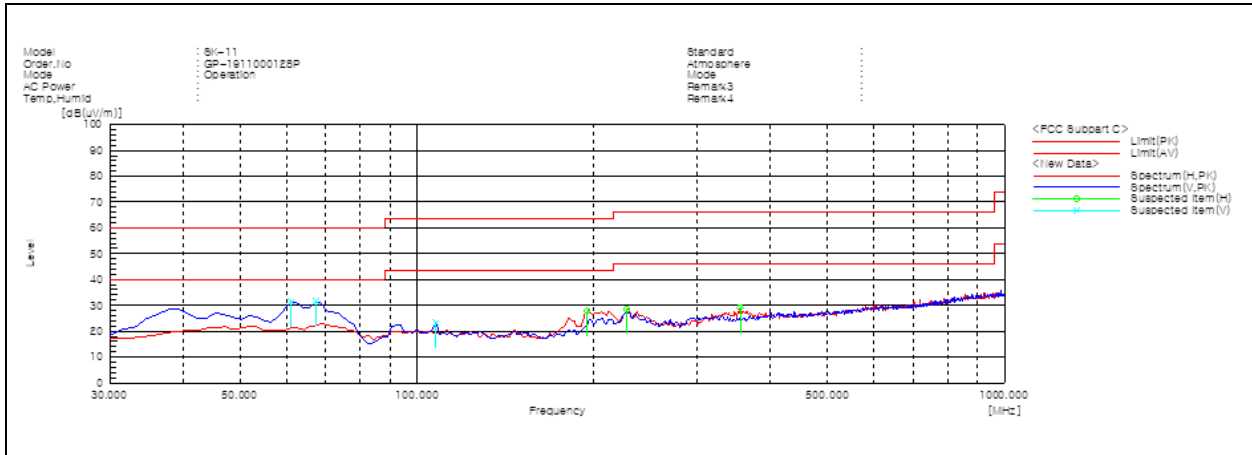

Remark;

- Traces shown in the plot were made by using a peak detector.

Test Condition: 7.5 W Operating mode with client device (1 % battery status of client device)

Ant. 1 (126.2 kHz ~ 129.2 kHz)

Below 30 MHz



Above 30 MHz

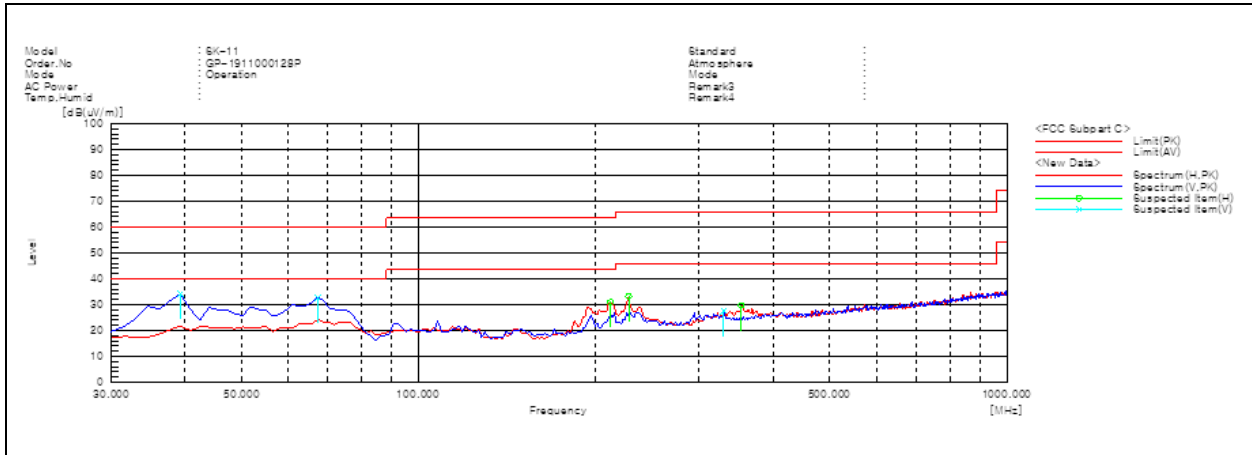

Remark;

- Traces shown in the plot were made by using a peak detector.

Test Condition: 9 W Operating mode with client device (1 % battery status of client device)

Ant. 1 (126.2 kHz ~ 129.2 kHz)

Below 30 MHz

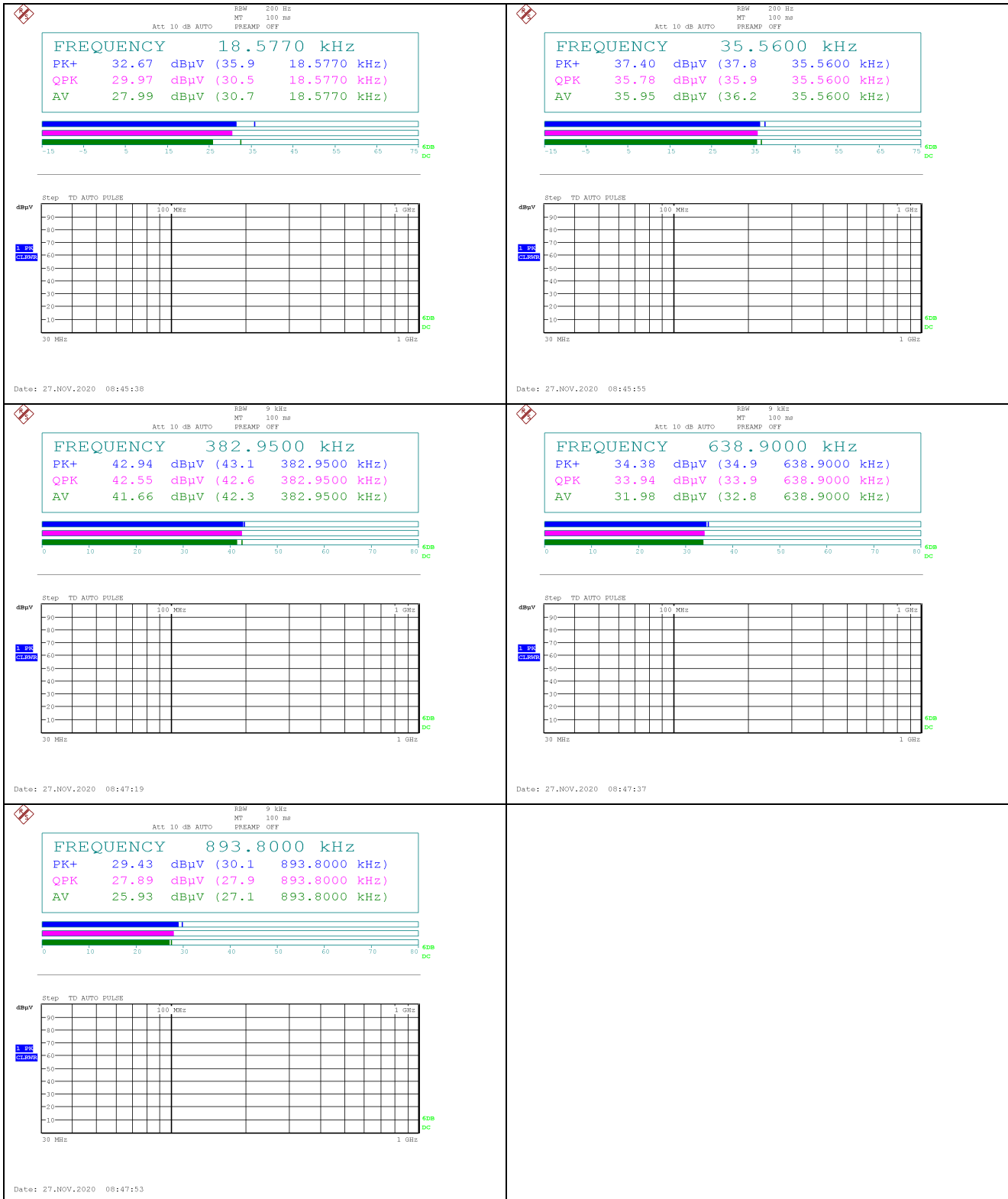

Above 30 MHz

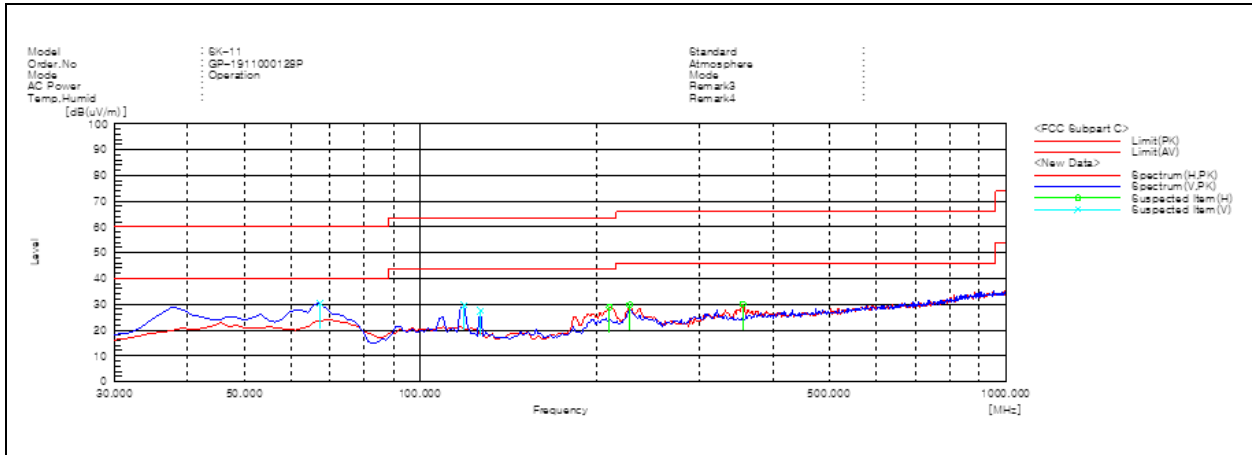

Remark;

- Traces shown in the plot were made by using a peak detector.

Test Condition: 2 W & 9 W Operating mode with client device (1 % battery status of client device)

Ant. 1 (126.2 kHz ~ 129.2 kHz) & Ant. 2 (144.5 kHz ~ 147.5 kHz)

Below 30 MHz



Above 30 MHz

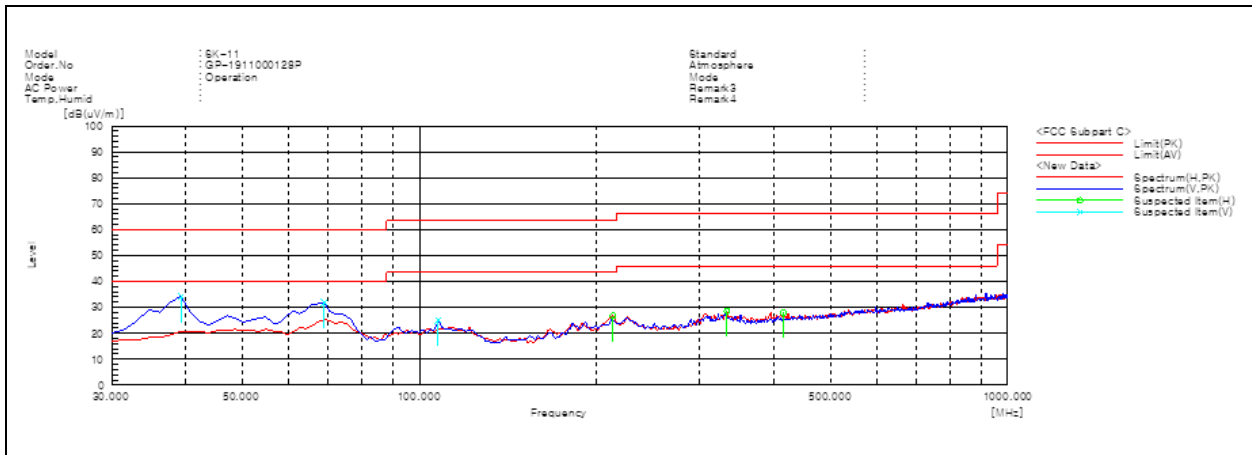

Remark;

- Traces shown in the plot were made by using a peak detector.

3. 20 dB Bandwidth

3.1. Test Setup

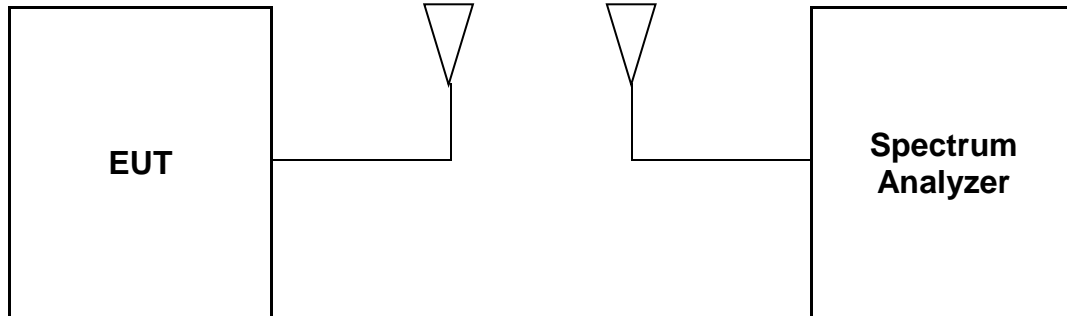

3.2. Limit

None; for reporting purposed only

3.3. Test Procedure

- a. Span = set to capture all products of the modulation process, including the emission skirts.
RBW = 200 Hz, VBW = 200 Hz, Sweep = auto, Detector = peak, Trace = max hold.
- b. The marker-to-peak function to set the mark to the peak of the emission. Use the marker-delta function to measure 20 dB down one side of the emission. Reset the function, and move the marker to the other side of the emission, until it is (as close as possible to) even with the reference marker level. The marker-delta reading at this point is 20 dB bandwidth of the emission.

3.4. Test Result

Ambient temperature : (23 ± 1) °C
 Relative humidity : 47 % R.H.

Test Condition: 2 W Operating mode with client device (1 % battery status of client device)

Antenna	Frequency (kHz)	EUT Status	20 dB Bandwidth (kHz)	Limit
1	126.2 ~ 129.2	With client device (1 % battery status of client device)	0.528	Reporting proposed only
2	144.5 ~ 147.5		0.550	

Test Condition: 4.5 W Operating mode with client device (1 % battery status of client device)

Antenna	Frequency (kHz)	EUT Status	20 dB Bandwidth (kHz)	Limit
1	126.2 ~ 129.2	With client device (1 % battery status of client device)	0.536	Reporting proposed only

Test Condition: 7.5 W Operating mode with client device (1 % battery status of client device)

Antenna	Frequency (kHz)	EUT Status	20 dB Bandwidth (kHz)	Limit
1	126.2 ~ 129.2	With client device (1 % battery status of client device)	0.528	Reporting proposed only

Test Condition: 9 W Operating mode with client device (1 % battery status of client device)

Antenna	Frequency (kHz)	EUT Status	20 dB Bandwidth (kHz)	Limit
1	126.2 ~ 129.2	With client device (1 % battery status of client device)	0.514	Reporting proposed only

Test Condition: 2 W & 9 W Operating mode with client device (1 % battery status of client device)

Antenna	Frequency (kHz)	EUT Status	20 dB Bandwidth (kHz)	Limit
1	126.2 ~ 129.2	With client device (1 % battery status of client device)	0.521	Reporting proposed only
2	144.5 ~ 147.5		0.543	

- Test plots

Test Condition: 2 W Operating mode with client device (1 % battery status of client device)

Ant. 1 (126.2 kHz ~ 129.2 kHz)

Ant. 2 (144.5 kHz ~ 147.5 kHz)

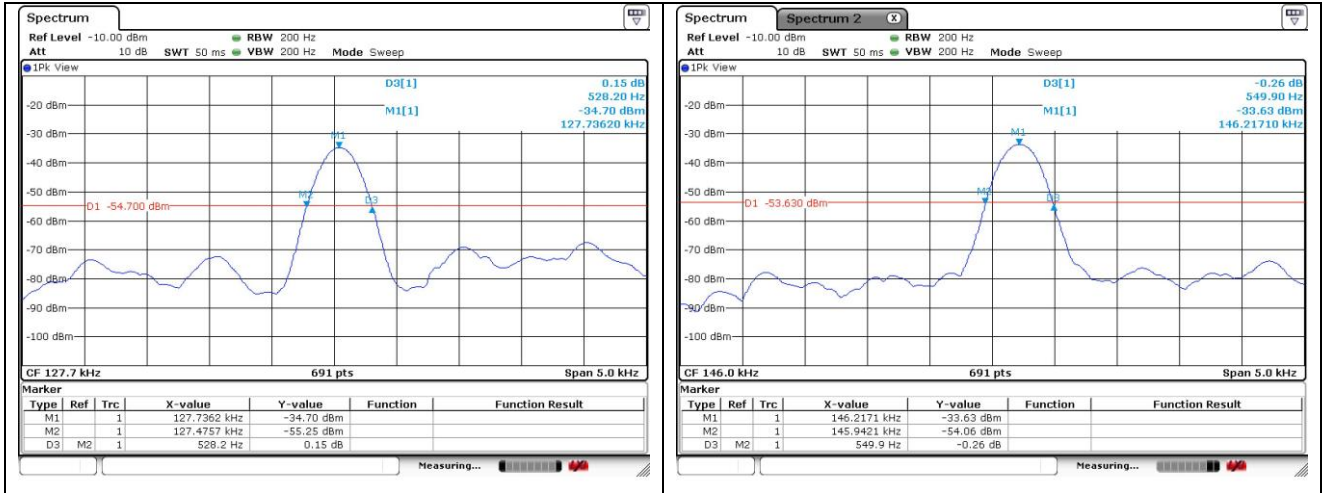

Test Condition: 4.5 W Operating mode with client device (1 % battery status of client device)

Ant. 1 (126.2 kHz ~ 129.2 kHz)

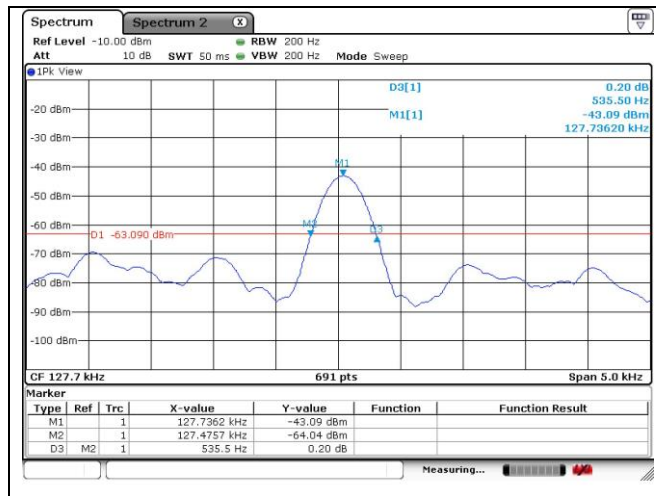

Test Condition: 7.5 W Operating mode with client device (1 % battery status of client device)

Ant. 1 (126.2 kHz ~ 129.2 kHz)

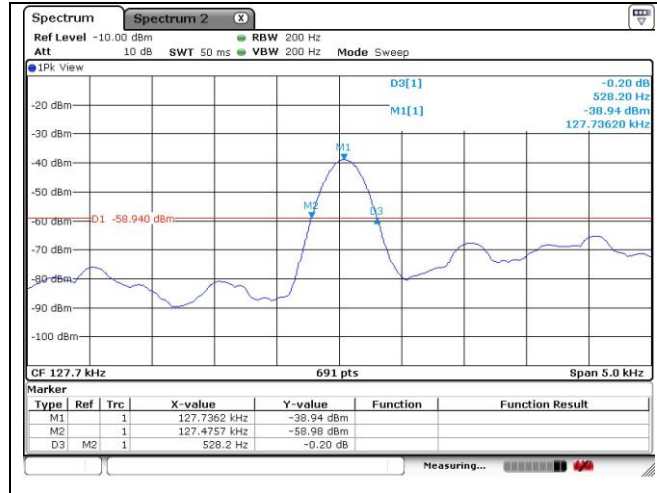

Test Condition: 9 W Operating mode with client device (1 % battery status of client device)

Ant. 1 (126.2 kHz ~ 129.2 kHz)

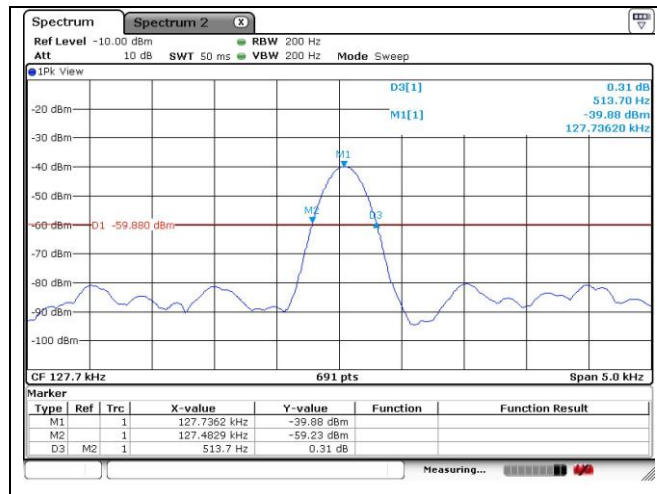

Test Condition: 2 W & 9 W Operating mode with client device (1 % battery status of client device)

Ant. 1 (126.2 kHz ~ 129.2 kHz)

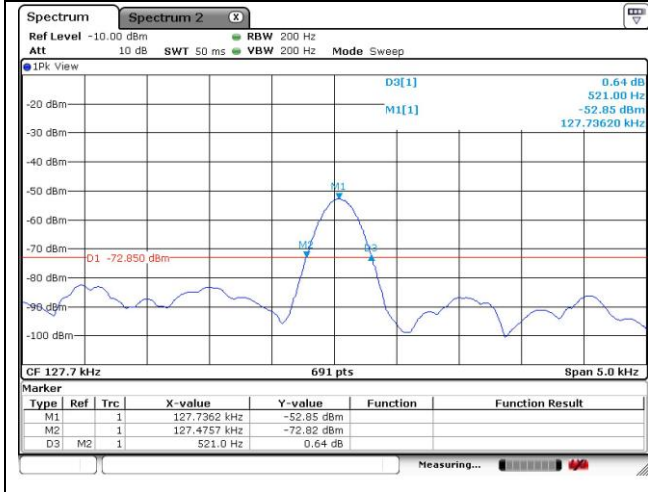

Ant. 2 (144.5 kHz ~ 147.5 kHz)

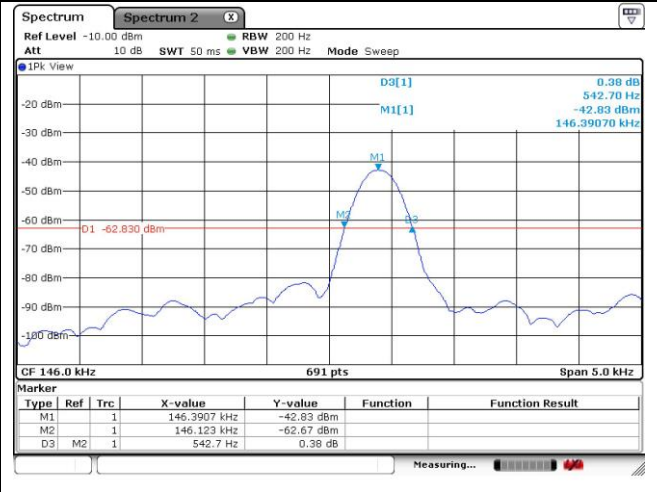

4. AC Power Line Conducted Emission

4.1. Test Setup

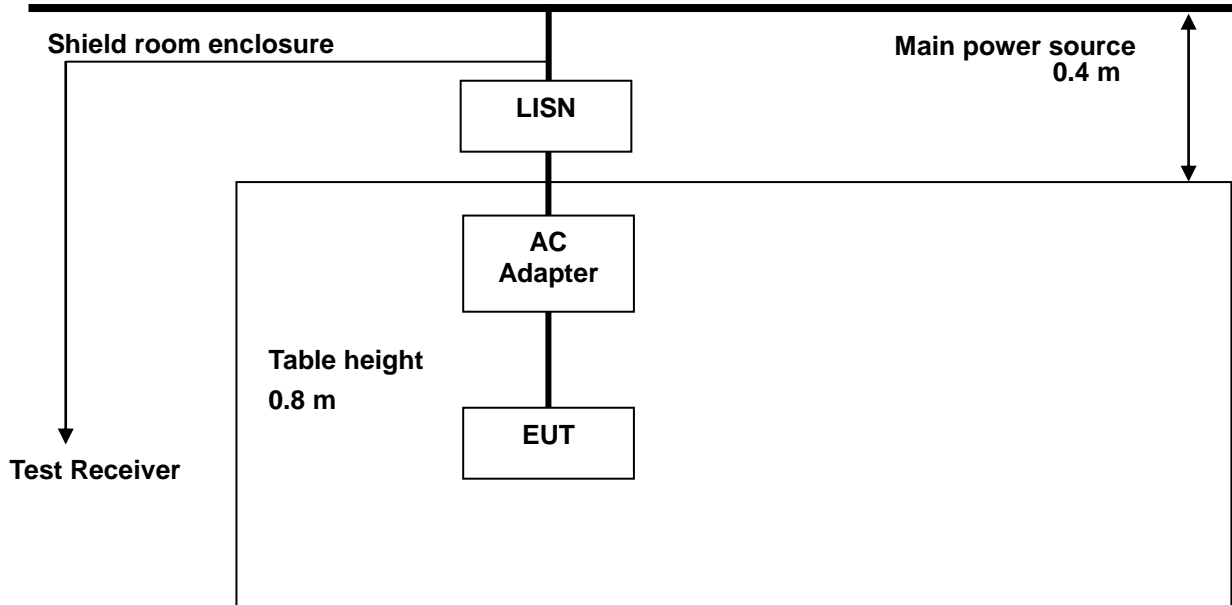

4.2. Limit

According to §15.207(a), for an intentional radiator that is designed to be connected to the public utility (AC) power line, the radio frequency voltage that is conducted back onto the AC power line on any frequency or frequencies, within the band 150 kHz to 30 MHz, shall not exceed the limits in the following table, as measured using a 50 μ H / 50 ohms line impedance stabilization network (LISN).

Compliance with the provision of this paragraph shall be based on the measurement of the radio frequency voltage between each power line and ground at the power terminal. The lower limit applies at the boundary between the frequency ranges.

Frequency of emission (MHz)	Conducted limit (dB μ V)	
	Quasi-peak	Average
0.15-0.5	66 to 56*	56 to 46*
0.5-5	56	46
5-30	60	50

* Decreases with the logarithm of the frequency.

4.3. Test Procedures

AC conducted emissions from the EUT were measured according to the dictates of ANSI C63.10:2013

1. The test procedure is performed in a 6.5 m × 3.5 m × 3.5 m (L × W × H) shielded room. The EUT along with its peripherals were placed on a 1.0 m (W) × 1.5 m (L) and 0.8 m in height wooden table and the EUT was adjusted to maintain a 0.4 meter space from a vertical reference plane.
2. The EUT was connected to power mains through a line impedance stabilization network (LISN) which provides 50 ohm coupling impedance for measuring instrument and the chassis ground was bounded to the horizontal ground plane of shielded room.
3. All peripherals were connected to the second LISN and the chassis ground also bounded to the horizontal ground plane of shielded room.
4. The excess power cable between the EUT and the LISN was bundled. The power cables of peripherals were unbundled. All connecting cables of EUT and peripherals were moved to find the maximum emission.

4.4. Test Results

The following table shows the highest levels of conducted emissions on both phase of Hot and Neutral line.

Ambient temperature : (23 ± 1) °C
 Relative humidity : 47 % R.H.
 Frequency range : 0.15 MHz – 30 MHz
 Measured Bandwidth : 9 kHz

Test Condition: 2 W Operating mode with client device (1 % battery status of client device)

Ant. 1 (126.2 kHz ~ 129.2 kHz)

FREQ. (MHz)	LEVEL (dB μ V)		LINE	LIMIT (dB μ V)		MARGIN (dB)	
	Q-Peak	Average		Q-Peak	Average	Q-Peak	Average
0.16	50.30	35.10	N	65.46	55.46	15.16	20.36
0.75	24.40	19.20	N	56.00	46.00	31.60	26.80
2.81	26.70	22.50	N	56.00	46.00	29.30	23.50
3.84	24.80	20.50	N	56.00	46.00	31.20	25.50
12.68	30.10	22.50	N	60.00	50.00	29.90	27.50
19.58	21.40	12.80	N	60.00	50.00	38.60	37.20
0.16	49.80	30.40	H	65.46	55.46	15.66	25.06
0.69	28.90	20.60	H	56.00	46.00	27.10	25.40
4.86	21.30	17.30	H	56.00	46.00	34.70	28.70
13.05	25.60	20.20	H	60.00	50.00	34.40	29.80
15.67	25.40	17.30	H	60.00	50.00	34.60	32.70
19.60	22.00	11.00	H	60.00	50.00	38.00	39.00

Remark;

1. Line (H): Hot, Line (N): Neutral
2. Each charging mode with client device (1 %, 50 % and 99 % of battery) was tested.
As worst condition, charging mode with client device (1 %) is reported.
3. The limit for Class B device(s) from 150 kHz to 30 MHz are specified in section of the Title 47 CFR.
4. Traces shown in plot were made by using a peak detector and average detector.
5. Deviations to the Specifications: None.

- Test plots

Test mode: (Neutral)

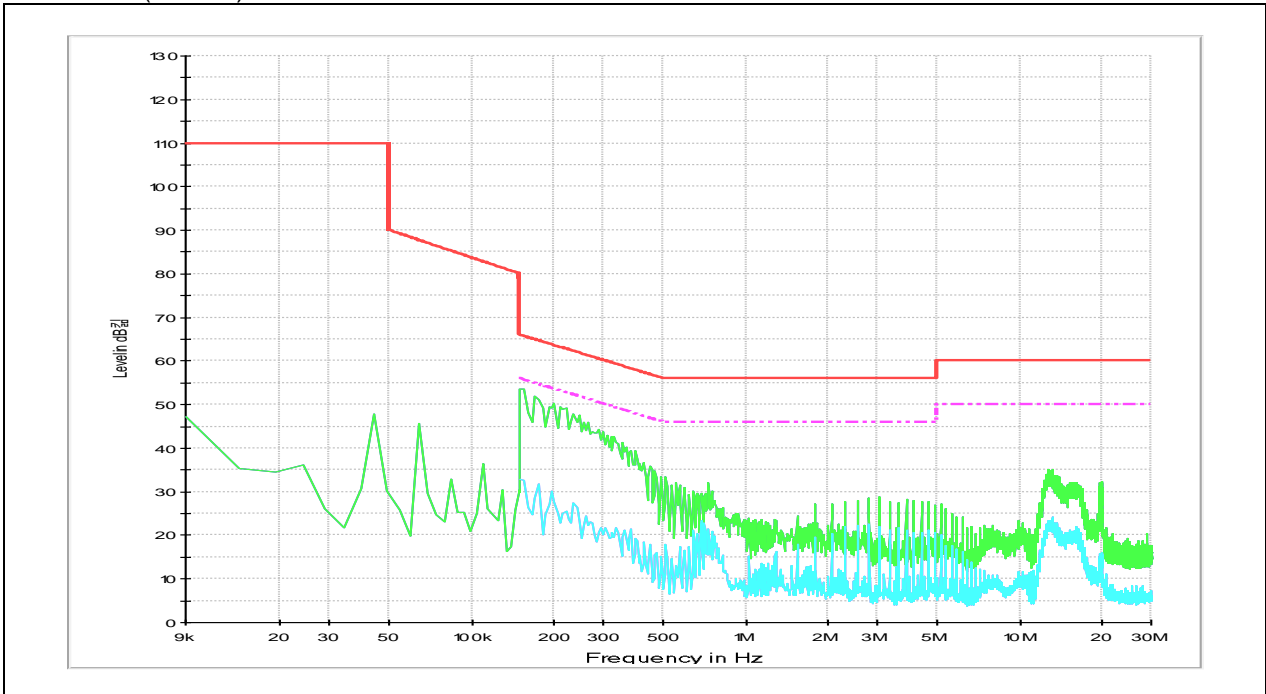

Test mode: (Hot)

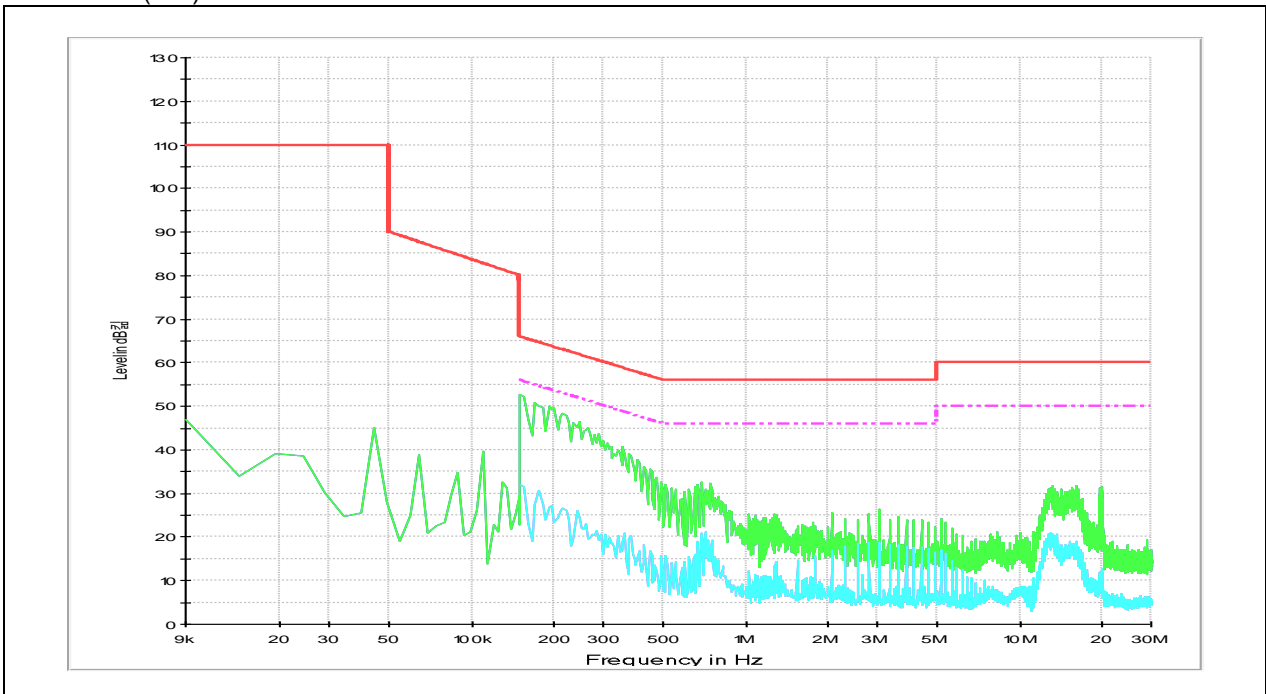

Ant. 2 (144.5 kHz ~ 147.5 kHz)

FREQ. (MHz)	LEVEL (dB μ V)		LINE	LIMIT (dB μ V)		MARGIN (dB)	
	Q-Peak	Average		Q-Peak	Average	Q-Peak	Average
0.16	47.40	29.00	N	65.46	55.46	18.06	26.46
0.74	25.40	20.50	N	56.00	46.00	30.60	25.50
3.83	19.70	7.60	N	56.00	46.00	36.30	38.40
10.26	19.10	11.70	N	60.00	50.00	40.90	38.30
12.47	30.00	22.40	N	60.00	50.00	30.00	27.60
13.52	31.50	24.90	N	60.00	50.00	28.50	25.10
0.17	44.10	25.50	H	64.96	54.96	20.86	29.46
0.74	27.90	20.00	H	56.00	46.00	28.10	26.00
3.85	20.80	10.20	H	56.00	46.00	35.20	35.80
12.20	24.90	18.80	H	60.00	50.00	35.10	31.20
15.08	28.30	20.30	H	60.00	50.00	31.70	29.70
19.60	19.40	9.70	H	60.00	50.00	40.60	40.30

Remark;

1. Line (H): Hot, Line (N): Neutral
2. Each charging mode with client device (1 %, 50 % and 99 % of battery) was tested.
As worst condition, charging mode with client device (1 %) is reported.
3. The limit for Class B device(s) from 150 kHz to 30 MHz are specified in section of the Title 47 CFR.
4. Traces shown in plot were made by using a peak detector and average detector.
5. Deviations to the Specifications: None.

- Test plots

Test mode: (Neutral)

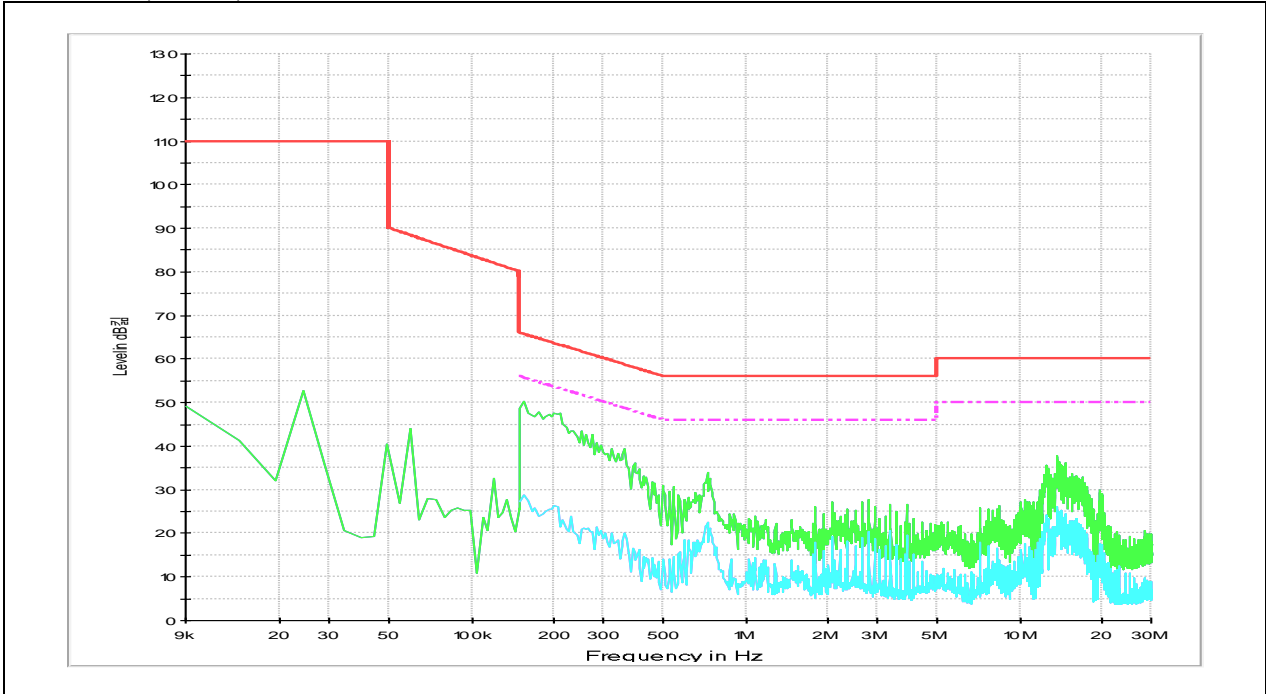

Test mode: (Hot)

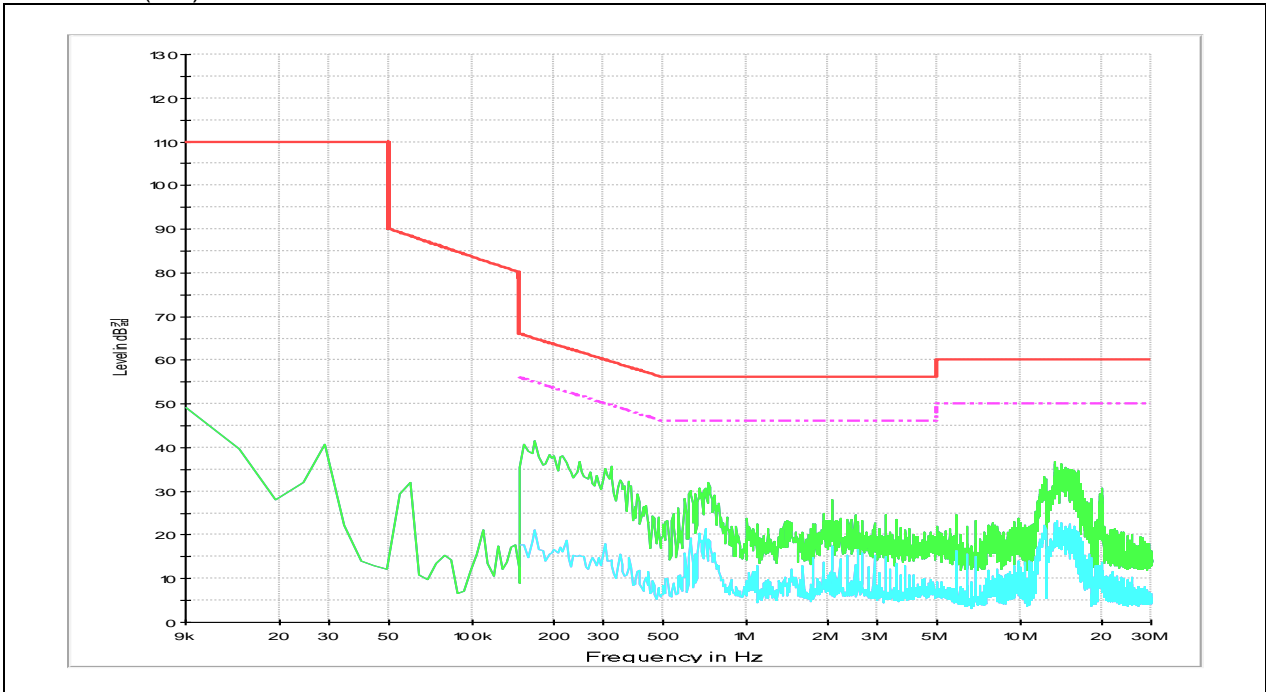

Test Condition: 4.5 W Operating mode with client device (1 % battery status of client device)

Ant. 1 (126.2 kHz ~ 129.2 kHz)

FREQ. (MHz)	LEVEL (dB μ V)		LINE	LIMIT (dB μ V)		MARGIN (dB)	
	Q-Peak	Average		Q-Peak	Average	Q-Peak	Average
0.22	48.90	33.60	N	62.82	52.82	13.92	19.22
0.72	34.60	26.80	N	56.00	46.00	21.40	19.20
2.43	36.50	31.60	N	56.00	46.00	19.50	14.40
9.16	28.60	19.90	N	60.00	50.00	31.40	30.10
12.73	41.40	31.10	N	60.00	50.00	18.60	18.90
15.84	36.20	28.10	N	60.00	50.00	23.80	21.90
0.21	51.10	34.80	H	63.21	53.21	12.11	18.41
0.29	44.00	25.70	H	60.52	50.52	16.52	24.82
0.66	37.90	27.90	H	56.00	46.00	18.10	18.10
9.18	26.10	16.20	H	60.00	50.00	33.90	33.80
13.12	35.20	26.90	H	60.00	50.00	24.80	23.10
15.89	34.80	22.90	H	60.00	50.00	25.20	27.10

Remark;

- Line (H): Hot, Line (N): Neutral
- Each charging mode with client device (1 %, 50 % and 99 % of battery) was tested. As worst condition, charging mode with client device (1 %) is reported.
- The limit for Class B device(s) from 150 kHz to 30 MHz are specified in section of the Title 47 CFR.
- Traces shown in plot were made by using a peak detector and average detector.
- Deviations to the Specifications: None.

- Test plots

Test mode: (Neutral)

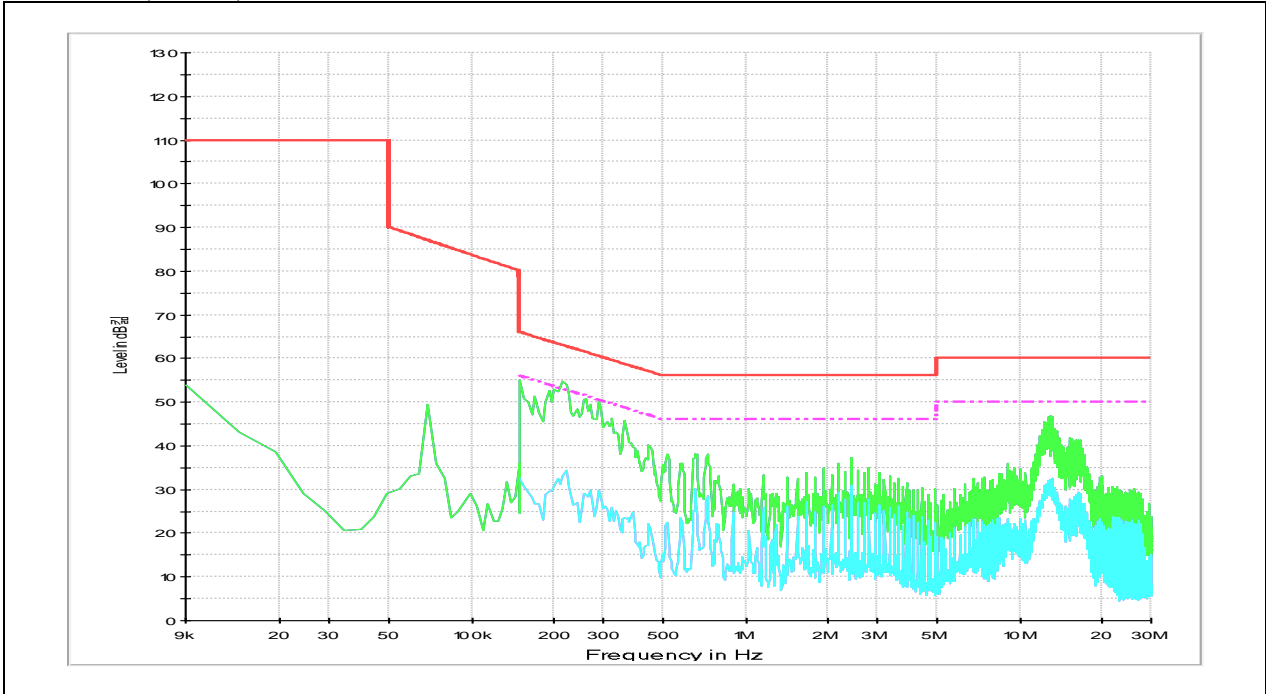

Test mode: (Hot)

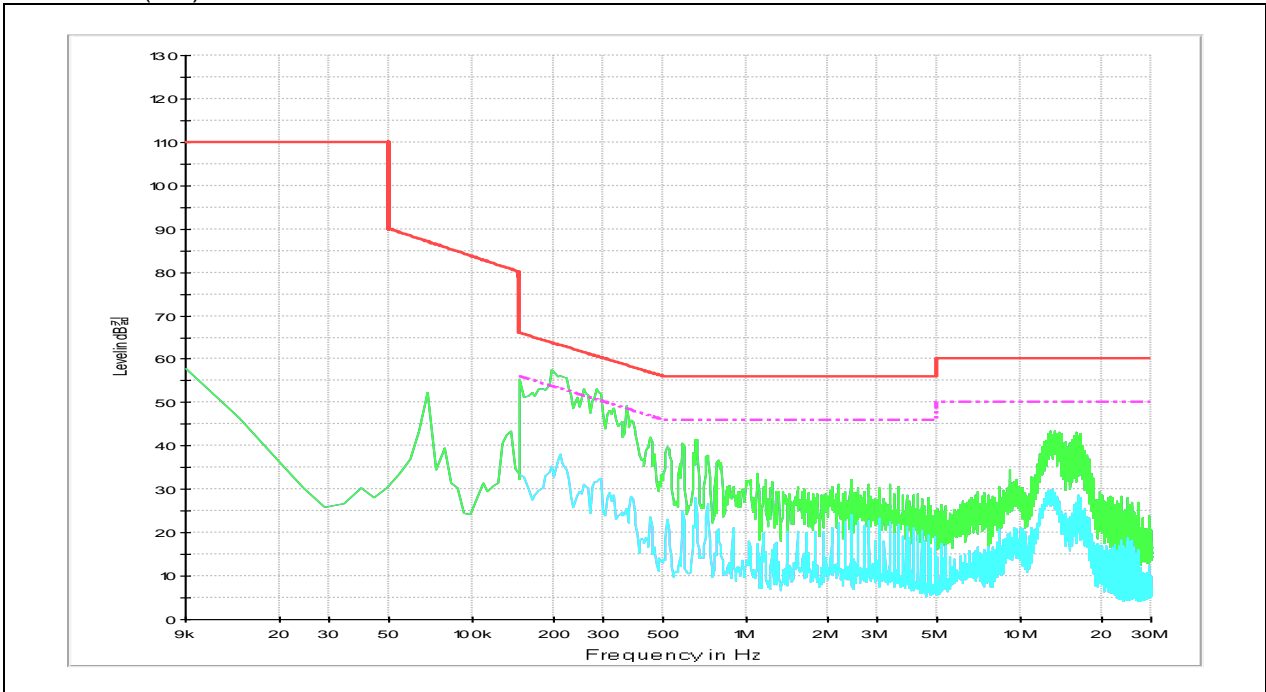

Test Condition: 7.5 W Operating mode with client device (1 % battery status of client device)

Ant. 1 (126.2 kHz ~ 129.2 kHz)

FREQ. (MHz)	LEVEL (dB μ V)		LINE	LIMIT (dB μ V)		MARGIN (dB)	
	Q-Peak	Average		Q-Peak	Average	Q-Peak	Average
0.16	56.50	42.00	N	65.46	55.46	8.96	13.46
0.23	48.70	34.50	N	62.45	52.45	13.75	17.95
0.66	34.80	23.40	N	56.00	46.00	21.20	22.60
3.07	36.10	31.30	N	56.00	46.00	19.90	14.70
9.43	29.90	21.80	N	60.00	50.00	30.10	28.20
13.37	42.30	34.20	N	60.00	50.00	17.70	15.80
0.16	54.40	39.80	H	65.46	55.46	11.06	15.66
0.65	34.40	24.00	H	56.00	46.00	21.60	22.00
2.04	28.40	23.80	H	56.00	46.00	27.60	22.20
6.65	24.90	17.90	H	60.00	50.00	35.10	32.10
9.60	27.30	20.10	H	60.00	50.00	32.70	29.90
14.03	42.30	31.80	H	60.00	50.00	17.70	18.20

Remark;

- Line (H): Hot, Line (N): Neutral
- Each charging mode with client device (1 %, 50 % and 99 % of battery) was tested. As worst condition, charging mode with client device (1 %) is reported.
- The limit for Class B device(s) from 150 kHz to 30 MHz are specified in section of the Title 47 CFR.
- Traces shown in plot were made by using a peak detector and average detector.
- Deviations to the Specifications: None.

- Test plots

Test mode: (Neutral)

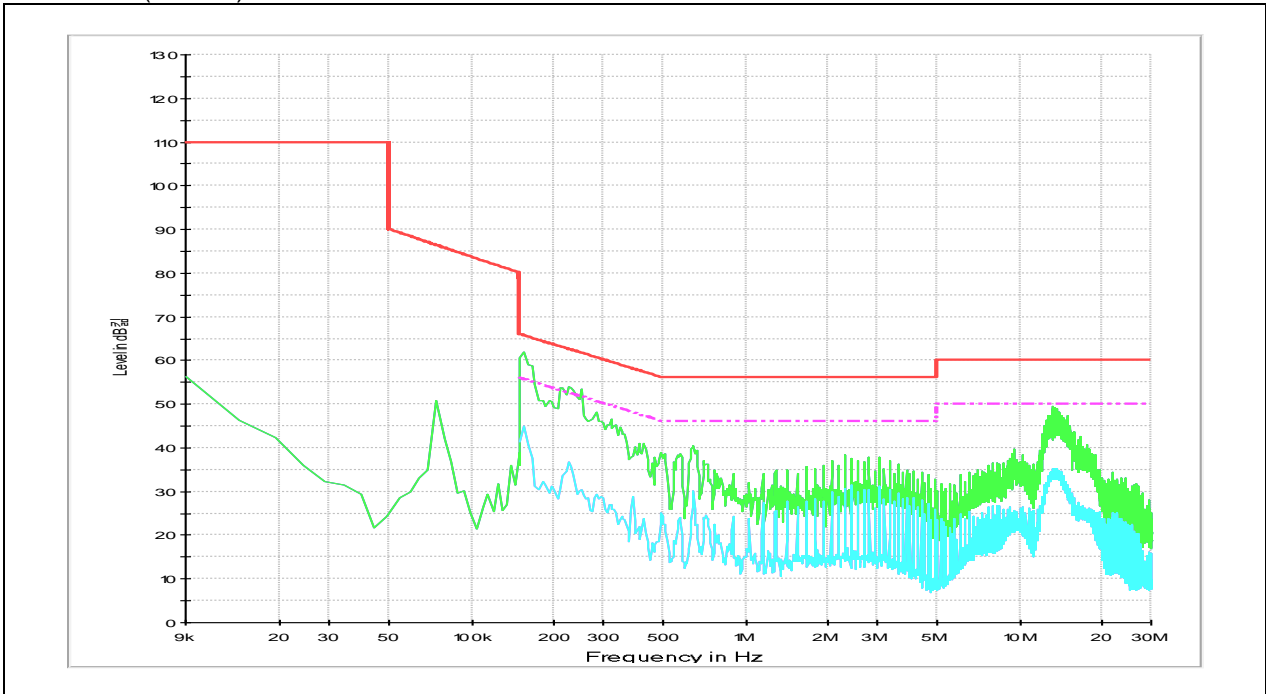

Test mode: (Hot)

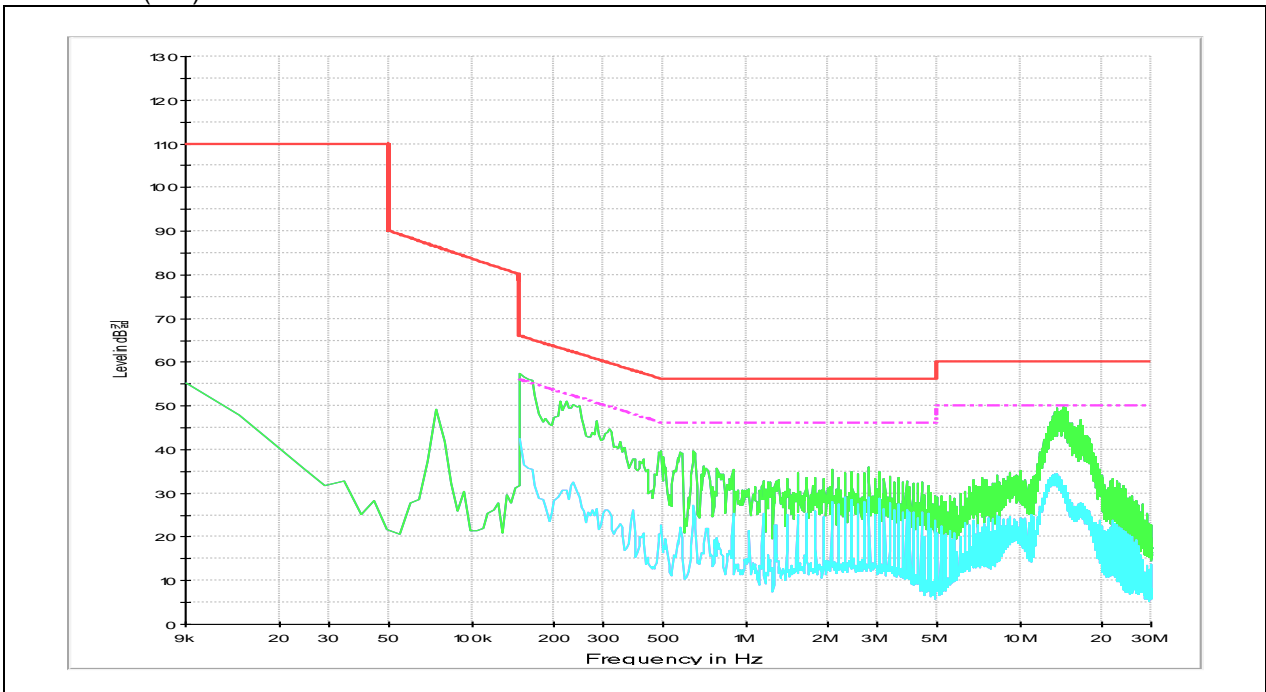

Test Condition: 9 W Operating mode with client device (1 % battery status of client device)

Ant. 1 (126.2 kHz ~ 129.2 kHz)

FREQ. (MHz)	LEVEL (dB μ V)		LINE	LIMIT (dB μ V)		MARGIN (dB)	
	Q-Peak	Average		Q-Peak	Average	Q-Peak	Average
0.16	52.40	38.00	N	65.46	55.46	13.06	17.46
0.65	33.30	24.90	N	56.00	46.00	22.70	21.10
2.04	31.40	26.40	N	56.00	46.00	24.60	19.60
3.84	33.70	28.90	N	56.00	46.00	22.30	17.10
9.44	30.00	21.90	N	60.00	50.00	30.00	28.10
12.97	42.50	34.40	N	60.00	50.00	17.50	15.60
0.16	53.40	38.70	H	65.46	55.46	12.06	16.76
0.57	34.60	21.50	H	56.00	46.00	21.40	24.50
2.03	24.80	13.80	H	56.00	46.00	31.20	32.20
9.70	26.70	20.10	H	60.00	50.00	33.30	29.90
12.93	40.50	33.00	H	60.00	50.00	19.50	17.00
16.75	38.80	27.40	H	60.00	50.00	21.20	22.60

Remark;

1. Line (H): Hot, Line (N): Neutral
2. Each charging mode with client device (1 %, 50 % and 99 % of battery) was tested.
As worst condition, charging mode with client device (1 %) is reported.
3. The limit for Class B device(s) from 150 kHz to 30 MHz are specified in section of the Title 47 CFR.
4. Traces shown in plot were made by using a peak detector and average detector.
5. Deviations to the Specifications: None.

- Test plots

Test mode: (Neutral)

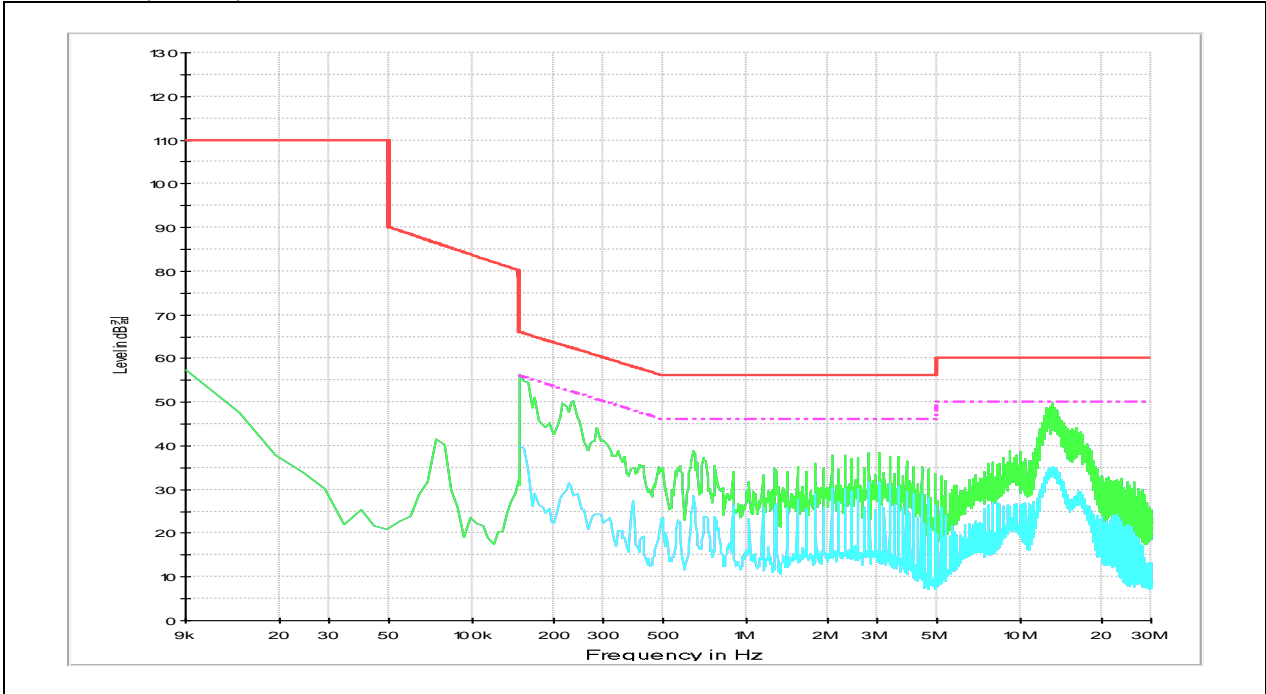

Test mode: (Hot)

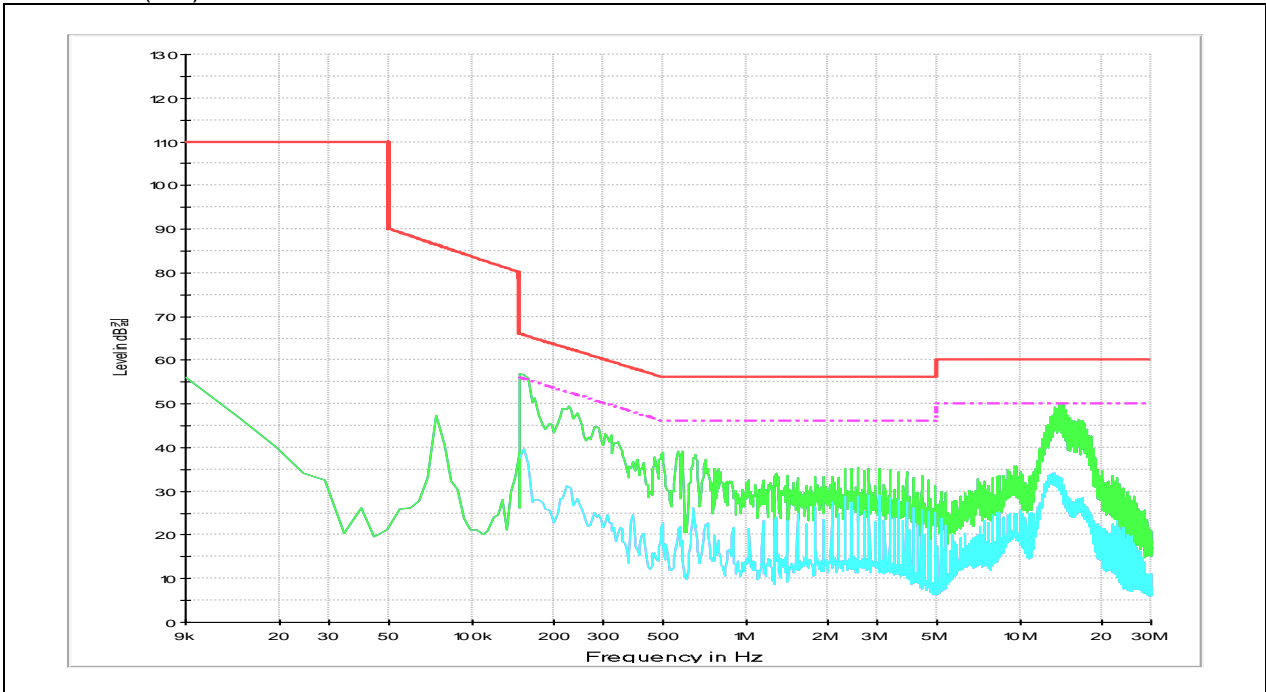

Test Condition: 2 W & 9 W Operating mode with client device (1 % battery status of client device)

Ant. 1 (126.2 kHz ~ 129.2 kHz) & Ant. 2 (144.5 kHz ~ 147.5 kHz)

FREQ. (MHz)	LEVEL (dB μ V)		LINE	LIMIT (dB μ V)		MARGIN (dB)	
	Q-Peak	Average		Q-Peak	Average	Q-Peak	Average
0.16	54.00	41.20	N	65.46	55.46	11.46	14.26
0.23	47.90	34.70	N	62.45	52.45	14.55	17.75
0.64	31.80	26.20	N	56.00	46.00	24.20	19.80
2.04	31.70	26.50	N	56.00	46.00	24.30	19.50
12.92	43.80	35.20	N	60.00	50.00	16.20	14.80
16.05	37.40	28.90	N	60.00	50.00	22.60	21.10
0.16	53.10	39.50	H	65.46	55.46	12.36	15.96
0.23	46.50	33.00	H	62.45	52.45	15.95	19.45
0.77	32.50	23.70	H	56.00	46.00	23.50	22.30
9.36	27.80	21.00	H	60.00	50.00	32.20	29.00
13.60	43.00	33.30	H	60.00	50.00	17.00	16.70
16.17	41.20	29.20	H	60.00	50.00	18.80	20.80

Remark;

1. Line (H): Hot, Line (N): Neutral
2. Each charging mode with client device (1 %, 50 % and 99 % of battery) was tested. As worst condition, charging mode with client device (1 %) is reported.
3. The limit for Class B device(s) from 150 kHz to 30 MHz are specified in section of the Title 47 CFR.
4. Traces shown in plot were made by using a peak detector and average detector.
5. Deviations to the Specifications: None.

- Test plots

Test mode: (Neutral)

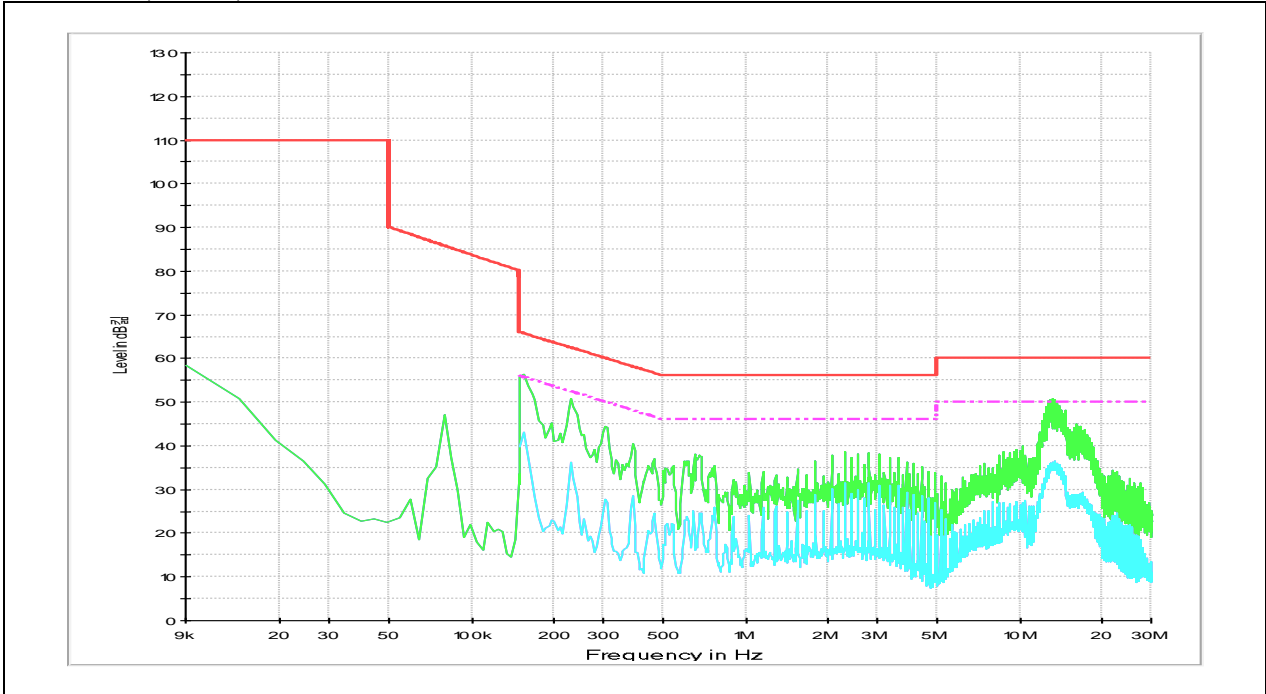

Test mode: (Hot)

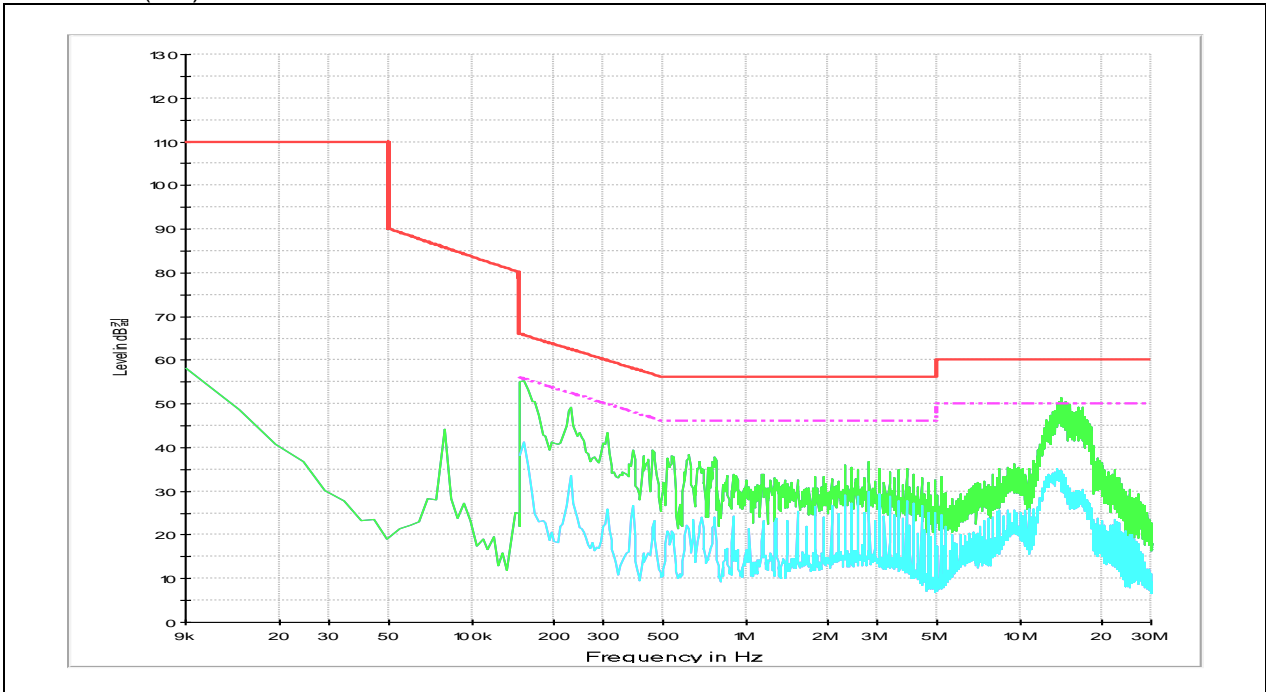

- End of the Test Report -