

TEST REPORT

of

FCC Part 15 Subpart C §15.209

FCC ID: A3LEPOR900

Equipment Under Test : WIRELESS CHARGER
Model Name : EP-OR900
Variant Model Name(s) : -
Applicant : Samsung Electronics Co., Ltd.
Manufacturer : Samsung Electronics Co., Ltd.
Date of Receipt : 2022.04.14
Date of Test(s) : 2022.04.20 ~ 2022.05.03
Date of Issue : 2022.05.06

In the configuration tested, the EUT complied with the standards specified above. This test report does not assure KOLAS accreditation.

- 1) The results of this test report are effective only to the items tested.
- 2) The SGS Korea is not responsible for the sampling, the results of this test report apply to the sample as received.
- 3) This test report cannot be reproduced, except in full, without prior written permission of the Company.

Tested by:



Teo Kim

Technical
Manager:



Jinhyoung Cho

SGS Korea Co., Ltd. Gunpo Laboratory



SGS Korea Co., Ltd.

4, LS-ro 182beon-gil, Gunpo-si, Gyeonggi-do, Korea, 15807
Tel. +82 31 428 5700 / Fax. +82 31 427 2370
<http://www.sgsgroup.kr>

Report Number: F690501-RF-RTL003096

Page: 2 of 25

INDEX

Table of Contents

1. General Information	3
2. Field Strength of Fundamental and Spurious Emission	7
3. 20 dB Bandwidth	17
4. AC Power Line Conducted Emission	20

1. General Information

1.1. Testing Laboratory

- SGS Korea Co., Ltd. (Gunpo Laboratory)
- 10-2, LS-ro 182beon-gil, Gunpo-si, Gyeonggi-do, Korea, 15807
 - 4, LS-ro 182beon-gil, Gunpo-si, Gyeonggi-do, Korea, 15807
 - Designation number: KR0150

All SGS services are rendered in accordance with the applicable SGS conditions of service available on request and accessible at <http://www.sgs.com/en/Terms-and-Conditions.aspx>.

Phone No. : +82 31 688 0901
 Fax No. : +82 31 688 0921

1.2. Details of Applicant

Applicant : Samsung Electronics Co., Ltd.
 Address : 19 Chapin Rd., Building D, Pine Brook, New Jersey, United States, 07058
 Contact Person : Jenni, Chun
 Phone No. : +1 973 808 6361

1.3. Details of Manufacturer

Company : Samsung Electronics Co., Ltd.
 Address : Yen Phong 1 Industrial park, Yen Phong District Bac Ninh Province, VIETNAM

1.4. Description of EUT

Kind of Product	WIRELESS CHARGER
Model Name	EP-OR900
Serial Number	R37T4DA00T1RTA
Power Supply	DC 5 V
Operation Mode	5 W
Frequency Range	143.5 ~ 146.5 kHz
Antenna Type	Loop Coil Antenna
Antenna Serial Number	W2401
PCB Version	EP-OR900 REV0.5, EP-OR900 REV0.6
H/W Version	01
S/W Version	V3.2

1.5. Declaration of Manufacturer

- The antenna can only operate on Smart Wearable Device.
- The EUT is two PCB versions, both of which use the same antenna.

1.6. Test Equipment List

Equipment	Manufacturer	Model	S/N	Cal. Date	Cal. Interval	Cal. Due
Spectrum Analyzer	R&S	FSV30	103210	Dec. 08, 2021	Annual	Dec. 08, 2022
Signal Generator	R&S	SMBV100A	255834	May 31, 2021	Annual	May 31, 2022
Amplifier	H.P.	8447F	2944A03909	Aug. 06, 2021	Annual	Aug. 06, 2022
Loop Antenna	Schwarzbeck Mess-Elektronik	FMZB 1519	1519-039	Aug. 23, 2021	Biennial	Aug. 23, 2023
Bilog Antenna	Schwarzbeck Mess-Elektronik	VULB9163	01126	Feb. 07, 2022	Annual	Feb. 07, 2023
Test Receiver	R&S	ESU26	100109	Jan. 18, 2022	Annual	Jan. 18, 2023
Turn Table	Innco systems GmbH	DS 1200 S	N/A	N.C.R.	N/A	N.C.R.
Controller	Innco systems GmbH	CONTROLLER CO3000-4P	CO3000/963/38 330516/L	N.C.R.	N/A	N.C.R.
Anechoic Chamber	SY Corporation	L x W x H (9.6 m x 6.4 m x 6.6 m)	N/A	N.C.R.	N/A	N.C.R.
Coaxial Cable	RFONE	PL360P-292M292M-1.5M- A	20200324002	Feb. 18, 2022	Semi-Annual	Aug. 18, 2022
Coaxial Cable	RFONE	MWX221-NMSNMS (4 m)	J1023142	Apr. 04, 2022	Semi-Annual	Oct. 04, 2022
Coaxial Cable	RFONE	142A SERIES 502839-8 (10 m)	90000034	Apr. 04, 2022	Semi-Annual	Oct. 04, 2022
Test Receiver	R&S	ESCI 7	100911	Feb. 23, 2022	Annual	Feb. 23, 2023
Two-Line V-Network	R&S	ENV216	100190	May 04, 2021	Annual	May 04, 2022
Shield Room	SY Corporation	L x W x H (6.5 m x 3.5 m x 3.5 m)	N/A	N.C.R.	N/A	N.C.R.

► Support Equipment

Description	Manufacturer	Model	FCC ID
Smart Wearable Device	Samsung Electronics Co., Ltd.	SM-R500	A3LSMR500
TRAVEL ADAPTER	RFTECH THAI NGUYEN CO.,LTD	EP-TA800 001	-

1.7. Summary of Test Results

The EUT has been tested according to the following specifications:

APPLIED STANDARD: FCC Part 15 Subpart C		
Section	Test Item(s)	Result
15.209	Radiated Emission, Spurious Emission and Field Strength of Fundamental	Complied
2.1049	20 dB Bandwidth	Complied
15.207	AC Power Line Conducted Emission	Complied

Note;

- Due to the frequency range of the device is less than 1 MHz, so we perform Middle frequency according to 15.31 requirement.
- According to the manufacturer, the EUT is two PCB versions, both of which use the same antenna. So we tested all the versions.

1.8. Test Procedure(s)

The measurement procedures described in the American National Standard of Procedure for Compliance Testing of unlicensed Wireless Devices (ANSI C63.10-2013).

1.9. Sample Calculation

Where relevant, the following sample calculation is provided:

$$\text{Field strength level (dB}\mu\text{V/m)} = \text{Measured level (dB}\mu\text{V)} + \text{Antenna factor (dB)} + \text{Cable loss (dB)} + \text{(AMP (dB))}$$

1.10. Test Report Revision

Revision	Report Number	Date of Issue	Description
0	F690501-RF-RTL003096	2022.05.06	Initial

1.11. Measurement Uncertainty

Where relevant, the following measurement uncertainty levels have been estimated for tests performed on the apparatus:

Parameter	Uncertainty	
20 dB Bandwidth	13.12 kHz	
AC Conducted Emission	3.45 dB	
Radiated Emission, 9 kHz to 30 MHz	H	3.66 dB
	V	3.66 dB
Radiated Emission, below 1 GHz	H	4.90 dB
	V	4.82 dB

All measurement uncertainty values are shown with a coverage factor of $k=2$ to indicate a 95 % level of confidence.

1.12. Worst Case of Test Configurations

Charging mode with client device	Mode	Description
Model: SM-R500 FCC ID: A3LSMR500	5 W	1 % of battery
	Ant. 1: 144.5 ~ 147.5 kHz	50 % of battery 99 % of battery

Note;

- EUT was investigated with client device under normal charging condition as above then worst value was only reported.

2. Field Strength of Fundamental and Spurious Emission

2.1. Test Setup

The diagram below shows the test setup that is utilized to make the measurements for emission from 9 MHz to 30 MHz.

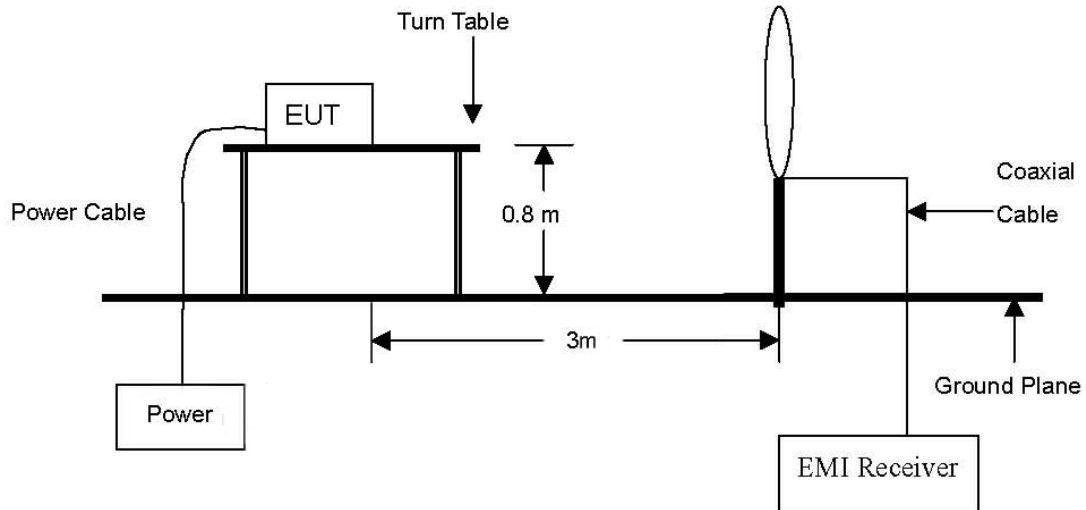

The diagram below shows the test setup that is utilized to make the measurements for emission from 30 MHz to 1 GHz.

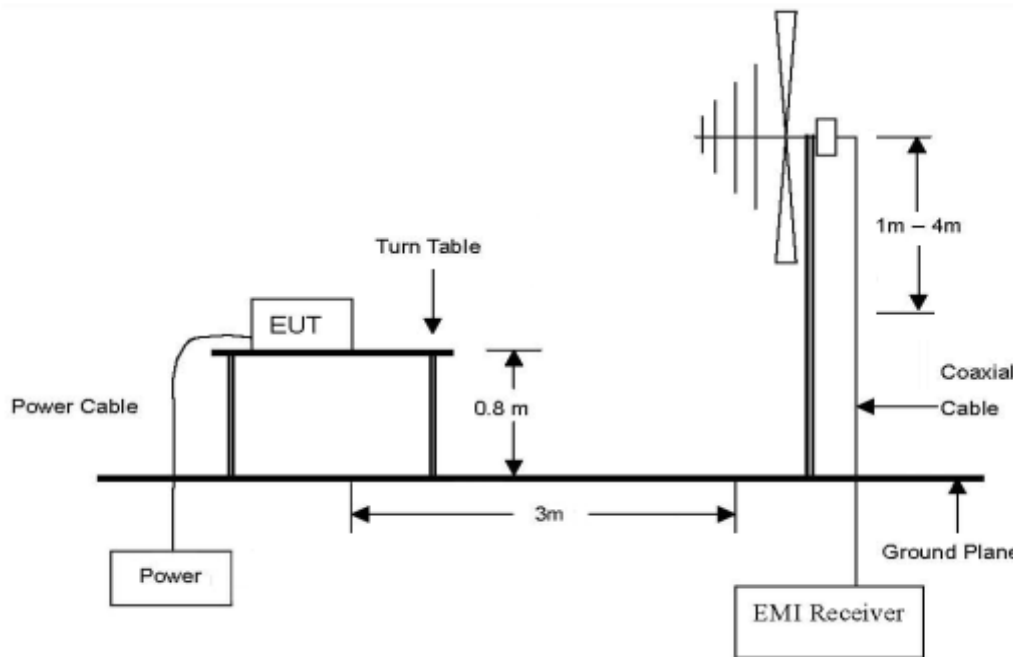

2.2. Limit

2.2.1. Radiated emission limits, general requirements

According to §15.209(a), except as provided elsewhere in this subpart, the emissions from an intentional radiator shall not exceed the field strength levels specified in the following table:

Frequency (MHz)	Field Strength (microvolts/meter)	Measurement Distance (meter)
0.009-0.490	2 400/F(kHz)	300
0.490-1.705	24 000/F(kHz)	30
1.705-30.0	30	30
30-88	100**	3
88-216	150**	3
216-960	200**	3
Above 960	500	3

** Except as provided in paragraph (g), fundamental emissions from intentional radiators operating under this section shall not be located in the frequency bands 54-72 MHz, 76-88 MHz, 174-216 MHz or 470-806 MHz. however, operation within these frequency bands is permitted under other sections of this part, e.g., §§15.231 and 15.241

2.3. Test Procedures

Radiated emissions from the EUT were measured according to the dictates of ANSI C63.10:2013.

2.3.1. Test Procedures for emission from 9 kHz to 30 MHz

- a. The EUT was placed on the top of a rotating table 0.8 meters above the ground at a 3 meter anechoic chamber test site. The table was rotated 360 degrees to determine the position of the highest radiation.
- b. Then antenna is a loop antenna is fixed at one meter above the ground to determine the maximum value of the field strength. Both parallel and perpendicular of the antenna are set to make the measurement.
- c. For each suspected emission, the EUT was arranged to its worst case and then the table was turned from 0 degrees to 360 degrees to find the maximum reading.
- d. The test-receiver system was set to Quasi Peak and Average Detect Function and Specified Bandwidth with Maximum Hold Mode.

2.3.2. Test Procedures for emission from 30 MHz to 1 000 MHz

- a. The EUT was placed on the top of a rotating table 0.8 meters above the ground at a 3 meter anechoic chamber test site. The table was rotated 360 degrees to determine the position of the highest radiation.
- b. During performing radiated emission below 1 GHz, the EUT was set 3 meters away from the interference receiving antenna, which was mounted on the top of a variable-height antenna tower. During performing radiated emission above 1 GHz, the EUT was set 3 meter away from the interference-receiving antenna.
- c. The antenna is a broadband antenna, and its height is varied from one meter to four meters above the ground to determine the maximum value of the field strength. Both horizontal and vertical polarizations of the antenna are set to make the measurement.
- d. For each suspected emission, the EUT was arranged to its worst case and then the antenna was tuned to heights from 1 meter to 4 meters and the table was turned from 0 degrees to 360 degrees to find the maximum reading.
- e. The test-receiver system was set to Peak Detect Function and Specified Bandwidth with Maximum Hold Mode.
- f. For measurements below 1 GHz resolution bandwidth is set to 100 kHz for peak detection measurements or 120 kHz for quasi-peak detection measurements. Peak detection is used unless otherwise noted as quasi-peak.

2.4. Field Strength of Fundamental Test Result

Ambient temperature : (23 ± 1) °C
 Relative humidity : 47 % R.H.

The following table shows the highest levels of radiated emissions on between polarizations of horizontal and vertical.

- PCB Version: EP-OR900 REV0.5

Test Condition: 5 W Operating mode with client device (1 % battery status of client device)

Radiated Emissions			Ant.	Correction Factors		Total		Limit	
Frequency (MHz)	Reading (dB μ V)	Detect Mode	Pol.	AF (dB/m)	CL (dB)	Actual (dB μ V/m) at 3 m	Actual (dB μ V/m) at 300 m	Limit (dB μ V/m) at 300 m	Margin (dB)
Ant. 1 (143.5 kHz ~ 146.5 kHz)									
0.144	40.20	Average	H	17.90	0.02	58.12	-21.88	24.44	46.32

- PCB Version: EP-OR900 REV0.6

Test Condition: 5 W Operating mode with client device (1 % battery status of client device)

Radiated Emissions			Ant.	Correction Factors		Total		Limit	
Frequency (MHz)	Reading (dB μ V)	Detect Mode	Pol.	AF (dB/m)	CL (dB)	Actual (dB μ V/m) at 3 m	Actual (dB μ V/m) at 300 m	Limit (dB μ V/m) at 300 m	Margin (dB)
Ant. 1 (143.5 kHz ~ 146.5 kHz)									
0.146	38.60	Average	H	17.90	0.02	56.52	-23.48	24.32	47.80

Remark;

- According to §15.31(f)(2),
 - 300 m Result (dB μ V/m) = 3 m Result (dB μ V/m) - 40log (300/3) (dB μ V/m).
- According to field strength table of general requirement in §15.209(a), field strength limits below 1.705 MHz were calculated as below.
 - 9 kHz to 490 kHz: 20log (2 400 / F (kHz)) at 300 m (dB μ V/m)
 - 490 kHz to 1.705 MHz: 20log (24 000/F (kHz)) at 30 m (dB μ V/m)
- According to §15.209(d), the measurements were tested by using Quasi peak detector except for the frequency bands 9-90 kHz, 110-490 kHz and above 1 GHz in these three bands on measurements employing an average detector.
- The limit above was calculated based on table of §15.209(a).

- Test plots

PCB Version: EP-OR900 REV0.5

Test Condition: 5 W Operating mode with client device (1 % battery status of client device)

Ant. 1 (143.5 kHz ~ 146.5 kHz)

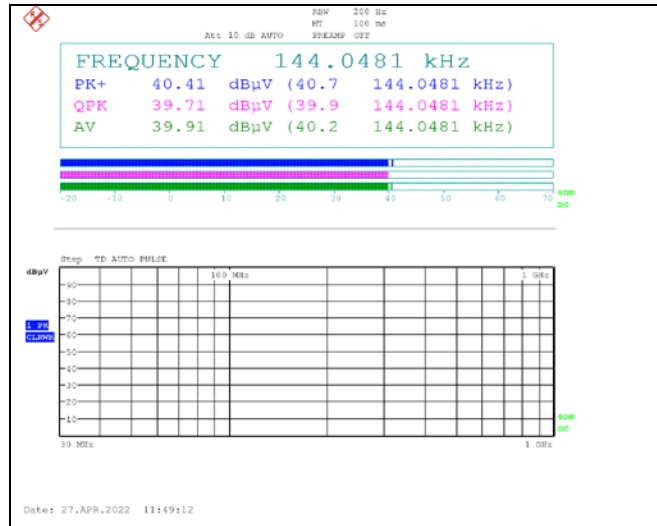

PCB Version: EP-OR900 REV0.6

Test Condition: 5 W Operating mode with client device (1 % battery status of client device)

Ant. 1 (143.5 kHz ~ 146.5 kHz)

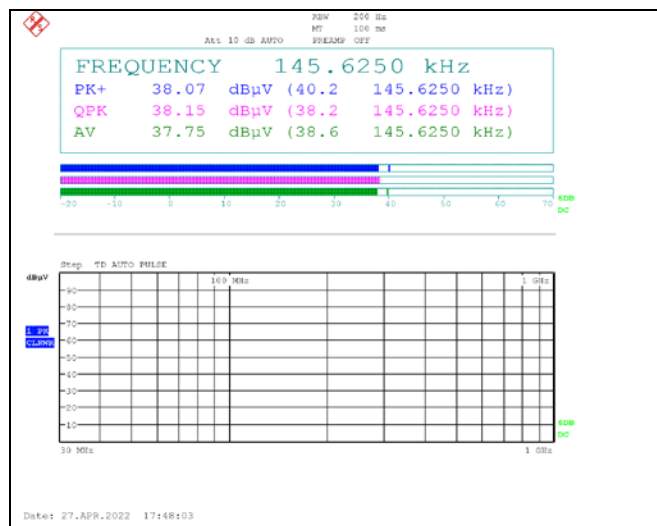

2.5. Spurious Emission Test Result

Ambient temperature : (23 ± 1) °C
 Relative humidity : 47 % R.H.

The following table shows the highest levels of radiated emissions on between polarizations of horizontal and vertical.

- PCB Version: EP-OR900 REV0.5

Test Condition: 5 W Operating mode with client device (1 % battery status of client device)

Ant. 1 (143.5 kHz ~ 146.5 kHz)

Below 30 MHz

Radiated Emissions			Ant.	Correction Factors		Total		Limit	
Frequency (MHz)	Reading (dBµV)	Detect Mode	Pol.	AF (dB/m)	CL (dB)	Actual (dBµV/m) at 3 m	Actual (dBµV/m) at 300 m or 30 m	Limit (dBµV/m) at 300 m or 30 m	Margin (dB)
0.035	30.50	Average	H	18.09	0.01	48.60	-31.40	36.72	68.12
Above 1.000	Not detected	-	-	-	-	-	-	-	-

Above 30 MHz

Radiated Emissions			Ant	Correction Factors		Total	Limit	
Frequency (MHz)	Reading (dBµV)	Detect Mode	Pol.	AF (dB/m)	AMP + CL (dB)	Actual (dBµV/m)	Limit (dBµV/m)	Margin (dB)
38.04	34.40	Peak	V	17.82	-26.62	25.60	40.00	14.40
58.13	38.90	Peak	V	18.77	-26.31	31.36	40.00	8.64
70.34	38.50	Peak	V	15.16	-26.15	27.51	40.00	12.49
109.62	32.60	Peak	V	17.44	-25.75	24.29	43.50	19.21
262.28	33.90	Peak	H	18.35	-24.28	27.97	46.00	18.03
300.87	34.30	Peak	H	19.12	-23.97	29.45	46.00	16.55
Above 400.00	Not detected	-	-	-	-	-	-	-

- PCB Version: EP-OR900 REV0.6

Test Condition: 5 W Operating mode with client device (1 % battery status of client device)

Ant. 1 (143.5 kHz ~ 146.5 kHz)

Below 30 MHz

Radiated Emissions			Ant.	Correction Factors		Total		Limit	
Frequency (MHz)	Reading (dB μ V)	Detect Mode	Pol.	AF (dB/m)	CL (dB)	Actual (dB μ V/m) at 3 m	Actual (dB μ V/m) at 300 m or 30 m	Limit (dB μ V/m) at 300 m or 30 m	Margin (dB)
0.035	31.32	Average	H	18.09	0.01	49.42	-30.58	36.72	67.30
Above 1.000	Not detected	-	-	-	-	-	-	-	-

Above 30 MHz

Radiated Emissions			Ant	Correction Factors		Total	Limit	
Frequency (MHz)	Reading (dB μ V)	Detect Mode	Pol.	AF (dB/m)	AMP + CL (dB)	Actual (dB μ V/m)	Limit (dB μ V/m)	Margin (dB)
31.70	37.00	Peak	V	16.43	-26.61	26.82	40.00	13.18
63.87	41.00	Peak	V	17.34	-26.23	32.11	40.00	7.89
109.70	33.10	Peak	V	17.43	-25.75	24.78	43.50	18.72
182.45	34.80	Peak	V	15.55	-24.97	25.38	43.50	18.12
315.54	38.40	Peak	H	19.31	-23.93	33.78	46.00	12.22
432.31	34.40	Peak	H	22.10	-24.06	32.44	46.00	13.56
Above 500.00	Not detected	-	-	-	-	-	-	-

Remark;

1. According to §15.31 (f)(2),
 - 300 m Result (dB μ V/m) = 3 m Result (dB μ V/m) - 40log (300/3) (dB μ V/m)
 - 30 m Result (dB μ V/m) = 3 m Result (dB μ V/m) - 40log (30/3) (dB μ V/m)
2. According to field strength table of general requirement in §15.209 (a), field strength limits below 1.705 MHz were calculated as below.
 - 9 kHz to 490 kHz: 20log (2 400 / F (kHz)) at 300 m (dB μ V/m)
 - 490 kHz to 1.705 MHz: 20log (24 000 / F (kHz)) at 30 m (dB μ V/m)
3. According to §15.209 (d), the measurements were tested by using Quasi peak detector except for the frequency bands 9-90 kHz, 110-490 kHz and above 1 GHz in these three bands on measurements employing an average detector.
4. The limit above was calculated based on table of §15.209 (a).
5. Radiated spurious emission measurement as below 30 MHz.
 - (Actual (dB μ A/m) at 3m = Reading (dB μ V) + AF (dB/m) + CL (dB))
6. Radiated spurious emission measurement as above 30 MHz.
 - (Actual (dB μ A/m) = Reading (dB μ V) + AF (dB/m) + CL (dB) + AMP (dB))
7. According to §15.31(o), emission levels are not report much lower than the limits by over 20 dB.

- Test plots

PCB Version: EP-OR900 REV0.5

Test Condition: 5 W Operating mode with client device (1 % battery status of client device)

Ant. 1 (143.5 kHz ~ 146.5 kHz)

Below 30 MHz

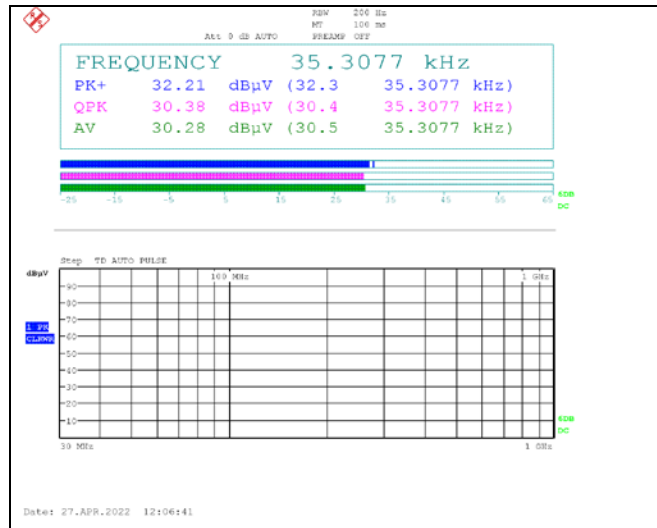

Above 30 MHz

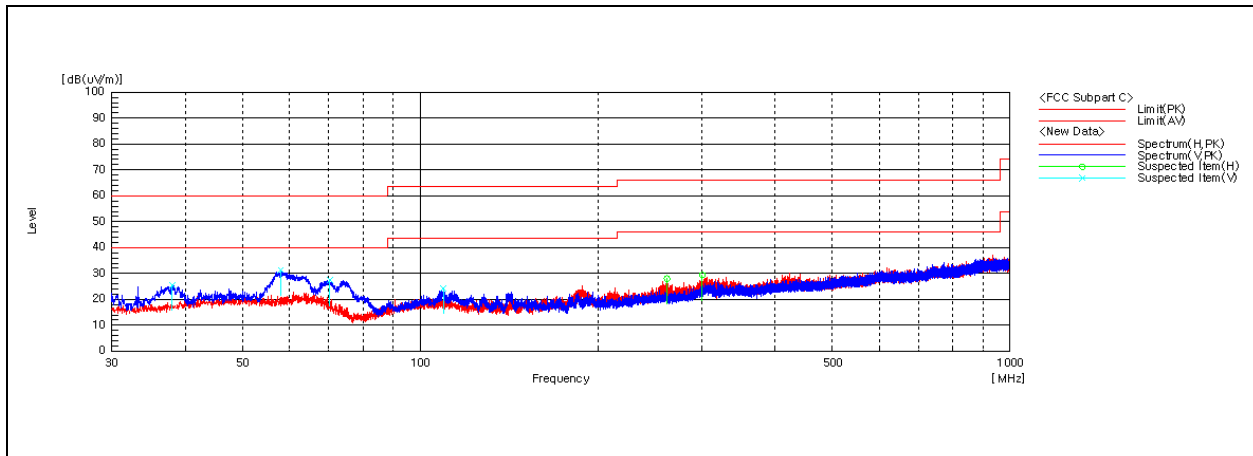

Remark;

- Traces shown in the plot were made by using a peak detector.

PCB Version: EP-OR900 REV0.6

Test Condition: 5 W Operating mode with client device (1 % battery status of client device)

Ant. 1 (143.5 kHz ~ 146.5 kHz)

Below 30 MHz

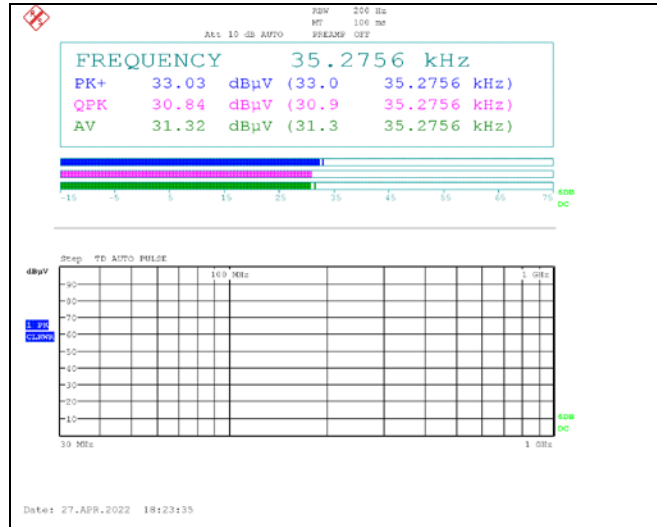

Above 30 MHz

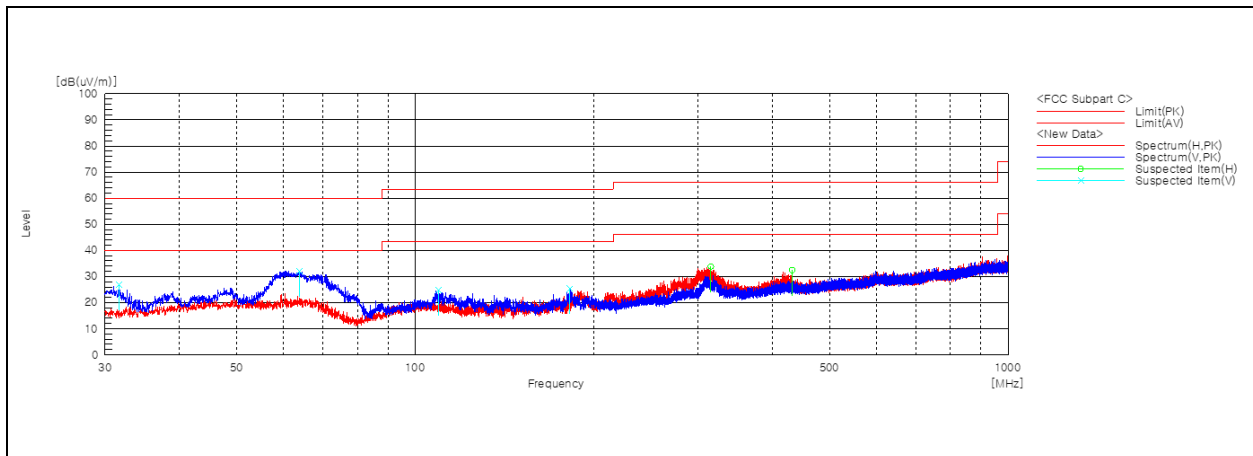

Remark;

- Traces shown in the plot were made by using a peak detector.

3. 20 dB Bandwidth

3.1. Test Setup

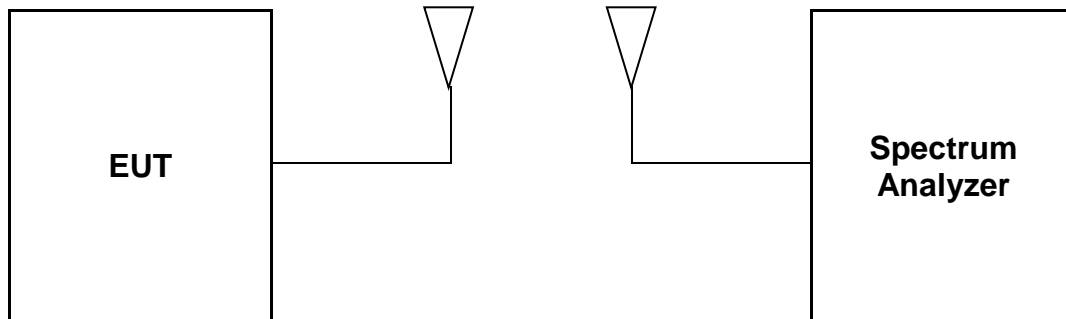

3.2. Limit

None; for reporting purposed only

3.3. Test Procedure

- a. Span = set to capture all products of the modulation process, including the emission skirts.
 RBW = 200 Hz, VBW = 200 Hz, Sweep = auto, Detector = peak, Trace = max hold.
- b. The marker-to-peak function to set the mark to the peak of the emission. Use the marker-delta function to measure 20 dB down one side of the emission. Reset the function, and move the marker to the other side of the emission, until it is (as close as possible to) even with the reference marker level. The marker-delta reading at this point is 20 dB bandwidth of the emission.

3.4. Test Result

Ambient temperature : (23 ± 1) °C
 Relative humidity : 47 % R.H.

- PCB Version: EP-OR900 REV0.5

Test Condition: 5 W Operating mode with client device (1 % battery status of client device)

Antenna	Frequency (kHz)	EUT Status	20 dB Bandwidth (kHz)	Limit
1	143.5 ~ 146.5	With client device (1 % battery status of client device)	0.557	Reporting proposed only

- PCB Version: EP-OR900 REV0.6

Test Condition: 5 W Operating mode with client device (1 % battery status of client device)

Antenna	Frequency (kHz)	EUT Status	20 dB Bandwidth (kHz)	Limit
1	143.5 ~ 146.5	With client device (1 % battery status of client device)	0.550	Reporting proposed only

- Test plots

PCB Version: EP-OR900 REV0.5

Test Condition: 5 W Operating mode with client device (1 % battery status of client device)

Ant. 1 (143.5 kHz ~ 146.5 kHz)

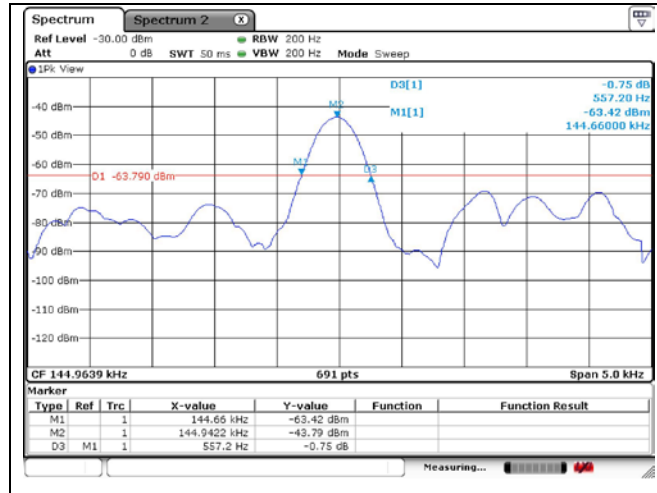

PCB Version: EP-OR900 REV0.6

Test Condition: 5 W Operating mode with client device (1 % battery status of client device)

Ant. 1 (143.5 kHz ~ 146.5 kHz)

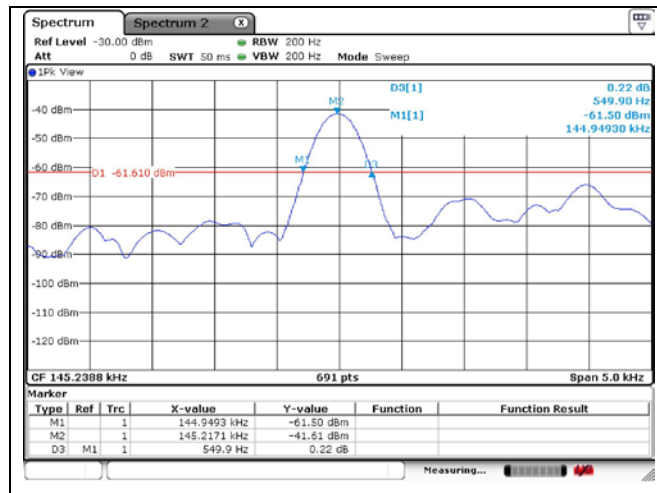

4. AC Power Line Conducted Emission

4.1. Test Setup

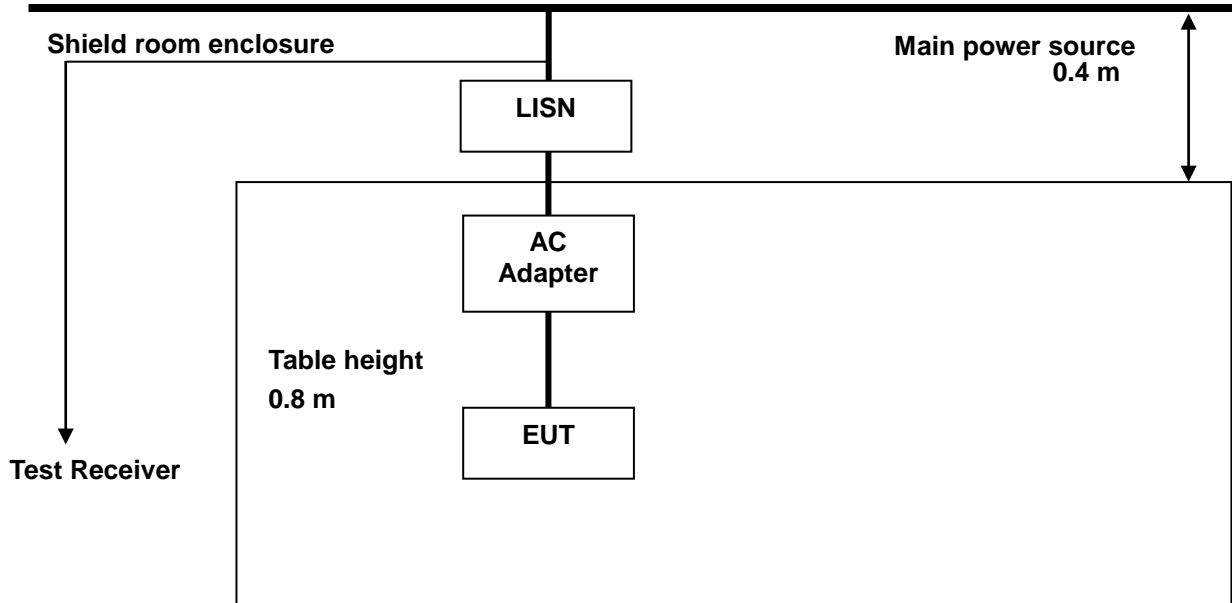

4.2. Limit

According to §15.207(a), for an intentional radiator that is designed to be connected to the public utility (AC) power line, the radio frequency voltage that is conducted back onto the AC power line on any frequency or frequencies, within the band 150 kHz to 30 MHz, shall not exceed the limits in the following table, as measured using a 50 μ H / 50 ohms line impedance stabilization network (LISN).

Compliance with the provision of this paragraph shall be based on the measurement of the radio frequency voltage between each power line and ground at the power terminal. The lower limit applies at the boundary between the frequency ranges.

Frequency of emission (MHz)	Conducted limit (dB μ V)	
	Quasi-peak	Average
0.15-0.5	66 to 56*	56 to 46*
0.5-5	56	46
5-30	60	50

* Decreases with the logarithm of the frequency.

4.3. Test Procedures

AC conducted emissions from the EUT were measured according to the dictates of ANSI C63.10:2013

1. The test procedure is performed in a 6.5 m × 3.5 m × 3.5 m (L × W × H) shielded room. The EUT along with its peripherals were placed on a 1.0 m (W) × 1.5 m (L) and 0.8 m in height wooden table and the EUT was adjusted to maintain a 0.4 meter space from a vertical reference plane.
2. The EUT was connected to power mains through a line impedance stabilization network (LISN) which provides 50 ohm coupling impedance for measuring instrument and the chassis ground was bounded to the horizontal ground plane of shielded room.
3. All peripherals were connected to the second LISN and the chassis ground also bounded to the horizontal ground plane of shielded room.
4. The excess power cable between the EUT and the LISN was bundled. The power cables of peripherals were unbundled. All connecting cables of EUT and peripherals were moved to find the maximum emission.

4.4. Test Results

The following table shows the highest levels of conducted emissions on both phase of Hot and Neutral line.

Ambient temperature : (23 ± 1) °C
 Relative humidity : 47 % R.H.
 Frequency range : 0.15 MHz - 30 MHz
 Measured Bandwidth : 9 kHz

- PCB Version: EP-OR900 REV0.5

Test Condition: 5 W Operating mode with client device (1 % battery status of client device)

Ant. 1 (143.5 kHz ~ 146.5 kHz)

FREQ. (MHz)	LEVEL (dB μ V)		LINE	LIMIT (dB μ V)		MARGIN (dB)	
	Q-Peak	Average		Q-Peak	Average	Q-Peak	Average
0.17	22.90	11.90	N	64.96	54.96	42.06	43.06
0.69	21.90	12.30	N	56.00	46.00	34.10	33.70
2.15	16.10	7.10	N	56.00	46.00	39.90	38.90
8.23	34.90	22.10	N	60.00	50.00	25.10	27.90
10.29	30.90	19.00	N	60.00	50.00	29.10	31.00
15.51	25.80	6.20	N	60.00	50.00	34.20	43.80
0.21	20.30	8.20	H	63.21	53.21	42.91	45.01
0.41	14.50	7.20	H	57.65	47.65	43.15	40.45
1.30	15.80	8.10	H	56.00	46.00	40.20	37.90
2.76	11.00	5.50	H	56.00	46.00	45.00	40.50
7.40	14.80	6.90	H	60.00	50.00	45.20	43.10
10.01	12.10	6.10	H	60.00	50.00	47.90	43.90

Remark;

1. Line (H): Hot, Line (N): Neutral
2. Each charging mode with client device (1 %, 50 % and 99 % of battery) was tested.
As worst condition, charging mode with client device (1 %) is reported.
3. The limit for Class B device(s) from 150 kHz to 30 MHz are specified in section of the Title 47 CFR.
4. Traces shown in plot were made by using a quasi-peak detector and average detector.
5. Deviations to the Specifications: None.

- PCB Version: EP-OR900 REV0.6

Test Condition: 5 W Operating mode with client device (1 % battery status of client device)

Ant. 1 (143.5 kHz ~ 146.5 kHz)

FREQ. (MHz)	LEVEL (dB μ V)		LINE	LIMIT (dB μ V)		MARGIN (dB)	
	Q-Peak	Average		Q-Peak	Average	Q-Peak	Average
0.17	32.00	14.60	N	64.96	54.96	32.96	40.36
0.68	28.70	20.90	N	56.00	46.00	27.30	25.10
1.02	22.10	15.80	N	56.00	46.00	33.90	30.20
2.19	23.90	16.00	N	56.00	46.00	32.10	30.00
4.80	15.90	9.20	N	56.00	46.00	40.10	36.80
10.03	19.90	12.60	N	60.00	50.00	40.10	37.40
0.17	30.70	13.10	H	64.96	54.96	34.26	41.86
0.69	20.90	16.10	H	56.00	46.00	35.10	29.90
1.02	14.70	11.60	H	56.00	46.00	41.30	34.40
2.19	20.60	16.00	H	56.00	46.00	35.40	30.00
10.39	36.30	34.30	H	60.00	50.00	23.70	15.70
15.37	16.90	12.20	H	60.00	50.00	43.10	37.80

Remark;

1. Line (H): Hot, Line (N): Neutral
2. Each charging mode with client device (1 %, 50 % and 99 % of battery) was tested.
As worst condition, charging mode with client device (1 %) is reported.
3. The limit for Class B device(s) from 150 kHz to 30 MHz are specified in section of the Title 47 CFR.
4. Traces shown in plot were made by using a quasi-peak detector and average detector.
5. Deviations to the Specifications: None.

- Test plots

PCB Version: EP-OR900 REV0.5

Test mode: (Neutral)

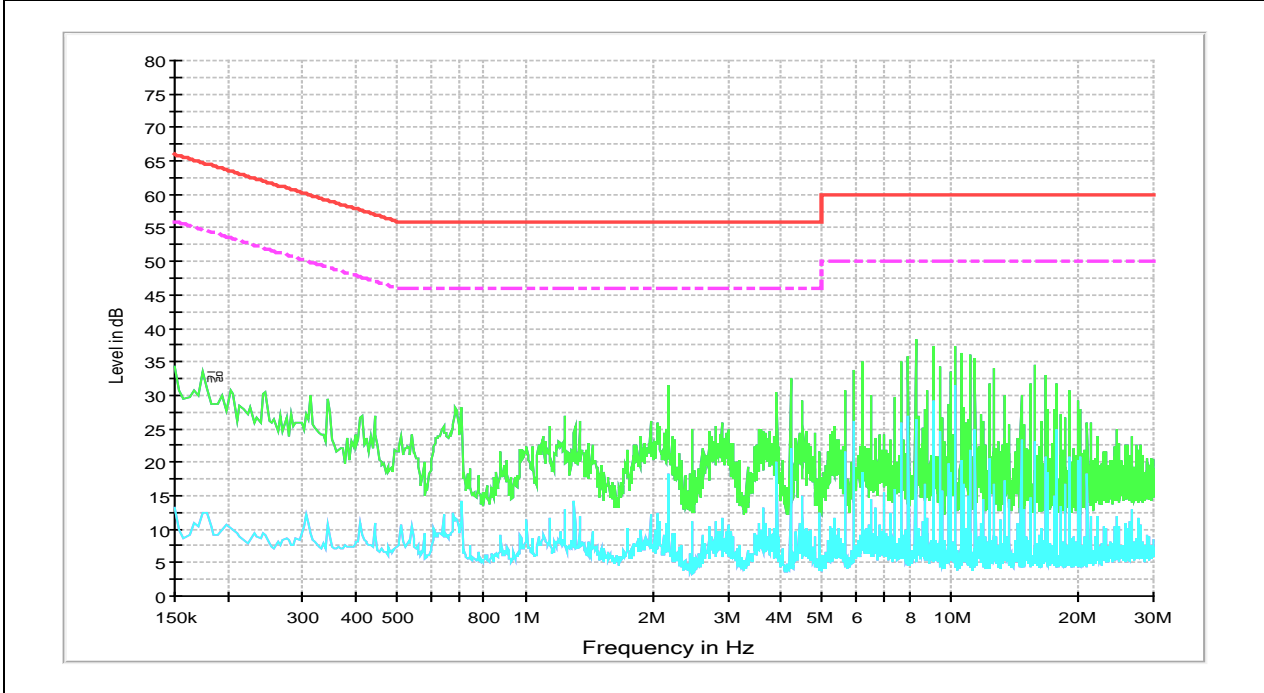

Test mode: (Hot)

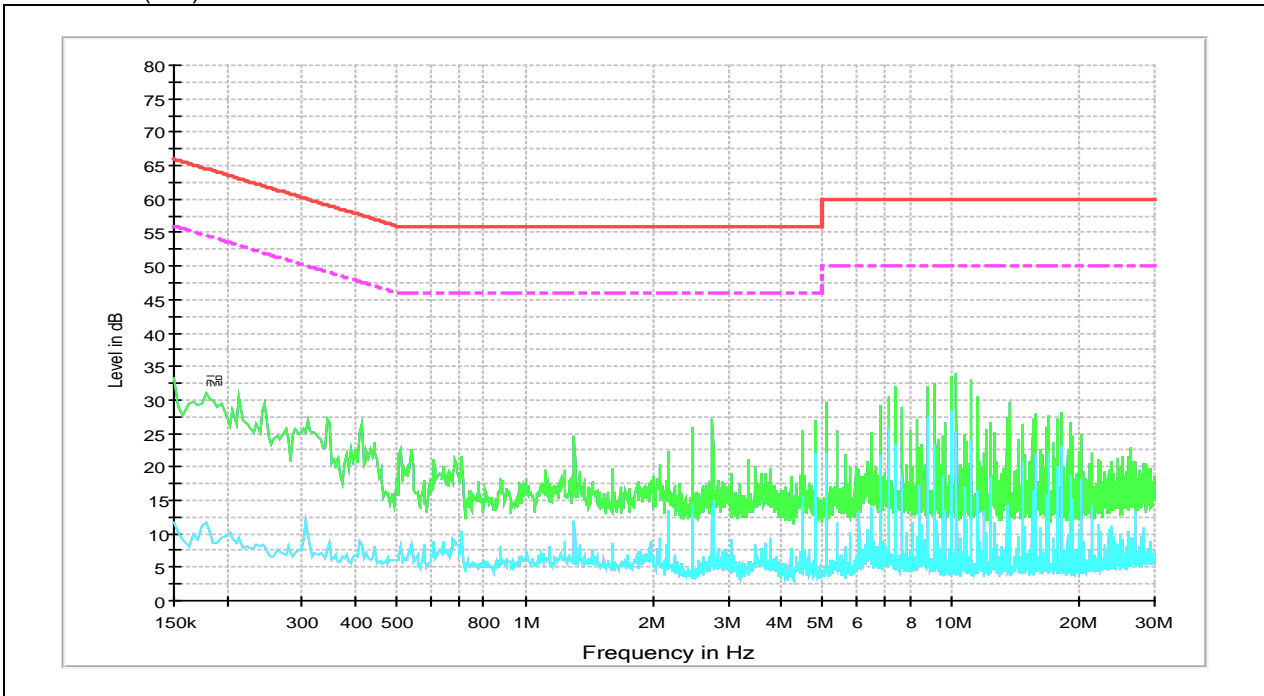

PCB Version: EP-OR900 REV0.6

Test mode: (Neutral)

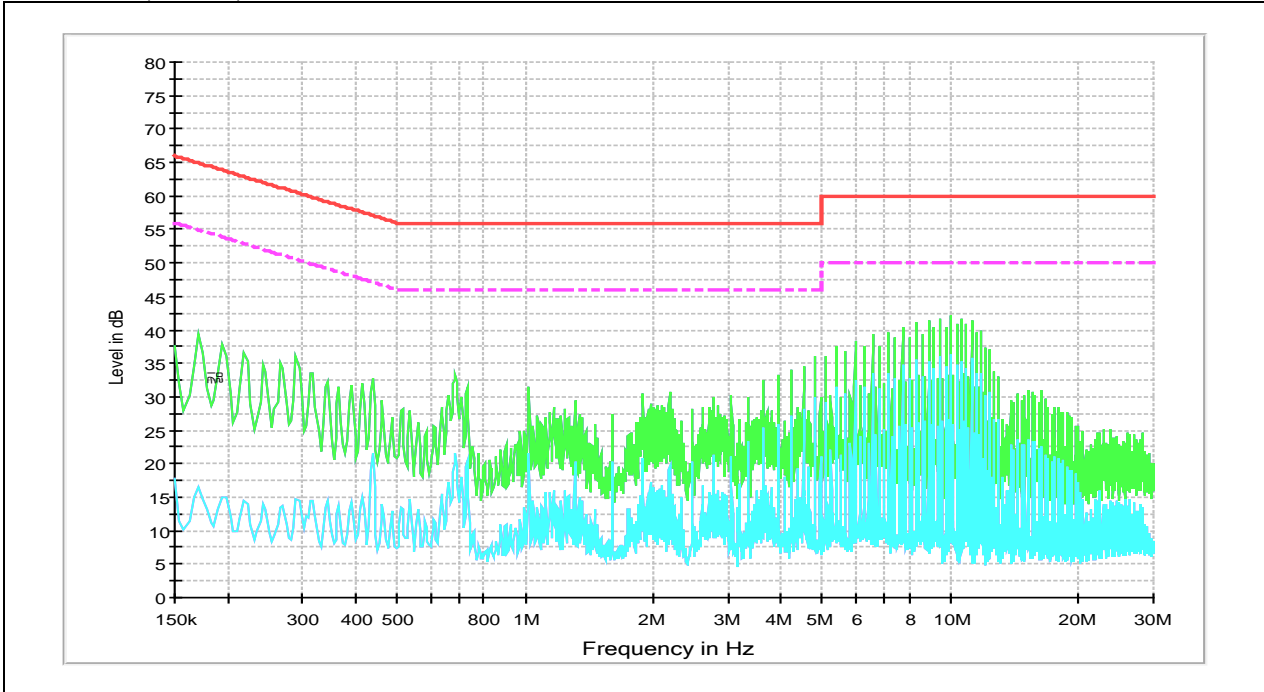

Test mode: (Hot)

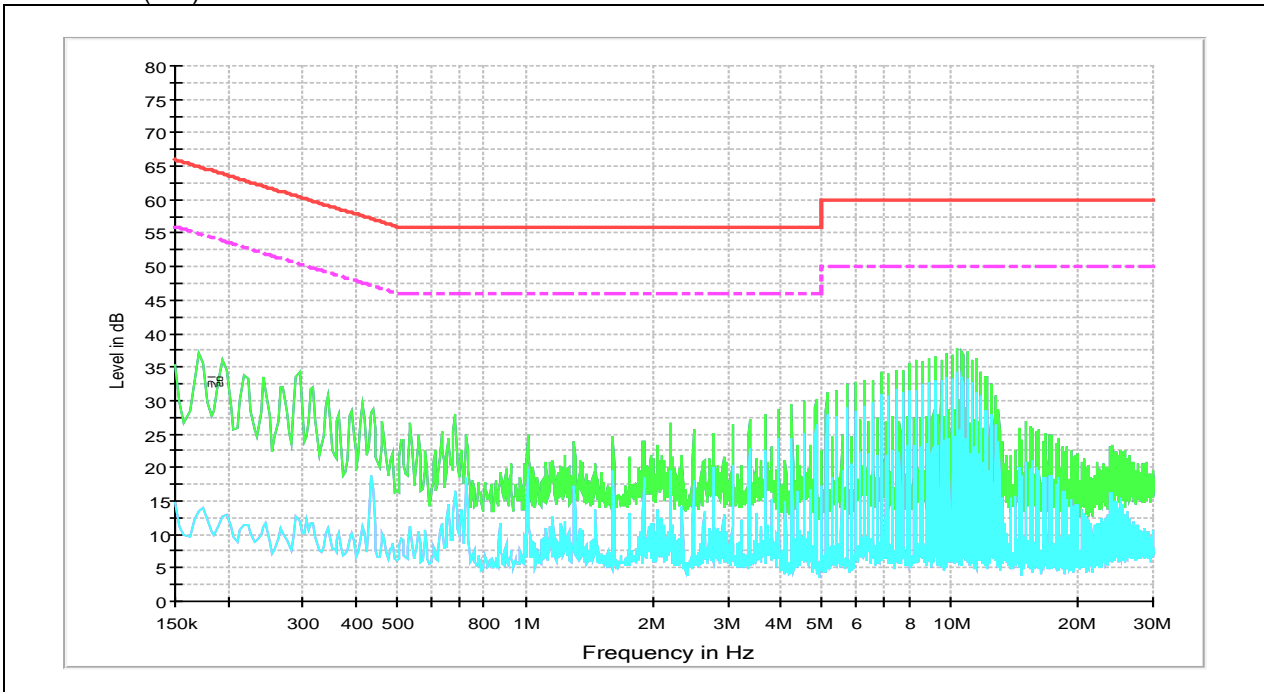

- End of the Test Report -