

TEST REPORT

of

FCC Part 15 Subpart E §15.407

FCC ID : A3LEKGC110

Equipment Under Test : Mobile imaging device
Model Name : EK-GC110
Serial No. : N/A
Applicant : SAMSUNG ELECTRONICS CO., LTD.
Manufacturer : SAMSUNG ELECTRONICS CO., LTD.
Date of Test(s) : 2013.02.07 ~ 2013.02.08
Date of Issue : 2013.02.13

In the configuration tested, the EUT complied with the standards specified above.

Tested By:



Harim Lee

Date:

2013.02.13

Approved By:



Denny Ham

Date:

2013.02.13

The results shown in this test report refer only to the sample(s) tested unless otherwise stated. This test report cannot be reproduced, except in full, without prior written permission of the Company.

SGS Korea Co., Ltd. (Gunpo Laboratory) 18-34, Sanbon-dong, Gunpo-si, Gyeonggi-do, Korea, 435-040

Tel. +82 31 428 5700 / Fax. +82 31 427 2371

www.ee.sgs.com/korea

Table of contents

1. General information	3
2. DFS (Dynamic Frequency Selection).....	5

The results shown in this test report refer only to the sample(s) tested unless otherwise stated. This test report cannot be reproduced, except in full, without prior written permission of the Company.

1. General information

1.1 Testing laboratory

SGS Korea Co., Ltd. (Gunpo Laboratory)

- Wireless Div. 3FL, 18-34, Sanbon-dong, Gunpo-si, Gyeonggi-do, Korea 435-040

All SGS services are rendered in accordance with the applicable SGS conditions of service available on request and accessible at <http://www.sgs.com/en/Terms-and-Conditions.aspx>.

Phone No. : +82 31 428 5700

Fax No. : +82 31 427 2371

1.2 Details of applicant

Applicant : SAMSUNG ELECTRONICS CO., LTD.

Address : 129, Samsung-ro, Yeongtong-gu, Suwon-si, Gyeonggi-do, 443-742 Rep. of Korea

Contact Person : Choi, Jeong-Wook

Phone No. : +82 10 8900 2047

1.3. Description of EUT

Kind of Product	Mobile imaging device
Model Name	EK-GC110
Serial Number	N/A
Power Supply	DC 3.8 V
Frequency Range	2 412 MHz ~ 2 462 MHz (11b/g/n_HT20), 5 745 MHz ~ 5 825 MHz (11a/n_HT20), 5 755 MHz ~ 5 795 MHz (11n_HT40), 5 180 MHz ~ 5 240 MHz (11a/n_HT20 – Non DFS), 5 190 MHz ~ 5 230 MHz (11n_HT40 – Non DFS), 5 260 MHz ~ 5 320 MHz (11a/n_HT20 – DFS), 5 270 MHz ~ 5 310 MHz (11n_HT40 – DFS), 5 500 MHz ~ 5 700 MHz (11a/n_HT20 – DFS), 5 510 MHz ~ 5 670 MHz (11n_HT40 – DFS)
Modulation Technique	DSSS, OFDM
Number of Channels	11 channel (11b/g/n_HT20), 5 channel (11a/n_HT20), 2 channel (11n_HT40), 4 channel (11a/n_HT20–Non DFS), 2 channel (11n_HT40 – Non DFS), 15 channel (11a/n_HT20 - DFS), 7 channel (11n_HT40 - DFS)
Antenna Type	PIFA type
Antenna Gain	2 412 MHz ~ 2 462 MHz : -2.50 dB i 5 180 MHz ~ 5 320 MHz : 6.49 dB i 5 500 MHz ~ 5 700 MHz : 6.44 dB i 5 745 MHz ~ 5 825 MHz : 6.28 dB i
H/W Version	REV1.1
S/W Version	GC110.003

The results shown in this test report refer only to the sample(s) tested unless otherwise stated. This test report cannot be reproduced, except in full, without prior written permission of the Company.

1.4. Declaration by the manufacturer

- EUT is SLAVE without DFS and TPC.

1.5. Test equipment list

Equipment	Manufacturer	Model	S/N	Cal Date	Cal Interval	Cal Due.
Spectrum Analyzer	R&S	FSV30	100955	Mar. 29, 2012	Annual	Mar. 29, 2013
Attenuator	AEROFLEX / INMET	18N – 20dB	2	Apr. 02, 2012	Annual	Apr. 02, 2013
Power Splitter	Mini-Circuits	ZFSC-2-10G	001	Jul. 12, 2012	Annual	Jul. 12, 2013
Power Splitter	Mini-Circuits	ZFSC-2-10G	002	Jul. 12, 2012	Annual	Jul. 12, 2013
DC power Supply	Agilent	U8002A	MY49030063	Dec. 20, 2012	Annual	Dec. 20, 2013

► Support equipment

Description	Manufacturer	Model	Serial Number / FCC ID
Access Point(master)	Cisco	AIR-AP1262N-K-K9	FTX1553K03A FCC ID:LDK102073
Notebook	IBM	T43	2669CC8

1.6. Summary of test result

The EUT has been tested according to the following specifications:

APPLIED STANDARD:FCC Part15 subpart E		
Section in FCC 15	Test Item	Result
15.407(h)	DFS -Channel closing transmission time -Channel move time -Non occupied period	Complied

1.7. Test report revision

Revision	Report number	Description
0	F690501/RF-RTL006270	Initial

The results shown in this test report refer only to the sample(s) tested unless otherwise stated. This test report cannot be reproduced, except in full, without prior written permission of the Company.

2. DFS (Dynamic Frequency Selection)

2.1. System overview

2.1.1. Set up of EUT

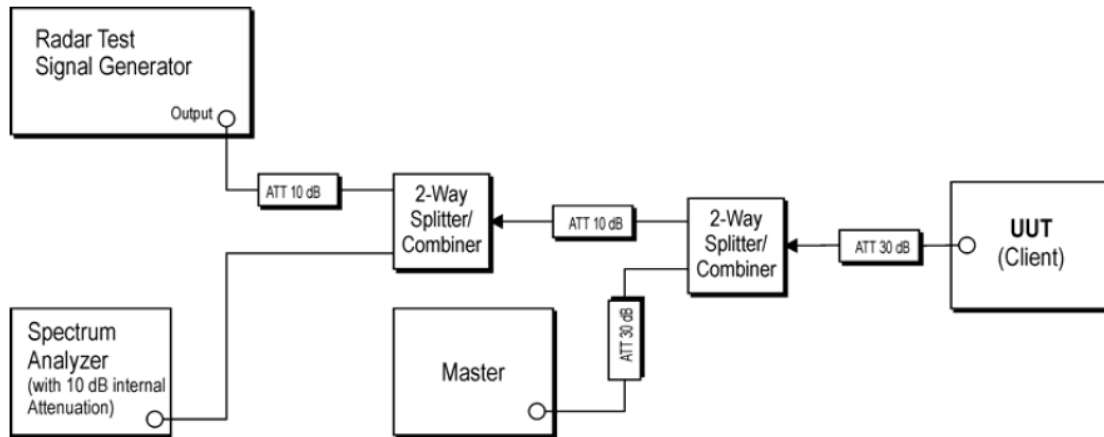

The radar signal generation equipment consists of a vector signal generator

The signal monitoring equipment consists of a spectrum analyzer set to display 8001 bins on the horizontal axis. The time domain resolution is 2 msec/bin with a 16 second sweep time, meeting the 10 second short pulse reporting criteria. The aggregate ON time is calculated by multiplying the number of bins above a threshold during a particular observation period by the dwell time per bin, with the analyzer set to peak detection and max hold.

The Slave is tested separately for compliance with the Channel Shutdown requirements, for the situation when the Slave device vacates the channel in response to detection of a radar by the Master.

All tests were performed at a channel center frequency of 5 260 MHz and 5 500 MHz. Measurements were performed using conducted test methods.

Stream the MPEG test file from the Master Device to the Client Device on the test Channel for the entire period of the test.

The designated MPEG test file and instructions are located at: <http://ntiacsd.ntia.doc.gov/dfs/>

The test file name is 'TestFile.mpg.'

The results shown in this test report refer only to the sample(s) tested unless otherwise stated. This test report cannot be reproduced, except in full, without prior written permission of the Company.

2.2 Limit

§15.407 (h) and FCC 06-96 APPENDIX “COMPLIANCE MEASUREMENT PROCEDURES FOR UNLICENSED-NATIONAL INFORMATION INFRASTRUCTURE DEVICES OPERATING IN THE 5250-5350 MHz AND 5470-5725 MHz BANDS INCORPORATING DYNAMIC FREQUENCY SELECTION

Table 1: Applicability of DFS requirements prior to use of a channel

Requirement	Operational Mode		
	Master	Client (without DFS)	Client (with DFS)
Non-Occupancy Period	Yes	Yes (according to KDB 848637)	Yes
DFS Detection Threshold	Yes	Yes (according to KDB 848637)	Yes
Channel Availability Check Time	Yes	Not required	Not required
Uniform Spreading	Yes	Not required	Not required

Table 2: Applicability of DFS requirements during normal operation

Requirement	Operational Mode		
	Master	Client (without DFS)	Client (with DFS)
DFS Detection Threshold	Yes	Not required	Yes
Channel Closing Transmission Time	Yes	Yes	Yes
Channel Move Time	Yes	Yes	Yes

Table 3: Interference Threshold values, Master or Client incorporating In-Service Monitoring

Maximum Transmit Power	Value (see note)
≥ 200 milliwatt	-64 dB m
< 200 milliwatt	-62 dB m

Note 1: This is the level at the input of the receiver assuming a 0 dB i receive antenna Note 2: Throughout these test procedures an additional 1 dB has been added to the amplitude of the test transmission waveforms to account for variations in measurement equipment. This will ensure that the test signal is at or above the detection threshold level to trigger a DFS response.

KDB 848637 : Non-Occupancy Period for Client Device without radar detection

- Test results demonstrating an associated client link is established with the master on a test frequency;
 - The client and DFS-certified master device are associated, and a movie can be streamed as specified in the DFS Order for a non-occupancy period test;
 - The test frequency has been monitored to ensure no transmission of any type has occurred for 30 minutes.
- Note: If the client moves with the master, the device is considered compliant if nothing appears in the client non-occupancy period test. For devices that shut down (rather than moving channels), no beacons should appear;
- An analyzer plot that contains a single 30-minute sweep on the original channel.

The results shown in this test report refer only to the sample(s) tested unless otherwise stated. This test report cannot be reproduced, except in full, without prior written permission of the Company.

Table 4: DFS Response requirement values

Parameter	Value
Non-occupancy period	30 minutes
Channel Availability Check Time	60 seconds
Channel Move Time	10 seconds
Channel Closing Transmission Time	200 milliseconds + approx. 60 milliseconds over remaining 10 second period

The instant that the Channel Move Time and the Channel Closing Transmission Time begins is as follows: For the Short pulse radar Test Signals this instant is the end of the Burst. For the Frequency Hopping radar Test Signal, this instant is the end of the last radar burst generated. For the Long Pulse radar Test Signal this instant is the end of the 12 second period defining the radar transmission. The Channel Closing Transmission Time is comprised of 200 milliseconds starting at the beginning of the Channel Move Time plus any additional intermittent control signals required to facilitate channel changes (an aggregate of approximately 60 milliseconds) during the remainder of the 10 second period. The aggregate duration of control signals will not count quiet periods in between transmissions.

Table 5 – Short Pulse Radar Test Waveforms

Radar Type	Pulse Width (Microseconds)	PRI (Microseconds)	Pulses	Minimum Percentage of Successful Detection	Minimum Trials
1	1	1428	18	60%	30
2	1-5	150-230	23-29	60%	30
3	6-10	200-500	16-18	60%	30
4	11-20	200-500	12-16	60%	30
Aggregate (Radar Types 1-4)				80%	120

Table 6 – Long Pulse Radar Test Signal

Radar Waveform	Bursts	Pulses per Burst	Pulse Width (µsec)	Chirp Width (MHz)	PRI (µsec)	Minimum Percentage of Successful Detection	Minimum Trials
5	8-20	1-3	50-100	5-20	10002000	80%	30

Table 7 – Frequency Hopping Radar Test Signal

Radar Waveform	Pulse Width (µsec)	PRI (µsec)	Burst Length (ms)	Pulses per Hop	Hopping Rate (kHz)	Minimum Percentage of Successful Detection	Minimum Trials
6	1	333	300	9	0.333	70%	30

The results shown in this test report refer only to the sample(s) tested unless otherwise stated. This test report cannot be reproduced, except in full, without prior written permission of the Company.

2.3. Description of EUT

The EUT operates over the 5 260 MHz ~ 5 320 MHz (11a/n-HT20-DFS), 5 270 MHz ~ 5 310 MHz (11n-HT40-DFS), 5 500 MHz ~ 5700 MHz (11a/n-HT20-DFS), and 5 510 MHz ~ 5670 MHz (11n-HT40-DFS) range.

The gain antenna assembly utilized with the master has a gain of 3.5 dB i.

The rated output power of the master unit is <200 milliwatt. Therefore the required interference threshold level is -62 dB m. After correction for antenna gain and procedure adjustments the required conducted threshold at the antenna port is $-62 + 3.5 = -58.50$ dB m

The calibrated conducted DFS Detection Threshold level is is -60 dB m

The results shown in this test report refer only to the sample(s) tested unless otherwise stated. This test report cannot be reproduced, except in full, without prior written permission of the Company.

PLOTS OF RADAR WAVEFORMS AND WLAN TRAFFIC

Plot of radar waveform type 1

5 260 MHz

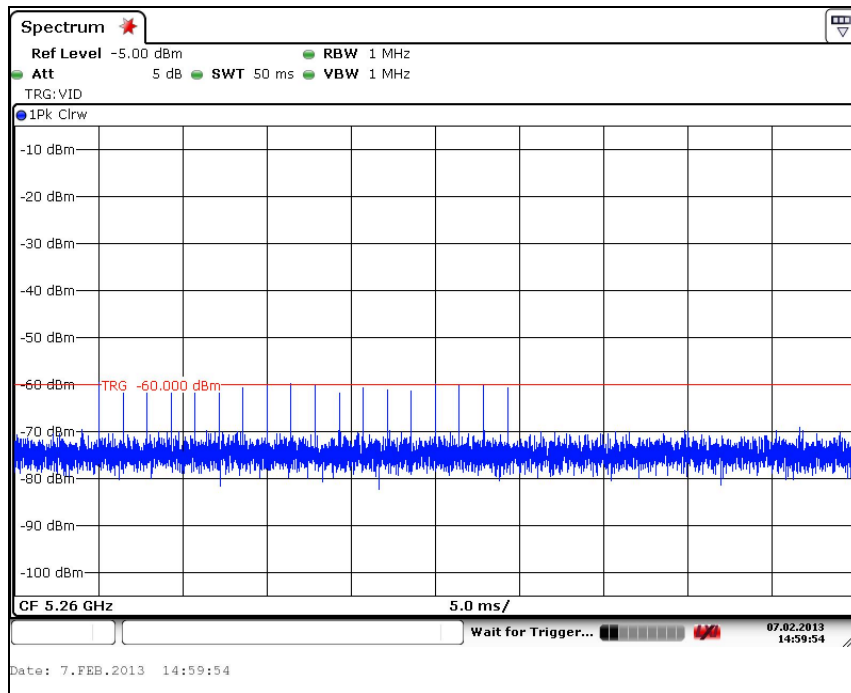

5 500 MHz

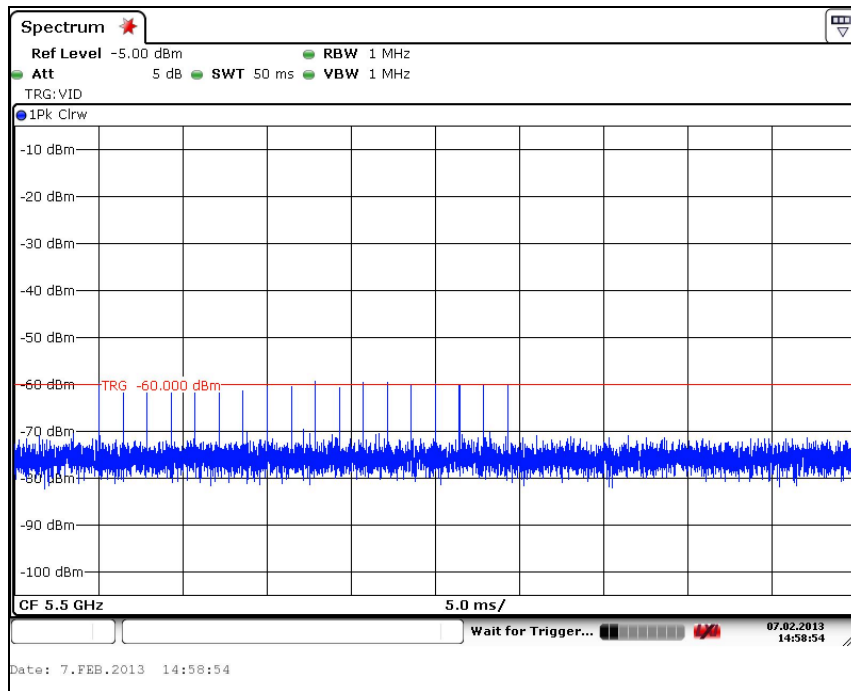

The results shown in this test report refer only to the sample(s) tested unless otherwise stated. This test report cannot be reproduced, except in full, without prior written permission of the Company.

Plot of LAN traffic

5 260 MHz

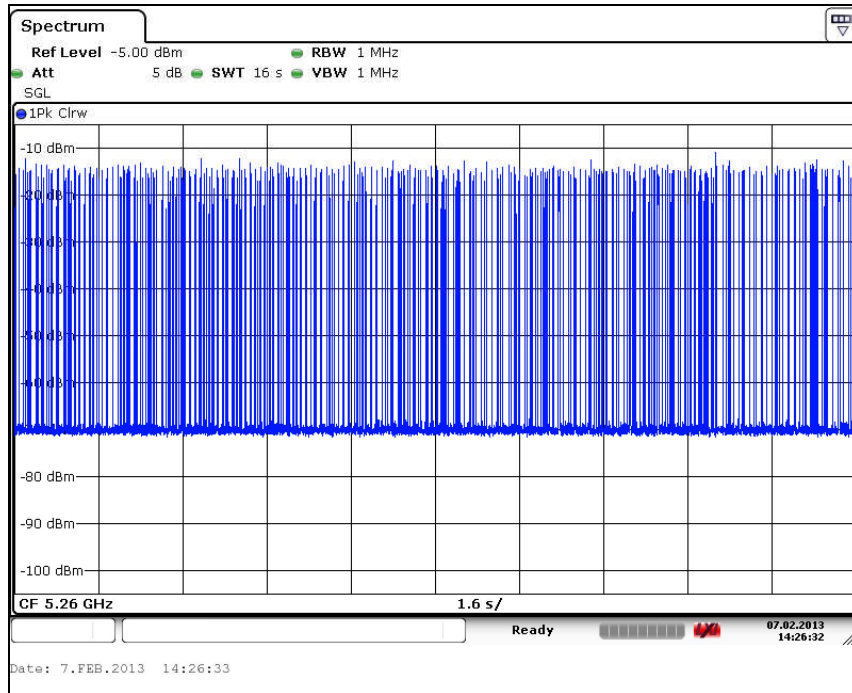

5 500 MHz

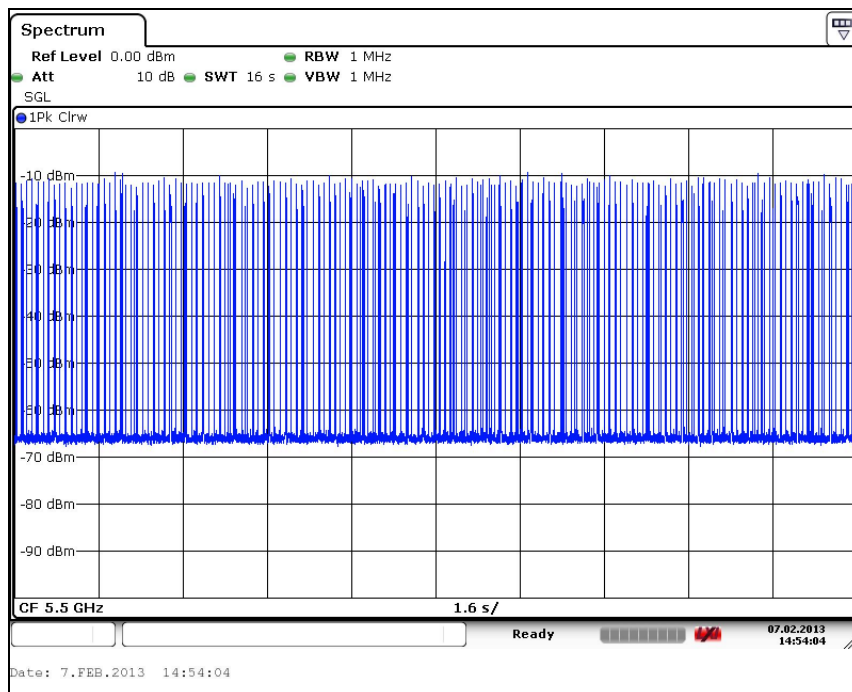

The results shown in this test report refer only to the sample(s) tested unless otherwise stated. This test report cannot be reproduced, except in full, without prior written permission of the Company.

The reference maker is set after 200 ms from the end of Last radar pulse.

The delta is set at the end of the last WLAN transmission following the radar pulse. This delta is the channel move time within the 10 sec.

The aggregate channel closing transmission time is calculated as follows:

Aggregate Transmission Time= (Number of analyzer bins showing transmission)*(dwell time per bin)

The observation period over which the aggregated time is calculated begins at (Reference Maker) and ends no earlier than (Reference Maker +10 sec)

2.3. Test result

Frequency (MHz)	Channel Move Time (sec)	Limit
5 260	0.159	Not exceed 10 sec
5 500	0.370	
Frequency (MHz)	Aggregate channel closing transmission time (msec)	Limit
5 260	4	Not exceed 60 msec
5 500	8	

Aggregate channel closing transmission time

[16s (sweep time) / 8001 (sweep point)] × The number of channel bin from 200 ms at the end of radar pulse.

5 260 MHz: (16 / 8001) × 2 = 4 ms

5 500 MHz: (16 / 8001) × 4 = 8 ms

Frequency (MHz)	Non-occupancy period (min)	Limit
5 260	Above 30	Not be less than 30 minute
5 500	Above 30	

The results shown in this test report refer only to the sample(s) tested unless otherwise stated. This test report cannot be reproduced, except in full, without prior written permission of the Company.

Plot of channel move time & aggregate channel closing transmission time

5 260 MHz

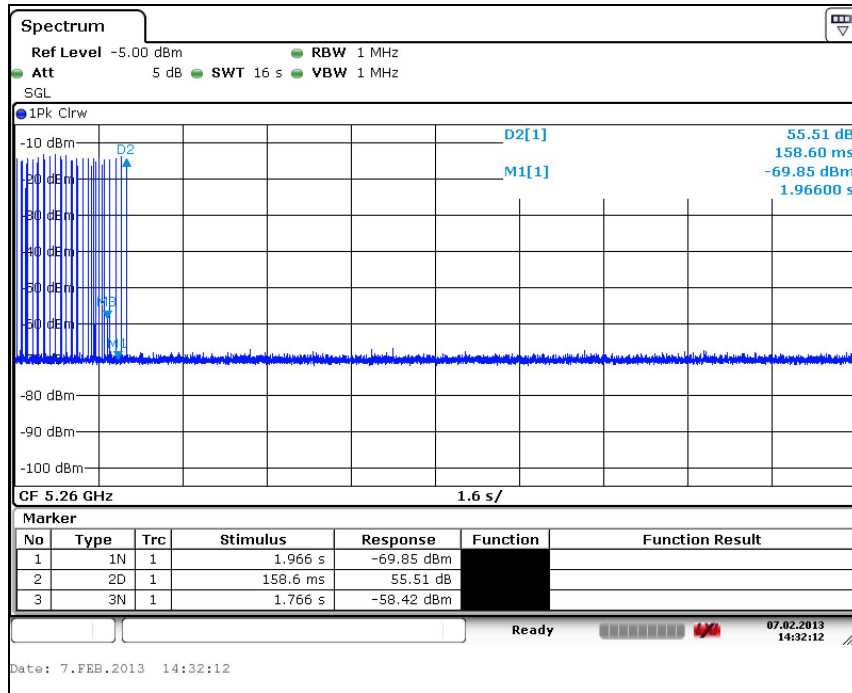

5 500 MHz

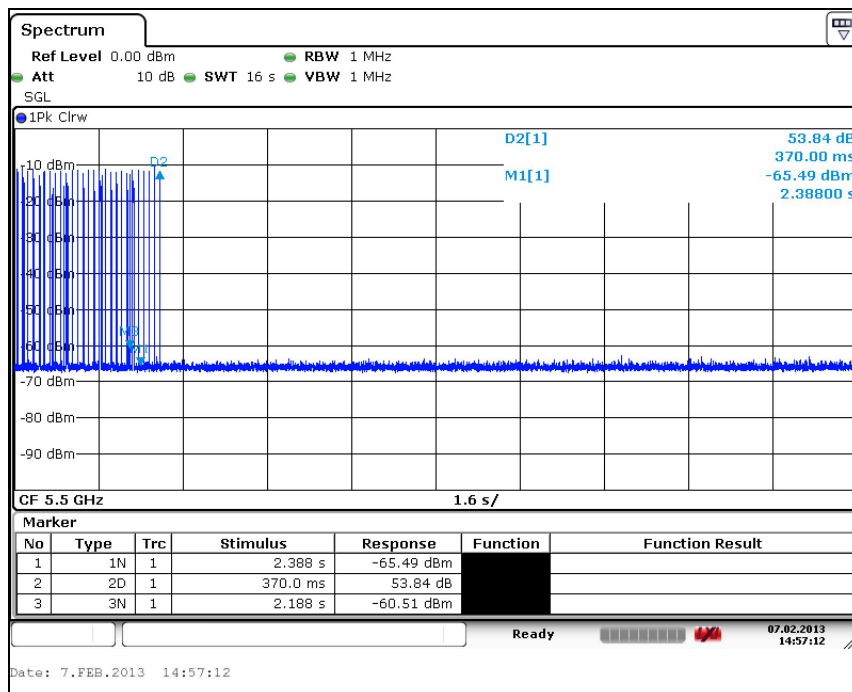

The results shown in this test report refer only to the sample(s) tested unless otherwise stated. This test report cannot be reproduced, except in full, without prior written permission of the Company.

Plot of Non-occupancy period

5 260 MHz

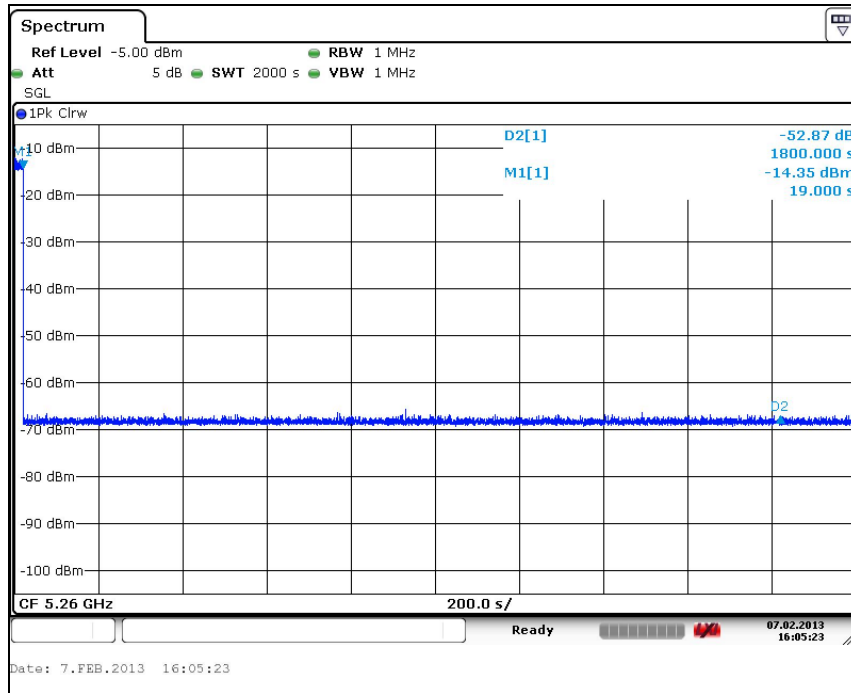

5 500 MHz

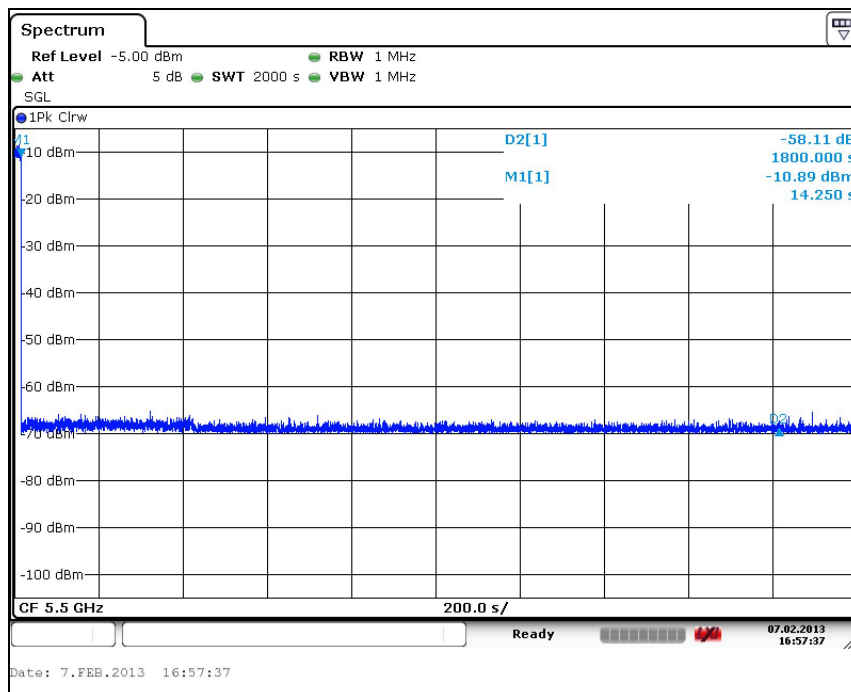

The results shown in this test report refer only to the sample(s) tested unless otherwise stated. This test report cannot be reproduced, except in full, without prior written permission of the Company.