

# TEST REPORT

of

FCC Part 15 Subpart C §15.225  
RSS-210 Issue 9, RSS-Gen Issue 4

FCC ID: A3L-EFNG955  
IC Certification: 649E-EFNG955

Equipment Under Test : LED View Cover  
Model Name : EF-NG955  
Applicant : Samsung Electronics Co., Ltd.  
Manufacturer : Samsung Electronics Co., Ltd.  
Date of Receipt : 2017.02.02  
Date of Test(s) : 2017.02.13 ~ 2017.03.11  
Date of Issue : 2017.03.13

In the configuration tested, the EUT complied with the standards specified above.

Tested By:



Brant Jang

Date:

2017.03.13

Technical  
Manager:



Hyunchoe You

Date:

2017.03.13

*The results shown in this test report refer only to the sample(s) tested unless otherwise stated. This test report cannot be reproduced, except in full, without prior written permission of the Company.*

SGS Korea Co., Ltd. (Gunpo Laboratory) 4, LS-ro 182beon-gil, Gunpo-si, Gyeonggi-do, Korea, 15807 <http://www.sgsgroup.kr>

---

# INDEX

<u>TABLE OF CONTENTS</u>	Page
1. General Information -----	3
2. Radiated Emissions -----	6
3. Frequency Stability -----	19
4. 20 dB Bandwidth & Occupied Bandwidth-----	25
5. AC Power Line Conducted Emissions -----	27

---

*The results shown in this test report refer only to the sample(s) tested unless otherwise stated. This test report cannot be reproduced, except in full, without prior written permission of the Company.*

**SGS Korea Co., Ltd. (Gunpo Laboratory)** 4, LS-ro 182beon-gil, Gunpo-si, Gyeonggi-do, Korea, 15807 <http://www.sgsgroup.kr>

## 1. General Information

### 1.1. Testing Laboratory

SGS Korea Co., Ltd. (Gunpo Laboratory)

- Wireless Div. 2FL, 10-2, LS-ro 182beon-gil, Gunpo-si, Gyeonggi-do, Korea, 15807

All SGS services are rendered in accordance with the applicable SGS conditions of service available on request and accessible at <http://www.sgs.com/en/Terms-and-Conditions.aspx>.

Phone No. : +82 31 688 0901

Fax No. : +82 31 688 0921

### 1.2. Details of Applicant

Applicant : Samsung Electronics Co., Ltd.

Address : 129, Samsung-ro, Yeongtong-gu, Suwon-si, Gyeonggi-do, 16677 Republic of Korea

Contact Person : Ko, Kang-Ho

Phone No. : +82 31 301 1107

### 1.3. Description of EUT

<b>Kind of Product</b>	LED View Cover
<b>Model Name</b>	EF-NG955
<b>Power Supply (EUT)</b>	DC 3.00 V (used by host equipment voltage – DC 3.85 V)
<b>Frequency Range</b>	13.56 MHz (NFC)
<b>Modulation Technique</b>	ASK
<b>Number of Channels</b>	1 channel
<b>Antenna Type</b>	Internal type
<b>H/W Version</b>	Rev0.6
<b>S/W Version</b>	Rev1.0

### 1.4. Declarations by The manufacturer

While the EUT operates NFC mode, it is directly supported voltage by host equipment through NFC antenna. For that reason, voltage of EUT could not be changed by DC power supply. Therefore measurement was investigated by setting voltage of host equipment.

*The results shown in this test report refer only to the sample(s) tested unless otherwise stated. This test report cannot be reproduced, except in full, without prior written permission of the Company.*

**SGS Korea Co., Ltd. (Gunpo Laboratory)** 4, LS-ro 182beon-gil, Gunpo-si, Gyeonggi-do, Korea, 15807 <http://www.sgsgroup.kr>

## 1.5. Test Equipment List

Equipment	Manufacturer	Model	S/N	Cal. Date	Cal. Interval	Cal. Due
Signal Generator	R&S	SMBV100A	259067	Jun. 20, 2016	Annual	Jun. 20, 2017
Spectrum Analyzer	R&S	FSV30	100955	Mar. 30, 2016	Annual	Mar. 30, 2017
High Pass Filter	Mini circuits	NHP-25+	V9741901107	Jan. 21, 2017	Annual	Jan. 21, 2018
DC Power Supply	Agilent	U8002A	MY49030063	Nov. 29, 2016	Annual	Nov. 29, 2017
Temperature Chamber	ESPEC CORP.	PL-1J	15000793	Jun. 20, 2016	Annual	Jun. 20, 2017
Preamplifier	H.P.	8447F	2944A03909	Aug. 11, 2016	Annual	Aug. 11, 2017
Trilog Broadband Antenna	SCHWARZBECK MESSELEKTRONIK	VULB9163	396	Jun. 18, 2015	Biennial	Jun. 18, 2017
Loop Antenna	SCHWARZBECK MESSELEKTRONIK	FMZB 1519	1519-039	Aug. 19, 2015	Biennial	Aug. 19, 2017
Test Receiver	R&S	ESU26	100109	Feb. 17, 2017	Annual	Feb. 17, 2018
Test Receiver	R&S	ESCI 7	100911	Feb. 22, 2017	Annual	Feb. 22, 2018
Antenna Mast	Innco systems GmbH	MM4640-XP-ET	MA4640/536/ 38330516/L	N/A	N/A	N.C.R.
Turn Table	Innco systems GmbH	DS 1200 S	N/A	N.C.R.	N/A	N.C.R.
Controller	Innco systems GmbH	CONTROLLER CO3000-4P	CO300/963/ 38330516/L	N.C.R.	N/A	N.C.R.
Anechoic Chamber	SY Corporation	L x W x H (9.6 m x 6.4 m x 6.6 m)	N/A	N.C.R.	N/A	N.C.R.
Two-Line V-Network	R&S	ENV216	100190	Dec. 21, 2016	Annual	Dec. 21, 2017
Shield Room	SY Corporation	L x W x H (6.5 m x 3.5 m x 3.5 m)	N/A	N.C.R.	N/A	N.C.R.

## 1.6. Host Equipment

Description	Manufacturer	Model	ID
Mobile phone	Samsung Electronics Co., Ltd.	SM-G955U, SM-G955W	FCC: A3LSMG955U, IC: 649E-SMG955W

The results shown in this test report refer only to the sample(s) tested unless otherwise stated. This test report cannot be reproduced, except in full, without prior written permission of the Company.

SGS Korea Co., Ltd. (Gunpo Laboratory) 4, LS-ro 182beon-gil, Gunpo-si, Gyeonggi-do, Korea, 15807 <http://www.sgsgroup.kr>

## 1.7. Summary of Test Results

The EUT has been tested according to the following specifications:

Applied standard : FCC Part15 subpart C, IC RSS-210 Issue 9, RSS-Gen Issue 4			
Standard section		Test item	Result
15.225(a)(b)(c)(d) 15.209	RSS-210 Annex B Section B.6 RSS-Gen Section 8.9	Radiated Emission, Spurious Emission and Field Strength of Fundamental	Complied
15.225(e)	RSS-210 Annex B Section B.6 RSS-Gen Section 6.11	Frequency Stability	Complied
15.215(c)	RSS-Gen Section 6.6	20 dB Bandwidth & Occupied Bandwidth	Complied
15.207	RSS-Gen Section 8.8	AC Power Line Conducted Emissions	Complied

## 1.8. Sample calculation

Where relevant, the following sample calculation is provided:

### 1.8.1. Conducted test

Offset value (dB) = Attenuator(dB) + Cable loss (dB)

### 1.8.2. Radiation test

Field strength level (dB $\mu$ V/m) = Measured level (dB $\mu$ V) + Antenna factor (dB) + Cable loss (dB) - amplifier (dB)

## 1.9. Test report revision

Revision	Report number	Date of Issue	Description
0	F690501/RF-RTL0101921	2017.03.13	Initial

*The results shown in this test report refer only to the sample(s) tested unless otherwise stated. This test report cannot be reproduced, except in full, without prior written permission of the Company.*

**SGS Korea Co., Ltd. (Gunpo Laboratory)** 4, LS-ro 182beon-gil, Gunpo-si, Gyeonggi-do, Korea, 15807 <http://www.sgsgroup.kr>

## 2. Radiated Emissions

### 2.1. Test Setup

The diagram below shows the test setup that is utilized to make the measurements for emission from 9 kHz to 30 MHz Emissions.

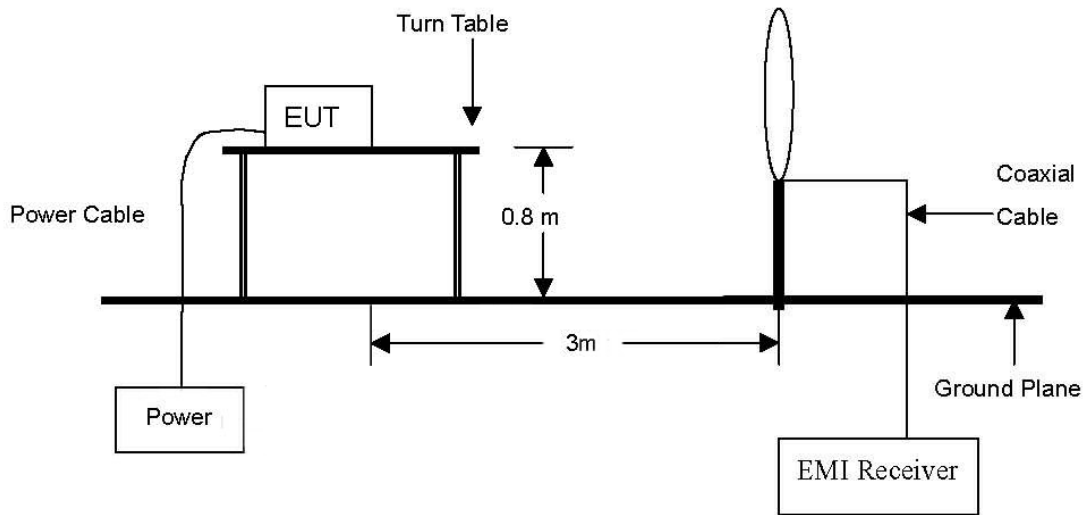

The diagram below shows the test setup that is utilized to make the measurements for emission from 30 MHz to 135.6 MHz Emissions.

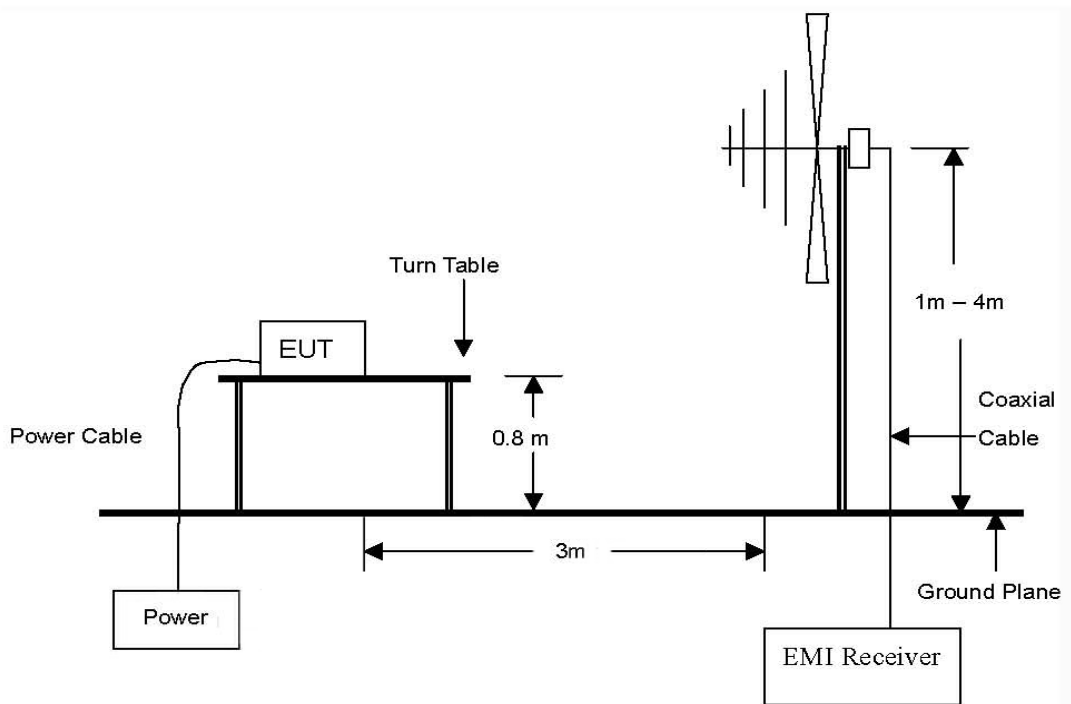

*The results shown in this test report refer only to the sample(s) tested unless otherwise stated. This test report cannot be reproduced, except in full, without prior written permission of the Company.*

## 2.2. Limit

### FCC

According to §15.225,

- (a) The field strength of any emissions within the band 13.553 - 13.567 MHz shall not exceed 15 848 microvolts / meter at 30 meters.
- (b) Within the bands 13.410 - 13.553 MHz and 13.567 - 13.710 MHz, the field strength of any emissions shall not exceed 334 microvolts / meter at 30 meters.
- (c) Within the bands 13.110 - 13.410 MHz and 13.710 - 14.010 MHz the field strength of any emissions shall not exceed 106 microvolts / meter at 30 meters.
- (d) The field strength of any emissions appearing outside of the 13.110 - 14.010 MHz and shall not exceed the general radiated emission limits in §15.209.

According to §15.209,

Except as provided elsewhere in this Subpart, the emissions from an intentional radiator shall not exceed the field strength levels specified in the following table:

Frequency (MHz)	Field Strength (microvolts/meter)	Measurement Distance (meter)
0.009 – 0.490	2400/F(kHz)	300
0.490 – 1.705	24000/F(kHz)	30
1.705 – 30.0	30	30
30 -88	100**	3
88 -216	150**	3
216 - 960	200**	3
Above 960	500	3

\*\* Except as provided in paragraph (g), fundamental emissions from intentional radiators operating under this Section shall not be located in the frequency bands 54-72 MHz, 76-88 MHz, 174-216 MHz or 470-806 MHz. However, operation within these frequency bands is permitted under other sections of this Part, e.g., Sections 15.231 and 15.241

*The results shown in this test report refer only to the sample(s) tested unless otherwise stated. This test report cannot be reproduced, except in full, without prior written permission of the Company.*

**SGS Korea Co., Ltd. (Gunpo Laboratory)** 4, LS-ro 182beon-gil, Gunpo-si, Gyeonggi-do, Korea, 15807 <http://www.sgsgroup.kr>

**IC**

According to RSS-210, Section B.6

The field strength of any emission shall not exceed the following limits:

- (a) 15.848 millivolts/m (84 dB $\mu$ V/m) at 30 m, within the band 13.553-13.567 MHz.
- (b) 334 microvolts/m (50.5 dB $\mu$ V/m) at 30 m, within the bands 13.410-13.553 MHz and 13.567-13.710 MHz.
- (c) 106 microvolts/m (40.5 dB $\mu$ V/m) at 30 m, within the bands 13.110-13.410 MHz and 13.710-14.010 MHz.
- (d) RSS-Gen general field strength limits for frequencies outside the band 13.110-14.010 MHz.

According to RSS-Gen, Section 8.9

Except when the requirements applicable to a given device state otherwise, emissions from licence-exempt transmitters shall comply with the field strength limits shown in Table 4 or Table 5 below.

Additionally, the level of any transmitter emission shall not exceed the level of the transmitter’s fundamental emission.

Table 4 – General Field Strength Limits for License-Exempt Transmitters at Frequencies Above 30 MHz

Frequency (MHz)	Field Strength ( $\mu$ V/m at 3 meters)
30-88	100
88-216	150
216-960	200
Above 960*	500

\* Unless otherwise specified, for all frequencies greater than 1GHz, the radiated emission limits for licence-exempt radio apparatus stated in applicable RSSs (including RSS-Gen) are based on measurements using a linear average detector function having a minimum resolution bandwidth of 1 MHz. If an average limit is specified for the EUT, then the peak emission shall also be measured with instrumentation properly adjusted for such factors as pulse desensitization to ensure the peak emission is less than 20 dB above the average limit.

**Note:** Transmitting devices are not permitted in restricted frequency bands unless stated otherwise in the specific RSS.

*The results shown in this test report refer only to the sample(s) tested unless otherwise stated. This test report cannot be reproduced, except in full, without prior written permission of the Company.*

Table 5 – General Field Strength Limits for Licence-Exempt Transmitters at Frequencies Below 30 MHz

Frequency	Electric Field Strength ( $\mu\text{V}/\text{m}$ )	Magnetic Field Strength (H-Field) ( $\mu\text{A}/\text{m}$ )	Measurement Distance (meters)
9-490 kHz	2,400/F (F in kHz)	2,400/377F (F in kHz)	300
490-1,705 kHz	24,000/ F (F in kHz)	24,000/377F (F in kHz)	30
1,705-30 MHz	30	N/A	30

**Note:** The emission limits for the bands 9-90 kHz and 110-490 kHz are based on measurements employing a linear average detector. Transmitting devices are not permitted in restricted frequency bands unless stated otherwise in the relevant RSS.

*The results shown in this test report refer only to the sample(s) tested unless otherwise stated. This test report cannot be reproduced, except in full, without prior written permission of the Company.*

**SGS Korea Co., Ltd. (Gunpo Laboratory)** 4, LS-ro 182beon-gil, Gunpo-si, Gyeonggi-do, Korea, 15807 <http://www.sgsgroup.kr>

## 2.3. Test Procedures

Radiated emissions from the EUT were measured according to the dictates of ANSI C63.10-2013.

### 2.3.1. Test Procedures for emission below 30 MHz

1. The EUT was placed on the top of a rotating table 0.8 meters above the ground at a 3 meter anechoic chamber test site. The table was rotated 360 degrees to determine the position of the highest radiation.
2. Then antenna is a loop antenna is fixed at one meter above the ground to determine the maximum value of the field strength. Both parallel and perpendicular of the antenna are set to make the measurement.
3. For each suspected emission, the EUT was arranged to its worst case and then the table was turned from 0 degrees to 360 degrees to find the maximum reading.
4. The test-receiver system was set to Quasi peak Detect Function with Maximum Hold Mode.

#### Note;

Although these tests were performed other than open field test site, adequate comparison measurements were confirmed against 30 meter open field test site. Therefore sufficient tests were made to demonstrate that the alternative site produces results that correlate with the ones of tests made in an open field based on KDB 937606.

### 2.3.2. Test Procedures for emission above 30 MHz

1. The EUT was placed on the top of a rotating table 0.8 meters above the ground at a 3 meter anechoic chamber test site. The table was rotated 360 degrees to determine the position of the highest radiation.
2. During performing radiated emission below 1 GHz, the EUT was set 3 meters away from the interference receiving antenna, which was mounted on the top of a variable-height antenna tower.
3. The antenna is a Trilog Broadband antenna and its height is varied from one meter to four meters above the ground to determine the maximum value of the field strength. Both horizontal and vertical polarizations of the antenna are set to make the measurement.
4. For each suspected emission, the EUT was arranged to its worst case and then the antenna was tuned to heights from 1 meter to 4 meters and the table was turned from 0 degrees to 360 degrees to find the maximum reading.
5. The test-receiver system was set to Peak Detect Function and Specified Bandwidth with Maximum Hold Mode.
6. If the emission level of the EUT in peak mode was 10 dB lower than the limit specified, then testing could be stopped and the peak values of the EUT would be reported. Otherwise the emissions that did not have 10 dB margin would be re-tested one by one using peak, quasi-peak or average method as specified and then reported in a data sheet.

#### NOTE;

To get a maximum emission level from the EUT, the EUT is manipulated through three orthogonal planes (X, Y, Z). Worst orthogonal plan of EUT is **Y – axis** during radiation test.

---

*The results shown in this test report refer only to the sample(s) tested unless otherwise stated. This test report cannot be reproduced, except in full, without prior written permission of the Company.*

SGS Korea Co., Ltd. (Gunpo Laboratory) 4, LS-ro 182beon-gil, Gunpo-si, Gyeonggi-do, Korea, 15807 <http://www.sgsgroup.kr>

RTT5041-20(2015.10.01)(3)

Tel. +82 31 428 5700 / Fax. +82 31 427 2370

A4(210 mm x 297 mm)

## 2.4. Test Result

Ambient temperature : (23 ± 1) °C

Relative humidity : 47 % R.H.

The following table shows the highest levels of radiated emissions.

### -Fundamental within the band 13.553 MHz – 13.567 MHz

Radiated Emissions			Ant.	Correction Factors		Total		Limit	
Freq. (MHz)	Reading (dB $\mu$ V)	Detect Mode	Pol.	Ant. Factor (dB/m)	Cable loss (dB)	Actual (dB $\mu$ V/m) at 3 m	Actual (dB $\mu$ V/m) at 30 m	Limit (dB $\mu$ V/m) at 30 m	Margin (dB)
13.560	35.41	Quasi-Peak	H	18.67	0.40	54.48	14.48	84.00	69.52

### -Spurious emission within the bands 13.410 MHz – 13.553 MHz and 13.567 MHz – 13.710 MHz

Radiated Emissions			Ant.	Correction Factors		Total		Limit	
Freq. (MHz)	Reading (dB $\mu$ V)	Detect Mode	Pol.	Ant. Factor (dB/m)	Cable loss (dB)	Actual (dB $\mu$ V/m) at 3 m	Actual (dB $\mu$ V/m) at 30 m	Limit (dB $\mu$ V/m) at 30 m	Margin (dB)
13.552	17.70	Quasi-Peak	H	18.67	0.40	36.77	-3.23	50.47	53.70
13.594	3.11	Quasi-Peak	H	18.67	0.40	22.18	-17.82	50.47	68.29

### - Spurious emission within the bands 13.110 MHz – 13.410 MHz and 13.710 MHz – 14.010 MHz

Radiated Emissions			Ant.	Correction Factors		Total		Limit	
Freq. (MHz)	Reading (dB $\mu$ V)	Detect Mode	Pol.	Ant. Factor (dB/m)	Cable loss (dB)	Actual (dB $\mu$ V/m) at 3 m	Actual (dB $\mu$ V/m) at 30 m	Limit (dB $\mu$ V/m) at 30 m	Margin (dB)
*13.371	3.20	Quasi-Peak	H	18.70	0.40	22.30	-17.70	29.54	47.24
13.809	3.00	Quasi-Peak	H	18.64	0.41	22.05	-17.95	40.51	58.46

The results shown in this test report refer only to the sample(s) tested unless otherwise stated. This test report cannot be reproduced, except in full, without prior written permission of the Company.

SGS Korea Co., Ltd. (Gunpo Laboratory) 4, LS-ro 182beon-gil, Gunpo-si, Gyeonggi-do, Korea, 15807 <http://www.sgsgroup.kr>

**- Spurious emission within the bands 9 kHz – 13.110 MHz**

Radiated Emissions			Ant.	Correction Factors		Total		Limit	
Freq. (MHz)	Reading (dB $\mu$ V)	Detect Mode	Pol.	Ant. Factor (dB/m)	Cable loss (dB)	Actual (dB $\mu$ V/m) at 3 m	Actual (dB $\mu$ V/m) at 300 m	Limit (dB $\mu$ V/m) at 300 m	Margin (dB)
0.072	5.90	Average	H	19.66	0.03	25.59	-54.41	30.46	84.87

Radiated Emissions			Ant.	Correction Factors		Total		Limit	
Freq. (MHz)	Reading (dB $\mu$ V)	Detect Mode	Pol.	Ant. Factor (dB/m)	Cable loss (dB)	Actual (dB $\mu$ V/m) at 3 m	Actual (dB $\mu$ V/m) at 30 m	Limit (dB $\mu$ V/m) at 30 m	Margin (dB)
*12.577	3.00	Quasi-Peak	H	18.79	0.40	22.19	-17.81	29.54	47.35

**- Spurious emission within the bands 14.010 MHz – 30 MHz**

Radiated Emissions			Ant.	Correction Factors		Total		Limit	
Freq. (MHz)	Reading (dB $\mu$ V)	Detect Mode	Pol.	Ant. Factor (dB/m)	Cable loss (dB)	Actual (dB $\mu$ V/m) at 3 m	Actual (dB $\mu$ V/m) at 30 m	Limit (dB $\mu$ V/m) at 30 m	Margin (dB)
15.753	2.90	Quasi-Peak	H	18.48	0.41	21.79	-18.21	29.54	47.75
*16.421	2.90	Quasi-Peak	H	18.47	0.42	21.79	-18.21	29.54	47.75

**Note:**

1. Fundamental limit ( $\mu$ V/m) =  $20 \log (15\ 848) = 84.00$  dB $\mu$ V/m.
2. 30 m distance compensation =  $40 \log (3/30) = -40$  dB $\mu$ V/m.
3. 300 m distance compensation =  $40 \log (3/300) = -80$  dB $\mu$ V/m.
4. "\*" means the restricted band.
5. If the spurious emissions are in the restricted band, the limit complied with §15.209.

The results shown in this test report refer only to the sample(s) tested unless otherwise stated. This test report cannot be reproduced, except in full, without prior written permission of the Company.

SGS Korea Co., Ltd. (Gunpo Laboratory) 4, LS-ro 182beon-gil, Gunpo-si, Gyeonggi-do, Korea, 15807 <http://www.sgsgroup.kr>

## Plot

-Fundamental within the band 13.553 MHz – 13.567 MHz

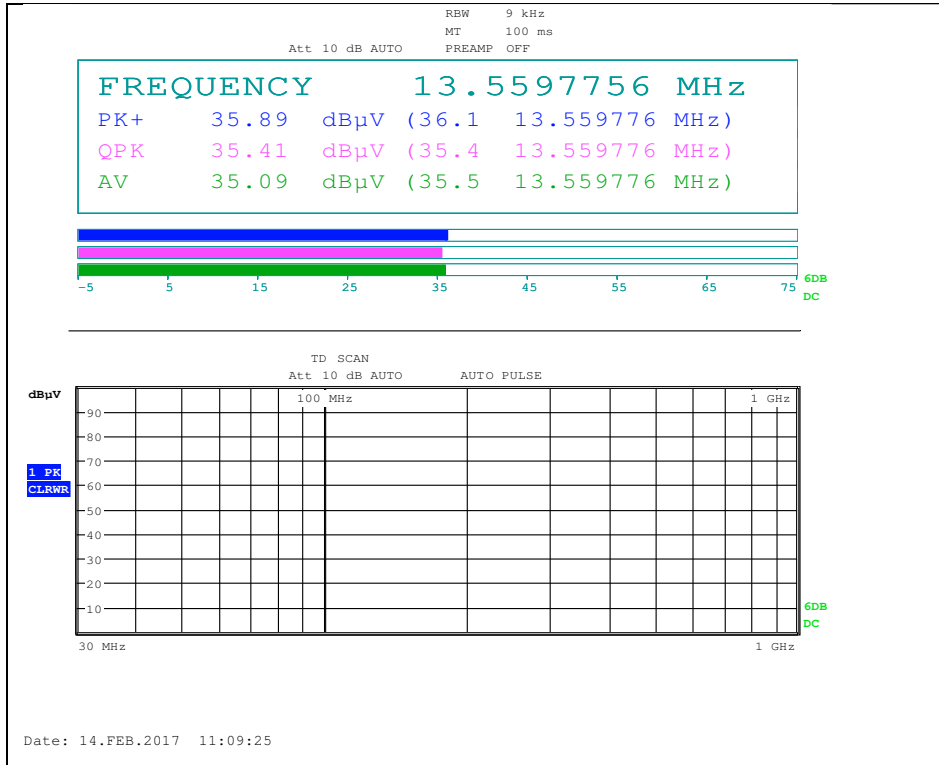

The results shown in this test report refer only to the sample(s) tested unless otherwise stated. This test report cannot be reproduced, except in full, without prior written permission of the Company.

SGS Korea Co., Ltd. (Gunpo Laboratory) 4, LS-ro 182beon-gil, Gunpo-si, Gyeonggi-do, Korea, 15807 <http://www.sgsgroup.kr>

**-Spurious emission within the bands 13.410 MHz – 13.553 MHz and 13.567 MHz – 13.710 MHz**

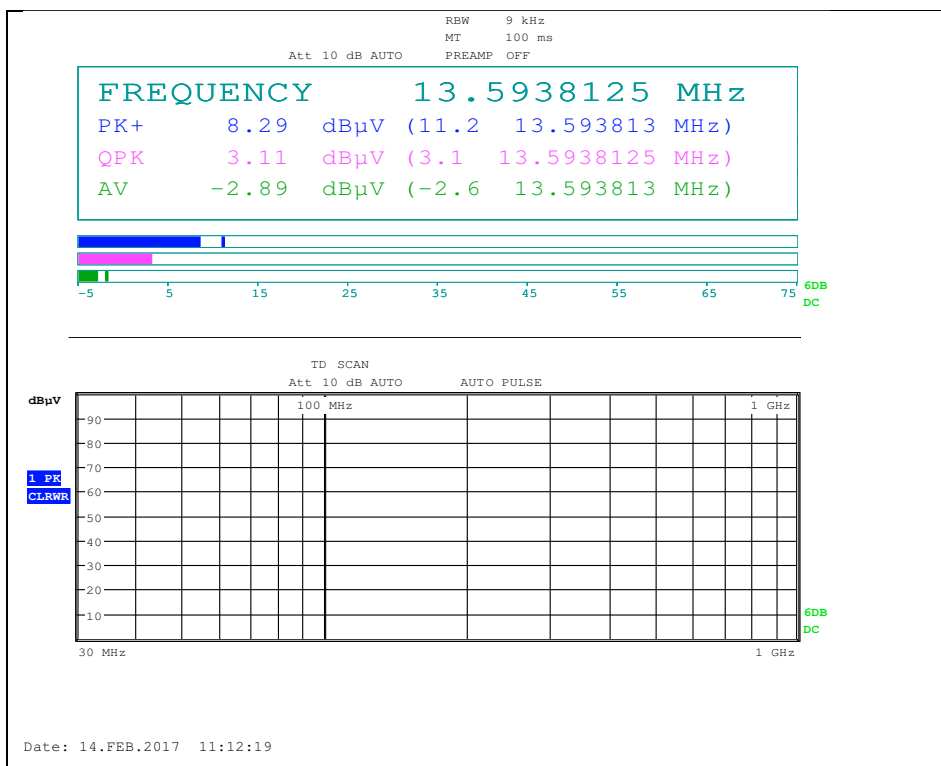
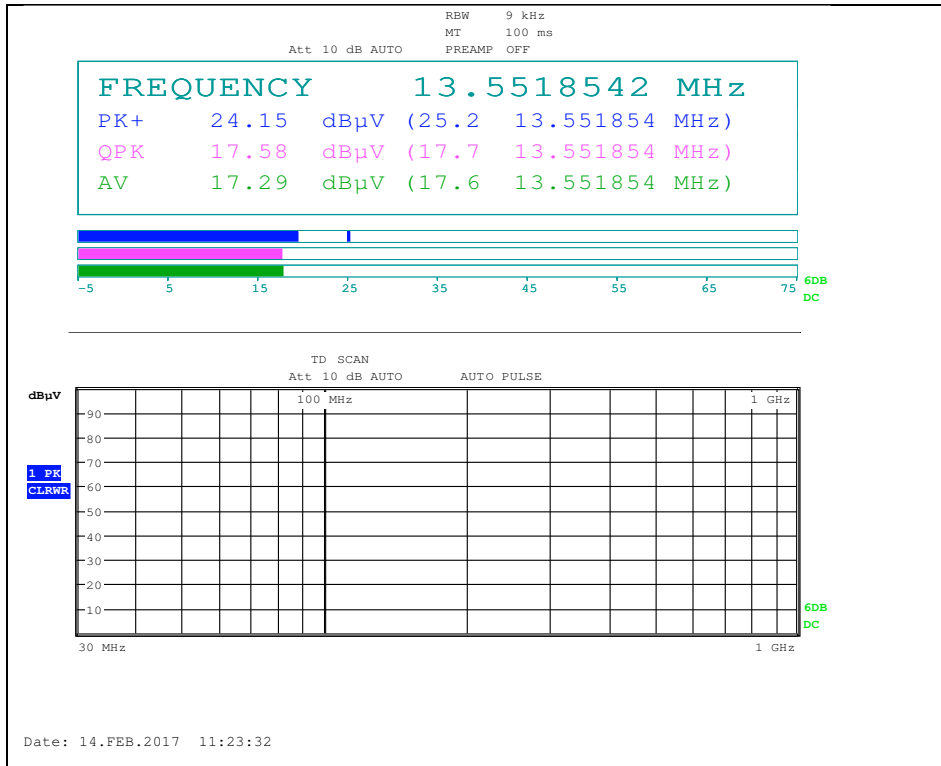

The results shown in this test report refer only to the sample(s) tested unless otherwise stated. This test report cannot be reproduced, except in full, without prior written permission of the Company.

**- Spurious emission within the bands 13.110 MHz – 13.410 MHz and 13.710 MHz – 14.010 MHz**

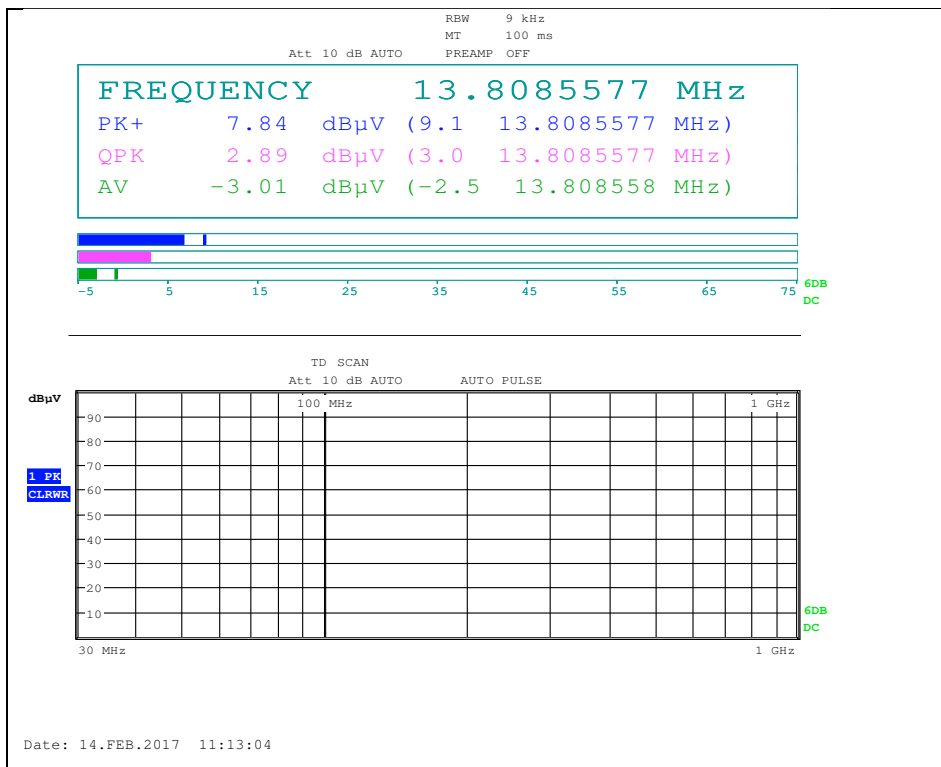
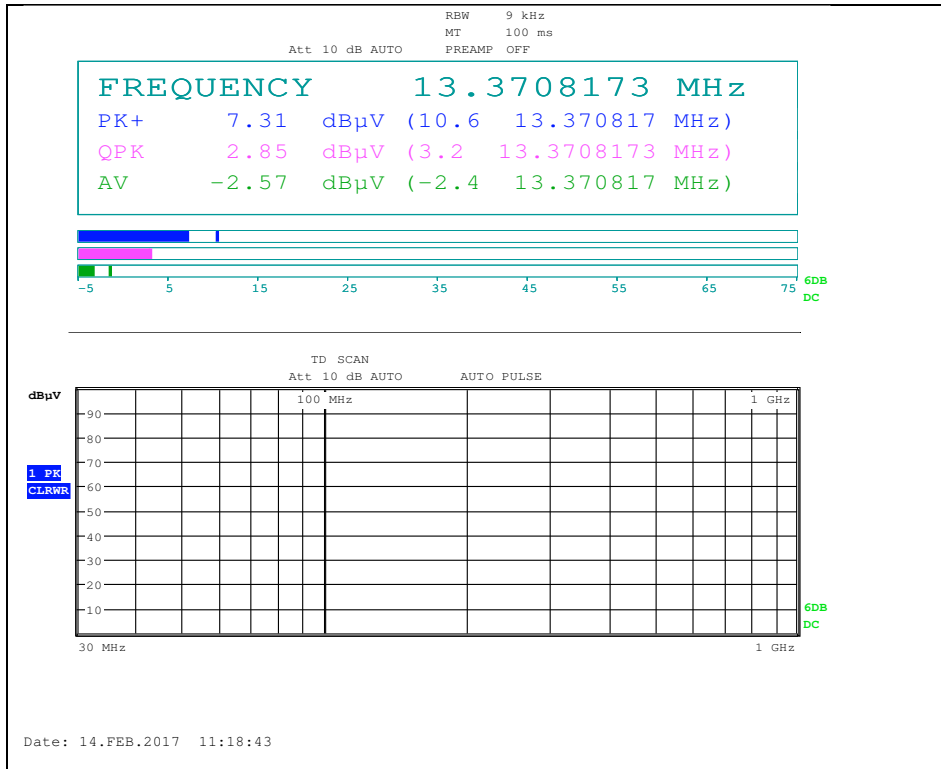

The results shown in this test report refer only to the sample(s) tested unless otherwise stated. This test report cannot be reproduced, except in full, without prior written permission of the Company.

**- Spurious emission within the bands 9 kHz – 13.110 MHz**

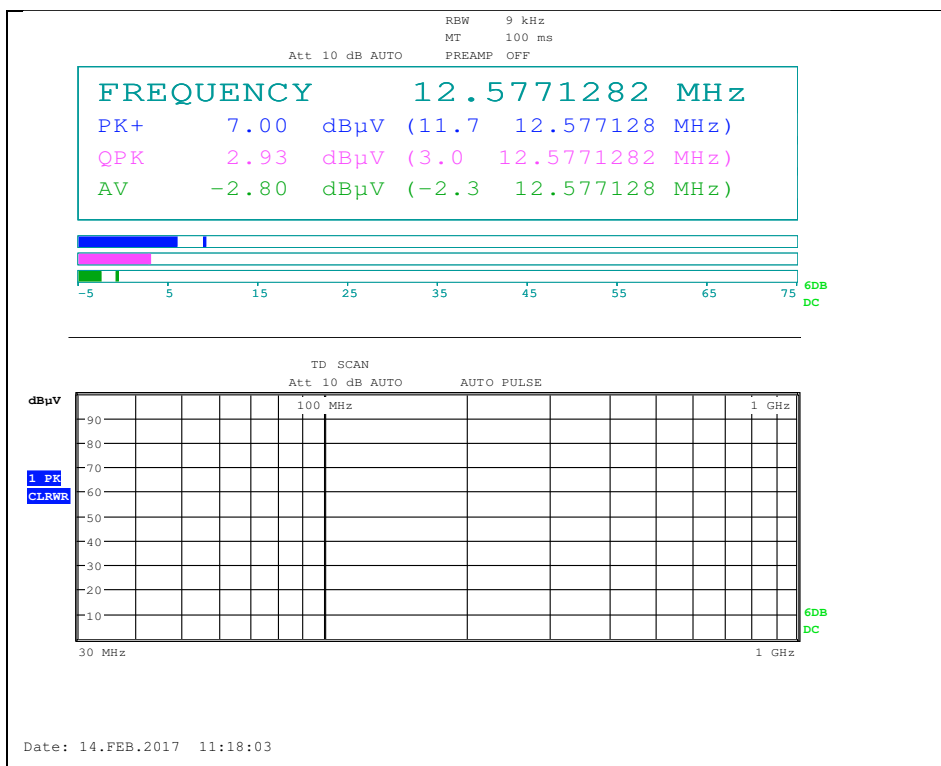
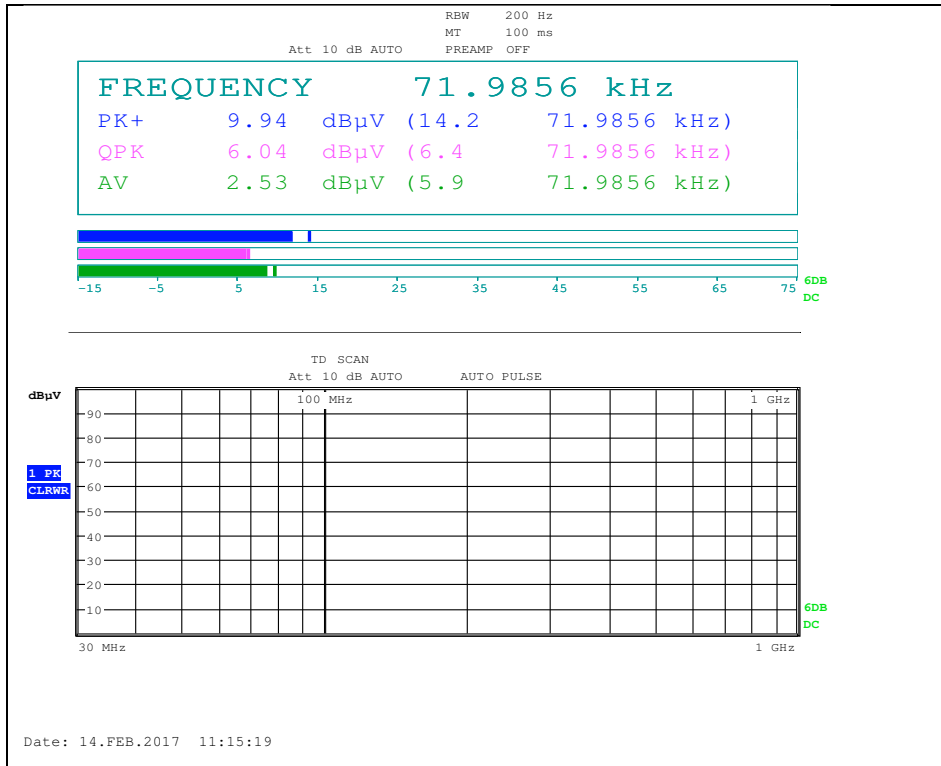

The results shown in this test report refer only to the sample(s) tested unless otherwise stated. This test report cannot be reproduced, except in full, without prior written permission of the Company.

**- Spurious emission within the bands 14.010 MHz – 30 MHz**

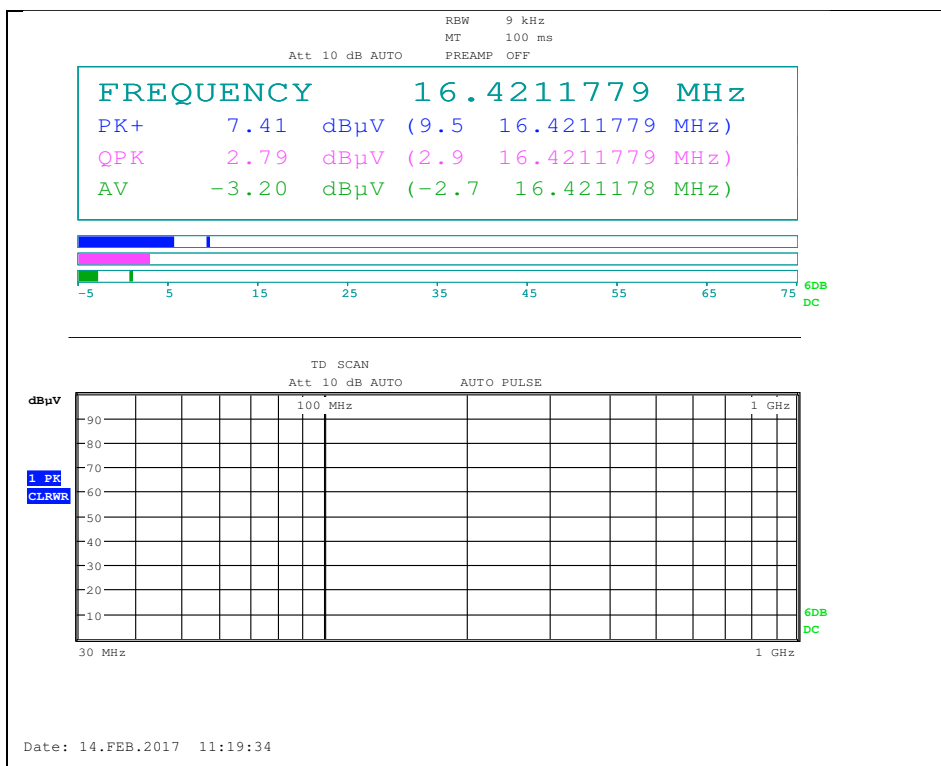
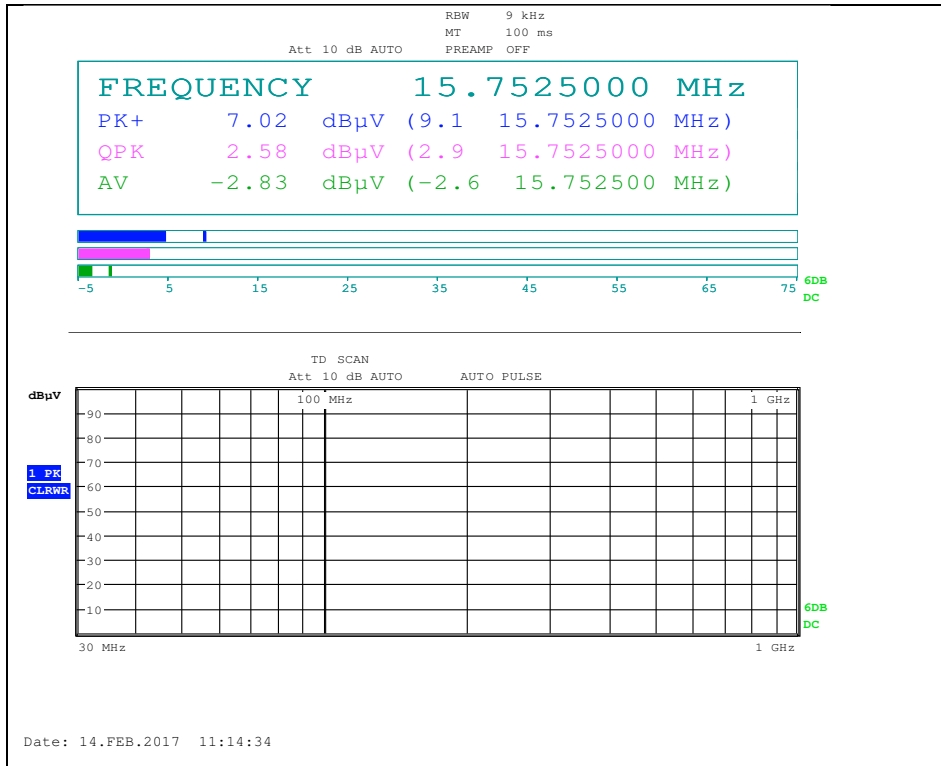

The results shown in this test report refer only to the sample(s) tested unless otherwise stated. This test report cannot be reproduced, except in full, without prior written permission of the Company.

**- Spurious emission above 30 MHz**

Radiated Emissions			Ant.	Correction Factors		Total	FCC Limit	
Freq. (MHz)	Reading (dB $\mu$ V)	Detect Mode	Pol.	Ant. Factor (dB/m)	Cable loss & Amp (dB)	Actual (dB $\mu$ V/m) at 3 m	Limit (dB $\mu$ V/m) at 3 m	Margin (dB)
40.68	49.90	Quasi Peak	V	14.06	-27.03	36.93	40.00	3.07
40.71	37.30	Peak	H	15.96	-27.03	26.23	40.00	13.77
81.33	43.80	Peak	V	9.96	-26.64	27.12	40.00	12.88
325.45	43.90	Peak	H	14.70	-24.74	33.86	46.00	12.14
338.99	47.20	Peak	V	16.14	-24.73	38.61	46.00	7.39
338.99	52.10	Peak	H	15.10	-24.73	42.47	46.00	3.53
Above 400.00	Not Detected	-	-	-	-	-	-	-

**Note:**

1. Fundamental limit ( $\mu$ V/m) =  $20 \log (15\ 848) = 84.00$  dB $\mu$ V/m.
2. 30 m distance compensation =  $40 \log (3/30) = -40$  dB $\mu$ V/m.
3. 300 m distance compensation =  $40 \log (3/300) = -80$  dB $\mu$ V/m.
4. “\*” means the restricted band.
5. If the spurious emissions are in the restricted band, the limit complied with §15.209.

**Test plot**

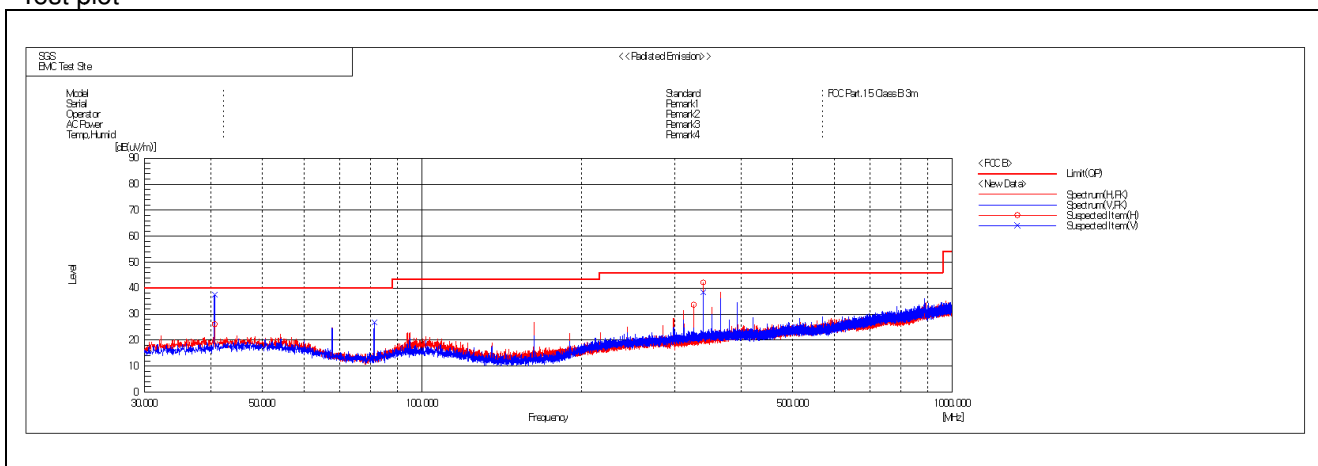

The results shown in this test report refer only to the sample(s) tested unless otherwise stated. This test report cannot be reproduced, except in full, without prior written permission of the Company.

### 3. Frequency Stability

#### 3.1. Test Setup

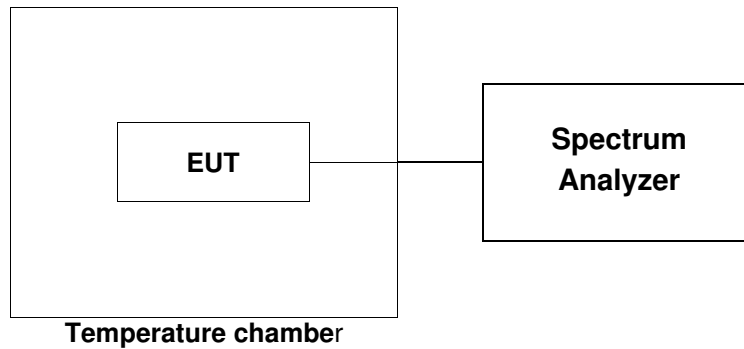

#### 3.2. Limit

##### FCC

According to §15.225(e), the frequency tolerance of the carrier signal shall be maintained within +/- 0.01 % of the operating frequency over a temperature variation of -20 degrees to +50 degrees C at normal supply voltage, and for a variation in the primary supply voltage from 85 % to 115 % of the rated supply voltage at a temperature of 20 degrees C. For battery operated equipment, the equipment tests shall be performed using a new battery.

##### IC

According to RSS-210, Annex B, Section B.6  
Carrier frequency stability shall be maintained to  $\pm 0.01$  % ( $\pm 100$  ppm).

#### 3.3. Test Procedures

1. Place the EUT on the table and set it in the transmitting mode.
2. Remove the antenna from the EUT and then connect a low loss RF cable from the antenna port to the spectrum analyzer.
3. Set the environment into appropriate environment.
4. Set the spectrum analyzer as RBW = 100 Hz, VBW = 100 Hz, Span = 10 kHz, Sweep time = auto.
5. Mark the peak frequency and measure the frequency tolerance using frequency counter function.
6. Repeat until all the results are investigated.

*The results shown in this test report refer only to the sample(s) tested unless otherwise stated. This test report cannot be reproduced, except in full, without prior written permission of the Company.*

### 3.4. Test Result

Ambient temperature : (23 ± 1) °C  
 Relative humidity : 47 % R.H.

Operating Frequency : 13 560 000 Hz  
 Reference Voltage: DC 3.85 V (Host Equipment)  
 Deviation Limit : ± 0.01 % = ± 1 356 Hz

#### Startup

##### Temperature Variations

Power (V <sub>DC</sub> )	Temperature (°C)	Frequency (Hz)	Freq. Dev. (Hz)	Deviation (%)
3.85	-30	13 559 696	-304	-0.002 242
	-20	13 559 783	-217	-0.001 600
	-10	13 559 797	-203	-0.001 497
	0	13 559 812	-188	-0.001 386
	+10	13 559 783	-217	-0.001 600
	+20	13 559 768	-232	-0.001 711
	+30	13 559 740	-260	-0.001 917
	+40	13 559 725	-275	-0.002 028
	+50	13 559 696	-304	-0.002 242

##### Voltage Variations

Power (V <sub>DC</sub> )	Temperature (°C)	Frequency (Hz)	Freq. Dev. (Hz)	Deviation (%)
115 % (4.43)	+20	13 559 768	-232	-0.001 711
85 % (3.27)	+20	13 559 768	-232	-0.001 711

The results shown in this test report refer only to the sample(s) tested unless otherwise stated. This test report cannot be reproduced, except in full, without prior written permission of the Company.

SGS Korea Co., Ltd. (Gunpo Laboratory) 4, LS-ro 182beon-gil, Gunpo-si, Gyeonggi-do, Korea, 15807 <http://www.sgsgroup.kr>

2 minutes

**Temperature Variations**

Power (V <sub>DC</sub> )	Temperature (°C)	Frequency (Hz)	Freq. Dev. (Hz)	Deviation (%)
3.85	-30	13 559 711	-289	-0.002 131
	-20	13 559 783	-217	-0.001 600
	-10	13 559 812	-188	-0.001 386
	0	13 559 812	-188	-0.001 386
	+10	13 559 783	-217	-0.001 600
	+20	13 559 768	-232	-0.001 711
	+30	13 559 740	-260	-0.001 917
	+40	13 559 725	-275	-0.002 028
	+50	13 559 696	-304	-0.002 242

**Voltage Variations**

Power (V <sub>DC</sub> )	Temperature (°C)	Frequency (Hz)	Freq. Dev. (Hz)	Deviation (%)
115 % (4.43)	+20	13 559 768	-232	-0.001 711
85 % (3.27)	+20	13 559 768	-232	-0.001 711

*The results shown in this test report refer only to the sample(s) tested unless otherwise stated. This test report cannot be reproduced, except in full, without prior written permission of the Company.*

**5 minutes**
**Temperature Variations**

Power (V <sub>DC</sub> )	Temperature (°C)	Frequency (Hz)	Freq. Dev. (Hz)	Deviation (%)
3.85	-30	13 559 711	-289	-0.002 131
	-20	13 559 783	-217	-0.001 600
	-10	13 559 812	-188	-0.001 386
	0	13 559 812	-188	-0.001 386
	+10	13 559 783	-217	-0.001 600
	+20	13 559 768	-232	-0.001 711
	+30	13 559 740	-260	-0.001 917
	+40	13 559 725	-275	-0.002 028
	+50	13 559 696	-304	-0.002 242

**Voltage Variations**

Power (V <sub>DC</sub> )	Temperature (°C)	Frequency (Hz)	Freq. Dev. (Hz)	Deviation (%)
115 % (4.43)	+20	13 559 768	-232	-0.001 711
85 % (3.27)	+20	13 559 768	-232	-0.001 711

The results shown in this test report refer only to the sample(s) tested unless otherwise stated. This test report cannot be reproduced, except in full, without prior written permission of the Company.

SGS Korea Co., Ltd. (Gunpo Laboratory) 4, LS-ro 182beon-gil, Gunpo-si, Gyeonggi-do, Korea, 15807 <http://www.sgsgroup.kr>

**10 minutes**
**Temperature Variations**

Power (V <sub>DC</sub> )	Temperature (°C)	Frequency (Hz)	Freq. Dev. (Hz)	Deviation (%)
3.85	-30	13 559 711	-289	-0.002 131
	-20	13 559 783	-217	-0.001 600
	-10	13 559 797	-203	-0.001 497
	0	13 559 812	-188	-0.001 386
	+10	13 559 783	-217	-0.001 600
	+20	13 559 768	-232	-0.001 711
	+30	13 559 740	-260	-0.001 917
	+40	13 559 725	-275	-0.002 028
	+50	13 559 696	-304	-0.002 242

**Voltage Variations**

Power (V <sub>DC</sub> )	Temperature (°C)	Frequency (Hz)	Freq. Dev. (Hz)	Deviation (%)
115 % (4.43)	+20	13 559 768	-232	-0.001 711
85 % (3.27)	+20	13 559 768	-232	-0.001 711

The results shown in this test report refer only to the sample(s) tested unless otherwise stated. This test report cannot be reproduced, except in full, without prior written permission of the Company.

## 4. 20 dB Bandwidth & Occupied Bandwidth

### 4.1. Test Setup

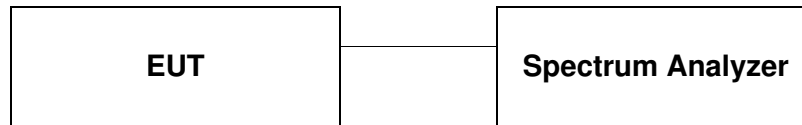

### 4.2. Limit

None ; for reporting purposes only.

### 4.3. Test Procedures

#### 4.3.1. 20 dB Bandwidth

The test follows DA 00-705.

The 20 dB bandwidth was measured with a spectrum analyzer connected to RF antenna connector (conducted measurement) while EUT was operating in transmit mode at the appropriate center frequency.

Use the following spectrum analyzer setting :

Span = approximately 2 to 3 times the 20 dB bandwidth, centered on a hopping channel.

RBW  $\geq$  1 % of the 20 dB bandwidth

VBW  $\geq$  RBW

Sweep = auto

Detector = peak

Trace = max hold

The marker-to-peak function to set the mark to the peak of the emission. Use the marker-delta function to measure 20 dB down one side of the emission. Reset the function, and move the marker to the other side of the emission, until it is (as close as possible to) even with the reference marker level. The marker-delta reading at this point is 20 dB bandwidth of the emission.

#### 4.3.2. Occupied Bandwidth

The span of the analyzer shall be set to capture all products of the modulation process, including the emission skirts.

The resolution bandwidth (RBW) shall be in the range of 1 % to 5 % of the occupied bandwidth (OBW) and video bandwidth (VBW) shall be approximately 3x RBW. Detector = sampling, Trace mode = max hold.

The trace data points are recovered and are directly summed in linear power level terms. The recovered amplitude data points, beginning at the lowest frequency, are placed in a running sum until 0.5 % of the total is reached and that frequency recorded. The process is repeated for the highest frequency data points (starting at the highest frequency, at the right side of the span, and going down in frequency).

This frequency is then recorded.

*The results shown in this test report refer only to the sample(s) tested unless otherwise stated. This test report cannot be reproduced, except in full, without prior written permission of the Company.*

**SGS Korea Co., Ltd. (Gunpo Laboratory)** 4, LS-ro 182beon-gil, Gunpo-si, Gyeonggi-do, Korea, 15807 <http://www.sgsgroup.kr>

RTT5041-20(2015.10.01)(3)

Tel. +82 31 428 5700 / Fax. +82 31 427 2370

A4(210 mm x 297 mm)

## 4.4. Test Result

Ambient temperature : (23 ± 1) °C  
 Relative humidity : 47 % R.H.

Frequency (MHz)	20 dB Bandwidth (kHz)	Occupied Bandwidth (kHz)
13.560	9.550	26.339

### - 20 dB Bandwidth

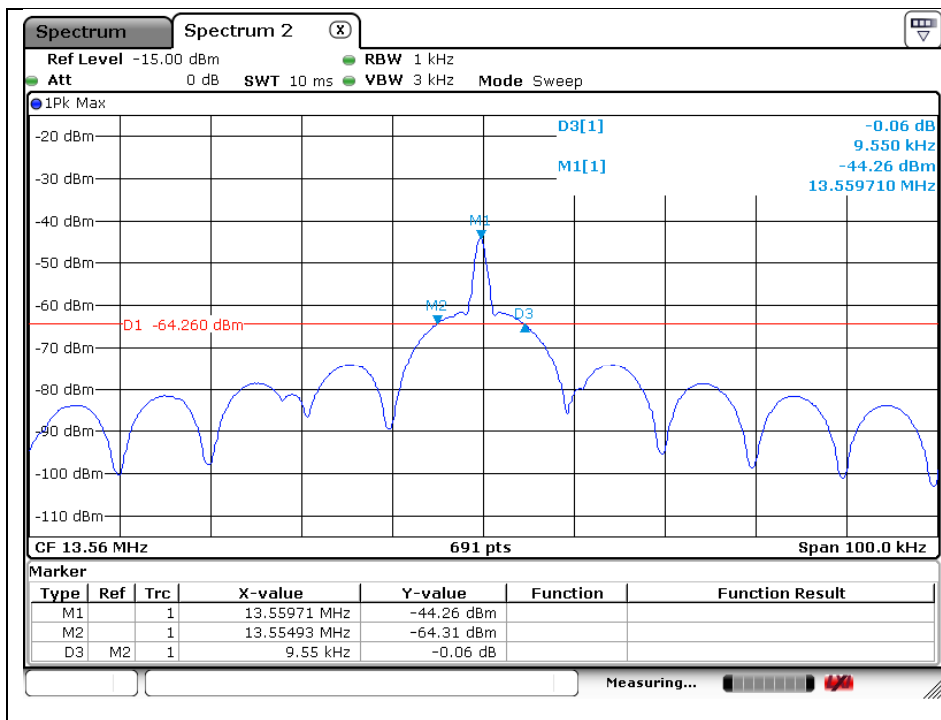

The results shown in this test report refer only to the sample(s) tested unless otherwise stated. This test report cannot be reproduced, except in full, without prior written permission of the Company.

## - Occupied Bandwidth

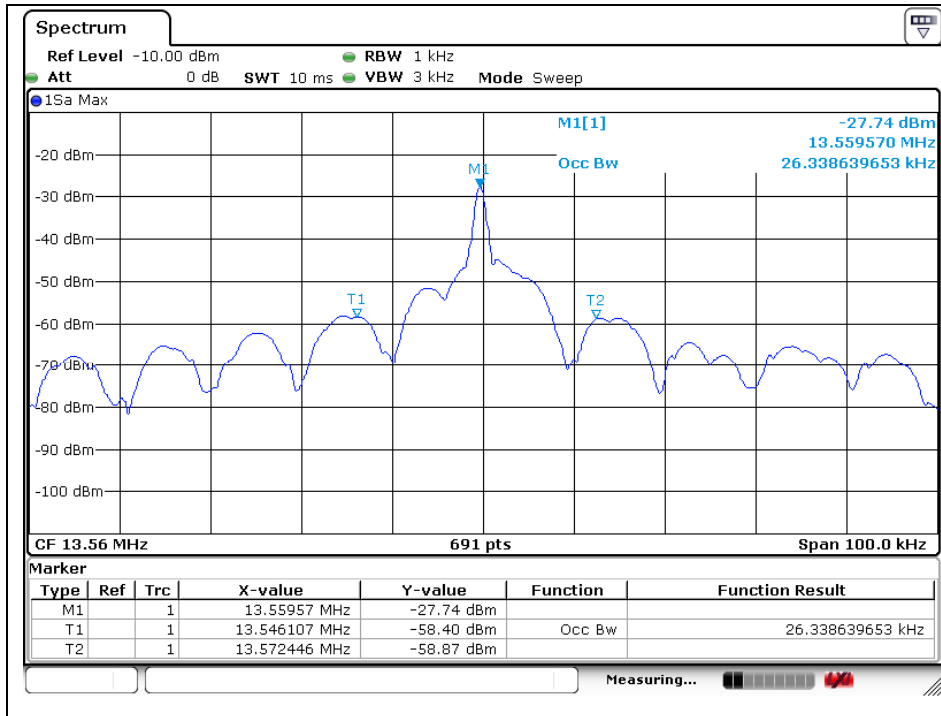

The results shown in this test report refer only to the sample(s) tested unless otherwise stated. This test report cannot be reproduced, except in full, without prior written permission of the Company.

## 5. AC Power Line Conducted Emissions

### 5.1. Test Setup

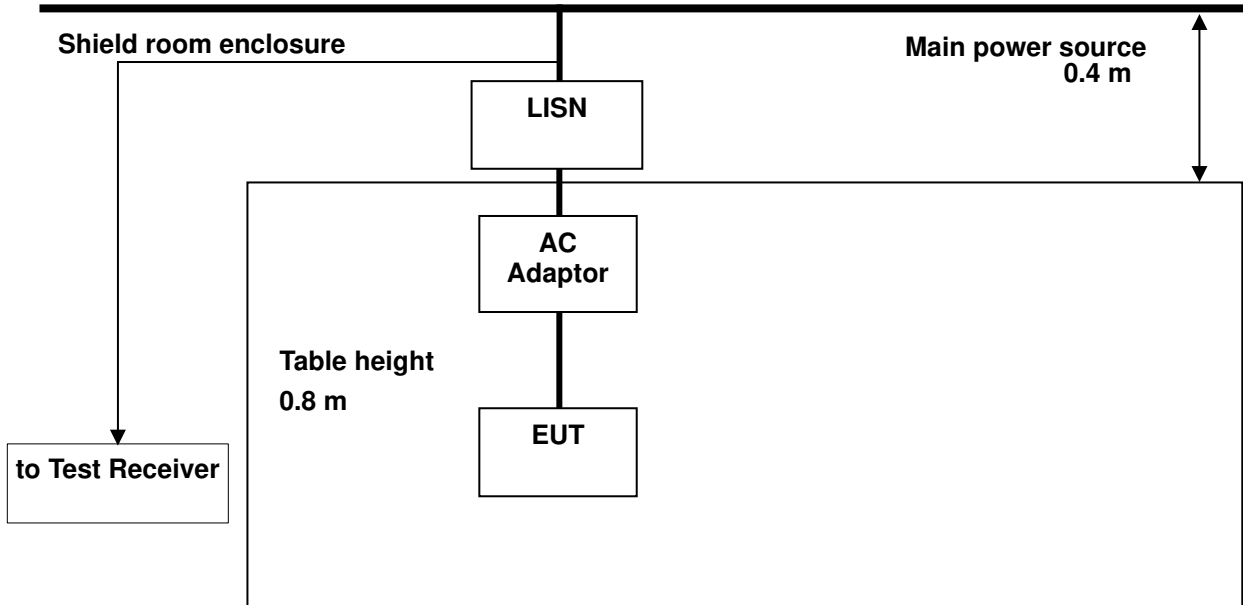

### 5.2. Limit

#### 5.2.1. FCC

According to §15.207(a), for an intentional radiator that is designed to be connected to the public utility (AC) power line, the radio frequency voltage that is conducted back onto the AC power line on any frequency or frequencies, within the band 150 kHz to 30 MHz, shall not exceed the limits in the following table, as measured using a 50  $\mu$ H / 50 ohm line impedance stabilization network(LISN).

Compliance with the provision of this paragraph shall on the measurement of the radio frequency voltage between each power line and ground at the power terminal. The lower applies at the boundary between the frequency ranges.

Frequency of Emission (MHz)	Conducted limit (dB $\mu$ V)	
	Quasi-peak	Average
0.15 – 0.50	66 - 56*	56 - 46*
0.50 – 5.00	56	46
5.00 – 30.0	60	50

\* Decreases with the logarithm of the frequency.

The results shown in this test report refer only to the sample(s) tested unless otherwise stated. This test report cannot be reproduced, except in full, without prior written permission of the Company.

SGS Korea Co., Ltd. (Gunpo Laboratory) 4, LS-ro 182beon-gil, Gunpo-si, Gyeonggi-do, Korea, 15807 <http://www.sgsgroup.kr>

### 5.2.2. IC

RSS-Gen Issue 4, 8.8, a radio apparatus that is designed to be connected to the public utility (AC) power line shall ensure that the radio frequency voltage, which is conducted back onto the AC power line on any frequency or frequencies, within the band 150 kHz to 30 MHz, shall not exceed the limits in Table 3.

Unless the requirements applicable to a given device state otherwise, for any radio apparatus equipped to operate from the public utility AC power supply either directly or indirectly (such as with a battery charger), the radio frequency voltage of emissions conducted back onto the AC power lines in the frequency range of 0.15 MHz to 30 MHz shall not exceed the limits shown in Table 3 below. The more stringent limit applies at the frequency range boundaries.

The conducted emissions shall be measured in accordance with the reference publication mentioned in Section 3.

**Table 3 – AC Power Line Conducted Emissions Limits**

Frequency (MHz)	Conducted limit (dB $\mu$ V)	
	Quasi-peak	Average**
0.15 – 0.50	66 - 56*	56 - 46*
0.50 – 5.00	56	46
5.00 – 30.0	60	50

\* Decreases with the logarithm of the frequency.

\*\* A linear average detector is required.

### 5.3. Test Procedures

AC line conducted emissions from the EUT were measured according to the dictates of ANSI C63.10-2013

1. The test procedure is performed in a 6.5 m × 3.6 m × 3.6 m (L × W × H) shielded room. The EUT along with its peripherals were placed on a 1.0 m (W) × 1.5 m (L) and 0.8 m in height wooden table and the EUT was adjusted to maintain a 0.4 meter space from a vertical reference plane.
2. The EUT was connected to power mains through a line impedance stabilization network (LISN) which provides 50 ohm coupling impedance for measuring instrument and the chassis ground was bounded to the horizontal ground plane of shielded room.
3. The excess power cable between the EUT and the LISN was bundled. All connecting cables of EUT were moved to find the maximum emission.

*The results shown in this test report refer only to the sample(s) tested unless otherwise stated. This test report cannot be reproduced, except in full, without prior written permission of the Company.*

## 5.4. Test Results

The following table shows the highest levels of conducted emissions on both phase of Hot and Neutral line.

Ambient temperature : (23 ± 1) °C

Relative humidity : 47 % R.H.

Frequency range : 0.15 MHz - 30 MHz

Measured Bandwidth : 9 kHz

FREQ. (MHz)	LEVEL(dB $\mu$ V)		LINE	LIMIT(dB $\mu$ V)		MARGIN(dB)	
	Quasi Peak	Average		Quasi Peak	Average	Quasi Peak	Average
0.17	41.50	26.10	N	64.96	54.96	23.46	28.86
0.22	26.20	12.90	N	62.82	52.82	36.62	39.92
0.67	37.30	27.50	N	56.00	46.00	18.70	18.50
8.95	14.30	8.70	N	60.00	50.00	45.70	41.30
14.86	20.00	11.50	N	60.00	50.00	40.00	38.50
24.77	15.20	8.10	N	60.00	50.00	44.80	41.90
0.17	38.30	24.20	H	64.96	54.96	26.66	30.76
0.19	40.10	26.20	H	64.04	54.04	23.94	27.84
0.67	40.50	30.10	H	56.00	46.00	15.50	15.90
5.31	26.60	20.10	H	60.00	50.00	33.40	29.90
14.38	23.80	15.70	H	60.00	50.00	36.20	34.30
19.86	13.30	7.90	H	60.00	50.00	46.70	42.10

Note;

1. Line ( H ): Hot, Line ( N ): Neutral
2. The limit for Class B device(s) from 150 kHz to 30 MHz are specified in Section of the Title 47 CFR.
3. Traces shown in plot made using a peak detector and average detector.
4. Deviations to the Specifications: None.

*The results shown in this test report refer only to the sample(s) tested unless otherwise stated. This test report cannot be reproduced, except in full, without prior written permission of the Company.*

**SGS Korea Co., Ltd. (Gunpo Laboratory)** 4, LS-ro 182beon-gil, Gunpo-si, Gyeonggi-do, Korea, 15807 <http://www.sgsgroup.kr>

Plots of Conducted Power line

Test mode: (Neutral)

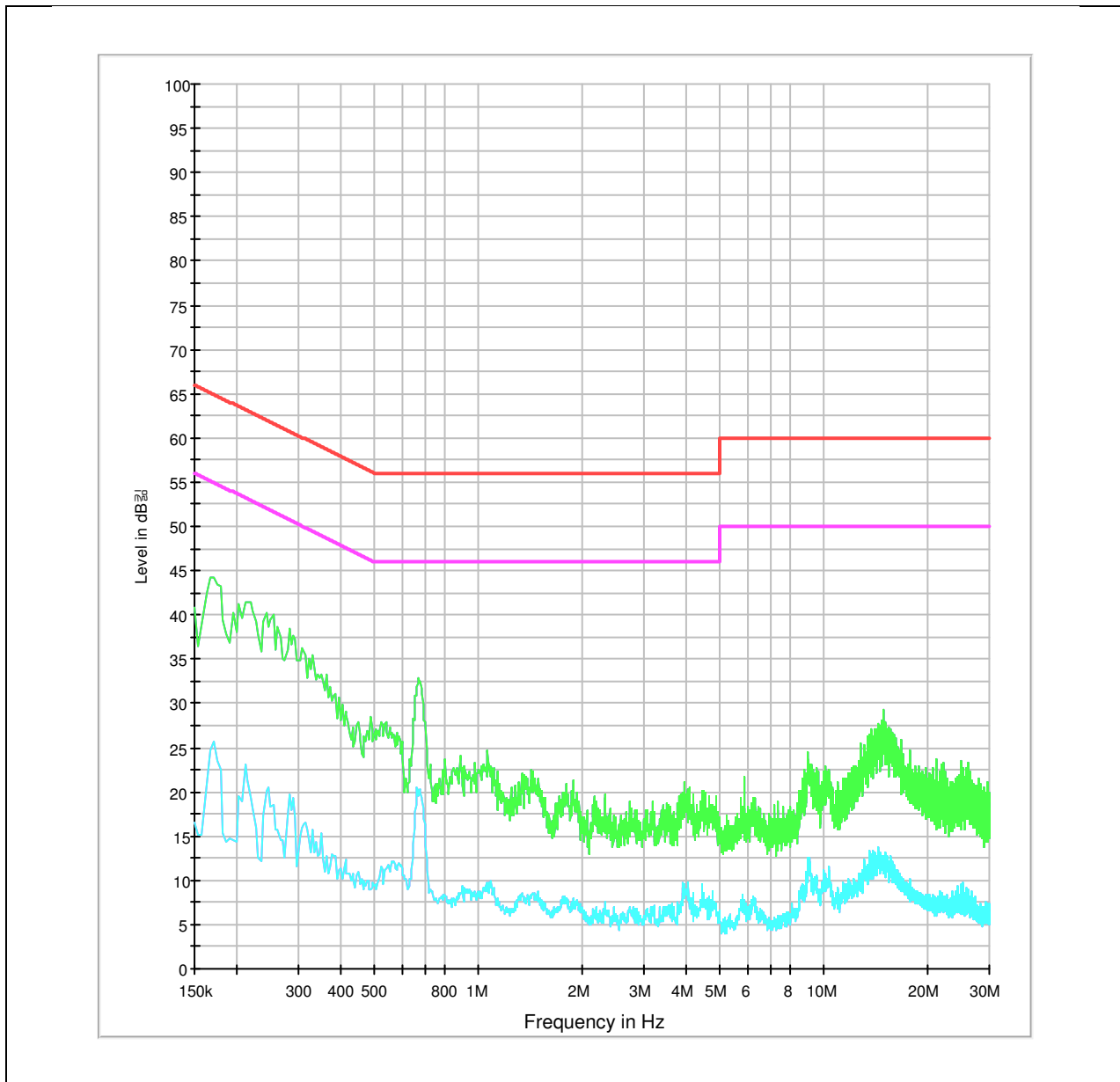

The results shown in this test report refer only to the sample(s) tested unless otherwise stated. This test report cannot be reproduced, except in full, without prior written permission of the Company.

SGS Korea Co., Ltd. (Gunpo Laboratory) 4, LS-ro 182beon-gil, Gunpo-si, Gyeonggi-do, Korea, 15807 <http://www.sgsgroup.kr>

Test mode: (Hot)

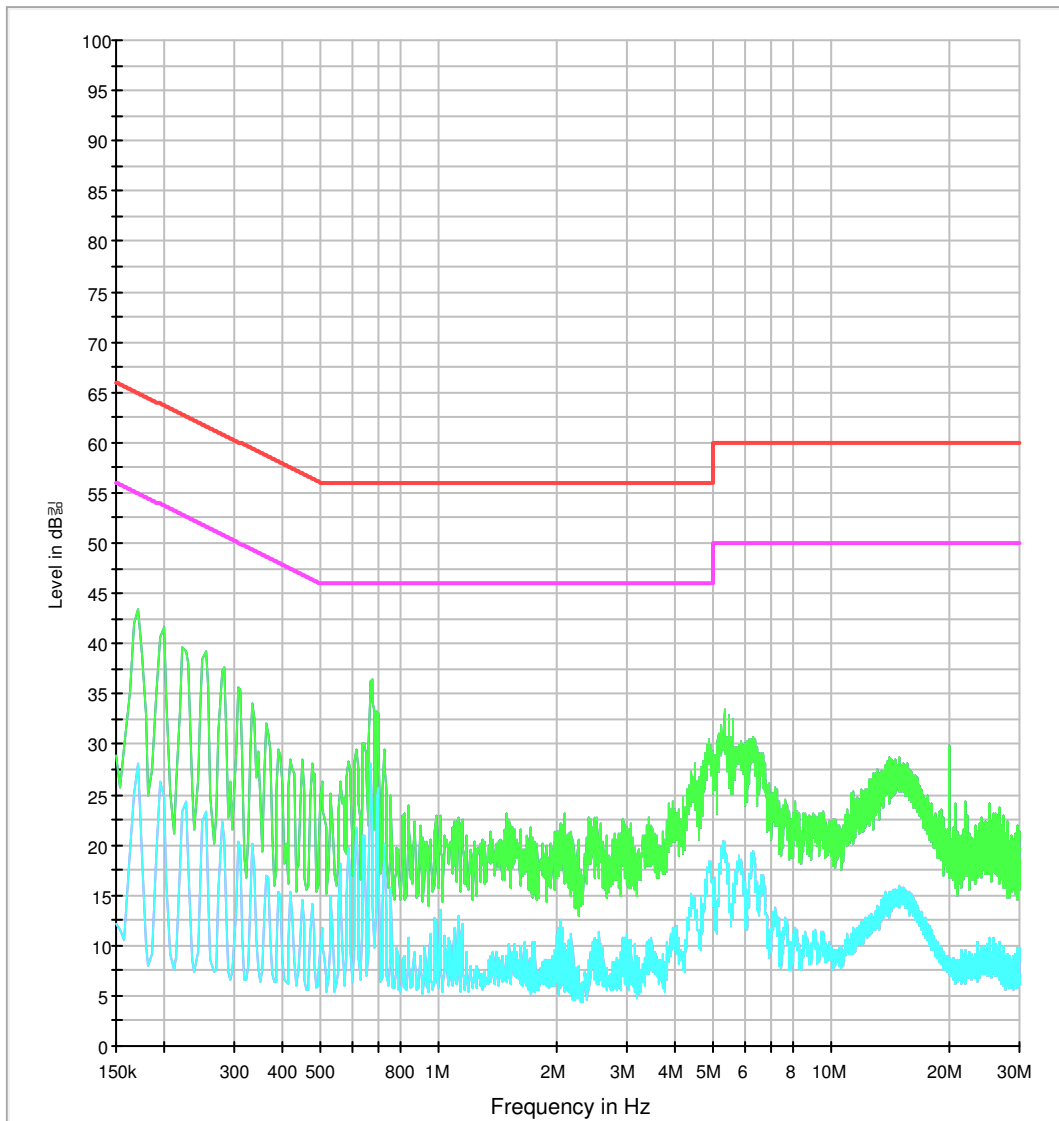

**-End of the Test report-**

The results shown in this test report refer only to the sample(s) tested unless otherwise stated. This test report cannot be reproduced, except in full, without prior written permission of the Company.

SGS Korea Co., Ltd. (Gunpo Laboratory) 4, LS-ro 182beon-gil, Gunpo-si, Gyeonggi-do, Korea, 15807 <http://www.sgsgroup.kr>