

Microwave oven

User manual

MS14K6000**



SAMSUNG

Contents

Important safety instructions	3
Installation	17
What's included	17
Turntable	18
Maintenance	19
Cleaning	19
Replacement (repair)	20
Care during an extended period of disuse	20
Before you start	21
Current time	21
Power saving	21
Child lock	22
Sound On/Off	22
Kitchen timer	22
About microwave energy	23
Cookware for microwaving	24
Operations	26
Feature panel	26
Simple steps to start	27
Manual mode	28
Common settings	29
Sensor mode	31
Auto mode	34
Convenience	41
Cooking Smart	46
Microwave cooking guide	46
Reheating guide	49
Defrosting guide	51
Quick & easy	53
Troubleshooting	54
Checkpoints	54
Information code	59
Technical specifications	60
Warranty	61
Samsung microwave oven	61

Important safety instructions

Congratulations on your new Samsung microwave oven. This manual contains important information on the installation, use and care of your appliance. Please take time to read this manual to take full advantage of your microwave oven's many benefits and features.

WHAT YOU NEED TO KNOW ABOUT SAFETY INSTRUCTIONS

Warnings and Important Safety Instructions in this manual do not cover all possible conditions and situations that may occur. It is your responsibility to use common sense, caution, and care when installing, maintaining, and operating your microwave oven.

PRECAUTIONS TO AVOID POSSIBLE EXPOSURE TO EXCESSIVE MICROWAVE ENERGY

- A.** Do not attempt to operate this oven with the door open since open-door operation can result in harmful exposure to microwave energy. It is important not to defeat or tamper with the safety interlocks.
- B.** Do not place any object between the oven front face and the door or allow soil or cleaner residue to accumulate on the sealing surface.
- C.** Do not operate the oven if it is damaged. It is particularly important that the oven door close properly and that there is no damage to the:
 - 1)** Door (bent),
 - 2)** Hinges and latches, (broken or loosened),
 - 3)** Door seals and sealing surface.
- D.** The oven should not be adjusted or repaired by anyone except properly qualified service personnel.

SAVE THESE INSTRUCTIONS



Important safety instructions

IMPORTANT SAFETY SYMBOLS AND PRECAUTIONS

What the icons and signs in this user manual mean:

 **WARNING**

Hazards or unsafe practices that may result in **severe personal injury or death**.

 **CAUTION**

Hazards or unsafe practices that may result in **minor personal injury or property damage**.

 **CAUTION**

To reduce the risk of fire, explosion, electric shock, or personal injury when using your microwave oven, follow these basic safety precautions:



Do NOT attempt.



Unplug the power plug from the wall socket.



Do NOT disassemble.



Make sure the machine is grounded to prevent electric shock.



Do NOT touch.



Call the service center for help.



Follow directions explicitly.



Note

These warning signs are here to prevent injury to you and others. Please follow them explicitly. After reading this section, keep it in a safe place for future reference.

SAVE THESE INSTRUCTIONS



STATE OF CALIFORNIA PROPOSITION 65 WARNING (US ONLY)

WARNING: This product contains chemicals known to the State of California to cause cancer and birth defects or other reproductive harm.

When using any electrical appliance, basic safety precautions should be followed, including the following:

⚠ WARNING

To reduce risk of burns, electric shock, fire, personal injury or exposure to excessive microwave energy:

1. Read all safety instructions before using the appliance.
2. Read and follow the specific "Precautions to avoid possible exposure to excessive microwave energy" on page 3.
3. This appliance must be grounded. Connect only to properly grounded outlets. See Important "Grounding instructions" on page 7 of this manual.
4. Install or locate this appliance only in accordance with the provided installation instructions.
5. Some products such as whole eggs and sealed containers (for example, closed glass jars) can explode if heated rapidly. Never heat them in a microwave oven.
6. Use this appliance only for its intended purpose as described in this manual. Do not expose this appliance to corrosive chemicals or vapors. This type of oven is specifically designed to heat, cook, or dry food. It is not designed for industrial or laboratory use.
7. As with any appliance, close supervision is necessary when it is used by children. Keep children away from the door when opening or closing it as they may bump themselves on the door or catch their fingers in the door.
8. Do not operate this appliance if it has a damaged cord or plug, if it is not working properly, or if it has been damaged or dropped.
9. This appliance should be repaired or serviced only by qualified service personnel. Contact the nearest authorized service facility for examination, repair, or adjustment.
10. Do not cover or block any openings on the appliance.
11. Do not tamper with or make any adjustments or repairs to the door.
12. Do not store this appliance outdoors. Do not use this product near water, for example, near a kitchen sink, in a wet basement, near a swimming pool, or similar locations.
13. Do not immerse the cord or plug in water.

SAVE THESE INSTRUCTIONS



Important safety instructions

- 14.** Keep the cord away from heated surfaces. (including the back of the oven).
- 15.** Do not let the cord hang over edge of table or counter.
- 16.** When cleaning surfaces of the door and oven that come together when the door closes, use only mild, nonabrasive soaps, or detergents applied with a sponge or soft cloth. Unplug the plug before cleaning.
- 17.** To reduce the risk of fire in the oven cavity:
 - 1)** Do not overcook food. Carefully attend the appliance when paper, plastic, or other combustible materials are placed inside the oven to facilitate cooking.
 - 2)** Remove wire twist-ties from paper or plastic bags before placing the bags in the oven.
 - 3)** If materials inside the oven ignite, keep the oven door closed, turn the oven off, and disconnect the power cord, or shut off the power at the fuse or circuit breaker panel. If the door is opened, the fire may spread.
 - 4)** Do not use the cavity for storage purposes. Do not leave paper products, cooking utensils, or food in the cavity when not in use.
- 18.** Liquids, such as water, milk, coffee, or tea can be overheated beyond the boiling point without appearing to be boiling. Visible bubbling or boiling when the container is removed from the microwave oven is not always present. THIS COULD RESULT IN VERY HOT LIQUIDS SUDDENLY BOILING OVER WHEN THE CONTAINER IS DISTURBED OR A SPOON OR OTHER UTENSIL IS INSERTED INTO THE LIQUID. To reduce the risk of injury:
 - 1)** Do not overheat liquid.
 - 2)** Stir liquid both before and halfway through heating it.
 - 3)** Do not use straight-sided containers with narrow necks.
 - 4)** After heating, allow the container to stand in the microwave oven for a short time before removing the container.
 - 5)** Use extreme care when inserting a spoon or other utensil into the container.
- 19.** Oversized food or oversized metal utensils should not be inserted into the microwave / toaster oven as they may cause a fire or electric shock.
- 20.** Do not clean with metal scouring pads. A piece of metal could come off the pad, contact electrical parts, and cause an electric shock.
- 21.** Do not put paper products into the oven when you are operating it in the toaster mode.
- 22.** Do not store any materials, other than manufacturer's recommended accessories, in this oven when not in use.
- 23.** Do not cover the racks or any other part of the oven with metal foil. This will cause the oven to overheat.

SAVE THESE INSTRUCTIONS



CAUTION

1. Over The Range model only
 - Clean Ventilating Hoods frequently. - Grease should not be allowed to accumulate on the hood of the filter.
 - When flaming foods under the hood, turn the fan on.
 - Use care when cleaning the vent-hood filter. Corrosive cleaning agents, such as lye-based oven cleaner, may damage the filter.
2. Push Button type model only
 - To avoid possible exposure to excessive microwave energy, do not open the door by pulling on any part of the door by hand. Open the door by pushing the button located on the bottom front-right side of the microwave only.

GROUNDING INSTRUCTIONS

This appliance must be grounded. In the event of an electrical short circuit, grounding reduces the risk of electric shock by providing an escape wire for the electrical current. This appliance is equipped with a cord that includes a grounding wire and a grounding plug. The plug must be plugged into an outlet that is properly installed and grounded.

WARNING

Improper use of the grounding plug can result in a risk of electric shock.

- Plug the power cord into a grounded 3 pronged outlet. Do not remove the third (grounding) prong. Do not use an adaptor or otherwise defeat the grounding plug.
- Consult a qualified electrician or service person if you do not understand the grounding instructions or if you are not sure if the appliance is properly grounded.
- We do not recommend using an extension cord with this appliance. If the power-supply cord is too short, have a qualified electrician or serviceman install an outlet near the appliance. However, if it is necessary to use an extension cord, read and follow the "Use of Extension Cords" section on the next page.

SAVE THESE INSTRUCTIONS



Important safety instructions

USE OF EXTENSION CORDS

A short power-supply cord is provided to reduce the risk of your becoming entangled in or tripping over a longer cord. Longer cord sets or extension cords are available and you can use them if you exercise care. If you use a long cord or extension cord:

1. The marked electrical rating of the cord set or extension cord should be at least as great as the electrical rating of the appliance.
2. The extension cord must be a grounding-type 3-wire cord and it must be plugged into a 3-slot outlet.
3. The longer cord should be arranged so that it will not drape over the counter top or tabletop where it can be pulled on by children or tripped over accidentally. If you use an extension cord, the interior light may flicker and the speed of the blower may vary when the microwave oven is on. Cooking times may be longer too.



SAVE THESE INSTRUCTIONS



▲ CRITICAL INSTALLATION WARNINGS



The installation of this appliance must be performed by a qualified technician or service company.

- Failing to have a qualified technician install the oven may result in electric shock, fire, an explosion, problems with the product, or injury.

Unpack the oven, remove all packaging material and examine the oven for any damage such as dents on the interior or exterior of the oven, broken door latches, cracks in the door, or a door that is not lined up correctly. If there is any damage, do not operate the oven and notify your dealer immediately.

Make sure to install your oven in a location with adequate space.

Remove all foreign substances such as dust or water from the power plug terminals and contact points using a dry cloth on a regular basis.

- Unplug the power plug and clean it with a dry cloth.
- Failing to do so may result in electric shock or fire.

Plug the power cord into a properly grounded 3 pronged outlet. Your oven should be the only appliance connected to this circuit.

- Sharing a wall socket with other appliances, using a power strip, or extending the power cord may result in electric shock or fire.
- Do not use an electric transformer. It may result in electric shock or fire.
- Ensure that the voltage, frequency, and current provided match the product's specifications. Failing to do so may result in electric shock or fire.

Keep all packaging materials out of the reach of children. Children may use them for play.



This appliance must be properly grounded. Read and follow the specific "Grounding instructions" found in the beginning of this Section. Do not ground the appliance to a gas pipe, plastic water pipe, or telephone line.

- This may result in electric shock, fire, an explosion, or problems with the product.
- Never plug the power cord into a socket that is not grounded correctly and make sure that it is grounded in accordance with local and national codes.



Do not cut or remove the third (ground) prong from the power cord under any circumstances.

Connect the oven to a 20A circuit. If you connect the oven to a 15A circuit, make sure that the circuit breaker is operable.



SAVE THESE INSTRUCTIONS



Important safety instructions

-  Do not install this appliance in a humid, oily, or dusty location, or in a location exposed to direct sunlight or water (rain drops).
 - This may result in electric shock or fire.Plug the power plug into the wall socket firmly. Do not use a damaged power plug, damaged power cord, or loose wall socket.
 - This may result in electric shock or fire.Do not mount over a sink.
Do not pull or excessively bend the power cord.
Do not twist or tie the power cord.
Do not hook the power cord over a metal object, place a heavy object on the power cord, insert the power cord between objects, or push the power cord into the space behind the appliance.
 - This may result in electric shock or fire.Do not pull the power cord when you unplug the oven.
 - Unplug the oven by pulling the plug only.
 - Failing to do so may result in electric shock or fire.
-  If the power plug or power cord is damaged, contact your nearest service center for a replacement or repair.



INSTALLATION CAUTIONS

-  Position the oven so that the plug is easily accessible.
 - Failing to do so may result in electric shock or fire due to electric leakage.
-  Unplug the oven when it is not being used for long periods of time or during a thunder/lightning storm.
 - Failing to do so may result in electric shock or fire.

SAVE THESE INSTRUCTIONS



▲ CRITICAL USAGE WARNINGS

-  If the microwave appliance is flooded, please contact your nearest Samsung service center. Failing to do so may result in electric shock or fire. Read and follow the specific “Precautions to Avoid Possible Exposure to Excessive Microwave Energy”, found in the beginning of this Safety Information section. If the microwave generates a strange noise, a burning smell or smoke, unplug it immediately and contact your nearest service center.
- Failing to do so may result in electric shock or fire.
- In the event of a gas leak (propane gas, LP gas, etc.), ventilate the room immediately. Do not touch the microwave, power cord, or plug.
- Do not use a ventilating fan.
 - A spark may result in an explosion or fire.
- Take care that the door or any of the other parts do not come into contact with your body while cooking or just after cooking.
- Failing to do so may result in burns.
- In the event of a grease fire on the surface units below the oven, smother the flaming pan on the surface unit by covering the pan completely with a lid, a cookie sheet, or a flat tray.
- Never leave surface units beneath your oven unattended at high heat settings. Boil overs cause smoking and greasy spillovers that may ignite and spread if the vent fan is operating. To minimize automatic fan operation, use adequate sized cookware and use high heat on surface units only when necessary.
- If materials inside the oven should ignite, keep the oven door closed, turn the oven off and disconnect the power cord, or shut off power at the fuse or circuit breaker panel. If the door is opened, the fire may spread.
- Always observe Safety Precautions when using your oven. Never try to repair the oven on your own. There is dangerous voltage inside. If the oven needs to be repaired, contact an authorized Samsung service center near you.
-  Do not attempt to repair, disassemble, or modify the appliance yourself.
- Because a high voltage current enters the product chassis during operation, opening the chassis can result in electric shock or fire.
 - You may be exposed to electromagnetic waves.
 - When the oven requires repair, contact your nearest Samsung service center.
-  If any foreign substance such as water enters the microwave, unplug it and contact your nearest Samsung service center.
- Failing to do so may result in electric shock or fire.

SAVE THESE INSTRUCTIONS



Important safety instructions



Do not touch the power plug with wet hands.

- This may result in electric shock.

Do not turn the appliance off by unplugging the power plug while the appliance is in operation.

- Plugging the power plug into the wall socket again may cause a spark and result in electric shock or fire.

Keep all packaging materials well out of the reach of children. Packaging materials can be dangerous to children.

- If a child places a bag over his or her head, the child can suffocate.

Do not let children or any person with reduced physical, sensory or mental capabilities use this appliance unsupervised. Make sure that the appliance is out of the reach of children.

- Failing to do so may result in electric shock, burns, or injury.

Do not touch the inside of the appliance immediately after cooking. The inside of the appliance will be hot.

- The heat on the inside of the oven can cause burns.

Do not put aluminum foil (except as specifically directed in this manual), metal objects (such as containers, forks, etc.) or containers with golden or silver rims into the microwave.

- These objects can cause sparks or a fire.

Do not use or place flammable sprays or objects near the oven.

- Heat from the microwave can cause flammable sprays to explode or burn.
- Failing to do so may result in electric shock or injury.



Do not tamper with or make any adjustments or repairs to the door. Under no circumstances should you remove the outer cabinet.

Do not store or use the oven outdoors.

SAVE THESE INSTRUCTIONS



USAGE CAUTIONS

-  If the surface of the microwave is cracked, turn the microwave off.
- Failing to do so may result in electric shock.
- Dishes and containers can become hot. Handle with care.
Hot foods and steam can cause burns. Carefully remove container coverings, directing steam away from your hands and face.
Remove lids from baby food before heating. After heating baby food, stir well to distribute the heat evenly. Always test the temperature by tasting before feeding the baby. The glass jar or surface of the food may be cooler than the food in the interior, which can be so hot that it will burn the infant's mouth.
Make sure all cookware used in the oven is suitable for microwaving.
Use microwavable cookware in strict compliance with such manufacturer's recommendations.
-  Do not stand on top of the microwave or place objects (such as laundry, oven covers, lighted candles, lighted cigarettes, dishes, chemicals, metal objects, etc.) on the appliance.
- Items, such as a cloth, may get caught in the door.
 - This may result in electric shock, fire, problems with the product, or injury.
- Do not operate the appliance with wet hands.
- This may result in electric shock.
- Do not spray volatile material such as insecticide onto the surface of the appliance.
- As well as being harmful to humans, it may also result in electric shock, fire, or problems with the product.
- Do not place the appliance over a fragile object such as a sink or glass object.
- This may result in damage to the sink or glass object.
- Do not put your face or body close to the appliance while cooking or when opening the door just after cooking.
- Take care that children do not come too close to the appliance.
 - Failing to do so may result in children burning themselves.
- Do not place food or heavy objects over the door.
- The food or object may fall when you open the door and this may result in burns or injury.
- Do not abruptly cool the door, the inside of the appliance, or the cooked food inside by pouring water over it during or just after cooking.
- This may result in damage to the appliance. The steam or water spray may result in burns or injury.



Important safety instructions

- ❑ Do not cook without the glass tray in place on the oven floor. Food will not cook properly without the tray.
Do not defrost frozen beverages in narrow-necked bottles. The containers can break.
Do not scratch the glass of the oven door with a sharp object.
 - This may result in the glass being damaged or broken.Do not store anything directly on top of the appliance when it is in operation.
Do not use sealed containers. Remove seals and lids before heating. Sealed containers can explode due to the buildup of pressure even after the oven has been turned off.

CRITICAL CLEANING INSTRUCTIONS

- Do not clean the appliance by spraying water directly onto it.
Do not use benzene, thinner, or alcohol to clean the appliance.
- This may result in discoloration, deformation, damage, electric shock, or fire.
- Before cleaning or performing maintenance, unplug the appliance from the wall socket and remove food waste from the door and cooking compartment.
- Failing to do so may result in electric shock or fire.
- Take care not to hurt yourself when cleaning the appliance.
(external/internal)
- You may hurt yourself on the sharp edges of the appliance.
- Do not clean the appliance with a steam cleaner.
- This may result in corrosion.
- Keep the inside of the oven clean. Food particles or spattered oils stuck to the oven walls or floor can cause paint damage and reduce the efficiency of the oven.

SAVE THESE INSTRUCTIONS





INSTALLING YOUR MICROWAVE OVEN

Place the oven on a flat level surface 33.5 inches (85 cm) above the floor. The surface should be strong enough to safely bear the weight of the oven.

NOT FOR BUILT-IN INSTALLATION

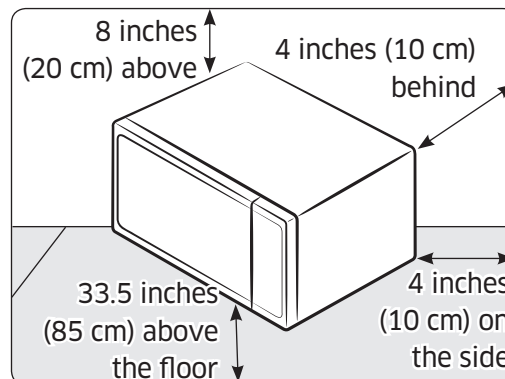
1. When you install your oven, make sure there is adequate ventilation for your oven by leaving at least 4 inches (10 cm) of space behind and on the sides of the oven and 8 inches (20 cm) of space above.
2. Remove all packing materials inside the oven.
3. Install the roller ring and turntable. Check that the turntable rotates freely. (Turntable type model only)
4. This microwave oven has to be positioned so that the plug is accessible.



-  If the power cord is damaged, it must be replaced by the manufacturer, the manufacturer's service agent or similarly qualified persons in order to avoid a hazard. For your personal safety, plug the power cord into a properly grounded AC socket.
-  Do not install the microwave oven in hot or damp surroundings such as next to a traditional oven or radiator. The power supply specifications of the oven must be observed and any extension cable used must have the same specifications as the power cable supplied with the oven. Wipe the interior and the door seal with a damp cloth before using your microwave oven for the first time.

CLEANING THE TURNTABLE AND ROLLER RINGS

Clean the roller rings periodically and wash the turntable as required. You can wash the turntable safely in your dishwasher.

SAVE THESE INSTRUCTIONS



Important safety instructions

STORING AND REPAIRING YOUR MICROWAVE OVEN

If you need to store your microwave oven for a short or extended period of time, choose a dust-free, dry location. Dust and dampness may adversely affect the microwave parts.

- ⚠ • Do not repair, replace, or service any part of your microwave oven yourself. Allow only a qualified service technician to perform repairs. If the oven is faulty and needs servicing, or you are in doubt about its condition, unplug the oven from the power outlet and contact your nearest Samsung service center.
- Do not use the oven if it is damaged, in particular, if the door or door seals are damaged. Door damage includes a broken hinge, a worn out seal, or distorted/bent casing.
- Do not remove the oven from its casing.
- This microwave oven is for home use only and is not intended for commercial use.



Installation

What's included

Make sure all parts and accessories are included in the product package. If you have a problem with the oven or accessories, contact a local Samsung customer center or your retailer.

Oven at a glance

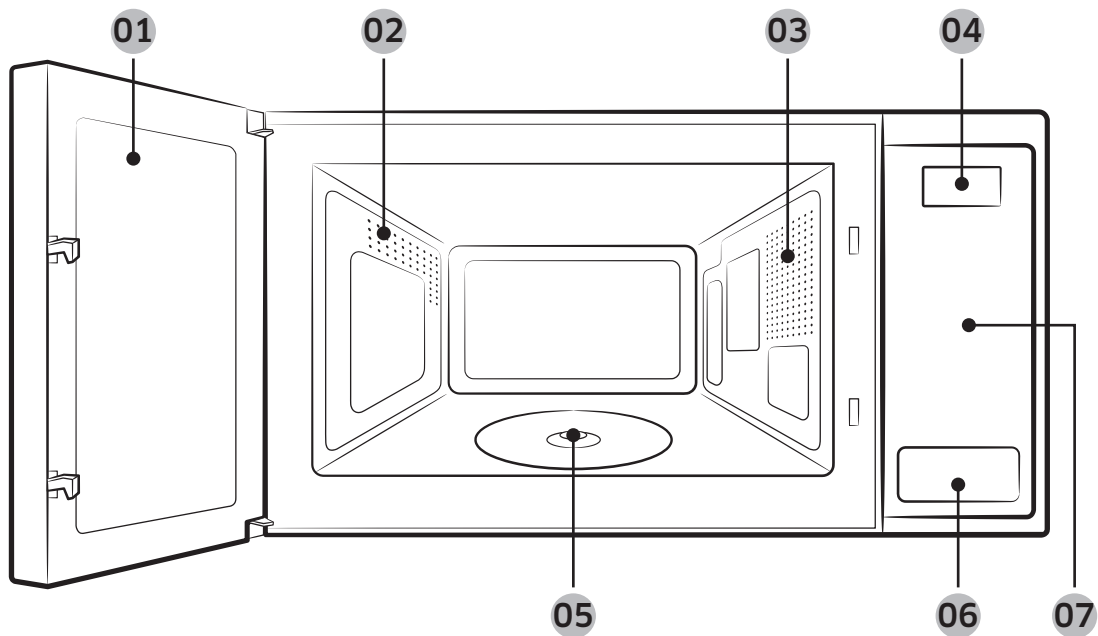

01 Door

02 Vent

03 Oven light

04 Display

05 Coupler

06 Push button door
opener

07 Feature panel

Installation

Accessories

The oven comes with different accessories that help you prepare different types of food.



Roller ring

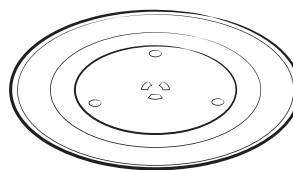

Turntable

Roller ring	Put in the center of the base. It supports the turntable.
Turntable	Put on the roller ring with the center fitting the coupler on the microwave's floor. It serves as a cooking base.

NOTE

- Do not operate the oven without the turntable on the roller ring.

Turntable

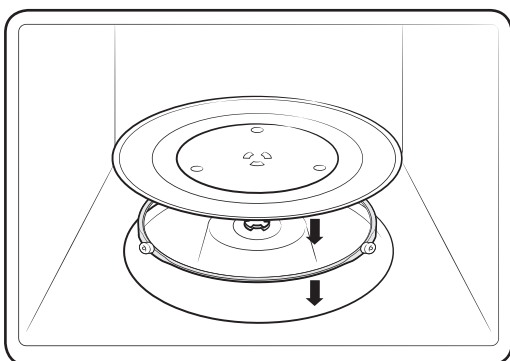

Remove all packing materials inside the oven. Install the roller ring and turntable. Check that the turntable rotates freely.

Maintenance

Cleaning

Clean the oven regularly to prevent impurities from building up on or inside the oven. Also pay special attention to the door, door sealing, and turntable and roller ring (applicable models only).

If the door won't open or close smoothly, first check if the door seals have built up impurities. Use a soft cloth and soapy water to clean both the inner and outer sides of the oven. Rinse and dry well.

To remove stubborn impurities with bad smells from inside the oven

1. With the oven empty, put a cup of diluted lemon juice on the center of the turntable.
2. Heat the oven for 10 minutes at maximum power.
3. When the cycle is complete, wait until the oven cools down. Then, open the door and clean the cooking chamber.

To clean inside swing-heater models

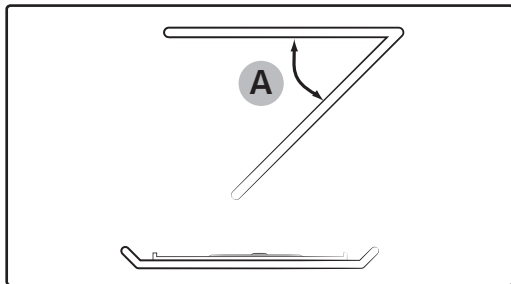

To clean the upper area of the cooking chamber, lower the top heating element by 45° (A) as shown. This will help you clean the upper area. When done, reposition the top heating element.

⚠ CAUTION

- Keep the door and door sealing clean and ensure the door opens and closes smoothly. Otherwise, the oven's lifecycle may be shortened.
- Take caution not to spill water into the oven vents.
- Do not use any abrasive or chemical substances for cleaning.
- After each use of the oven, use a mild detergent to clean the cooking chamber after waiting for the oven to cool down.

Maintenance

Replacement (repair)

▲ WARNING

This oven has no user-removable parts inside. Do not try to replace parts or repair the oven yourself.

- If you encounter a problem with hinges, sealing, and/or the door, contact a qualified technician or a local Samsung service center for technical assistance.
- If you want to replace the light bulb, contact a local Samsung service center. Do not replace it yourself.
- If you encounter a problem with the outer housing of the oven, first unplug the power cord from the power source, and then contact a local Samsung service center.

Care during an extended period of disuse

- If you don't use the oven for an extended period of time, unplug the power cord and move the oven to a dry, dust-free location. Dust and moisture that builds up inside the oven may affect the performance of the oven.

Before you start

Before you use the microwave for the first time, there is some basic information you should know. This information starts below.

NOTE

- Before or during any cooking mode, you can set/change the clock or the kitchen timer.

Current time

It is important to set the correct clock time to ensure correct automatic operations.

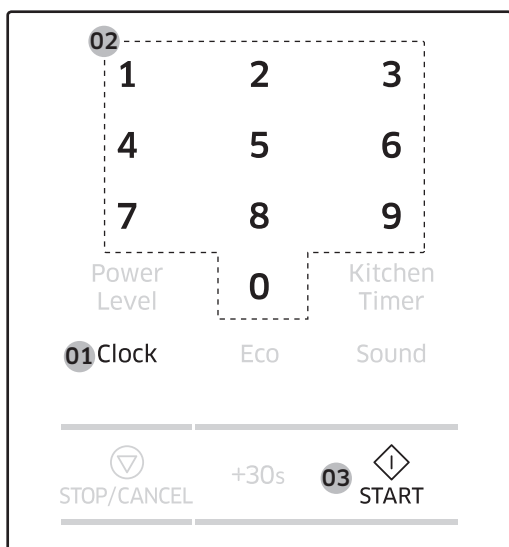

1. Press **Clock**.
2. Use the number buttons to enter the current time. For example, press 5, 0, and 0 in sequence for 5:00 o'clock.
3. Press **START** to confirm your settings. The colon (:) indicator blinks several times.

Power saving

To reduce power consumption when not using the oven, use the power saving function of the oven.



Auto power saving

- After 25 minutes of user inactivity, the oven automatically enters power saving mode. Any previous function will be cancelled, and the current time will be displayed.
- To activate power saving, press **Eco** to turn off the display.
- To deactivate power saving, open the door or press **Eco** again. The display turns back on showing the current time.
- If you open the door and leave it open, the oven light will turn off after 5 minutes.

Before you start

Child lock

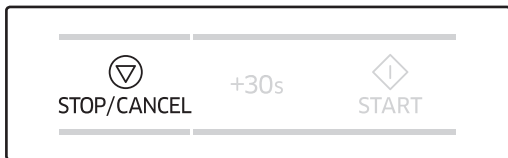

To prevent accidents, Child Lock disables all controls except for the Eco button. Hold down **STOP/CANCEL** for 3 seconds to activate. Hold down **STOP/CANCEL** again for 3 seconds to deactivate.

Sound On/Off

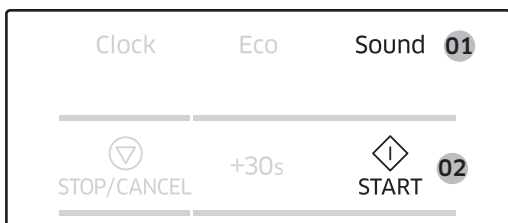

You can mute or unmute the sounds (beeps or melody) made by the oven.

- To mute the sounds, press **Sound** until “OFF” appears in the display. Then, press **START**.
- To unmute the sounds, press **Sound** again until “ON” appears in the display. Then, press **START**.

Kitchen timer

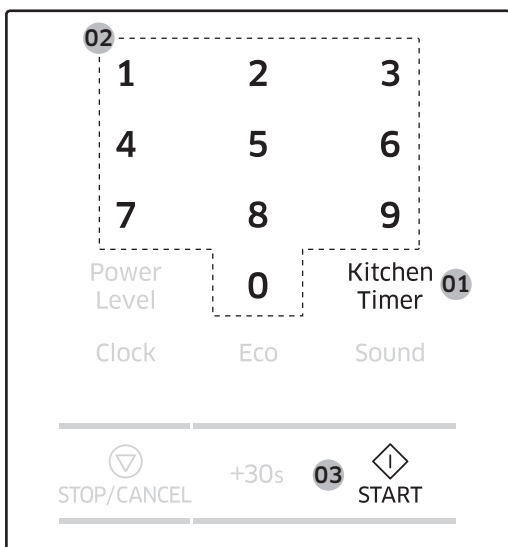

1. Press **Kitchen Timer**.
2. Press the number buttons to set the length of time. For example, press 3 - 0 - 0 to set the timer to 3 minutes.
3. Press **START**. The Kitchen Timer counts down the time.

About microwave energy

Microwaves are high-frequency electromagnetic waves. The magnetron built into the oven generates microwaves which cook or reheat food without deforming or discolouring it.

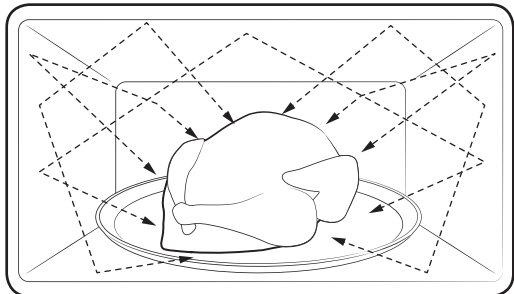

1. The microwaves generated by the magnetron are distributed uniformly by the microwave's distribution system. This is why the food cooks evenly.
2. The microwaves are absorbed by the food to a depth of approx. 1 inch (2.5 cm). Then, the microwaves dissipate inside the food as cooking continues.
3. The cooking time is affected by the following conditions of the food:
 - Quantity and density
 - Moisture content
 - Initial temperature (especially, when frozen)

NOTE

The cooked food retains heat in its core after cooking is complete. This is why you must observe the standing times specified in this manual, which ensures food cooks evenly down to the core.

Before you start

Cookware for microwaving

Cookware used for Microwave Mode must allow microwaves to pass through and penetrate food. Metals such as stainless steel, aluminum, and copper reflect microwaves. Therefore, do not use cookware made of metallic materials. Cookware marked microwave - safe is always safe for use. For additional information on appropriate cookware, refer to the following guide.

Requirements:

- Flat bottom and straight sides
- Tight-fitting lid
- Well-balanced pan with handles that weigh less than the main pan

Material	Microwave-safe	Description	
Aluminium foil	△	Use for a small serving size to protect against overcooking. Arcing can occur if the foil is near the oven wall or if you use an excessive amount of foil.	
Crusty plate	○	Do not use for preheating for more than 8 minutes.	
Bone china or earthenware	○	Porcelain, pottery, glazed earthenware, and bone china are usually microwave-safe, unless decorated with a metal trim.	
Disposable polyester cardboard dishes	○	Some frozen foods are packaged in these dishes.	
Fast-food packaging	Polystyrene cups or containers	○	Overheating may cause these to melt.
	Paper bags or newspaper	×	These may catch fire.
	Recycled paper or metal trims	×	These may cause arcing

○ : Microwave Safe

△ : Use Caution

× : Microwave Unsafe

Material		Microwave-safe	Description
Glassware	Oven-to-table ware	○	Microwave-safe unless decorated with metal trim.
	Fine glassware	○	Rapid heating may cause delicate glassware to break or crack.
	Glass jars	○	Appropriate for warming only. Remove the lid before cooking.
Metal	Dishes	✗	These may cause arcing or fire.
	Freezer bag with twist-ties	✗	
Paper	Plates, cups, napkins, and kitchen paper	○	Use to cook for a short time. These absorb excess moisture.
	Recycled paper	✗	Causes arcing.
Plastic	Containers	○	Use thermoplastic containers only. Some plastics may warp or discolour at high temperatures.
	Cling film	○	Use to maintain moisture after cooking.
	Freezer bags	△	Use boilable or ovenproof bags only.
Wax or grease-proof paper		○	Use to maintain moisture and prevent spattering.

○ : Microwave Safe

△ : Use Caution

✗ : Microwave Unsafe

Before you start

Operations

Feature panel

The front panel comes in a wide range of materials and colors. For improved quality, the actual appearance of the oven is subject to change without notice.

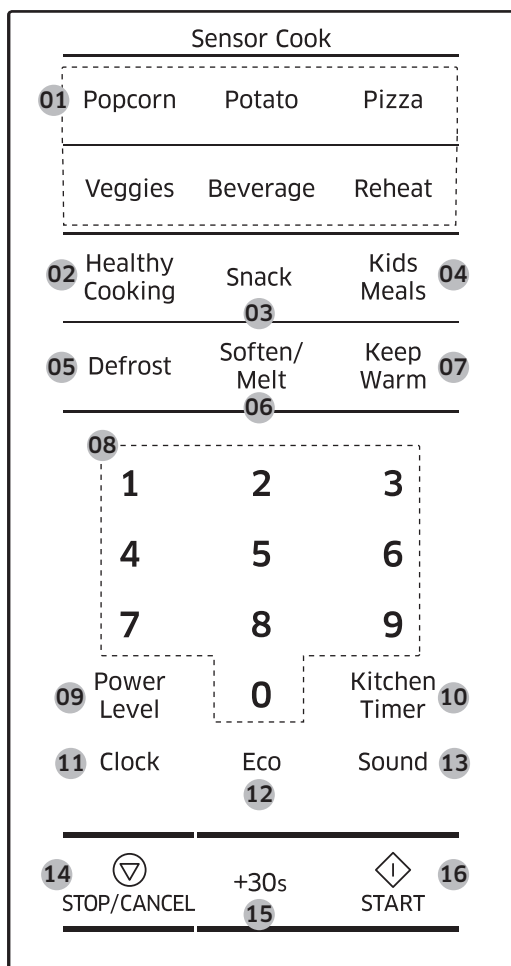

01	Sensor Cook
02	Healthy Cooking
03	Snack
04	Kids Meals
05	Defrost
06	Soften/Melt
07	Keep Warm
08	Number
09	Power Level
10	Kitchen Timer
11	Clock
12	Eco
13	Sound
14	STOP/CANCEL
15	+30s
16	START

Simple steps to start

To cook food

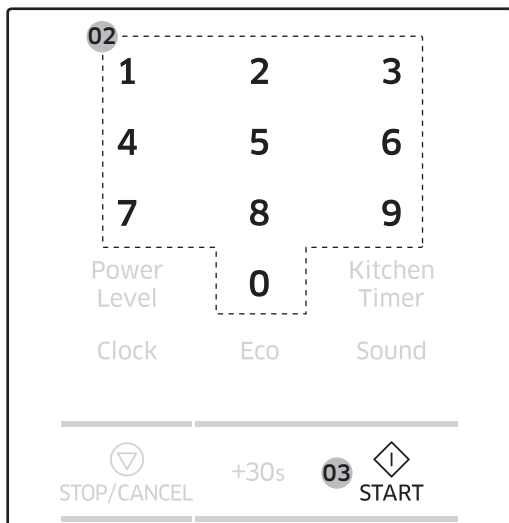

1. Put the food in a microwave-safe container, and then put the container in the center of the turntable.
2. Use the number buttons to set the cooking time.
3. Press **START**.

NOTE

When cooking is complete, the oven beeps 4 times. Use oven gloves to take out the food.

To defrost frozen food

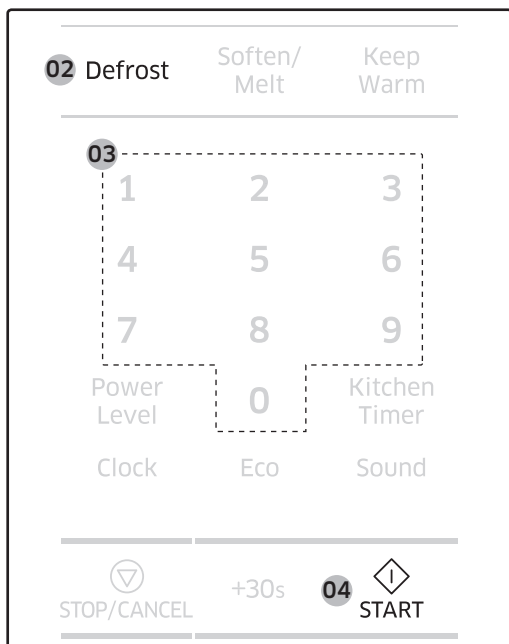

1. Put the frozen food in a microwave-safe container, and then put the container in the center of the turntable.
2. Press **Defrost**.
3. Use the number buttons to set the serving size.
4. Press **START**.

NOTE

For more information, see the Defrost section on page 41.

Operations

Manual mode

Microwave

This is the basic function of this microwave oven. The power level is set to High by default.

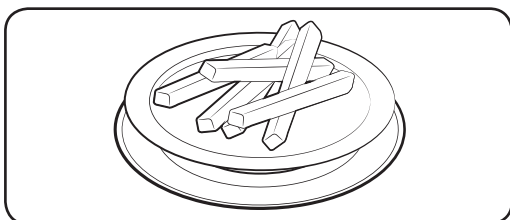

1. Put food in a microwave-safe container, and then place the container on the turntable.

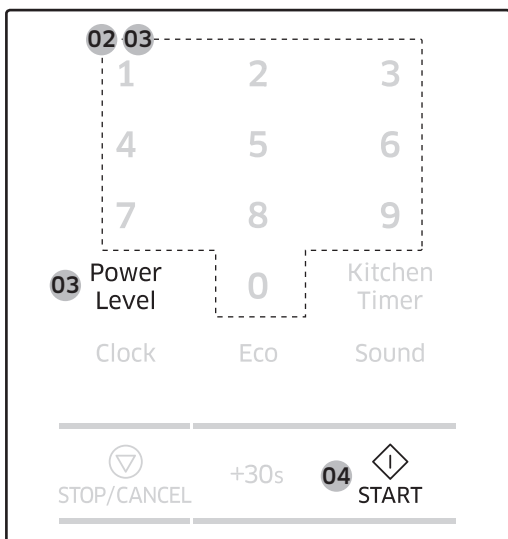

2. Use the number buttons to set the cooking time (max: 99 min 99 sec). For example, to set the time to 10 minutes, press 1 and 0 for the minutes, and 0 and 0 for the seconds (10:00).
3. To change the default power level, press **Power Level**, and then select a different level. See the **Power level** section on page 30 for details.
4. Press **START**.
5. When cooking is complete, the oven beeps 4 times. Use oven gloves to take out the food.

Common settings

Cooking time

Follow these steps to set or change the cooking time. By default, the power level is set to High.

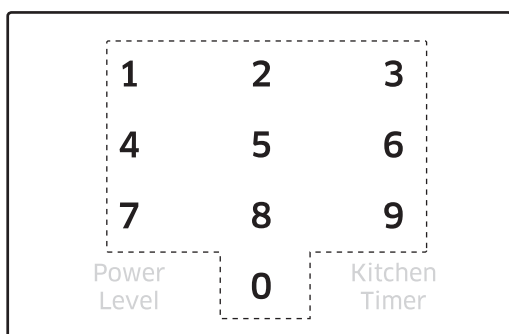

Use the number buttons to set the cooking time (max: 99 min 99 sec). The time area consists of the minute and second elements. To set a cooking time of 25 minutes, for example, press 2 and 5 for the minutes, then 0 and 0 for the seconds.

NOTE

- To change the cooking time during operation, press **STOP/CANCEL** twice, and then repeat the steps above.
- To stop cooking, simply open the door, or press **STOP/CANCEL**. To resume operation, close the door and press **START**.
- To cancel cooking, press **STOP/CANCEL** twice.

Time increment

You might want to add extra time to the current cooking time while cooking is in progress. Time can be added in 30 second intervals.

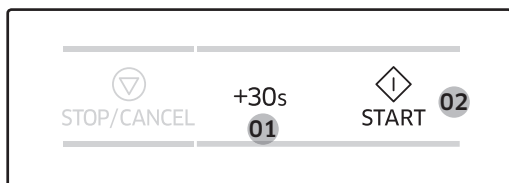

1. Before or during cooking, press **+30s** as many times as needed. For example, to add 2 minutes to the current cooking time, press the button 4 times.
2. Press **START**. The oven continues to operate for the changed time.

NOTE

This button is not enabled when you use Auto mode.

Operations

Power level

Select the cooking time, and then choose the power level before pressing the Start button.

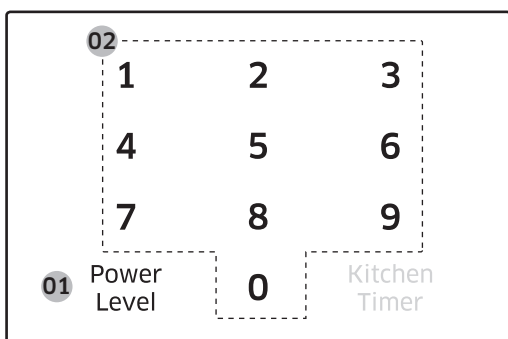

1. Press **Power Level**.
2. Use the number buttons to select a specific power level. Available levels range from No power (0) to High (10). See the table below.

0	PL:0	No power
1	PL:10	Warm
2	PL:20	Defrost
3	PL:30	Low
4	PL:40	Medium low
5	PL:50	Medium
6	PL:60	Simmer
7	PL:70	Medium high
8	PL:80	Reheat
9	PL:90	Sauté
10	PL:Hi	High

NOTE

To check the current power level while cooking is in progress, press **Power Level**.

Sensor mode

Sensor Cook

For inexperienced cooks, the oven offers a total of 9 Sensor Cook programs in 6 different categories. Take advantage of this feature to save time or shorten your learning curve. The cooking time and temperature will be adjusted according to the selected recipe.

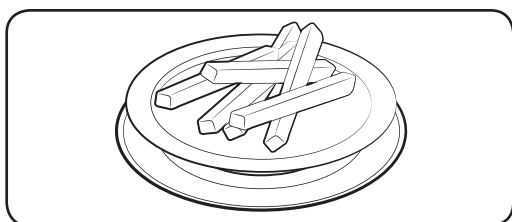

1. Put food in a microwave-safe container, and then put the container in the center of the turntable.

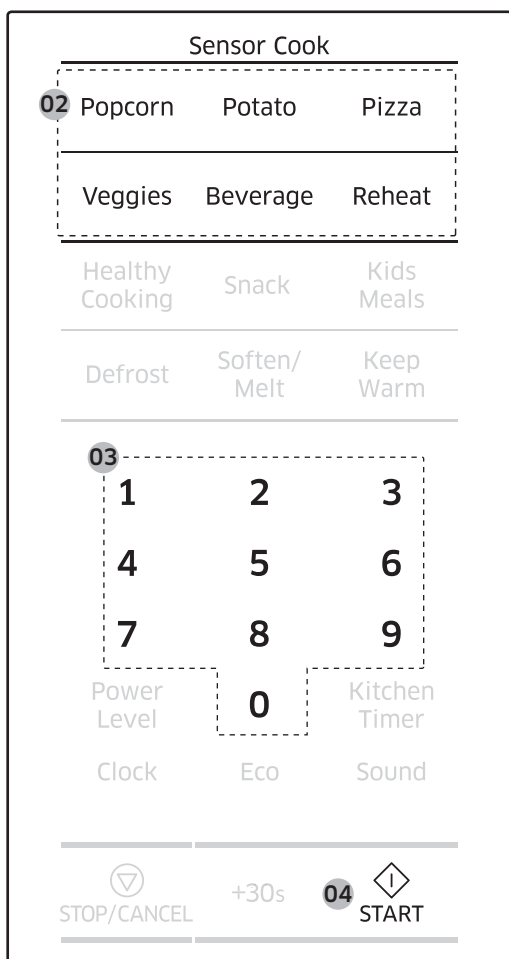

2. Select a category by pressing **Popcorn**, **Potato**, **Pizza**, **Veggies**, **Beverage**, or **Reheat**.
3. Press the selected button again or the number buttons to select a specific program.
4. Press **START**.
5. When cooking is complete, the oven beeps 4 times. Use oven gloves to take out the food.

Operations

Sensor cook guide

The following table presents auto programs for cooking, roasting, and baking. The table contains food quantities, weight ranges, and appropriate recommendations. Cooking modes and times have been pre-programmed for your convenience.

Code/Food		Serving Size	Instruction
1. Popcorn		3.0 to 3.5 oz. (1 package)	Use only one microwave popcorn bag at a time. Be careful when removing the heated bag from the oven and opening it. Let the oven cool for at least 5 minutes before using it again.
2. Potato		1 to 6 pcs	Pierce each potato several times with a fork. Place on the turntable in a spoke-like fashion. After cooking, let the potatoes stand for 3-5 minutes. Let the oven cool for at least 5 minutes before using it again.
3. Pizza		2 to 4 slices	Place 2-4 pizza slices on a microwave-safe plate with the wide ends of the slices towards the outside edge of the plate. Do not let the slices overlap. Do not cover. Let the oven cool for at least 5 minutes before using it again.
4. Veggies	1. Fresh Vegetables	1 to 4 servings	Place the food in a microwave-safe ceramic, glass, or plastic dish and add 2-4 tbs. water. Cover with vented plastic wrap, and then cook. Stir before letting stand. Let the oven cool for at least 5 minutes before using it again.
	2. Frozen Vegetables	1 to 4 servings	
5. Beverage		8 to 10 oz.	Use a measuring cup or mug and do not cover. Place the beverage in the oven. After heating, stir well. Let the oven cool for at least 5 minutes before using it again.

Code/Food		Serving Size	Instruction
6. Reheat	1. Dinner Plate	1 serving	Use only precooked, refrigerated foods. Cover the plate with vented plastic wrap or waxed paper tucked under the plate. If the food is not as hot as you would like after using the “Sensor” function, continue heating using additional time and power. Let the oven cool for at least 5 minutes before using it again. Contents: 3-4 oz. meat, poultry, or fish (up to 6 oz. with bone) ½ cup starch (potatoes, pasta, rice, etc.) ½ cup vegetables (about 3-4 oz.)
	2. Casserole	1 to 4 servings	Cover the plate with vented plastic wrap. If the food is not as hot as you would like after using the “Sensor Cook” function, continue heating using additional time and power. Stir the food once before serving. Let the oven cool for at least 5 minutes before using it again.
	3. Pasta/Soup	1 to 4 servings	Contents: Casseroles, soup, refrigerated foods.

Operations

Auto mode

Healthy Cooking

For healthier alternatives, the oven offers a total of 10 Healthy Cook programs. Take advantage of this feature to save time or shorten your learning curve. The cooking time and temperature will be adjusted according to the selected recipe.

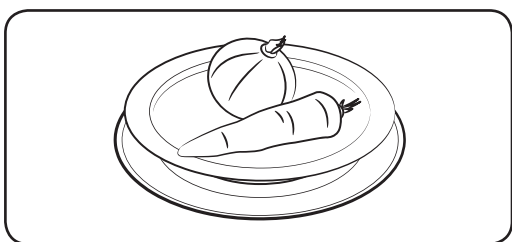

1. Put food in a microwave-safe container, and then put the container in the center of the turntable.

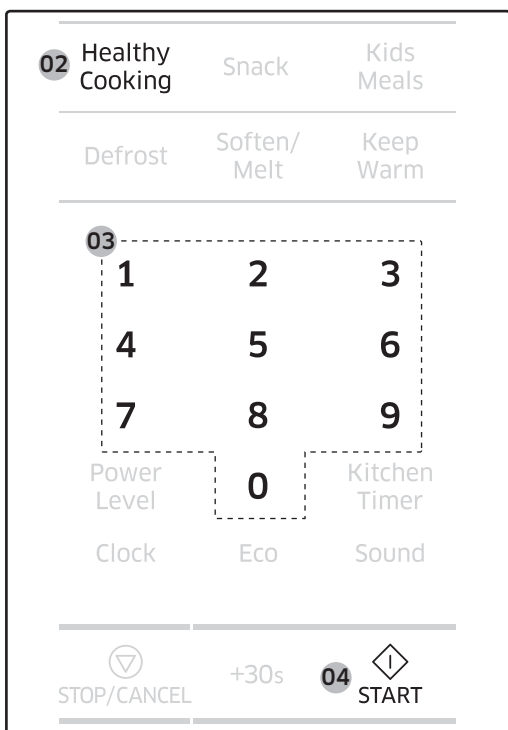

2. Press **Healthy Cooking**.
3. Press the Healthy Cooking button again or the number buttons to select a specific program.
4. Press **START**.
5. When cooking is complete, the oven beeps 4 times. Use oven gloves to take out the food.

Healthy Cooking guide

The following table lists auto programs for cooking. The table contains food quantities, weight ranges, and appropriate recommendations. Cooking modes and times have been pre-programmed for your convenience.

Code	Food	Serving Size	Instructions
1	Spinach	5.3 oz.	Rinse and clean spinach. Put into a glass bowl with lid. Do not add water. Put bowl in the center of turntable. Cook covered. Stir after cooking. Let stand for 1-2 minutes.
2	Squash	8.8 oz.	Slice the squash in half and remove the seeds. Place the squash cut side down in a microwave safe dish and cover with the plastic wrap. If needed, add a ¼ cup of water.
3	Brown Rice	16 oz.	Use a large glass ovenware dish with lid. Add a double quantity of cold water (500 ml). Cook covered. Stir before standing time and add salt and herbs. Let stand for 5-10 minutes.
4	Oatmeal	1 pack	Follow the package directions for the recommended amount of water needed. Stir well before and afterwards.
5	Quinoa	8.8 oz.	Use a large glass ovenware dish with lid. Add a double quantity of cold water (500 ml). Cook covered. Stir before standing time and add salt and herbs. Let stand for 1-3 minutes.
6	Green Beans	8.8 oz.	Rinse and clean green beans. Put them evenly into a glass bowl with lid. Add 30 ml (2 tbsp) water. Put bowl in the center of turntable. Cook covered. Stir after cooking. Let stand for 1-2 minutes.
7	Chicken Breasts	10.6 oz.	Rinse pieces and put on a ceramic plate. Cover with plastic wrap. Pierce the plastic wrap in 3 or 4 places. Put dish on turntable. Let stand for 2 minutes.

Operations

Code	Food	Serving Size	Instructions
8	Fresh Fish Fillet	10.6 oz.	Rinse fish fillets and put on a ceramic plate, add 1 tbsp lemon juice. Cover with plastic wrap. Pierce the plastic wrap in 3 or 4 places. Put dish on turntable. Let stand for 1-2 minutes.
9	Fresh Salmon Fillet	10.6 oz.	Rinse fish fillets and put on a ceramic plate, add 1 tbsp lemon juice. Cover with plastic wrap. Pierce the plastic wrap in 3 or 4 places. Put dish on turntable. Let stand for 1-2 minutes.
10	Fresh Prawns	8.8 oz.	Rinse prawns and put on a ceramic plate, add 1 tbsp lemon juice. Cover with plastic wrap. Pierce the plastic wrap in 3 or 4 places. Put dish on turntable. Let stand for 1-2 minutes.

Snack

The Snack feature has 5 pre-programmed cooking times. You do not need to set either cooking times or the power level.

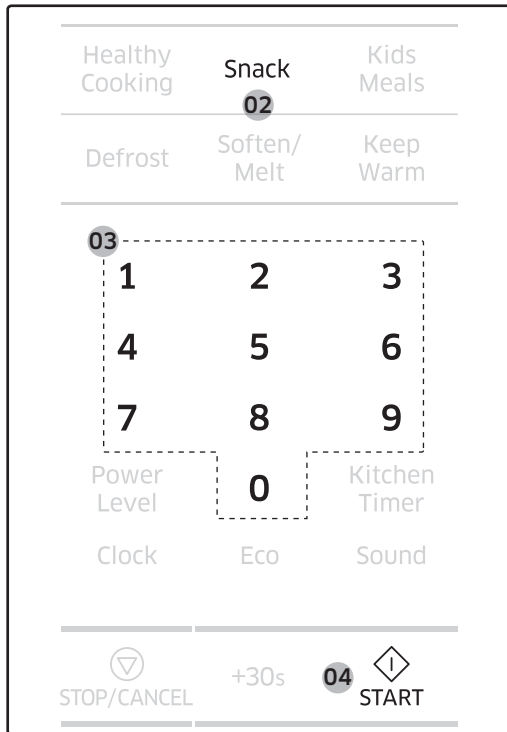

1. Put food in the center of the turntable, and then close the door.
2. Press **Snack**.
3. Press the Snack button again or the number buttons to select a specific program.
4. Press **START**.
5. When the cycle is complete, the oven beeps 4 times. Use oven gloves to take out the food.

Operations

Snack guide

The following table lists auto programs for heating snack foods. The table contains food quantities, weight ranges, and appropriate recommendations.

Code	Food	Serving Size	Instruction
1	Bacon	4 slices	Layer 2 paper towels on microwave safe plate and arrange the bacon on the towels. Do not overlap bacon. Cover with an additional paper towel. Remove the paper towel immediately after cooking.
2	Frozen Cheese Sticks	5-6 pcs	Place the cheese sticks on a plate in a spoke-like fashion. Do not cover. Let stand for 1 to 2 minutes after heating.
3	Frozen Chicken Wings	7-8 oz.	Use precooked, refrigerated chicken wings. Place the chicken wings around the plate in a spoke-like fashion and cover with wax paper. Let stand for 1 to 2 minutes.
4	Nachos	1 serving	Place the nachos on a plate without letting them overlap. Sprinkle cheese evenly over them. Contents: 2 cups tortilla chips 1/3 cup grated cheese
5	Potato Skins	2 (cooked) potatoes	Cut the cooked potato into 4 even wedges. Scoop or cut out the potato flesh, leaving about a ¼ in. flesh on the skin. Place the skins in a spoke-like fashion around the plate. Sprinkle with bacon, onions and cheese. Do not cover. Let stand for 1 to 2 minutes.

Kids Meals

Kids meals feature has 4 pre-programmed cooking times. You do not need to set either cooking times or the power level.

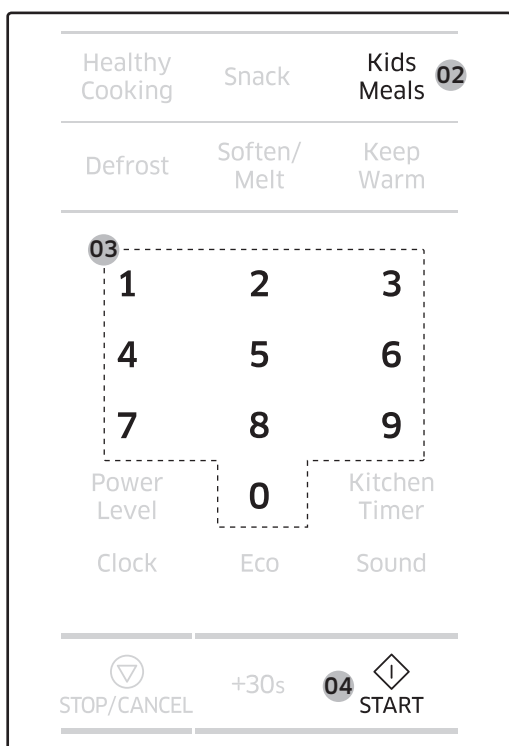
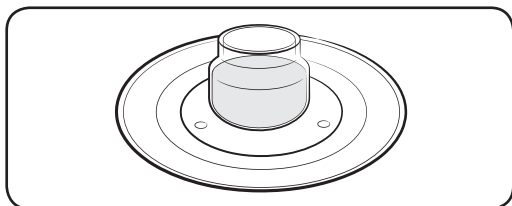

1. Put food in the center of the turntable.

2. Press **Kids Meals**.

3. Press the Kids Meals or number buttons to select a specific program.

4. Press **START**.

5. When cooking is complete, the oven beeps 4 times. Use oven gloves to take out the food.

CAUTION

Before inserting food in the oven, remove any metal or plastic cover or lid from the food.

Operations

Kids meals guide

Code	Food	Serving Size	Instructions
1	Frozen Chicken Nuggets	1 serving	Place a paper towel on a plate and arrange the nuggets in a spoke-like fashion on the paper towel. Do not cover. Let stand for 1 minute after heating. Refer to the package directions for the serving size and the amount of food.
2	Frozen French Fries	1 serving	Place two paper towels on a microwave safe plate and arrange the French fries on the towels without letting them overlap. Blot the fries with additional paper towels after removing from the oven. Let stand for 1 minute. Refer to the directions on the packaging for the serving size and the amount of food.
3	Frozen Sandwich	1 serving (1 sandwich)	Place the frozen sandwich in a susceptor "crisping sleeve" (which is in the package) and place on a microwave safe plate. Remove from the "crisping sleeve". Let stand for 2 minutes after heating.
4	Hot Dogs	1 serving (2 hot dogs)	Pierce the hot dogs and place them on a plate. When the oven beeps, remove the hot dogs from the oven, put each hot dog in a bun, place the buns and hot dogs in the oven, and then restart the oven. Let stand for 1 minute after heating. For the best texture, the buns should be added to the hot dogs when the oven beeps.

Convenience

Defrost

This is useful to defrost frozen meat, poultry, fish, or bread. The operating time and power level will be adjusted according to the selected program.

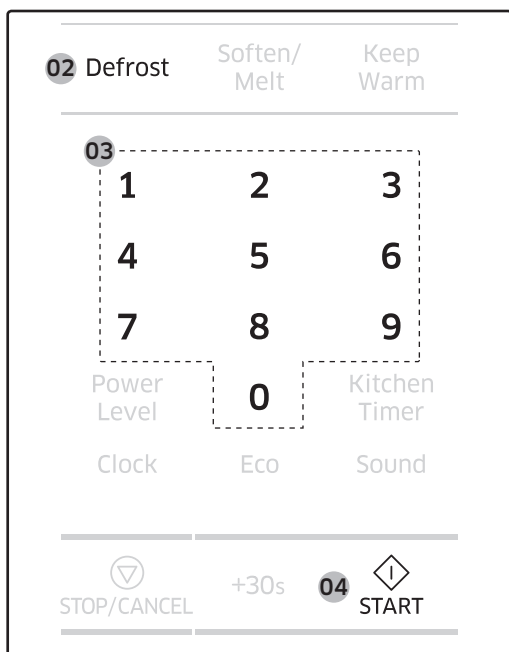

1. Put food in the center of the turntable, and then close the door.
2. Press **Defrost** to select a category.
3. Use the number buttons to select a weight.
4. Press **START**.
5. When the cycle is complete, the oven beeps 4 times. Use oven gloves to take out the food.

NOTE

- The oven beeps in the middle of the cycle to remind you to turn the food over. Turn the food over, and then press Start again to continue. When the cycle is complete, the oven beeps 4 times.
- You can defrost food manually. To do this, set a time, press the **2** button (20 % power), and then press **START**. For more information, see the Power level section on page 30.

Operations

Defrost guide

The following table lists auto programs for defrosting food. The table contains food quantities, weight ranges, and appropriate recommendations.

Code	Food	Serving Size (lb)	Instructions
1	Meat	0.1-3.5	Shield the edges with aluminium foil. Turn the meat over when the oven beeps. This program is suitable for beef, lamb, pork, steaks, chops, minced meat. Let stand for 10-30 minutes.
2	Poultry	0.1-3.5	This program is suitable for whole chicken as well as for chicken pieces. Before defrosting, if there are a large number of ice crystals on the surface of the poultry, rinse the surface with cold water until all the ice crystals are removed. The poultry should then be left to stand for 5 to 10 min. at room temperature. Shield the leg and wing tips with aluminum foil. Place chicken pieces skin-side down, and whole chicken breast-side down on the middle of a flat microwave-safe plate. Turn the poultry over when the oven beeps
3	Fish	0.1-3.5	Shield the tail of a whole fish with aluminium foil. Turn the fish over, when the oven beeps. This program is suitable for whole fish as well as for fish fillets. Let stand for 10-30 minutes.
4	Bread	0.1-3.5	Put bread on a piece of kitchen paper and turn over as soon as the oven beeps. Place cake on a ceramic plate and, if possible, turn over, as soon as the oven beeps. (The oven keeps operating and stops when you open the door.) This program is also suitable for all kinds of bread, sliced or whole, as well as for bread rolls and baguettes. Arrange bread rolls in a circle. In addition, this program is suitable for all kinds of yeast cakes, biscuits, cheese cakes, and puff pastry. It is not suitable for short/crust pastry, fruit and cream or for cakes with chocolate topping. Let stand for 5-30 minutes.

Soften/Melt

This is useful to soften or melt soft food or confections such as butter, chocolate, and sugar.

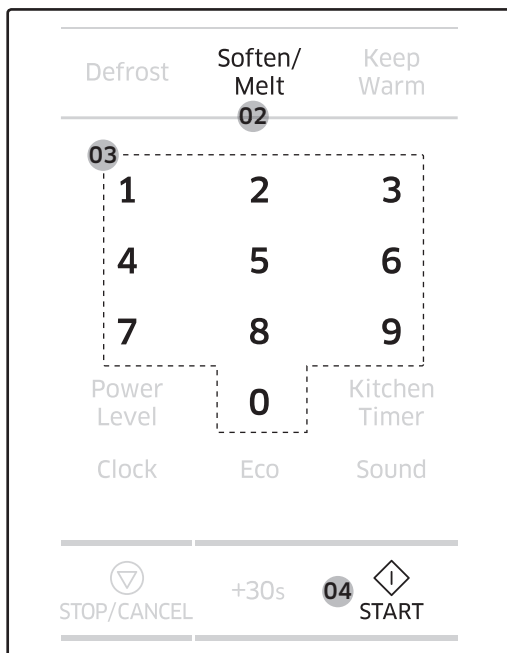

1. Put food in the center of the turntable.
2. Press **Soften/Melt**.
3. Press the Soften/Melt button again or the number buttons to select a specific program.
4. Press **START**.
5. When the cycle is complete, the oven beeps 4 times. Use oven gloves to take out the food.

Operations

Soften/Melt guide

The following table lists auto programs for softening or melting specific kinds of food. The table contains food quantities, weight ranges, and appropriate recommendations.

Code	Food	Serving Size (g)	Instructions
1	Melting Butter	50 (1.75 oz)	Cut butter into 3 or 4 pieces, and then put them in a small glass bowl. Melt uncovered. Stir after cooking. Let stand for 1-2 minutes.
2	Melting Butter	100 (3.5 oz)	
3	Melting Dark Chocolate	50 (1.75 oz)	Grate dark chocolate, and then put in a small glass bowl. Melt uncovered. Stir after melting. Let stand for 1-2 minutes.
4	Melting Dark Chocolate	100 (3.5 oz)	
5	Melting Sugar	25 (1 oz)	Put sugar in a small glass bowl. Add 10 ml (2 tsp) water for 25 g (1 oz). Add 20 ml water for 50 g (1.75 oz). Melt uncovered. Take out carefully using oven gloves! Use spoon or fork and pour caramel decorations on baking paper. Let stand for 10 minutes until dry, and then remove from paper.
6	Melting Sugar	50 (1.75 oz)	
7	Soften Butter	50 (1.75 oz)	Cut butter into 3 or 4 pieces, and then put them in small glass bowl. Soften uncovered. Let stand for 1-2 minutes.
8	Soften Butter	100 (3.5 oz)	

Keep Warm

If you want to keep cooked foods warm until serving, use this function. The operating time and power level will be adjusted according to the selected program.

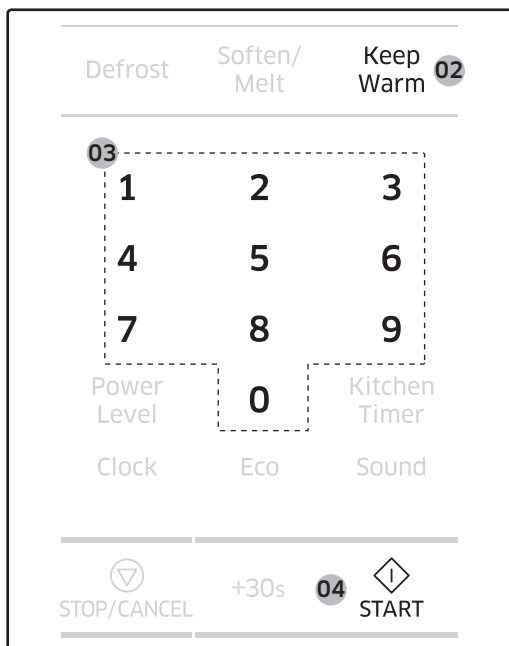

1. Put food in the center of the turntable, and then close the door.
2. Press **Keep Warm**. The default time is 99 minutes.
3. Use the number buttons to set the warming time (max: 99 min 99 sec.).
4. Press **START**.
5. When the cycle is complete, the oven beeps 4 times. Use oven gloves to take out the food.

⚠ CAUTION

- Do not use this function to reheat cold food. Use this only for keeping food that has just been cooked warm.
- Do not keep food for more than 1 hour. The food surface may dry up.
- Do not put food covered with lids or plastic wrap in the oven.

Cooking Smart

We provide these cooking guides to help you make the most out of this oven. Experience our cooking know-how to add convenience and richness to your life.

Microwave cooking guide

- Cover the food for the entire time it is cooking. The vaporised moisture from the food cycles through inside and helps cook the food evenly.
- When cooking is complete, let stand for the specified time. This allows the food to cook evenly throughout.
- Use only microwave-safe cookware.

Frozen vegetables

- Use a suitable glass Pyrex container with a lid.
- Stir twice during cooking and once after cooking, and then add the seasoning of your preference.

Food	Serving Size (g)	Power	Time (min.)
Spinach	150 (5.3 oz)	60 %	5-6
	Add 15 ml (1 tbsp) cold water. Let stand for 2-3 minutes.		
Broccoli	300 (10.6 oz)	60 %	8-9
	Add 30 ml (2 tbsp) cold water. Let stand for 2-3 minutes.		
Peas	300 (10.6 oz)	60 %	7-8
	Add 15 ml (1 tbsp) cold water. Let stand for 2-3 minutes.		
Green Beans	300 (10.6 oz)	60 %	7½-8½
	Add 30 ml (2 tbsp) cold water. Let stand for 2-3 minutes.		
Mixed Vegetables (Carrots/Peas/Corn)	300 (10.6 oz)	60 %	7-8
	Add 15 ml (1 tbsp) cold water. Let stand for 2-3 minutes.		
Mixed Vegetables (Chinese style)	300 (10.6 oz)	60 %	7½-8½
	Add 15 ml (1 tbsp) cold water. Let stand for 2-3 minutes.		

Fresh vegetables

- Use a suitable glass Pyrex container with a lid.
- Cut ingredients into as small pieces as possible to reduce the cooking time.
- Add 2-3 tbls (30-45 ml) of cold water to every 250 g (9 oz) unless otherwise specified.
- Stir once during cooking and once after cooking, and then add seasoning to your preference.

Food	Serving Size (g)	Power	Time (min.)
Broccoli	250 (9 oz) 500 (17.6 oz)	90 %	4½-5 7-8
	Prepare even sized florets. Arrange the stems to the center. Let stand for 3 minutes.		
Brussels Sprouts	250 (9 oz)	90 %	6-6½
	Add 60-75 ml (4-5 tbsp) water. Let stand for 3 minutes.		
Carrots	250 (9 oz)	90 %	4½-5
	Cut carrots into even sized slices. Let stand for 3 minutes.		
Cauliflower	250 (9 oz) 500 (17.6 oz)	90 %	5-5½ 7½-8½
	Prepare even sized florets. Cut big florets into halves. Arrange stems to the center. Let stand for 3 minutes.		
Courgettes (Zucchini)	250 (9 oz)	90 %	4-4½
	Cut courgettes into slices. Add 30 ml (2 tbsp) water or a pat of butter. Cook until just tender. Let stand for 3 minutes.		
Eggplant	250 (9 oz)	90 %	3½-4
	Cut eggplants into small slices and sprinkle with 1 tbsp lemon juice. Let stand for 3 minutes.		
Leeks	250 (9 oz)	90 %	4-4½
	Cut leeks into thick slices. Let stand for 3 minutes.		
Mushrooms	125 (4.5 oz) 250 (9 oz)	90 %	1½-2 2½-3
	Prepare small whole or sliced mushrooms. Do not add any water. Sprinkle with lemon juice. Spice with salt and pepper. Drain before serving. Let stand for 3 minutes.		

Cooking Smart

Food	Serving Size (g)	Power	Time (min.)
Onions	250 (9 oz)	90 %	5-5½
	Cut onions into slices or halves. Add only 15 ml (1 tbsp) water. Let stand for 3 minutes.		
Pepper	250 (9 oz)	90 %	4½-5
	Cut pepper into small slices. Let stand for 3 minutes.		
Potatoes	250 (9 oz) 500 (17.6 oz)	90 %	4-5 7-8
	Weigh the peeled potatoes and cut them into similar sized halves or quarters. Let stand for 3 minutes.		
Turnip Cabbage	250 (9 oz)	90 %	5½-6
	Cut turnip cabbage into small cubes. Let stand for 3 minutes.		

Rice and pasta

Rice

- Use a large-sized glass Pyrex container with a lid. Note that rice doubles in volume during cooking.

Pasta

- Use a large-sized glass Pyrex container. Cook uncovered.
- Add boiling water and a little salt, and stir well. Stir several times during and after cooking.
- Cover with a lid while letting stand, and then drain well.

Food	Serving Size	Power	Time (min.)
White Rice (Parboiled)	250 g (9 oz) 375 g (13.25 oz)	90 %	15-16 17½-18½
	Add 500 ml (2 cups) cold water for 250 g. Add 750 ml (3.125 cups) cold water for 375 g. Let stand for 5 minutes.		
Brown Rice (Parboiled)	250 g (9 oz) 375 g (13.25 oz)	90 %	20-21 22-23
	Add 500 ml (2 cups) cold water for 250 g. Add 750 ml (3.125 cups) water for 375 g. Let stand for 5 minutes.		
Mixed Rice (Rice + Wild Rice)	250 g (9 oz)	90 %	16-17
	Add 500 ml (2 cups) cold water. Let stand for 5 minutes.		

Food	Serving Size	Power	Time (min.)
Mixed Corn (Rice + Grain)	250 g (9 oz)	90 %	17-18
	Add 400 ml (1.66 cups) cold water. Let stand for 5 minutes.		
Pasta	250 g (9 oz)	90 %	10-11
	Add 1000 ml (4 cups) hot water. Let stand for 5 minutes.		

Reheating guide

General

This reheating guide is based on the following standards: That the temperature of liquid at room temperature is between 64.4 °F and 68 °F (18 °C and 20 °C) and that the temperature of chilled food is between 41 °F and 44.6 °F (5 °C and 7 °C). Follow the operating time, power level, and standing times specified in this table.

Food	Serving Size	Power	Time (min.)
Drinks (Coffee, Tea and Water)	150 ml (1 cup)	90 %	1-1½
	300 ml (2 cups)		2-2½
450 ml (3 cups)	3-3½		
600 ml (4 cups)	3½-4		
Pour into cups and reheat uncovered: 1 cup in the center, 2 cups opposite of each other, 3 cups in a circle. Keep in microwave oven during standing time and stir well. Let stand for 1-2 minutes.			
Soup (Chilled)	250 g (9 oz)	90 %	2½-3
	350 g (12.3 oz)		3-3½
	450 g (15.87 oz)		3½-4
	550 g (1.2 lb)		4½-5
Pour into a deep ceramic plate or deep ceramic bowl. Cover with plastic lid. Stir well after reheating. Stir again before serving. Let stand for 2-3 minutes.			
Stew (Chilled)	350 g (12.3 oz)	60 %	4½-5½
	Put stew in a deep ceramic plate. Cover with plastic lid. Stir occasionally during reheating and again before standing and serving. Let stand for 2-3 minutes.		

Cooking Smart

Food	Serving Size	Power	Time (min.)
Pasta with Sauce (Chilled)	350 g (12.3 oz)	60 %	3½-4½
	Put pasta (e.g. spaghetti or egg noodles) on a flat ceramic plate. Cover with microwave cling film. Stir before serving. Let stand for 3 minutes.		
Filled Pasta with Sauce (Chilled)	350 g (12.3 oz)	60 %	4-5
	Put filled pasta (e.g. ravioli, tortellini) in a deep ceramic plate. Cover with plastic lid. Stir occasionally during reheating and again before standing and serving. Let stand for 3 minutes.		
Plated Meal (Chilled)	350 g (12.3 oz)	60 %	4½-5
	450 g (15.87 oz)		5½-6½
Put a meal of 2-3 chilled components on a ceramic dish. Cover with plastic cling-film. Let stand for 3 minutes.			
Cheese Fondue Ready-to-Serve (Chilled)	400 g (14 oz)	60 %	6-7
	Put the ready-to-serve cheese fondue in a suitable sized glass pyrex bowl with lid. Stir occasionally during and after reheating. Stir well before serving. Let stand for 1-2 minutes.		

Special care for baby food

To prevent accidents such as burns, special care must be taken with baby food before serving. Make sure to strictly follow this reheating guide for baby food.

Baby food

- Use a deep ceramic plate and cover it with a plastic lid.
- Recommended serving temperature is 86-104 °F (30-40 °C).

Baby milk

- Use a sterilised glass bottle and reheat it uncovered.
- Remove the nipple before reheating. Otherwise, the milk in the bottle can boil over.

Food	Serving Size	Power	Time (sec.)
Baby Food (Vegetables + Meat)	6.7 oz (190 g)	60 %	30
	Empty into ceramic deep plate. Cook covered. Stir after cooking time. Before serving, stir well and check the temperature carefully. Let stand for 2-3 minutes.		

Food	Serving Size	Power	Time (sec.)
Baby Porridge (Grain + Milk + Fruit)	6.7 oz (190 g)	60 %	20
	Empty into ceramic deep plate. Cook covered. Stir after cooking time. Before serving, stir well and check the temperature carefully. Let stand for 2-3 minutes.		
Baby Milk	3.4 oz (100 ml)	30 %	30-40
	6.7 oz (200 ml)		60-70
Stir or shake well and pour into a sterilised glass bottle. Place in the center of turn-table. Cook uncovered. Shake well and let stand for at least 3 minutes. Before serving, shake well and check the temperature carefully.			

Defrosting guide

This defrosting guide is based on the following standard: That frozen food has an internal temperature between 0 °F and -4 °F (-18 °C and -20 °C). The standing time varies depending on the food type (meat or vegetables) and serving size (thinner or thicker pieces of food).

- Put frozen food in a microwave-safe container uncovered.
- Turn it over halfway through defrosting time and drain well when complete.

Food		Serving Size	Power	Time (min.)
Meat	Minced (Ground) Meat	250 g (9 oz)	20 %	6-7
		500 g (1.1 lb)		8-13
	Pork Steaks	250 g (9 oz)		7-8
Place the meat on turntable. Shield thinner edges with aluminium foil. Turn over after half of defrosting time! Let stand for 15-30 minutes.				
Poultry	Chicken Pieces	500 g (1.1 lb) (2 pcs)	20 %	14-15
	Whole Chicken	1200 g (2.65 lb)		32-34
	First, put chicken pieces skin-side down, whole chicken breast-side-down on a flat ceramic plate. Shield the thinner parts like wings and ends with aluminium foil. Turn over after half of defrosting time! Let stand for 15-60 minutes.			

Cooking Smart

Food		Serving Size	Power	Time (min.)
Fish	Fish Fillets	250 g (7 oz)	20 %	6-7
	Whole Fish	400 g (14 oz)		11-13
Put frozen fish in the middle of a flat ceramic plate. Arrange the thinner parts under the thicker parts. Shield narrow ends of fillets and tail of whole fish with aluminium foil. Turn over after half of defrosting time! Let stand for 10-25 minutes.				
Fruit	Berries	300 g (10.6 oz)	20 %	6-7
	Spread fruit on a flat, round glass dish (with a large diameter). Let stand for 5-10 minutes.			
Bread	Bread Rolls (Each ca. 50 g)	2 pcs 4 pcs	20 %	1-1½ 2½-3
	Toast/Sandwich	250 g (9 oz)		4-4½
	German Bread (Wheat + Rye Flour)	500 g (1.1 lb)		7 - 9
	Arrange rolls in a circle or bread horizontally on kitchen paper in the middle of turntable. Turn over after half of defrosting time! Let stand for 5-20 minutes.			

Quick & easy

Melting crystallized honey

Put 7 oz (20 g) crystallized honey into a small deep glass dish.

Heat for 20-30 seconds using 30 %, until honey is melted.

Melting gelatine

Put dry gelatine sheets (10 g/3.5 oz) into cold water for 5 minutes.

Put drained gelatine into a small glass pyrex bowl.

Heat for 1 minute using 30 %.

Stir after melting.

Cooking glaze/icing (for cake and gateaux)

Mix instant glaze (approximately 14 g/5 oz) with 40 g (1.5 oz) sugar and 250 ml (8.5 oz) cold water.

Cook uncovered in a glass pyrex bowl for 3½ to 4½ minutes using 90 %, until glaze/icing is transparent. Stir twice during cooking.

Cooking jam

Put 600 g (1.3 lb) fruit (for example mixed berries) in a suitably sized glass pyrex bowl with lid. Add 300 g (10.5 oz) preserving sugar and stir well.

Cook covered for 10-12 minutes using 90 %.

Stir several times during cooking. Empty directly into small jam glasses with twist-off lids. Let stand for 5 minutes.

Cooking pudding/ custard

Mix pudding powder with sugar and milk (500 ml/2 cups) by following the manufacturers instructions and stir well. Use a suitably sized glass pyrex bowl with lid. Cook covered for 6½ to 7½ minutes using 90 %.

Stir well several times during cooking.

Browning almond slices

Spread 30 g (1 oz) sliced almonds evenly on a medium sized ceramic plate.

Stir several times during browning for 3½ to 4½ minutes using 60 %.

Let stand for 2-3 minutes in the oven. Use oven gloves while taking out!

Troubleshooting

If you encounter a problem with your oven, first check the tables starting below and try the suggestions. If a problem persists, or if an information code keeps appearing on the display, contact a local Samsung service center.

Checkpoints

If you encounter a problem with the oven, first check the tables below and try the suggestions.

Problem	Cause	Action
General		
The buttons cannot be pressed properly.	Foreign matter may be caught between the buttons.	Remove the foreign matter and try again.
	For touch models: Moisture is on the exterior.	Wipe the moisture from the exterior.
	Child lock is activated.	Deactivate Child lock.
The time is not displayed.	Power is not supplied.	Make sure power is supplied. Confirm the microwave is plugged in. Check your fuses or circuit breakers.
	The Eco (power-saving) function is set.	Turn off the Eco function.
The oven does not work.	Power is not supplied.	Make sure power is supplied. Confirm the microwave is plugged in. Check your fuses or circuit breakers.
	The door is open.	Close the door and try again.
	The door open safety mechanisms are covered in foreign matter.	Remove the foreign matter and try again.
The oven stops while in operation.	The user has opened the door to turn food over.	After turning over the food, press the Start button again to start operation.

Problem	Cause	Action
The power turns off during operation.	The oven has been cooking for an extended period of time.	After cooking for an extended period of time, let the oven cool.
	The cooling fan is not working.	Listen for the sound of the cooling fan.
	Trying to operate the oven without food inside.	Put food in the oven.
	There is not enough ventilation space around the oven.	There are intake/exhaust outlets on the front and rear of the oven for ventilation. Check the installation guide and make sure that the microwave is far enough away from walls and cabinets for proper ventilation.
	Several appliances or devices are plugged into the same outlet.	Unplug all other appliances or devices from the outlet.
There is no power to the oven.	Power is not supplied.	Make sure power is supplied. Confirm the microwave is plugged in. Check your fuses or circuit breakers.
There is a popping sound during operation, and the oven doesn't work.	Cooking sealed food or using a container with a lid may causes popping sounds.	Do not use sealed containers as they may burst during cooking due to expansion of the contents.
The oven exterior gets too hot during operation.	There is not enough ventilation space around the oven.	There are intake/exhaust outlets on the front and rear of the oven for ventilation. Check the installation guide and make sure that the microwave is far enough away from walls and cabinets for proper ventilation.
	Objects are on top of the oven.	Remove all objects on the top of the oven.
The door cannot be opened properly.	Food residue is stuck between the door and oven interior.	Clean the oven and then open the door.

Troubleshooting

Problem	Cause	Action
The oven does not heat.	The oven may not work, too much food is being cooked, or improper cookware is being used.	To test the oven, put one cup of water in a microwave-safe container, put the container in the oven, and then run the microwave for 1-2 minutes to check whether the water is heated. If the water is heated, reduce the amount of food and start the function again. Use a cooking container with a flat bottom.
Heating is weak or slow.	The oven may not work, too much food is being cooked, or improper cookware is being used.	To test the oven, put one cup of water in a microwave-safe container, put the container in the oven, and then run the microwave for 1-2 minutes to check whether the water is heated. If the water is heated, reduce the amount of food and start the function again. Use a cooking container with a flat bottom.
The warm function does not work.	The oven may not work, too much food is being cooked, or improper cookware is being used.	To test the oven, put one cup of water in a microwave-safe container, put the container in the oven, and then run the microwave for 1-2 minutes to check whether the water is heated. If the water is heated, reduce the amount of food and start the function again. Use a cooking container with a flat bottom.

Problem	Cause	Action
The thaw function does not work.	The oven may not work, too much food is being cooked, or improper cookware is being used.	To test the oven, put one cup of water in a microwave-safe container, put the container in the oven, and then run the microwave for 1-2 minutes to check whether the water is heated. If the water is heated, reduce the amount of food and start the function again. Use a cooking container with a flat bottom.
The interior light is dim or does not turn on.	The door has been left open for a long time.	The interior light may automatically turn off when the Eco function operates. Close and reopen the door or press the "Cancel" button.
	The interior light is covered by foreign matter.	Clean the inside of the oven and check again.
A beeping sound occurs during cooking.	If the Auto Cook function is being used, this beeping sound means it's time to turn over the food during thawing.	After turning over the food, press the Start button again to restart operation.
The oven is not level.	The oven is installed on an uneven surface.	Make sure the oven is installed on flat, stable surface.
There are sparks during cooking.	Metal containers are used during the oven/thawing functions.	Do not use metal containers.
When power is connected, the oven immediately starts to work.	The door is not properly closed.	Close the door and check again.
There is electricity coming from the oven.	The power or power socket is not properly grounded.	Make sure the power and power socket are properly grounded.
There is water dripping.	Water or steam may be generated by the cooking or defrosting process, depending on the food. This is not an oven malfunction.	Let the oven cool and then wipe with a dry dish towel.

Troubleshooting

Problem	Cause	Action
Steam leaks from the door.	Water or steam may be generated by the cooking or defrosting process, depending on the food. This is not an oven malfunction.	Let the oven cool and then wipe with a dry dish towel.
There is water left in the oven.	Water or steam may be generated by the cooking or defrosting process, depending on the food. This is not an oven malfunction.	Let the oven cool and then wipe with a dry dish towel.
The brightness inside the oven varies.	Changes in brightness reflect changes in power output. Power output changes depending on the functions in use.	Power output changes during cooking are not malfunctions.
Cooking is finished, but the cooling fan is still running.	To ventilate the oven, the cooling fan continues to run for about 5 minutes after cooking is complete.	This is not an oven malfunction.
Pressing the +30sec button operates the oven.	This happens when the oven was not operating.	The microwave oven is designed to start operating when you press the +30 sec button if it was not operating.
Turntable		
While turning, the turntable comes out of place or stops turning.	There is no roller ring, or the roller ring is not properly in place.	Install the roller ring and then try again.
The turn table drags while turning.	The roller ring is not properly in place, there is too much food, or the container is too large and touches the inside of the microwave.	Adjust the amount of food and do not use containers that are too large.
The turn table rattles while turning and is noisy.	Food residue is stuck to the bottom of the oven.	Remove any food residue stuck to the bottom of the oven.

NOTE

If the above guidelines do not enable you to solve the problem, then contact your local SAMSUNG customer service center.

Please have the following information ready:

- The model and serial numbers, normally printed on the rear of the oven
- Your warranty details
- A clear description of the problem

Information code

Code	Description	Action
C-d0	Control buttons are pressed over 10 seconds.	Clean the keys and check if there is water on the surface around the keys. If this occurs again, turn off the microwave oven for more than 30 seconds, and then try setting again. If this code appears again, call your local Samsung service center.
C-10	The GAS Sensor is open.	Unplug the power cord of the oven, and then contact a local Samsung service center.
	The GAS Sensor is shorted.	

NOTE

If the suggested solution does not solve the problem, contact your local SAMSUNG Service Center.

Technical specifications

SAMSUNG strives to improve its products at all times. Both the design specifications and these user instructions are consequently subject to change without notice.

Model		MS14K6000**
Power Source		120 V ~ 60 Hz
Power Consumption		1600 W
Output Power		100 W / 1000 W (IEC - 705)
Operating Frequency		2450 MHz
Magnetron		OM75P (31)
Cooling Method		Cooling fan motor
Dimensions (W x H x D)	Main unit	21 ²⁷ / ₃₂ X 12 ⁴¹ / ₁₂₈ X 18 ⁵ / ₈ (in)
	Cooking chamber	14 ⁴⁹ / ₆₄ X 9 ¹³ / ₁₆ X 16 ¹ / ₁₆ (in)
Volume		1.4 cu.ft
Weight	Net	37.5 lbs.

Warranty

Samsung microwave oven

Limited warranty to original purchaser

This SAMSUNG brand product, as supplied and distributed by Samsung Electronics AMERICA, Inc. (SAMSUNG) and delivered new, in the original carton to the original consumer purchaser, is warranted by SAMSUNG against manufacturing defects in materials and workmanship for a limited warranty period of:

ONE (1) YEAR PARTS AND LABOR, TEN (10) YEARS PARTS WARRANTY FOR MAGNETRON

Samsung will charge a repair fee for replacing an accessory or repairing a cosmetic defect if the damage to the unit and/or damage to or loss of the accessory was caused by the customer. Items this stipulation covers include:

- A Dented, Scratched, or Broken Door, Handle, Out-Panel, or Control Panel
- A Broken or missing Tray, Guide Roller, Coupler, Filter, or Wire Rack

User Replaceable Parts may be sent to the customer for unit repair. If necessary, a Service Engineer can be dispatched to perform service.

This limited warranty begins on the original date of purchase, and is valid only on products purchased and used in the United States. To receive warranty service, the purchaser must contact SAMSUNG for problem determination and service procedures. Warranty service can only be performed by a SAMSUNG authorized service center. The original dated bill of sale must be presented upon request as proof of purchase to SAMSUNG or SAMSUNG's authorized service center.

SAMSUNG will repair this product or replace it if cannot repair it, at our option and at no charge as stipulated herein, with new or reconditioned parts or products if found to be defective during the limited warranty period specified above. All replaced parts and products become the property of SAMSUNG and must be returned to SAMSUNG. Replacement parts and products assume the remaining original warranty, or ninety (90) days, whichever is longer.

Warranty

In-home service will be provided during the warranty labor period subject to availability within the contiguous United States. In-home service is not available in all areas. To receive in-home service, the product must be unobstructed and accessible to service personnel. If during in-home service repair can not be completed, it may be necessary to remove, repair and return the product. If in-home service is unavailable, SAMSUNG may elect, at our option, to provide for transportation of our choice to and from a SAMSUNG authorized service center. Otherwise, transportation to and from the SAMSUNG authorized service center is the responsibility of the purchaser.

This limited warranty covers manufacturing defects in materials and workmanship encountered in normal, noncommercial use of this product and shall not apply to the following, including, but not limited to: damage which occurs in shipment; delivery and installation; applications and uses for which this product was not intended; altered product or serial numbers; cosmetic damage or exterior finish; accidents, abuse, neglect, fire, water, lightning or other acts of nature; use of products, equipment, systems, utilities, services, parts, supplies, accessories, applications, installations, repairs, external wiring or connectors not supplied or authorized by SAMSUNG which damage this product or result in service problems; incorrect electrical line voltage, fluctuations and surges; customer adjustments and failure to follow operating instructions, cleaning, maintenance and environmental instructions that are covered and prescribed in the instruction book; problems caused by pest infestations, and overheating or overcooking by user; glass tray or turntable; reduced magnetron power output related to normal aging. SAMSUNG does not warrant uninterrupted or error-free operation of the product.

THERE ARE NO EXPRESS WARRANTIES OTHER THAN THOSE LISTED AND DESCRIBED ABOVE, AND NO WARRANTIES WHETHER EXPRESS OR IMPLIED, INCLUDING, BUT NOT LIMITED TO, ANY IMPLIED WARRANTIES OF MERCHANTABILITY OR FITNESS FOR A PARTICULAR PURPOSE, SHALL APPLY AFTER THE EXPRESS WARRANTY PERIODS STATED ABOVE, AND NO OTHER EXPRESS WARRANTY OR GUARANTY GIVEN BY ANY PERSON, FIRM OR CORPORATION WITH RESPECT TO THIS PRODUCT SHALL BE BINDING ON SAMSUNG. SAMSUNG SHALL NOT BE LIABLE FOR LOSS OF REVENUE OR PROFITS, FAILURE TO REALIZE SAVINGS OR OTHER BENEFITS, OR ANY OTHER SPECIAL, INCIDENTAL OR CONSEQUENTIAL DAMAGES CAUSED BY THE USE, MISUSE OR INABILITY TO USE THIS PRODUCT, REGARDLESS OF THE LEGAL THEORY ON WHICH THE CLAIM IS BASED, AND EVEN IF SAMSUNG HAS BEEN ADVISED OF THE POSSIBILITY OF SUCH DAMAGES. NOR SHALL RECOVERY OF ANY KIND AGAINST SAMSUNG BE GREATER IN AMOUNT THAN THE PURCHASE PRICE OF THE PRODUCT SOLD BY SAMSUNG AND CAUSING THE ALLEGED DAMAGE. WITHOUT LIMITING THE FOREGOING, PURCHASER ASSUMES ALL RISK AND LIABILITY FOR LOSS, DAMAGE OR INJURY TO PURCHASER AND PURCHASER'S PROPERTY AND TO OTHERS AND THEIR PROPERTY ARISING OUT OF THE USE, MISUSE OR INABILITY TO USE THIS PRODUCT SOLD BY SAMSUNG NOT CAUSED DIRECTLY BY THE NEGLIGENCE OF SAMSUNG. THIS LIMITED WARRANTY SHALL NOT EXTEND TO ANYONE OTHER THAN THE ORIGINAL PURCHASER OF THIS PRODUCT, IS NONTRANSFERABLE AND STATES YOUR EXCLUSIVE REMEDY.

Some states do not allow limitations on how long an implied warranty lasts, or the exclusion or limitation of incidental or consequential damages, so the above limitations or exclusions may not apply to you. This warranty gives you specific legal rights, and you may also have other rights which vary from state to state.

To obtain warranty service, please contact SAMSUNG at:

1-800-SAMSUNG (726-7864) or www.samsung.com/us/support (English)
www.samsung.com/ca_fr/support (French)



Scan the QR code* or visit
www.samsung.com/spsn
 to view our helpful
 How-to Videos and Live Shows

*Requires reader to be installed on your smartphone

Scan this with your smartphone

Please be advised that the Samsung warranty does NOT cover service calls to explain product operation, correct improper installation, or perform normal cleaning or maintenance.

QUESTIONS OR COMMENTS?

COUNTRY	CALL	OR VISIT US ONLINE AT
U.S.A Consumer Electronics	1-800-SAMSUNG (726-7864)	www.samsung.com/us/support
CANADA	1-800-SAMSUNG(726-7864)	www.samsung.com/ca/support (English) www.samsung.com/ca_fr/support (French)

DE68-04345Q-00 

Horno de microondas

Manual del usuario

MS14K6000**



SAMSUNG

Contenido

Instrucciones de seguridad importantes	3
Instalación	17
Elementos incluidos	17
Plato giratorio	18
Mantenimiento	19
Limpieza	19
Repuesto (reparación)	20
Cuidados para períodos prolongados sin uso	20
Antes de comenzar	21
Hora actual	21
Ahorro de energía	21
Bloqueo para niños	22
Activar o desactivar las señales sonoras	22
Cronómetro	22
Acerca de la energía de microondas	23
Utensilios de cocina para microondas	24
Funcionamiento	26
Panel de funciones	26
Pasos simples para comenzar	27
Modo manual	28
Configuraciones comunes	29
Modo con sensor	31
Modo automático	34
Platos preparados	41
Cocción inteligente	46
Guía de cocción en microondas	46
Guía de recalentado	49
Guía de descongelado	51
Rápido y fácil	53
Resolución de problemas	54
Puntos de verificación	54
Código de información	59
Especificaciones técnicas	60
Garantía	61
Horno de microondas Samsung	61

Instrucciones de seguridad importantes

Felicitaciones por haber adquirido su nuevo horno de microondas Samsung. Este manual contiene información importante acerca de la instalación, el uso y el cuidado de su electrodoméstico. Lea detenidamente el manual y podrá así aprovechar todas las ventajas y las funciones del horno de microondas.

LO QUE NECESITA SABER SOBRE LAS INSTRUCCIONES DE SEGURIDAD

Las advertencias y las instrucciones de seguridad importantes de este manual no cubren todos los problemas y situaciones que podrían ocurrir. Es su responsabilidad usar el sentido común, ser precavido y cuidadoso al instalar, mantener y manejar su horno de microondas.

PRECAUCIONES PARA EVITAR LA POSIBLE EXPOSICIÓN A ENERGÍA DE MICROONDAS EXCESIVA

- A.** No intente hacer funcionar este horno con la puerta abierta dado que el funcionamiento con la puerta abierta puede dar como resultado una exposición nociva a energía de microondas. Es importante no alterar ni modificar las trabas de seguridad.
- B.** No coloque ningún objeto entre la parte delantera del horno y la puerta ni deje que se acumule suciedad o residuos de limpiadores en la superficie de sellado.
- C.** No haga funcionar el horno si está dañado. Es de especial importancia que la puerta del horno cierre correctamente y que no haya daños en:
 - 1)** La puerta (doblada),
 - 2)** Las bisagras y los pestillos (rotos o sueltos),
 - 3)** Las juntas de la puerta y la superficie de sellado.
- D.** Este horno no debe ser ajustado ni reparado por nadie excepto por personal del servicio técnico adecuadamente calificado.

CONSERVE ESTAS INSTRUCCIONES



Instrucciones de seguridad importantes

SÍMBOLOS Y PRECAUCIONES DE SEGURIDAD IMPORTANTES

Significado de iconos y símbolos en este manual del usuario:

ADVERTENCIA

Prácticas peligrosas o inseguras que pueden provocar **lesiones personales graves o la muerte.**

PRECAUCIÓN

Prácticas peligrosas o inseguras que pueden provocar **lesiones leves o daños a la propiedad.**

PRECAUCIÓN

Para reducir el riesgo de incendio, explosión, descarga eléctrica o lesiones personales cuando utilice el horno de microondas, siga estas instrucciones básicas de seguridad:



NO intentar.



Desenchufe la alimentación eléctrica del tomacorriente de la pared.



NO desensamblar.



Asegúrese de que la máquina tenga buena conexión a tierra para evitar descargas eléctricas.



NO tocar.



Comuníquese con el centro de servicio técnico para obtener ayuda.



Siga las instrucciones fielmente.



Nota

Estas señales de advertencia se incluyen para evitar lesiones a usted y a otras personas. Sígalos explícitamente. Una vez que haya leído esta sección, consérvela en un lugar seguro para consultas futuras.

CONSERVE ESTAS INSTRUCCIONES



ADVERTENCIA SOBRE LA STATE OF CALIFORNIA PROPOSITION 65 (SOLO EE.UU.)

ADVERTENCIA: Este producto contiene productos químicos reconocidos en el estado de California como capaces de provocar cáncer y defectos de nacimiento u otras afecciones reproductivas.

Al utilizar cualquier electrodoméstico, se deben seguir precauciones de seguridad básicas, a saber:

⚠ ADVERTENCIA

Para reducir el riesgo de quemaduras, descargas eléctricas, incendios, lesiones o exposición a energía de microondas excesiva:

1. Lea todas las instrucciones de seguridad antes de usar este electrodoméstico.
2. Lea y siga las "Precauciones para evitar la posible exposición a energía de microondas excesiva" en la página 3.
3. Este electrodoméstico debe conectarse a tierra. Conéctelo solo a los tomacorrientes adecuadamente conectados a tierra. Consulte "Instrucciones importantes de conexión a tierra" en la página 7 de este manual.
4. Instale o coloque este electrodoméstico solo de acuerdo con las instrucciones de instalación proporcionadas.
5. Algunos productos tales como los huevos enteros y los recipientes sellados (por ejemplo, frascos de vidrio cerrados) pueden explotar si se los calienta rápidamente. Nunca los caliente en un horno de microondas.
6. Utilice este electrodoméstico solo para el uso al que fue destinado según se describe en este manual. No exponga este electrodoméstico a vapores ni productos químicos corrosivos. Este tipo de horno está específicamente diseñado para calentar, cocinar o secar alimentos. No está diseñado para uso industrial o de laboratorio.
7. Al igual que con cualquier electrodoméstico, se requiere de supervisión cuando es utilizado por niños. Mantenga a los niños alejados de la puerta cuando la abra o la cierre ya que podría golpearlos o pillarles los dedos.
8. No haga funcionar este electrodoméstico si tiene un cable o enchufe dañado, si no funciona correctamente o si fue dañado o se cayó.
9. Este electrodoméstico debe ser reparado solo por personal técnico calificado. Comuníquese con la oficina del servicio técnico autorizado más cercana para que examinen, reparen o ajusten el equipo.
10. No tape ni bloquee ninguna de las aberturas del electrodoméstico.
11. No altere ni haga ajustes ni reparaciones en la puerta.

CONSERVE ESTAS INSTRUCCIONES



Instrucciones de seguridad importantes

12. No almacene este electrodoméstico al aire libre. No utilice este producto cerca del agua, por ejemplo, cerca del fregadero de la cocina, en un sótano húmedo, cerca de una piscina o en lugares similares.
13. No sumerja el cable ni el enchufe en agua.
14. Mantenga el cable alejado de superficies calientes. (incluso la parte posterior del horno).
15. No permita que el cable cuelgue del borde de una mesa o mesada.
16. Cuando limpie las superficies de la puerta y del horno que se ensamblan al cerrar la puerta, utilice solo jabones o detergentes suaves, no abrasivos, aplicados con una esponja o paño suave. Desenchúfelo antes de limpiarlo.
17. Para reducir el riesgo de incendio en el interior del horno:
 - 1) No cocine los alimentos en exceso. Preste atención al electrodoméstico cuando coloque en su interior papel, plástico u otros materiales combustibles para facilitar la cocción.
 - 2) Retire las ataduras de alambre de las bolsas de papel o plástico antes de colocar las bolsas en el horno.
 - 3) Si los materiales en el interior del horno se prenden fuego, mantenga la puerta cerrada, apague el horno y desconecte el cable de alimentación o corte la alimentación en el panel del disyuntor o fusible. Si abre la puerta, el fuego puede expandirse.
 - 4) No utilice el interior para almacenar alimentos u objetos. No deje productos de papel, utensilios de cocina ni alimentos en el interior cuando no utiliza el horno.
18. Los líquidos tales como agua, leche, café o té pueden recalentarse más allá del punto de ebullición sin que se note que están hirviendo. No siempre se verán las burbujas o el hervor cuando se retira el recipiente del horno de microondas. **ESTO PUEDE HACER QUE LOS LÍQUIDOS MUY CALIENTES SE DERRAMEN REPENTINAMENTE CUANDO SE MUEVE EL RECIPIENTE O SE COLOCA UNA CUCHARA U OTRO UTENSILIO EN EL LÍQUIDO.** Para reducir el riesgo de lesiones:
 - 1) No caliente demasiado los líquidos.
 - 2) Revuelva el líquido antes y durante la etapa de calentamiento.
 - 3) No utilice recipientes con lados rectos y cuellos estrechos.
 - 4) Después de calentar, deje reposar el recipiente en el horno de microondas durante un tiempo breve antes de sacarlo.
 - 5) Tenga sumo cuidado cuando introduce una cuchara u otro utensilio en el recipiente.
19. Los alimentos o utensilios de metal de mayor tamaño al normal no deben colocarse en el horno de microondas/tostador dado que pueden provocar un incendio o una descarga eléctrica.
20. No limpie con paños para fregar de metal. Puede desprenderse un trozo de metal del paño, entrar en contacto con las piezas eléctricas y provocar una descarga.
21. No coloque productos de papel en el horno cuando se encuentre en modo tostadora.
22. No almacene ningún material, distinto de los accesorios recomendados por el fabricante, en este horno cuando no se lo utiliza.
23. No cubra los estantes ni ninguna otra parte del horno con papel de aluminio. Si lo hace, el horno podría sobrecalentarse.

CONSERVE ESTAS INSTRUCCIONES

