

Description for HVPS Changes of A3LCLP510N
(HVPS version 0.4 ->1.2)

1. BIAS-TRANS Optimization

V0.4 : EE1916 BIAS TRANS
V1.2 : EE1312 BIAS TRANS

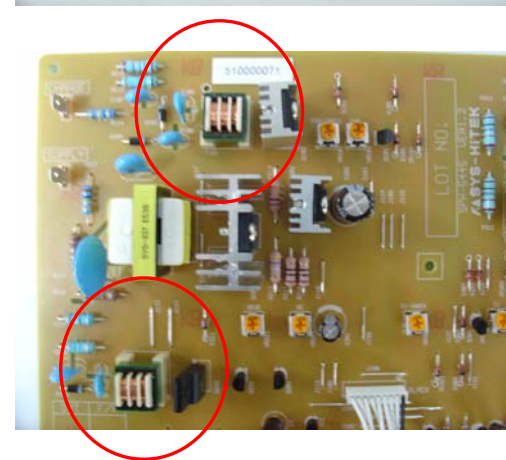
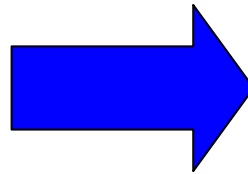
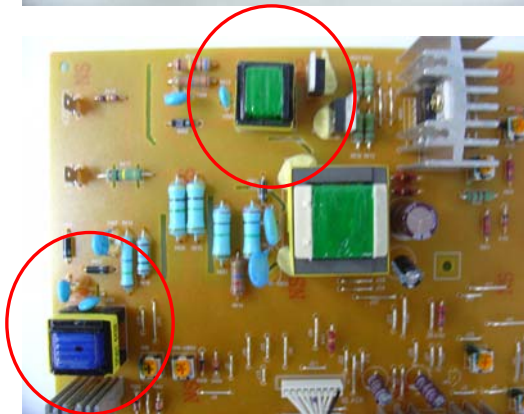
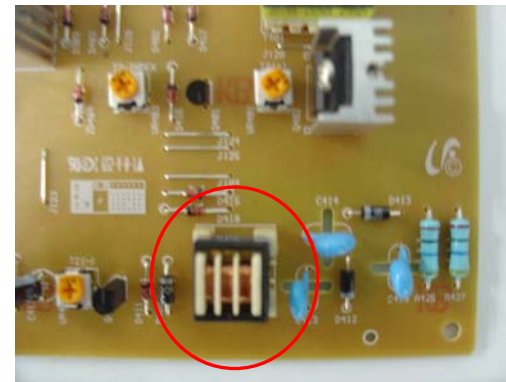
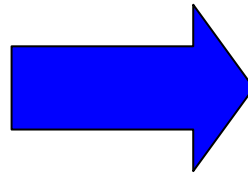
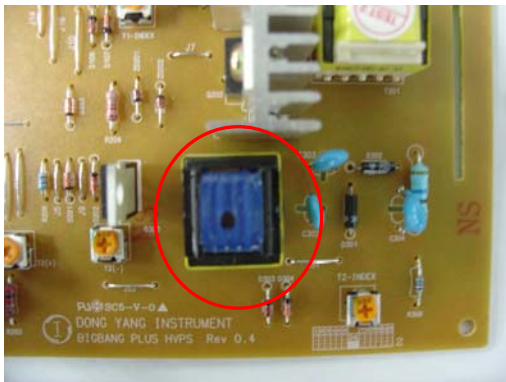

2. AC TRANS Optimization

V0.4 : Iron core EI3025
V1.2 : Ferrite EE2519

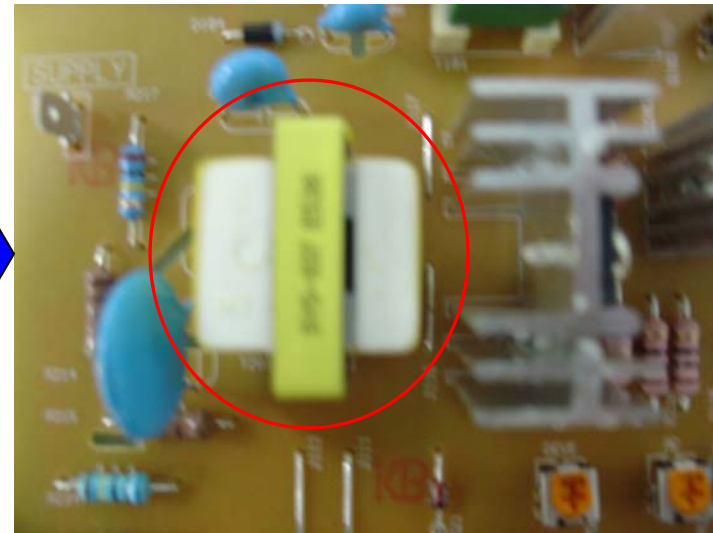
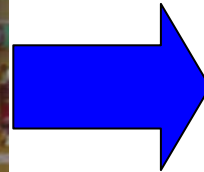
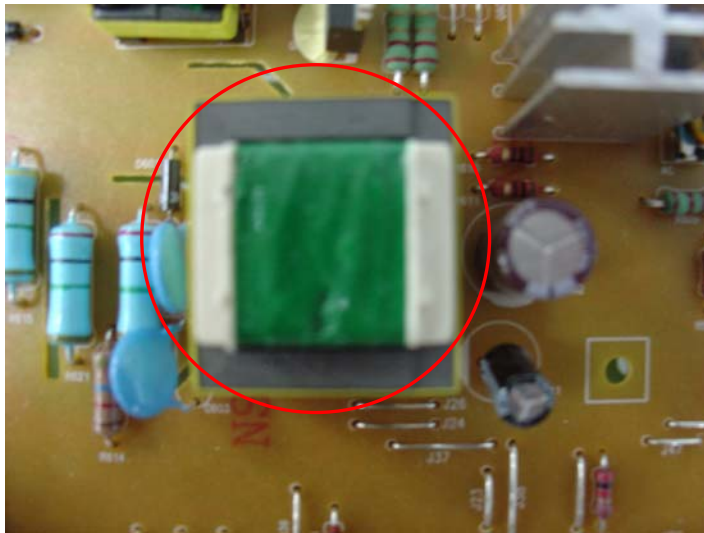

4. Regulator Circuit Optimization

Remove Heat sink in regulator circuit

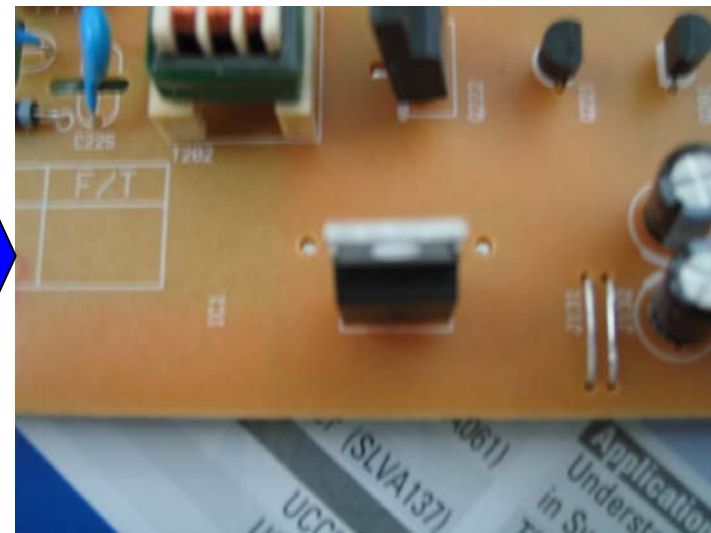
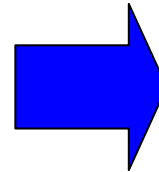
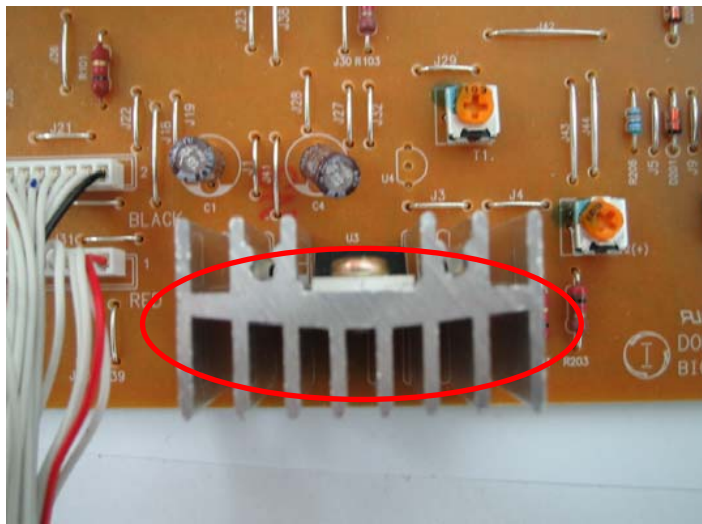

5. Reverse-Transfer Circuit Optimization

S/W Transistor Optimization of Changing Reverse-Transfer circuit
(no control unit → sub winding wire control)

