

TEST REPORT

of

FCC Part 15 Subpart C §15.247

FCC ID: A3LATKM102000

Equipment Under Test : ARTIK-1020
Model Name : ATKM102000
Variant Model Name : ATKM102001, ATKM102002
Applicant : Samsung Electronics Co., Ltd.
Manufacturer : Samsung Electro-Mechanics Co., Ltd.
Date of Test(s) : 2016.04.01 ~ 2016.04.23
Date of Issue : 2016.06.16

In the configuration tested, the EUT complied with the standards specified above.

Tested By:



Jungmin Yang

Date:

2016.06.16

Approved By:



Hyunchoe You

Date:

2016.06.16

The results shown in this test report refer only to the sample(s) tested unless otherwise stated. This test report cannot be reproduced, except in full, without prior written permission of the Company.

SGS Korea Co., Ltd. (Gunpo Laboratory) 4, LS-ro 182beon-gil, Gunpo-si, Gyeonggi-do, Korea, 15807 <http://www.sgsgroup.kr>

INDEX

<u>Table of Contents</u>	Page
1. General Information -----	3
2. Radiated Spurious Emissions and Conducted Spurious Emission-----	7
3. 6 dB Bandwidth -----	23
4. Maximum Peak Conducted Output Power -----	26
5. Power Spectral Density -----	28
6. AC Power Line Conducted Emission -----	31
7. Antenna Requirement -----	35

The results shown in this test report refer only to the sample(s) tested unless otherwise stated. This test report cannot be reproduced, except in full, without prior written permission of the Company.

SGS Korea Co., Ltd. (Gunpo Laboratory) 4, LS-ro 182beon-gil, Gunpo-si, Gyeonggi-do, Korea, 15807 <http://www.sgsgroup.kr>

RTT5041-20(2015.10.01)(3)

Tel. +82 31 428 5700 / Fax. +82 31 427 2370

A4(210 mm x 297 mm)

1. General Information

1.1. Testing Laboratory

SGS Korea Co., Ltd. (Gunpo Laboratory)

- Wireless Div. 2FL, 10-2, LS-ro 182beon-gil, Gunpo-si, Gyeonggi-do, Korea, 15807

All SGS services are rendered in accordance with the applicable SGS conditions of service available on request and accessible at <http://www.sgs.com/en/Terms-and-Conditions.aspx>.

Phone No. : +82 31 688 0901

Fax No. : +82 31 688 0921

1.2. Details of Applicant

Applicant : Samsung Electronics Co., Ltd.

Address : 1, Samsung-ro, Giheung-gu, Yongin-si, Gyeonggi-do, 17113 Korea

Contact Person : Lee, Jae-Hyuk

Phone No. : +82 10 8848 6628

1.3. Description of EUT

Kind of Product		ARTIK-1020
Model Name		ATKM102000
Variant Model Name		ATKM102001, ATKM102002
Power Supply		DC 4.2 V
Frequency Range		2 402 MHz ~ 2 480 MHz (Bluetooth, Bluetooth Low Energy), 2 405 MHz ~ 2 475 MHz (Zigbee), 2 412 MHz ~ 2 462 MHz (11b/g/n_HT20), 2 422 MHz ~ 2 452 MHz (11n_HT40), 5 745 MHz ~ 5 825 MHz (Band 3: 11a/n_HT20, 11ac_VHT20), 5 755 MHz ~ 5 795 MHz (Band 3: 11n_HT40, 11ac_VHT40), 5 775 MHz (Band 3: 11ac_VHT80), 5 180 MHz ~ 5 220 MHz (Band 1: 11a/n_HT20, 11ac_VHT20), 5 190 MHz (Band 1: 11n_HT40, 11ac_VHT40), 5 260 MHz ~ 5 320 MHz (Band 2A: 11a/n_HT20, 11ac_VHT20), 5 270 MHz ~ 5 310 MHz (Band 2A: 11n_HT40, 11ac_VHT40), 5 290 MHz (Band 2A: 11ac_VHT80), 5 500 MHz ~ 5 720 MHz (Band 2C: 11a/n_HT20, 11ac_VHT20), 5 510 MHz ~ 5 710 MHz (Band 2C: 11n_HT40, 11ac_VHT40), 5 530 MHz ~ 5 690 MHz (Band 2C: 11ac_VHT80)
Modulation Technique		DSSS, OFDM, GFSK, $\pi/4$ DQPSK, 8DPSK
Number of Channels		79 channel (Bluetooth), 40 channel (Bluetooth Low Energy), 15 channel (Zigbee), 11 channel (11b/g/n_HT20), 7 channel (11n_HT40), 5 channel (Band 3: 11a/n_HT20, 11ac_VHT20), 2 channel (Band 3: 11n_HT40, 11ac_VHT40), 1 channel (Band 3: 11ac_VHT80), 3 channel (Band 1: 11a/n_HT20, 11ac_VHT20), 1 channel (Band 1: 11n_HT40, 11ac_VHT40), 4 channel (Band 2A: 11a/n_HT20, 11ac_VHT20), 2 channel (Band 2A: 11n_HT40, 11ac_VHT40), 1 channel (Band 2A: 11ac_VHT80), 9 channel (Band 2C: 11a/n_HT20, 11ac_VHT20), 4 channel (Band 2C: 11n_HT40, 11ac_VHT40), 2 channel (Band 2C: 11ac_VHT80)
Antenna Type		Dipole antenna
Antenna Gain	Port#1	2 402 MHz ~ 2 480 MHz: 2.7 dB i, 2 412 MHz ~ 2 462 MHz (MIMO): 2.7 dB i, 5 180 MHz ~ 5 320 MHz (MIMO): 2.7 dB i, 5 500 MHz ~ 5 720 MHz (MIMO): 2.7 dB i, 5 745 MHz ~ 5 825 MHz (MIMO): 2.7 dB i
	Port#2	2 412 MHz ~ 2 462 MHz (MIMO): 2.7 dB i, 5 180 MHz ~ 5 320 MHz (MIMO): 2.7 dB i, 5 500 MHz ~ 5 720 MHz (MIMO): 2.7 dB i, 5 745 MHz ~ 5 825 MHz (MIMO): 2.7 dB i
	Port#3	2 405 MHz ~ 2 475 MHz: 2.7 dB i
H/W Version		V0.5_R04
S/W Version		1020GC0F-3AF-01Q0

The results shown in this test report refer only to the sample(s) tested unless otherwise stated. This test report cannot be reproduced, except in full, without prior written permission of the Company.

SGS Korea Co., Ltd. (Gunpo Laboratory) 4, LS-ro 182beon-gil, Gunpo-si, Gyeonggi-do, Korea, 15807 <http://www.sgsgroup.kr>

1.4. Test Equipment List

Equipment	Manufacturer	Model	S/N	Cal Date	Cal Interval	Cal Due.
Signal Generator	Agilent	E8257D	MY51501169	Jul. 13, 2015	Annual	Jul. 13, 2016
Signal Generator	R&S	SMBV100A	255834	Jun. 22, 2015	Annual	Jun. 22, 2016
Spectrum Analyzer	R&S	FSV30	103100	Jun. 22, 2015	Annual	Jun. 22, 2016
Spectrum Analyzer	Agilent	N9020A	MY53421758	Sep. 24, 2015	Annual	Sep. 24, 2016
Attenuator	MCLI	FAS-23-20	23834	Jun. 08, 2015	Annual	Jun. 08, 2016
High Pass Filter	Wainwright Instrument GmbH	WHK3.0/18G-6SS	4	Jun. 23, 2015	Annual	Jun. 23, 2016
High Pass Filter	Wainwright Instrument GmbH	WHK7.5/26.5G-6SS	15	Jun. 23, 2015	Annual	Jun. 23, 2016
Low Pass Filter	Mini-Circuits	NLP-1200+	V 8979400903-2	Feb. 29, 2016	Annual	Feb. 29, 2017
Power Sensor	R&S	NRP-Z81	100669	Feb. 29, 2016	Annual	Feb. 29, 2017
DC Power Supply	Agilent	U8002A	MY53150029	Jun. 22, 2015	Annual	Jun. 22, 2016
Preamplifier	H.P.	8447F	2944A03909	Aug. 27, 2015	Annual	Aug. 27, 2016
Preamplifier	R&S	SCU-18	10117	Apr. 07, 2016	Annual	Apr. 07, 2017
Preamplifier	MITEQ Inc.	JS44-18004000-35-8P	1546891	May 07, 2015	Annual	May 07, 2016
Loop Antenna	R&S	HFH2-Z2	100118	Jun. 04, 2015	Biennial	Jun. 04, 2017
Bilog Antenna	Schwarzbeck Mess-Elektronik	VULB9163	396	Jun. 18, 2015	Biennial	Jun. 18, 2017
Horn Antenna	R&S	HF906	100608	Oct. 16, 2014	Biennial	Oct. 16, 2016
Horn Antenna	Schwarzbeck Mess-Elektronik	BBHA9170	BBHA9170431	May 15, 2014	Biennial	May 15, 2016
Antenna Master	INN-CO	MM4000	N/A	N.C.R.	N/A	N.C.R.
Turn Table	INN-CO	DS 1200 S	N/A	N.C.R.	N/A	N.C.R.
Test Receiver	R&S	ESU26	100109	Mar. 07, 2016	Annual	Mar. 07, 2017
Anechoic Chamber	SY Corporation	L x W x H (9.6 m x 6.4 m x 6.6 m)	N/A	N.C.R.	N/A	N.C.R.
Test Receiver	R&S	ESCI 7	100911	Dec. 22, 2015	Annual	Dec. 22, 2016
Artificial Mains Networks	R&S	ESH2-Z5	100280	Mar. 25, 2016	Annual	Mar. 25, 2017
Shield Room	SY Corporation	L x W x H (6.5 m x 3.5 m x 3.5 m)	N/A	N.C.R.	N/A	N.C.R.

The results shown in this test report refer only to the sample(s) tested unless otherwise stated. This test report cannot be reproduced, except in full, without prior written permission of the Company.

1.5. Summary of Test Results

The EUT has been tested according to the following specifications:

APPLIED STANDARD : FCC Part15 Subpart C		
Standard section	Test Item(s)	Result
15.205(a) 15.209 15.247(d)	Radiated Spurious Emissions and Conducted Spurious Emission	Complied
15.247(a)(2)	6 dB Bandwidth	Complied
15.247(b)(3)	Maximum Peak Conducted Output Power	Complied
15.247(e)	Power Spectral Density	Complied
15.207	AC Power Line Conducted Emission	Complied

1.6. Test Procedure(s)

The measurement procedures described in the American National Standard for Testing Unlicensed Wireless Devices (ANSI C63.10-2009) and the guidance provided in KDB 558074_v03r05 were used in the measurement of the DUT.

1.7. Sample calculation

Where relevant, the following sample calculation is provided:

1.7.1. Conducted test

Offset value (dB) = Attenuator (dB) + Cable loss (dB)

1.7.2. Radiation test

Field strength level (dB μ V/m) = Measured level (dB μ V) + Antenna factor (dB) + Cable loss (dB) - Amplifier gain (dB)

1.8. Test report revision

Revision	Report number	Date of Issue	Description
0	F690501/RF-RTL009768	2016.04.29	Initial
1	F690501/RF-RTL009768-1	2016.06.16	Add U-NII 2A and 2C of 1.3 "Description of EUT"

The results shown in this test report refer only to the sample(s) tested unless otherwise stated. This test report cannot be reproduced, except in full, without prior written permission of the Company.

1.9. Information of variant models

Model		Information
Basic Model	ATKM102000	<p>H/W</p> <ul style="list-style-type: none"> - PCB Layout and Out-line are the exactly same between both models. (PCB : Common used for both models) - PMIC, RF TRCV and Memory are the exactly same between both models. - Main Chip has perfectly same specifications except security features. (Main Chip does not support security features) <p>S/W</p> <ul style="list-style-type: none"> - ATKM102000, ATKM102001, ATKM102002 has same FW. - User can update FW if they need.
Variant Model	ATKM102001	<p>H/W</p> <ul style="list-style-type: none"> - Same to main model except security features. (Main Chip support Secure Boot) <p>S/W</p> <ul style="list-style-type: none"> - Same to main model.
	ATKM102002	<p>H/W</p> <ul style="list-style-type: none"> - Same to main model except security features. (Main Chip support Secure Boot & Secure JTAG) <p>S/W</p> <ul style="list-style-type: none"> - Same to main model.

The results shown in this test report refer only to the sample(s) tested unless otherwise stated. This test report cannot be reproduced, except in full, without prior written permission of the Company.

2. Radiated Spurious Emissions and Conducted Spurious Emission

2.1. Test Setup

2.1.1. Radiated Spurious Emissions

The diagram below shows the test setup that is utilized to make the measurements for emission from 9 kHz to 30 MHz Emissions.

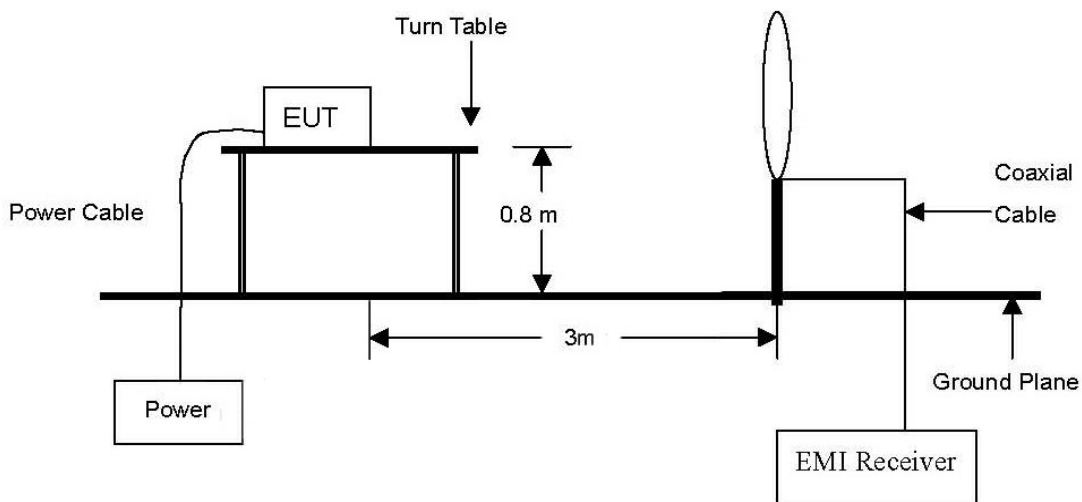

The diagram below shows the test setup that is utilized to make the measurements for emission from 30 MHz to 1 GHz Emissions.

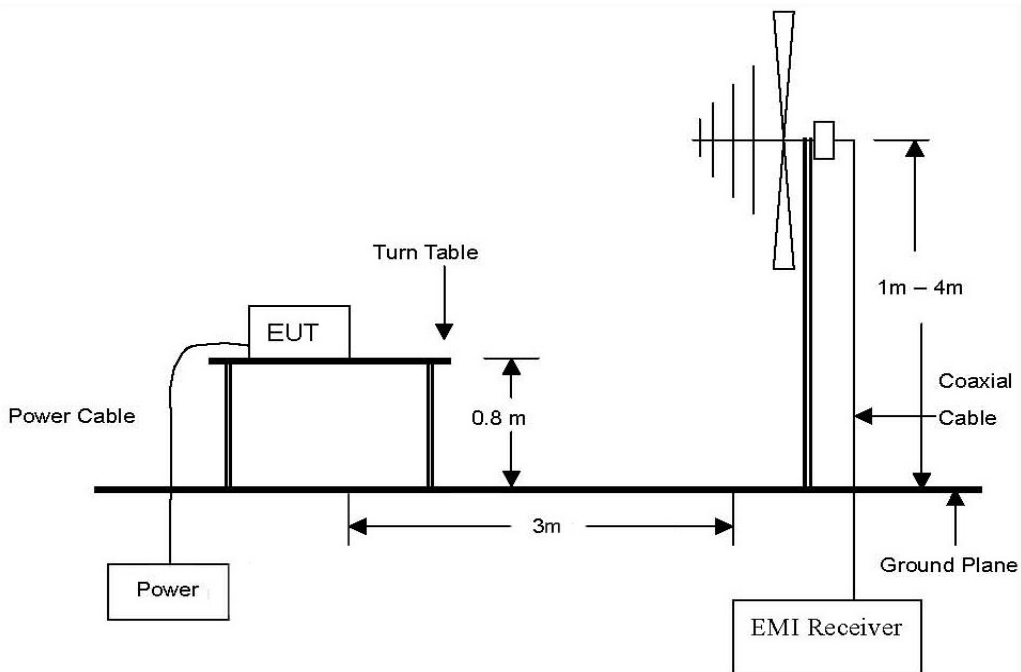

The results shown in this test report refer only to the sample(s) tested unless otherwise stated. This test report cannot be reproduced, except in full, without prior written permission of the Company.

The diagram below shows the test setup that is utilized to make the measurements for emission. The spurious emissions were investigated from 1 GHz to the 10th harmonic of the highest fundamental frequency or 40 GHz, whichever is lower.

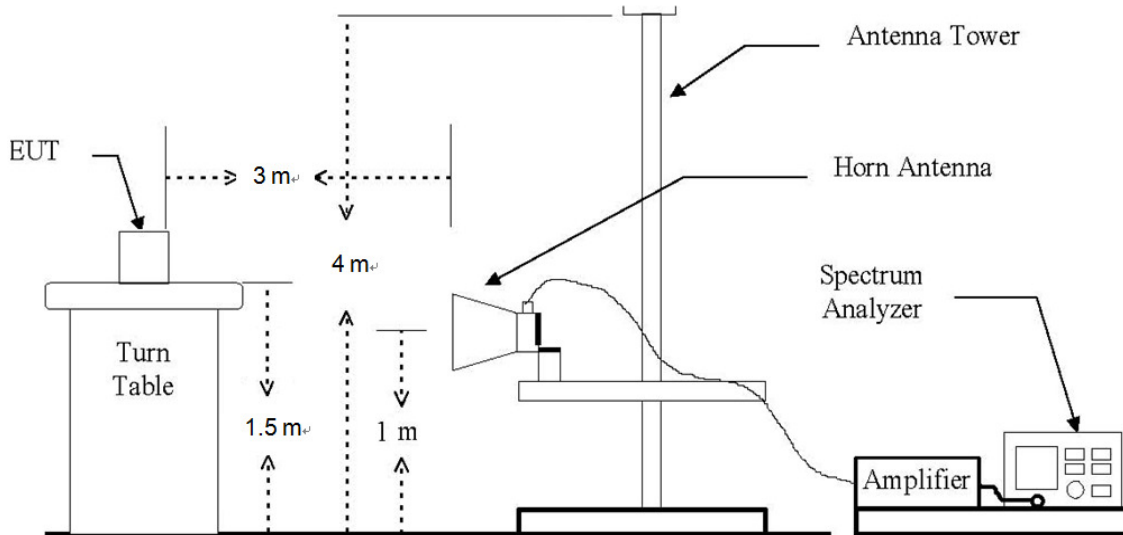

The results shown in this test report refer only to the sample(s) tested unless otherwise stated. This test report cannot be reproduced, except in full, without prior written permission of the Company.

2.1.2. Conducted Spurious Emissions

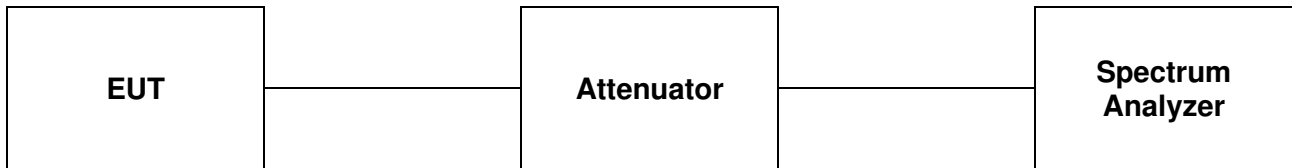

2.2. Limit

According to §15.247(d), in any 100 kHz bandwidth outside the frequency band in which the spread spectrum or digitally modulated intentional radiator is operating, the radio frequency power that is produced by the intentional radiator shall be at least 20 dB below that in the 100 kHz bandwidth within the band that contains the highest level of the desired power, based on either an RF conducted or a radiated measurement, provided the transmitter demonstrates compliance with the peak conducted power limits. If the transmitter complies with the conducted power limits based on the use of RMS averaging over a time interval, as permitted under paragraph(b)(3) of this section, the attenuation required under this paragraph shall be 30 dB instead of 20 dB. Attenuation below the general limits specified in section §15.209(a) is not required. In addition, radiated emission which in the restricted band, as define in section §15.205(a), must also comply the radiated emission limits specified in section §15.209(a) (see section §15.205(c))

According to § 15.209(a), Except as provided elsewhere in this Subpart, the emissions from an intentional radiator shall not exceed the field strength levels specified in the following table :

Frequency (MHz)	Distance (Meters)	Field Strength (dB μ V/m)	Field Strength (μ V/m)
0.009 – 0.490	300	20 log (2 400/F(kHz))	2 400/F(kHz)
0.490 – 1.705	30	20 log (24 000/F(kHz))	24 000/F(kHz)
1.705 – 30.0	30	29.54	30
30 – 88	3	40.0	100
88 – 216	3	43.5	150
216 – 960	3	46.0	200
Above 960	3	54.0	500

The results shown in this test report refer only to the sample(s) tested unless otherwise stated. This test report cannot be reproduced, except in full, without prior written permission of the Company.

2.3. Test Procedures

Radiated emissions from the EUT were measured according to the dictates in section 11.0 & 12.0 of KDB 558074_v03r05 and ANSI C63.10-2009.

Remark:

Testing for radiated emissions above 1 GHz was performed with the EUT elevated at 1.5 m instead of 0.8 m. 1.5 m is the required height in ANSI C63.10:2013 as referenced by RSS-Gen issue 4. This test height has been permitted by FCC as discussed in FCC-TCB conference call in December 2014.

2.3.1. Test Procedures for emission below 30 MHz

1. The EUT was placed on the top of a rotating table 0.8 meters above the ground at a 3 meter anechoic chamber test site. The table was rotated 360 degrees to determine the position of the highest radiation.
2. Then antenna is a loop antenna is fixed at one meter above the ground to determine the maximum value of the field strength. Both parallel and perpendicular of the antenna are set to make the measurement.
3. For each suspected emission, the EUT was arranged to its worst case and then the table was turned from 0 degrees to 360 degrees to find the maximum reading.
4. The test-receiver system was set to average or quasi peak detect function and Specified Bandwidth with Maximum Hold Mode.

2.3.2. Test Procedures for emission from above 30 MHz

1. The EUT was placed on the top of a rotating table 0.8 meters above the ground at a 3 meter anechoic chamber test site below 1 GHz and 1.5 meters above the ground at a 3 meter anechoic chamber test site above 1 GHz. The table was rotated 360 degrees to determine the position of the highest radiation.
2. During performing radiated emission below 1 GHz, the EUT was set 3 meters away from the interference receiving antenna, which was mounted on the top of a variable-height antenna tower. During performing radiated emission above 1 GHz, the EUT was set 3 meter away from the interference-receiving antenna.
3. The antenna is a bi-log antenna, a horn antenna and its height is varied from one meter to four meters above the ground to determine the maximum value of the field strength. Both horizontal and vertical polarizations of the antenna are set to make the measurement.
4. For each suspected emission, the EUT was arranged to its worst case and then the antenna was tuned to heights from 1 meter to 4 meters and the table was turned from 0 degrees to 360 degrees to find the maximum reading.
5. The test-receiver system was set to Peak Detect Function and Specified Bandwidth with Maximum Hold Mode.
6. If the emission level of the EUT in peak mode was 10 dB lower than the limit specified, then testing could be stopped and the peak values of the EUT would be reported. Otherwise the emissions that did not have 10 dB margin would be re-tested one by one using peak, quasi-peak or average method as specified and then reported in a data sheet.

The results shown in this test report refer only to the sample(s) tested unless otherwise stated. This test report cannot be reproduced, except in full, without prior written permission of the Company.

SGS Korea Co., Ltd. (Gunpo Laboratory) 4, LS-ro 182beon-gil, Gunpo-si, Gyeonggi-do, Korea, 15807 <http://www.sgsgroup.kr>

RTT5041-20(2015.10.01)(3)

Tel. +82 31 428 5700 / Fax. +82 31 427 2370

A4(210 mm x 297 mm)

NOTE;
1. Unwanted Emissions into Non-Restricted Frequency Bands

- The Reference Level Measurement refer to section 11.2

Set analyzer center frequency to DTS channel center frequency, SPAN ≥ 1.5 times the DTS bandwidth, the RBW = 100 kHz and VBW $\geq 3 \times$ RBW, Detector = Peak, Sweep time = Auto couple, Trace = Max hold

- Unwanted Emissions Level Measurement refer to section 11.3

Set the center frequency and span to encompass frequency range to be measured, the RBW = 100 kHz and VBW $\geq 3 \times$ RBW, Detector = Peak, Ensure that the number of measurement points \geq span/RBW, Sweep time = Auto couple, Trace = Max hold

2. Unwanted Emissions into Restricted Frequency Bands

- Peak Power measurement procedure refer to section 12.2.4

Set RBW = as specified in Table 1, VBW $\geq 3 \times$ RBW, Detector = Peak, Sweep time = Auto couple, Trace = Max hold.

Table 1- RBW as a function of frequency

Frequency	RBW
9 – 150 kHz	200 – 300 Hz
0.15 – 30 MHz	9 – 10 kHz
30 – 1 000 MHz	100 – 120 kHz
> 1 000 MHz	1 MHz

-Average Power measurements procedure refer to section 12.2.5.2

The EUT shall be configured to operate at the maximum achievable duty cycle.

Measure the duty cycle, x, of the transmitter output signal as described in section 6.0.

Set RBW = 1 MHz, VBW $\geq 3 \times$ RBW, Detector = RMS, if span / (# of points in sweep) \leq (RBW/2).

Satisfying this condition may require increasing the number of points in the sweep or reducing the span. If this condition cannot be satisfied then the detector mode shall be set to peak.

Averaging type = power (i.e., RMS).

As an alternative the detector and averaging type may be set for linear voltage averaging.

Some instruments require linear display mode in order to use linear voltage averaging. Log or dB averaging shall not be used. Sweep time = auto, Perform a trace average of at least 100 traces.

A correction factor shall be added to the measurement results prior to comparing to the emission limit in order to compute the emission level that would have been measured had the test been performed at 100 percent duty cycle. The correction factor is computed as follows:

- 1) If power averaging (RMS) mode was used in step f), then the applicable correction factor is $10 \log (1/x)$, where x is the duty cycle.
- 3) If a specific emission is demonstrated to be continuous (≥ 98 percent duty cycle) rather than turning on and off with the transmit cycle, then no duty cycle correction is required for that emission.

3. To get a maximum emission level from the EUT, the EUT is manipulated through three orthogonal planes (X, Y, Z). Worst orthogonal plan of EUT is **Z – axis** during radiation test.

The results shown in this test report refer only to the sample(s) tested unless otherwise stated. This test report cannot be reproduced, except in full, without prior written permission of the Company.

SGS Korea Co., Ltd. (Gunpo Laboratory) 4, LS-ro 182beon-gil, Gunpo-si, Gyeonggi-do, Korea, 15807 <http://www.sgsgroup.kr>

2.3.3. Test Procedures for Conducted Spurious Emissions

Per the guidance of KDB 558074 v03r05, section 11.1 & 11.2 & 11.3, the reference level for out of band emissions is established from the plots of this section since the band edge emissions are measured with a RBW of 100 kHz. This reference level is then used as the limit in subsequent plots for out of band spurious emissions shown in section 2.4.3. The limit for out of band spurious emission at the band edge is 20 dB or 30 dB below the fundamental emission level measured in a 100 kHz bandwidth.

1. Conducted Emissions at Band Edge

- The Measurement refer to section 11.2

Set the center frequency and span to encompass frequency range to be measured, the RBW = 100 kHz and VBW $\geq 3 \times$ RBW, Detector = Peak, Sweep time = Auto couple, Trace = Max hold, Ensure that the number of measurement points \geq span/RBW, The trace was allowed to stabilize.

2. Conducted Spurious Emissions

- The Measurement refer to section 11.3

Start frequency was set to 9 kHz and stop frequency was set to 25 GHz (separated into two plots per channel), RBW = 100 kHz, VBW $\geq 3 \times$ RBW, Detector = Peak, Sweep time = Auto couple, Trace = Max hold, The trace was allowed to stabilize.

3. TDF function

- For plots showing conducted spurious emissions from 9 kHz to 25 GHz, all path loss of wide frequency range was investigated and compensated to spectrum analyzer as TDF function. So, the reading values shown in plots were final result.

The results shown in this test report refer only to the sample(s) tested unless otherwise stated. This test report cannot be reproduced, except in full, without prior written permission of the Company.

SGS Korea Co., Ltd. (Gunpo Laboratory) 4, LS-ro 182beon-gil, Gunpo-si, Gyeonggi-do, Korea, 15807 <http://www.sgsgroup.kr>

RTT5041-20(2015.10.01)(3)

Tel. +82 31 428 5700 / Fax. +82 31 427 2370

A4(210 mm x 297 mm)

2.4. Test Results

Ambient temperature : (23 ± 1) °C

Relative humidity : 47 % R.H.

2.4.1. Radiated Spurious Emission below 1 000 MHz

The frequency spectrum from 9 MHz to 1 000 MHz was investigated. All reading values are peak values.

Radiated Emissions			Ant	Correction Factors		Total	Limit	
Frequency (MHz)	Reading (dB μ V)	Detect Mode	Pol.	AF (dB/m)	AMP + CL (dB)	Actual (dB μ V/m)	Limit (dB μ V/m)	Margin (dB)
47.91	39.10	Peak	V	14.59	-27.06	26.63	40.00	13.37
54.90	39.80	Peak	V	13.71	-26.98	26.53	40.00	13.47
64.48	43.00	Peak	V	11.71	-26.88	27.83	40.00	12.17
76.64	48.60	Peak	V	9.91	-26.81	31.70	40.00	8.30
199.02	40.40	Peak	V	11.57	-25.83	26.14	43.50	17.36
Above 200.00	Not detected	-	-	-	-	-	-	-

Remark:

1. Spurious emissions for all channels were investigated and almost the same below 1 GHz.
2. Reported spurious emissions are in **Middle channel** as worst case among other channels.
3. Radiated spurious emission measurement as below.
(Actual = Reading + Antenna Factor + Amp + CL)
4. According to §15.31(o), emission levels are not report much lower than the limits by over 20 dB.

The results shown in this test report refer only to the sample(s) tested unless otherwise stated. This test report cannot be reproduced, except in full, without prior written permission of the Company.

SGS Korea Co., Ltd. (Gunpo Laboratory) 4, LS-ro 182beon-gil, Gunpo-si, Gyeonggi-do, Korea, 15807 <http://www.sgsgroup.kr>

RTT5041-20(2015.10.01)(3)

Tel. +82 31 428 5700 / Fax. +82 31 427 2370

A4(210 mm x 297 mm)

2.4.2. Radiated Spurious Emission above 1 000 MHz

The frequency spectrum above 1 000 MHz was investigated. All reading values are peak and average values.

A. Low Channel (2 402 MHz)

Radiated Emissions			Ant.	Correction Factors			Total	Limit	
Frequency (MHz)	Reading (dB μ V)	Detect Mode	Pol.	AF (dB/m)	CL (dB)	Duty (dB)	Actual (dB μ V/m)	Limit (dB μ V/m)	Margin (dB)
*2 310.00	23.96	Peak	H	28.07	5.35	-	57.38	74.00	16.62
*2 310.00	14.63	Average	H	28.07	5.35	2.08	50.13	54.00	3.87
*2 389.96	27.06	Peak	H	28.15	5.38	-	60.59	74.00	13.41
*2 374.15	15.37	Average	H	28.13	5.37	2.08	50.95	54.00	3.05
*2 390.00	27.06	Peak	H	28.15	5.38	-	60.59	74.00	13.41
*2 390.00	14.47	Average	H	28.15	5.38	2.08	50.08	54.00	3.92

Radiated Emissions			Ant.	Correction Factors			Total	Limit	
Frequency (MHz)	Reading (dB μ V)	Detect Mode	Pol.	AF (dB/m)	AMP+ CL (dB)	Duty (dB)	Actual (dB μ V/m)	Limit (dB μ V/m)	Margin (dB)
*4 805.61	42.49	Peak	H	32.66	-29.81	-	45.34	74.00	28.66
*4 803.02	30.62	Average	H	32.65	-29.81	2.08	35.54	54.00	18.46
Above 4 900.00	Not detected	-	-	-	-	-	-	-	-

B. Middle Channel (2 440 MHz)

Radiated Emissions			Ant.	Correction Factors			Total	Limit	
Frequency (MHz)	Reading (dB μ V)	Detect Mode	Pol.	AF (dB/m)	AMP+ CL (dB)	Duty (dB)	Actual (dB μ V/m)	Limit (dB μ V/m)	Margin (dB)
*4 879.95	42.30	Peak	H	32.86	-29.50	-	45.66	74.00	28.34
*4 880.65	30.47	Average	H	32.86	-29.50	2.08	35.91	54.00	18.09
Above 4 900.00	Not detected	-	-	-	-	-	-	-	-

The results shown in this test report refer only to the sample(s) tested unless otherwise stated. This test report cannot be reproduced, except in full, without prior written permission of the Company.

C. High Channel (2 480 MHz)

Radiated Emissions			Ant.	Correction Factors			Total	Limit	
Frequency (MHz)	Reading (dB μ V)	Detect Mode	Pol.	AF (dB/m)	CL (dB)	Duty (dB)	Actual (dB μ V/m)	Limit (dB μ V/m)	Margin (dB)
*2 483.50	25.22	Peak	H	28.24	5.44	-	58.90	74.00	15.10
*2 483.50	15.17	Average	H	28.24	5.44	2.08	50.93	54.00	3.07
*2 484.03	26.64	Peak	H	28.24	5.45	-	60.33	74.00	13.67
*2 487.38	16.01	Average	H	28.25	5.45	2.08	51.79	54.00	2.21
*2 500.00	25.25	Peak	H	28.26	5.49	-	59.00	74.00	15.00
*2 500.00	15.20	Average	H	28.26	5.49	2.08	51.03	54.00	2.97

Radiated Emissions			Ant.	Correction Factors			Total	Limit	
Frequency (MHz)	Reading (dB μ V)	Detect Mode	Pol.	AF (dB/m)	AMP+CL (dB)	Duty (dB)	Actual (dB μ V/m)	Limit (dB μ V/m)	Margin (dB)
*4 959.92	41.51	Peak	H	33.07	-29.51	-	45.07	74.00	28.93
*4 959.12	30.39	Average	H	33.07	-29.51	2.08	36.03	54.00	17.97
Above 5 000.00	Not detected	-	-	-	-	-	-	-	-

Remarks;

1. "*" means the restricted band.
2. Measuring frequencies from 1 GHz to the 10th harmonic of highest fundamental frequency.
3. Radiated emissions measured in frequency above 1 000 MHz were made with an instrument using peak/average detector mode.
4. Actual = Reading + AF + AMP + CL or Reading + AF + CL.
5. According to § 15.31(o), Emission levels are not reported much lower than the limits by over 20 dB.

The results shown in this test report refer only to the sample(s) tested unless otherwise stated. This test report cannot be reproduced, except in full, without prior written permission of the Company.

Note;

Duty cycle measurement of EUT

Duty cycle (x) = Tx(on) / Tx(on+off) = 0.39 μ s / 0.63 μ s = 0.62

Duty factor = 10log(1/x), 10log(1/0.62) = 2.08

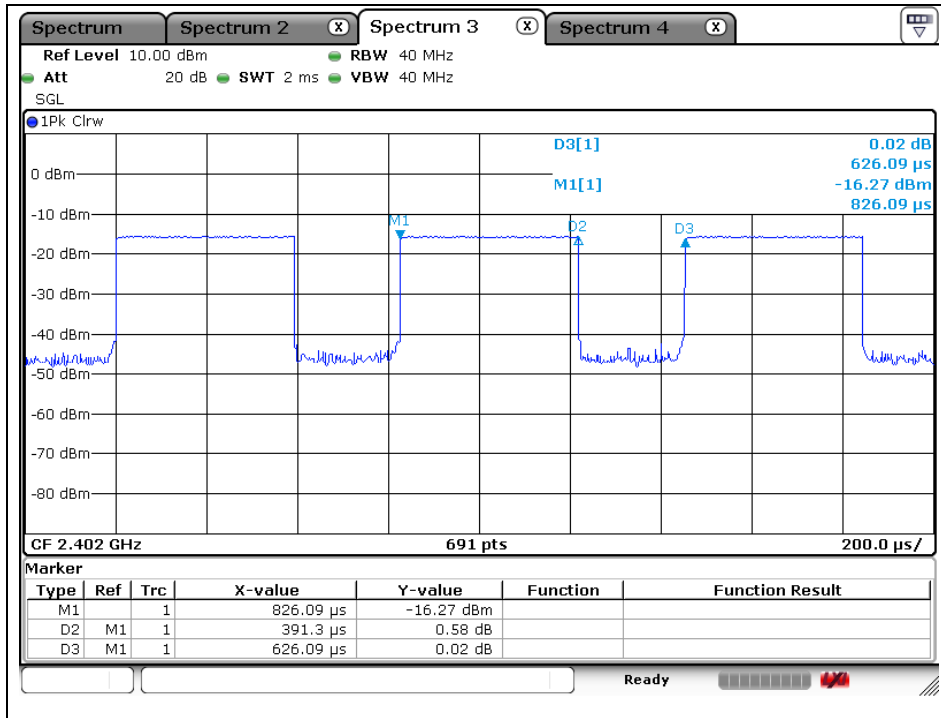

The results shown in this test report refer only to the sample(s) tested unless otherwise stated. This test report cannot be reproduced, except in full, without prior written permission of the Company.

SGS Korea Co., Ltd. (Gunpo Laboratory) 4, LS-ro 182beon-gil, Gunpo-si, Gyeonggi-do, Korea, 15807 <http://www.sgsgroup.kr>

RTT5041-20(2015.10.01)(3)

Tel. +82 31 428 5700 / Fax. +82 31 427 2370

A4(210 mm x 297 mm)

2.4.3. Spurious RF Conducted Emissions: Plot of Spurious RF Conducted Emission

Low Channel

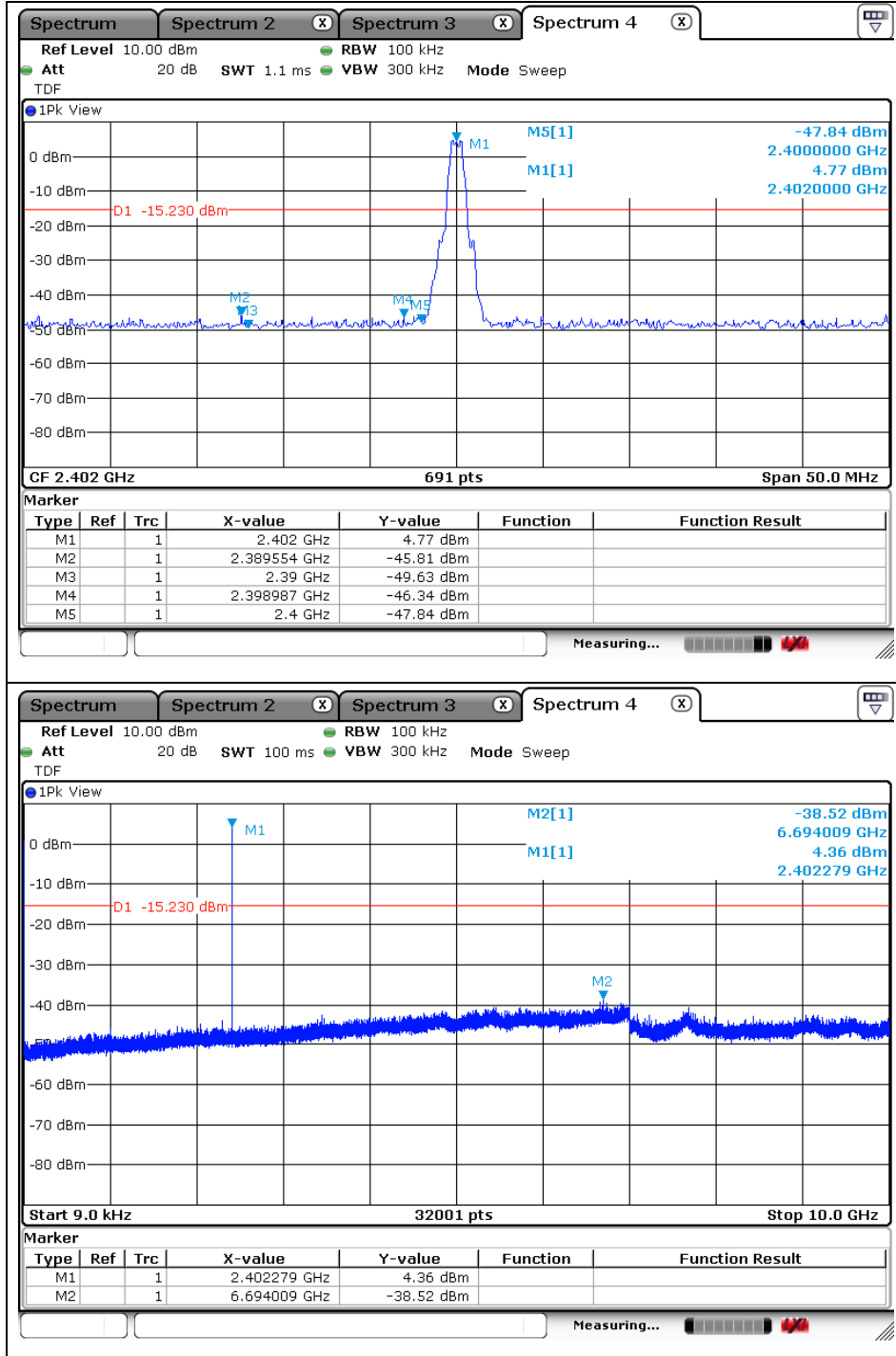

The results shown in this test report refer only to the sample(s) tested unless otherwise stated. This test report cannot be reproduced, except in full, without prior written permission of the Company.

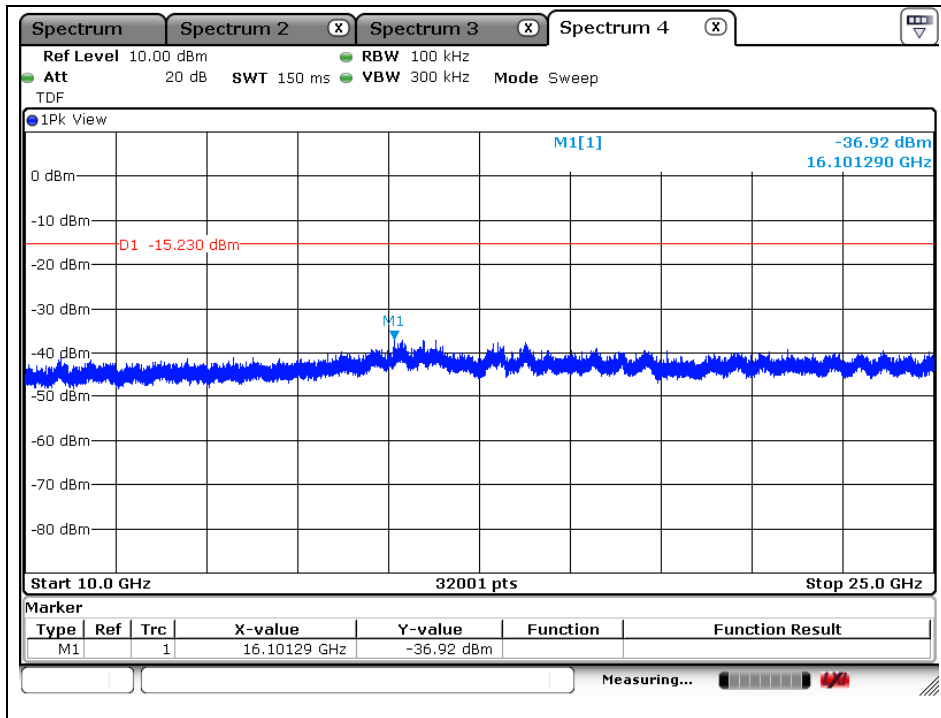

The results shown in this test report refer only to the sample(s) tested unless otherwise stated. This test report cannot be reproduced, except in full, without prior written permission of the Company.

SGS Korea Co., Ltd. (Gunpo Laboratory) 4, LS-ro 182beon-gil, Gunpo-si, Gyeonggi-do, Korea, 15807 <http://www.sgsgroup.kr>

Middle Channel

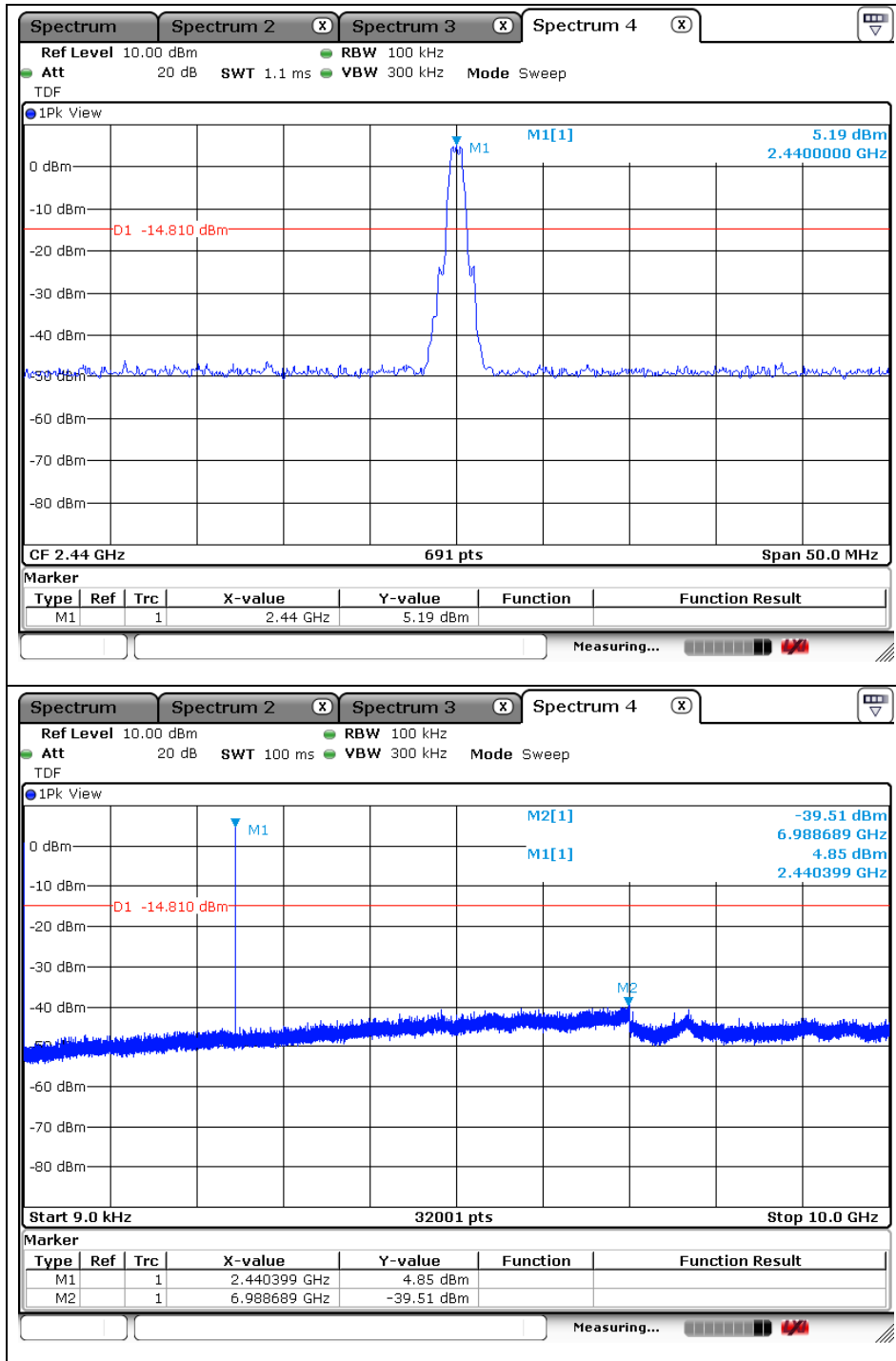

The results shown in this test report refer only to the sample(s) tested unless otherwise stated. This test report cannot be reproduced, except in full, without prior written permission of the Company.

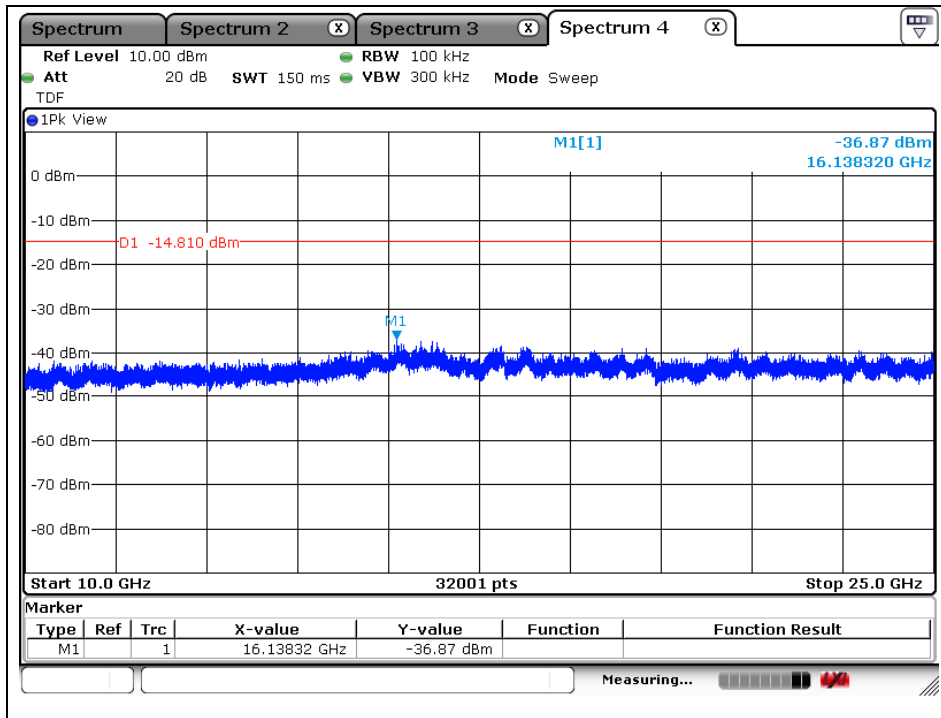

The results shown in this test report refer only to the sample(s) tested unless otherwise stated. This test report cannot be reproduced, except in full, without prior written permission of the Company.

High Channel

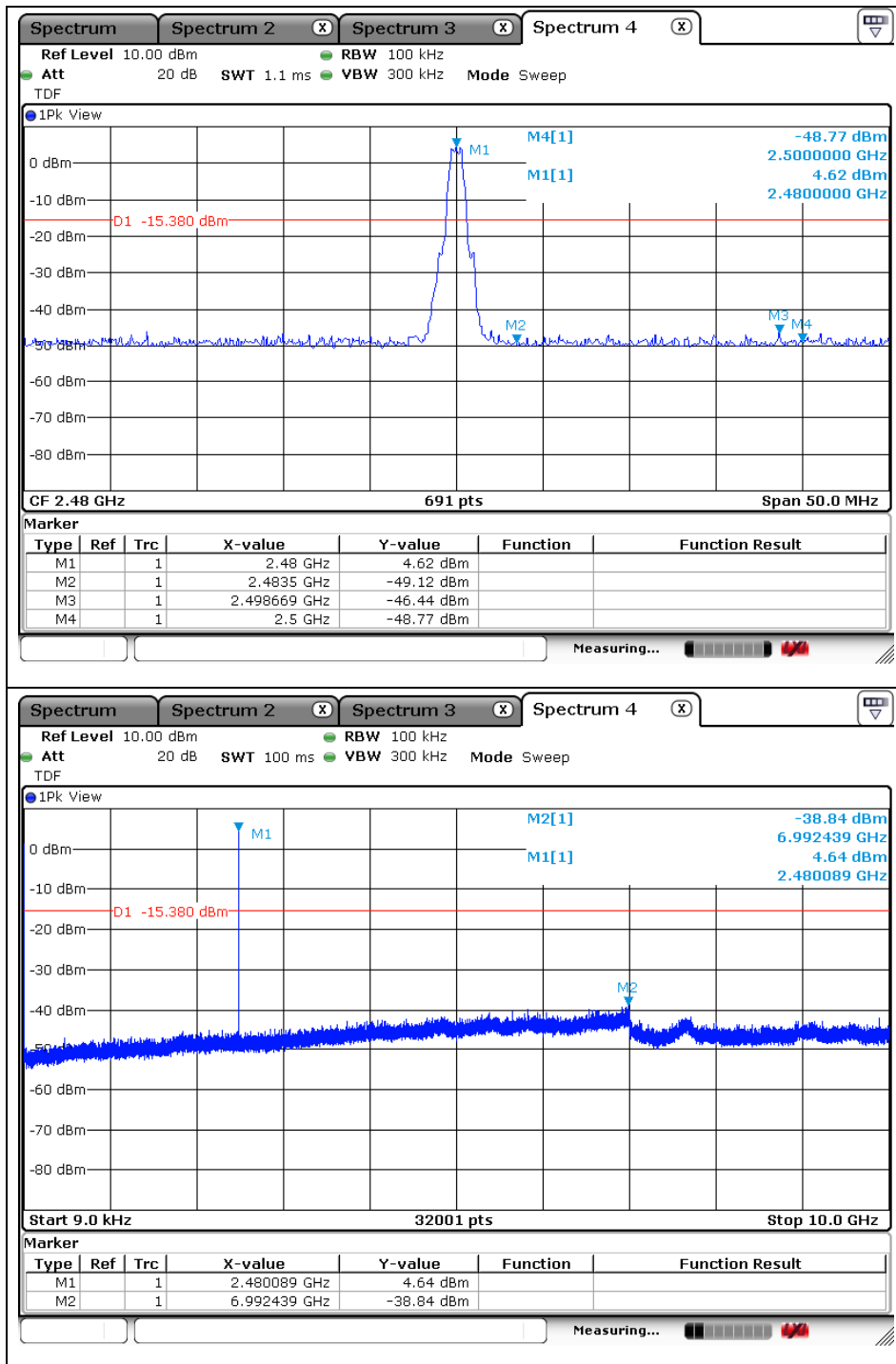

The results shown in this test report refer only to the sample(s) tested unless otherwise stated. This test report cannot be reproduced, except in full, without prior written permission of the Company.

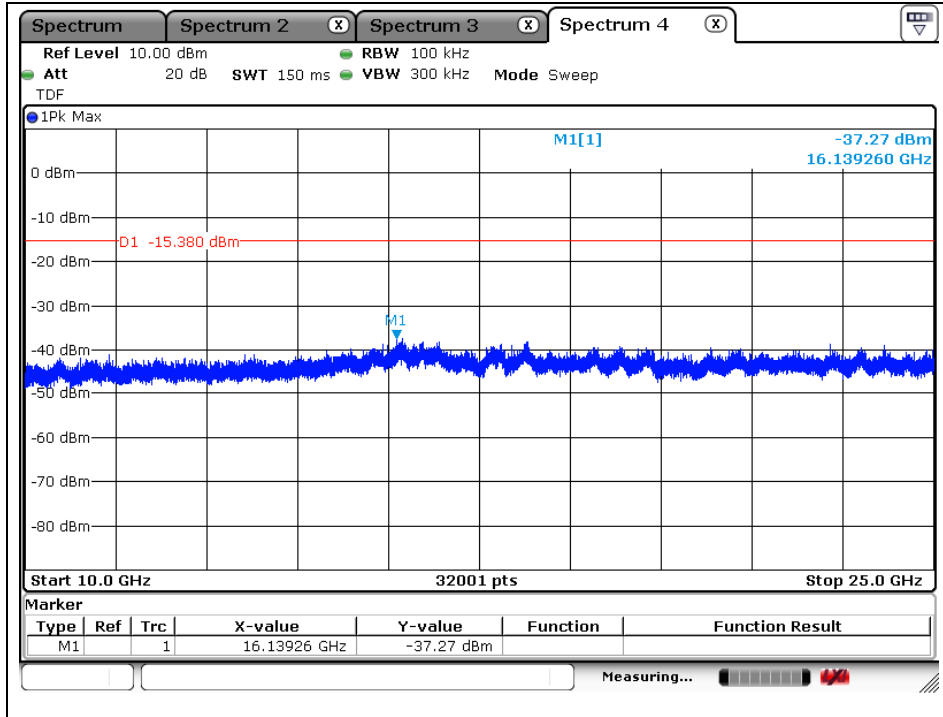

The results shown in this test report refer only to the sample(s) tested unless otherwise stated. This test report cannot be reproduced, except in full, without prior written permission of the Company.

3. 6 dB Bandwidth

3.1. Test Setup

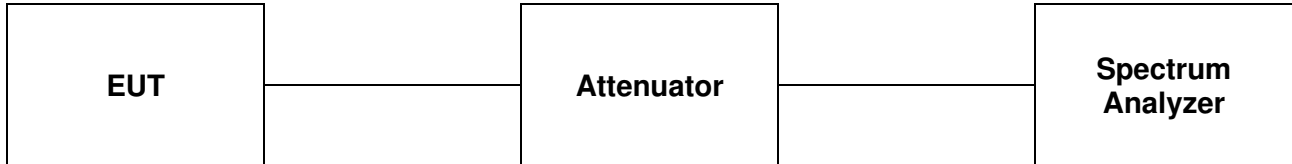

3.2. Limit

According to §15.247(a)(2), systems using digital modulation techniques may operate in the 902-928 MHz, 2 400-2 483.5 MHz, and 5 725-5 825 MHz bands. The minimum of 6 dB Bandwidth shall be at least 500 kHz.

3.3. Test Procedure

3.3.1. 6 dB Bandwidth

The test follows section 8.0 DTS bandwidth of FCC KDB Publication 558074_v03r05.

Tests performed using section 8.1 Option 1.

- Option 1:

1. Set RBW = 100 kHz.
2. Set the video bandwidth (VBW) $\geq 3 \times$ RBW.
3. Detector = Peak.
4. Trace mode = max hold.
5. Sweep = auto couple.
6. Allow the trace to stabilize.
7. Measure the maximum width of the emission that is constrained by the frequencies associated with the two outermost amplitude points (upper and lower) that are attenuated by 6 dB relative to the maximum level measured in the fundamental emission.

The results shown in this test report refer only to the sample(s) tested unless otherwise stated. This test report cannot be reproduced, except in full, without prior written permission of the Company.

SGS Korea Co., Ltd. (Gunpo Laboratory) 4, LS-ro 182beon-gil, Gunpo-si, Gyeonggi-do, Korea, 15807 <http://www.sgsgroup.kr>

RTT5041-20(2015.10.01)(3)

Tel. +82 31 428 5700 / Fax. +82 31 427 2370

A4(210 mm x 297 mm)

3.4. Test Results

Ambient temperature : (23 ± 1) °C
 Relative humidity : 47 % R.H.

Operation Mode	Channel	Frequency (MHz)	6 dB Bandwidth (kHz)	Minimum Bandwidth (kHz)
GFSK	Low	2 402	0.731	500
	Middle	2 440	0.716	500
	High	2 480	0.716	500

Low Channel

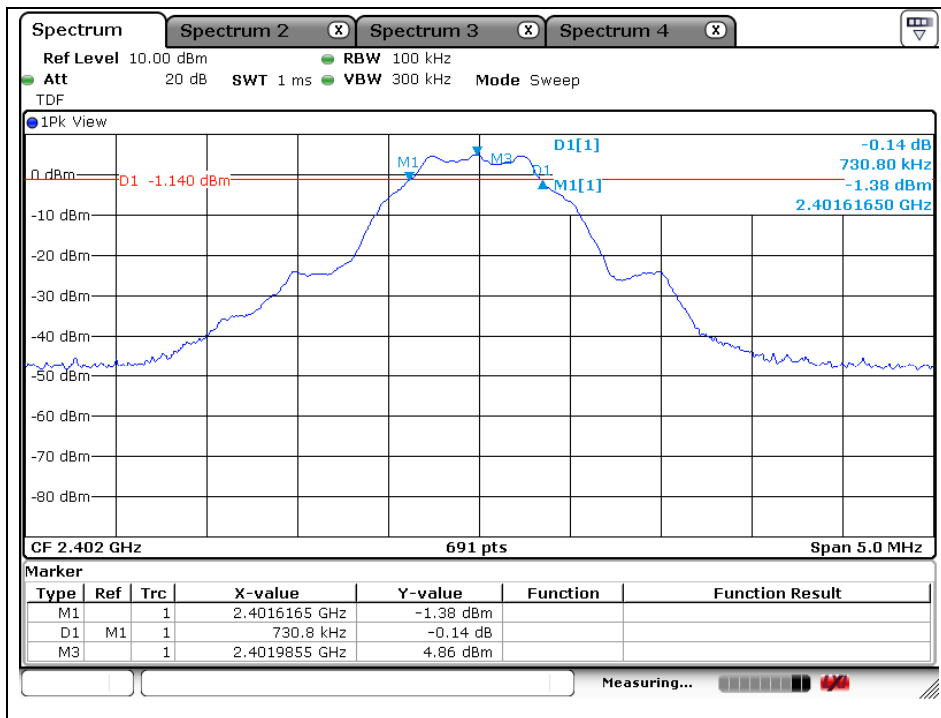

The results shown in this test report refer only to the sample(s) tested unless otherwise stated. This test report cannot be reproduced, except in full, without prior written permission of the Company.

Middle Channel

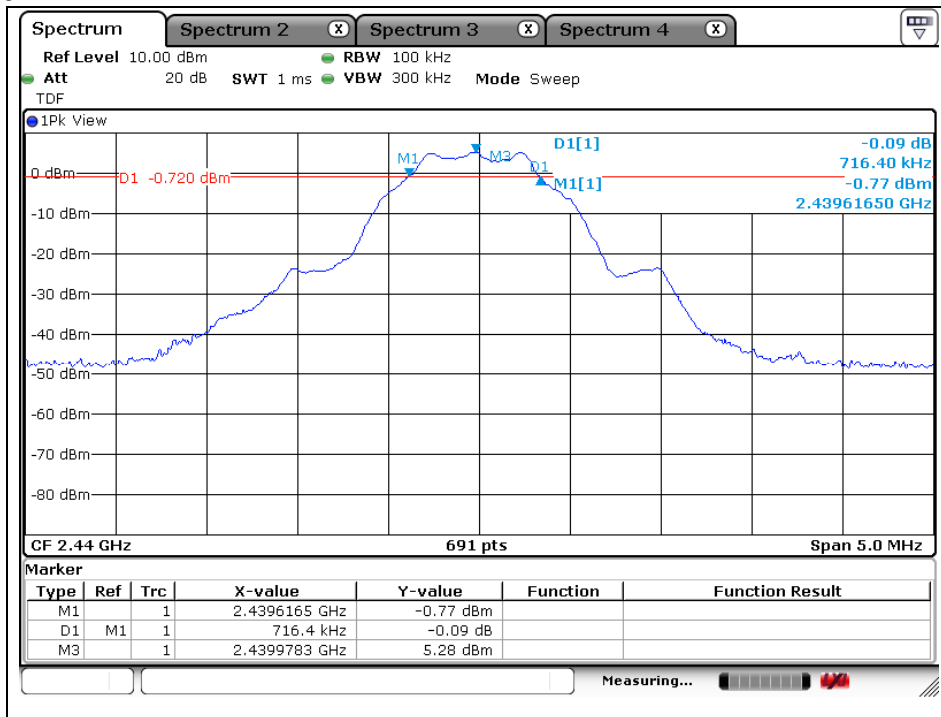

High Channel

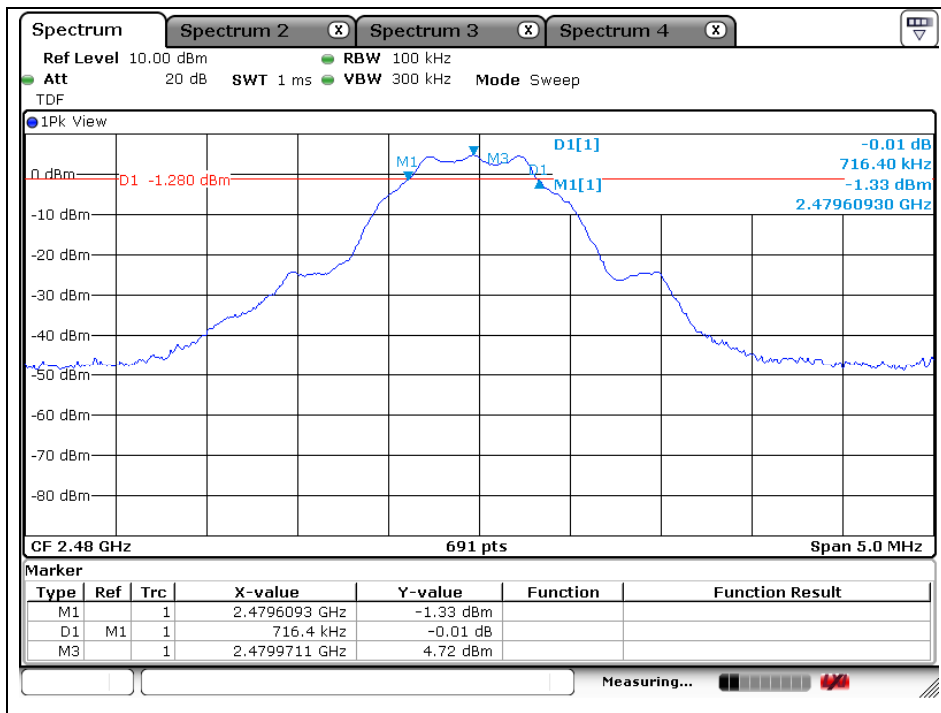

The results shown in this test report refer only to the sample(s) tested unless otherwise stated. This test report cannot be reproduced, except in full, without prior written permission of the Company.

4. Maximum Peak Conducted Output Power

4.1. Test Setup

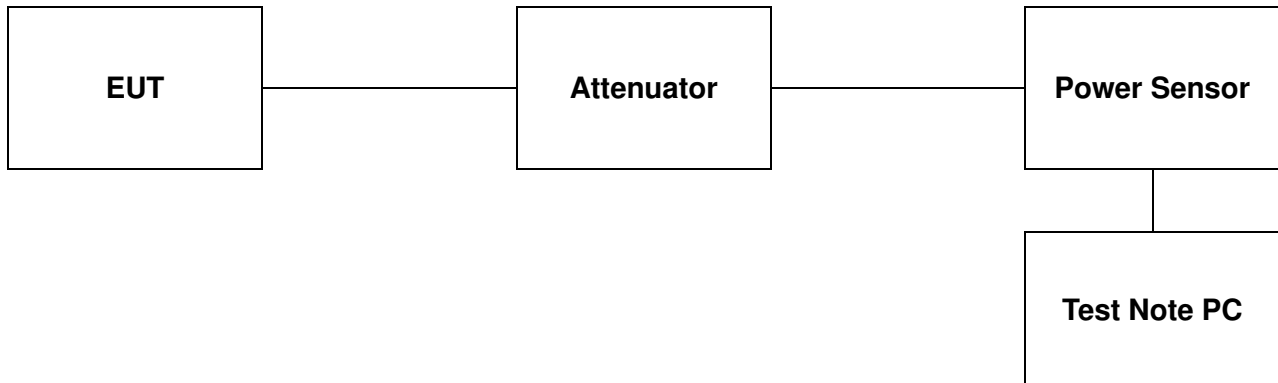

4.2. Limit

According to §15.247(b)(3), for systems using digital modulation in the 902-928 MHz, 2 400-2 483.5 MHz, and 5 725-5 850 MHz band : 1 Watt. As an alternative to a peak power measurement, compliance with the one watt limit can be based on a measurement of the maximum conducted output power. Maximum Conducted output Power is defined as the total transmit power delivered to all antennas and antenna elements averaged across all symbols in the signaling alphabet when the transmitter is operating at its maximum power control level. Power must be summed across all antenna elements. The average must not include any intervals during which the transmitter is off or is transmitting at a reduced power level. If multiple modes of operation are possible (e.g., alternative modulation methods), the maximum conducted output power is the highest total transmit power occurring in any mode.

According to §15.247(b)(4), the conducted output power limit specified in paragraph(b) of this section is based on the use of antenna with directional gains that do not exceed 6 dBi. Except as shown in paragraph(c) of this section, if transmitting antenna of directional gain greater than 6 dBi are used, the conducted output power from the intentional radiator shall be reduced below the stated values in paragraph (b)(1), (b)(2), and (b)(3) of this section, as appropriate, by the amount in dB that the directional gain of the antenna exceeds 6 dBi.

4.3. Test Procedure

The test follows section 9.1.2 of FCC KDB Publication 558074 v03r05.

- Peak power meter method

-The maximum peak conducted output power can be measured using a broad band peak RF power meter. The power meter shall have a video bandwidth that is greater than or equal to the DTS bandwidth and shall utilize a fast-responding diode detector.

Test program: (S/W name : R&S Power Viewer, Version : 3.2.0)

1. Initially overall offset for attenuator and cable loss is measured per frequency.
2. Measured offset is inserted in test program in advance of measurement for output power.
3. Power for each frequency (channel) of device is investigated as final result.
4. Final result reported on this section from R&S power viewer program includes with several factors and test program shows only final result.

The results shown in this test report refer only to the sample(s) tested unless otherwise stated. This test report cannot be reproduced, except in full, without prior written permission of the Company.

4.4. Test Results

Ambient temperature : (23 ± 1) °C
 Relative humidity : 47 % R.H.

Mode	Channel	Frequency (MHz)	Attenuator + Cable offset (dB)	Peak Power Result (dB m)	Peak Power Limit (dB m)
GFSK	Low	2 402	21.20	5.97	30
	Middle	2 440	21.25	<u>6.33</u>	30
	High	2 480	21.18	5.85	30

Remark;

Attenuator and cable offset was compensated in test program (R&S Power Viewer) before measuring.

The results shown in this test report refer only to the sample(s) tested unless otherwise stated. This test report cannot be reproduced, except in full, without prior written permission of the Company.

SGS Korea Co., Ltd. (Gunpo Laboratory) 4, LS-ro 182beon-gil, Gunpo-si, Gyeonggi-do, Korea, 15807 <http://www.sgsgroup.kr>

RTT5041-20(2015.10.01)(3)

Tel. +82 31 428 5700 / Fax. +82 31 427 2370

A4(210 mm x 297 mm)

5. Power Spectral Density

5.1. Test Setup

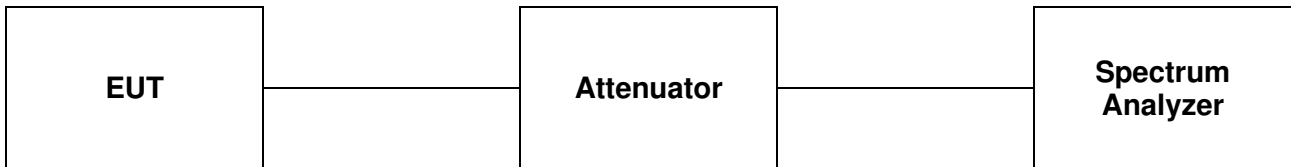

5.2. Limit

§15.247(e) For digitally modulated system, the power spectral density conducted from the intentional radiator to the antenna shall not be greater than 8 dB m in any 3 kHz band any time interval of continuous transmission. This power spectral density shall be determined in accordance with the provisions of paragraph (b) of this section. The same method of determining the conducted output power shall be used to determine the power spectral density.

5.3. Test Procedure

The measurement is recorded using the PKPSD measurement procedure in section 10.2 of KDB 558074_v03r05.

- This procedure shall be used if maximum peak conducted output power was used to demonstrate compliance, and is optional if the maximum conducted (average) output power was used to demonstrate compliance.

1. Set analyzer center frequency to DTS channel center frequency.
2. Set the span to at least 1.5 times the DTS channel bandwidth.
3. Set the RBW to : $3 \text{ kHz} \leq \text{RBW} \leq 100 \text{ kHz}$.
4. Set the VBW $\geq 3 \times \text{RBW}$.
5. Detector = Peak.
6. Sweep time = auto couple.
7. Trace mode = max hold.
8. Allow trace to fully stabilize.
9. Use the peak marker function to determine the maximum amplitude level within the RBW.
10. If measured value exceeds limit, reduce RBW (no less than 3 kHz) and repeat.

The results shown in this test report refer only to the sample(s) tested unless otherwise stated. This test report cannot be reproduced, except in full, without prior written permission of the Company.

SGS Korea Co., Ltd. (Gunpo Laboratory) 4, LS-ro 182beon-gil, Gunpo-si, Gyeonggi-do, Korea, 15807 <http://www.sgsgroup.kr>

5.4. Test Results

Ambient temperature : (23 ± 1) °C
 Relative humidity : 47 % R.H.

Mode	Channel	Frequency (MHz)	Measured PSD (dB m)	Maximum Limit (dB m)
GFSK	Low	2 402	-8.77	8
	Middle	2 440	-8.24	8
	High	2 480	-8.84	8

Low Channel

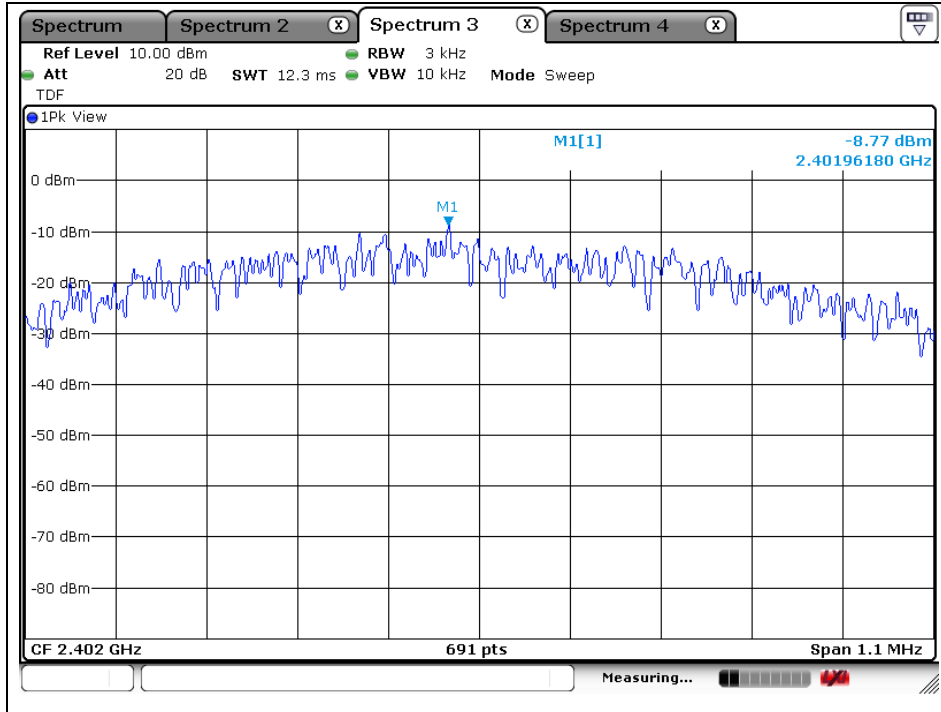

The results shown in this test report refer only to the sample(s) tested unless otherwise stated. This test report cannot be reproduced, except in full, without prior written permission of the Company.

Middle Channel

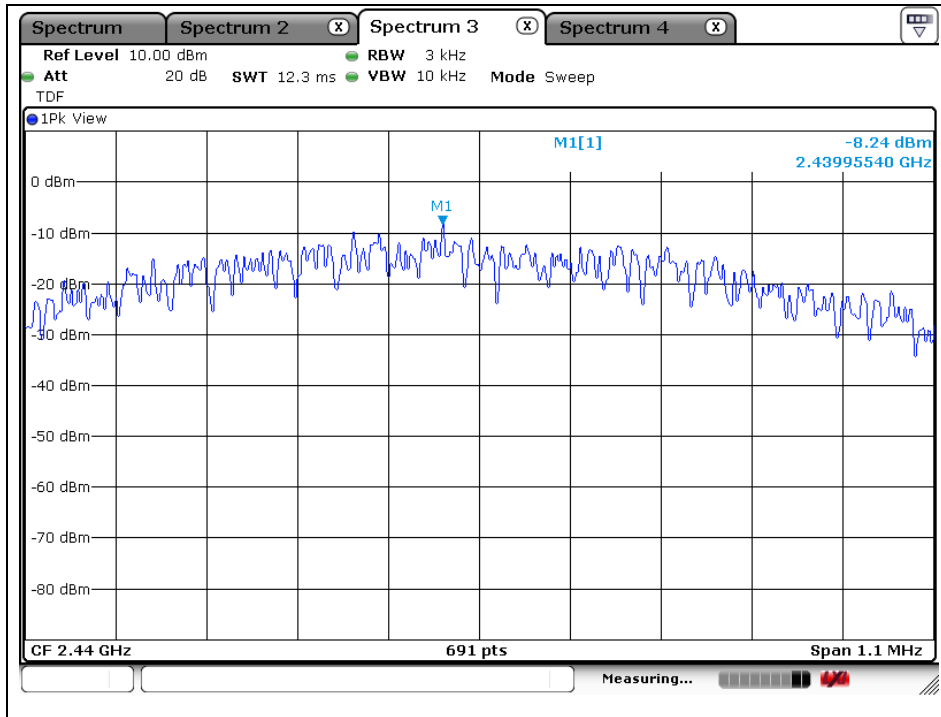

High Channel

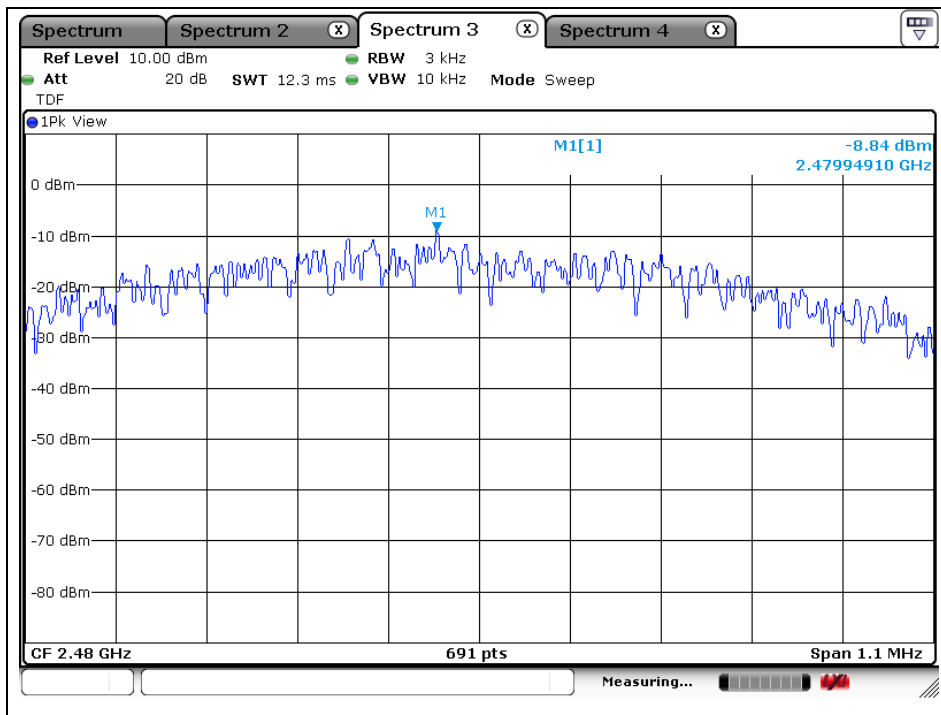

The results shown in this test report refer only to the sample(s) tested unless otherwise stated. This test report cannot be reproduced, except in full, without prior written permission of the Company.

6. AC Power Line Conducted Emission

6.1. Test Setup

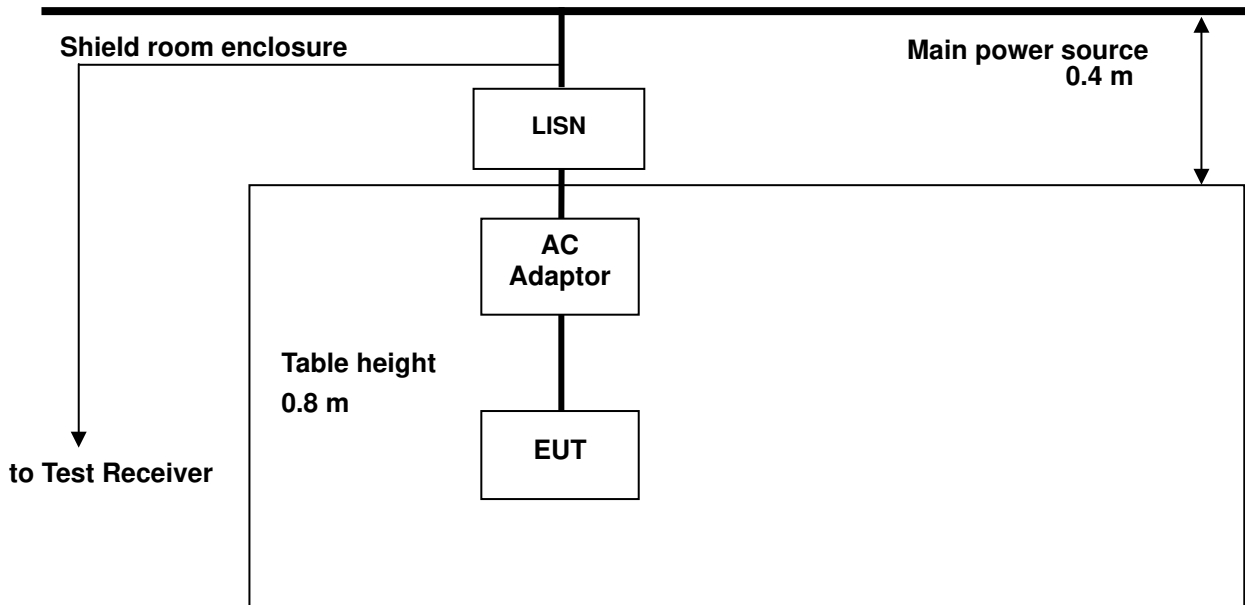

6.2. Limit

According to §15.207(a) for an intentional radiator that is designed to be connected to the public utility (AC) power line, the radio frequency voltage that is conducted back onto the AC power line on any frequency or frequencies, within the band 150 kHz to 30 MHz, shall not exceed the limits in the following table, as measured using a 50 μ H / 50 ohm line impedance stabilization network(LISN).

Compliance with the provision of this paragraph shall on the measurement of the radio frequency voltage between each power line and ground at the power terminal. The lower applies at the boundary between the frequency ranges.

Frequency of Emission (MHz)	Conducted limit (dB μ V)	
	Quasi-peak	Average
0.15 – 0.50	66 - 56*	56 - 46*
0.50 – 5.00	56	46
5.00 – 30.0	60	50

* Decreases with the logarithm of the frequency.

The results shown in this test report refer only to the sample(s) tested unless otherwise stated. This test report cannot be reproduced, except in full, without prior written permission of the Company.

SGS Korea Co., Ltd. (Gunpo Laboratory) 4, LS-ro 182beon-gil, Gunpo-si, Gyeonggi-do, Korea, 15807 <http://www.sgsgroup.kr>

6.3. Test Procedures

All data rates and modes were investigated for this test. The full data for the worst case data rate are reported in this section.

AC line conducted emissions from the EUT were measured according to the dictates of ANSI C63.10-2009

1. The test procedure is performed in a 6.5 m × 3.6 m × 3.6 m (L × W × H) shielded room. The EUT along with its peripherals were placed on a 1.0 m (W) × 1.5 m (L) and 0.8 m in height wooden table and the EUT was adjusted to maintain a 0.4 meter space from a vertical reference plane.
2. The EUT was connected to power mains through a line impedance stabilization network (LISN) which provides 50 ohm coupling impedance for measuring instrument and the chassis ground was bounded to the horizontal ground plane of shielded room.
3. The excess power cable between the EUT and the LISN was bundled. All connecting cables of EUT were moved to find the maximum emission.

The results shown in this test report refer only to the sample(s) tested unless otherwise stated. This test report cannot be reproduced, except in full, without prior written permission of the Company.

SGS Korea Co., Ltd. (Gunpo Laboratory) 4, LS-ro 182beon-gil, Gunpo-si, Gyeonggi-do, Korea, 15807 <http://www.sgsgroup.kr>

RTT5041-20(2015.10.01)(3)

Tel. +82 31 428 5700 / Fax. +82 31 427 2370

A4(210 mm × 297 mm)

6.4. Test Results

The following table shows the highest levels of conducted emissions on both phase of Hot and Neutral line

Ambient temperature : (23 ± 1) °C
 Relative humidity : 47 % R.H.

 Frequency range : 0.15 MHz – 30 MHz
 Measured Bandwidth : 9 kHz

FREQ. (MHz)	LEVEL(dB μ V)		LINE	LIMIT(dB μ V)		MARGIN(dB)	
	Q-Peak	Average		Q-Peak	Average	Q-Peak	Average
0.48	31.80	22.80	N	56.34	46.34	24.54	23.54
0.70	16.50	11.60	N	56.00	46.00	39.50	34.40
5.96	27.00	21.80	N	60.00	50.00	33.00	28.20
9.94	26.00	21.60	N	60.00	50.00	34.00	28.40
14.80	26.10	21.00	N	60.00	50.00	33.90	29.00
27.82	31.70	26.80	N	60.00	50.00	28.30	23.20
0.49	33.00	24.10	H	56.17	46.17	23.17	22.07
3.91	25.40	23.70	H	56.00	46.00	30.60	22.30
4.56	24.60	20.60	H	56.00	46.00	31.40	25.40
6.01	27.30	21.90	H	60.00	50.00	32.70	28.10
14.74	26.70	21.20	H	60.00	50.00	33.30	28.80
27.81	32.30	26.20	H	60.00	50.00	27.70	23.80

Remark;

- Line (H): Hot, Line (N): Neutral.
- All channel of operation were investigated and the worst-case emissions were reported using Middle channel.
- Traces shown in plot mad using a peak detector and average detector.
- The limit for Class B device(s) from 150 kHz to 30 MHz are specified in Section of the Title 47 CFR.
- Deviations to the Specifications: None.

The results shown in this test report refer only to the sample(s) tested unless otherwise stated. This test report cannot be reproduced, except in full, without prior written permission of the Company.

Plots of Conducted Power line

Test mode: (Neutral)

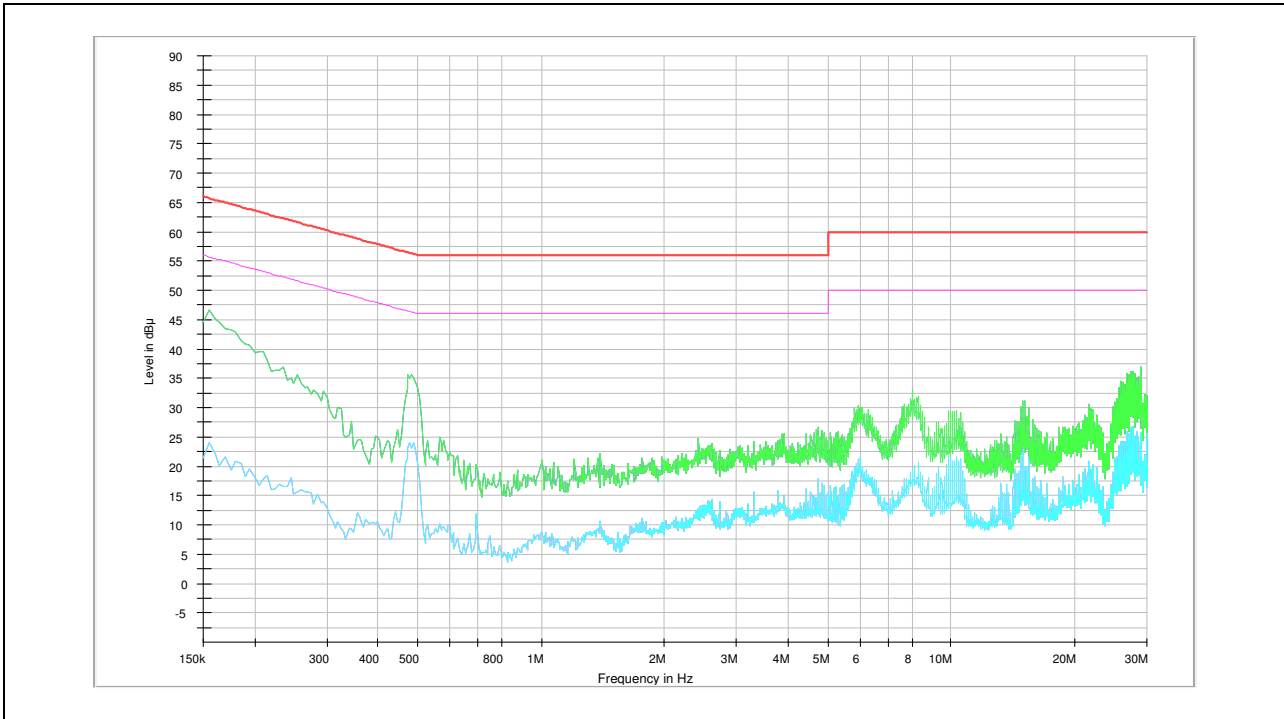

Test mode: (Hot)

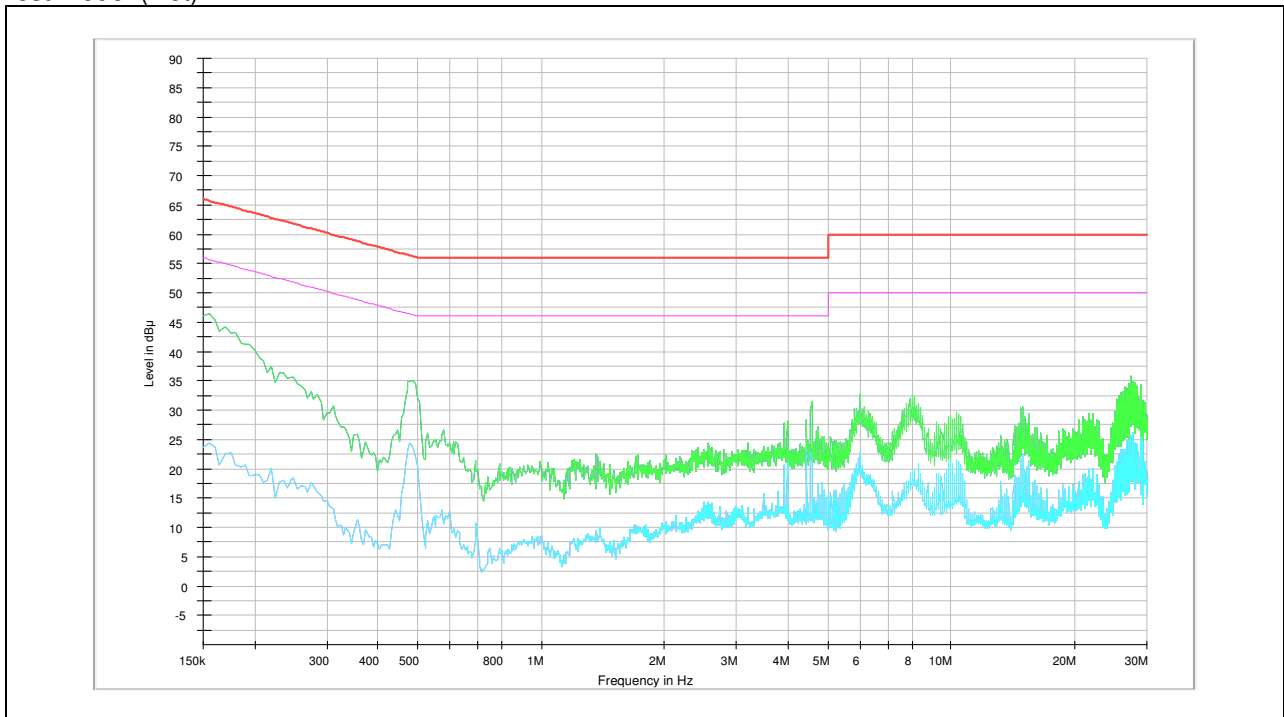

The results shown in this test report refer only to the sample(s) tested unless otherwise stated. This test report cannot be reproduced, except in full, without prior written permission of the Company.

7. Antenna Requirement

7.1. Standard Applicable

For intentional device, according to FCC 47 CFR Section §15.203, an intentional radiator shall be designed to ensure that no antenna other than that furnished by the responsible party shall be used with the device. And according to FCC 47 CFR Section §15.247 (b) if transmitting antennas of directional gain greater than 6 dB i are used, the power shall be reduced by the amount in dB that the gain of the antenna exceeds 6 dB i.

7.2. Antenna Connected Construction

Antenna used in this product is Dipole type with gain of 2.7 dB i.

The results shown in this test report refer only to the sample(s) tested unless otherwise stated. This test report cannot be reproduced, except in full, without prior written permission of the Company.

SGS Korea Co., Ltd. (Gunpo Laboratory) 4, LS-ro 182beon-gil, Gunpo-si, Gyeonggi-do, Korea, 15807 <http://www.sgsgroup.kr>

RTT5041-20(2015.10.01)(3)

Tel. +82 31 428 5700 / Fax. +82 31 427 2370

A4(210 mm x 297 mm)