

**MEASUREMENT REPORT**  
**FCC Part 30 5G mmWave**

**Applicant Name:**  
 Samsung Electronics Co., Ltd.  
 129, Samsung-ro,  
 Yeongtong-gu, Suwon-si  
 Gyeonggi-do, 16677, Korea

**Date of Testing:**  
 06/21/2021 – 08/31/2021  
**Test Site/Location:**  
 PCTEST KOREA Lab. Yongin-si, Gyeonggi-do, Korea  
**Test Report Serial No.:**  
 8K21060202-R1.A3L

<b>FCC ID:</b>	<b>A3LAT1K06-A00</b>
<b>APPLICANT:</b>	<b>Samsung Electronics Co., Ltd.</b>

**Application Type:** Class II Permissive Change  
**Model:** AT1K06-A00  
**EUT Type:** AU(AT1K06)  
**FCC Classification:** Part 30 Fixed Transmitter (5GB)  
**FCC Rule Part:** 30  
**Test Procedure(s):** ANSI C63.26-2015, KDB 971168 D01 v03r01,  
 KDB 842590 D01 v01r02

This revised Test Report (S/N: 8K21060202-R1.A3L) supersedes and replaces the previously issued test report (S/N: 8K21060202.A3L) on the same subject device for the same type of testing as indicated. Please discard or destroy the previously issued test report(s) and dispose of it accordingly.

This equipment has been shown to be capable of compliance with the applicable technical standards as indicated in the measurement report and was tested in accordance with the measurement procedures specified in §2.947. Test results reported herein relate only to the item(s) tested.



I attest to the accuracy of data. All measurements reported herein were performed by me or were made under my supervision and are correct to the best of my knowledge and belief. I assume full responsibility for the completeness of these measurements and vouch for the qualifications of all persons taking them.



Prepared by Ian.Kim  
 Test Engineer





Reviewed by Charles.Shin  
 Technical Manager

<b>FCC ID:</b> A3LAT1K06-A00		<b>MEASUREMENT REPORT</b> (Class II Permissive Change)		<b>Approved by:</b> Technical Manager
<b>Test Report S/N:</b> 8K21060202-R1.A3L	<b>Test Dates:</b> 06/21/2021-08/31/2021	<b>EUT Type:</b> AU(AT1K06)	Page 1 of 84	

## T A B L E O F C O N T E N T S

1.0	INTRODUCTION .....	3
1.1	Scope .....	3
1.2	PCTEST KOREA Test Location .....	3
1.3	Test Facility / Accreditations.....	3
2.0	PRODUCT INFORMATION.....	4
2.1	Equipment Description .....	4
2.2	Device Capabilities.....	4
2.3	Test Configuration .....	4
2.4	EMI Suppression Device(s)/Modifications .....	4
3.0	DESCRIPTION OF TESTS .....	5
3.1	Measurement Procedure.....	5
3.2	Radiated Power and Radiated Spurious Emissions .....	5
4.0	MEASUREMENT UNCERTAINTY .....	8
5.0	TEST EQUIPMENT CALIBRATION DATA .....	9
6.0	SAMPLE CALCULATIONS .....	10
7.0	TEST RESULTS.....	11
7.1	Summary.....	11
7.2	Occupied Bandwidth .....	12
7.3	Equivalent Isotropic Radiated Power (EIRP) Density .....	17
7.4	RF Conducted Output Power .....	28
7.5	Radiated Spurious and Harmonic Emissions .....	31
7.6	Band Edge Emissions .....	69
7.7	Frequency Stability / Temperature Variation .....	77
8.0	CONCLUSION.....	80
9.0	APPENDIX A .....	81
9.1	HARMONIC MIXER Verification Certificate.....	81

<b>FCC ID:</b> A3LAT1K06-A00	 <b>MEASUREMENT REPORT</b> (Class II Permissive Change)		<b>Approved by:</b> Technical Manager
<b>Test Report S/N:</b> 8K21060202-R1.A3L	<b>Test Dates:</b> 06/21/2021-08/31/2021	<b>EUT Type:</b> AU(AT1K06)	Page 2 of 84

## 1.0 INTRODUCTION

### 1.1 Scope

Measurement and determination of electromagnetic emissions (EMC) of radio frequency devices including intentional and/or unintentional radiators for compliance with the technical rules and regulations of the Federal Communications Commission and the Innovation, Science and Economic Development Canada.



### 1.2 PCTEST KOREA Test Location

These measurement tests were conducted at the PCTEST KOREA CO., LTD. facility located at (#1407) 13, Heungdeok 1-ro, Giheung-gu, Yongin-si, Gyeonggi-do 16954, Korea.

### 1.3 Test Facility / Accreditations

Measurements were performed at PCTEST KOREA Lab located in Yongin-si, Gyeonggi, Korea.

- PCTEST KOREA is an ISO 17025:2005 accredited test facility under the National Institute of Standards and Technology (NIST) with Certificate number 600143-0 for Specific Absorption Rate (SAR), where applicable, and Electromagnetic Compatibility (EMC) testing for FCC and Innovation, Science, and Economic Development Canada rules.
- PCTEST KOREA facility is accredited and designated in accordance with the provision of Radio Wave Act and International Standard ISO/IEC 17025:2017 under the National Radio Research Agency.
  - Designation Number: KR0169
  - Test Firm Registration Number: 417945

FCC ID: A3LAT1K06-A00	 PCTEST® Proud to be part of element	MEASUREMENT REPORT (Class II Permissive Change)		Approved by: Technical Manager
Test Report S/N: 8K21060202-R1.A3L	Test Dates: 06/21/2021-08/31/2021	EUT Type: AU(AT1K06)		Page 3 of 84

## 2.0 PRODUCT INFORMATION

### 2.1 Equipment Description

The Equipment Under Test (EUT) is the **Samsung 5G Access Unit FCC ID: A3LAT1K06-A00**. The test data contained in this report pertains only to the emissions due to the EUT's 5G mmWave function.

The EUT supports 100 MHz bandwidth. The EUT supports multiple component carrier configuration which also supports for contiguous and non-contiguous transmit condition.

The EUT operates as a 4X4 MIMO system that consists of four antenna arrays (denoted herein as "Antenna A", "Antenna B", "Antenna C" and "Antenna D". Each of the four antenna arrays has 256 antenna elements for a total of 1024 antenna elements. Of the 4 antenna arrays, Antenna A and Antenna C have the same polarization (135 degrees from horizontal) and Antenna B and Antenna D have the same polarization (45 degrees from horizontal). Beamforming is used with Antenna A and Antenna C and it is also used with Antenna B and Antenna D. Signal correlation is possible between the outputs of all four antenna arrays.

The unit is powered by a nominal AC voltage source.

See Section 3.2 for the antenna polarization of the 5G Access Unit and the measurement antenna.

**Test Device Serial No.:** EP96-05810A

### 2.2 Device Capabilities

This device contains the following capabilities:



5G NR (n260) with multiple configurations of operation as below:  
 100 MHz bandwidth with single component carrier  
 100 MHz bandwidth with up to 8 contiguous component carrier  
 100 MHz bandwidth with up to 8 Non-contiguous component carrier  
 The device is supports QPSK, 16QAM and 64QAM of CP-OFDM.

### 2.3 Test Configuration

The EUT was tested per the guidance of KDB 842590 D01 v01r02 and ANSI C63.26-2015. See Section 7.0 of this test report for a description of the radiated tests.

### 2.4 EMI Suppression Device(s)/Modifications

No EMI suppression device(s) were added and no modifications were made during testing.

FCC ID: A3LAT1K06-A00		MEASUREMENT REPORT (Class II Permissive Change)		Approved by: Technical Manager
Test Report S/N: 8K21060202-R1.A3L	Test Dates: 06/21/2021-08/31/2021	EUT Type: AU(AT1K06)		Page 4 of 84

## 3.0 DESCRIPTION OF TESTS

### 3.1 Measurement Procedure

The measurement procedures described in the document titled “American National Standard for Compliance Testing of Transmitter Used in Licensed Radio Service” (ANSI C63.26-2015) and the guidance provided in KDB 842590 D01 v01r02 were used in the measurement of the EUT.

### 3.2 Radiated Power and Radiated Spurious Emissions

#### §30.202, §30.203

The radiated test facilities consisted of an indoor 3 meter semi-anechoic chamber used for Final measurement and exploratory measurements, when necessary. The measurement area is contained within the semi-anechoic chamber which is shielded from any ambient interference. The test site inside the chamber is a 8.5 m(L) x 6.1 m(W) x 5.6 m(H) elliptical, obstruction-free area in accordance with Figure 5.7 of Clause 5 in ANSI C63.4-2014. Absorbers are arranged on the floor between the turn table and the antenna mast in such a way so as to maximize the reduction of reflections for measurements above 1 GHz. For measurements below 1 GHz, the absorbers are removed. A raised turntable is used for radiated measurement. The turn table is a continuously rotatable, remote-controlled, metallic turntable and 2 meters (6.56 ft.) in diameter. The turn table is flush with the raised floor of the chamber in order to maintain its function as a ground plane. An 80 cm tall test table made of Styrodur is placed on top of the turn table. A Styrodur pedestal is placed on top of the test table to bring the total table height to 1.5 m.



Made of Styrodur is placed on top of the turn table. A Styrodur pedestal is placed on top of the test table to bring the total table height to 1.5 m for measurements above 1 GHz.

The equipment under test was transmitting while connected to its integral antenna and is placed on a turntable. The measurement antenna is in the far field of the EUT per formula  $2D^2/\lambda$  where D is the larger between the dimension of the measurement antenna and the transmitting antenna of the EUT. In this case, “D” is the largest dimension of the measurement antenna. The EUT is manipulated through all orthogonal planes representative of its typical use to achieve the highest reading on the receive spectrum analyzer.

Frequency Range [GHz]	Wavelength [cm]	Far Field Distance [m]	Measurements Distance [m]
18 to 40	0.749	2.61	2.61
40 to 60	0.500	1.39	2.61
60 to 90	0.333	0.91	2.61
90 to 140	0.214	0.58	1.00
140 to 220	0.150	0.39	1.00

**Table 3-1. Far-Field Distance & Measurement Distance per Frequency Range**

Radiated power levels are investigated with the receive antenna horizontally and vertically polarized. Additionally, the receive antenna was rotated on various angles to investigate worst case emissions on each EUT antenna array. The EUT antenna array polarization and horn antennas angle are denoted as follows:

FCC ID: A3LAT1K06-A00	 PCTEST Proud to be part of element	MEASUREMENT REPORT (Class II Permissive Change)		Approved by: Technical Manager
Test Report S/N: 8K21060202-R1.A3L	Test Dates: 06/21/2021-08/31/2021	EUT Type: AU(AT1K06)		Page 5 of 84

**Horn antenna at 135 degrees**

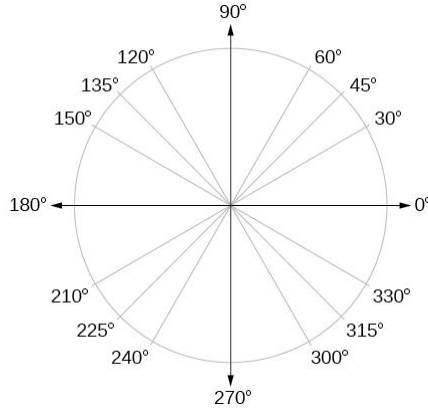
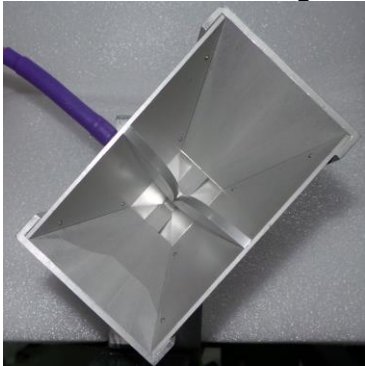

**Horn antenna at 45 degrees**

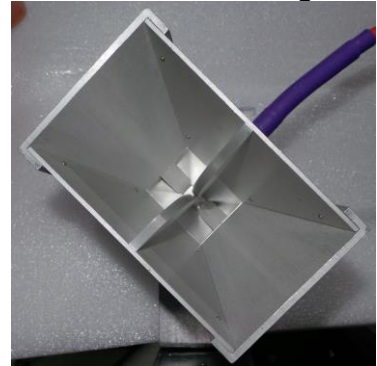

**5G Access Unit Antenna Array Polarization**

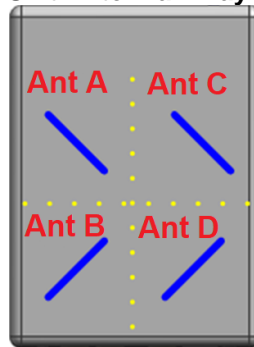

The maximized power level is recorded using the spectrum analyzer “Channel Power” function with the integration band set to the emissions’ occupied bandwidth. The EIRP is calculated from the raw power level measured with the spectrum analyzer using the formulas shown below.

**Effective Isotropic Radiated Power Sample Calculation**

The measured e.i.r.p is converted to E-field in V/m. Then the distance correction is applied before converted back to calculated e.i.r.p.as explained in KDB 971168 D01.

**Field Strength [dB V/m]** = Measured Value (dBm) + AFCL (dB/m) + 107  
 = -16.01 dBm + (42.91 dB/m + 13.26 dB) + 107 = 147.16 dBuV/m  
 = 10^(147.16/20)/1000000  
 = 22.80 V/m

**e.i.r.p. (dBm)** = 10\*log(E-Field\*D<sub>m</sub>)^2/30) + 30 dB  
 = 10\*log(22.80 V/m \* 2.61 m)^2/30) + 30 dB  
 = 50.72 dBm e.i.r.p.

<b>FCC ID:</b> A3LAT1K06-A00		<b>MEASUREMENT REPORT</b> (Class II Permissive Change)		<b>Approved by:</b> Technical Manager
<b>Test Report S/N:</b> 8K21060202-R1.A3L	<b>Test Dates:</b> 06/21/2021-08/31/2021	<b>EUT Type:</b> AU(AT1K06)		Page 6 of 84

### Sample MIMO e.i.r.p. Calculation:



The e.i.r.p at Antenna A, Antenna B, Antenna C and Antenna D were first measured individually. The measured values were then summed in linear power units then converted back to dBm for the co-polarized antennas.

$$\text{Conversion to linear value} = 10^{(e.i.r.p./10)} = 10^{(50.69/10)} = 118032 \text{ mW}$$

$$\begin{aligned} \text{MIMO e.i.r.p.} &= e.i.r.p._A + e.i.r.p._c \\ &= 118032 \text{ mW} + 110407 \text{ mW} \\ &= 10 \cdot \log(228439 \text{ mW}) \\ &= 53.59 \text{ dBm} \end{aligned}$$

For summation across all antennas,



$$\begin{aligned} \text{MIMO e.i.r.p.} &= e.i.r.p._A + e.i.r.p._B + e.i.r.p._c + e.i.r.p._D \\ &= 118032 \text{ mW} + 121898 \text{ mW} + 110407 \text{ mW} + 123026 \text{ mW} \\ &= 10 \cdot \log(473363 \text{ mW}) \\ &= 56.75 \text{ dBm} \end{aligned}$$

FCC ID: A3LAT1K06-A00		<b>MEASUREMENT REPORT</b> <b>(Class II Permissive Change)</b>		<b>Approved by:</b> Technical Manager
<b>Test Report S/N:</b> 8K21060202-R1.A3L	<b>Test Dates:</b> 06/21/2021-08/31/2021	<b>EUT Type:</b> AU(AT1K06)	Page 7 of 84	

## 4.0 MEASUREMENT UNCERTAINTY

The measurement uncertainties shown below were calculated in accordance with the requirements of ANSI C63.4-2014. All measurement uncertainty values are shown with a coverage factor of  $k = 2$  to indicate a 95% level of confidence. The measurement uncertainty shown below meets or exceeds the  $U_{CISPR}$  measurement uncertainty values specified in CISPR 16-4-2 and, thus, can be compared directly to specified limits to determine compliance.

Contribution	Expanded Uncertainty ( $\pm$ dB)
Conducted Bench Top Measurements	1.20
Radiated Disturbance (<1GHz)	3.01
Radiated Disturbance (>1GHz)	5.56
Radiated Disturbance (>18GHz)	3.16

FCC ID: A3LAT1K06-A00	 PCTEST® Proud to be part of element	MEASUREMENT REPORT (Class II Permissive Change)		Approved by: Technical Manager
Test Report S/N: 8K21060202-R1.A3L	Test Dates: 06/21/2021-08/31/2021	EUT Type: AU(AT1K06)		Page 8 of 84



## 5.0 TEST EQUIPMENT CALIBRATION DATA



Test Equipment Calibration is traceable to the National Institute of Standards and Technology (NIST). Measurements antennas used during testing were calibrated in accordance to the requirements of ANSI C63.5-2017.

Manufacture	Model	Description	Cal Date	Cal interval	Cal Due	Serial Number
Rohde & Schwarz	FSW	Signal & Spectrum Analyzer	09/17/2020	Annual	09/16/2021	101250
KIKISUI	PWR1201ML	DC POWER SUPPLY	05/25/2021	Annual	05/24/2022	ZL000972
SUKSAN TECHNOLOGY	SE-CT-10	Temperature Chamber	09/17/2020	Annual	09/16/2021	191021
Schwarzbeck	VULB9162	Broadband TRILOG Antenna	07/13/2021	Biennial	07/12/2023	9162-217
Sunol sciences	DRH-118	Horn Antenna	07/14/2021	Biennial	07/13/2023	A102416-1
Schwarzbeck	BBHA 9170	Horn Antenna	09/02/2020	Biennial	09/01/2022	1037
MIWV	261F-25/387	Horn Antenna	07/13/2021	Annual	07/12/2022	2019
MIWV	261U-25/383	Horn Antenna	07/13/2021	Annual	07/12/2022	2019
MIWV	261G-25/387	Horn Antenna	07/19/2021	Annual	07/18/2022	-
MIWV	261E-25/387	Horn Antenna	07/13/2021	Annual	07/12/2022	2019
Radiometer Physics	FS-Z220	Harmonic Mixer	10/21/2020	Annual	10/20/2021	101015
Radiometer Physics	FS-Z140	Harmonic Mixer	03/08/2021	Annual	03/07/2022	101135
Radiometer Physics	FS-Z60	Harmonic Mixer	03/08/2021	Annual	03/07/2022	100981
Rohde & Schwarz	FS-Z90	Harmonic Mixer	10/21/2020	Annual	10/20/2021	101860

**Table 5-1. Test Equipment**

### Notes:

For equipment listed above that has a calibration date or calibration due date that falls within the test date range, care was taken to ensure that this equipment was used after the calibration date and before the calibration due date.

FCC ID: A3LAT1K06-A00		MEASUREMENT REPORT (Class II Permissive Change)		Approved by: Technical Manager
Test Report S/N: 8K21060202-R1.A3L	Test Dates: 06/21/2021-08/31/2021	EUT Type: AU(AT1K06)		Page 9 of 84

## 6.0 SAMPLE CALCULATIONS

### Emission Designator

#### QPSK Modulation

**Emission Designator = 800MG7D**

BW = 800 MHz

G = Phase Modulation

7 = Quantized/Digital Info

D = Data transmission, telemetry, telecommand

#### QAM Modulation



**Emission Designator = 802MW7D**

BW = 802 MHz

W = Amplitude/Angle Modulated

7 = Quantized/Digital Info

D = Data transmission, telemetry, telecommand

<b>FCC ID:</b> A3LAT1K06-A00		<b>MEASUREMENT REPORT (Class II Permissive Change)</b>		<b>Approved by:</b> Technical Manager
<b>Test Report S/N:</b> 8K21060202-R1.A3L	<b>Test Dates:</b> 06/21/2021-08/31/2021	<b>EUT Type:</b> AU(AT1K06)	Page 10 of 84	

## 7.0 TEST RESULTS

### 7.1 Summary



Company Name: Samsung Electronics Co., Ltd.  
 FCC ID: A3LAT1K06-A00  
 FCC Classification: Part 30 Fixed Transmitter (5GB)  
 Mode(s): TDD

FCC Part Section(s)	Test Description	Test Limit	Test Condition	Test Result	Reference
2.1049	Occupied Bandwidth	N/A	RADIATED	PASS	Section 7.2
30.202	Equivalent Isotropic Radiated Power Density	75 dBm/100 MHz		PASS	Section 7.3
2.1046	RF Output Power	N/A		PASS	Section 7.4
2.1051 30.203	Out-of-Band Spurious Emissions	-13 dBm/MHz for all out-of-band emissions		PASS	Section 7.5
2.1051 30.203	Out-of-Band Emissions at the Band Edge	-13 dBm/MHz for all out-of-band emissions, -5 dBm/MHz from the band edge up to 10 % of the channel BW		PASS	Section 7.6
2.1055	Frequency Stability	Fundamental emissions stay within authorized frequency block		PASS	Section 7.7

**Table 7-1. Summary of Radiated Test Results**

#### Notes:

- For comparison with the original authorization, the testing was performed on the worst case of the original test results
- Per 2.1057(a)(3), spurious emissions were investigated up to 100 GHz for n261 and up to 200 GHz for n260.
- All radiated emission measurements at the band edge are converted to an equivalent conductive power by subtracting the known antenna gain from the EIRP measured at each frequency of interest. These emissions are compared to the 30.203 spurious emission limits as conductive power levels.
- The radiated RF output power and all out-of-band emissions in the spurious domain are evaluated to the EIRP limits.
- The fundamental band consists of 1 – 8 component carriers, referred as “CC” in this report.
- In the following tables, the term “CCs Active” refers to which component carrier is transmitting for a particular test.
- CCs active 1, 8 = 1 Components Carriers Active Channel, 8 = 8 Component Carriers Active. 8(NC) = 8 Non-contiguous Component Carriers Active. Each component carrier is 100 MHz bandwidth.

FCC ID: A3LAT1K06-A00	 PCTEST Proud to be part of element	MEASUREMENT REPORT (Class II Permissive Change)		Approved by: Technical Manager
Test Report S/N: 8K21060202-R1.A3L	Test Dates: 06/21/2021-08/31/2021	EUT Type: AU(AT1K06)	Page 11 of 84	

## 7.2 Occupied Bandwidth

### §2.1049

#### Test Overview

The occupied bandwidth, that is the frequency bandwidth such that, below its lower and above its upper frequency limits, the mean powers radiated are each equal to 0.5 % of the total mean power radiated by a given emission shall be measured. All modes of operation were investigated and the worst case configuration results are reported in this section.

#### Test Procedure Used



ANSI C63.25-2015 Section 5.4.3  
KDB 842590 D01 v01r02 Section 4.3

#### Test Settings

1. The signal analyzer's automatic bandwidth measurement capability was used to perform the 99 % occupied bandwidth. The bandwidth measurement was not influenced by any intermediate power nulls in the fundamental emission.
2. RBW = 1 – 5 % of the expected OBW
3. VBW  $\geq$  3 x RBW
4. Detector = Peak
5. Trace mode = max hold
6. Sweep = auto couple
7. The trace was allowed to stabilize
8. If necessary, steps 2 – 7 were repeated after changing the RBW such that it would be within 1 – 5 % of the 99 % occupied bandwidth observed in Step 7

#### Test Notes

1. For comparison with the original authorization, the testing was performed on the worst case of the original test results.

FCC ID: A3LAT1K06-A00		MEASUREMENT REPORT (Class II Permissive Change)		Approved by: Technical Manager
Test Report S/N: 8K21060202-R1.A3L	Test Dates: 06/21/2021-08/31/2021	EUT Type: AU(AT1K06)	Page 12 of 84	

## 7.2.1 Antenna A Occupied Bandwidth

Bandwidth [MHz]	Channel	Antenna	CCs active	Modulation	OBW [MHz]
100	Mid	A	1	64QAM	94.49
			8	16QAM	789.90

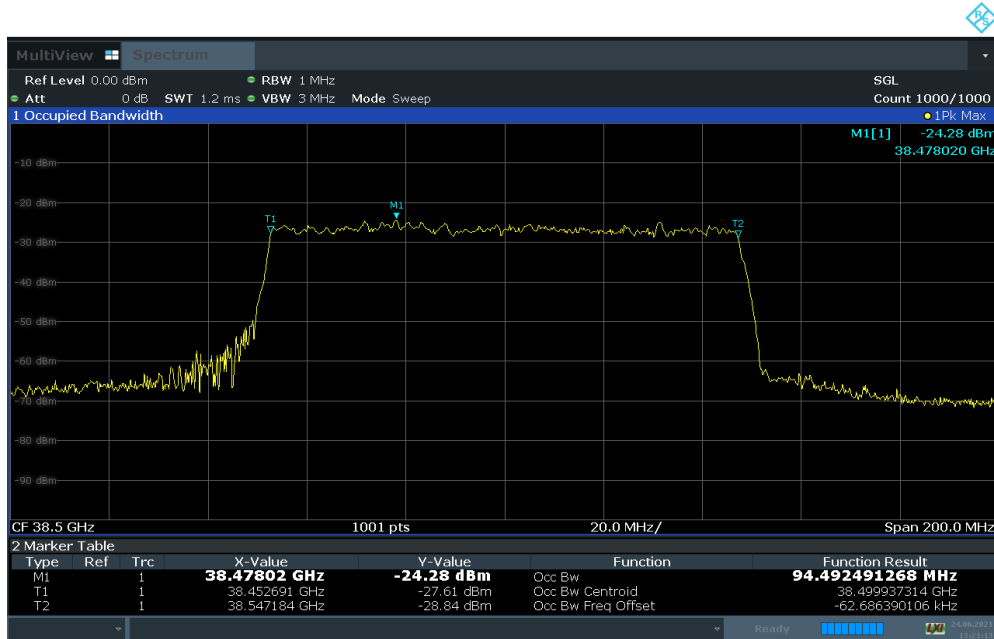

Table 7-2. Antenna A Occupied Bandwidth Summary Data

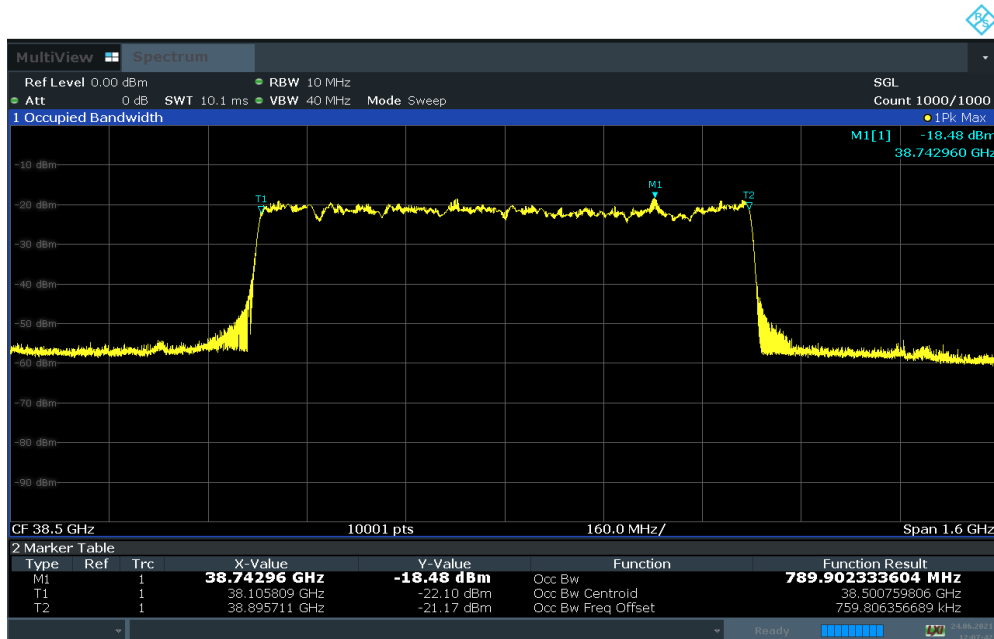

Plot 7-1. Occupied Bandwidth Plot (100 MHz BW 1CC 64QAM Mid Channel)



Plot 7-2. Occupied Bandwidth Plot (100 MHz BW 8CC 16QAM Mid Channel)

FCC ID: A3LAT1K06-A00		MEASUREMENT REPORT (Class II Permissive Change)		Approved by: Technical Manager
Test Report S/N: 8K21060202-R1.A3L	Test Dates: 06/21/2021-08/31/2021	EUT Type: AU(AT1K06)		Page 13 of 84

## 7.2.2 Antenna B Occupied Bandwidth

Bandwidth [MHz]	Channel	Antenna	CCs active	Modulation	OBW [MHz]
100	Mid	B	1	64QAM	94.49
			8	16QAM	789.80

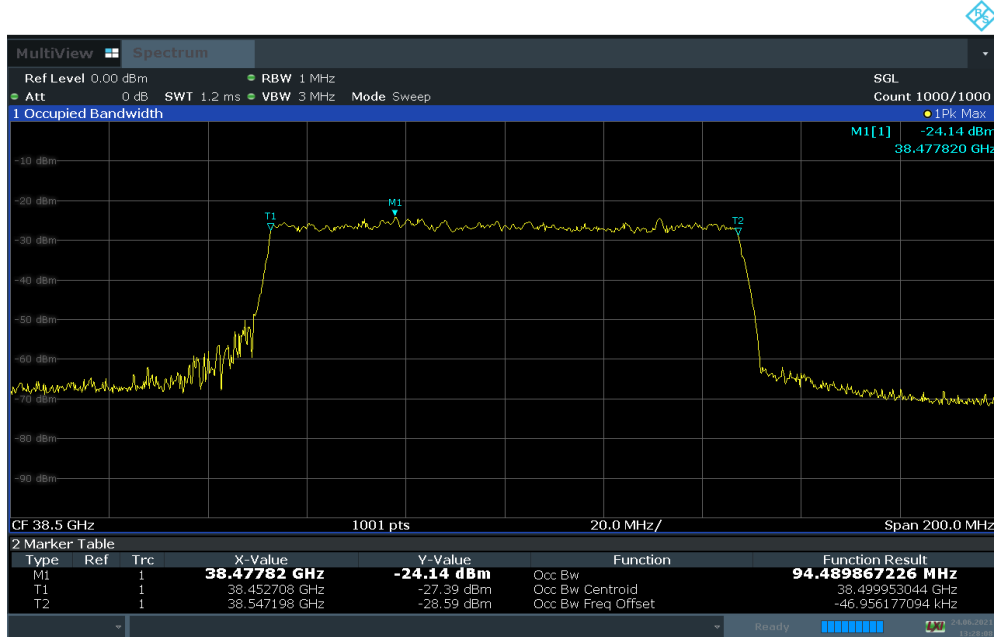

Table 7-3. Antenna B Occupied Bandwidth Summary Data

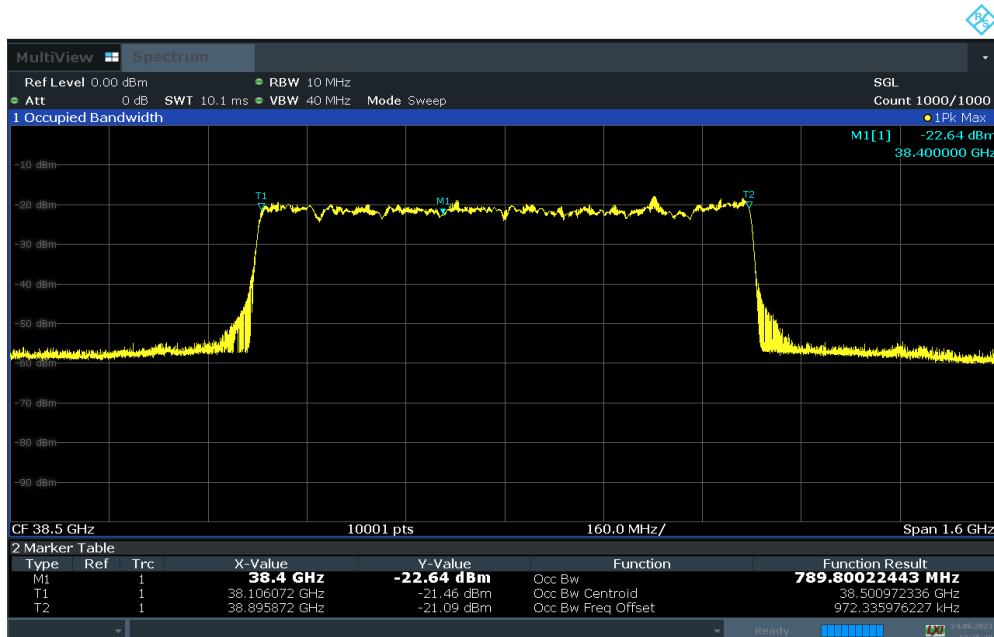

Plot 7-3. Occupied Bandwidth Plot (100 MHz BW 1CC 64QAM Mid Channel)



Plot 7-4. Occupied Bandwidth Plot (100 MHz BW 8CC 16QAM Mid Channel)

FCC ID: A3LAT1K06-A00		MEASUREMENT REPORT (Class II Permissive Change)		Approved by: Technical Manager
Test Report S/N: 8K21060202-R1.A3L	Test Dates: 06/21/2021-08/31/2021	EUT Type: AU(AT1K06)		Page 14 of 84

### 7.2.3 Antenna C Occupied Bandwidth

Bandwidth [MHz]	Channel	Antenna	CCs active	Modulation	OBW [MHz]
100	Mid	C	1	64QAM	94.47
			8	16QAM	789.73

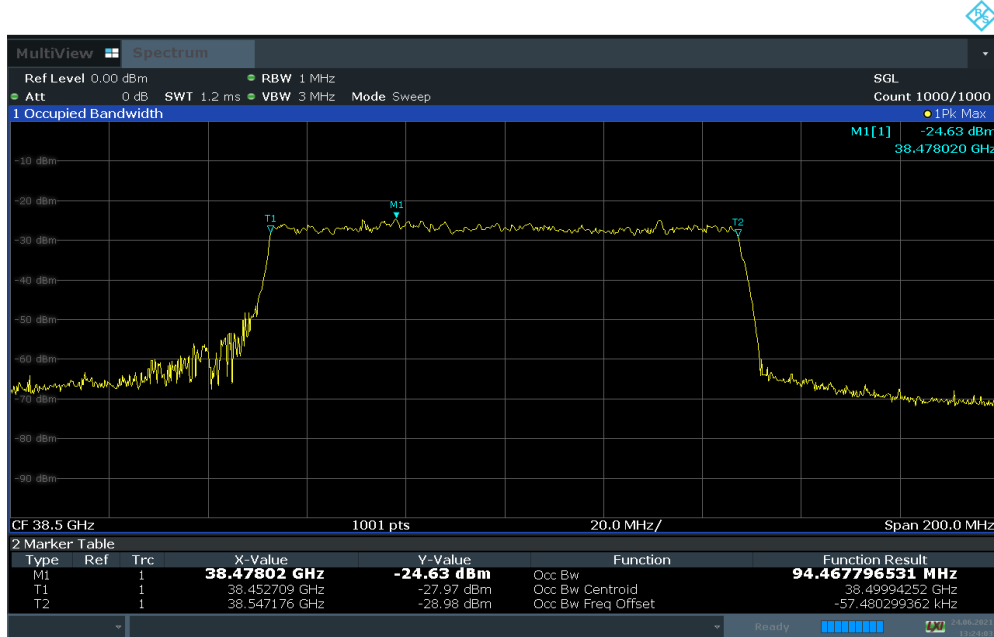

Table 7-4. Antenna C Occupied Bandwidth Summary Data

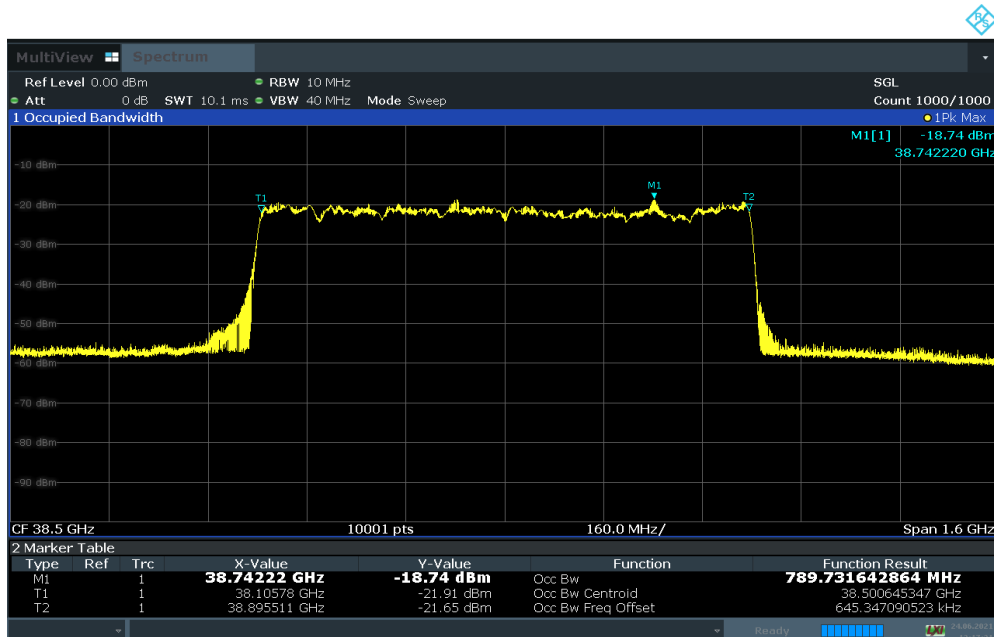

Plot 7-5. Occupied Bandwidth Plot (100 MHz BW 1CC 64QAM Mid Channel)



Plot 7-6. Occupied Bandwidth Plot (100 MHz BW 8CC 16QAM Mid Channel)

FCC ID: A3LAT1K06-A00		MEASUREMENT REPORT (Class II Permissive Change)		Approved by: Technical Manager
Test Report S/N: 8K21060202-R1.A3L	Test Dates: 06/21/2021-08/31/2021	EUT Type: AU(AT1K06)		Page 15 of 84

## 7.2.4 Antenna D Occupied Bandwidth

Bandwidth [MHz]	Channel	Antenna	CCs active	Modulation	OBW [MHz]
100	Mid	D	1	64QAM	94.47
			8	16QAM	789.85

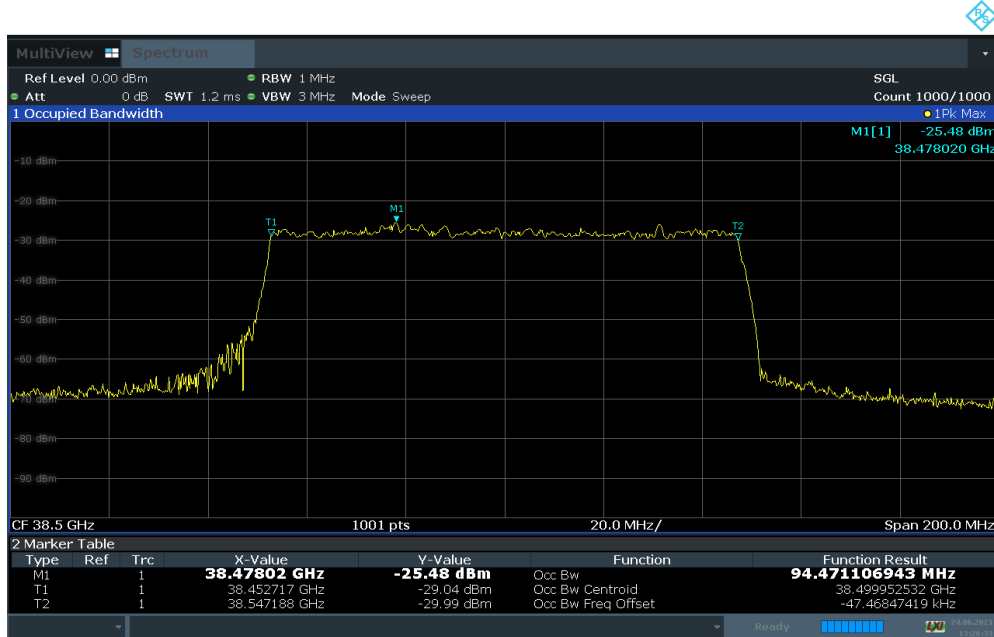

Table 7-5. Antenna D Occupied Bandwidth Summary Data

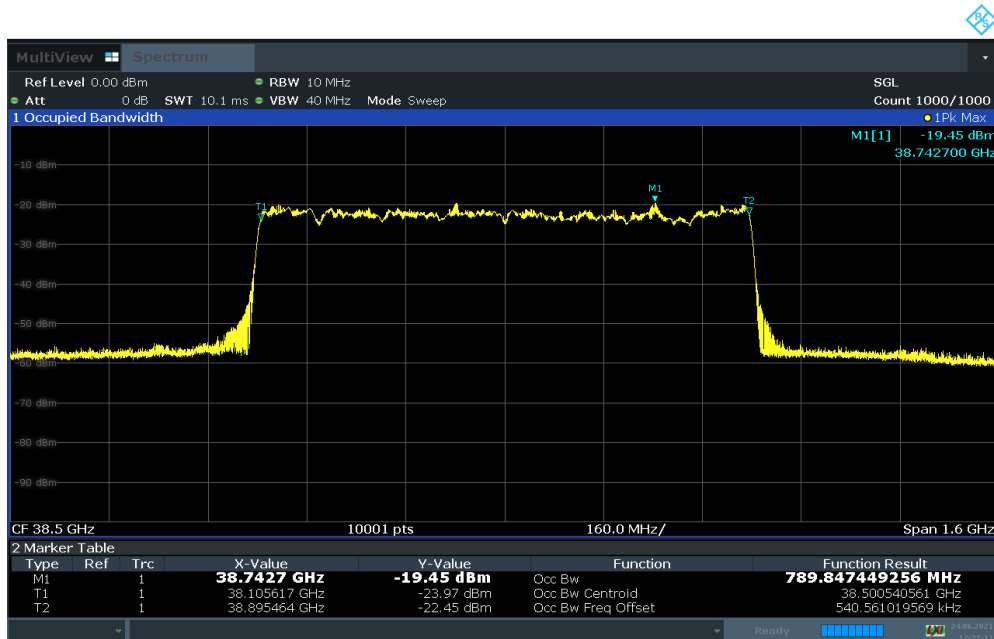

Plot 7-7. Occupied Bandwidth Plot (100 MHz BW 1CC 64QAM Mid Channel)



Plot 7-8. Occupied Bandwidth Plot (100 MHz BW 8CC 16QAM Mid Channel)

FCC ID: A3LAT1K06-A00		MEASUREMENT REPORT (Class II Permissive Change)		Approved by: Technical Manager
Test Report S/N: 8K21060202-R1.A3L	Test Dates: 06/21/2021-08/31/2021	EUT Type: AU(AT1K06)		Page 16 of 84



## 7.3 Equivalent Isotropic Radiated Power (EIRP) Density

§2.1046 §30.202

### Test Overview

Equivalent Isotropic Radiated Power (EIRP) measurements are performed using broadband horn antennas. All measurements are performed as RMS average measurements while the EUT is operating at its maximum duty cycle, at maximum power, and at the appropriate frequencies.



***The average power of the sum of all antenna elements is limited to an equivalent isotopically radiated power (EIRP) density of +75 dBm / 100 MHz.***

### Test Procedures Used

ANSI C63.26-2015 Section 5.2.4.4.1  
ANSI C63.26-2015 Section 6.4  
KDB 842590 D01 v01r02 Section 4.2

### Test Settings

1. Radiated power measurements are performed using the signal analyzer's "channel power" measurement capability for signals with continuous operation.
2. RBW = 1 – 5 % of the expected OBW, not to exceed 1 MHz
3. VBW  $\geq$  3 x RBW
4. Span = 2x to 3x the OBW
5. No. of sweep points  $\geq$  2 x span / RBW
6. Detector = RMS
7. The integration bandwidth was roughly set equal to the measured (EIRP) Density of the signal for signals with continuous operation. For signals with burst transmission, the "gating" function was enabled to ensure that measurements are performed during times in which the transmitter is operating at its maximum power
8. Trace mode = trace averaging (RMS) over 100 sweeps
9. The trace was allowed to stabilize

FCC ID: A3LAT1K06-A00	 PCTEST® Proud to be part of element	MEASUREMENT REPORT (Class II Permissive Change)		Approved by: Technical Manager
Test Report S/N: 8K21060202-R1.A3L	Test Dates: 06/21/2021-08/31/2021	EUT Type: AU(AT1K06)		Page 17 of 84

## Test Notes

- 1) For comparison with the original authorization, the testing was performed on the worst case of the original test results.
- 2) For multiple carrier configuration, the highest value among all carrier powers was taken.
- 3) The EUT was tested while positioned upright and mounted on a mast at 1.5 m height. The worst case emissions are reported with the EUT in this fixed position and with the modulations and active component carriers shown in the tables below.
- 4) The EIRP measurements of the co-polarized antenna arrays (Antenna A/C and Antenna B/D) were added together to address MIMO concerns referenced in ANSI C63.26-2015 Section 6.4.
- 5) Elements within the same antenna array are correlated to produce beamforming array gain. During testing, only one antenna array was active.
- 6) Measurements were taken in the far field of the mmWave signal based on the formula:  $R \geq 2D^2/\text{wavelength}$ .
- 7) The test case with from 1CC to 8CC active, was selected for the worst case emission testing as it created the highest EIRP within 100 MHz bandwidth carrier configurations.
- 8) The average EIRP reported below is calculate per section 5.2.7 of ANSI C63.26-2015 which states:
- 9)  $EIRP \text{ (dBm)} = E \text{ (dBuV/m)} + 20\log(D) - 104.8$ ; where D is the measurement distance (in the far field region) in m. For this section, all EIRP density measurements were performed at a distance of 3.20 m, so, the effective correction is:



$$\begin{aligned}
 EIRP \text{ (dBm)} &= E \text{ (dBuV/m)} - 96.46 \text{ dB} \\
 &= \text{Analyzer Level (dBm)} + \text{AFCL (dB/m)} + 107 - 96.46 \text{ dB} \\
 &= \text{Analyzer Level (dBm)} + \text{AFCL (dB/m)} + 12.30
 \end{aligned}$$

\*AFCL (dB/m) contains measurement antenna factor(dB/m) and cable loss(dB) as below:

Frequency [GHz]	Antenna Factor (dB/m)	Cable loss [dB]	Distance factor [dB]	AFCL (dB/m)
37.05	42.91	9.55	12.30	64.76
38.50	43.70	9.76	12.30	65.76
39.95	44.43	9.77	12.30	66.50

**Table 7-6. Adopted AFCL value in the calculation**

- 10) The angle of the horn antenna was rotated to maximize and find the worst case emissions. Worst case EIRP is reported below.

FCC ID: A3LAT1K06-A00		MEASUREMENT REPORT (Class II Permissive Change)		Approved by: Technical Manager
Test Report S/N: 8K21060202-R1.A3L	Test Dates: 06/21/2021-08/31/2021	EUT Type: AU(AT1K06)		Page 18 of 84

### 7.3.1 Antenna A EIRP Density

Antenna	Bandwidth	Configuration	Chan.	Frequency	Modulation	Analyzer Level	AFCL	Average e.i.r.p PSD	PSD Limit	Margin
	[MHz]			[GHz]		[dBm]	[dBm]	[dBm/100MHz]	[dBm/100MHz]	[dB]
A	100	1CC	Low	37.050	64QAM	-14.65	64.76	50.11	75.00	24.89
	100	8CC	Low	37.050	64QAM	-20.06	64.76	44.70	75.00	30.30
	100	8NC	High	39.950	64QAM	-20.87	66.50	45.63	75.00	29.37

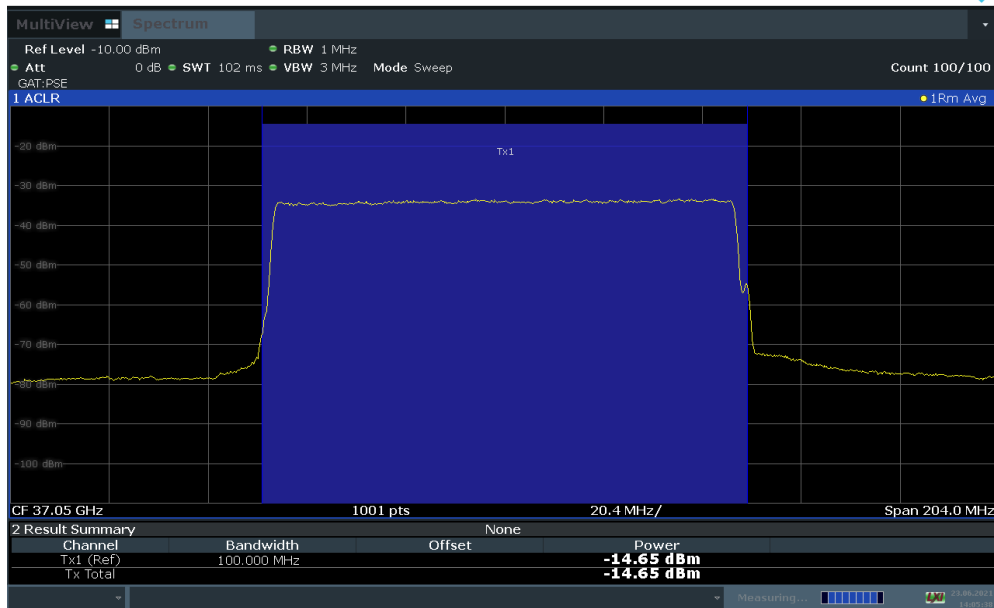

Table 7-7. Antenna A EIRP Density Summary Data

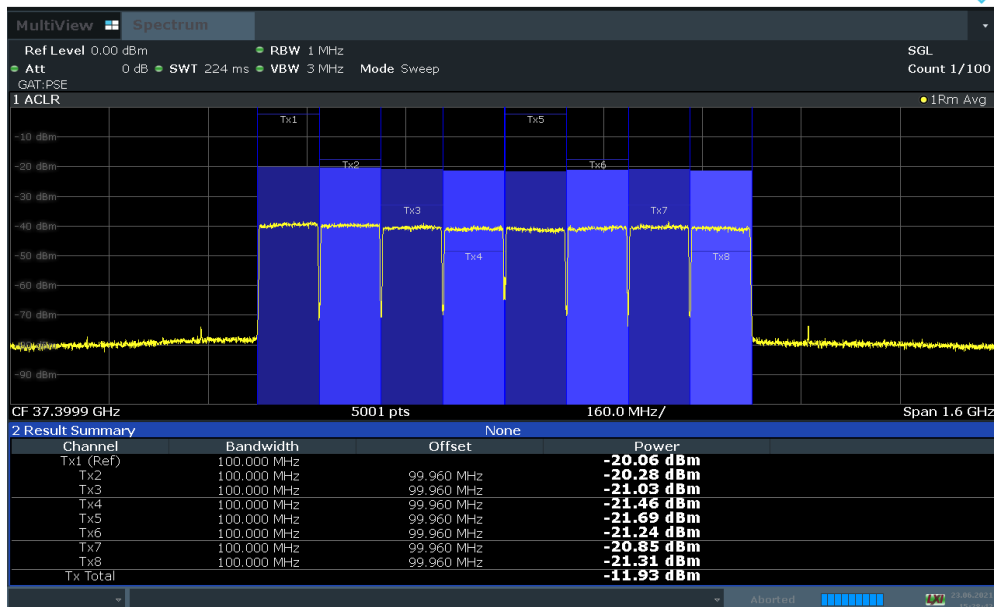

Plot 7-9. Antenna A EIRP Density Plot (100 MHz BW 1CC 64QAM Low Channel)



Plot 7-10. Antenna A EIRP Density Plot (100 MHz BW 8CC 64QAM Low Channel)

FCC ID: A3LAT1K06-A00		MEASUREMENT REPORT (Class II Permissive Change)		Approved by: Technical Manager
Test Report S/N: 8K21060202-R1.A3L	Test Dates: 06/21/2021-08/31/2021	EUT Type: AU(AT1K06)		Page 19 of 84

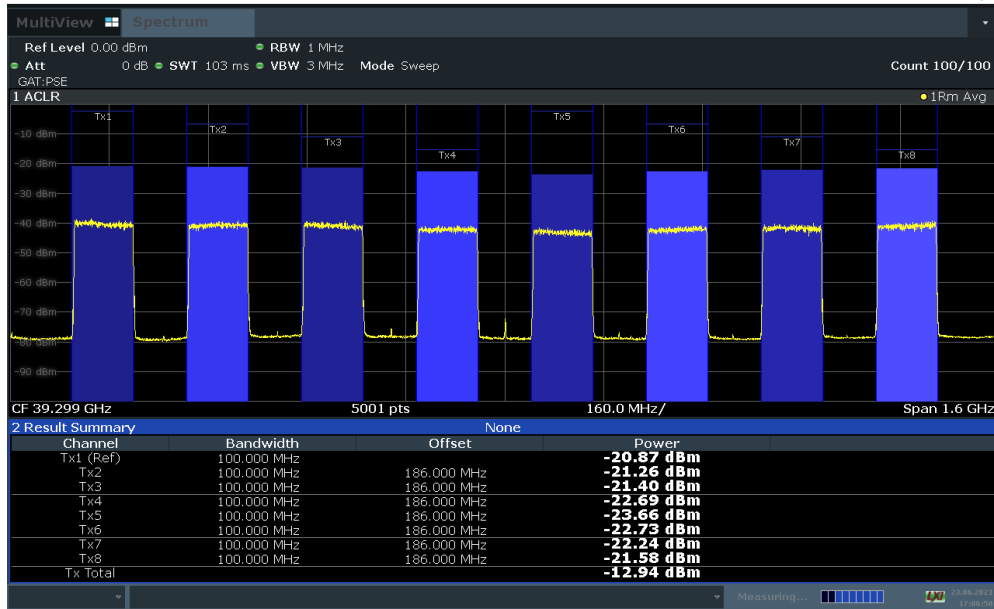

**Plot 7-11. Antenna A EIRP Density Plot (100 MHz BW 8NC 64QAM High Channel)**

FCC ID: A3LAT1K06-A00	<b>PCTEST</b> Proud to be part of element	<b>MEASUREMENT REPORT</b> (Class II Permissive Change)	<b>SAMSUNG</b>	Approved by: Technical Manager
Test Report S/N: 8K21060202-R1.A3L	Test Dates: 06/21/2021-08/31/2021	EUT Type: AU(AT1K06)		Page 20 of 84

### 7.3.2 Antenna B EIRP Density

Antenna	Bandwidth	Configuration	Chan.	Frequency	Modulation	Analyzer Level	AFCL	Average e.i.r.p PSD	PSD Limit	Margin
	[MHz]			[GHz]		[dBm]	[dBm]	[dBm/100MHz]	[dBm/100MHz]	[dB]
B	100	1CC	Low	37.050	64QAM	-14.43	64.76	50.33	75.00	24.67
	100	8CC	Low	37.050	64QAM	-19.88	64.76	44.88	75.00	30.12
	100	8NC	High	39.950	64QAM	-20.29	66.50	46.21	75.00	28.79

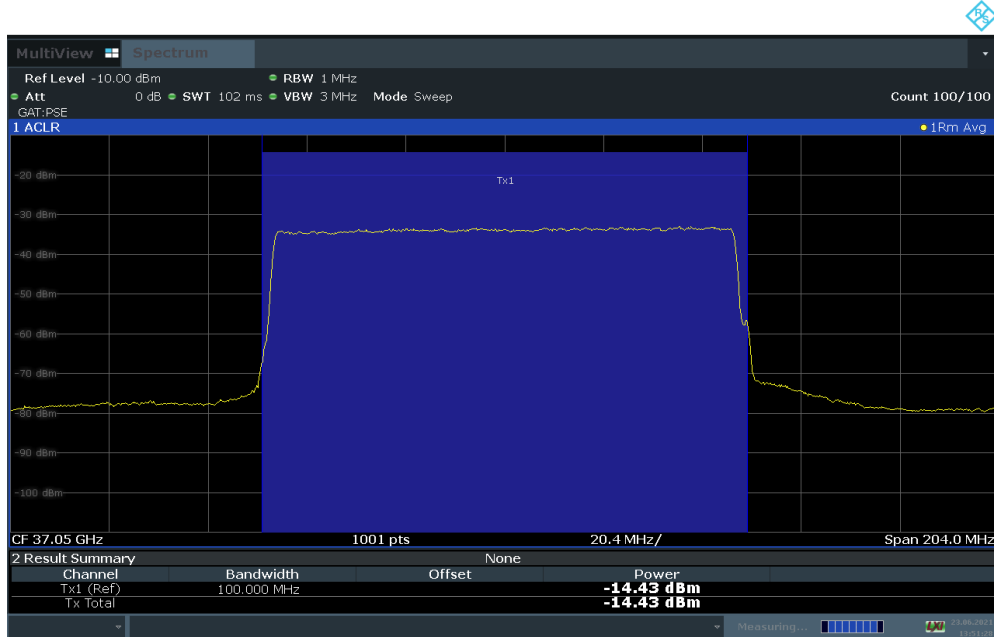

Table 7-8. Antenna B EIRP Density Summary Data

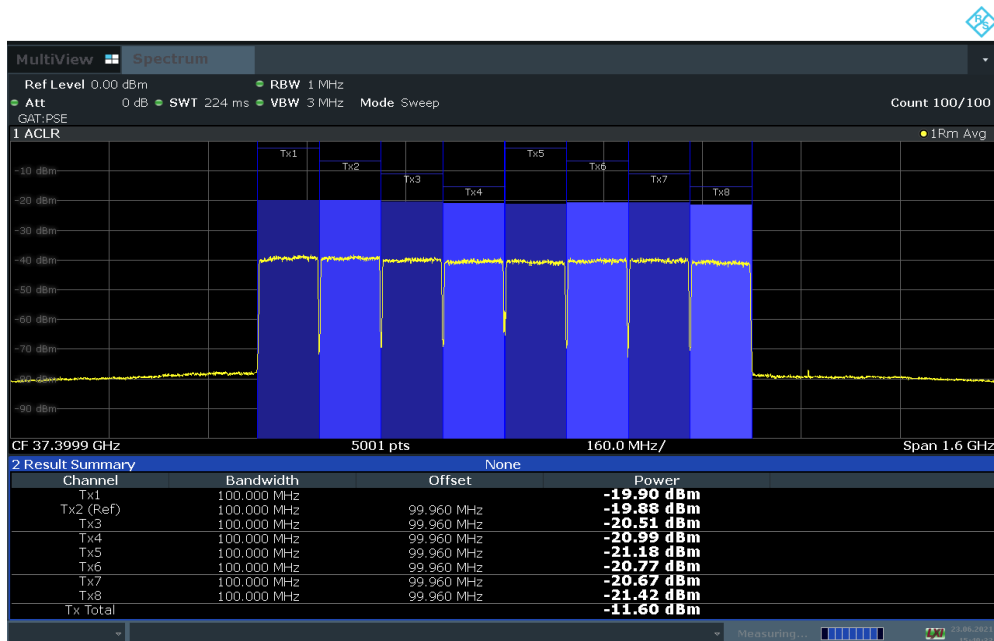

Plot 7-12. Antenna B EIRP Density Plot (100 MHz BW 1CC 64QAM Low Channel)



Plot 7-13. Antenna B EIRP Density Plot (100 MHz BW 8CC 64QAM Low Channel)

FCC ID: A3LAT1K06-A00		MEASUREMENT REPORT (Class II Permissive Change)		Approved by: Technical Manager
Test Report S/N: 8K21060202-R1.A3L	Test Dates: 06/21/2021-08/31/2021	EUT Type: AU(AT1K06)		Page 21 of 84

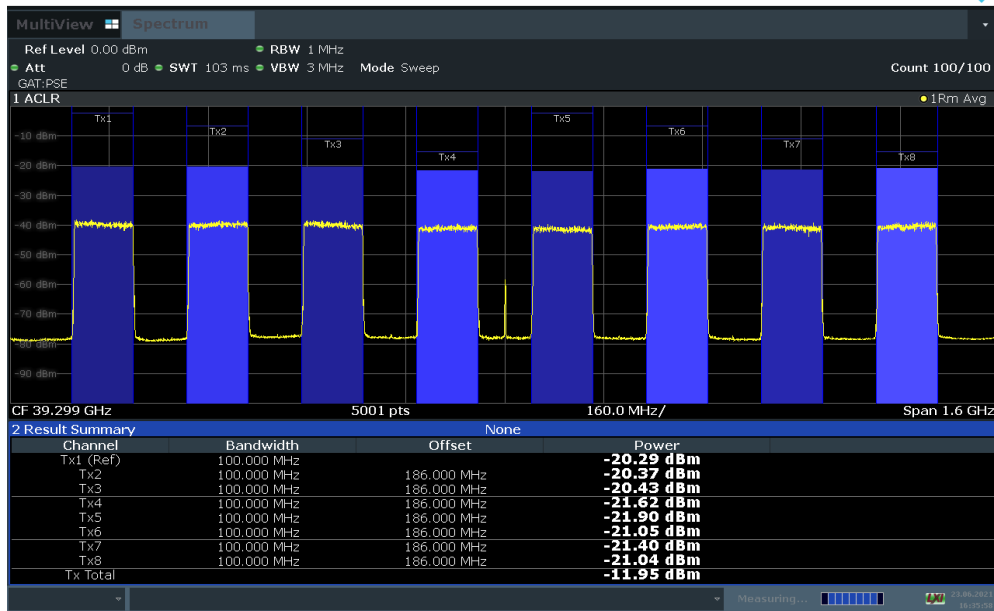

**Plot 7-14. Antenna B EIRP Density Plot (100 MHz BW 8NC 64QAM High Channel)**

FCC ID: A3LAT1K06-A00	<b>PCTEST</b> Proud to be part of element	<b>MEASUREMENT REPORT</b> (Class II Permissive Change)	<b>SAMSUNG</b>	Approved by: Technical Manager
Test Report S/N: 8K21060202-R1.A3L	Test Dates: 06/21/2021-08/31/2021	EUT Type: AU(AT1K06)		Page 22 of 84

### 7.3.3 Antenna C EIRP Density

Antenna	Bandwidth	Configuration	Chan.	Frequency	Modulation	Analyzer Level	AFCL	Average e.i.r.p PSD	PSD Limit	Margin
	[MHz]			[GHz]		[dBm]	[dBm]	[dBm/100MHz]	[dBm/100MHz]	[dB]
C	100	1CC	Low	37.050	64QAM	-14.55	64.76	50.21	75.00	24.79
	100	8CC	Low	37.050	64QAM	-19.82	64.76	44.94	75.00	30.06
	100	8NC	High	39.950	64QAM	-20.92	66.50	48.59	75.00	29.42

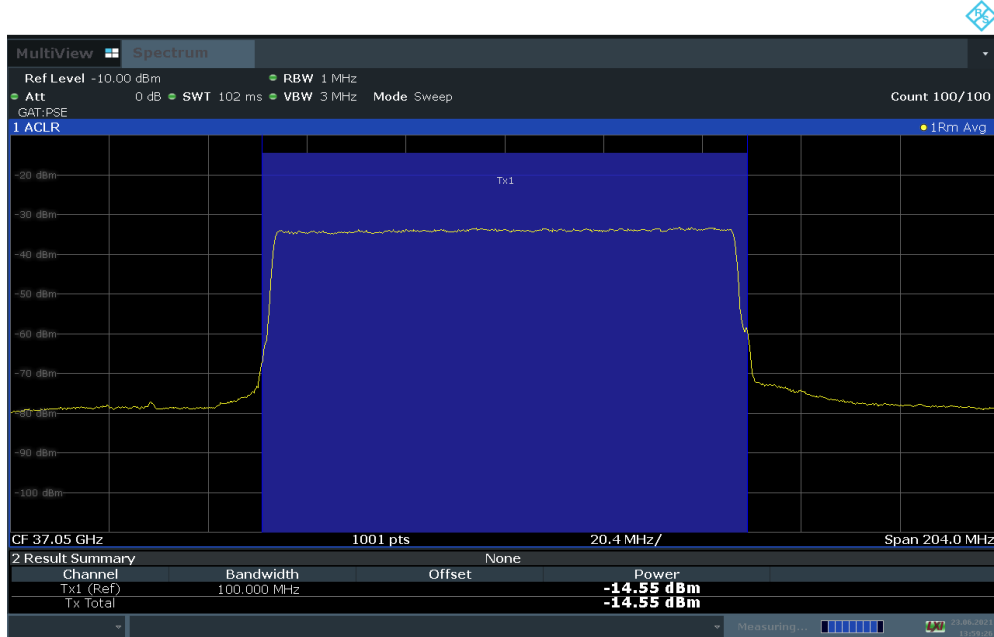

Table 7-9. Antenna C EIRP Density Summary Data

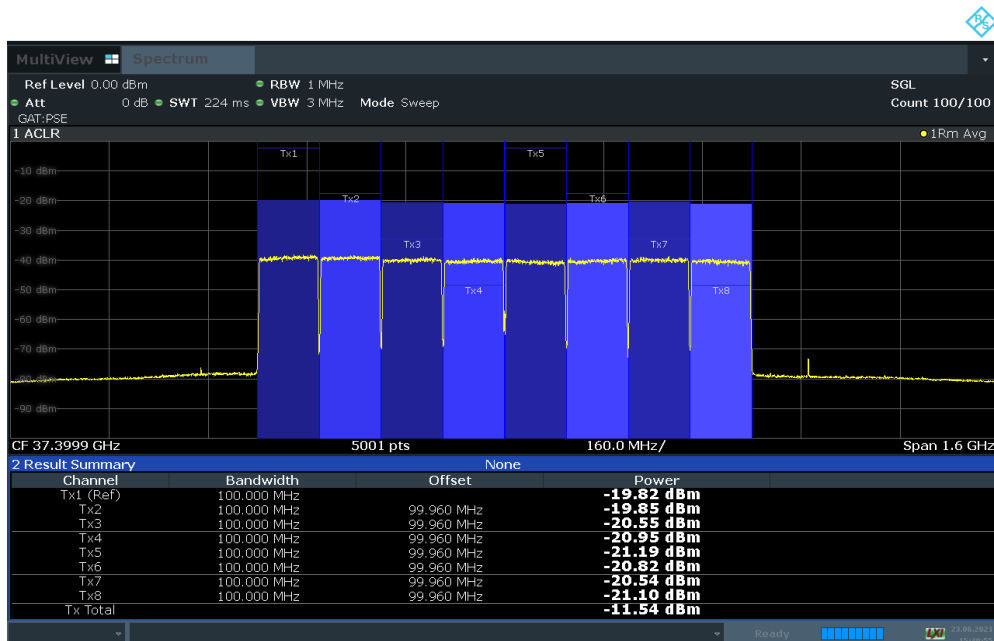

Plot 7-15. Antenna C EIRP Density Plot (100 MHz BW 1CC 64QAM Low Channel)



Plot 7-16. Antenna C EIRP Density Plot (100 MHz BW 8CC 64QAM Low Channel)

FCC ID: A3LAT1K06-A00	 PCTEST Proud to be part of element	MEASUREMENT REPORT (Class II Permissive Change)		Approved by: Technical Manager
Test Report S/N: 8K21060202-R1.A3L	Test Dates: 06/21/2021-08/31/2021	EUT Type: AU(AT1K06)		Page 23 of 84

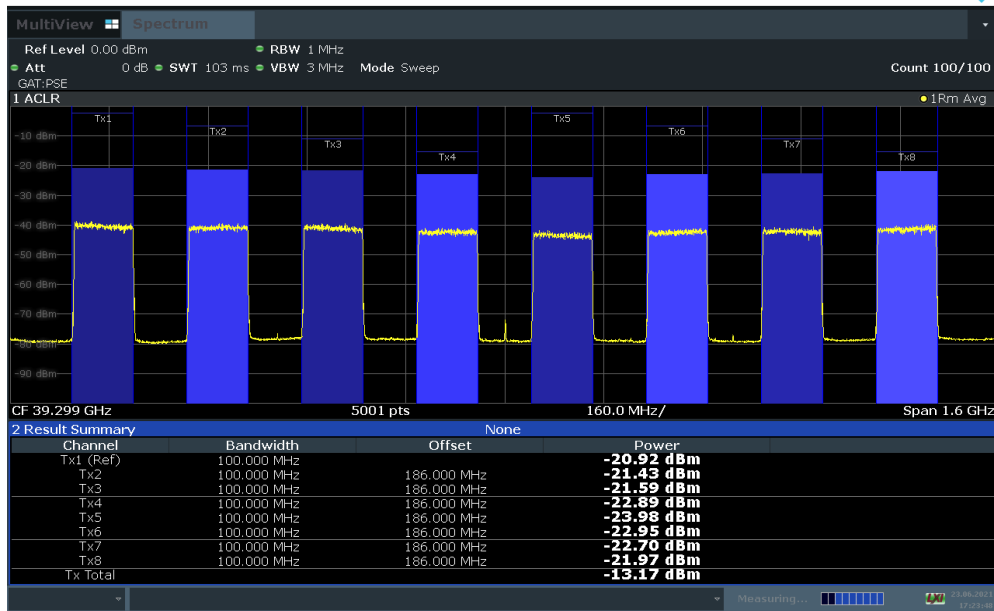

**Plot 7-17. Antenna C EIRP Density Plot (100 MHz BW 8NC 64QAM High Channel)**

<b>FCC ID:</b> A3LAT1K06-A00	<b>PCTEST</b> Proud to be part of element	<b>MEASUREMENT REPORT</b> (Class II Permissive Change)		<b>Approved by:</b> Technical Manager
<b>Test Report S/N:</b> 8K21060202-R1.A3L	<b>Test Dates:</b> 06/21/2021-08/31/2021	<b>EUT Type:</b> AU(AT1K06)		Page 24 of 84



### 7.3.4 Antenna D EIRP Density

Antenna	Bandwidth	Configuration	Chan.	Frequency	Modulation	Analyzer Level	AFCL	Average e.i.r.p PSD	PSD Limit	Margin
	[MHz]			[GHz]		[dBm]	[dBm]	[dBm/100MHz]	[dBm/100MHz]	[dB]
D	100	1CC	Low	37.050	64QAM	-14.69	64.76	50.07	75.00	24.93
	100	8CC	Low	37.050	64QAM	-19.70	64.76	45.06	75.00	29.94
	100	8NC	High	39.950	64QAM	-20.68	66.50	45.82	75.00	29.18

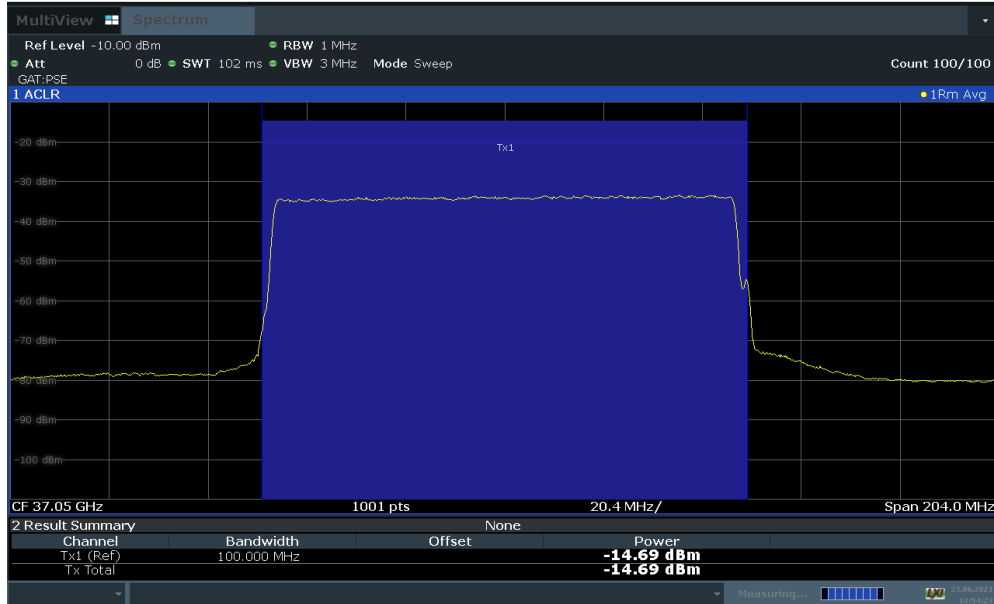

Table 7-10. Antenna D EIRP Density Summary Data

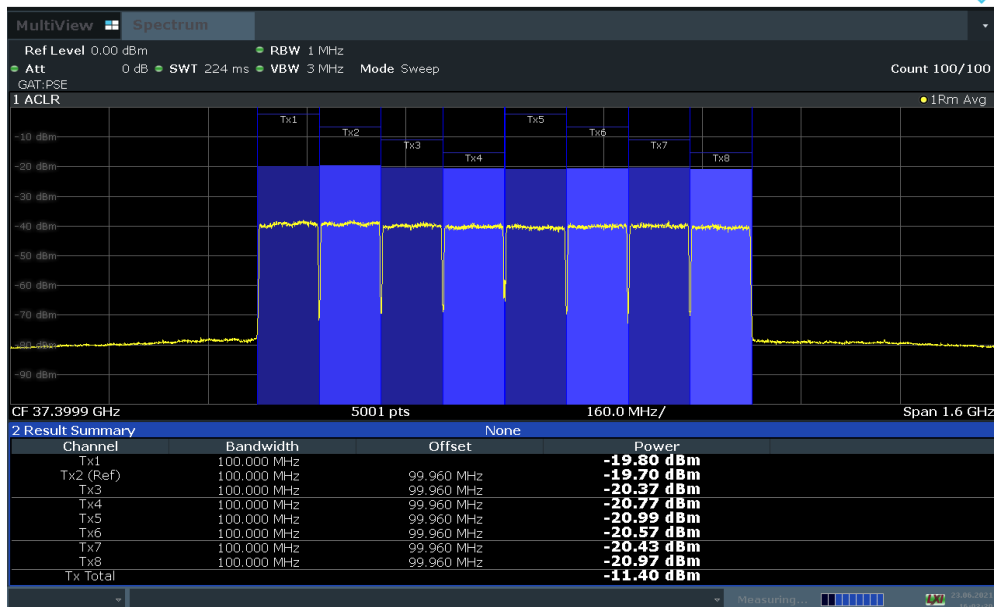

Plot 7-18. Antenna D EIRP Density Plot (100 MHz BW 1CC 64QAM Low Channel)



Plot 7-19. Antenna D EIRP Density Plot (100 MHz BW 8CC 64QAM Low Channel)

FCC ID: A3LAT1K06-A00		MEASUREMENT REPORT (Class II Permissive Change)		Approved by: Technical Manager
Test Report S/N: 8K21060202-R1.A3L	Test Dates: 06/21/2021-08/31/2021	EUT Type: AU(AT1K06)		Page 25 of 84

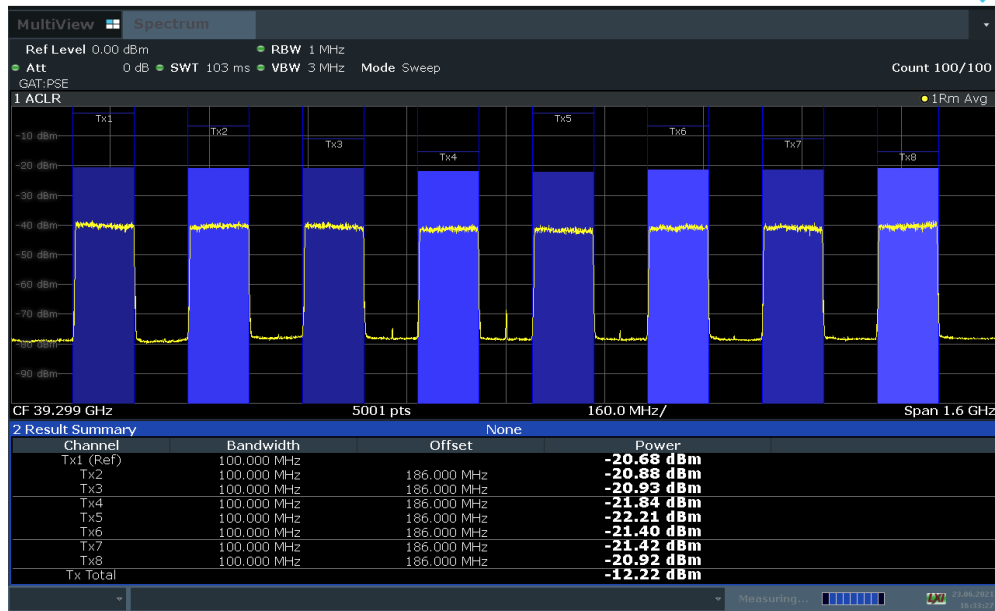

**Plot 7-20. Antenna D EIRP Density Plot (100 MHz BW 8NC 64QAM High Channel)**

<b>FCC ID:</b> A3LAT1K06-A00		<b>MEASUREMENT REPORT</b> (Class II Permissive Change)		<b>Approved by:</b> Technical Manager
<b>Test Report S/N:</b> 8K21060202-R1.A3L	<b>Test Dates:</b> 06/21/2021-08/31/2021	<b>EUT Type:</b> AU(AT1K06)		Page 26 of 84

### 7.3.5 MIMO EIRP Density

Antenna	Bandwidth	Configuration	Chan.	Frequency	Modulation	Ant A	Ant C	Average e.i.r.p PSD	PSD Limit	Margin
	[MHz]			[GHz]		[mW]	[mW]			
A + C	100	1CC	Low	37.050	64QAM	102.64	105.03	53.17	75.00	21.83
	100	8CC	Low	37.050	64QAM	29.53	31.21	47.83	75.00	27.17
	100	8NC	High	39.950	64QAM	36.58	72.33	50.37	75.00	24.63



**Table 7-11. MIMO EIRP Density Summary Data (Antenna A + C)**

Antenna	Bandwidth	Configuration	Chan.	Frequency	Modulation	Ant B	Ant D	Average e.i.r.p PSD	PSD Limit	Margin
	[MHz]			[GHz]		[mW]	[mW]			
B + D	100	1CC	Low	37.050	64QAM	107.97	101.70	53.22	75.00	21.78
	100	8CC	Low	37.050	64QAM	30.78	32.08	47.98	75.00	27.02
	100	8NC	High	39.950	64QAM	41.81	38.22	49.03	75.00	25.97

**Table 7-12. MIMO EIRP Density Summary Data (Antenna B + D)**

Antenna	Bandwidth	Configuration	Chan.	Freq.	Modulation	Ant A	Ant B	Ant C	Ant D	Average e.i.r.p PSD	PSD Limit	Margin
	[MHz]			[GHz]	ion	[mW]	[mW]	[mW]	[mW]			
A + B + C + D	100	1CC	Low	37.050	64QAM	102.64	107.97	105.03	101.70	56.20	75.00	18.80
	100	8CC	Low	37.050	64QAM	29.53	30.78	31.21	32.08	50.92	75.00	24.08
	100	8NC	High	39.950	64QAM	36.58	41.81	72.33	38.22	52.76	75.00	22.24

**Table 7-13. MIMO EIRP Density Summary Data (Antenna A + B + C + D)**

FCC ID: A3LAT1K06-A00	 PCTEST Proud to be part of element	MEASUREMENT REPORT (Class II Permissive Change)		Approved by: Technical Manager
Test Report S/N: 8K21060202-R1.A3L	Test Dates: 06/21/2021-08/31/2021	EUT Type: AU(AT1K06)		Page 27 of 84

## 7.4 RF Conducted Output Power

### §2.1046

#### Test Overview



RF conducted output power measurements are performed using broadband horn antennas. The conducted power is determined by maximizing the full spectrum EIRP for all component carrier configurations and then subtracting the known antenna gain from the EIRP. All measurements are performed as RMS average measurements while the EUT is operating at its maximum duty cycle, at maximum power, and at the appropriate frequencies.

#### Test Procedures Used

ANSI C63.26-2015 Section 5.2.4.4.1  
ANSI C63.26-2015 Section 6.4

#### Test Settings

1. Radiated power measurements are performed using the signal analyzer's "channel power" measurement capability for signals with continuous operation.
2. RBW = 1 – 5 % of the expected OBW
3. VBW  $\geq$  3 x RBW
4. Span = 2x to 3x the OBW
5. No. of sweep points  $\geq$  2 x span / RBW
6. Detector = RMS
7. The integration bandwidth was roughly set equal to the measured RF Conducted Output Power of the signal for signals with continuous operation. For signals with burst transmission, the "gating" function was enabled to ensure that measurements are performed during times in which the transmitter is operating at its maximum power
8. Trace mode = trace averaging (RMS) over 100 sweeps
9. The trace was allowed to stabilize

FCC ID: A3LAT1K06-A00	 PCTEST® Proud to be part of element	MEASUREMENT REPORT (Class II Permissive Change)		Approved by: Technical Manager
Test Report S/N: 8K21060202-R1.A3L	Test Dates: 06/21/2021-08/31/2021	EUT Type: AU(AT1K06)		Page 28 of 84



## Test Notes

- 1) For comparison with the original authorization, the testing was performed on the worst case of the original test results.
- 2) For multiple carrier configuration, the highest value among all carrier powers was taken.
- 3) The EUT was tested while positioned upright and mounted on a mast at 1.5 m height. The worst case emissions are reported with the EUT in this fixed position and with the modulations and active component carriers shown in the tables below.
- 4) Elements within the same antenna array are correlated to produce beamforming array gain, only one antenna array was active.
- 5) Measurements were taken in the far field of the mmWave signal based on the formula:  $R \geq 2D^2/\text{wavelength}$ .
- 6) The test case with from 1CC to 8CC active, was selected for the worst case emission testing as it created the highest EIRP within 100 MHz bandwidth carrier configurations.
- 7) The average EIRP reported below is calculated per formula specific in d) of ANSI C63.26-2015 Section 5.2.7:  

$$\text{EIRP (dBm)} = E \text{ (dB}\mu\text{V/m)} + 20\log(D) - 104.8;$$
 where D is the measurement distance (in the far field region) in m.  
 For this section, all EIRP density measurements were performed at a distance of 3.20 m, so the effective correction is:  

$$\begin{aligned} \text{EIRP (dBm)} &= E \text{ (dB}\mu\text{V/m)} - 96.46 \text{ dB} \\ &= \text{Analyzer Level (dBm)} + \text{AFCL (dB/m)} + 107 \text{ dB} - 96.46 \text{ dB} \\ &= \text{Analyzer Level (dBm)} + \text{AFCL (dB/m)} + 12.30 \text{ dB} \end{aligned}$$
- 8) The conducted average power over the full channel BW is calculated as follows:  

$$\text{Conducted Average Power (dBm)} = \text{Average EIRP (dBm)} - \text{Antenna Gain (dBi)}$$
- 9) Per ANSI C63.26-2015 Section 6.4, individual EIRPs are also summed before compared to the limit.
- 10) The angle of the horn antenna was rotated to maximize and find the worst case emissions. Worst case EIRP is reported below.
- 11) 7.3 Equivalent Isotropic Radiated Power (EIRP) Density plots cover for 7.4 Conducted Output Power plot.

FCC ID: A3LAT1K06-A00		<b>MEASUREMENT REPORT</b> <b>(Class II Permissive Change)</b>		<b>Approved by:</b> Technical Manager
<b>Test Report S/N:</b> 8K21060202-R1.A3L	<b>Test Dates:</b> 06/21/2021-08/31/2021	<b>EUT Type:</b> AU(AT1K06)	Page 29 of 84	

### 7.4.1 Antenna A Conducted Power

Antenna	Bandwidth	Configuration	Chan.	Frequency	Modulation	Analyzer Level	AFCL	EUT Antenna Gain	Average e.i.r.p. PSD	Conducted Average Power
	[MHz]			[GHz]		[dBm]				
A	100	1CC	Low	37.050	64QAM	-14.65	64.76	27.00	50.11	23.11
	100	8CC	Low	37.050	64QAM	-20.06	64.76	27.00	44.70	17.70
	100	8NC	High	39.950	64QAM	-20.87	66.50	27.00	45.63	18.63

Table 7-14. Antenna A Conducted Power Summary Data

### 7.4.2 Antenna B Conducted Power

Antenna	Bandwidth	Configuration	Chan.	Frequency	Modulation	Analyzer Level	AFCL	EUT Antenna Gain	Average e.i.r.p. PSD	Conducted Average Power
	[MHz]			[GHz]		[dBm]				
B	100	1CC	Low	37.050	64QAM	-14.43	64.76	27.00	50.33	23.33
	100	8CC	Low	37.050	64QAM	-19.88	64.76	27.00	44.88	17.88
	100	8NC	High	39.950	64QAM	-20.29	66.50	27.00	46.21	19.21

Table 7-15. Antenna B Conducted Power Summary Data

### 7.4.3 Antenna C Conducted Power



Antenna	Bandwidth	Configuration	Chan.	Frequency	Modulation	Analyzer Level	AFCL	EUT Antenna Gain	Average e.i.r.p. PSD	Conducted Average Power
	[MHz]			[GHz]		[dBm]				
C	100	1CC	Low	37.050	64QAM	-14.55	64.76	27.00	50.21	23.21
	100	8CC	Low	37.050	64QAM	-19.82	64.76	27.00	44.94	17.94
	100	8NC	High	39.950	64QAM	-20.92	66.50	27.00	45.58	18.58

Table 7-16. Antenna C Conducted Power Summary Data

### 7.4.4 Antenna D Conducted Power

Antenna	Bandwidth	Configuration	Chan.	Frequency	Modulation	Analyzer Level	AFCL	EUT Antenna Gain	Average e.i.r.p. PSD	Conducted Average Power
	[MHz]			[GHz]		[dBm]				
D	100	1CC	Low	37.050	64QAM	-14.69	64.76	27.00	50.07	23.07
	100	8CC	Low	37.050	64QAM	-19.70	64.76	27.00	45.06	18.06
	100	8NC	High	39.950	64QAM	-20.68	66.50	27.00	45.82	18.82

Table 7-17. Antenna D Conducted Power Summary Data

FCC ID: A3LAT1K06-A00	 PCTEST Proud to be part of element	MEASUREMENT REPORT (Class II Permissive Change)		Approved by: Technical Manager
Test Report S/N: 8K21060202-R1.A3L	Test Dates: 06/21/2021-08/31/2021	EUT Type: AU(AT1K06)		Page 30 of 84

## 7.5 Radiated Spurious and Harmonic Emissions

### §2.1051 §30.203

#### Test Overview

The spectrum is scanned from 30 MHz to 100 GHz for n261 and from 30 MHz to 200 GHz for n260. All out of band emissions are measured in a radiated setup while the EUT is operating at its maximum duty cycle, at maximum power, and at the appropriate frequencies. All modulations were investigated to determine the worst case configuration. All modes of operation were investigated and the worst case configuration results are reported in this section.

***The conductive power or total radiated power of any emissions outside a licensee's frequency block shall be -13 dBm / 1 MHz.***

#### Test Procedure Used



ANSI C63.26-2015 Section 5.7.4  
ANSI C63.26-2015 Section 6.4  
KDB 842590 D01 v01r02 Section 4.4.2 and Section 4.4.3

#### Test Settings

1. Start frequency was set to 30 MHz and stop frequency was set to 100 GHz for n261 and 200 GHz for n260. Several plots are used to show investigations in this entire span.
2. Detector = RMS
3. Trace mode = trace average
4. Sweep time = auto couple
5. Number of sweep points  $\geq 2 \times \text{Span/RBW}$
6. The trace was allowed to stabilize
7. RBW = 1 MHz, VBW = 3 MHz

#### Test Notes

- 1) The peak spurious emissions level is within up to 3 dB from the original authorization.
- 2) For comparison with the original authorization, the testing was performed on the worst case of the original test results.
- 3) The EUT was tested while positioned upright and mounted on a mast 1.5 m height. The worst case emissions are reported with the EUT in this fixed position and with the modulations and active component carriers shown in the tables below.
- 4) All radiated spurious emissions were measured as EIRP to compare with the §30.203 TRP limits.
- 5) Emissions below 18 GHz were measured at a 3 meter test distance, while emissions above 18 GHz were measured at the appropriate far field distance. The far field of the mmWave signal is based on formula;  $R > 2D^2/\text{wavelength}$ , where D is the larger between the dimension of the measurement antenna and the transmitting antenna of the EUT. In this case, D is the largest dimension of the measurement antenna.
- 6) Out-band Emission of 10% channel bandwidth are exempted on Radiated Spurious and Harmonic Emissions test case.
- 7) The plots from 1-200 GHz show corrected average EIRP levels. The average EIRP reported below is calculated per section 5.2.7 of ANSI C63.26-2015 which states:  $\text{EIRP (dBm)} = E \text{ (dB}\mu\text{V/m)} + 20\log(D) - 104.8$ ; where D is the measurement distance (in the far field region) in m. The field strength E is

FCC ID: A3LAT1K06-A00	 PCTEST Proud to be part of element	MEASUREMENT REPORT (Class II Permissive Change)		Approved by: Technical Manager
Test Report S/N: 8K21060202-R1.A3L	Test Dates: 06/21/2021-08/31/2021	EUT Type: AU(AT1K06)		Page 31 of 84

calculated E (dBμV/m) = Spectrum Analyzer Level (dBm) + Antenna Factor (dB/m) + Cable Loss (dB) + Duty Cycle (dB) + Harmonic Mixer Conversion Loss (dB) + 107. All appropriate Antenna Factor and Cable Loss have been applied in the spectrum analyzer for each measurement. For measurements > 40 GHz, Harmonic Mixer Conversion Loss was also applied to the spectrum analyzer.

Frequency Range [GHz]	Wavelength [cm]	Far Field Distance [m]	Measurements Distance [m]
18 to 40	0.749	2.61	3.20
40 to 60	0.500	1.39	3.20
60 to 90	0.333	0.91	3.20
90 to 140	0.214	0.58	1.00
140 to 200	0.150	0.39	1.00

**Table 7-18. Far-field Distance & Measurement Distance per Frequency Range**

Frequency Range [GHz]	Calculated Measurement D * E [dB]	Duty Cycle [dB]	Reference offset [dB]
18 to 90	12.30	1.37	13.67
90 to 200	2.20	1.37	3.57



**Table 7-19. Far-field Distance & Measurement Distance per Frequency Range**

- 8) Emissions > 40 GHz were measured using a harmonic mixer with the spectrum analyzer.
- 9) The “-“ shown in the following RSE tables are used to denote a noise floor measurement.
- 10) Spurious emissions were measured with all EUT antennas transmitting simultaneously.  
Per section 4.4.1 of KDB 842590 D01, unwanted emission measurements, “If the device does not meet the emission limit at one or some frequencies, then TRP measurements shall be performed only at the failing frequencies at which emission levels exceed the limit.” The TRP measurement plots using the three cut test method as described in section 4.4 of the KDB, follow all failing emission plots in this report.

### TRP Measurement Procedure



If the recorded EIRP value was close or above the TRP limit, a Two Cut TRP measurement was done according to KDB 842590 D01 v01 Section 4.4.3.3.2

- a) Align the EUT with a chosen xy-plane and the xz-plane of the antenna measurement coordinate system.  
NOTE 1 For harmonics and spurious emission frequencies which are beamforming as identified in exploratory scan, it may be required to align the orthogonal cuts to include the peak based on exploratory scans.
- b) Measure the EUT dimensions, i.e., depth (d), width (w), and height (h); see Figure A.1 in Appendix A.
- c) Calculate the spherical and cylindrical diameters (D and D<sub>cy</sub>) using Equations (A.1) and (A.2) (see Appendix
- d) For the highest frequency (smallest wavelength) of the frequency band measured, calculate the reference angular steps  $\Delta\theta_{ref}$  and  $\Delta\phi_{ref}$  using Equations (A.3) and (A.4).
- e) Set the grid spatial sampling step  $\Delta\theta \leq \Delta\theta_{ref}$  for the vertical angle and  $\Delta\phi \leq \Delta\phi_{ref}$  for the horizontal cut.
- f) For each emission frequency, measure the EIRP (as a sum of two orthogonal polarizations) at each spatial sampling step on the selected grid.
- g) For each emission frequency, calculate the average EIRP for both the cuts separately, and then take the average of these two average values.

FCC ID: A3LAT1K06-A00	 PCTEST Proud to be part of element	MEASUREMENT REPORT (Class II Permissive Change)		Approved by: Technical Manager
Test Report S/N: 8K21060202-R1.A3L	Test Dates: 06/21/2021-08/31/2021	EUT Type: AU(AT1K06)		Page 32 of 84



- h) Add 2 dB as a correction factor to the averaged value computed in step g).
- i) If the TRP limit is exceeded, a third orthogonal cut in the yz-plane and using the  $\Delta\theta$  angular step, can be added. Now, calculate the average values in all three cuts separately, and then take the average value of these three average values.
- j) Add 1.5 dB as a correction factor to the averaged value computed in step i).
- k) Evaluate the pass/fail decision by comparing TRP from step h) or step j) against the applicable TRP limit.

<b>FCC ID:</b> A3LAT1K06-A00		<b>MEASUREMENT REPORT (Class II Permissive Change)</b>		<b>Approved by:</b> Technical Manager
<b>Test Report S/N:</b> 8K21060202-R1.A3L	<b>Test Dates:</b> 06/21/2021-08/31/2021	<b>EUT Type:</b> AU(AT1K06)	Page 33 of 84	

### 7.5.1 Radiated Spurious Emissions Plots (30 MHz to 1 GHz)

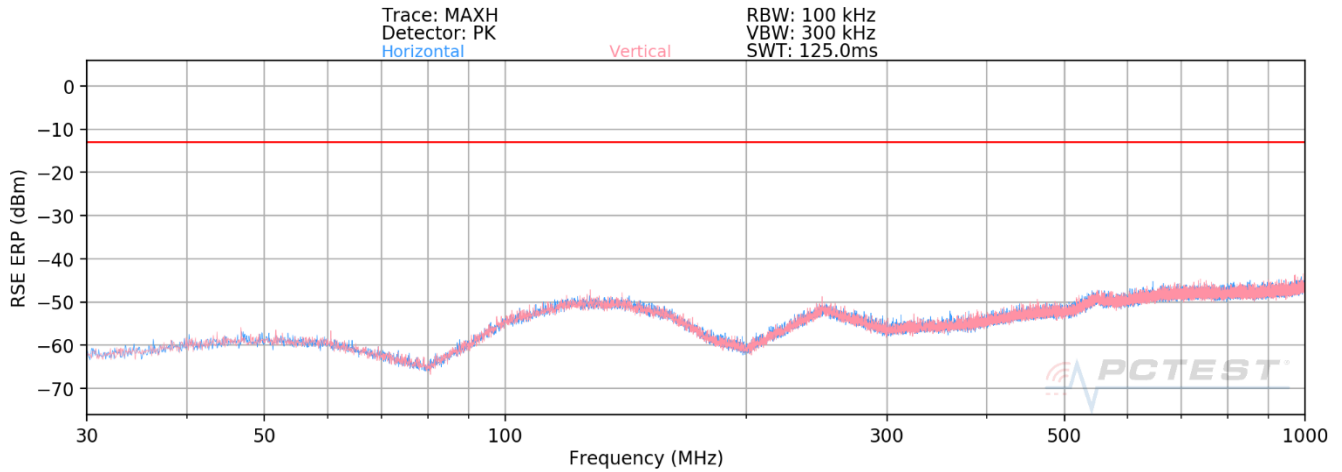

**Plot 7-21. Radiated Spurious Plot 30 MHz - 1 GHz (100 MHz BW 1CC QPSK Mid Channel)**

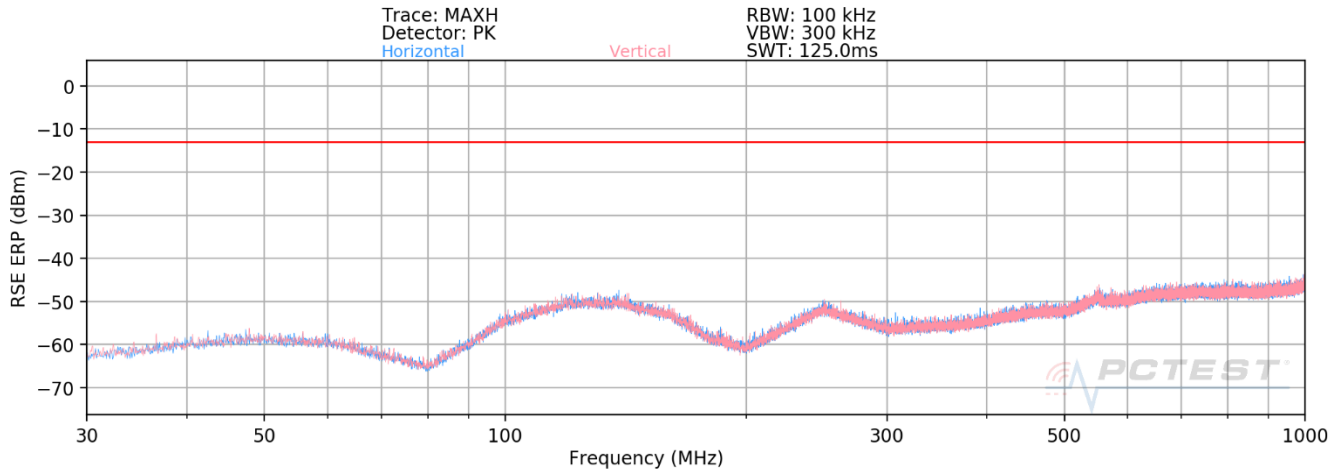

**Plot 7-22. Radiated Spurious Plot 30 MHz - 1 GHz (100 MHz BW 1CC QPSK High Channel)**

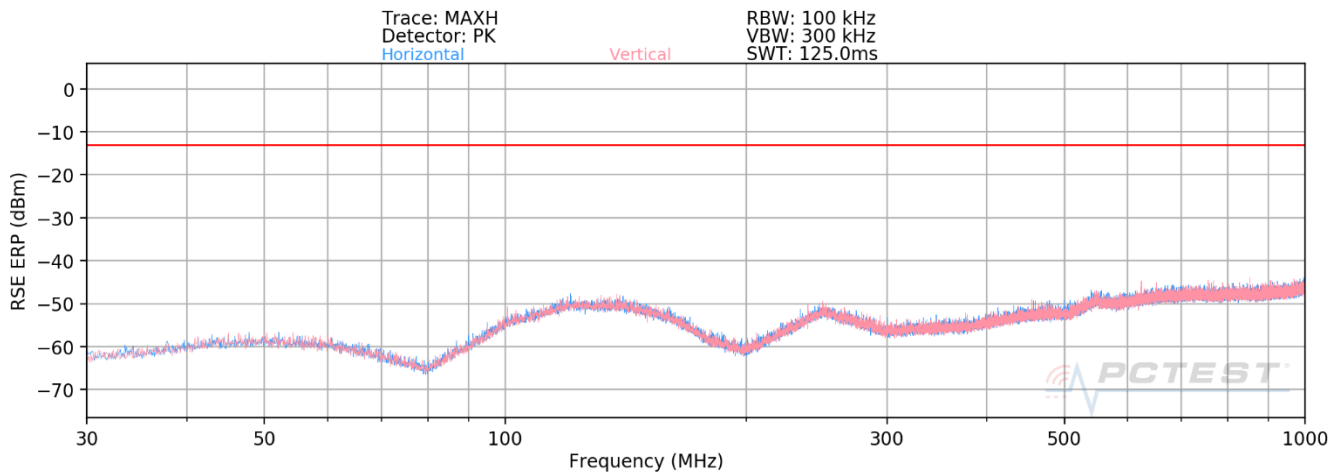

**Plot 7-23. Radiated Spurious Plot 30 MHz - 1 GHz (100 MHz BW 8CC QPSK Low Channel)**

FCC ID: A3LAT1K06-A00	<b>PCTEST</b> Proud to be part of element	<b>MEASUREMENT REPORT</b> (Class II Permissive Change)		Approved by: Technical Manager
Test Report S/N: 8K21060202-R1.A3L	Test Dates: 06/21/2021-08/31/2021	EUT Type: AU(AT1K06)		Page 34 of 84

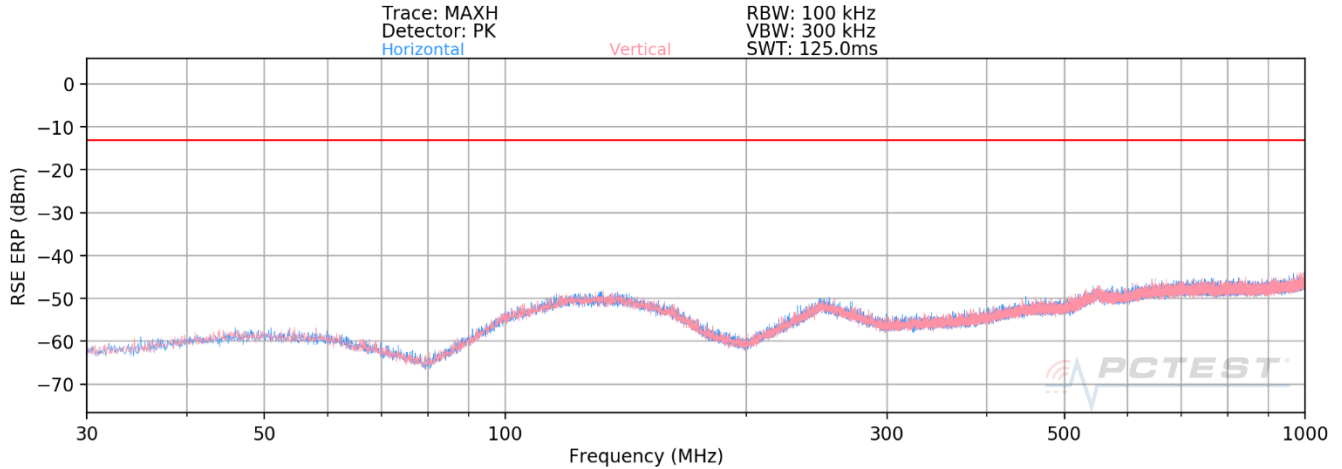

Plot 7-24. Radiated Spurious Plot 30 MHz - 1 GHz (100 MHz BW 8CC QPSK High Channel)

### Spurious Emissions EIRP Sample Calculation (n260)

The raw radiated spurious level is converted to field strength in dB $\mu$ V/m. Then, the RSE EIRP level is calculated by applying the additional factors shown below for a test distance of 3 meters.



$$\text{RSE EIRP (dBm)} = \text{Analyzer Level (dBm)} + \text{AFCL (dB/m)} + 107 + 20\text{Log}(D_m) - 104.8$$

Frequency [MHz]	Configuration	Channel	Modulation	Ant. Pol. [H/V]	Antenna Height [cm]	Turntable Azimuth [degree]	Analyzer Level [dBm]	AFCL [dBm]	RSE EIRP [dBm]	Margin [dB]
544.09	8CC	Mid	QPSK	H	1.5	5	-77.45	20.33	-45.39	32.39
750.83	8CC	Mid	QPSK	V	1.6	5	-79.33	23.83	-43.76	30.76

Table 7-20. Spurious Emissions (30 MHz to 1 GHz)

### Notes

The RSE EIRP level is taken directly from the spectrum analyzer which includes the appropriate antenna factors, and cable losses. Measurements were performed at a distance of 3 meter.

FCC ID: A3LAT1K06-A00		MEASUREMENT REPORT (Class II Permissive Change)		Approved by: Technical Manager
Test Report S/N: 8K21060202-R1.A3L	Test Dates: 06/21/2021-08/31/2021	EUT Type: AU(AT1K06)		Page 35 of 84

## 7.5.2 Radiated Spurious Emissions Plots (1 GHz to 18 GHz)

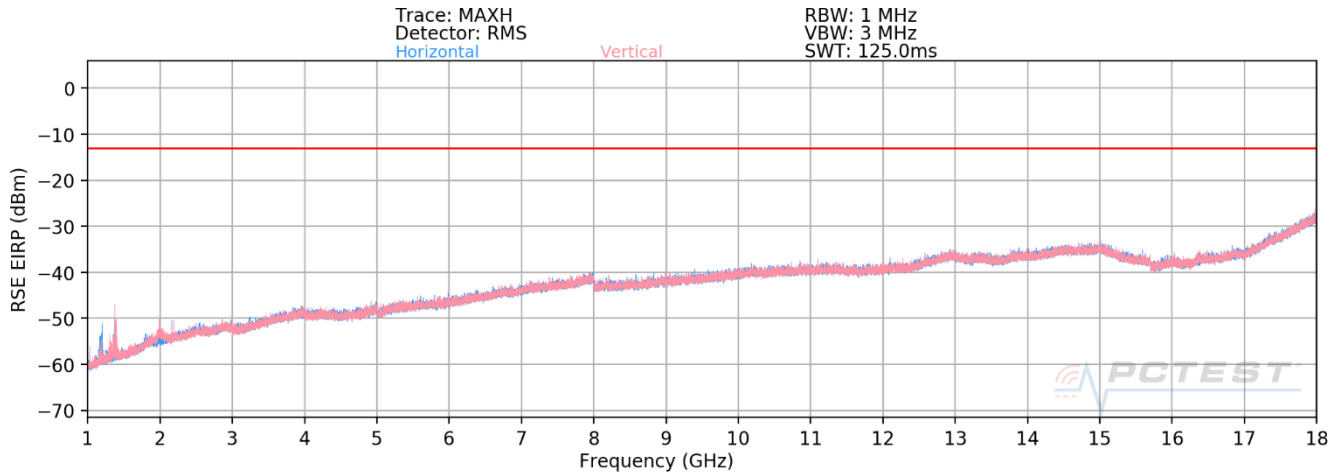

**Plot 7-25. Radiated Spurious Plot 1 GHz - 18 GHz (100 MHz BW 1CC QPSK Mid Channel)**

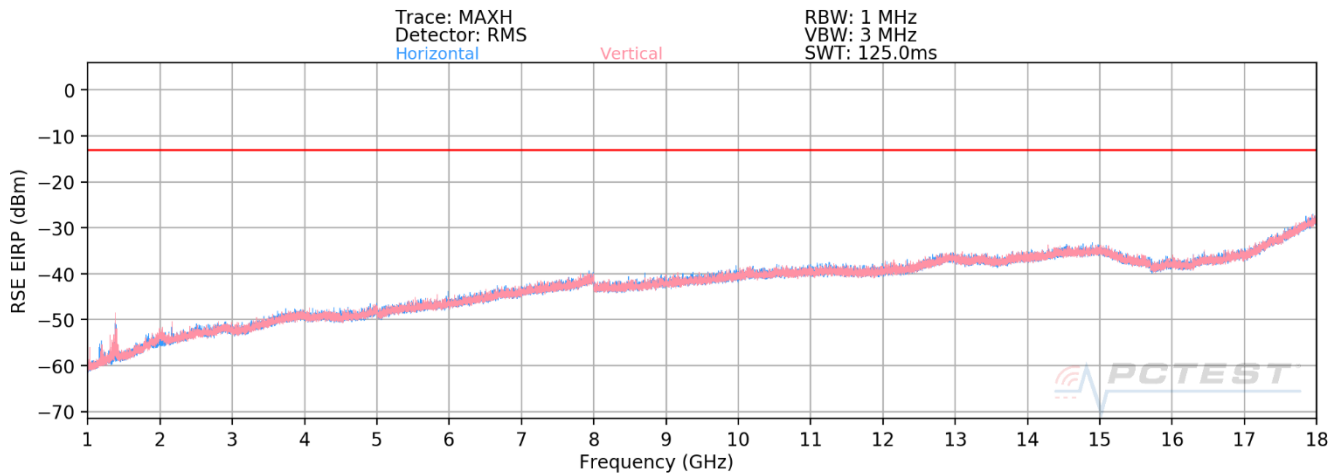

**Plot 7-26. Radiated Spurious Plot 1 GHz - 18 GHz (100 MHz BW 1CC QPSK High Channel)**

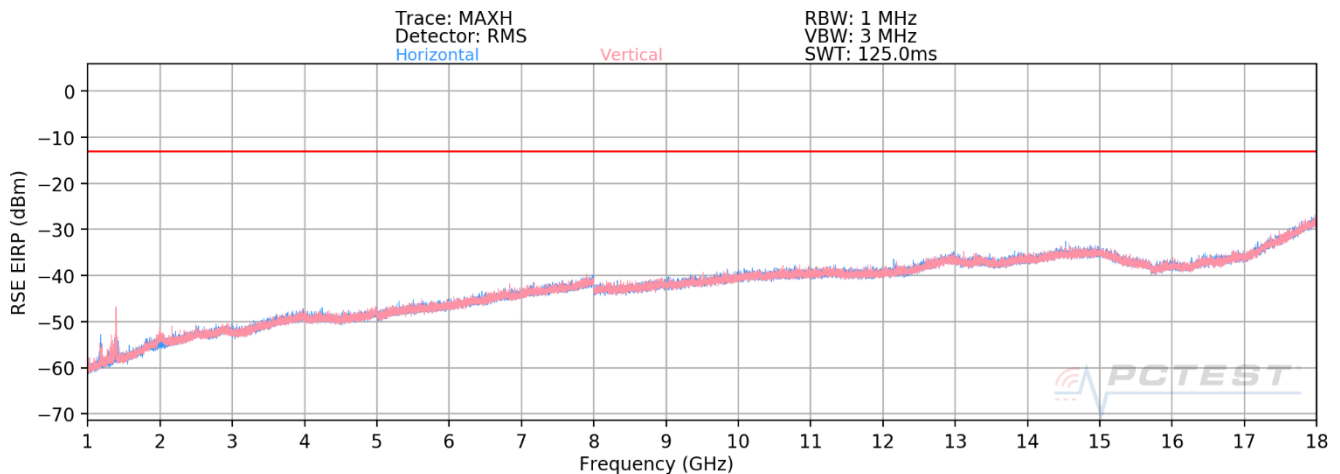

**Plot 7-27. Radiated Spurious Plot 1 GHz - 18 GHz (100 MHz BW 8CC QPSK Low Channel)**

FCC ID: A3LAT1K06-A00	PCTEST Proud to be part of element	MEASUREMENT REPORT (Class II Permissive Change)		Approved by: Technical Manager
Test Report S/N: 8K21060202-R1.A3L	Test Dates: 06/21/2021-08/31/2021	EUT Type: AU(AT1K06)		Page 36 of 84

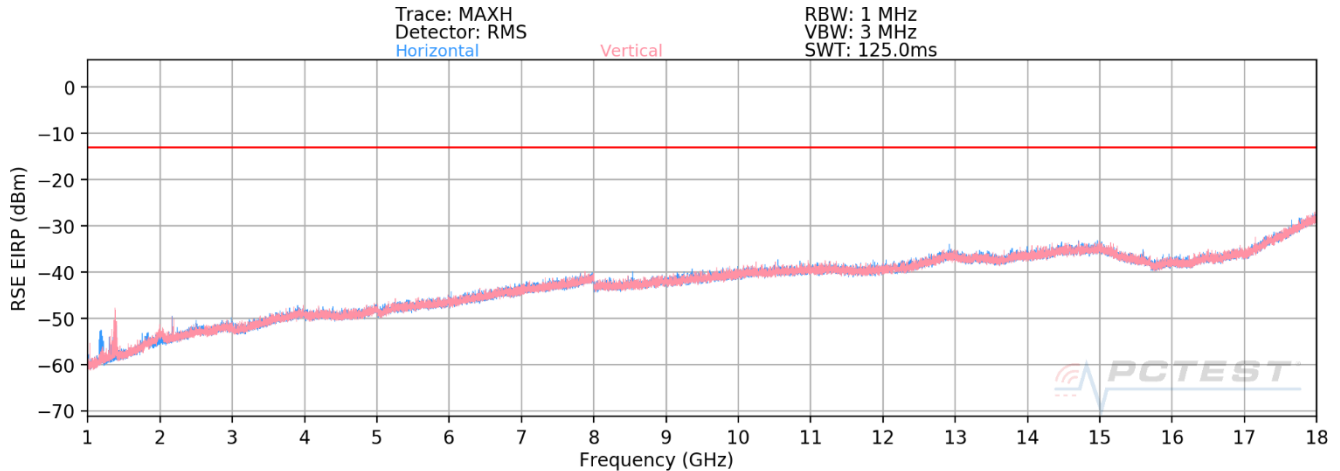

Plot 7-28. Radiated Spurious Plot 1 GHz - 18 GHz (100 MHz BW 8CC QPSK High Channel)

### Spurious Emissions EIRP Sample Calculation (n260)

The raw radiated spurious level is converted to field strength in dB $\mu$ V/m. Then, the RSE EIRP level is calculated by applying the additional factors shown below for a test distance of 3 meters.



$$\text{RSE EIRP (dBm)} = \text{Analyzer Level (dBm)} + \text{AFCL (dB/m)} + 107 + 20\text{Log}(D_m) - 104.8$$

Frequency [MHz]	Configuration	Channel	Modulation	Ant. Pol. [H/V]	Antenna Height [cm]	Turntable Azimuth [degree]	Analyzer Level [dBm]	AFCL [dBm]	RSE EIRP [dBm]	Margin [dB]
1398.64	8CC	Low	QPSK	V	1.5	0	-55.42	0.08	-43.60	30.6
1998.72	1CC	Mid	QPSK	V	1.5	0	-65.79	3.35	-50.70	37.7

Table 7-21. Radiated Spurious Emissions (1 GHz to 18 GHz)

### Notes

The RSE EIRP level is taken directly from the spectrum analyzer which includes the appropriate antenna factors, and cable losses. Measurements were performed at a distance of 3 meter.

FCC ID: A3LAT1K06-A00		MEASUREMENT REPORT (Class II Permissive Change)		Approved by: Technical Manager
Test Report S/N: 8K21060202-R1.A3L	Test Dates: 06/21/2021-08/31/2021	EUT Type: AU(AT1K06)		Page 37 of 84

### 7.5.3 Radiated Spurious Emissions Plots (18 GHz to 33 GHz)

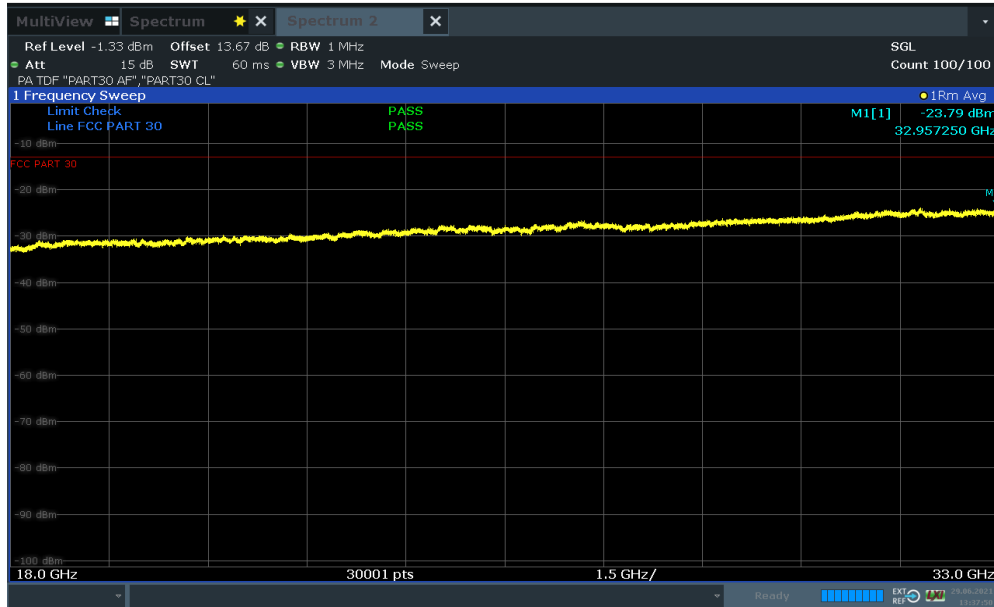

Plot 7-29. Radiated Spurious Plot 18 GHz – 33 GHz (100 MHz BW 1CC QPSK Mid Channel Pol. H)

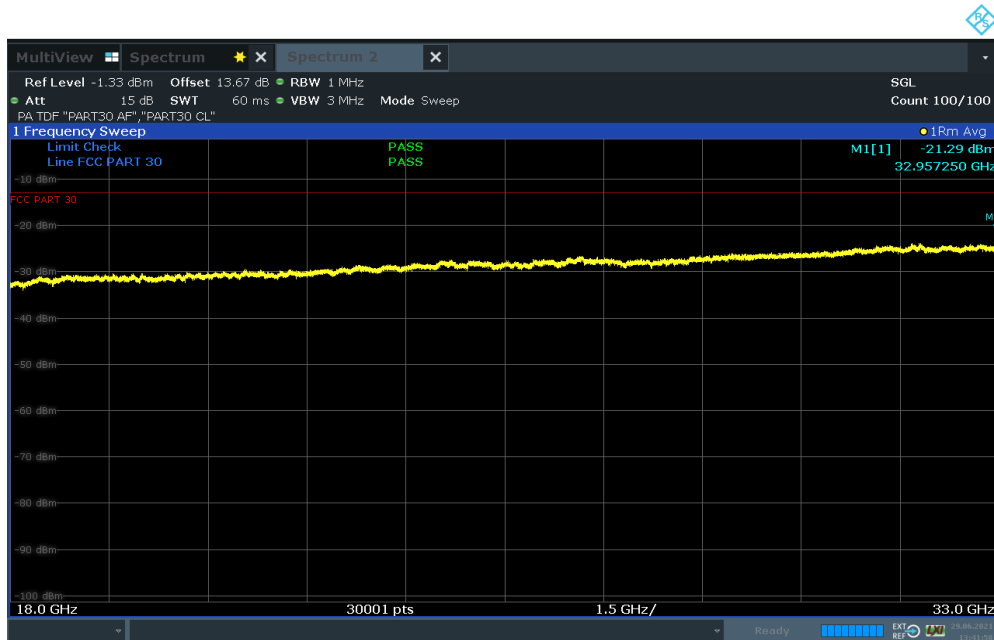

Plot 7-30. Radiated Spurious Plot 18 GHz – 33 GHz (100 MHz BW 1CC QPSK Mid Channel Pol. V)

FCC ID: A3LAT1K06-A00	<b>PCTEST</b> Proud to be part of element	MEASUREMENT REPORT (Class II Permissive Change)	<b>SAMSUNG</b>	Approved by: Technical Manager
Test Report S/N: 8K21060202-R1.A3L	Test Dates: 06/21/2021-08/31/2021	EUT Type: AU(AT1K06)		Page 38 of 84

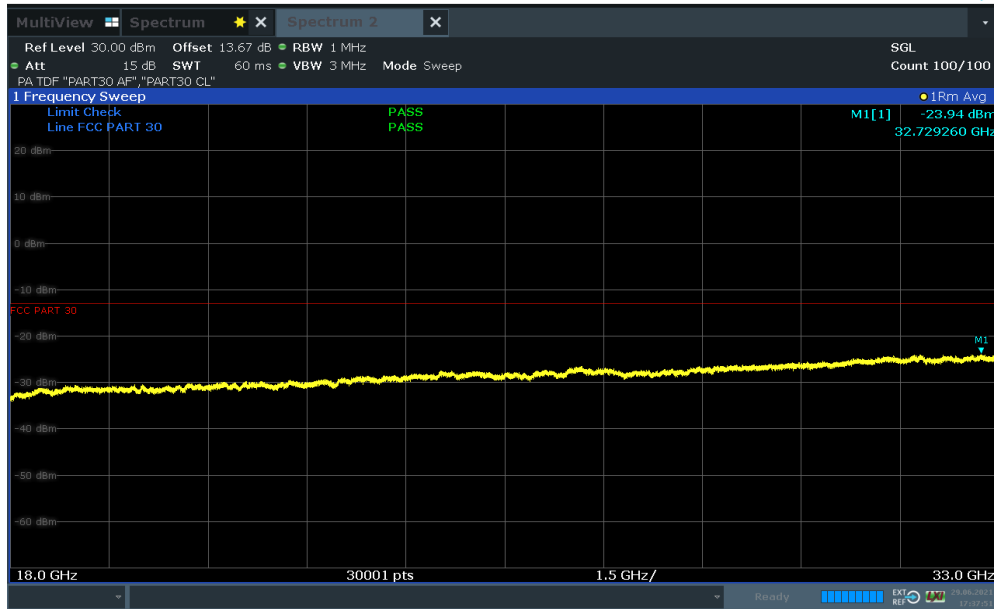

Plot 7-31. Radiated Spurious Plot 18 GHz – 33 GHz (100 MHz BW 1CC QPSK High Channel Pol. H)

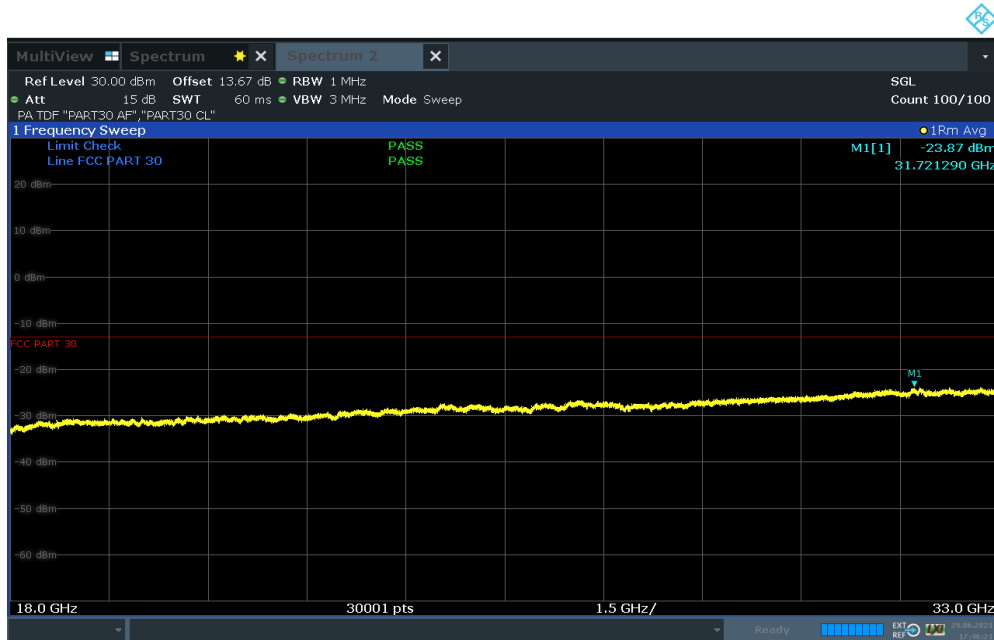

Plot 7-32. Radiated Spurious Plot 18 GHz – 33 GHz (100 MHz BW 1CC QPSK High Channel Pol. V)

FCC ID: A3LAT1K06-A00	<b>PCTEST</b> Proud to be part of element	<b>MEASUREMENT REPORT</b> (Class II Permissive Change)	<b>SAMSUNG</b>	Approved by: Technical Manager
Test Report S/N: 8K21060202-R1.A3L	Test Dates: 06/21/2021-08/31/2021	EUT Type: AU(AT1K06)		Page 39 of 84

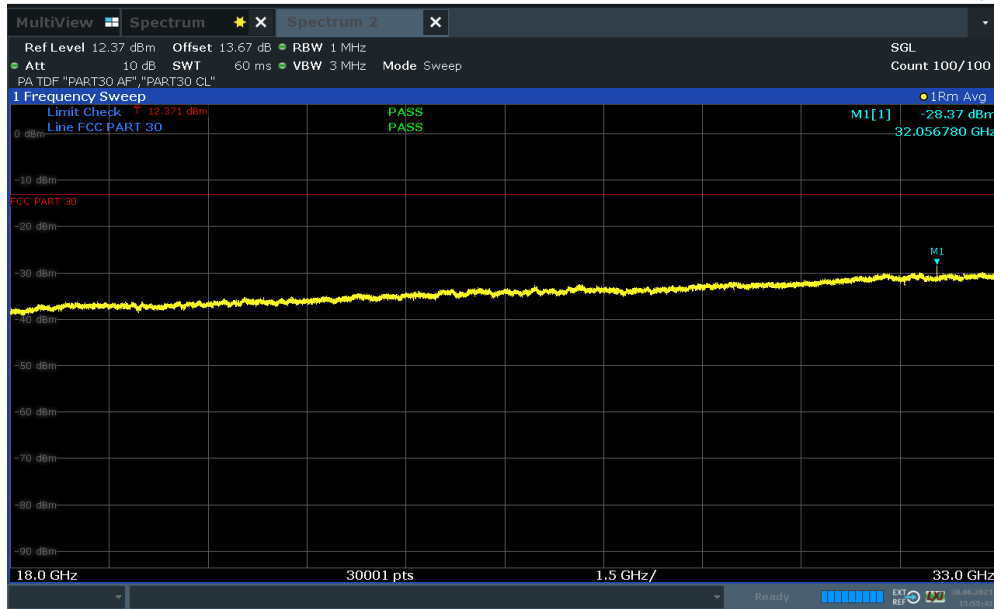

Plot 7-33. Radiated Spurious Plot 18 GHz – 33 GHz (100 MHz BW 8CC QPSK Low Channel Pol. H)

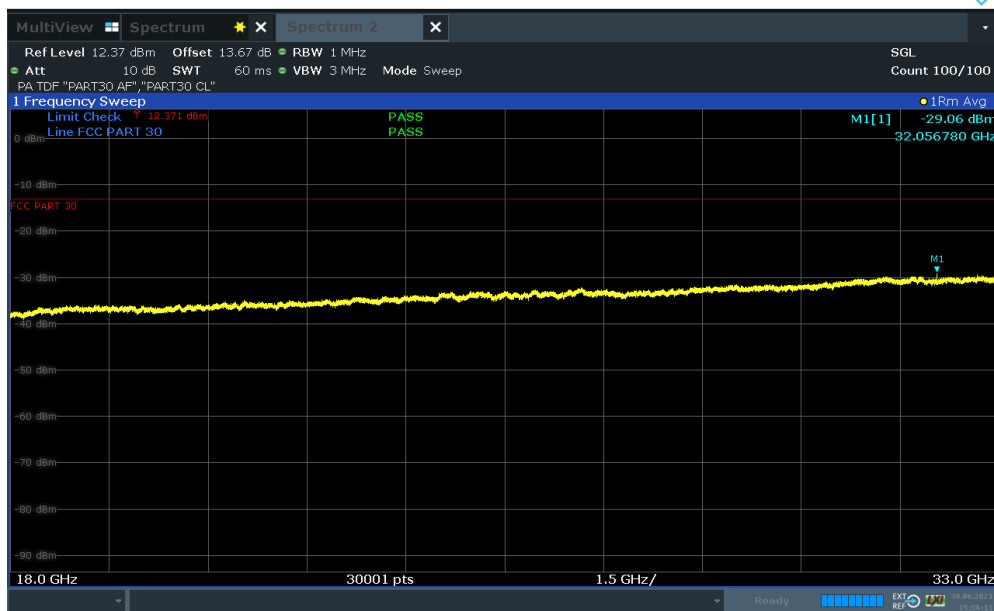

Plot 7-34. Radiated Spurious Plot 18 GHz – 33 GHz (100 MHz BW 8CC QPSK Low Channel Pol. V)

FCC ID: A3LAT1K06-A00		<b>MEASUREMENT REPORT</b> (Class II Permissive Change)		Approved by: Technical Manager
Test Report S/N: 8K21060202-R1.A3L	Test Dates: 06/21/2021-08/31/2021	EUT Type: AU(AT1K06)		Page 40 of 84



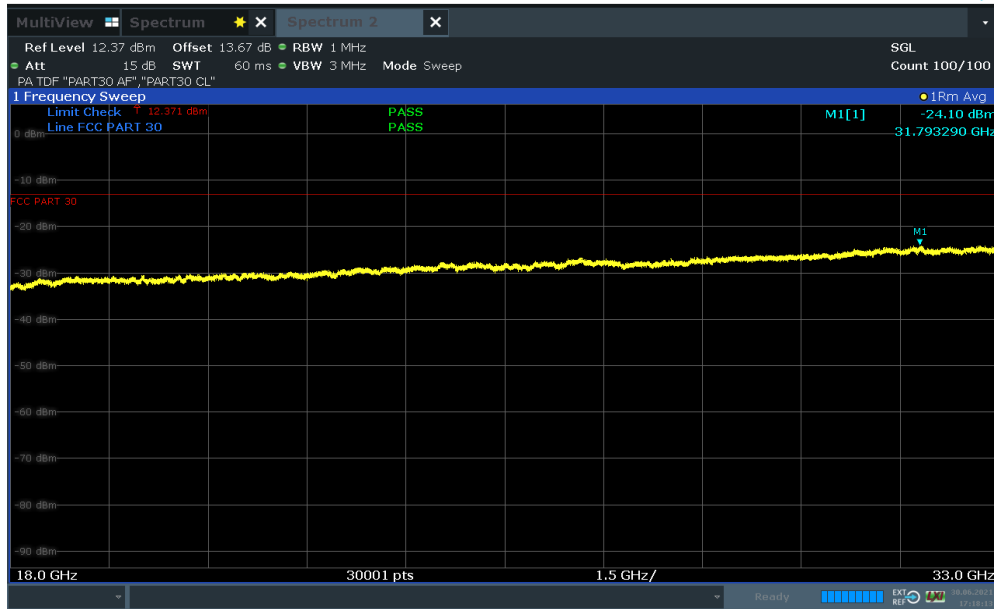

Plot 7-35. Radiated Spurious Plot 18 GHz – 33 GHz (100 MHz BW 8CC QPSK High Channel Pol. H)

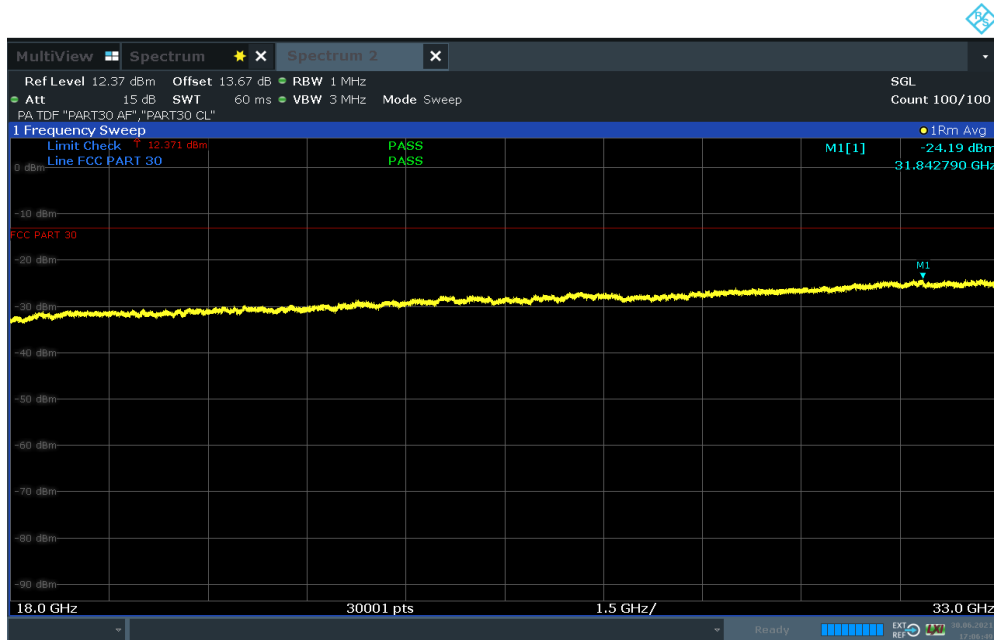

Plot 7-36. Radiated Spurious Plot 18 GHz – 33 GHz (100 MHz BW 8CC QPSK High Channel Pol. V)

FCC ID: A3LAT1K06-A00		<b>MEASUREMENT REPORT</b> (Class II Permissive Change)		<b>Approved by:</b> Technical Manager
<b>Test Report S/N:</b> 8K21060202-R1.A3L	<b>Test Dates:</b> 06/21/2021-08/31/2021	<b>EUT Type:</b> AU(AT1K06)	Page 41 of 84	

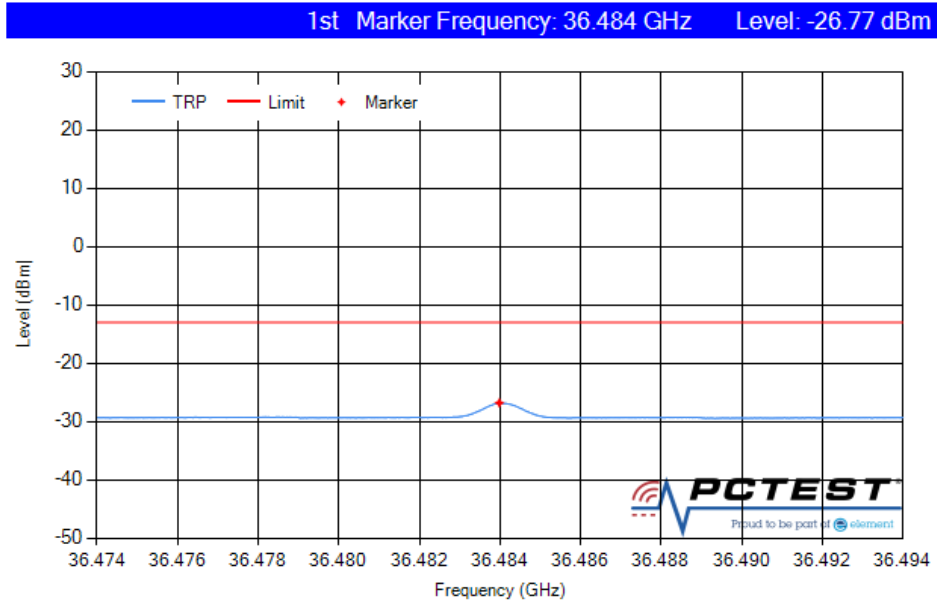

### 7.5.4 Radiated Spurious Emissions Plots (33 GHz to 37 GHz)

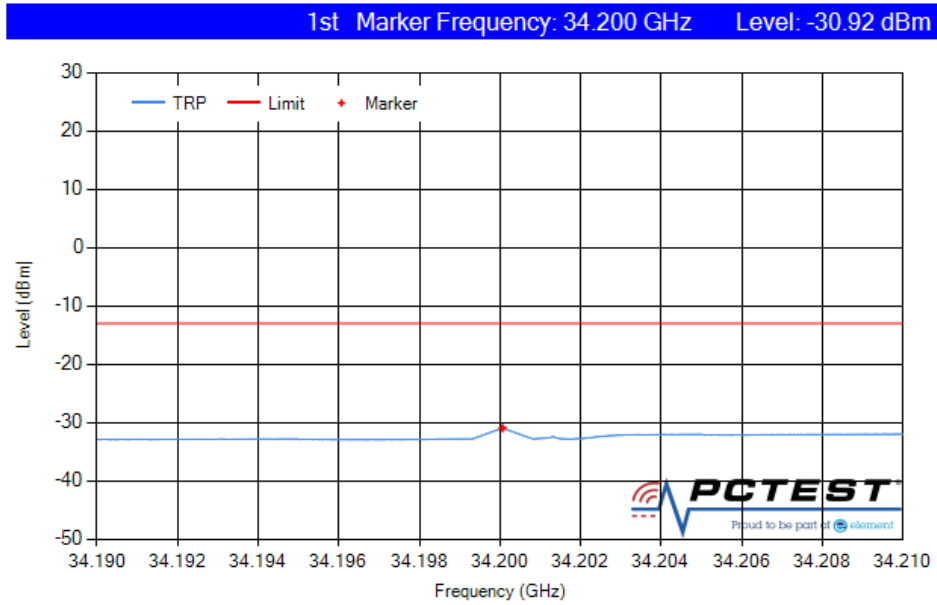

**Plot 7-37. Radiated Spurious Plot 36.474 GHz – 36.494 GHz (100 MHz BW 1CC QPSK Mid Channel TRP)**



**Plot 7-38. Radiated Spurious Plot 34.190 GHz - 34.210 GHz (100 MHz BW 1CC QPSK High Channel TRP)**

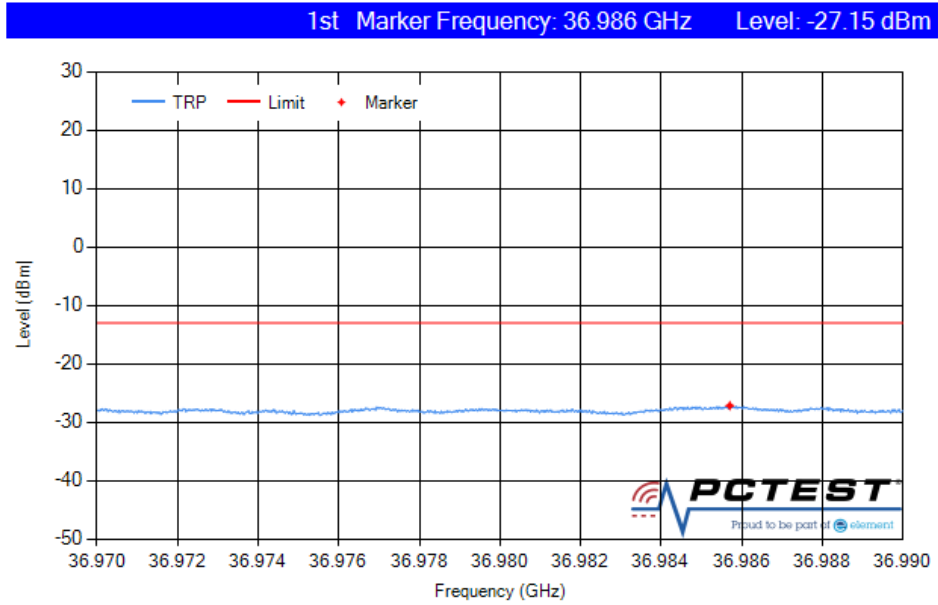

<b>FCC ID:</b> A3LAT1K06-A00	 Proud to be part of 	<b>MEASUREMENT REPORT</b> (Class II Permissive Change)		<b>Approved by:</b> Technical Manager
<b>Test Report S/N:</b> 8K21060202-R1.A3L	<b>Test Dates:</b> 06/21/2021-08/31/2021	<b>EUT Type:</b> AU(AT1K06)	Page 42 of 84	

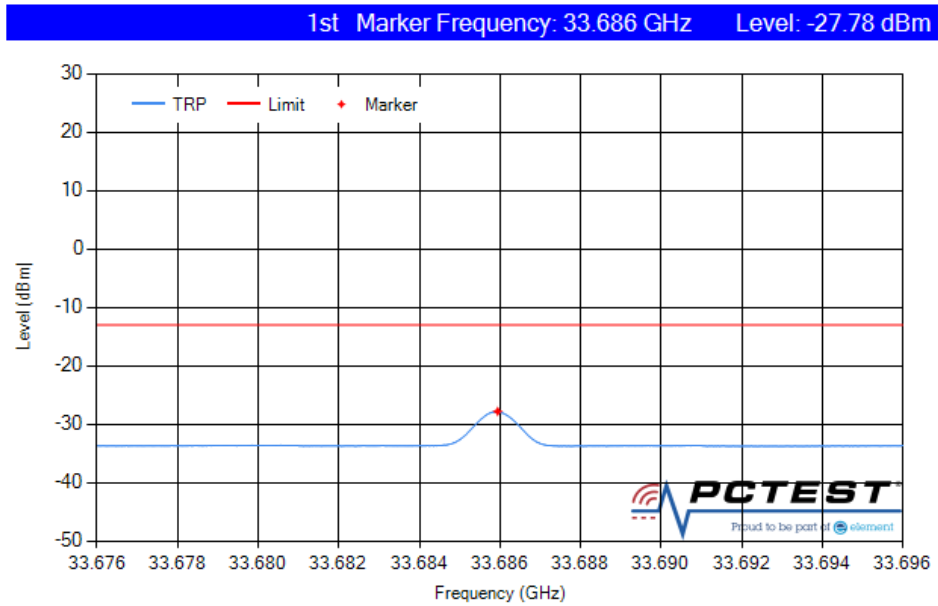

**Plot 7-39. Radiated Spurious Plot 36.970 GHz – 36.990 GHz (100 MHz BW 8CC QPSK Low Channel TRP)**





**Plot 7-40. Radiated Spurious Plot 33.676 GHz – 33.696 GHz (100 MHz BW 8CC QPSK High Channel TRP)**

FCC ID: A3LAT1K06-A00	 <b>PCTEST</b> Proud to be part of 	<b>MEASUREMENT REPORT</b> (Class II Permissive Change)		Approved by: Technical Manager
Test Report S/N: 8K21060202-R1.A3L	Test Dates: 06/21/2021-08/31/2021	EUT Type: AU(AT1K06)		Page 43 of 84

Configuration	Channel	Ant Pol. [Degree]	Frequency [GHz]	RSE EIRP [dBm]	Early Exit?	TRP [dBm]	Margin [dB]
100MHz BW 1CC	Mid	H	36.48	-9.82	No	-26.77	13.77
		V	36.48	-15.99	No <sup>1</sup>		
	High	H	34.20	-3.54	No	-30.92	17.92
		V	34.20	-7.43	No		
100MHz BW 8CC	Low	H	33.69	-10.69	No	-27.15	14.15
		V	33.69	-13.35	No <sup>1</sup>		
	High	H	36.89	-3.75	No	-27.78	14.78
		V	36.90	-8.51	No		

1. "Early Exit" – Less than 3 dB margin

**Table 7-22. Radiated Spurious Emissions (33 GHz to 37 GHz)**

<b>FCC ID:</b> A3LAT1K06-A00	 <small>Proud to be part of element</small>	<b>MEASUREMENT REPORT (Class II Permissive Change)</b>		<b>Approved by:</b> Technical Manager
<b>Test Report S/N:</b> 8K21060202-R1.A3L	<b>Test Dates:</b> 06/21/2021-08/31/2021	<b>EUT Type:</b> AU(AT1K06)	Page 44 of 84	

### 7.5.5 Radiated Spurious Emissions Plots (40 GHz to 60 GHz)

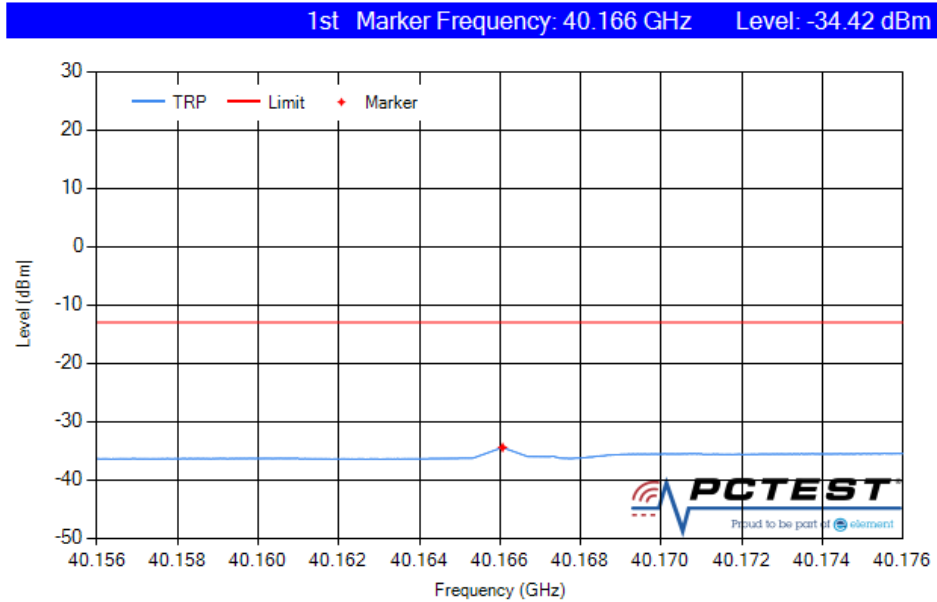

Plot 7-41. Radiated Spurious Plot 40.156 GHz – 60 GHz (100 MHz BW 1CC QPSK Mid Channel TRP)

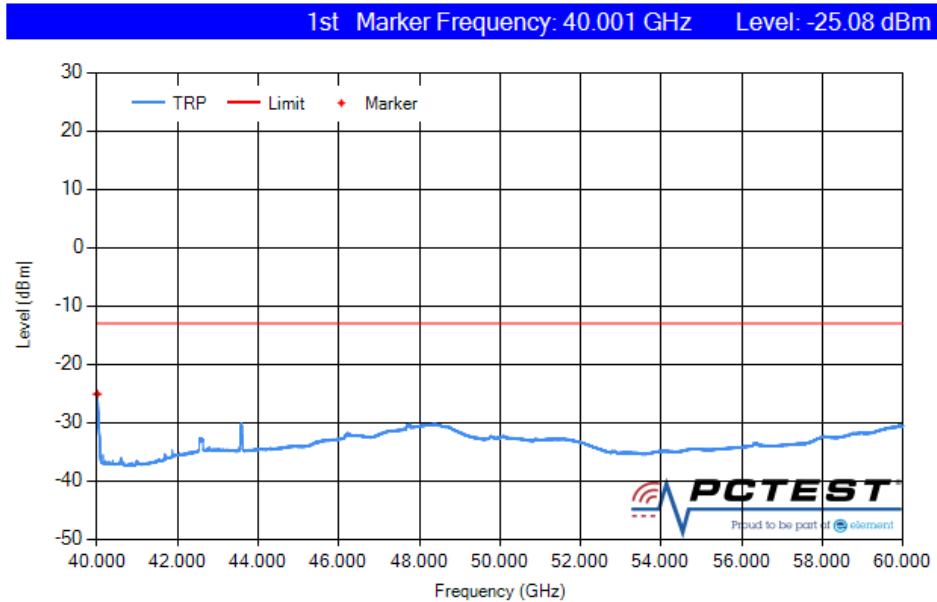

Plot 7-42. Radiated Spurious Plot 40 GHz – 60 GHz (100 MHz BW 1CC QPSK High Channel TRP)

FCC ID: A3LAT1K06-A00	<b>PCTEST</b> Proud to be part of element	MEASUREMENT REPORT (Class II Permissive Change)	<b>SAMSUNG</b>	Approved by: Technical Manager
Test Report S/N: 8K21060202-R1.A3L	Test Dates: 06/21/2021-08/31/2021	EUT Type: AU(AT1K06)		Page 45 of 84

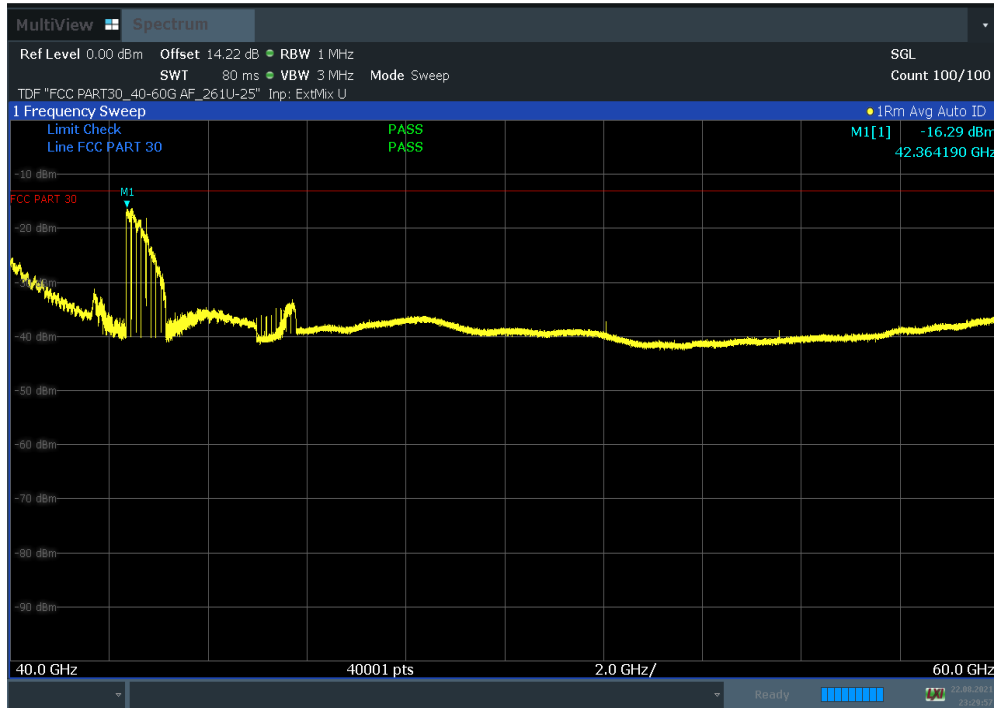

Plot 7-43. Radiated Spurious Plot 40 GHz – 60 GHz (100 MHz 8CC CC BW QPSK Low Channel Pol. V)



Plot 7-44. Radiated Spurious Plot 40 GHz – 60 GHz (100 MHz 8CC CC BW QPSK Low Channel Pol. H)

FCC ID: A3LAT1K06-A00	<b>PCTEST</b> Proud to be part of element	MEASUREMENT REPORT (Class II Permissive Change)	<b>SAMSUNG</b>	Approved by: Technical Manager
Test Report S/N: 8K21060202-R1.A3L	Test Dates: 06/21/2021-08/31/2021	EUT Type: AU(AT1K06)		Page 46 of 84

1st Marker Frequency: 40.014 GHz Level: -25.33 dBm

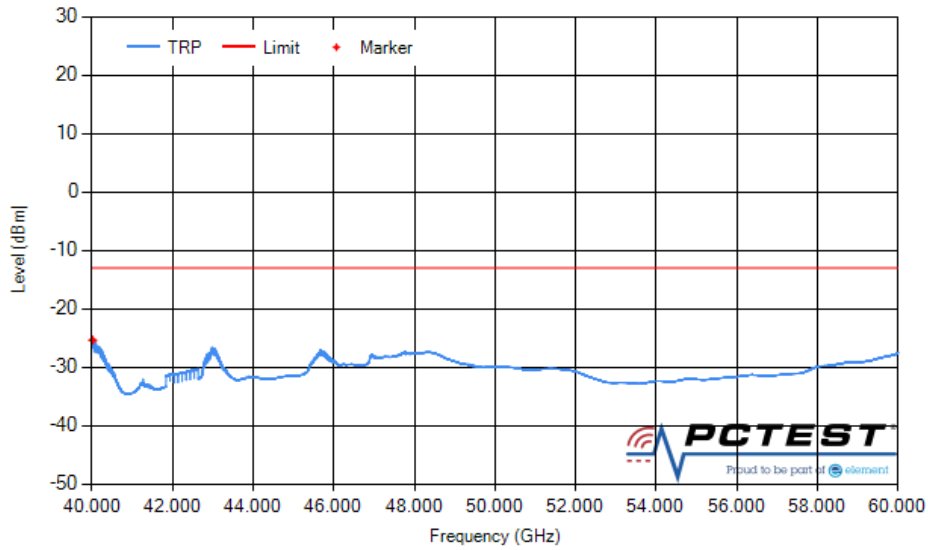

**Plot 7-45. Radiated Spurious Plot 40 GHz – 60 GHz (100 MHz BW 8CC QPSK High Channel TRP)**

<b>FCC ID:</b> A3LAT1K06-A00		<b>MEASUREMENT REPORT (Class II Permissive Change)</b>		<b>Approved by:</b> Technical Manager
<b>Test Report S/N:</b> 8K21060202-R1.A3L	<b>Test Dates:</b> 06/21/2021-08/31/2021	<b>EUT Type:</b> AU(AT1K06)	Page 47 of 84	

## Spurious Emissions EIRP Sample Calculation (n260)

The raw radiated spurious level is converted to field strength in dBμV/m. Then, the RSE EIRP level is calculated by applying the additional factors shown below for a test distance of 3.2 meters.

**RSE EIRP (dBm) = Analyzer Level (dBm) + Antenna Factor (dB/m) + Offset (dB)\* + Harmonic Mixer Conversion Loss (dB)**



\* Offset = IF Cable Loss (dB) + 107 + 20Log(D<sub>m</sub>) – 104.8 + Duty cycle (dB)  
= 0.55 + 107 + 20Log(3.2m) – 104.8 + 1.37 dB = 14.22 dB

Frequency [GHz]	Config uration	Channel	Modulation	Ant. Pol.	Analyzer Level	Antenna Factor	Offset	Mixer	RSE EIRP	Early Exit?	TRP	Margin
				[H/V]	[dBm]	[dBm]	[dB]	[dB]	[dBm]		[dBm]	[dB]
40.18	1CC	Mid	QPSK	H	-91.49	38.80	14.22	9.81	-28.66	Yes	-34.42	21.42
40.16	1CC	Mid	QPSK	V	-70.12	38.80	14.22	9.82	-7.28	No		
42.54	1CC	High	QPSK	H	-94.39	38.86	14.22	11.61	-29.70	Yes	-25.08	12.08
40.02	1CC	High	QPSK	V	-71.64	38.80	14.22	9.85	-8.77	No		
42.36	8CC	Low	QPSK	V	-80.73	38.80	14.22	11.42	-16.29	Yes	-	3.29
42.74	8CC	Low	QPSK	H	-86.48	38.96	14.22	11.40	-21.90	Yes	-	8.90
40.00	8CC	High	QPSK	H	-54.26	38.80	14.22	9.85	8.61	No	-25.33	12.33
42.32	8CC	High	QPSK	V	-82.85	38.80	14.22	11.36	-18.47	Yes		

**Table 7-23. Radiated Spurious Emissions (40 GHz to 60 GHz)**

### Notes

The RSE EIRP level is taken directly from the spectrum analyzer which includes the appropriate antenna factors, and cable losses and harmonic mixer conversion losses. Measurements were performed at a distance of 3.2 meter.

FCC ID: A3LAT1K06-A00		MEASUREMENT REPORT (Class II Permissive Change)		Approved by: Technical Manager
Test Report S/N: 8K21060202-R1.A3L	Test Dates: 06/21/2021-08/31/2021	EUT Type: AU(AT1K06)		Page 48 of 84



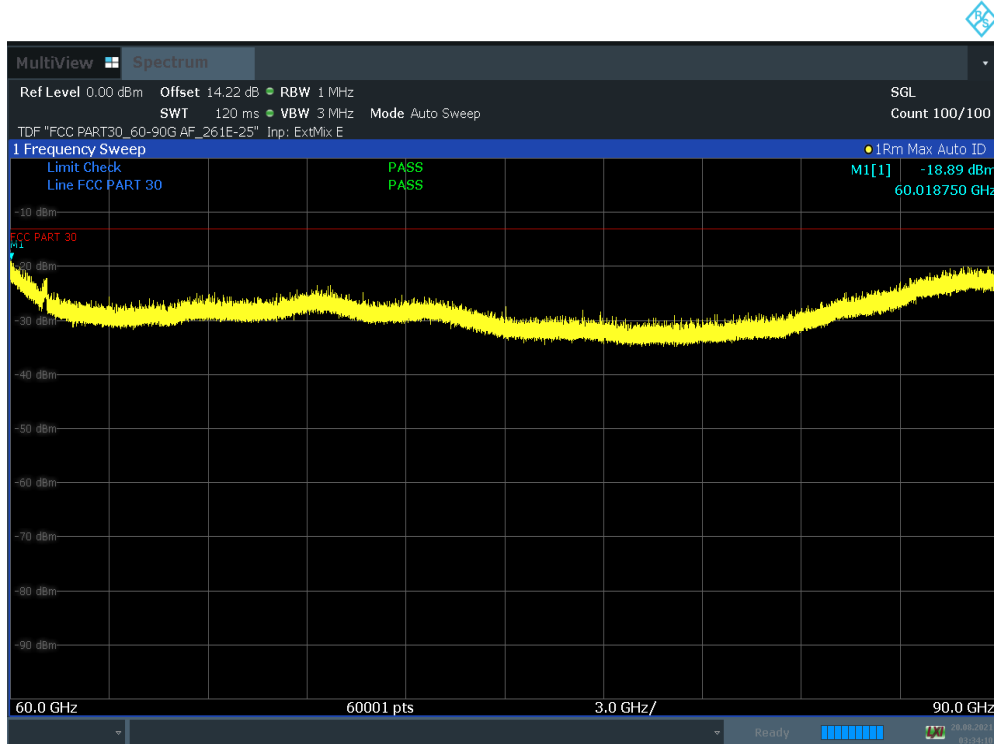

## 7.5.6 Radiated Spurious Emissions Plots (60 GHz to 90 GHz)

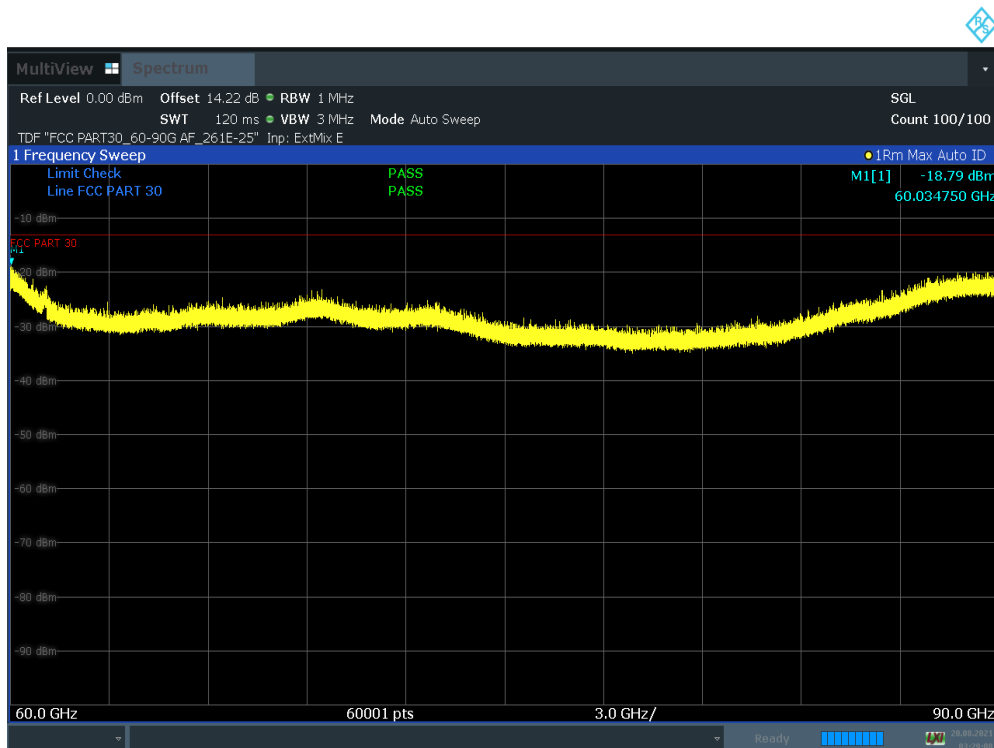

Plot 7-46. Radiated Spurious Plot 60 GHz – 90 GHz (100 MHz BW 1CC QPSK Mid Channel Pol. H)



FCC ID: A3LAT1K06-A00		MEASUREMENT REPORT (Class II Permissive Change)		Approved by: Technical Manager
Test Report S/N: 8K21060202-R1.A3L	Test Dates: 06/21/2021-08/31/2021	EUT Type: AU(AT1K06)		Page 49 of 84

**Plot 7-47. Radiated Spurious Plot 60 GHz – 90 GHz (100 MHz BW 1CC QPSK Mid Channel Pol. V)**

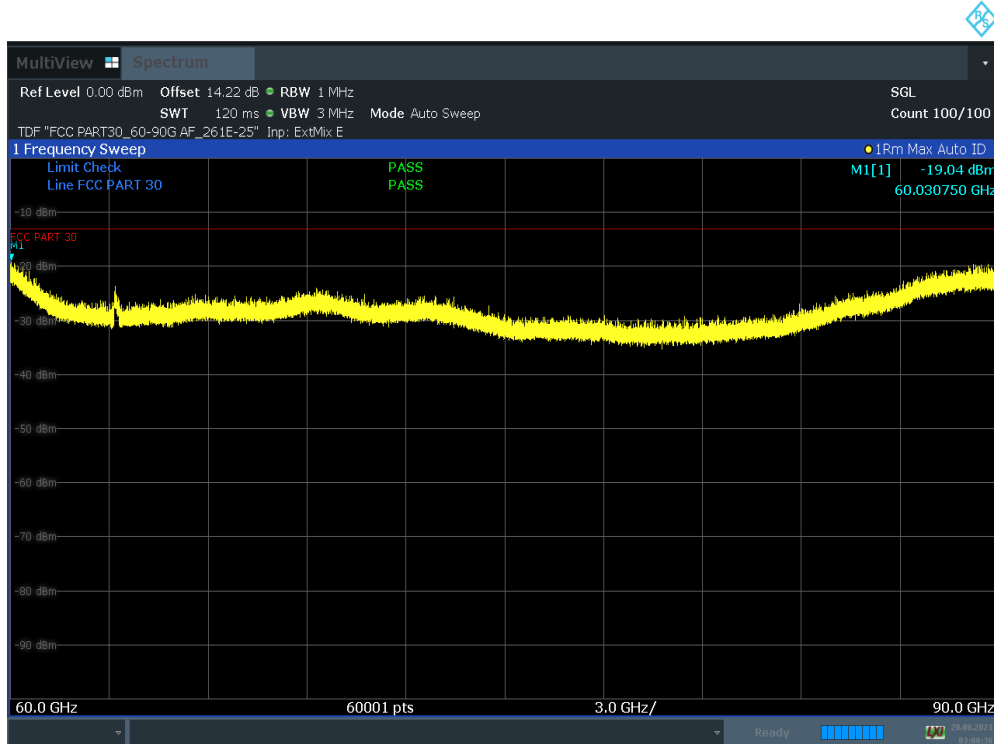

**Plot 7-48. Radiated Spurious Plot 60 GHz – 90 GHz (100 MHz BW 1CC QPSK High Channel Pol. H)**

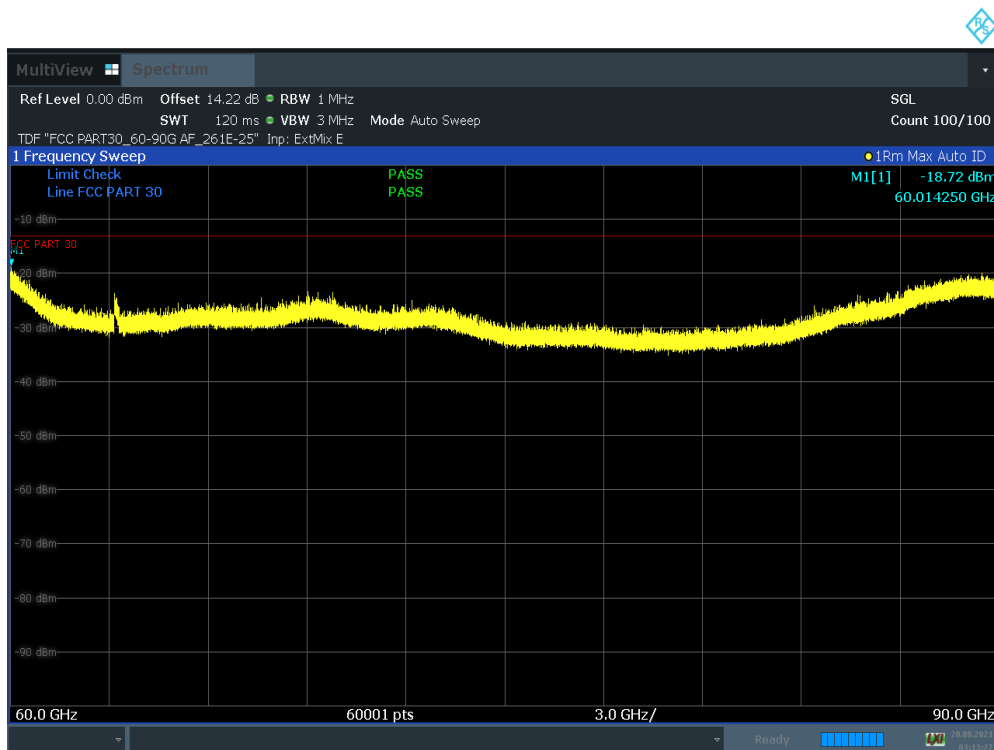

**Plot 7-49. Radiated Spurious Plot 60 GHz – 90 GHz (100 MHz BW 1CC QPSK High Channel Pol. V)**

FCC ID: A3LAT1K06-A00	<b>PCTEST</b> Proud to be part of element	<b>MEASUREMENT REPORT</b> (Class II Permissive Change)	<b>SAMSUNG</b>	Approved by: Technical Manager
Test Report S/N: 8K21060202-R1.A3L	Test Dates: 06/21/2021-08/31/2021	EUT Type: AU(AT1K06)		Page 50 of 84

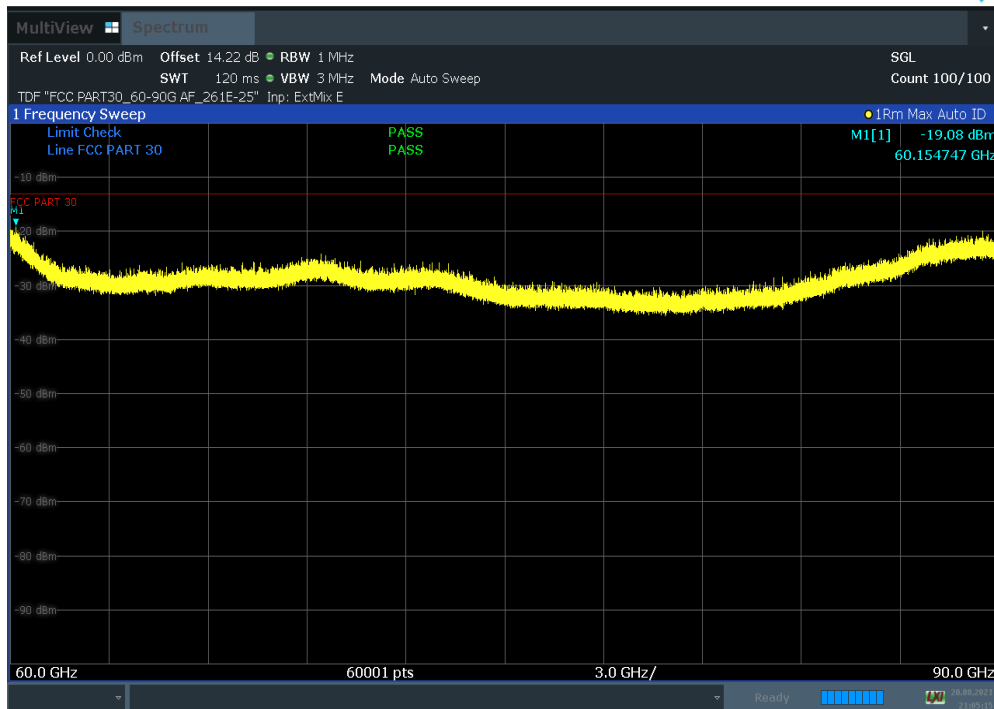

Plot 7-50. Radiated Spurious Plot 60 GHz – 90 GHz (100 MHz BW 8CC QPSK Low Channel Pol. H)

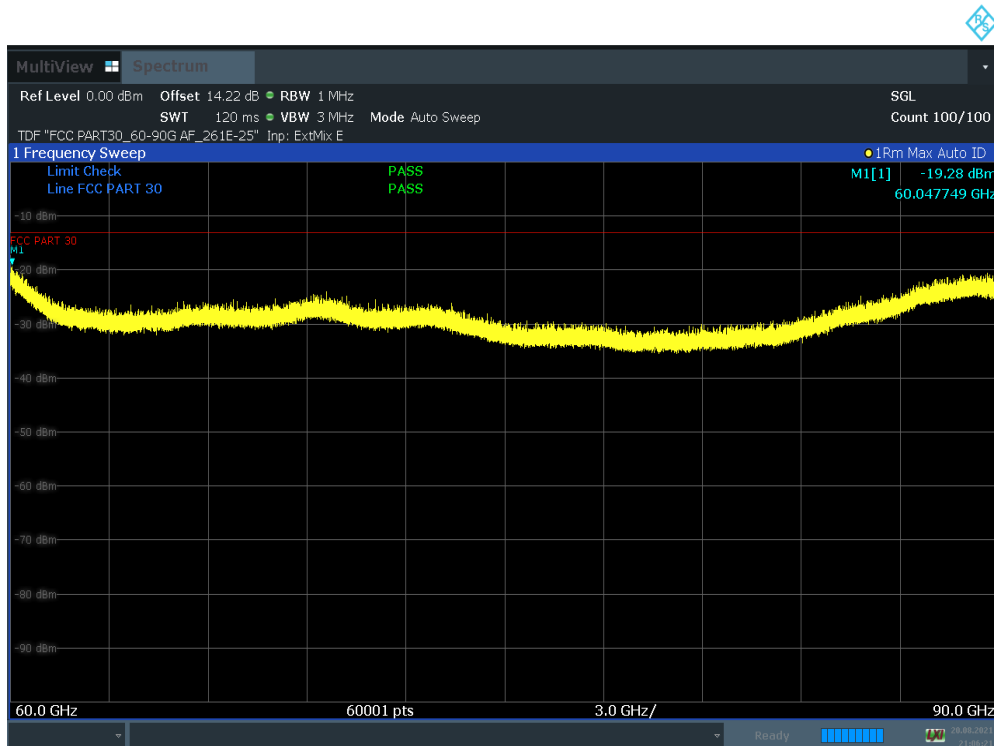

Plot 7-51. Radiated Spurious Plot 60 GHz – 90 GHz (100 MHz BW 8CC QPSK Low Channel Pol. V)

FCC ID: A3LAT1K06-A00	<b>PCTEST</b> Proud to be part of element	MEASUREMENT REPORT (Class II Permissive Change)	<b>SAMSUNG</b>	Approved by: Technical Manager
Test Report S/N: 8K21060202-R1.A3L	Test Dates: 06/21/2021-08/31/2021	EUT Type: AU(AT1K06)		Page 51 of 84

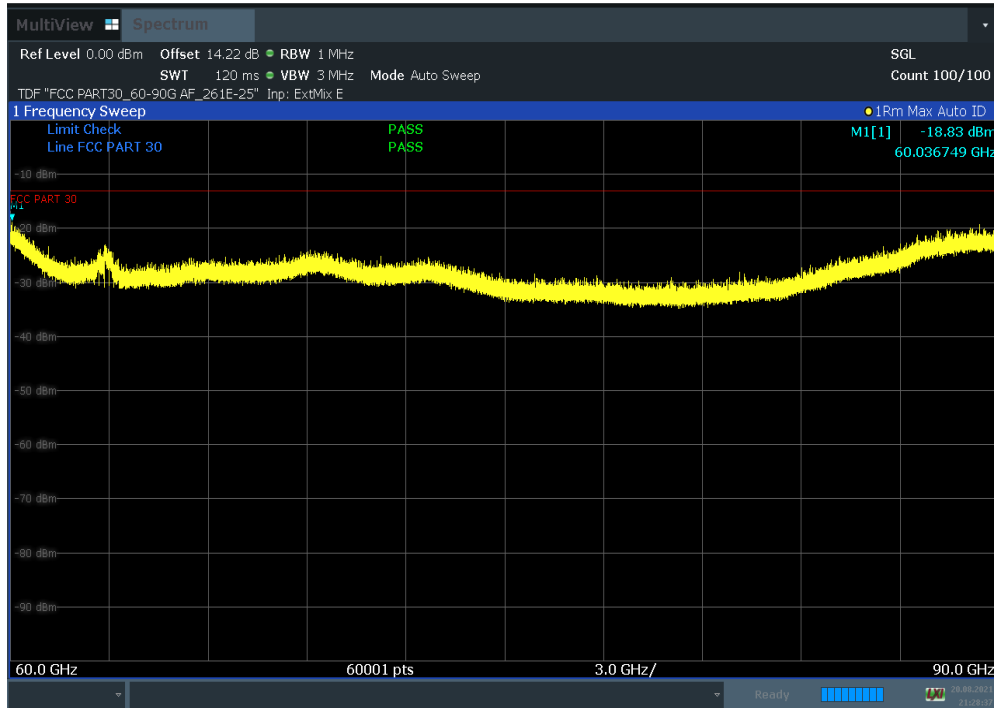

Plot 7-52. Radiated Spurious Plot 60 GHz – 90 GHz (100 MHz BW 8CC QPSK High Channel Pol. H)

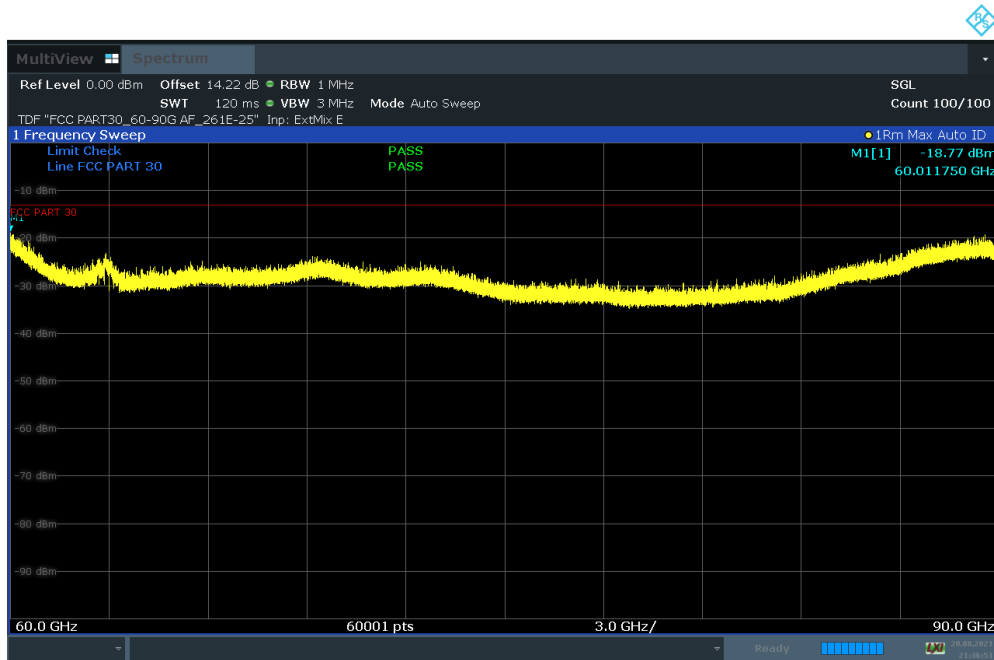

Plot 7-53. Radiated Spurious Plot 60 GHz – 90 GHz (100 MHz BW 8CC QPSK High Channel Pol. V)

FCC ID: A3LAT1K06-A00	PCTEST Proud to be part of element	MEASUREMENT REPORT (Class II Permissive Change)		Approved by: Technical Manager
Test Report S/N: 8K21060202-R1.A3L	Test Dates: 06/21/2021-08/31/2021	EUT Type: AU(AT1K06)		Page 52 of 84

## Spurious Emissions EIRP Sample Calculation (n260)

The raw radiated spurious level is converted to field strength in dBμV/m. Then, the RSE EIRP level is calculated by applying the additional factors shown below for a test distance of 3.2 meters.

**RSE EIRP (dBm) = Analyzer Level (dBm) + Antenna Factor (dB/m) + Offset (dB)\* + Harmonic Mixer Conversion Loss (dB)**



\* Offset = IF Cable Loss (dB/m) + 107 + 20Log(D<sub>m</sub>) – 104.8 + Duty cycle (dB)  
= 0.55 + 107 + 20Log(3.2m) – 104.8 + 1.37 dB = 14.22 dB

Frequency [GHz]	Config uration	Channel	Modulation	Ant. Pol.	Analyzer Level	Antenna Factor	Offset	Mixer	RSE EIRP	Margin
				[H/V]	[dBm]	[dBm]	[dB]	[dB]	[dBm]	[dB]
60.02	1CC	Mid	QPSK	H	-101.78	42.28	14.22	26.39	-18.89	5.89
60.03	1CC	Mid	QPSK	V	-101.62	42.27	14.22	26.34	-18.79	5.79
60.03	1CC	High	QPSK	H	-101.87	42.27	14.22	26.34	-19.04	6.04
60.01	1CC	High	QPSK	V	-101.68	42.29	14.22	26.45	-18.72	5.72
60.15	8CC	Low	QPSK	H	-101.20	42.20	14.22	25.70	-19.08	6.08
60.05	8CC	Low	QPSK	V	-101.98	42.25	14.22	26.23	-19.28	6.28
60.04	8CC	High	QPSK	H	-101.60	42.26	14.22	26.29	-18.83	5.83
60.01	8CC	High	QPSK	V	-101.73	42.29	14.22	26.45	-18.77	5.77

**Table 7-24. Radiated Spurious Emissions (60 GHz to 90 GHz)**

### Notes

The RSE EIRP level is taken directly from the spectrum analyzer which includes the appropriate antenna factors, and cable losses and harmonic mixer conversion losses. Measurements were performed at a distance of 3.2 meter.

FCC ID: A3LAT1K06-A00		MEASUREMENT REPORT (Class II Permissive Change)		Approved by: Technical Manager
Test Report S/N: 8K21060202-R1.A3L	Test Dates: 06/21/2021-08/31/2021	EUT Type: AU(AT1K06)		Page 53 of 84

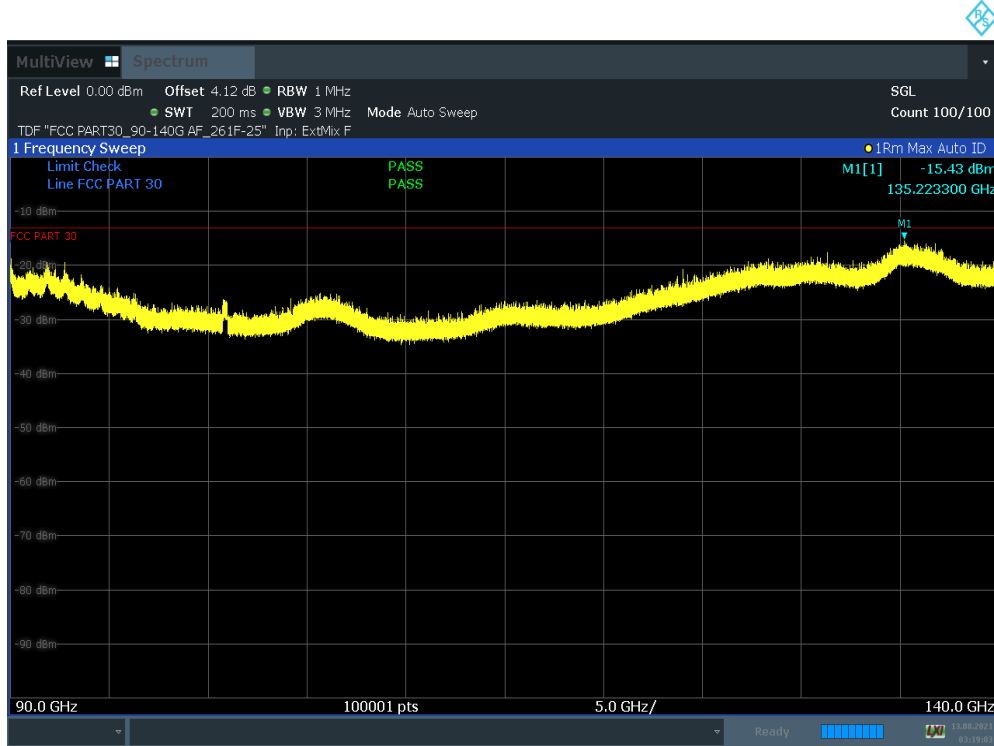

### 7.5.7 Radiated Spurious Emissions Plots (90 GHz – 140 GHz)

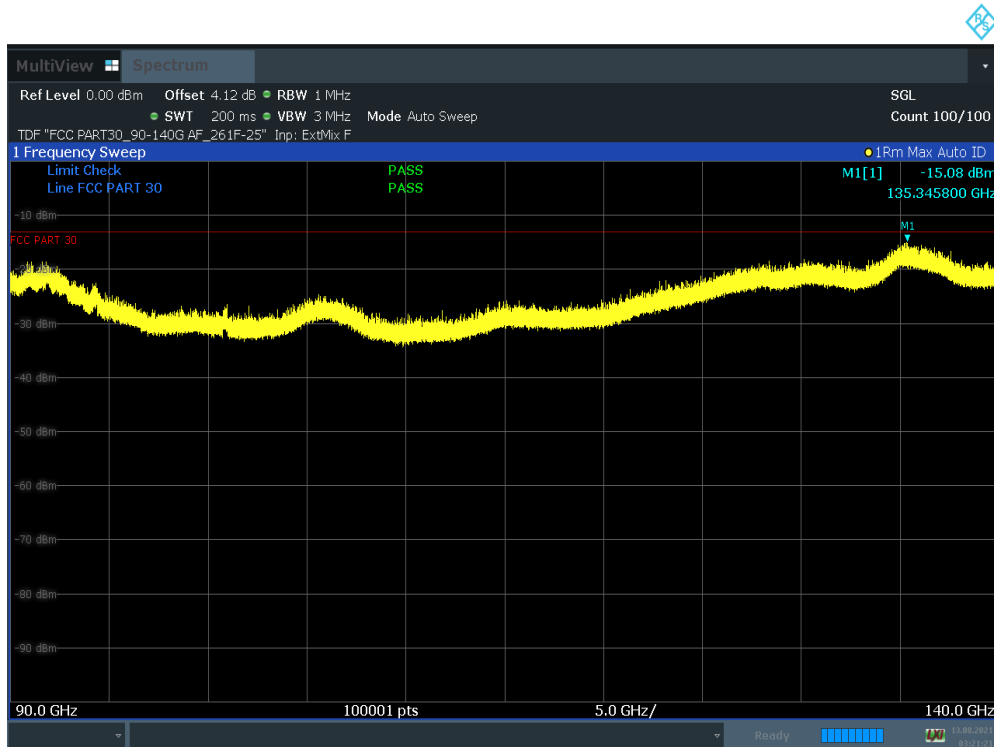

Plot 7-54. Radiated Spurious Plot 90 GHz – 140 GHz (100 MHz BW 1CC QPSK Mid Channel Pol. H)



Plot 7-55. Radiated Spurious Plot 90 GHz – 140 GHz (100 MHz BW 1CC QPSK Mid Channel Pol. V)

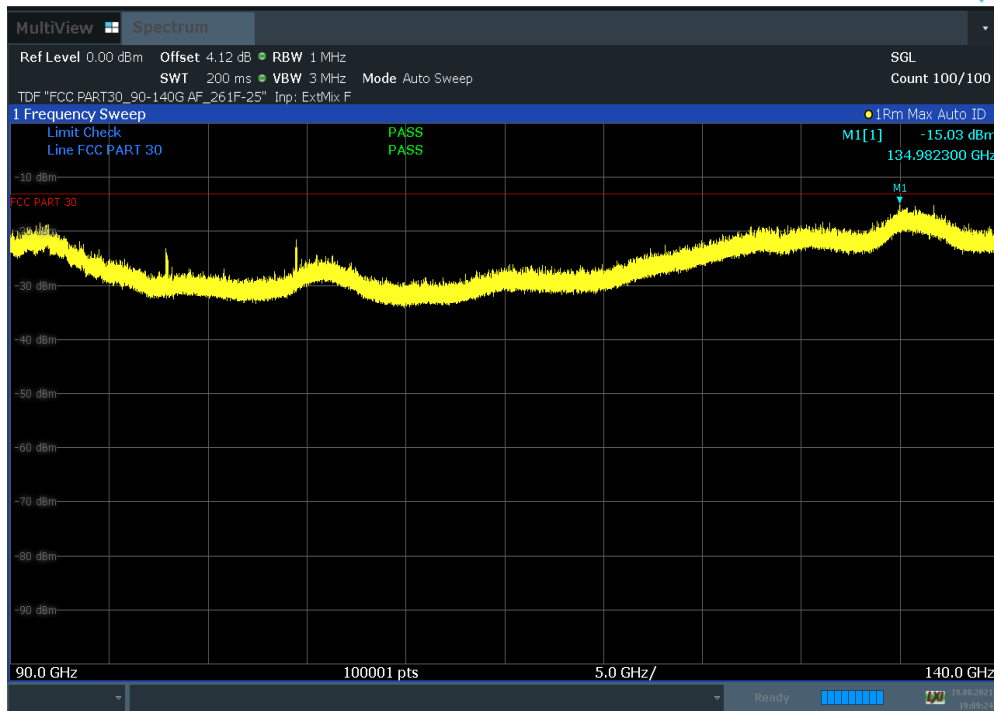

FCC ID: A3LAT1K06-A00		MEASUREMENT REPORT (Class II Permissive Change)		Approved by: Technical Manager
Test Report S/N: 8K21060202-R1.A3L	Test Dates: 06/21/2021-08/31/2021	EUT Type: AU(AT1K06)		Page 54 of 84

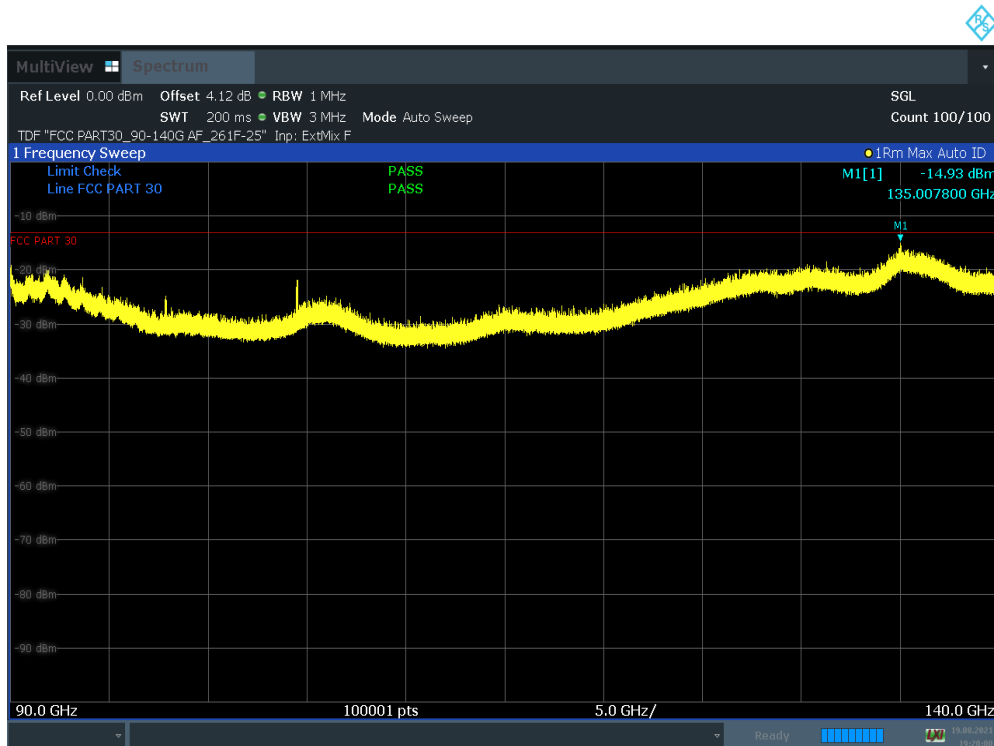

Plot 7-56. Radiated Spurious Plot 90 GHz – 140 GHz (100 MHz BW 1CC QPSK High Channel Pol. H)



Plot 7-57. Radiated Spurious Plot 90 GHz – 140 GHz (100 MHz BW 1CC QPSK High Channel Pol. V)

FCC ID: A3LAT1K06-A00		MEASUREMENT REPORT (Class II Permissive Change)		Approved by: Technical Manager
Test Report S/N: 8K21060202-R1.A3L	Test Dates: 06/21/2021-08/31/2021	EUT Type: AU(AT1K06)		Page 55 of 84

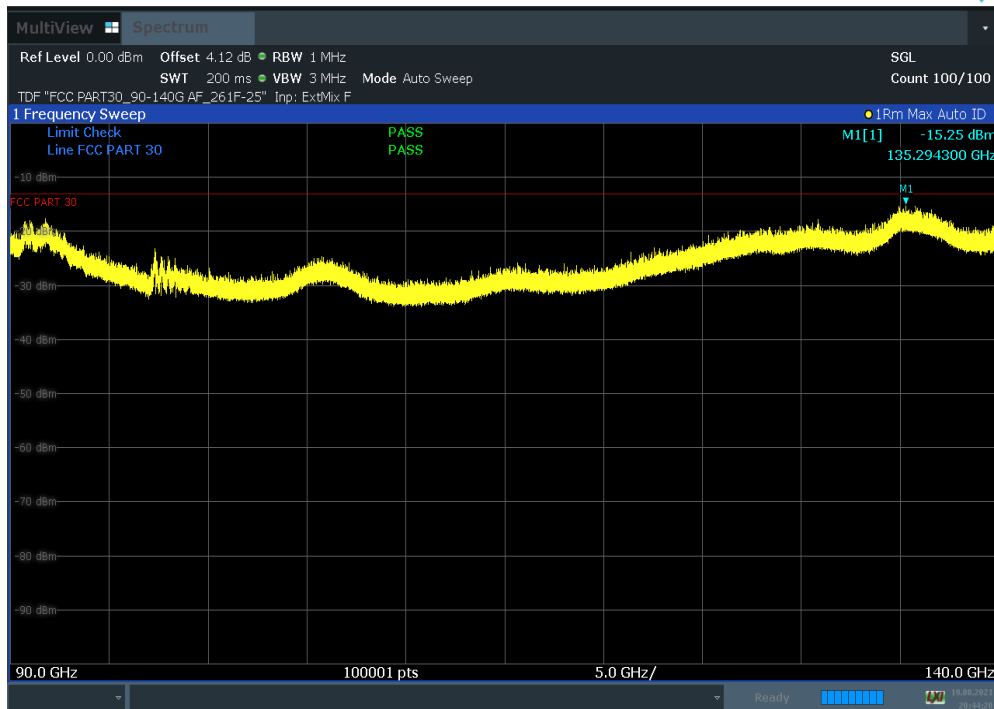

Plot 7-58. Radiated Spurious Plot 90 GHz – 140 GHz (100 MHz BW 8CC QPSK Low Channel Pol. H)

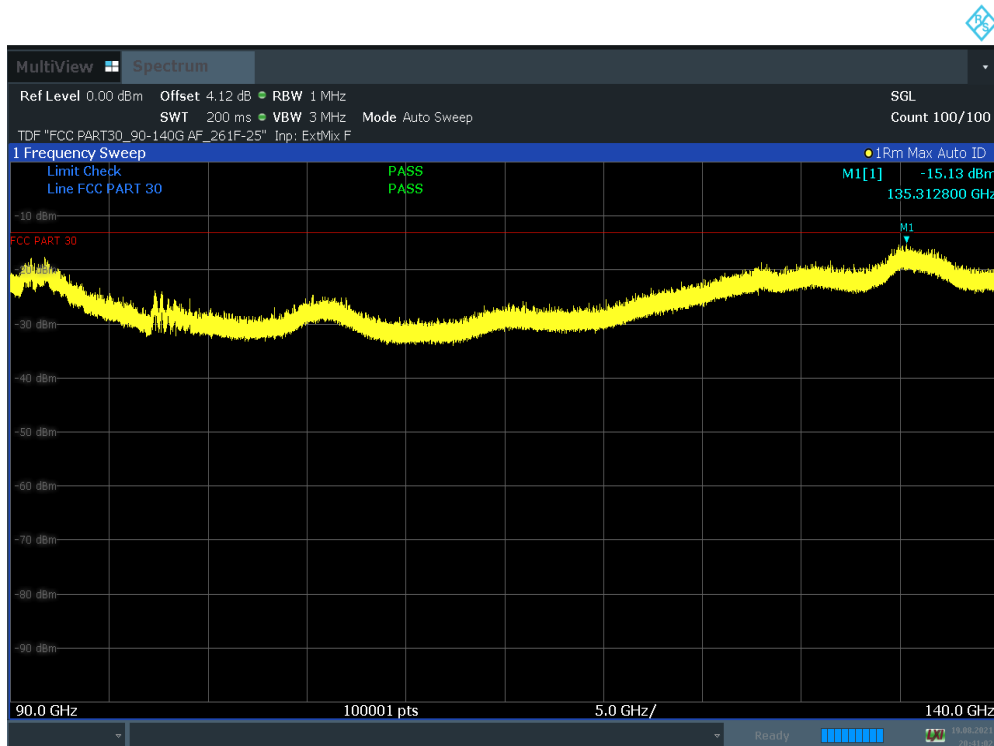

Plot 7-59. Radiated Spurious Plot 90 GHz – 140 GHz (100 MHz BW 8CC QPSK Low Channel Pol. V)

FCC ID: A3LAT1K06-A00	PCTEST Proud to be part of element	MEASUREMENT REPORT (Class II Permissive Change)	SAMSUNG	Approved by: Technical Manager
Test Report S/N: 8K21060202-R1.A3L	Test Dates: 06/21/2021-08/31/2021	EUT Type: AU(AT1K06)		Page 56 of 84



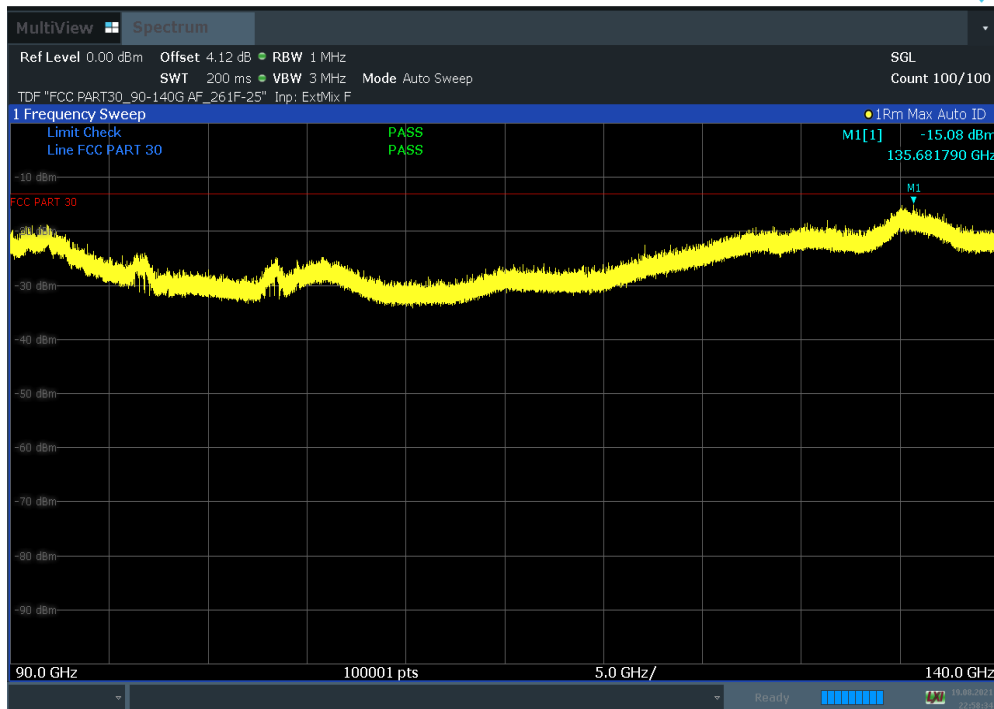

Plot 7-60. Radiated Spurious Plot 90 GHz – 140 GHz (100 MHz BW 8CC QPSK High Channel Pol. H)

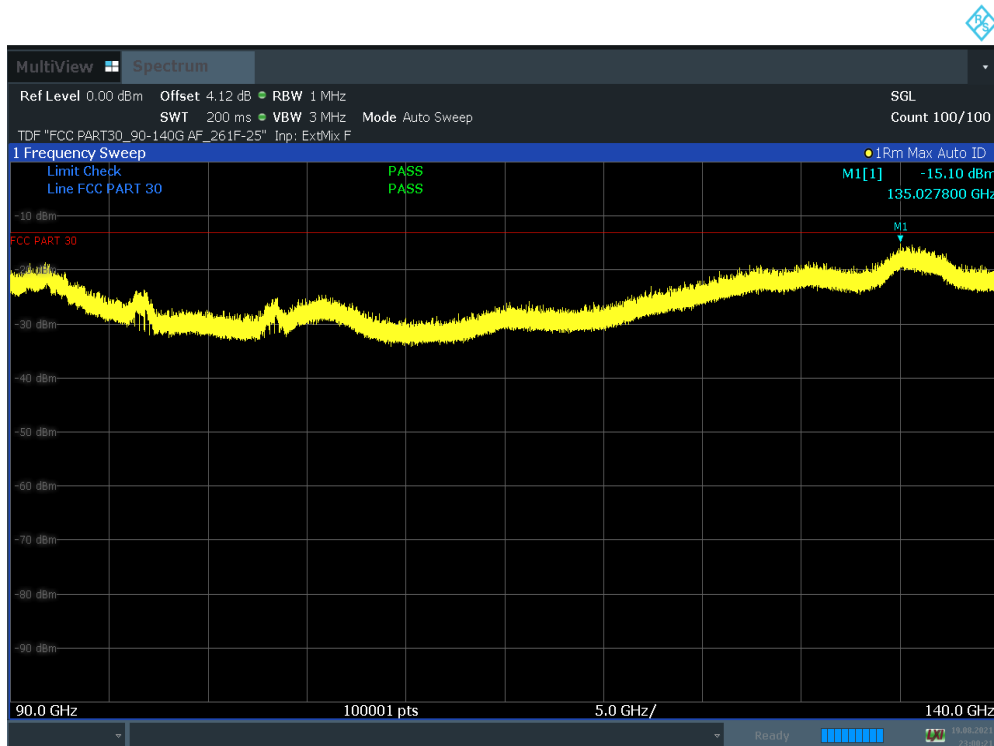

Plot 7-61. Radiated Spurious Plot 90 GHz – 140 GHz (100 MHz BW 8CC QPSK High Channel Pol. V)

FCC ID: A3LAT1K06-A00	<b>PCTEST</b> Proud to be part of element	MEASUREMENT REPORT (Class II Permissive Change)	<b>SAMSUNG</b>	Approved by: Technical Manager
Test Report S/N: 8K21060202-R1.A3L	Test Dates: 06/21/2021-08/31/2021	EUT Type: AU(AT1K06)		Page 57 of 84

## Spurious Emissions EIRP Sample Calculation (n260)

The raw radiated spurious level is converted to field strength in dBμV/m. Then, the RSE EIRP level is calculated by applying the additional factors shown below for a test distance of 1 meters.

**RSE EIRP (dBm) = Analyzer Level (dBm) + Antenna Factor (dB/m) + Offset (dB)\* + Harmonic Mixer Conversion Loss (dB)**



\* Offset = IF Cable Loss (dB/m) + 107 + 20Log(D<sub>m</sub>) – 104.8 + Duty cycle (dB)  
= 0.55 + 107 + 20Log(1m) – 104.8 + 1.37 dB = 4.12 dB

Frequency [GHz]	Config uration	Channel	Modulation	Ant. Pol. [H/V]	Analyzer Level [dBm]	Antenna Factor [dBm]	Offset [dB]	Mixer [dB]	RSE EIRP [dBm]	Margin [dB]
135.22	1CC	Mid	QPSK	H	-100.15	46.91	4.12	33.69	-15.43	2.43
135.35	1CC	Mid	QPSK	V	-99.74	46.91	4.12	33.63	-15.08	2.08
134.98	1CC	High	QPSK	H	-99.79	46.90	4.12	33.74	-15.03	2.03
135.01	1CC	High	QPSK	V	-99.75	46.90	4.12	33.80	-14.93	1.93
135.29	8CC	Low	QPSK	H	-99.94	46.91	4.12	33.66	-15.25	2.25
135.31	8CC	Low	QPSK	V	-99.81	46.91	4.12	33.65	-15.13	2.13
135.68	8CC	High	QPSK	H	-99.58	46.92	4.12	33.46	-15.08	2.08
135.03	8CC	High	QPSK	V	-99.91	46.90	4.12	33.79	-15.10	2.10

**Table 7-25. Radiated Spurious Emissions (90 GHz to 140 GHz)**

### Notes

The RSE EIRP level is taken directly from the spectrum analyzer which includes the appropriate antenna factors, and cable losses and harmonic mixer conversion losses. Measurements were performed at a distance of 1 meter.

FCC ID: A3LAT1K06-A00		MEASUREMENT REPORT (Class II Permissive Change)		Approved by: Technical Manager
Test Report S/N: 8K21060202-R1.A3L	Test Dates: 06/21/2021-08/31/2021	EUT Type: AU(AT1K06)		Page 58 of 84

## 7.5.8 Radiated Spurious Emissions Plots (140 GHz – 170 GHz)

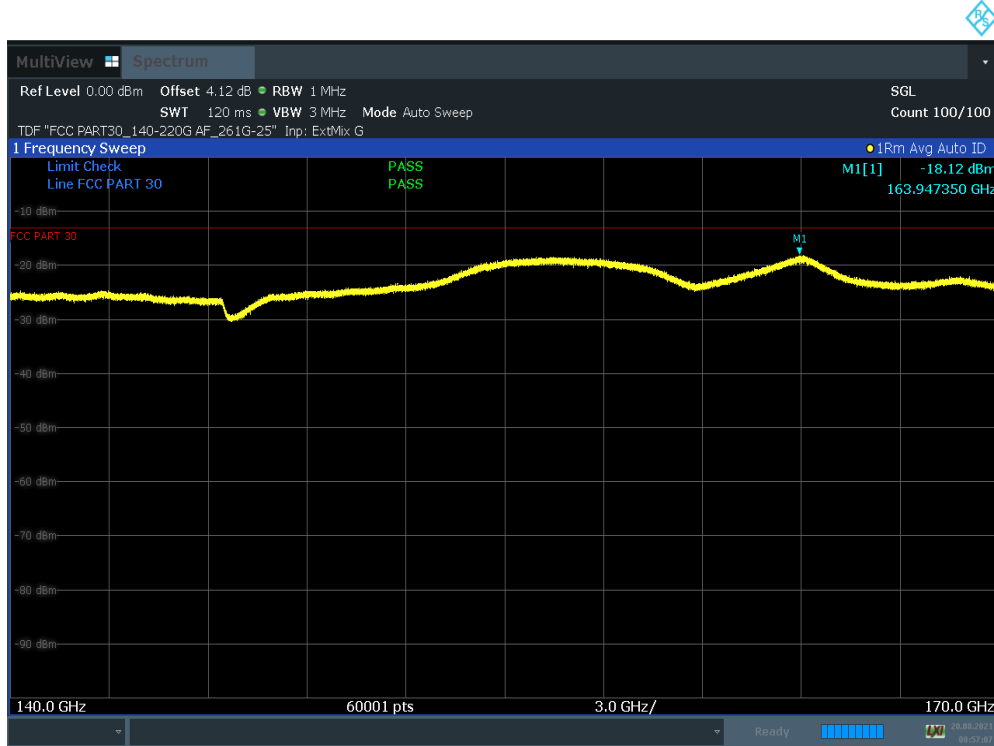

Plot 7-62. Radiated Spurious Plot 140 GHz – 170 GHz (100 MHz BW 1CC QPSK Mid Channel Pol. H)

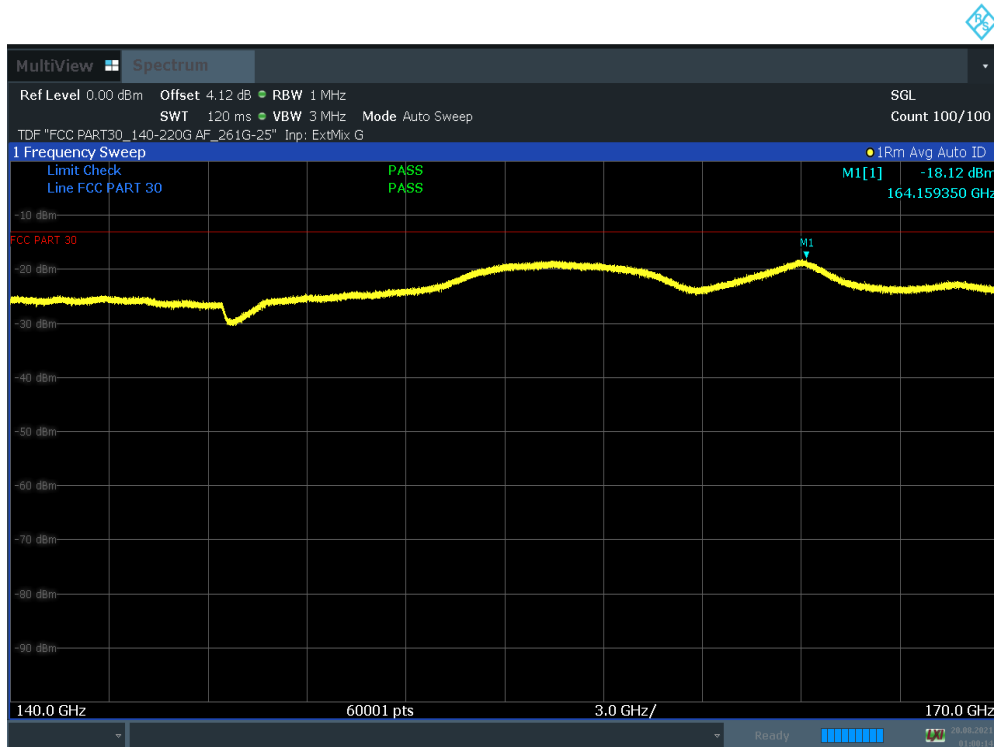

Plot 7-63. Radiated Spurious Plot 140 GHz – 170 GHz (100 MHz BW 1CC QPSK Mid Channel Pol. V)

FCC ID: A3LAT1K06-A00	PCTEST Proud to be part of element	MEASUREMENT REPORT (Class II Permissive Change)	SAMSUNG	Approved by: Technical Manager
Test Report S/N: 8K21060202-R1.A3L	Test Dates: 06/21/2021-08/31/2021	EUT Type: AU(AT1K06)		Page 59 of 84

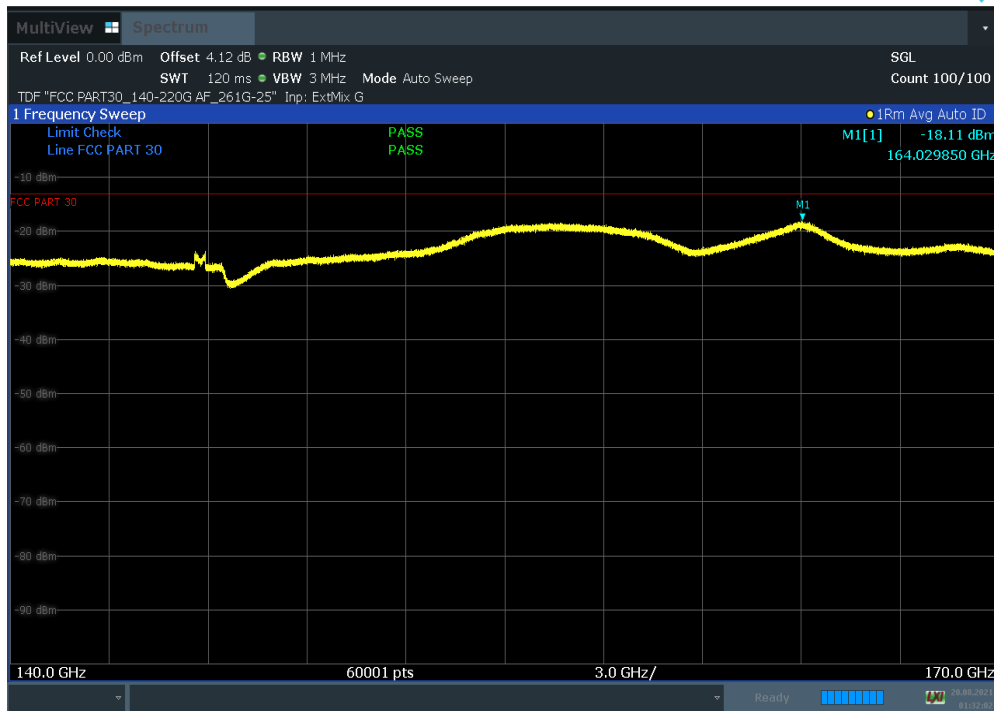

**Plot 7-64. Radiated Spurious Plot 140 GHz – 170 GHz (100 MHz BW 1CC QPSK High Channel Pol. H)**

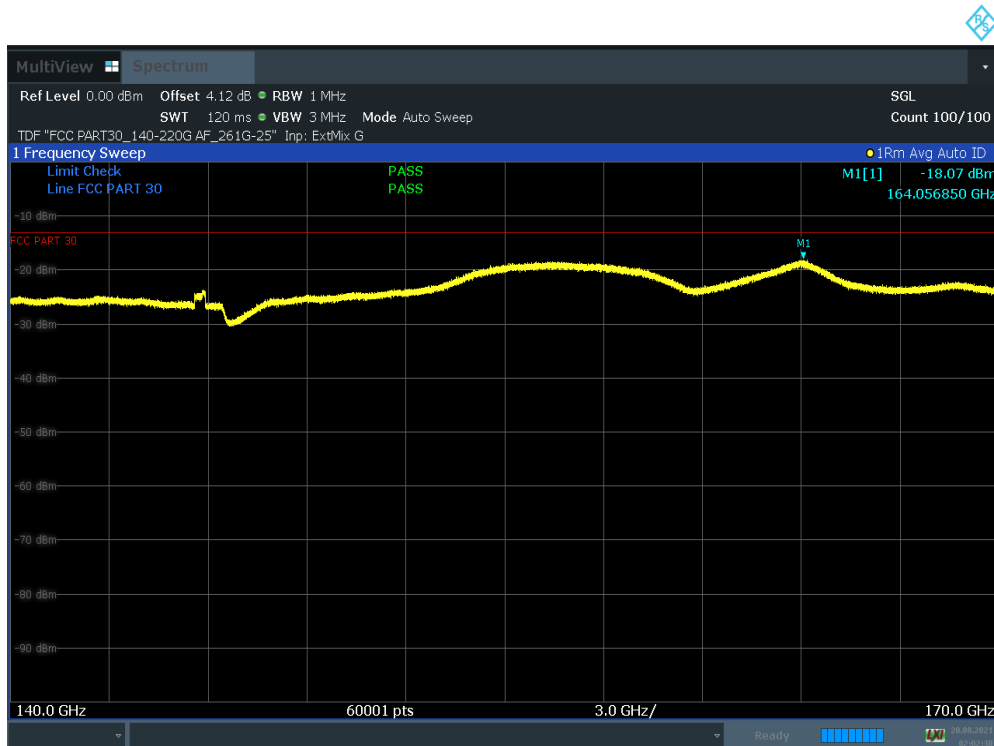

**Plot 7-65. Radiated Spurious Plot 140 GHz – 170 GHz (100 MHz BW 1CC QPSK High Channel Pol. V)**

FCC ID: A3LAT1K06-A00		<b>MEASUREMENT REPORT</b> (Class II Permissive Change)		Approved by: Technical Manager
Test Report S/N: 8K21060202-R1.A3L	Test Dates: 06/21/2021-08/31/2021	EUT Type: AU(AT1K06)		Page 60 of 84

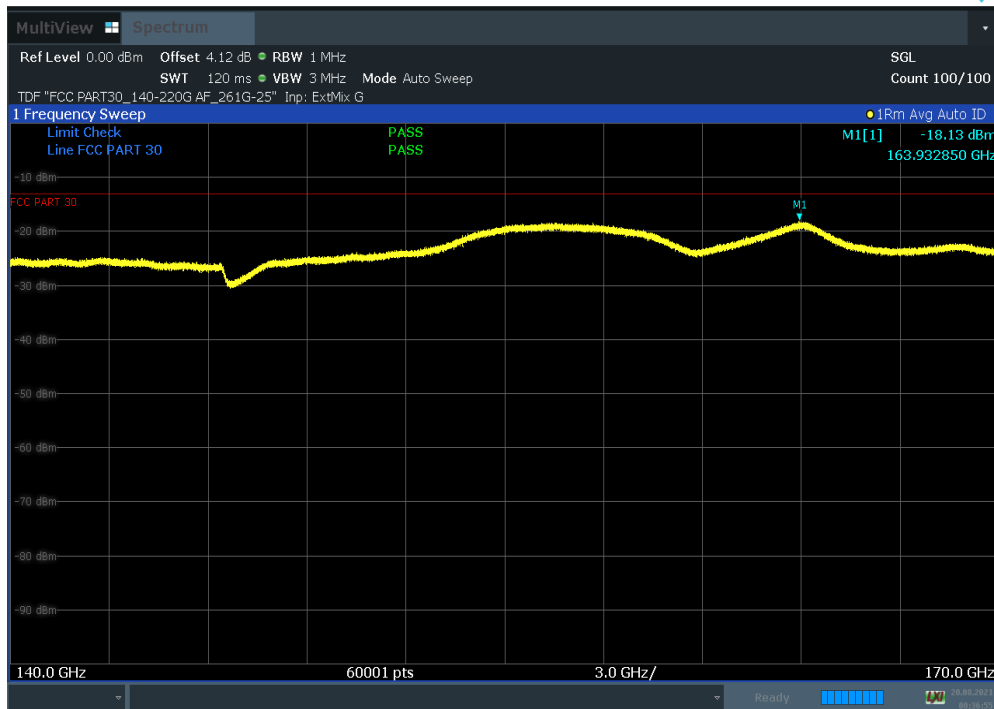

Plot 7-66. Radiated Spurious Plot 140 GHz – 170 GHz (100 MHz BW 8CC QPSK Low Channel Pol. H)

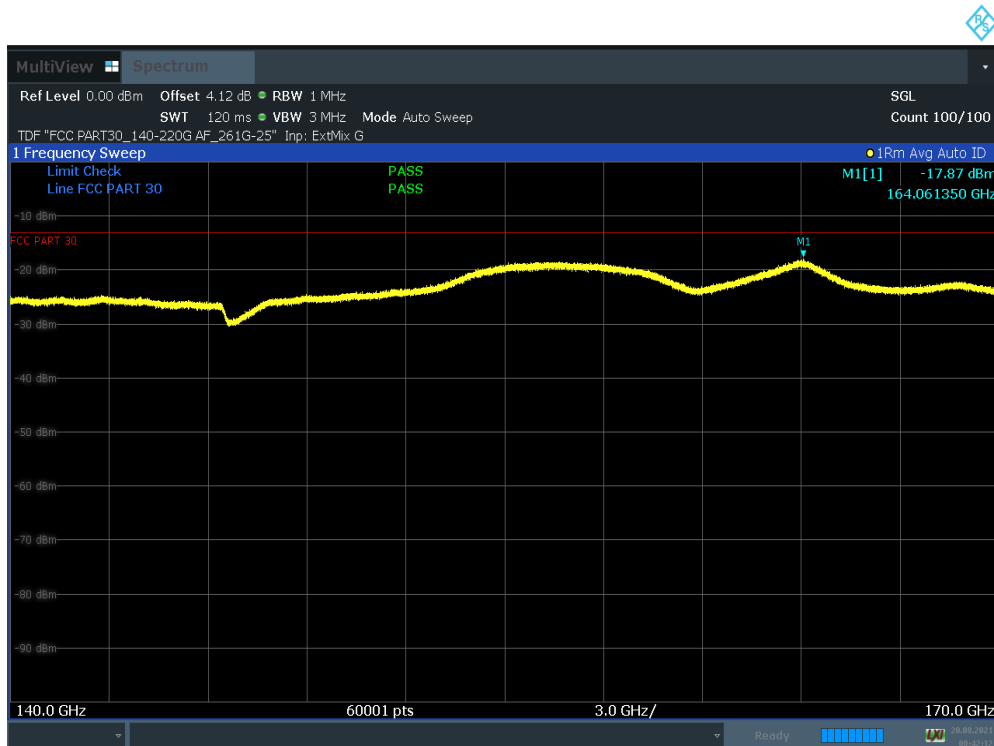

Plot 7-67. Radiated Spurious Plot 140 GHz – 170 GHz (100 MHz BW 8CC QPSK Low Channel Pol. V)

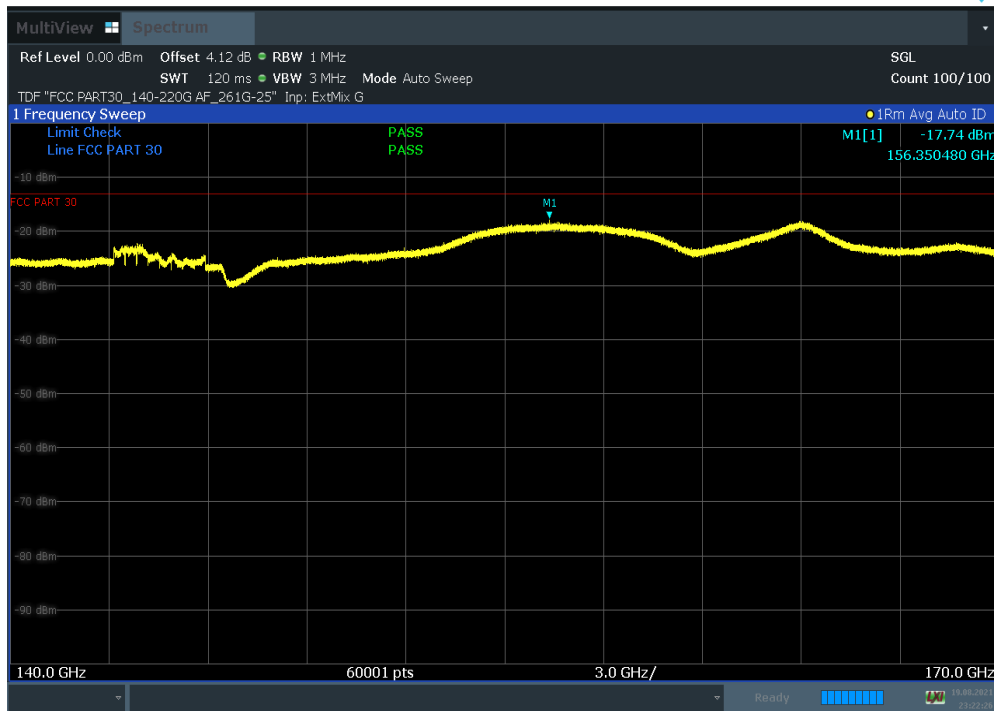

FCC ID: A3LAT1K06-A00	<b>PCTEST</b> Proud to be part of element	MEASUREMENT REPORT (Class II Permissive Change)	<b>SAMSUNG</b>	Approved by: Technical Manager
Test Report S/N: 8K21060202-R1.A3L	Test Dates: 06/21/2021-08/31/2021	EUT Type: AU(AT1K06)		Page 61 of 84

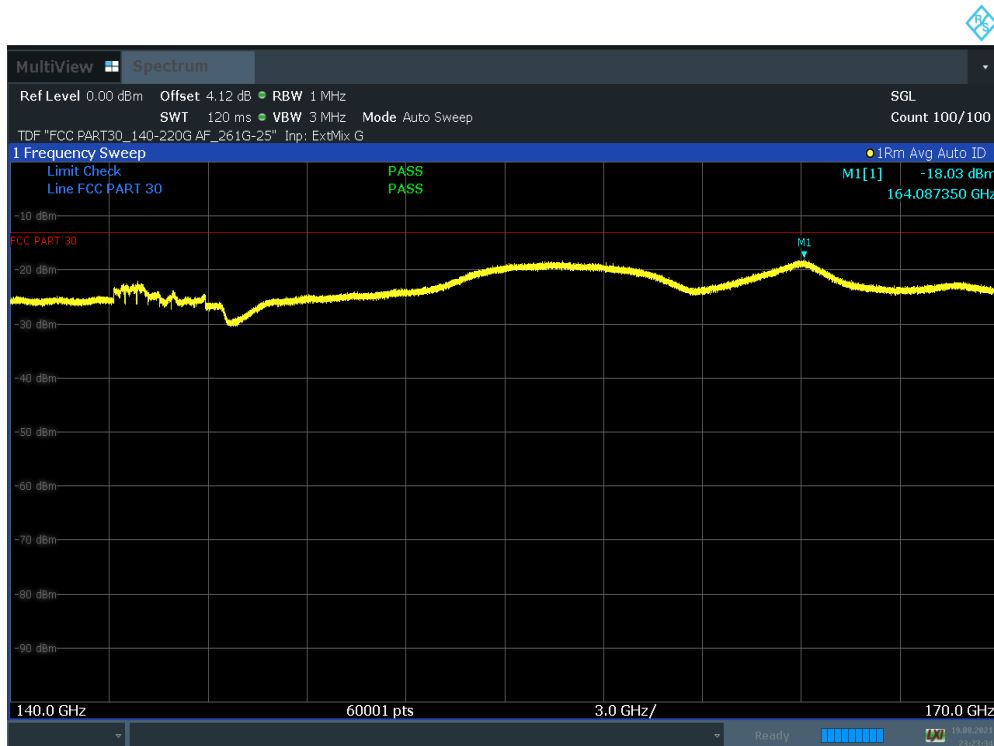

Plot 7-68. Radiated Spurious Plot 140 GHz – 170 GHz (100 MHz BW 8CC QPSK High Channel Pol. H)



Plot 7-69. Radiated Spurious Plot 140 GHz – 170 GHz (100 MHz BW 8CC QPSK High Channel Pol. V)

FCC ID: A3LAT1K06-A00		MEASUREMENT REPORT (Class II Permissive Change)		Approved by: Technical Manager
Test Report S/N: 8K21060202-R1.A3L	Test Dates: 06/21/2021-08/31/2021	EUT Type: AU(AT1K06)		Page 62 of 84

## Spurious Emissions EIRP Sample Calculation (n260)

The raw radiated spurious level is converted to field strength in dB $\mu$ V/m. Then, the RSE EIRP level is calculated by applying the additional factors shown below for a test distance of 1 meters.

**RSE EIRP (dBm) = Analyzer Level (dBm) + Antenna Factor (dB/m) + Offset (dB)\* + Harmonic Mixer Conversion Loss (dB)**



\* Offset = IF Cable Loss (dB/m) + 107 + 20Log(D<sub>m</sub>) – 104.8 + Duty cycle (dB)  
= 0.55 + 107 + 20Log(1m) – 104.8 + 1.37 dB = 4.12 dB

Frequency [GHz]	Config uration	Channel	Modulation	Ant. Pol. [H/V]	Analyzer Level [dBm]	Antenna Factor [dBm]	Offset [dB]	Mixer [dB]	RSE EIRP [dBm]	Margin [dB]
163.95	1CC	Mid	QPSK	H	-107.96	50.12	4.12	35.60	-18.12	5.12
164.16	1CC	Mid	QPSK	V	-109.06	50.12	4.12	36.70	-18.12	5.12
164.03	1CC	High	QPSK	H	-109.38	50.12	4.12	37.03	-18.11	5.11
164.06	1CC	High	QPSK	V	-109.26	50.12	4.12	36.95	-18.07	5.07
163.93	8CC	Low	QPSK	H	-107.96	50.12	4.12	35.59	-18.13	5.13
164.06	8CC	Low	QPSK	V	-109.06	50.12	4.12	36.95	-17.87	4.87
156.35	8CC	High	QPSK	H	-108.53	50.01	4.12	36.66	-17.74	4.74
164.09	8CC	High	QPSK	V	-109.15	50.12	4.12	36.88	-18.03	5.03

**Table 7-26. Radiated Spurious Emissions (140 GHz to 170 GHz)**

### Notes

The RSE EIRP level is taken directly from the spectrum analyzer which includes the appropriate antenna factors, and cable losses and harmonic mixer conversion losses. Measurements were performed at a distance of 1 meter.

FCC ID: A3LAT1K06-A00		MEASUREMENT REPORT (Class II Permissive Change)		Approved by: Technical Manager
Test Report S/N: 8K21060202-R1.A3L	Test Dates: 06/21/2021-08/31/2021	EUT Type: AU(AT1K06)		Page 63 of 84

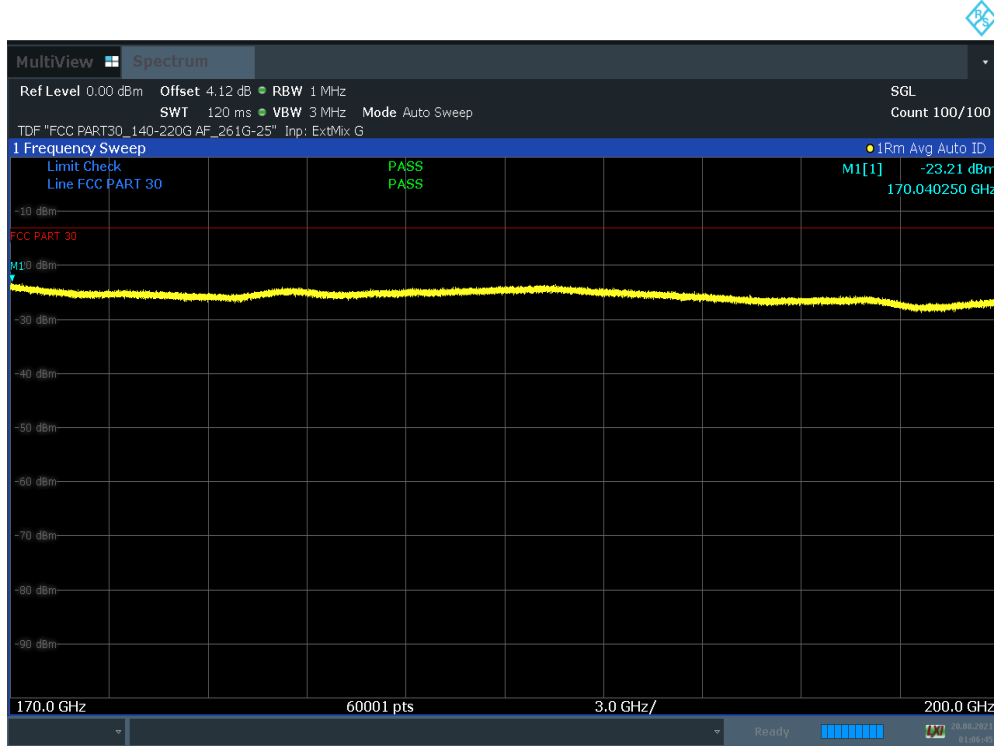

## 7.5.9 Radiated Spurious Emissions Plots (170 GHz – 200 GHz)

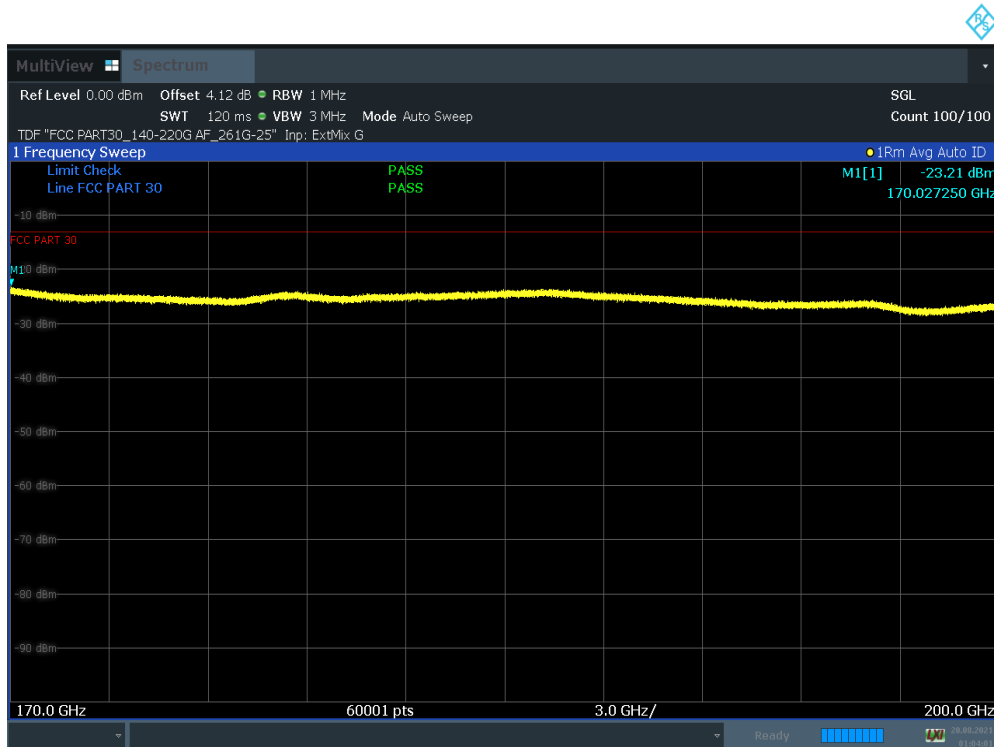

Plot 7-70. Radiated Spurious Plot 170 GHz – 200 GHz (100 MHz BW 1CC QPSK Mid Channel Pol. H)



Plot 7-71. Radiated Spurious Plot 170 GHz – 200 GHz (100 MHz BW 1CC QPSK Mid Channel Pol. V)

FCC ID: A3LAT1K06-A00		MEASUREMENT REPORT (Class II Permissive Change)		Approved by: Technical Manager
Test Report S/N: 8K21060202-R1.A3L	Test Dates: 06/21/2021-08/31/2021	EUT Type: AU(AT1K06)		Page 64 of 84



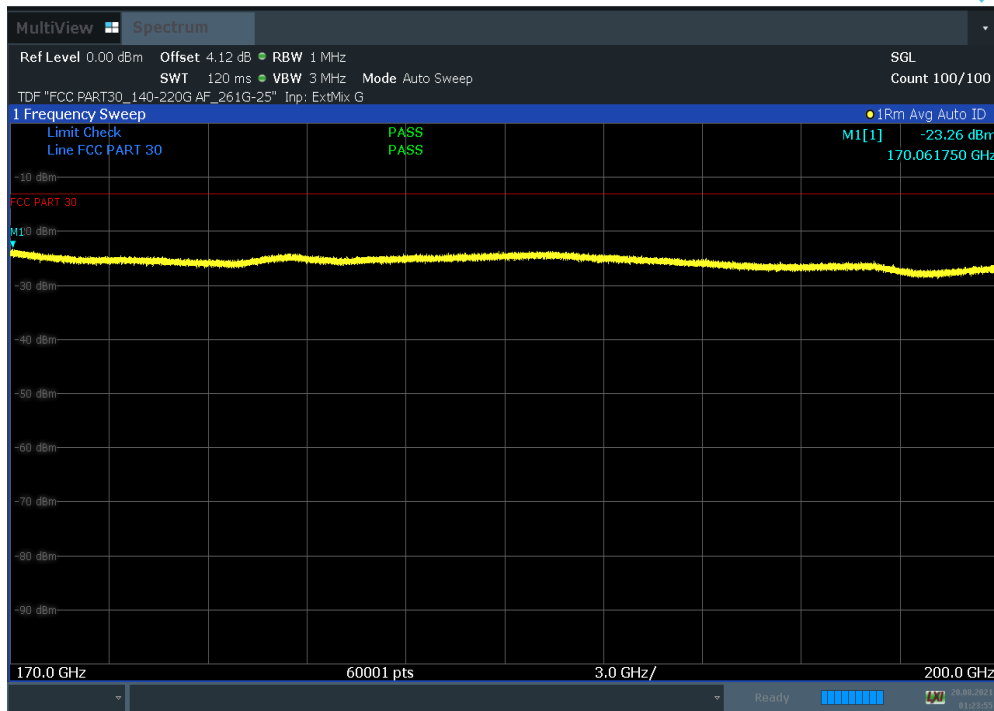

Plot 7-72. Radiated Spurious Plot 170 GHz – 200 GHz (100 MHz BW 1CC QPSK High Channel Pol. H)

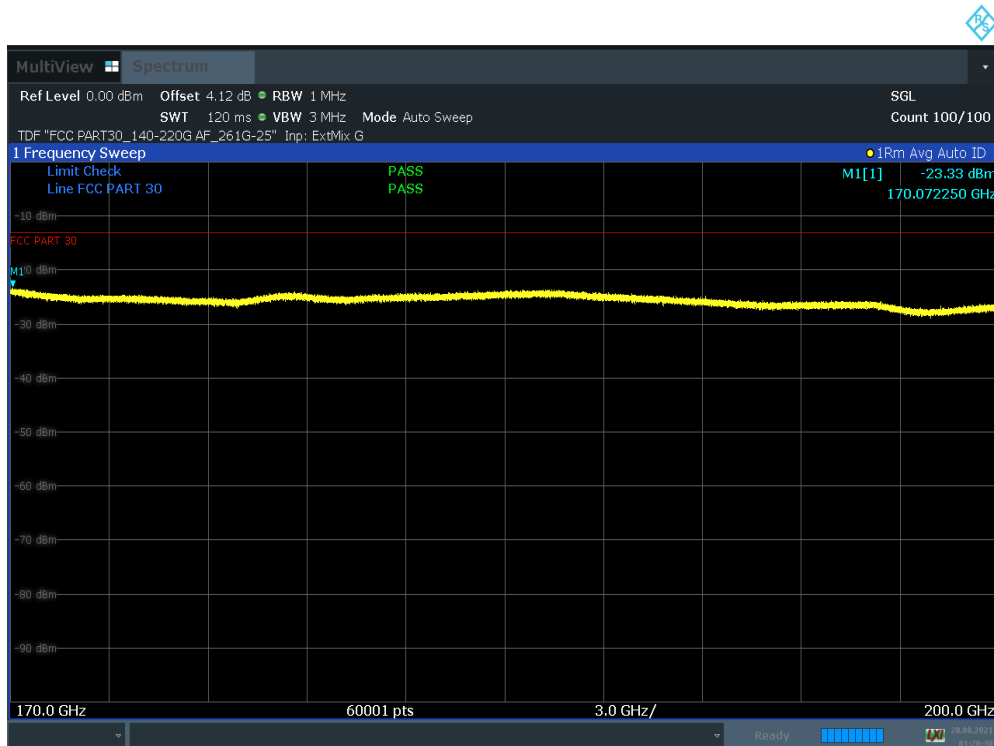

Plot 7-73. Radiated Spurious Plot 170 GHz – 200 GHz (100 MHz BW 1CC QPSK High Channel Pol. V)

FCC ID: A3LAT1K06-A00	<b>PCTEST</b> Proud to be part of element	MEASUREMENT REPORT (Class II Permissive Change)	<b>SAMSUNG</b>	Approved by: Technical Manager
Test Report S/N: 8K21060202-R1.A3L	Test Dates: 06/21/2021-08/31/2021	EUT Type: AU(AT1K06)		Page 65 of 84

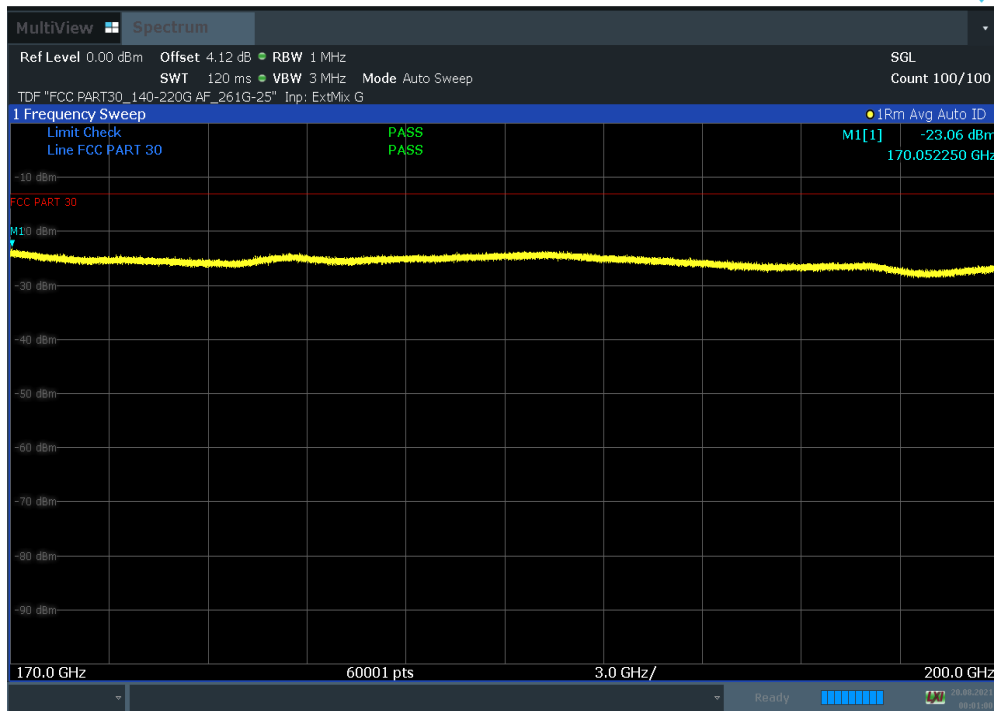

Plot 7-74. Radiated Spurious Plot 170 GHz – 200 GHz (100 MHz BW 8CC QPSK Low Channel Pol. H)

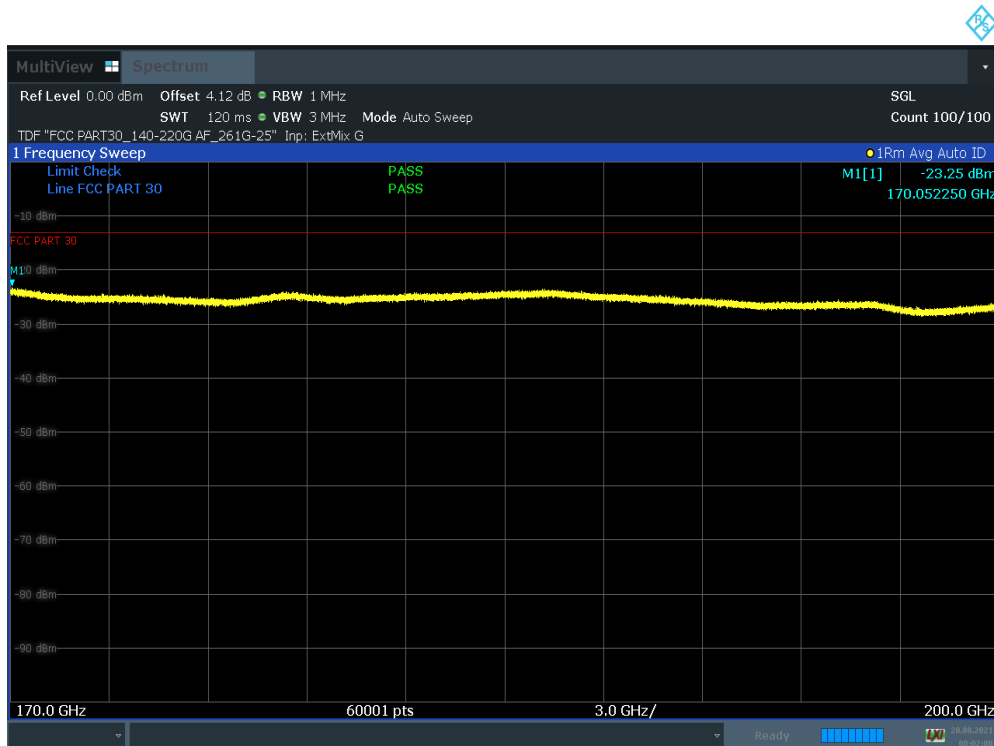

Plot 7-75. Radiated Spurious Plot 170 GHz – 200 GHz (100 MHz BW 8CC QPSK Low Channel Pol. V)

FCC ID: A3LAT1K06-A00	PCTEST Proud to be part of element	MEASUREMENT REPORT (Class II Permissive Change)	SAMSUNG	Approved by: Technical Manager
Test Report S/N: 8K21060202-R1.A3L	Test Dates: 06/21/2021-08/31/2021	EUT Type: AU(AT1K06)		Page 66 of 84

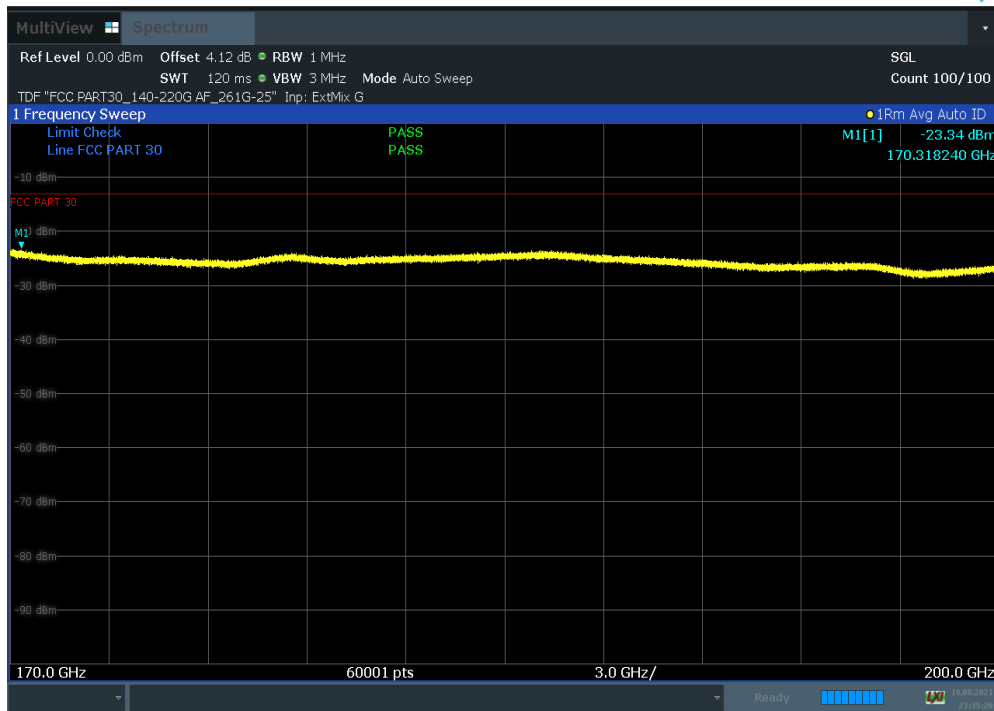

Plot 7-76. Radiated Spurious Plot 170 GHz – 200 GHz (100 MHz BW 8CC QPSK High Channel Pol. H)

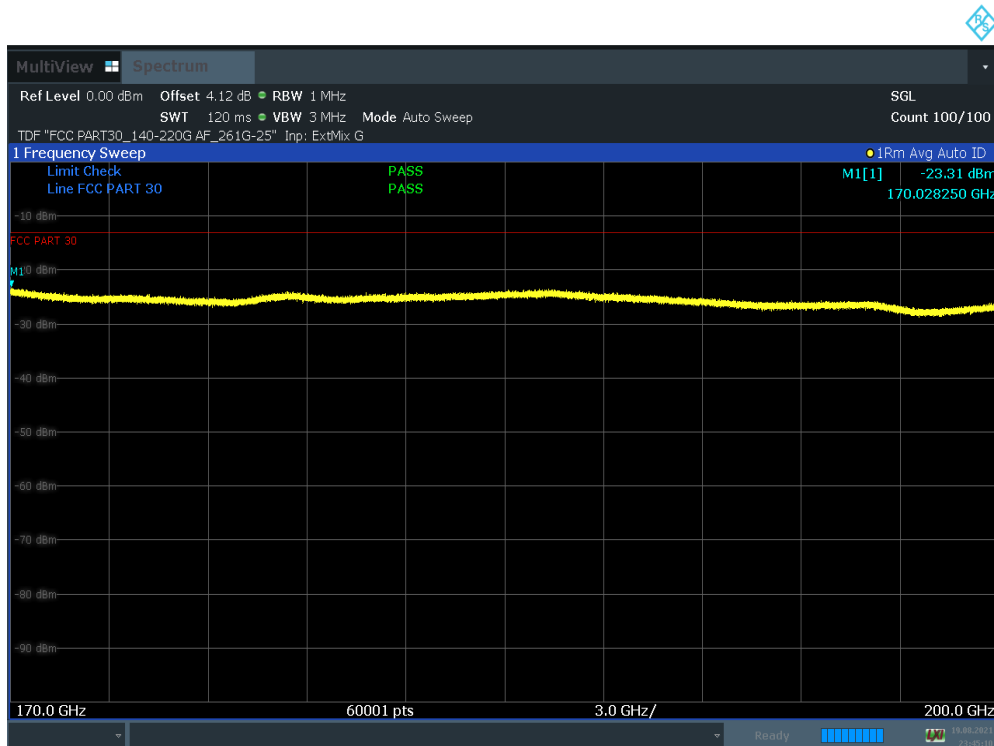

Plot 7-77. Radiated Spurious Plot 170 GHz – 200 GHz (100 MHz BW 8CC QPSK High Channel Pol. V)

FCC ID: A3LAT1K06-A00	<b>PCTEST</b> Proud to be part of element	<b>MEASUREMENT REPORT</b> (Class II Permissive Change)	<b>SAMSUNG</b>	Approved by: Technical Manager
Test Report S/N: 8K21060202-R1.A3L	Test Dates: 06/21/2021-08/31/2021	EUT Type: AU(AT1K06)		Page 67 of 84

## Spurious Emissions EIRP Sample Calculation (n260)

The raw radiated spurious level is converted to field strength in dB $\mu$ V/m. Then, the RSE EIRP level is calculated by applying the additional factors shown below for a test distance of 1 meters.

**RSE EIRP (dBm) = Analyzer Level (dBm) + Antenna Factor (dB/m) + Offset (dB)\* + Harmonic Mixer Conversion Loss (dB)**



\* Offset = IF Cable Loss (dB/m) + 107 + 20Log(D<sub>m</sub>) – 104.8 + Duty cycle (dB)  
= 0.55 + 107 + 20Log(1m) – 104.8 + 1.37 dB = 4.12 dB

Frequency [GHz]	Config uration	Channel	Modulation	Ant. Pol. [H/V]	Analyzer Level [dBm]	Antenna Factor [dBm]	Offset [dB]	Mixer [dB]	RSE EIRP [dBm]	Margin [dB]
170.04	1CC	Mid	QPSK	H	-109.48	50.21	4.12	31.94	-23.21	10.21
170.03	1CC	Mid	QPSK	V	-109.48	50.21	4.12	31.94	-23.21	10.21
170.06	1CC	High	QPSK	H	-109.53	50.21	4.12	31.94	-23.26	10.26
170.07	1CC	High	QPSK	V	-109.6	50.21	4.12	31.94	-23.33	10.33
170.05	8CC	Low	QPSK	H	-109.33	50.21	4.12	31.94	-23.06	10.06
170.05	8CC	Low	QPSK	V	-109.52	50.21	4.12	31.94	-23.25	10.25
170.32	8CC	High	QPSK	H	-109.61	50.21	4.12	31.94	-23.34	10.34
170.03	8CC	High	QPSK	V	-109.58	50.21	4.12	31.94	-23.31	10.31

**Table 7-27. Radiated Spurious Emissions (170 GHz to 200 GHz)**

### Notes

The RSE EIRP level is taken directly from the spectrum analyzer which includes the appropriate antenna factors, and cable losses and harmonic mixer conversion losses. Measurements were performed at a distance of 1 meter.

FCC ID: A3LAT1K06-A00		MEASUREMENT REPORT (Class II Permissive Change)		Approved by: Technical Manager
Test Report S/N: 8K21060202-R1.A3L	Test Dates: 06/21/2021-08/31/2021	EUT Type: AU(AT1K06)		Page 68 of 84

## 7.6 Band Edge Emissions

### §2.1051 §30.203

#### Test Overview

All out of band emissions are measured in a radiated setup while the EUT is operating at its maximum duty cycle, at maximum power, and at the appropriate frequencies. All modulations were investigated to determine the worst case configuration. All modes of operation were investigated and the worst case configuration results are reported in this section.

***The minimum permissible attenuation level of any spurious emission is -13 dBm / 1 MHz. However, in the bands immediately outside and adjacent to the licensee's frequency block, having a bandwidth equal to 10 percent of the channel bandwidth, the conductive power or the total radiated power of any emission shall be -5 dBm / MHz or lower.***

#### Test Procedure Used



ANSI C63.26-2015 Section 5.7.3  
ANSI C63.26-2015 Section 6.4  
KDB 842590 D01 v01r02 Section 4.4.2.5

#### Test Settings

1. Start and stop frequency were set such that both upper and lower band edges are measured.
2. Span was set large enough so as to capture all out of band emissions near the band edge
3. RBW = 1 MHz
4. VBW  $\geq 3 \times$  RBW
5. Detector = RMS
6. Number of sweep points  $\geq 2 \times$  Span/RBW
7. Trace mode = trace average
8. Sweep time = auto couple
9. The trace was allowed to stabilize



#### Test Notes

- 1) For comparison with the original authorization, the testing was performed on the worst case of the original test results.
- 2) The EUT was tested while positioned upright and mounted on a mast 1.5 m height. The worst case emissions are reported with the EUT in this fixed position and with the modulations and active component carriers shown in the tables below.
- 3) All measurements in this section was performed in the radiated setup in the far field.
- 4) All appropriate Antenna Factor, Cable Loss, and Duty Correction factor have been applied in the spectrum analyzer for each measurement. Additionally, band Edge measurements in this section are shown as equivalent conductive powers for direct comparison to the 30.203 limit. The conductive power at the band edge is calculated by subtracting the gain of the EUT's antenna from the measured EIRP level. Antenna Gain information is shown on the following page.
- 5) For band edge measurement of the receive horn antenna was maximized on Antenna A were individually energized and measured while maintaining maximized position on Antenna A. These measurements were saved into a spreadsheet and their spectra were summed to determine the total conducted power

FCC ID: A3LAT1K06-A00	 PCTEST® Proud to be part of element	MEASUREMENT REPORT (Class II Permissive Change)		Approved by: Technical Manager
Test Report S/N: 8K21060202-R1.A3L	Test Dates: 06/21/2021-08/31/2021	EUT Type: AU(AT1K06)		Page 69 of 84

for the band edge emissions level shown starting in Section 7.6.5. The same procedure was repeated with the receive horn antenna maximized on Antennas B, C, and D.

- 6) The MIMO Band Edges were calculated by using the “measure and sum the spectra across the outputs” technique specified in Section 6.4.3.2.2 of ANSI C63.26-2015. The spectra were summed linearly and converted to dBm for comparison with the limit.
- 7) 10% outside of the channel bandwidth result should be referred from 7.5 Radiated Spurious and Harmonic Emissions due to EUT Antenna subtraction calculation adoption. Thus, some failure results are performed of TRP measurement adopted.

<b>FCC ID:</b> A3LAT1K06-A00		<b>MEASUREMENT REPORT (Class II Permissive Change)</b>		<b>Approved by:</b> Technical Manager
<b>Test Report S/N:</b> 8K21060202-R1.A3L	<b>Test Dates:</b> 06/21/2021-08/31/2021	<b>EUT Type:</b> AU(AT1K06)	Page 70 of 84	

## 7.6.1 Antenna Gain Information at the Band Edge

The following antenna gain information is provided to demonstrate the antenna performance of the 37.05 GHz to 39.95 GHz band. These antenna gains were subtracted from the measured EIRP levels at the lower and upper band edge frequencies to determine an equivalent conductive power that was compared directly with the §30.203 limits.

Frequency [GHz]	Channel	Antenna Gain [dBi]
37.05	High	27.00
39.95	High	27.00

**Table 7-28. Antenna Gains at the Band Edges**

### Sample Analyzer Offset Calculation (at 39.95 GHz)

Measurement Antenna Factor = 44.43 dB/m

Cable Loss = 9.77 dB

Far Field Distance = 3.20 m



EUT Antenna Gain = 27.00 dBi

Duty Cycle Correction Factor = 1.37 dB

Analyzer Offset (dB) = AF (dB/m) + CL (dB) + 107 + 20log<sub>10</sub>(D) – 104.8 dB – Gain (dBi) + Duty Correction factor (dB)

$$= 44.43 \text{ dB/m} + 9.77 \text{ dB} + 107 + 20\log_{10}(3.20) - 104.8 \text{ dB} - 27.00 \text{ dBi} + 1.37 \text{ dB}$$

$$= 40.87 \text{ dB}$$

FCC ID: A3LAT1K06-A00		MEASUREMENT REPORT (Class II Permissive Change)		Approved by: Technical Manager
Test Report S/N: 8K21060202-R1.A3L	Test Dates: 06/21/2021-08/31/2021	EUT Type: AU(AT1K06)	Page 71 of 84	

## 7.6.2 Antenna A Conducted Band Edge Maximized on Antenna A

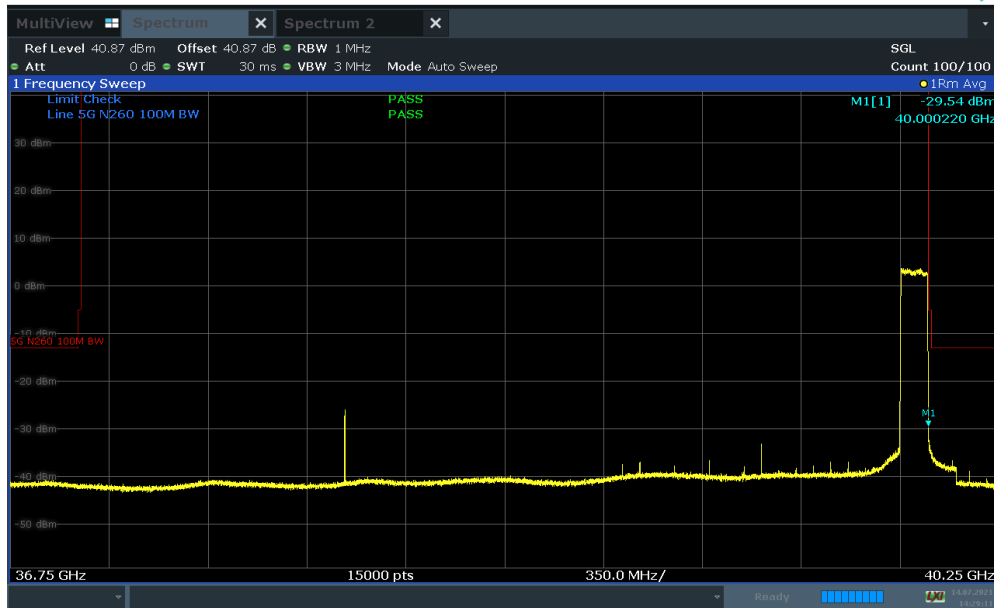

Plot 7-78. Band Edge (100 MHz BW 1CC QPSK High channel)

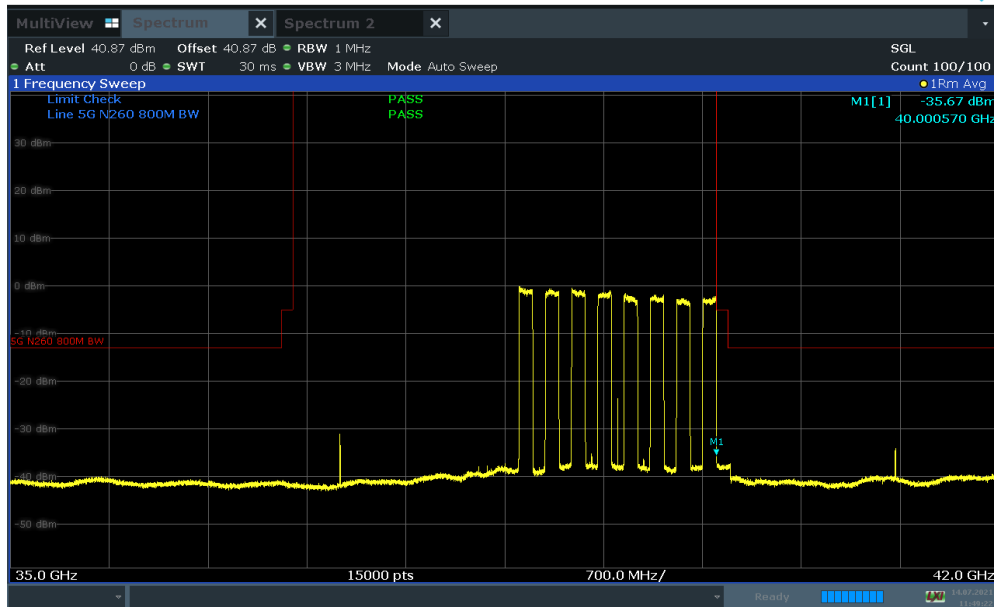

Plot 7-79. Band Edge (100 MHz BW 8NC QPSK High channel)

FCC ID: A3LAT1K06-A00	<b>PCTEST</b> Proud to be part of element	MEASUREMENT REPORT (Class II Permissive Change)	<b>SAMSUNG</b>	Approved by: Technical Manager
Test Report S/N: 8K21060202-R1.A3L	Test Dates: 06/21/2021-08/31/2021	EUT Type: AU(AT1K06)		Page 72 of 84



### 7.6.3 Antenna B Conducted Band Edge Maximized on Antenna B

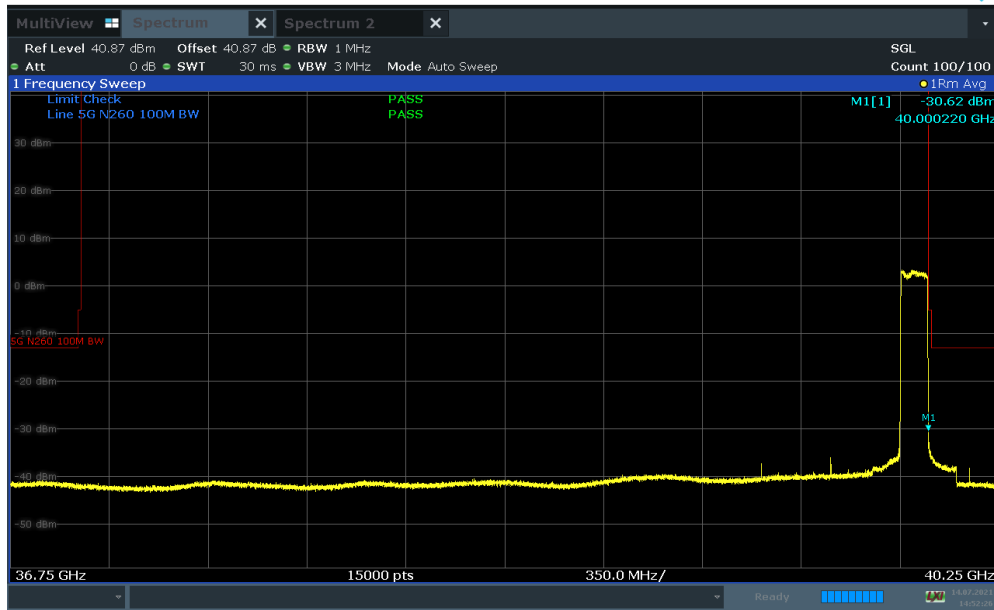

Plot 7-80. Band Edge (100 MHz BW 1CC QPSK High channel)

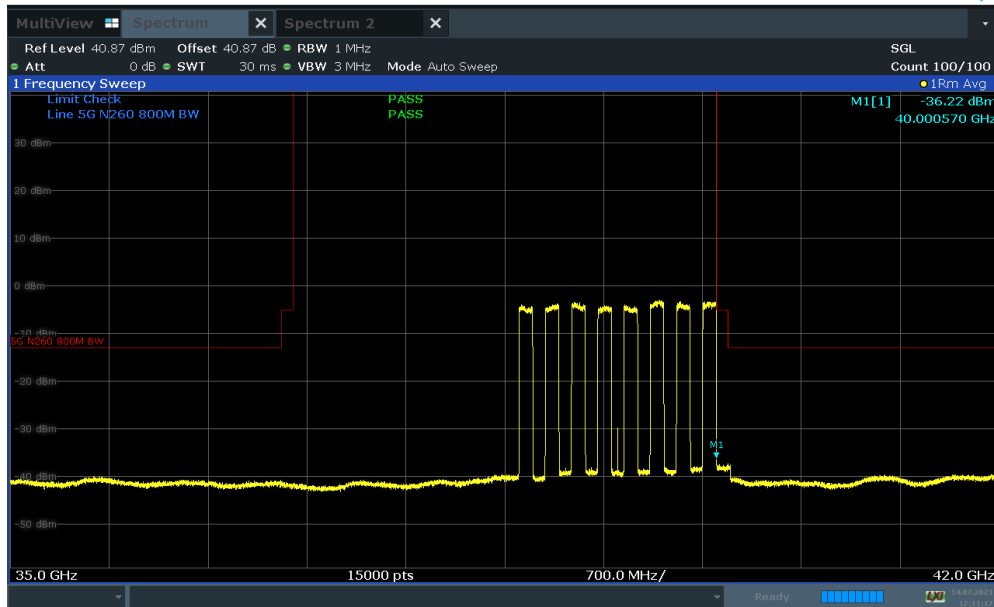

Plot 7-81. Band Edge (100 MHz BW 8NC QPSK High channel)

FCC ID: A3LAT1K06-A00	PCTEST Proud to be part of element	MEASUREMENT REPORT (Class II Permissive Change)	SAMSUNG	Approved by: Technical Manager
Test Report S/N: 8K21060202-R1.A3L	Test Dates: 06/21/2021-08/31/2021	EUT Type: AU(AT1K06)		Page 73 of 84

## 7.6.4 Antenna C Conducted Band Edge Maximized on Antenna C

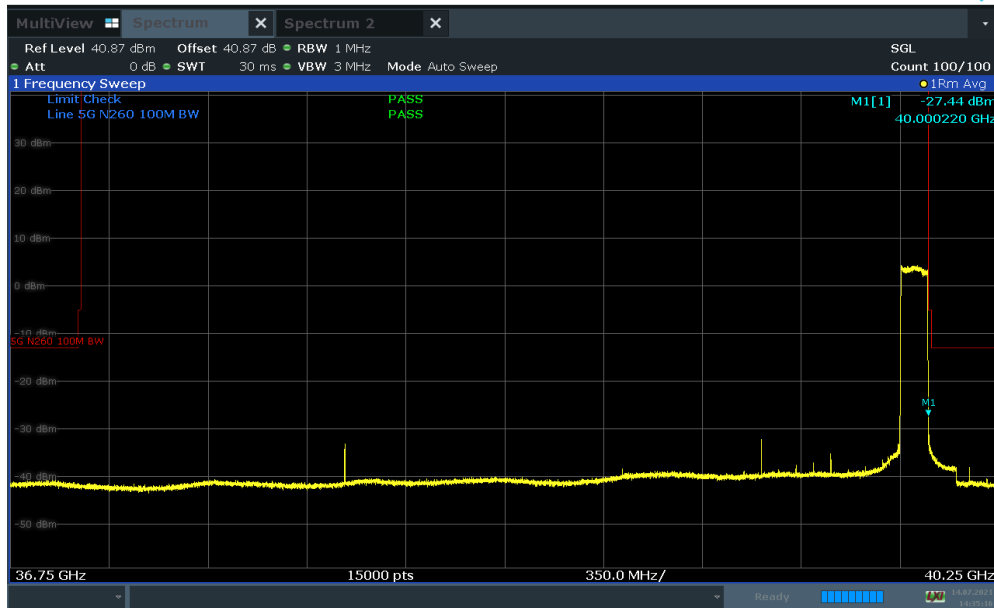

Plot 7-82. Band Edge (100 MHz BW 1CC QPSK High channel)

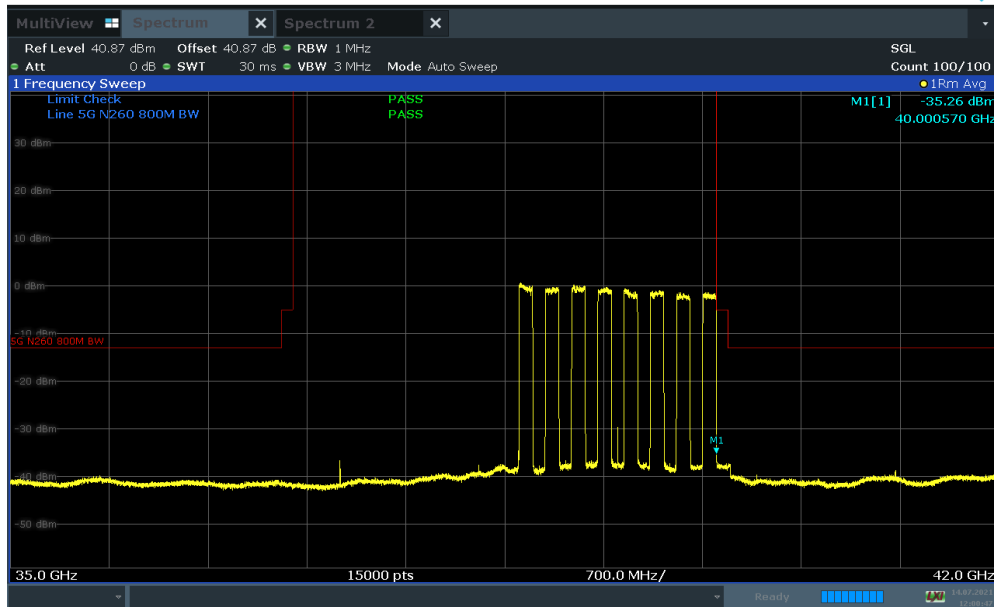

Plot 7-83. Band Edge (100 MHz BW 8NC QPSK High channel)

FCC ID: A3LAT1K06-A00	<b>PCTEST</b> Proud to be part of element	MEASUREMENT REPORT (Class II Permissive Change)	<b>SAMSUNG</b>	Approved by: Technical Manager
Test Report S/N: 8K21060202-R1.A3L	Test Dates: 06/21/2021-08/31/2021	EUT Type: AU(AT1K06)		Page 74 of 84

## 7.6.5 Antenna D Conducted Band Edge Maximized on Antenna D

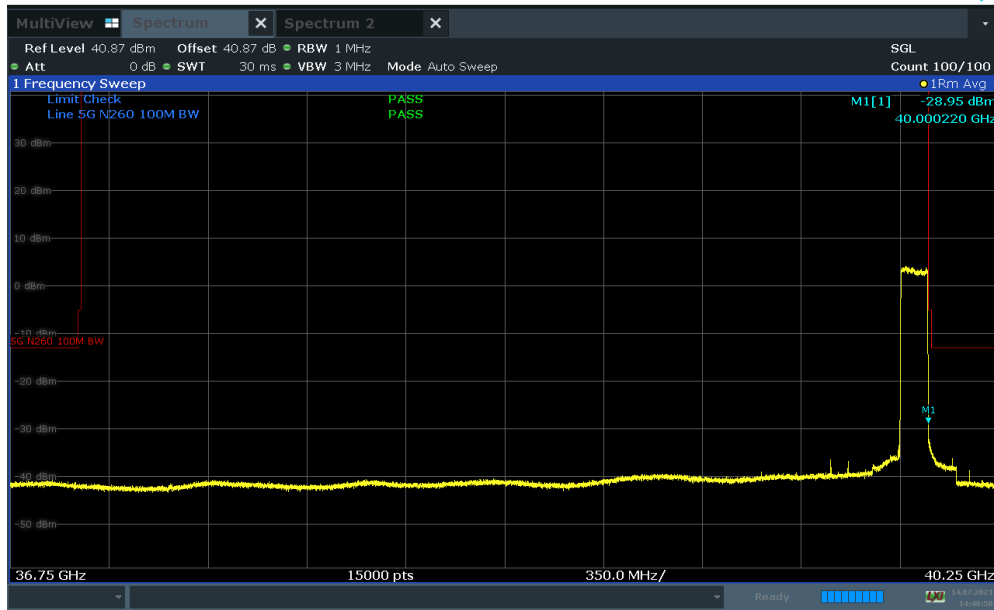

Plot 7-84. Band Edge (100 MHz BW 1CC QPSK High channel)

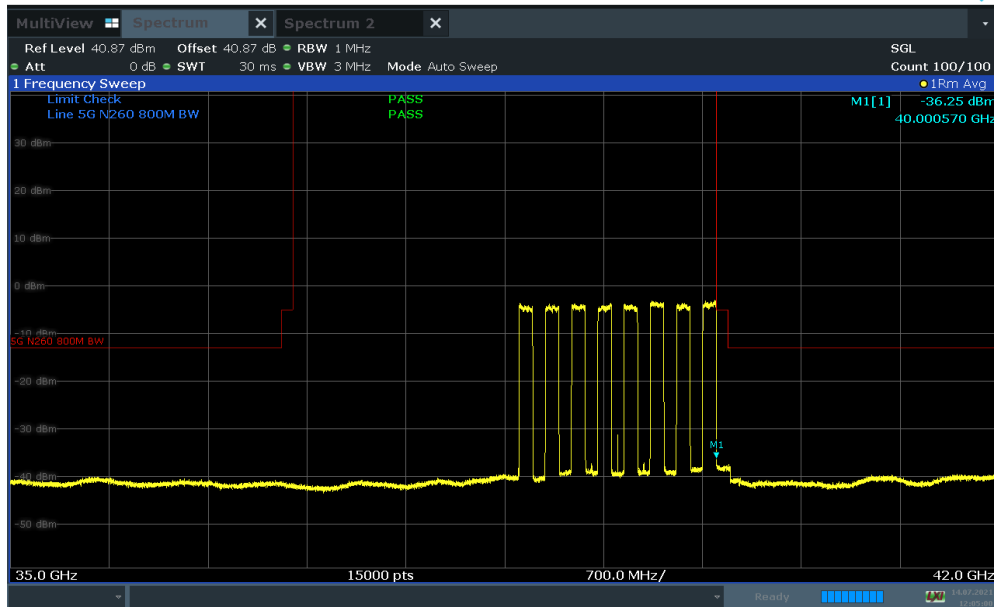

Plot 7-85. Band Edge (100 MHz BW 8NC QPSK High channel)

FCC ID: A3LAT1K06-A00	<b>PCTEST</b> Proud to be part of element	MEASUREMENT REPORT (Class II Permissive Change)	<b>SAMSUNG</b>	Approved by: Technical Manager
Test Report S/N: 8K21060202-R1.A3L	Test Dates: 06/21/2021-08/31/2021	EUT Type: AU(AT1K06)		Page 75 of 84

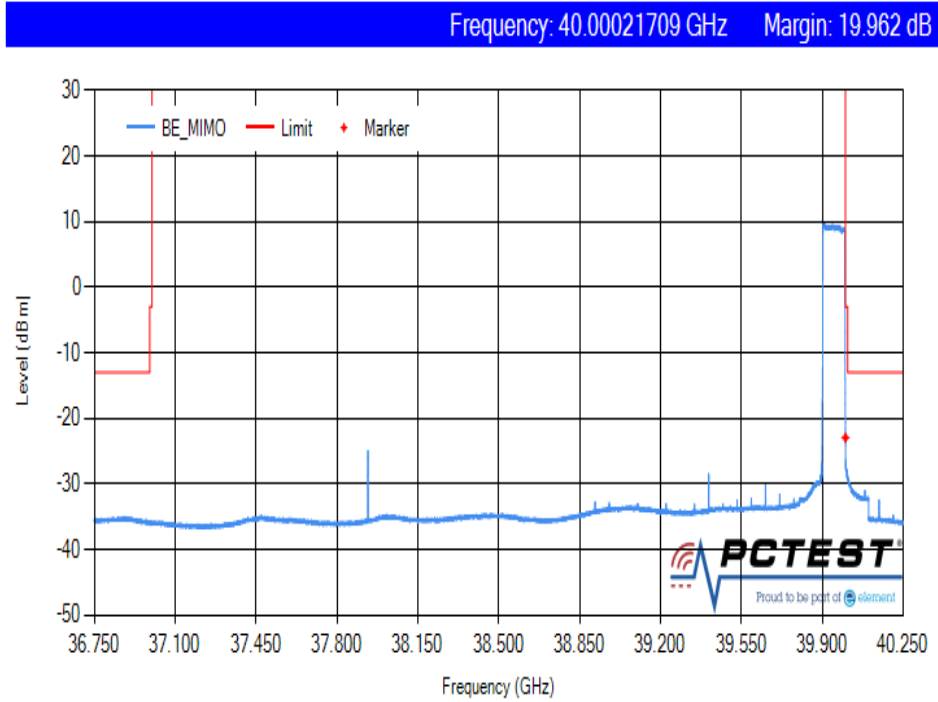

### 7.6.6 MIMO Band Edge Maximized on Antenna A/B/C/D

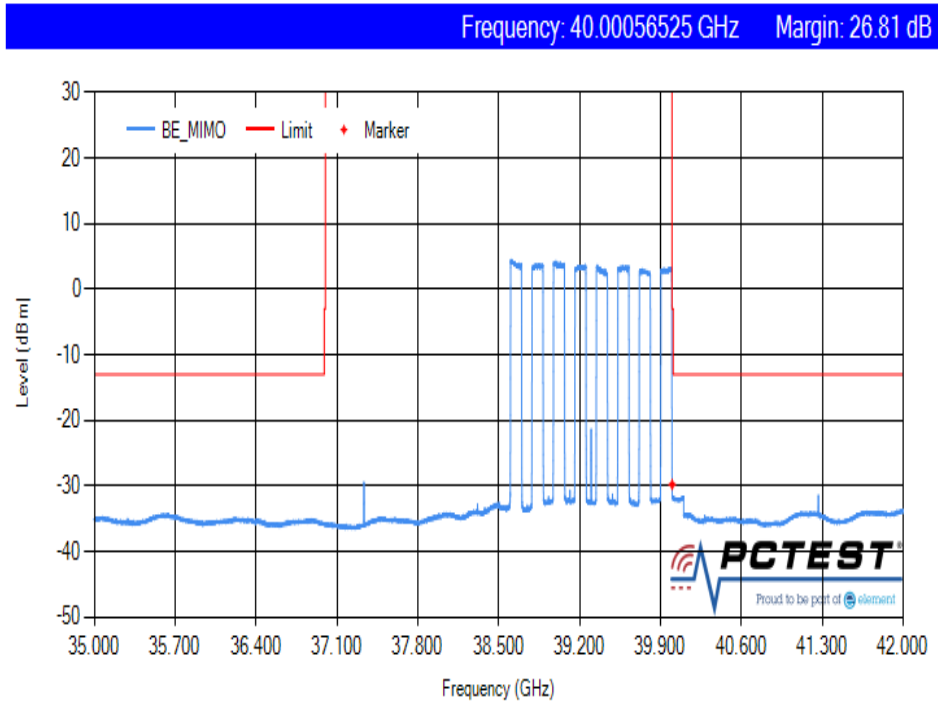

**Plot 7-86. Band Edge MIMO (100 MHz BW 1CC QPSK High)**



**Plot 7-87. Band Edge MIMO (100 MHz BW 8NC QPSK High)**

<b>FCC ID:</b> A3LAT1K06-A00		<b>MEASUREMENT REPORT</b> (Class II Permissive Change)		<b>Approved by:</b> Technical Manager
<b>Test Report S/N:</b> 8K21060202-R1.A3L	<b>Test Dates:</b> 06/21/2021-08/31/2021	<b>EUT Type:</b> AU(AT1K06)	Page 76 of 84	

## 7.7 Frequency Stability / Temperature Variation

### \$2.1055

#### Test Overview and Limit

Frequency stability testing is performed in accordance with the guidelines of ANSI C63.26-2015. The frequency stability of the transmitter is measured by:

- a.) **Temperature:** The temperature is varied from -30°C to +50°C in 10°C increments using an environmental chamber.
- b.) **Primary Supply Voltage:** The primary supply voltage is varied from 85 % to 115 % of the nominal value for non hand-carried battery and AC powered equipment. For hand-carried, battery-powered equipment, primary supply voltage is reduced to the battery operating end point which shall be specified by the manufacturer.

#### Test Procedure Used

ANSI C63.26-2015 Section 5.6  
KDB 842590 D01 v01r02 Section 4.5

#### Test Settings

1. The carrier frequency of the transmitter is measured at room temperature (20°C to provide a reference).
2. The equipment is turned on in a “standby” condition for fifteen minutes before applying power to the transmitter. Measurement of the carrier frequency of the transmitter is made within one minute after applying power to the transmitter.
3. Frequency measurements are made at 10°C intervals ranging from -30°C to +50°C. A period of at least one hour is provided to allow stabilization of the equipment at each temperature level.

#### Test Setup

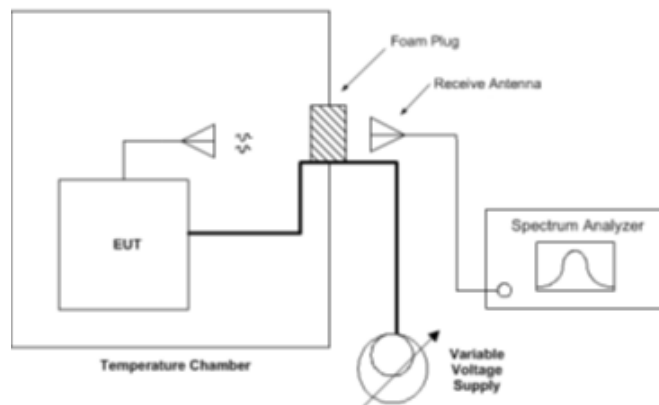



Figure 7-1. Test Instrument & Measurement Setup

The EUT was measured using horn antenna connected to a spectrum analyzer. The EUT was placed inside an environmental chamber.

#### Test Notes

The Frequency Deviation column in the table below is the amount of deviation measured from the center frequency of the Reference measurement (first row).

FCC ID: A3LAT1K06-A00	 PCTEST Proud to be part of element	MEASUREMENT REPORT (Class II Permissive Change)		Approved by: Technical Manager
Test Report S/N: 8K21060202-R1.A3L	Test Dates: 06/21/2021-08/31/2021	EUT Type: AU(AT1K06)		Page 77 of 84

## Frequency Stability Measurements

\$2.1055

OPERATING FREQUENCY: 38,500,000,000 Hz



REFERENCE VOLTAGE: 110.00 VAC

VOLTAGE (%)	POWER (VAC)	TEMP (°C)	FREQUENCY (Hz)	Freq. Dev. (Hz)	Deviation (%)
100 %	110.00	+ 20 (Ref)	38,500,084,554	0	0.0000000
100 %		- 30	38,500,084,478	-75	-0.0000002
100 %		- 20	38,500,084,446	-107	-0.0000003
100 %		- 10	38,500,084,236	-318	-0.0000008
100 %		0	38,500,084,856	302	0.0000008
100 %		+ 10	38,500,084,401	-153	-0.0000004
100 %		+ 20	38,500,084,554	0	0.0000000
100 %		+ 30	38,500,084,425	-128	-0.0000003
100 %		+ 40	38,500,084,535	-18	0.0000000
100 %		+ 50	38,500,084,473	-81	-0.0000002
85 %		93.50	+ 20	38,500,083,818	-736
115 %	126.50	+ 20	38,500,084,618	64	0.0000002

**Table 7-29. Frequency Stability Data**

**Note:**



Based on the results of the frequency stability test at the center channel the frequency deviation results measured are very small. As such it is determined that the channels at the band edge would remain in-band when the maximum measured frequency deviation noted during the frequency stability tests is applied. Therefore, the device is determined to remain operating in band over the temperature and voltage range as tested.

FCC ID: A3LAT1K06-A00		MEASUREMENT REPORT (Class II Permissive Change)		Approved by: Technical Manager
Test Report S/N: 8K21060202-R1.A3L	Test Dates: 06/21/2021-08/31/2021	EUT Type: AU(AT1K06)		Page 78 of 84

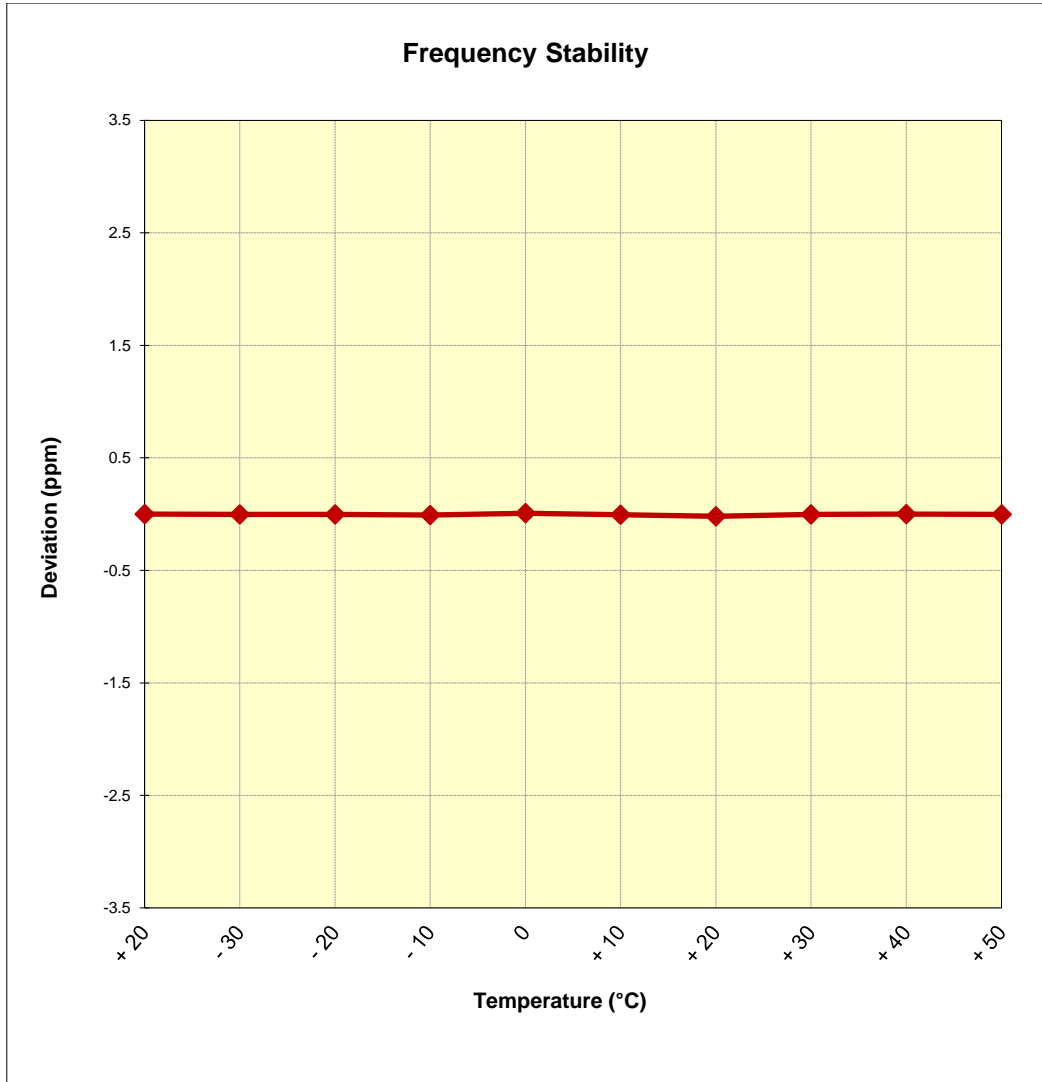
**Frequency Stability Measurements**  
**§2.1055**





**Figure 7-2. Frequency Stability Graph**

<b>FCC ID:</b> A3LAT1K06-A00	 <b>MEASUREMENT REPORT</b> (Class II Permissive Change)		<b>Approved by:</b> Technical Manager
<b>Test Report S/N:</b> 8K21060202-R1.A3L	<b>Test Dates:</b> 06/21/2021-08/31/2021	<b>EUT Type:</b> AU(AT1K06)	Page 79 of 84

## 8.0 CONCLUSION

The data collected relate only to the item(s) tested and show that the **Samsung 5G Access Unit Model: AT1K06-A00** complies with all the requirements of Part 30.

FCC ID: A3LAT1K06-A00		<b>MEASUREMENT REPORT (Class II Permissive Change)</b>		<b>Approved by:</b> Technical Manager
<b>Test Report S/N:</b> 8K21060202-R1.A3L	<b>Test Dates:</b> 06/21/2021-08/31/2021	<b>EUT Type:</b> AU(AT1K06)	Page 80 of 84	



## 9.0 APPENDIX A

### 9.1 HARMONIC MIXER Verification Certificate



### 교정 성적서

#### CALIBRATION CERTIFICATE

경기도 이천시 마장면 서이천로 578번길 74  
TEL : 031-645-6900, FAX : 031-645-6969



---

성적서발급번호(Certificate No) : IC-2021-17236

교정번호(Calibration No) : C-2021-021271



페이지(page) : 1 of 4

- 1. 의뢰자 (Client)**
  - 기관명 (Name) : 피씨테스트코리아 주식회사
  - 주소 (Address) : 경기도 용인시 기흥구 흥덕1로 13, 피136, 피137호(영덕동, 흥덕 IT 벨리)
- 2. 측정기 (Calibration Subject)**
  - 기기명 (Description) : HARMONIC MIXER
  - 제작회사 및 형식(Manufacturer and Model Name) : ROHDE & SCHWARZ / FS-Z60
  - 기기번호 (Serial Number) : 100981
- 3. 교정일자 (Date of Calibration)** : 2021.03.08
- 4. 교정환경 (Environment)**
  - 온도(Temperature) : ( 23.5 ± 0.4 ) °C
  - 습도(Humidity) : ( 49 ± 5 ) % R.H.
  - 교정장소 (Location) : 고정표준실(Permanent Calibration Lab)  
(주소: 경기도 이천시 마장면 서이천로 578번길 74)
- 5. 측정표준의 소급성 (Traceability)**
  - Field code : 40641(RF SPECTRUM ANALYZER)
  - 교정방법 및 소급성 서술 (Calibration method and/or brief description)  
상기 기기는 고주파 스펙트럼 분석기의 교정절차(HCT-CS-125-40641)에 따라 국가측정표준기관으로부터 측정의 소급성이 확보된 아래의 표준장비를 이용하여 교정 되었음.

**교정에 사용한 표준장비 명세 (List of used standards/specifications)**

기기명 (Description)	제작회사 및 형식 (Manufacturer and Model Name)	기기번호 (Serial Number)	차기교정예정일자 (The due date of next Calibration)	교정기관 (Calibration laboratory)
EXG ANALOG SIGNAL GENERATOR	KEYSIGHT N5173B	MY53270544	2021/06/23	(주)에이치시티
	AGILENT E4419B			
EPM SERIES POWER METER	AGILENT 8487A	GB42420565	2021/11/02	(주)에이치시티
POWER SENSOR	KEYSIGHT V8486A	MY41092450	2022/01/11	(주)에이치시티
POWER SENSOR	OML S19MS-A	160516-1	2021/09/09	Keysight Technologies (주)에이치시티

- 6. 교정결과 (Calibration result)** : 교정결과 참조 (Refer to attachment)
- 7. 측정불확도 (Measurement uncertainty)** : 교정결과 참조 (Refer to attachment)  
신뢰수준 약 95 %, k = 2 ( Confidence level about 95 %, k = 2 )

<b>확 인 (affirmation)</b>	작성자 (Measurements performed by) 성명 (Name) 박민지	 승인자 (Approved by) 직위 (Title) 기술책임자 (Technical Cal. Manager) (정) 성명 (Name) 이승찬
		 (서명)

위 성적서는 국제시험기관인정협력체(International Laboratory Accreditation Cooperation) 상호인정협정(Mutual Recognition Arrangement)에 서명한 한국인정기구(KOLAS)로부터 공인 받은 분야의 교정결과입니다.

**2021. 03. 08**



한국인정기구 인정  
Accredited by KOLAS, Republic of KOREA

**(주)에이치시티 대표이사**  
President, HCT Co., Ltd.



※ 위 성적서는 측정기의 정밀정확도에 영향을 미치는 요소(과부하, 온도, 습도 등)의 급격한 변화가 발생한 경우에는 무효가 됩니다.  
 ※ 고객진흥사이트(http://www.callab.co.kr)에서 성적서의 진위여부 확인이 가능합니다.  
 ※ 성적서의 원본은 상단에 HCT홀로그램이 들어간 위변조 방지 용지에 인쇄되어 발급되며, 원본 복사시에는 복사본이라는 표시가 처리됩니다.

F-02P-02-008 (Rev.02)

FCC ID: A3LAT1K06-A00		<b>MEASUREMENT REPORT</b> (Class II Permissive Change)		<b>Approved by:</b> Technical Manager
Test Report S/N: 8K21060202-R1.A3L	Test Dates: 06/21/2021-08/31/2021	EUT Type: AU(AT1K06)		Page 81 of 84

**열람용**  
This certificate may not be reproduced  
other than in full except with  
permission of the issuing laboratory.

**교정성적서**  
CALIBRATION CERTIFICATE



경기도 이천시 마장면 서이천로 578번길 74  
TEL : 031-645-6900, FAX : 031-645-6969

성적서발급번호(Certificate No) : IC-2020-77176  
교정번호(Calibration No) : C-2020-089965

페이지(page) : 1 of 3

- 1. 의뢰자 (Client)**
  - 기관명 (Name) : 피씨테스트코리아 주식회사
  - 주소 (Address) : 경기도 용인시 기흥구 흥덕1로 13, 피136, 피137호(영덕동, 흥덕 IT 밸리)
- 2. 측정기 (Calibration Subject)** ◇ 등록번호 : 369548
  - 기기명 (Description) : HARMONIC MIXER
  - 제작회사 및 형식 (Manufacturer and Model Name) : ROHDE & SCHWARZ / FS-Z90
  - 기기번호 (Serial Number) : 101860
- 3. 교정일자 (Date of Calibration)** : 2020.10.21
- 4. 교정환경 (Environment)**
  - 온도(Temperature) : ( 23.1 ± 0.3 ) °C - 습도(Humidity) : ( 46 ± 3 ) % R.H.
  - 교정장소 (Location) : 고정표준실(Permanent Calibration Lab)  
(주소: 경기도 이천시 마장면 서이천로 578번길 74)
- 5. 측정표준의 소급성 (Traceability)** ◇ Field code : 40641(RF SPECTRUM ANALYZER)  
교정방법 및 소급성 서술 (Calibration method and/or brief description)  
상기 기기는 고주파 스펙트럼 분석기의 교정절차(HCT-CS-125-40641)에 따라 국가측정표준기관으로부터 측정의 소급성이 확보된 아래의 표준장비를 이용하여 교정 되었음.

교정에 사용한 표준장비 명세 (List of used standards/specifications)

기기명 (Description)	제작회사 및 형식 (Manufacturer and Model Name)	기기번호 (Serial Number)	차기교정예정일자 (The due date of next Calibration)	교정기관 (Calibration laboratory)
EXG ANALOG SIGNAL GENERATOR	KEYSIGHT N5173B	MY53270544	2021/06/23	(주)에이치시티
	AGILENT E4419B			
EPM SERIES POWER METER	KEYSIGHT V8486A	MY56330017	2021/01/03	Keysight Technologies
	KEYSIGHT W8486A			
POWER SENSOR	OML S12MS-A	160419-1	2021/09/09	(주)에이치시티
	KEYSIGHT W8486A			

- 6. 교정결과 (Calibration result)** : 교정결과 참조 (Refer to attachment)
- 7. 측정불확도 (Measurement uncertainty)** : 교정결과 참조 (Refer to attachment)  
신뢰수준 약 95 %, k = 2 ( Confidence level about 95 %, k = 2 )

<b>확인 (affirmation)</b>	작성자 (Measurements performed by)	승인자 (Approved by)
	성명 (Name) 박민지	직위 (Title) 기술책임자(Technical Cal. Manager) (중) 성명 (Name) 이승찬

위 성적서는 국제시험기관인정협력체(International Laboratory Accreditation Cooperation) 상호인정협정(Mutual Recognition Arrangement)에 서명한 한국인정기구(KOLAS)로부터 공인 받은 분야의 교정결과입니다.

2020. 10. 21  
한국인정기구 인정 Accredited by KOLAS, Republic of KOREA  
(주)에이치시티 대표이사 President, HCT Co., Ltd.

※ 이 성적서는 측정기의 정밀정확도에 영향을 미치는 요소(과부하, 온도, 습도 등)의 급격한 변화가 발생한 경우에는 무효가 됩니다.  
※ 고객연용사이트(<http://www.callab.co.kr>)에서 성적서의 진위여부 확인이 가능합니다.  
※ 성적서의 원본은 상단에 HCT 로고가 찍혀 있는 워터마크 및 용지 용지에 인쇄되어 발급되며, 원본 복사시에는 복사본이라는 표시가 처리됩니다.

F-02P-02-008 (Rev.02)

FCC ID: A3LAT1K06-A00	<b>PCTEST</b> Proud to be part of  element	MEASUREMENT REPORT (Class II Permissive Change)		Approved by: Technical Manager
Test Report S/N: 8K21060202-R1.A3L	Test Dates: 06/21/2021-08/31/2021	EUT Type: AU(AT1K06)		Page 82 of 84



# Measurement Report

74, Seoicheon-ro 578beon-gil, Majang-myeon,  
Icheon-si, Gyeonggi-do, Korea 17383  
Tel :82-31-645-6900, www.hct.co.kr

보고서번호(Report No) : IC-2021-17234  
측정번호(Measurement No) : C-2021-021269

페이지(page) : 1 of 3

**1. 의뢰자 (Client)**

- 기관명 (Name) : 피씨테스트코리아 주식회사
- 주소 (Address) : 경기도 용인시 기흥구 흥덕1로 13, 피136, 피137호(영덕동, 흥덕 IT 밸리)

**2. 대상품목 (Measurement Item)**

- ◇ HCT 등록번호 : 380382
- 기기명 (Description) : HARMONIC MIXER
- 제작회사 및 형식(Manufacturer and Model Name) : ROHDE & SCHWARZ / FS-Z140
- 기기번호 (Serial Number) : 101135

실무자	기술책임자

**3. 측정일자 (Measurement date) : 2021.03.08**

**4. 측정환경 (Environment)**

- 온도(Temperature) : ( 23.5 ± 0.4 ) °C
- 습도(Humidity) : ( 49 ± 5 ) % R.H.

**5. 측정방법 (Measurement method used)**

상기 기기는 고주파 스펙트럼 분석기의 교정절차(HCT-CS-125-40641)에 따라 국가측정표준기관으로부터 측정의 소급성이 확보된 아래의 표준장비와 자체 점검된 장비를 사용하여 측정 되었음.

측정에 사용한 표준장비 명세 (List of used standards/specifications)

기기명 (Description)	제작회사 및 형식 (Manufacturer and Model Name)	기기번호 (Serial Number)	차기교정예정일자 (The due date of next Calibration)	교정기관 (Calibration laboratory)
EXG ANALOG SIGNAL GENERATOR	KEYSIGHT N5173B	MY53270544	2021/06/23	(주)에이치시티
ERICKSON POWER METER	VDI PM5	394V	측정	(주)에이치시티
WR-08 MULTIPLIER SOURCE MODULE	OML S08MS-A	160419-1	측정	(주)에이치시티
SPECTRUM ANALYZER	H.P 8563EC	3946A00314	2022/03/03	(주)에이치시티

**6. 측정결과 (Measurement result) : 측정결과 참조 (Refer to attachment)**

Ⓜ 이 측정결과는 의뢰자가 제시한 시료 및 시료명에만 한정됩니다.  
The measurement results shown in this report refer only to the sample(s) measured unless otherwise stated.

<b>확 인 (Affirmation)</b>	작성자 (Tested by)		승인자 (Approved by)	
	성명 (Name) : 박민지		직위 (Title) : 기술책임자(Technical Manager) 성명 (Name) : 이승찬	

이 성적서는 ILAC MRA 서명 기관인 KOLAS(Korea Laboratory Accreditation Scheme)와 A2LA (American Laboratory for Laboratory Accreditation)의 인정과 무관합니다. This calibration certificate is Not an accredited report by KOLAS(Korea Laboratory Accreditation Scheme) and A2LA(American Association for Laboratory Accreditation), a ILAC MRA signatory.

2021. 03. 08



(주)에이치시티 대표이사  
President, HCT Co., Ltd.



Ⓜ 측정결과는 측정기의 정밀정확도에 영향을 미치는 요소(과부하, 온도, 습도 등)의 급격한 변화가 발생한 경우에는 무효가 됩니다. If any significant instability or other adverse factor(overload, temperature, humidity etc.) manifests itself before, during or after calibration, and is likely to affect the validity of the calibration.

F-02P-02-010 (Rev.01)

FCC ID: A3LAT1K06-A00		MEASUREMENT REPORT (Class II Permissive Change)		Approved by: Technical Manager
Test Report S/N: 8K21060202-R1.A3L	Test Dates: 06/21/2021-08/31/2021	EUT Type: AU(AT1K06)		Page 83 of 84



# Measurement Report

74, Seoicheon-ro 578beon-gil, Majang-myeon,  
Icheon-si, Gyeonggi-do, Korea 17383  
Tel :82-31-645-6900, www.hct.co.kr

보고서번호(Report No) : IC-2020-77177  
측정번호(Measurement No) : C-2020-089966

페이지(page) : 1 of 3



- 1. 의뢰자 (Client)**
  - 기관명 (Name) : 피씨테스트코리아 주식회사
  - 주소 (Address) : 경기도 용인시 기흥구 흥덕1로 13, 피136, 피137호(영덕동, 흥덕 IT 밸리)
- 2. 대상품목 (Measurement Item)** ◇ HCT 등록번호 : 369547
  - 기기명 (Description) : HARMONIC MIXER
  - 제작회사 및 형식(Manufacturer and Model Name) : ROHDE & SCHWARZ / FS-Z220
  - 기기번호 (Serial Number) : 101015
- 3. 측정일자 (Measurement date)** : 2020.10.21
- 4. 측정환경 (Environment)**
  - 온도(Temperature) : ( 23.1 ± 0.3 ) °C
  - 습도(Humidity) : ( 46 ± 3 ) % R.H.
- 5. 측정방법 (Measurement method used)**

상기 기기는 고주파 스펙트럼 분석기의 교정절차(HCT-CS-125-40641)에 따라 국가측정표준기관으로부터 측정의 소급성이 확보된 아래의 표준장비와 자체 점검된 장비를 사용하여 측정 되었음.

측정에 사용한 표준장비 명세 (List of used standards/specifications)

기기명 (Description)	제작회사 및 형식 (Manufacturer and Model Name)	기기번호 (Serial Number)	차기교정예정일자 (The due date of next Calibration)	교정기관 (Calibration laboratory)
EXG ANALOG SIGNAL GENERATOR	KEYSIGHT N5173B	MY53270544	2021/06/23	(주)에이치시티
ERICKSON POWER METER	VDI PM5	394V	측정	(주)에이치시티
WR-05 MULTIPLIER SOURCE MODULE	OML S05MS-A	160419-1	측정	(주)에이치시티

- 6. 측정결과 (Measurement result)** : 측정결과 참조 (Refer to attachment)  
 (이 측정결과는 의뢰자가 제시한 시료 및 시료명에만 한정됩니다.  
 The measurement results shown in this report refer only to the sample(s) measured unless otherwise stated.)

<b>확 인 (Affirmation)</b>	작성자 (Tested by)		승인자 (Approved by)	
	성명 (Name) : 박민지		직위 (Title) : 기술책임자(Technical Manager) 성명 (Name) : 이승찬	

이 성적서는 ILAC MRA 서명 기관인 KOLAS(Korea Laboratory Accreditation Scheme)와 AZLA (American Laboratory for Laboratory Accreditation)의 인정과 무관합니다. This calibration certificate is Not an accredited report by KOLAS(Korea Laboratory Accreditation Scheme) and AZLA(American Association for Laboratory Accreditation), a ILAC MRA signatory.

2020. 10. 21





(주)에이치시티 대표이사  
President, HCT Co., Ltd.



(이 측정결과는 측정기의 정밀정확도에 영향을 미치는 요소(과부하, 온도, 습도 등)의 급격한 변화가 발생한 경우에는 무효가 됩니다. If any significant instability or other adverse factor(overload, temperature, humidity etc.) manifests itself before, during or after calibration, and is likely to affect the validity of the calibration.

F-02P-02-010 (Rev.01)

FCC ID: A3LAT1K06-A00		MEASUREMENT REPORT (Class II Permissive Change)		Approved by: Technical Manager
Test Report S/N: 8K21060202-R1.A3L	Test Dates: 06/21/2021-08/31/2021	EUT Type: AU(AT1K06)		Page 84 of 84