

SAMSUNG

AT1K01 Series Installation Manual

Describes product installation and requirement procedure.

Document Version 2.0
July 2019

Document Number: 2600-00OFL4GAA

Radio Access Network

© 2019 SAMSUNG Electronics Co., Ltd.

All Rights Reserved. The contents of this document/presentation contain proprietary information that must be kept confidential. No part of this document shall be photocopied, reproduced, stored in a retrieval system, or transmitted, in any form or by any means whether, electronic, mechanical, or otherwise without the prior written permission of SAMSUNG Electronics Co., Ltd.

No warranty of accuracy is given concerning the contents of the information contained in this publication. To the extent permitted by law no liability (including liability to any person by reason of negligence) will be accepted by SAMSUNG Electronics Co., Ltd., its subsidiaries or employees for any direct or indirect loss or damage caused by omissions from or inaccuracies in this document. SAMSUNG Electronics Co., Ltd. reserves the right to change details in this publication without notice.

SNMTC-v3-0312

This manual should be read and used as a guideline for properly installing and/or operating the product. Owing to product variations across the range, any illustrations and photographs used in this manual may not be a wholly accurate depiction of the actual products you are using.

This manual may be changed for system improvement, standardization and other technical reasons without prior notice.

Samsung Networks documentation is available at www.samsungdocs.com

Samsung Networks Website and YouTube Channel
Official Website: www.samsungnetworks.com/

YouTube: www.youtube.com/samsung5g

Contents

Preface		ix
	Conventions in this Document	ix
	New and Changed Information	x
	Revision History.....	x
	Organization of This Document	x
	Personal and Product Safety	xi
	Equipment Markings	xv
Chapter 1	Before Installation	1
	AU View and External Interface	1
	<i>AU View</i>	1
	<i>AU External Interface</i>	2
	Specifications	3
	Cautions for Installation.....	4
	<i>Before Installing</i>	4
	<i>While Installing</i>	4
	<i>After Installing</i>	5
	Installation Tools	6
Chapter 2	Installing System	9
	Installation Procedure	9
	System Arrangement	10
	<i>Using Tilting and Swiveling Bracket</i>	10
	<i>Using No Tilting Bracket</i>	14
	Transporting and Unpacking	16
	<i>Bringing in Items</i>	16
	<i>Unpacking</i>	17
	AU Handling	18
	Fixing AU	19
	<i>Using Tilting and Swiveling Bracket</i>	19
	<i>Using No Tilting Bracket</i>	44
Chapter 3	Connecting Cables	56
	Cabling Procedure	56
	Guidelines for Cable Connections	57
	<i>Cable Path Inspection</i>	57
	<i>Cable Cutting</i>	58
	<i>Cable Installation</i>	58
	<i>Connector Attachment</i>	59
	<i>Cable Binding</i>	59
	<i>Identification Tag Attachment</i>	60
	Cabling Diagram	61
	Grounding	62
	<i>Connecting Ground Cable</i>	62
	Power Cabling	65
	<i>Connecting Power Cable</i>	66
	Interface Cable Connection.....	75
	<i>Remove/Insert Optical Module</i>	75

	<i>Connecting Backhaul Cable</i>	77
	<i>Connecting UDA Cable</i>	89
	<i>GPS Cable Connection</i>	95
Chapter 4	Inspect the Installation	97
Appendix A	Acronyms	101
Appendix B	GPS Antenna Installation	102
	GPS Antenna System Configuration	102
	<i>Lightening Arrestor</i>	104
	Interference Signal	105
	<i>Interference Types</i>	105
	<i>Avoiding Interference</i>	105
	GPS Antenna Installation.....	107
Appendix C	Clean the Optical Connectors	108
Appendix D	Standard Torque	111

List of Figures

Figure 1.	AU View.....	1
Figure 2.	AU External Interface	2
Figure 3.	Procedure to Install the AU	9
Figure 4.	AU Arrangement_1 Sector Pole Type Installation.....	10
Figure 5.	AU Arrangement_2 Sector Pole Type Installation.....	11
Figure 6.	AU Arrangement_3 Sector Pole Type Installation.....	11
Figure 7.	AU Arrangement_Pole Type Tilting.....	12
Figure 8.	AU Arrangement_Pole Type Swiveling.....	12
Figure 9.	AU Arrangement_Wall Type Installation	13
Figure 10.	AU Arrangement_Wall Type Tilting.....	13
Figure 11.	AU Arrangement_Wall Type Swiveling	14
Figure 12.	AU Arrangement_1 Sector Pole Type Installation.....	15
Figure 13.	AU Arrangement_2 Sector Pole Type Installation.....	15
Figure 14.	AU Arrangement_3 Sector Pole Type Installation.....	16
Figure 15.	Using a Handle to transport an AU	18
Figure 16.	Fixing Unit Bracket (1)	20
Figure 17.	Fixing Unit Bracket (2)	21
Figure 18.	Fixing Mounting Bracket on the Pole (1).....	23
Figure 19.	Fixing Mounting Bracket on the Pole (2).....	24
Figure 20.	Fixing Mounting Bracket on the Pole (3).....	25
Figure 21.	Fixing Mounting Bracket on the Pole (4).....	25
Figure 22.	Fixing Mounting Bracket on the Pole (5).....	26
Figure 23.	Fixing Mounting Bracket on the Pole (6).....	27
Figure 24.	Lifting AU	28
Figure 25.	Fixing AU on the Pole (1).....	29
Figure 26.	Fixing AU on the Pole (2).....	30
Figure 27.	AU Marking Dimensions.....	32
Figure 28.	Marking	33
Figure 29.	Drilling	34
Figure 30.	Fixing Mounting Bracket on the Wall (1)	35
Figure 31.	Fixing Mounting Bracket on the Wall (2)	36
Figure 32.	Fixing AU on the Wall	37
Figure 33.	AU Tilting Adjustment (1).....	39
Figure 34.	AU Tilting Adjustment (2).....	40
Figure 35.	AU Tilting Adjustment (3).....	41
Figure 36.	AU Swiveling Adjustment (1).....	42
Figure 37.	AU Swiveling Adjustment (2).....	43
Figure 38.	AU Swiveling Adjustment (3).....	44
Figure 39.	Fixing Unit Bracket	45
Figure 40.	Fixing Mounting Bracket on the Pole (1).....	47
Figure 41.	Fixing Mounting Bracket on the Pole (2).....	48
Figure 42.	Fixing Mounting Bracket on the Pole (3).....	48
Figure 43.	Fixing Mounting Bracket on the Pole (4).....	49
Figure 44.	Fixing Mounting Bracket on the Pole (5).....	50
Figure 45.	Lifting AU	51
Figure 46.	Fixing AU on the Pole (1).....	52
Figure 47.	Fixing AU on the Pole (2).....	53

Figure 48.	Fixing AU on the Pole (3).....	54
Figure 49.	Fixing AU on the Pole (4).....	54
Figure 50.	Procedure to Connect System Cable.....	56
Figure 51.	Cable Connection Procedure.....	57
Figure 52.	Cable Diagram.....	61
Figure 53.	Connecting Ground Cable (1).....	63
Figure 54.	Connecting Ground Cable (2).....	64
Figure 55.	Power Equipment Elements.....	65
Figure 56.	Connecting Power Cable_AC (1).....	67
Figure 57.	Connecting Power Cable_AC (2).....	68
Figure 58.	Connecting Power Cable_AC (3).....	69
Figure 59.	Connecting Power Cable_DC (1).....	71
Figure 60.	Connecting Power Cable_DC (2).....	72
Figure 61.	Connecting Power Cable_DC (3).....	73
Figure 62.	Optical Module Removal (1).....	75
Figure 63.	Optical Module Removal (2).....	75
Figure 64.	Optical Module Removal (3).....	76
Figure 65.	Optical Module Insert.....	76
Figure 66.	Case#1) Connecting Backhaul Cable (1).....	78
Figure 67.	Case#1) Connecting Backhaul Cable (2).....	79
Figure 68.	Case#1) Connecting Backhaul Cable (3).....	79
Figure 69.	Case#1) Connecting Backhaul Cable (4).....	80
Figure 70.	Case#2) Connecting Backhaul Cable_Cascade (1).....	83
Figure 71.	Case#2) Connecting Backhaul Cable_Cascade (2).....	83
Figure 72.	Case#2) Connecting Backhaul Cable_Cascade (3).....	84
Figure 73.	Case#2) Connecting Backhaul Cable_Cascade (4).....	85
Figure 74.	Remove Backhaul Cable (1).....	87
Figure 75.	Remove Backhaul Cable (2).....	88
Figure 76.	Connecting UDA Cable (1).....	90
Figure 77.	Connecting UDA Cable (2).....	91
Figure 78.	Connecting UDA Cable (3).....	92
Figure 79.	Remove UDA Cable (1).....	93
Figure 80.	Remove UDA Cable (2).....	94
Figure 81.	GPS Antenna Connection_Direct Installation (1).....	95
Figure 82.	GPS Antenna Connection_Direct Installation (2).....	96
Figure 83.	Installation Inspection Procedure.....	97
Figure 84.	Example of a Common GPS Antenna System Configuration.....	102
Figure 85.	GPS Antenna Installation.....	104
Figure 86.	Cleaning MPO Connector_Plug side (1).....	108
Figure 87.	Cleaning MPO Connector_Plug side (2).....	109
Figure 88.	Cleaning MPO Connector_Receptacle side (1).....	109
Figure 89.	Cleaning MPO Connector_Receptacle side (2).....	110

List of Tables

Table 1.	Specifications	3
Table 2.	Basic Installation Tools	6
Table 3.	Parts and Tools for Fixing Unit Bracket on AU	19
Table 4.	Parts and Tools for Fixing Mounting Bracket on the Pole	22
Table 5.	Parts and Tools for Fixing AU on the Pole	28
Table 6.	Tools for Marking	30
Table 7.	Parts and Tools for Drilling	33
Table 8.	Anchor Bolt Drill Bits and Hole Depth	33
Table 9.	Parts and Tools for Fixing Mounting Bracket on the Wall.....	34
Table 10.	Parts and Tools for Fixing AU on the Wall.....	36
Table 11.	Tools for Tilting AU.....	37
Table 12.	Tools for Swiveling AU.....	42
Table 13.	Parts and Tools for Fixing Unit Bracket on AU	45
Table 14.	Parts and Tools for Fixing Mounting Bracket on the Pole	46
Table 15.	Tools for Fixing AU on the Pole	51
Table 16.	Recommended Minimum Allowed Cable Bending Radius	59
Table 17.	AU Connection Cable	61
Table 18.	Parts and Tools for Connecting Ground Cable	62
Table 19.	Parts and Tools for Connecting Power Cable_AC.....	66
Table 20.	Power Cable/Connector Pin Map_AC	66
Table 21.	Parts and Tools for Connecting Power Cable_DC	70
Table 22.	Power Cable/Connector Pin Map_DC	70
Table 23.	Case#1) Parts and Tools for connecting Backhaul Cable.....	77
Table 24.	Case#2) Parts and Tools for connecting Backhaul Cable_Cascade	81
Table 25.	Parts and Tools for Remove Backhaul Cable	86
Table 26.	Parts and Tools for Connecting UDA Cable	89
Table 27.	UDA Cable Pin Map	90
Table 28.	Parts and Tools for Remove UDA Cable	92
Table 29.	Parts and Tools for GPS Antenna (Direct Installation)	95
Table 30.	Construction Situation Checklist	98
Table 31.	GPS Antenna system Configuration	102
Table 32.	MPO Connector Cleaning Tools	108
Table 33.	Standard Torque Value for Fastening Bolts	111
Table 34.	Brass Bolts Torque Value.....	111
Table 35.	Connector Connection Torque Value.....	111







Preface

This manual describes how to install a Samsung AT1K01 Series and how to connect its cables.

Conventions in this Document

Samsung Networks product documentation uses the following conventions.

Symbols

Symbol	Description
	Indicates a task.
	Indicates a shortcut or an alternative method.
	Provides additional information.
	Provides information or instructions that you should follow to avoid service failure or damage to equipment.
	Provides information or instructions that you should follow to avoid personal injury or fatality.
	Provides antistatic precautions that you should observe.

Menu Commands

menu | command

This indicates that you must select a command on a menu, where **menu** is the name of the menu, and **command** is the name of the command on that menu.

File Names and Paths

These are indicated by a bold typeface. For example:

Copy **filename.ext** into the **/home/folder1/folder2/bin/** folder.

User Input and Console Screen Output Text

- The input and output text is presented in the Courier New font. For example, `context <designated epc-context-name>`
- The CLI command is presented in capital letters and Courier New, bold style. For example, Type the **RTRV-NE-STS** command in the input field.
- The YANG object is presented in the small letters and boldface. For example, **eutran-cell-conf-idle**

New and Changed Information

This section describes information that has been added/changed since the previous publication of this manual.

- The Personal and Product Safety and the Equipment Markings are updated.
- The Specifications is changed as follows:
 - The Antenna Gain, the Channel Bandwidth/Capacity, the RF Output Power, the Input Current, the IP rating and the EMC are updated.

Revision History

The following table lists all versions of this document.

Document Version	Publication Date	Remarks
1.0	June 2019	First version
2.0	July 2019	<ul style="list-style-type: none"> • The Personal and Product Safety and the Equipment Markings are updated. • The Specifications is updated.

Organization of This Document

Section	Title	Description
Chapter 1	Before Installation	This chapter introduces AU and describes the items that should be understood before installation.
Chapter 2	Installing System	This chapter describes the procedures to install the AU.
Chapter 3	Connecting Cables	This chapter describes the procedures to connect the cables to the installed AU.
Chapter 4	Inspect the Installation	This chapter describes the procedures of inspecting installation status after the AU installation and cabling is completed.
Appendix A	Acronyms	This appendix describes the acronyms used in this manual.
Appendix B	GPS Antenna Installation	This appendix describes the procedure of installing GPS antenna.
Appendix C	Clean the Optical Connectors	This appendix describes the procedure of cleaning the optical connector and cleaning tool.
Appendix D	Standard Torque	This appendix describes the standard torque when fastening the bolt.

Personal and Product Safety

This product safety information includes European directives, which you must follow. If these do not apply in your country, please follow similar directives that do apply in your country.

Electrical

The product is designed to operate from a power supply and is therefore classified as Safe Extra Low Voltage (SELV) equipment.

All structural parts are grounded and all input and outputs have built-in isolation from the network. All input and output ports that connect to external power sources are designed to meet relevant national safety requirements.

The product contains hazardous energy levels as defined by UL 60950 or 62368. Care must be taken when maintaining this equipment as injury to personnel or damage to the equipment could result from mistakes. Maintenance should only be carried out by trained and competent engineers who are familiar with the relevant procedures and instructions.

Lasers

The product is fitted with optic modules rated as Class 1 radiation-emitting devices under IEC/EN 60825-1. During installation, operation, and maintenance, never look into the end of an optical fiber directly or by reflection either with the naked eye or through an optical instrument. Do not operate equipment with exposed fiber connectors—cover these with fiber cables or blanking caps. Do not remove equipment covers during operation unless requested to do so in the documentation. Carry out normal safety precautions when trimming fibers during installation.

Manual Handling

Care should be taken when handling equipment. Give due consideration to the weight of the equipment, the physical capability of the individual(s) handling the equipment, and movements such as twisting, bending and stooping, which could lead to skeletal and muscular injuries.

Installation

Installation must be carried out by trained and competent engineers only. All relevant safety measures should be taken to ensure equipment is not connected to live power and transmission sources during installation. Equipment must be correctly installed in order to meet the relevant safety standards and approval conditions.

Each power feed to the unit requires a separate fused feed from the provided power supply. The cable between the power distribution point and the installed equipment must have a minimum cross-sectional area of 2.5 mm².

Maintenance

Maintenance must only be carried out by a suitably trained and competent technician. All safety instructions must be carefully observed at all times. Equipment covers should not be removed while live power and transmission is connected unless in a controlled environment by trained technicians.

Fire

The product is powered from a power supply. To protect against fire, the equipment is fused.

Environment

The product must be operated in an environment with the specified relative humidity and ambient temperature ranges.

Keep all liquids away from the equipment as accidental spillage can cause severe damage.

Cooling

The product is natural convection cooling type.

Anti-Static Precautions

The circuit boards and other modules in the product are sensitive to and easily damaged by static electricity. If any card or sub-assembly is removed from the unit, the following anti-static precautions must be observed at all times:

- Service personnel must wear anti-static wrist straps.
- Circuit boards and sub-assemblies must be placed on ground conductive mats or in conductive bags.
- All tools must be discharged to ground before use.
- The anti-static wrist strap and cord must be checked at regular intervals for their suitability for use.

Grounding

To comply with UL 60950 or 62368, the equipment must be connected to a safety grounding point via a permanent link. Grounding points are located on the product for this purpose. Always connect the ground cable before fitting other cables. The product must remain grounded continuously unless all connections to the power supply and data network are all removed.

If equipment is grounded through a cabinet or rack, make sure it is done so properly.

Power Supply Connection

Power connections and installation of associated wiring must be carried out by a suitably qualified technician.

Only devices that comply with all relevant national safety requirements should be connected to the unit's power supply inlets. Other usage will invalidate any approval given to this equipment.

Connection of this equipment to devices that are not marked with all relevant national safety requirements may produce hazardous conditions on the network.

When the power supply is obtained by a rectifier/safety isolation transformer, the supply must meet the requirements of UL 60950 or 62368 providing double/reinforced insulation between hazardous voltages and SELV/TNV circuits. Any battery must be separated from hazardous voltages by reinforced insulation.

Indirect Connection

Before indirectly connecting any equipment to another device through a shared power supply, ALWAYS seek advice from a competent engineer.

Devices that are not marked according to the relevant national safety standards may produce hazardous conditions on the network.

Product Disposal

To reduce the environmental impact of products, Samsung has joined WEEE compliance activities.

The WEEE symbol on the product indicates that the product is covered by the European Directive 2002/96/CE for the disposal of Waste Electrical and Electronic Equipment (WEEE). This means that the product should be disposed of separately from the municipal waste stream via designated collection facilities appointed by the government or the local authorities. This will help prevent potential negative consequences for the environment and human health. Please check the terms and conditions of the purchase contract for information about correct disposal.

California USA Only

This Perchlorate warning applies only to primary CR (Manganese Dioxide) Lithium coin cells in the product sold or distributed ONLY in California USA

‘Perchlorate Material-special handling may apply, See www.dtsc.ca.gov/hazardouswaste/perchlorate.’

FCC Statement

This equipment has been tested and found to comply with the limits for a Class A digital device, pursuant to part 15 of the FCC Rules. These limits are designed to provide reasonable protection against harmful interference when the equipment is operated in a commercial environment. This equipment generates, uses, and can

radiate radio frequency energy and, if not installed and used in accordance with the instruction manual, may cause harmful interference to radio communications. Operation of this equipment in a residential area is likely to cause harmful interference in which case the user will be required to correct the interference at his own expense.

Any changes or modifications not expressly approved by the party responsible for compliance could void the user's authority to operate this equipment.

Proposition 65 (US Only)

State of California Proposition 65 Warning (US only)

WARNING: This product contains chemicals known to the State of California to cause cancer and birth defects or other reproductive harm.

Equipment Markings

**Hot surface warning**

Allow to cool before servicing.

Do not touch before cooling.

Notice! Be careful not to touch due to high temperature.

The system must be installed in a restricted area, and make sure the work is done by personnel properly trained for the job.

**Protective earth**

AU should be grounded.

Chapter 1 Before Installation

This chapter introduces the AU system and describes the items that you should know before installation.

AU View and External Interface

This section provides the physical structure of the AU and its interfaces.

AU View

The figure below depicts the physical structure of the AU:

Figure 1. AU View

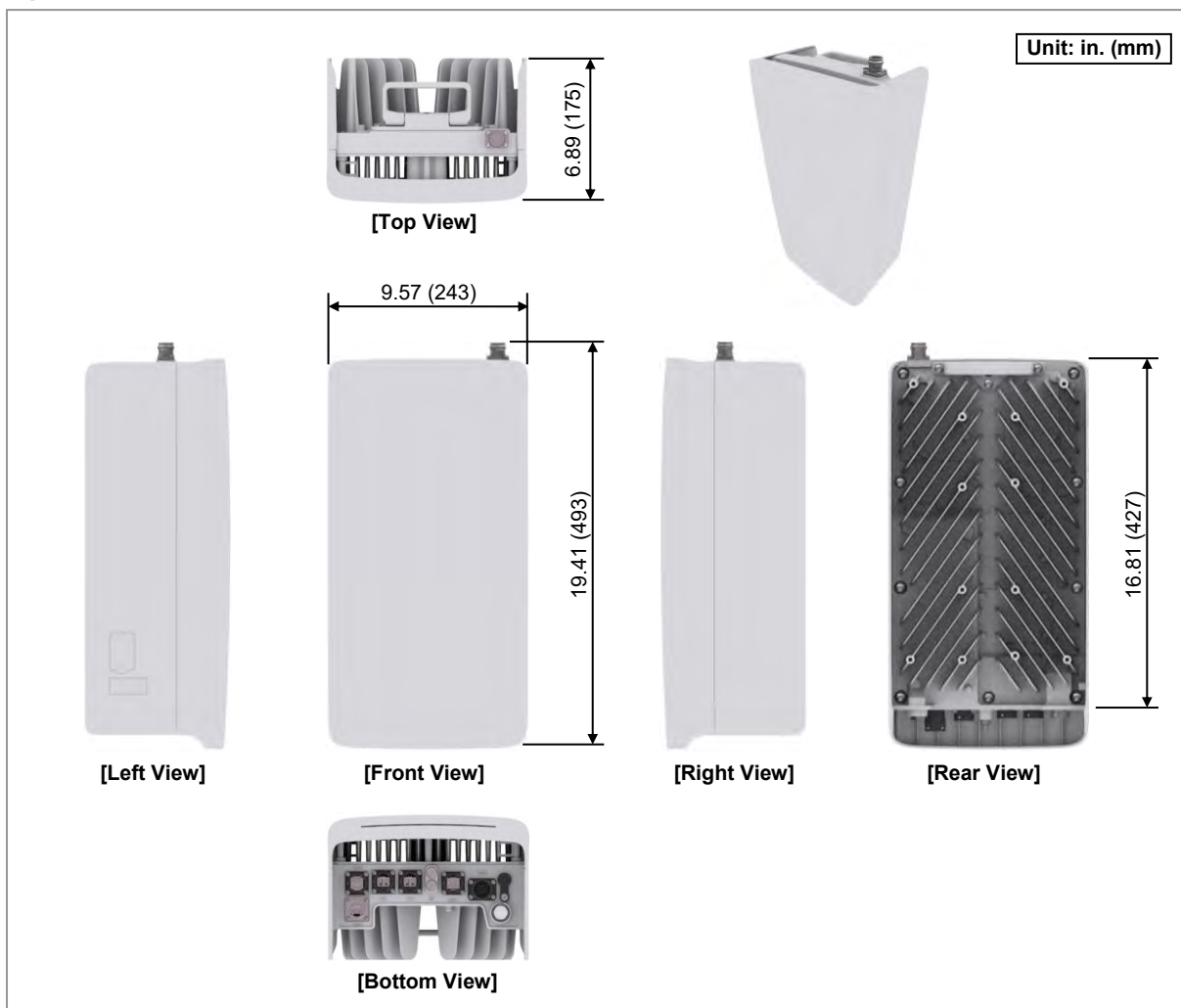

AU External Interface

The figure below depicts the external interface structure of the AU:

Figure 2. AU External Interface

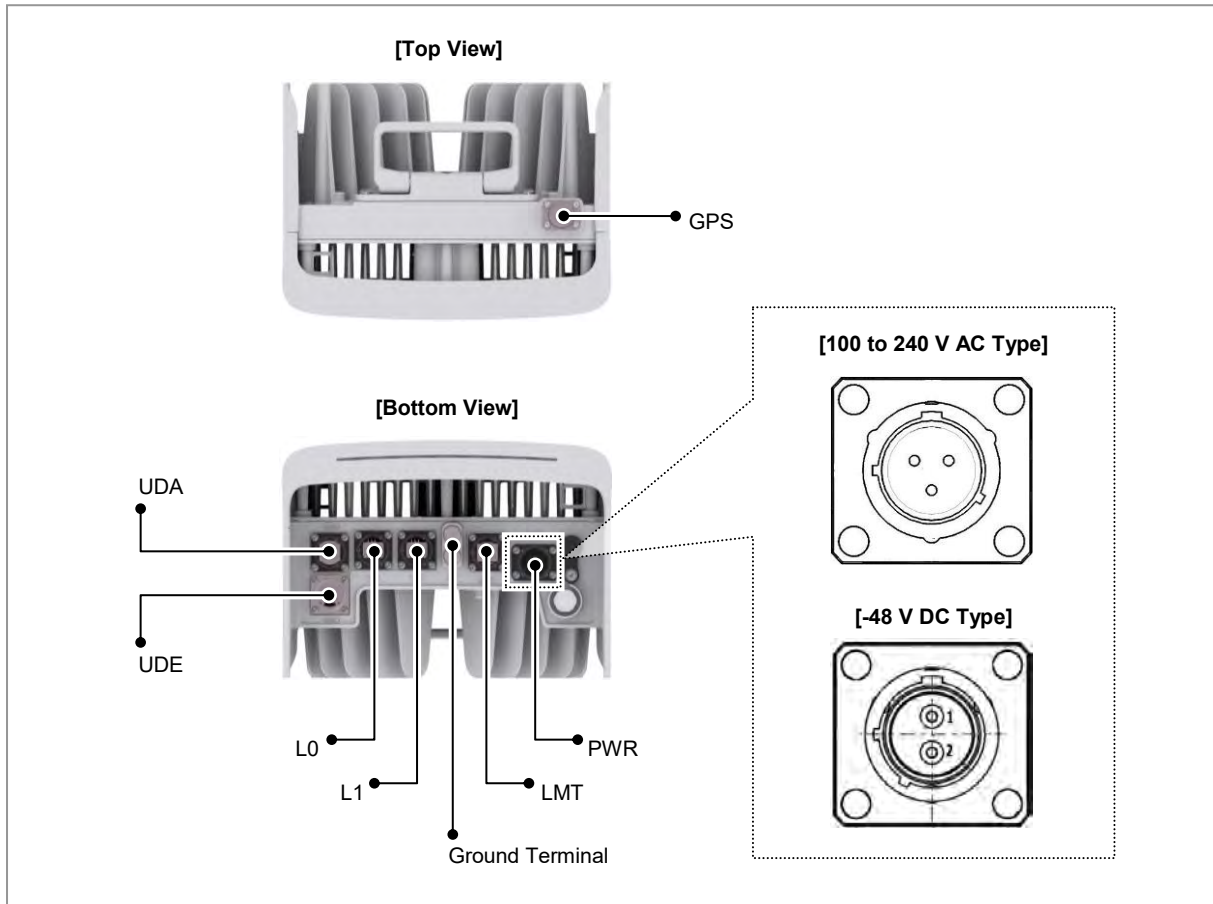

Specifications

The table below outlines the main specifications of the AU:

Table 1. Specifications

Item	AT1K01
Technology	5G NR
Operating Frequency	27.5 to 28.35 GHz
Input Voltage	-48 V DC (-36 to -58 V DC) or 100 to 240 V AC
LED	Total: 1 EA Powered, Operational, Fail (3 Status w/different colors)
Operational Temperature	-40~55°C (with solar load)
Humidity	TBD
IP rating	IP65
EMC	FCC Title 47 CFR Part 15 Subpart B
Safety	UL 60950 or 62368
Installation	Pole/Wall/Tower mounting
Dimension (W × D × H)	<ul style="list-style-type: none"> • 9.57 in. (243 mm) × 6.89 in. (175 mm) × 16.81 in. (427 mm) •(@without cover) • 9.57 in. (243 mm) × 6.89 in. (175 mm) × 19.4 in. (493 mm) (@with cover & GPS Port)
Volume	< 18.16 L
Weight	< 33.07 lb (15.8 kg)

Cautions for Installation

Observe the safety instructions described in this section when installing the system.

Installation should be done in accordance with the applicable local electric codes.

Before Installing

Before starting the installation, ensure the following:

- Post warning signs in areas where high-voltage cables are installed.
- Post 'off limit' signs in areas where accidents are most expected.
- Use guardrails or fences to block open areas such as ditches, open roof areas, and scaffolds.



Install the system in the restricted access area.

While Installing

During installation, ensure the following:

The system power must be cut off before installing.



Ensure that the power switch of the power supply is off when installing the system. Installing the system with power on may cause system damage or fatal human injury when connecting or disconnecting cables.



Ensure that workers wear protection gloves and goggles to prevent injury from debris while drilling holes in a wall or ceiling.



Do not wear accessories such as watches and rings to prevent electrical shock.



Cover unused ports with a cap. This prevents foreign substances from entering into the unused ports.



To prevent foreign substances, outdoor air, and moisture from entering the cable inlet (including cable gland and conduit), finish the inlet as follows:

- Unused inlet: Use the hole finishing materials including cap and rubber packing.
- Cable-installed inlet: After cable installation, block any space in the inlet with tape, compressed sponge, rubber packing, and silicone.



Keep a safe distance between the base station antenna (AU) and people.

AU	Safe Distance
AT1K01	157.48 inch (400 cm)

Do not co-locate nor operate in conjunction with any other antenna or transmitter for the protection of general public from exposure to radio frequency electromagnetic field.

After Installing

After installation, remove any debris produced during the work and clean up the installation site.



In the system, the laser beam light runs through the optical cable. The workers must handle the optical cables with care as the laser beam can seriously damage the eyes.



Ensure that the workers do not damage installed cables while cleaning the system.



While cleaning the power supply device, take precaution that the device does not come in contact with foreign objects that may cause power failure.













DOUBLE POLE/NEUTRAL FUSING















AT1K01-A00 (AC Type model) has double pole (neutral fusing) at the AC power port. So, service person should turn off the relevant circuit breaker at power distribution panel, before servicing this equipment.







Installation Tools

The basic tools required for installation are listed in the table below. The additional tools required for each site need to be identified and arranged during a site survey before starting the installation.

Table 2. Basic Installation Tools

Number	Name	Specification	Purpose of use
1	Tool Box 	-	To keep all the tool items in the box
2	Torque Driver 	Apply a torque range : 20 to 90 lbf·in	Fastening M6 SEMS
3	Screw Driver Bit 	+, No. 3	Fastening M6 SEMS
4	Screw Driver 	+, No. 3	Loosening M6 SEMS
5	Torque Wrench 	Apply a torque range: 10 to 50 lbf·in	Tightening M6 Hex. bolt and 4.3-10 Connector
		Apply a torque range: 100 to 400 lbf·in	Tightening M8 Hex. bolt
6	Torque Wrench Spanner Head 	Apply Hex. bolt head: 10 mm (for 10 to 50 lbf·in)	Tightening M6 Hex. bolt
		Apply Hex. bolt head: 13 mm (for 100 to 400 lbf·in)	Tightening M8 Hex. bolt
		Apply Hex. bolt head: 22 mm (for 10 to 50 lbf·in)	Tightening 4.3-10 Connector
7	Spanner 	10 mm	Loosening M6 Hex. bolt
		13 mm	Loosening M8 Hex. bolt
		22 mm	Loosening 4.3-10 Connector
8	Tape Measure 	16/150 ft.	Measuring length
9	Power Extension Cable 	100 ft.	Basic tool
10	Level 	Normal	Levelling horizontality and verticality
11	Hammer Drill	Normal	Drilling wall

Number	Name	Specification	Purpose of use
			
12	Concrete Drill Bit 	12 mm	Setting M8 Anchor
13	Heating Gun 	50 to 300°C	Shrinking the feeder cable tube
14	Anchor Punch 	M8	Setting M8 anchor
15	Hammer 	Normal	Fixing anchor
16	Vacuum Cleaner 	Normal	Removing dust during the drilling work
17	Cable Cutter 	0.24-1.26 in. (6-32 mm)	Cutting cable
18	Crimping Tool 	14-4 AWG (1.5 to 16 mm ²)	Crimping pressure terminal
19	Wire Stripper 	Apply cable thickness: 1.5 to 6.2 in. (4 to 16 mm)	Removing cable sheath
20	Nipper 	Basic Tool	Cutting cable
21	Flush cutter 	Basic Tool	For cutting cable tie
22	Industrial Scissor 	Basic Tool	Cutting
23	Knife 	Basic Tool	Cutting
24	Heating Gun 	50 to 300°C	Shrinking the feeder cable tube

Number	Name	Specification	Purpose of use
25	Multi tester 	Digital Pocket Tester	Checking voltage and current to detect cable disconnection
26	Fiber Optical Test Set 	Wave length: 1310 nm, 1550 nm (single mode) 850 nm, 1310 nm (multi-mode)	Checking optical level
27	Optical Connector Cleaner 	For LC Connector	Cleaning Optical Connector
28	Optical Transceiver Removal Tool 	Normal	For separating the optical module
29	Antenna Alignment Tool 	-	Checking azimuth and tilting
30	Angle Meter 	Normal	Checking MMU Tilting
31	Compass 	Normal	Check azimuth during installation



The required installation tools may vary depending on the site conditions. In addition to the basic tools, protractor, ladder, safety equipment, and cleaning tools must also be arranged, considering the site conditions.

Chapter 2 Installing System

This chapter describes the installation procedures of the AU.

Installation Procedure

The figure below depicts the overall procedures for installing the AU:

Figure 3. Procedure to Install the AU

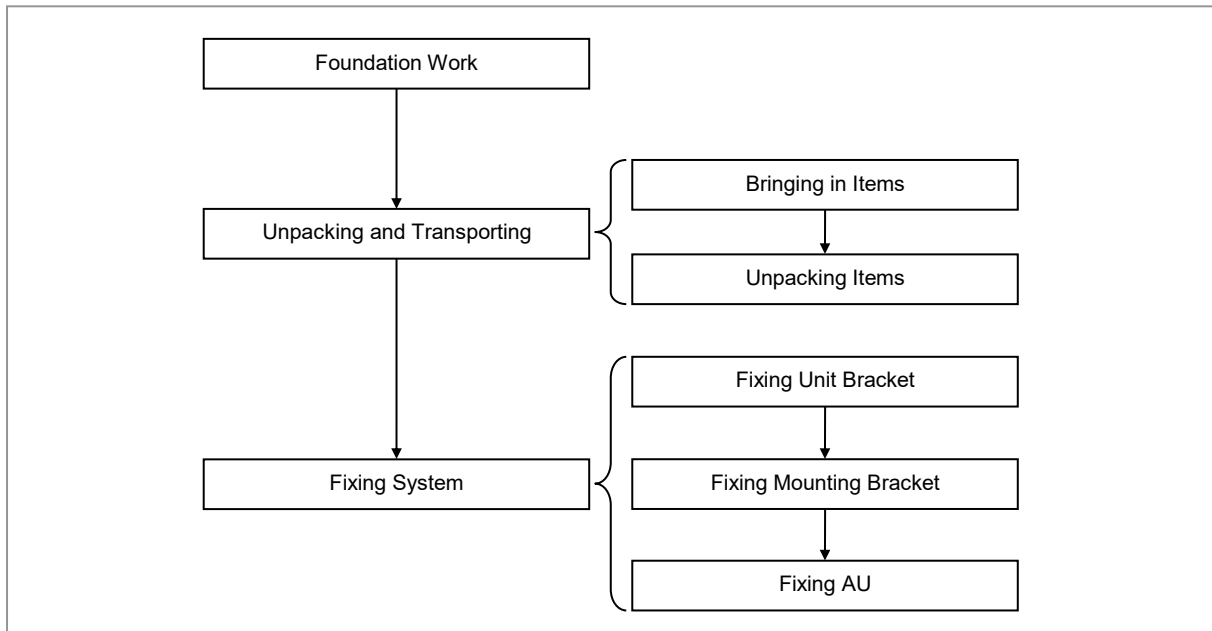

System Arrangement

A minimum distance must be secured around the AU, in each direction for installation and maintenance.



The recommended clearance for installing the AU is as follows.

Category	Recommended Distances	Remarks
Front	≥ 32 in. (800 mm)	-
Sides	≥ 8 in. (200 mm)	Standard Installation
Top	≥ 16 in. (400 mm)	-
Bottom	≥ 16 in. (400 mm)	Over the ground, without cover

Using Tilting and Swiveling Bracket

The figures below depict the recommended distances for each direction of the AU using the tilting and swiveling bracket for the wall and the pole type installations:

Figure 4. AU Arrangement_1 Sector Pole Type Installation

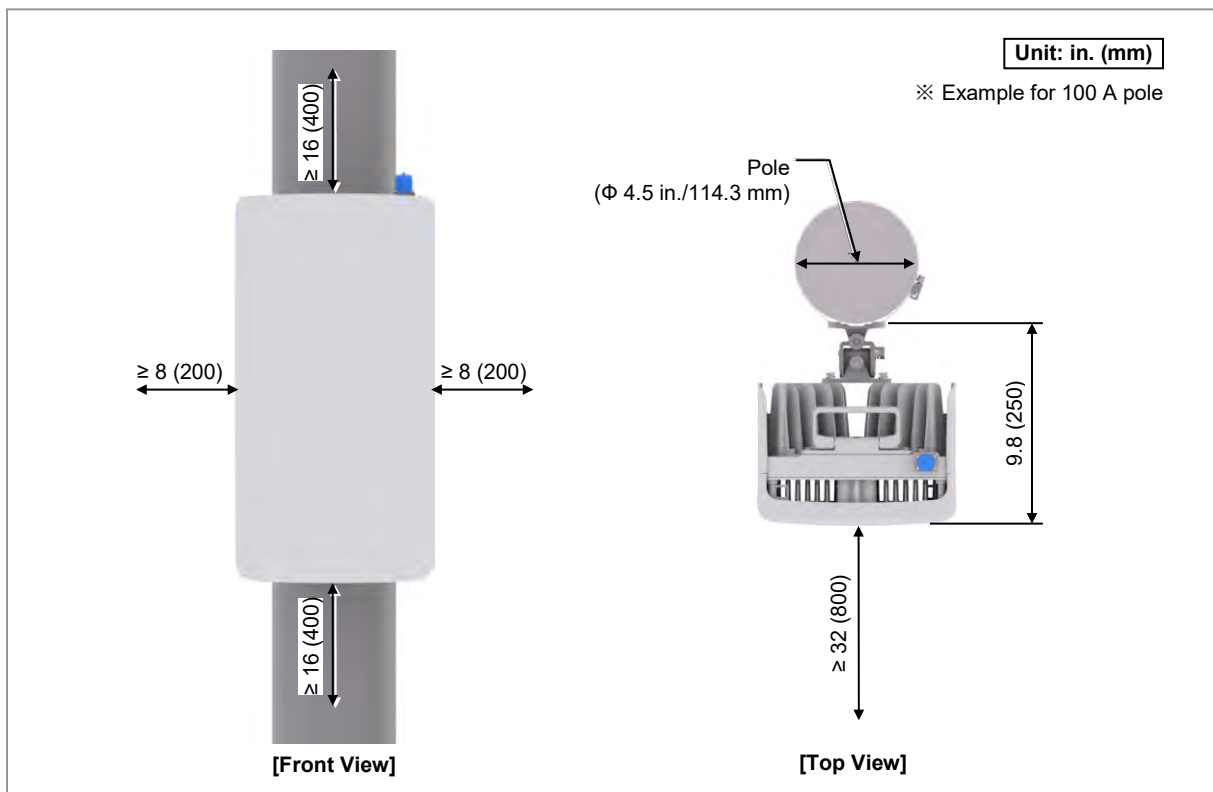

Figure 5. AU Arrangement_2 Sector Pole Type Installation

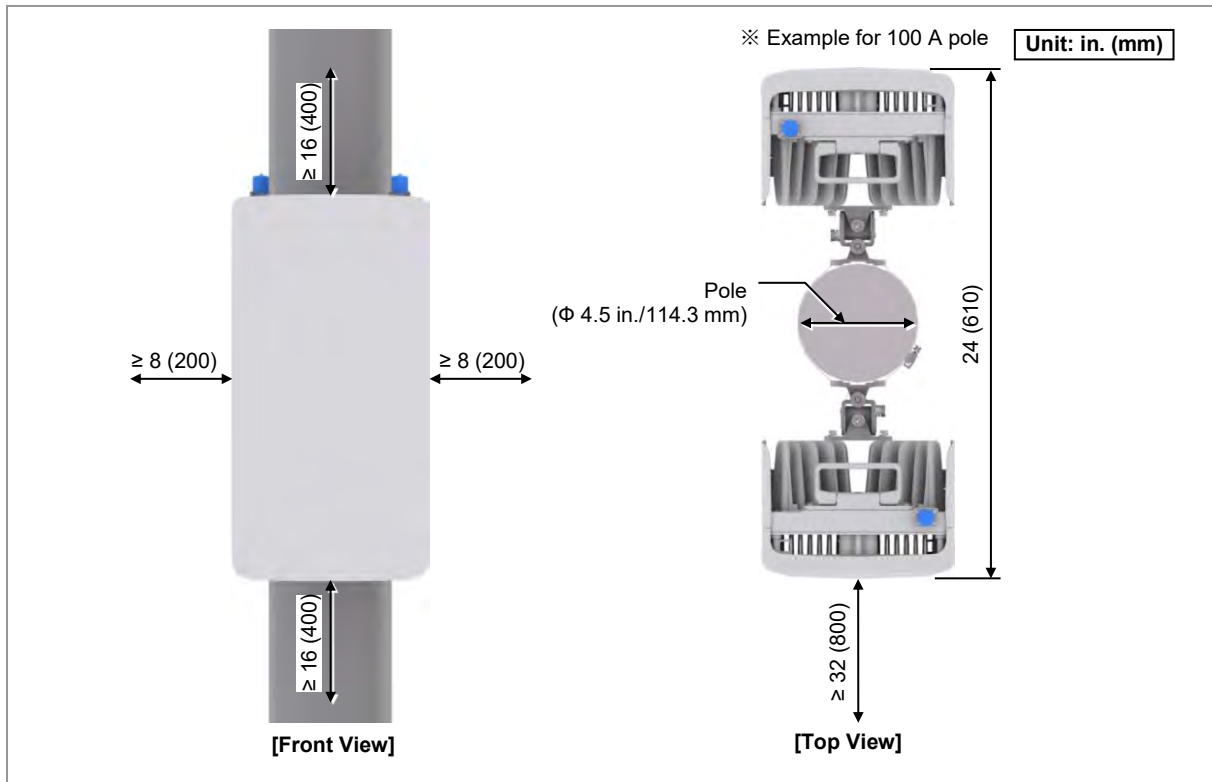

Figure 6. AU Arrangement_3 Sector Pole Type Installation

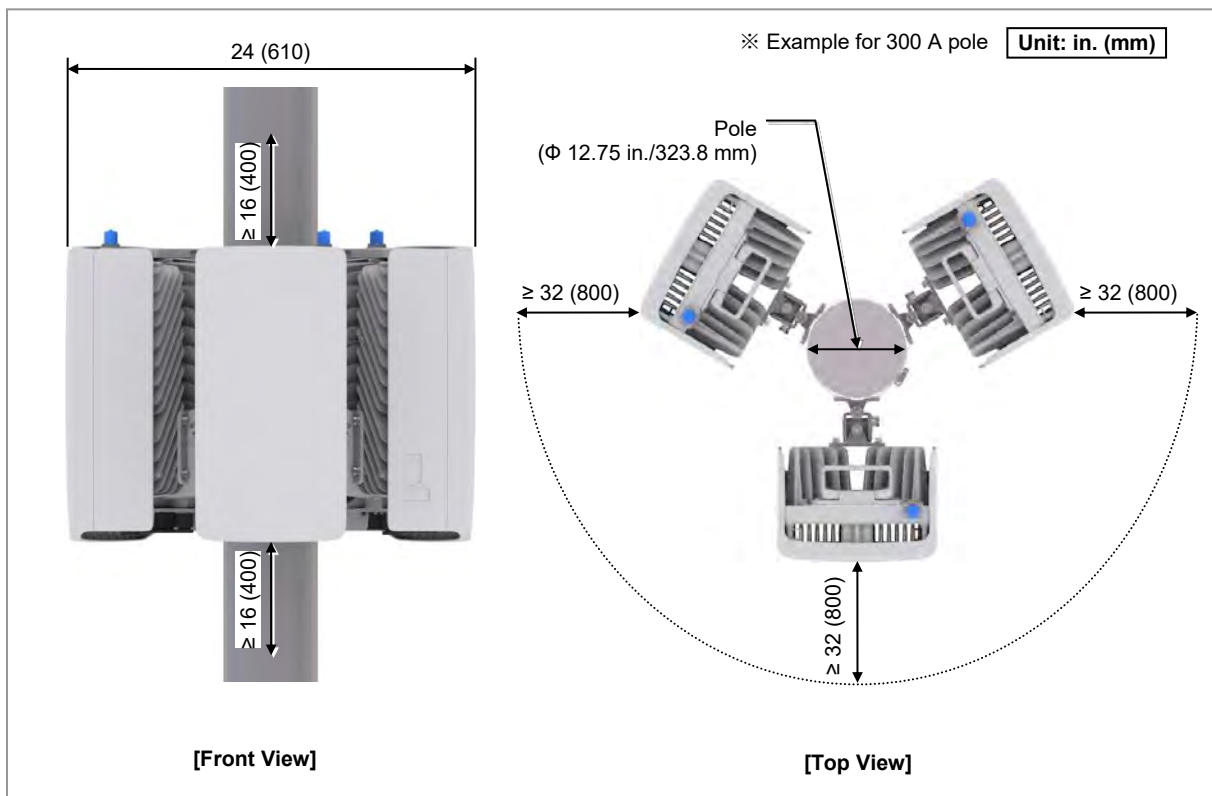

Figure 7. AU Arrangement_Pole Type Tilting

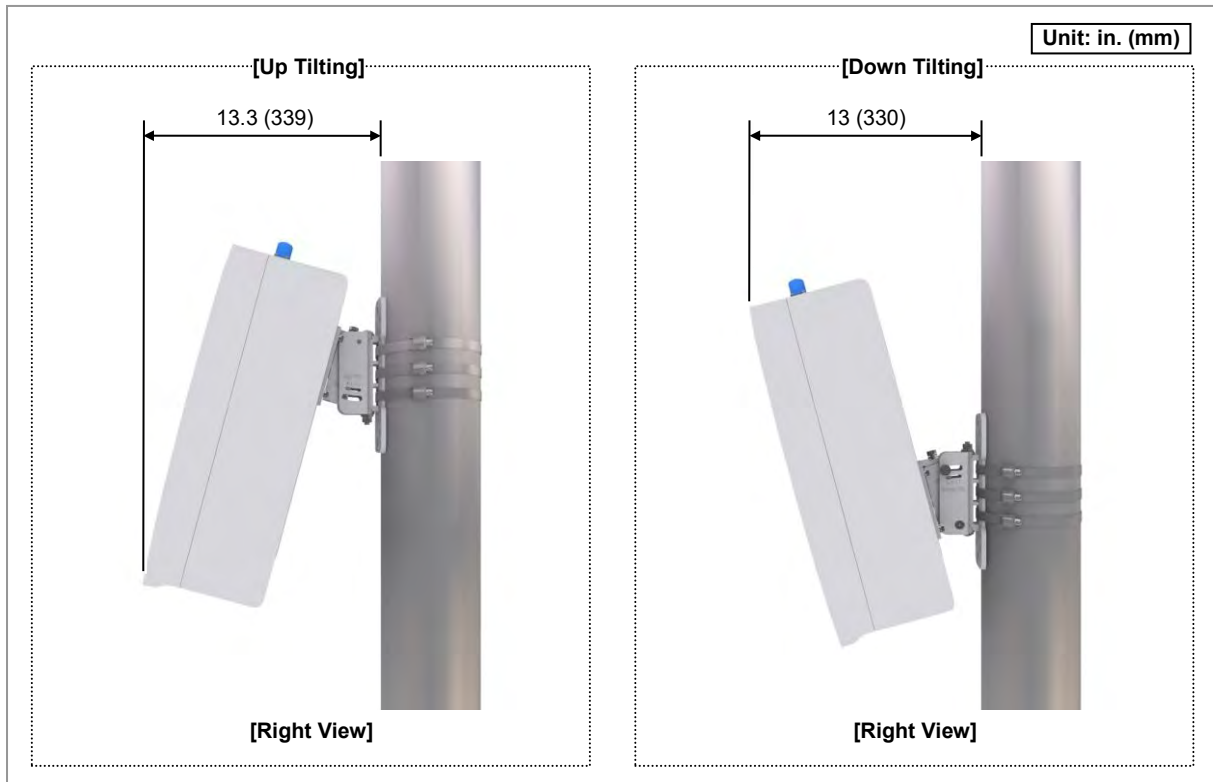

Figure 8. AU Arrangement_Pole Type Swiveling

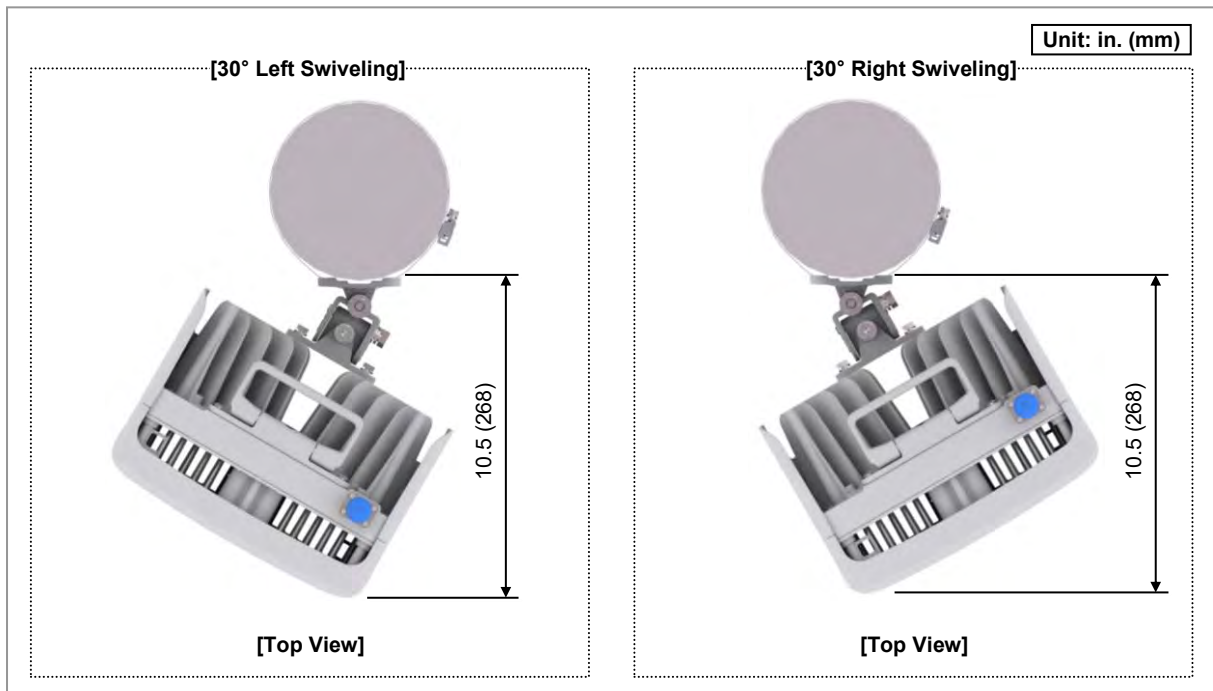

Figure 9. AU Arrangement_Wall Type Installation

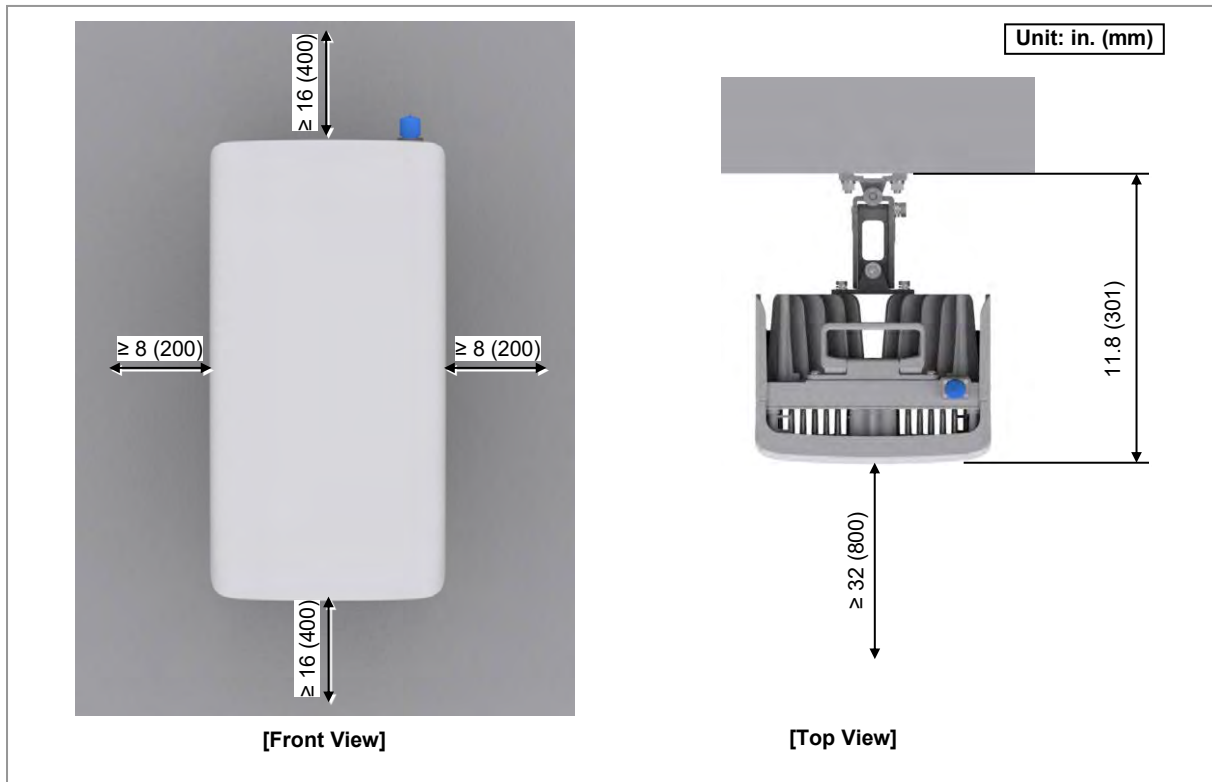

Figure 10. AU Arrangement_Wall Type Tilting

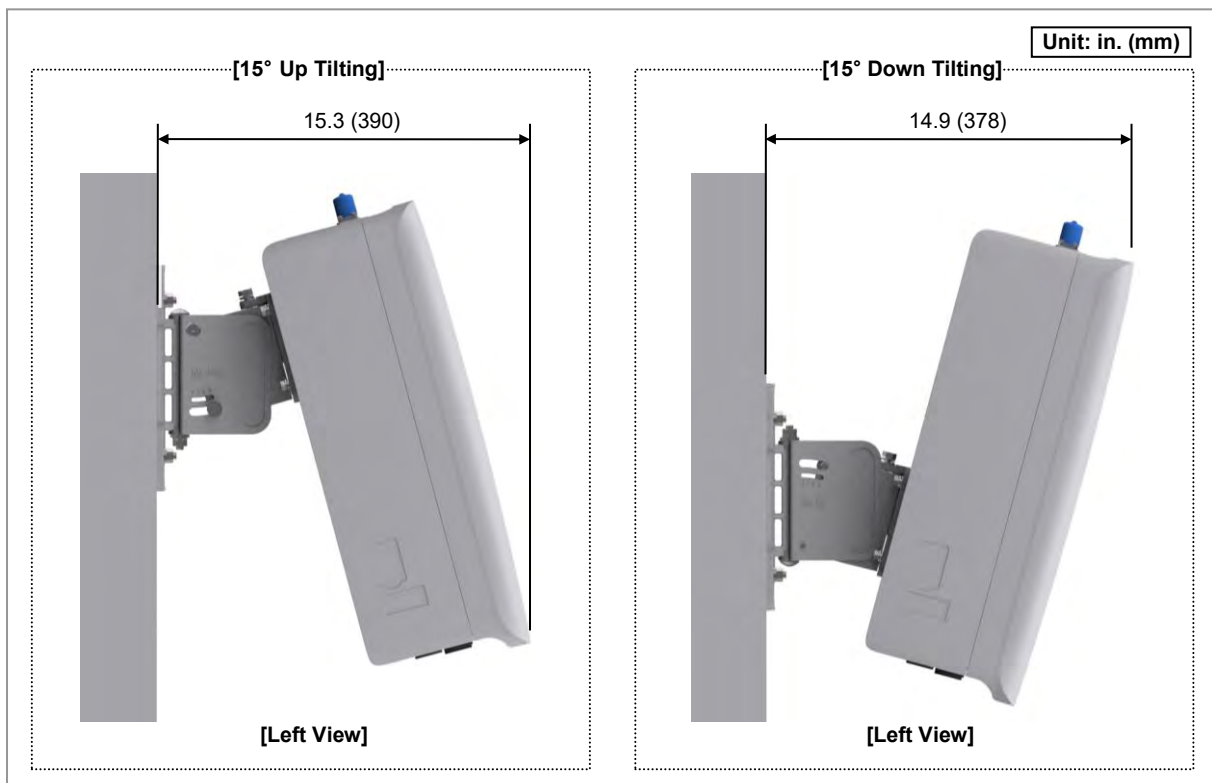
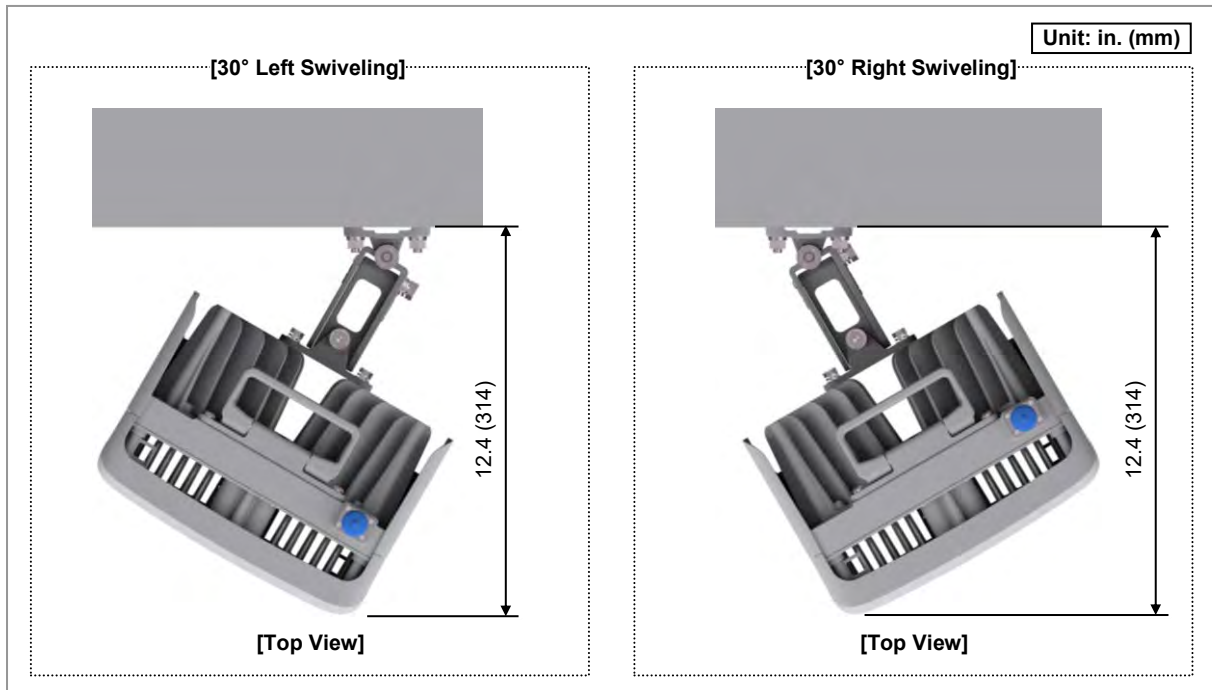

Figure 11. AU Arrangement_Wall Type Swiveling



Using No Tilting Bracket

The figures below depict the recommended distances for each direction of the AU without using the tilting bracket:

Figure 12. AU Arrangement_1 Sector Pole Type Installation

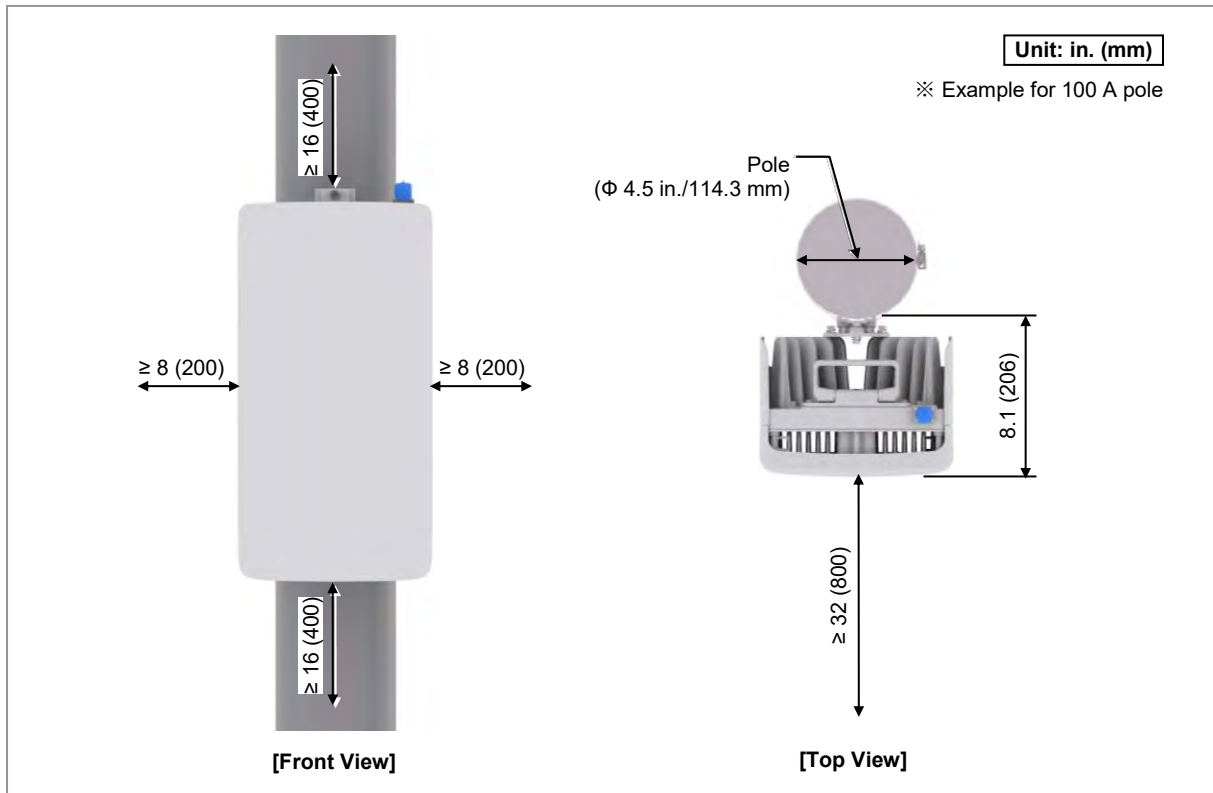

Figure 13. AU Arrangement_2 Sector Pole Type Installation

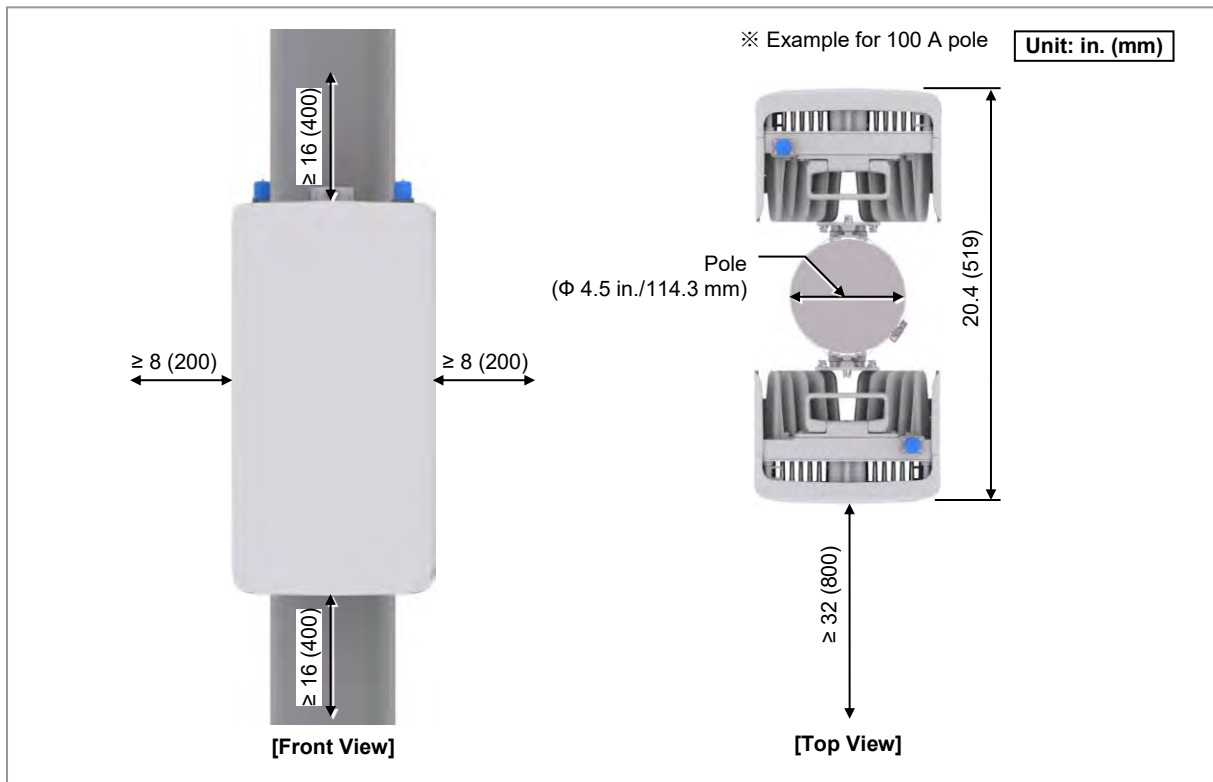
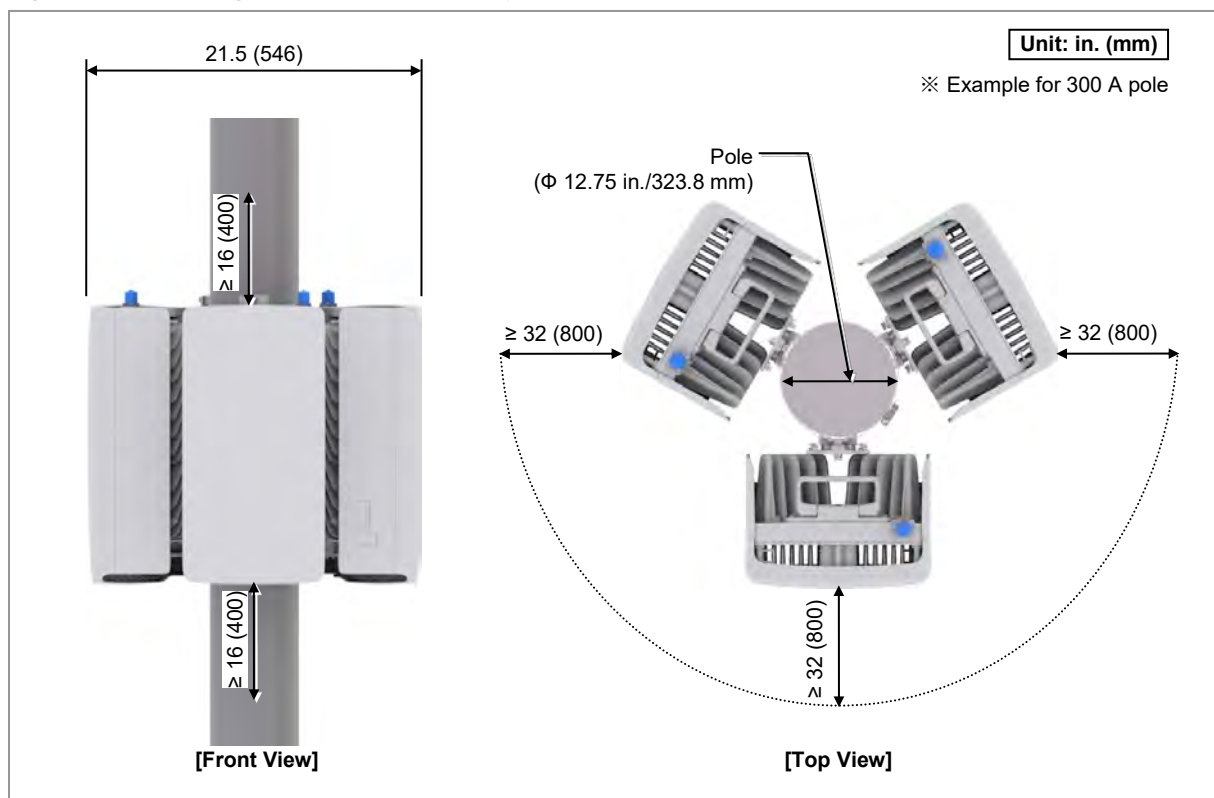

Figure 14. AU Arrangement_3 Sector Pole Type Installation



Transporting and Unpacking

This section describes how to transport the items to the installation place and provides the procedure to unpack cabinets and other components.

Bringing in Items

Ensure the following at each stage of transportation of the items:

- Before moving a system, check storage place for the system and remove obstacles in advance.
- When carrying the system:
 - Fasten the system firmly to the transport vehicle or carrier to prevent damage to the system from a vibration or shock.
 - Use an elevator to prevent accidents. However, if the system must be carried by people, ensure there are enough people to carry the system.
- The system must not be shocked physically.
- The system should be protected from dust, moisture, and static electricity.

Unpacking

To unpack the items, ensure the following:

- The items must be packed until they reach the installation place.
- The items are classified in accordance with each job specification and stored at a place that does not interfere with working.
- Unpacked systems must be installed immediately. If immediate installation of the systems is not planned, the systems must be stored in the installation place temporarily.
- Unpack only external packing, leaving the internal packing in unpacked status.
- Unpack the inner packaging after each system is placed on its installation location.
- Dispose by-products (packaging waste) in accordance with waste management rules. Do not recycle the by-products.

AU Handling

When transporting the AU, hold the handle at the side of the AU (no tool is needed for holding the handle.). After finishing the AU fixation, turn the handle back.

The figure below depicts the position and direction of movement of the handle:

Figure 15. Using a Handle to transport an AU

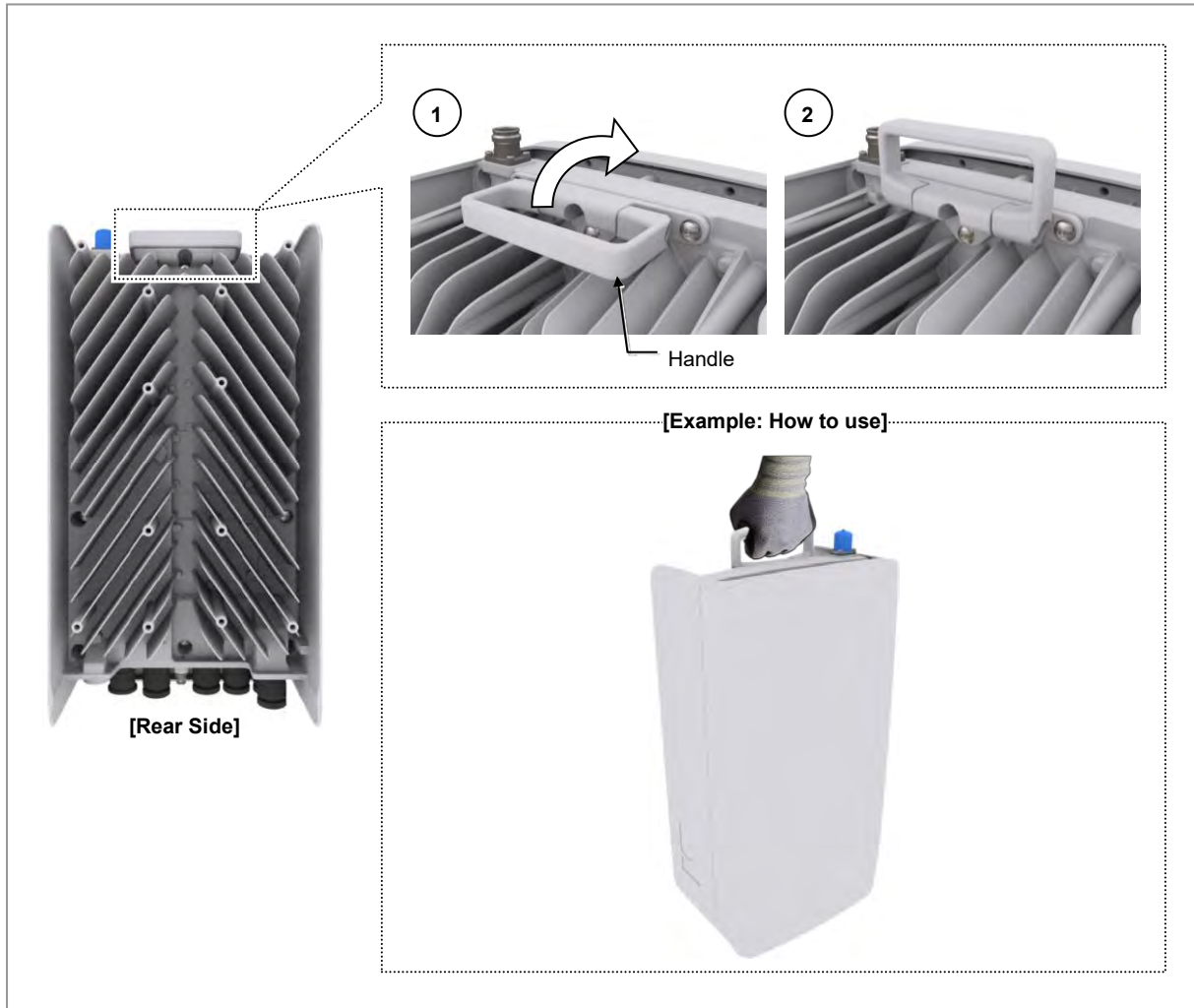

Fixing AU

This section describes the procedures to fix the AU by different methods.

Using Tilting and Swiveling Bracket

This section describes the procedure to fix the unit bracket using the tilting and swiveling bracket.

Fixing Unit Bracket



These instructions for mounting a unit bracket to the AU apply to all installation types.

To fix the unit bracket, do the following:

Prerequisites

Before proceeding with fixing the unit bracket, make sure that you have the items mentioned in the table below:

Table 3. Parts and Tools for Fixing Unit Bracket on AU

Category	Description	
Parts	Unit Bracket	1 EA/AU
	Fasteners	M6 × L20 Hex. bolt (Washer assembly) 4 EA/AU
Recommended Torque Value	M6 Hex. Bolt	43 lbf-in
Working Tools	<ul style="list-style-type: none"> • Torque Wrench (10 to 50 lbf-in) • Torque Wrench Spanner Head (apply Hex. head: 10 mm) • Spanner (apply Hex. head: 10 mm) 	

- 1 If the unit is installed with down tilting, the unit bracket should be fitted in the lower fixing hole at the rear of the equipment. If the unit is installed with up tilting, the unit bracket should be fitted in the top fixing hole at the rear of the equipment.

Figure 16. Fixing Unit Bracket (1)

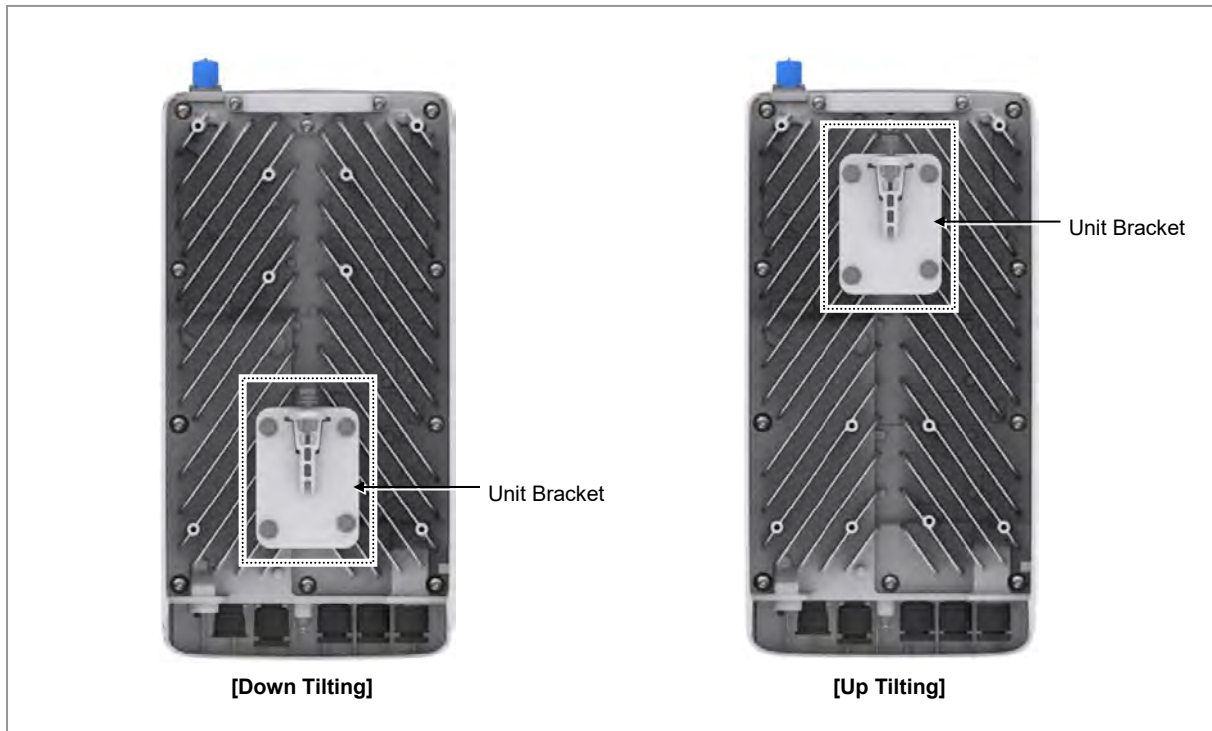

2 Fix the unit bracket using fasteners.



The attachment process is the same for both down and up tilting, but the attachment point for the unit bracket is different. This manual describes the attachment process for down tilting only.

Figure 17. Fixing Unit Bracket (2)

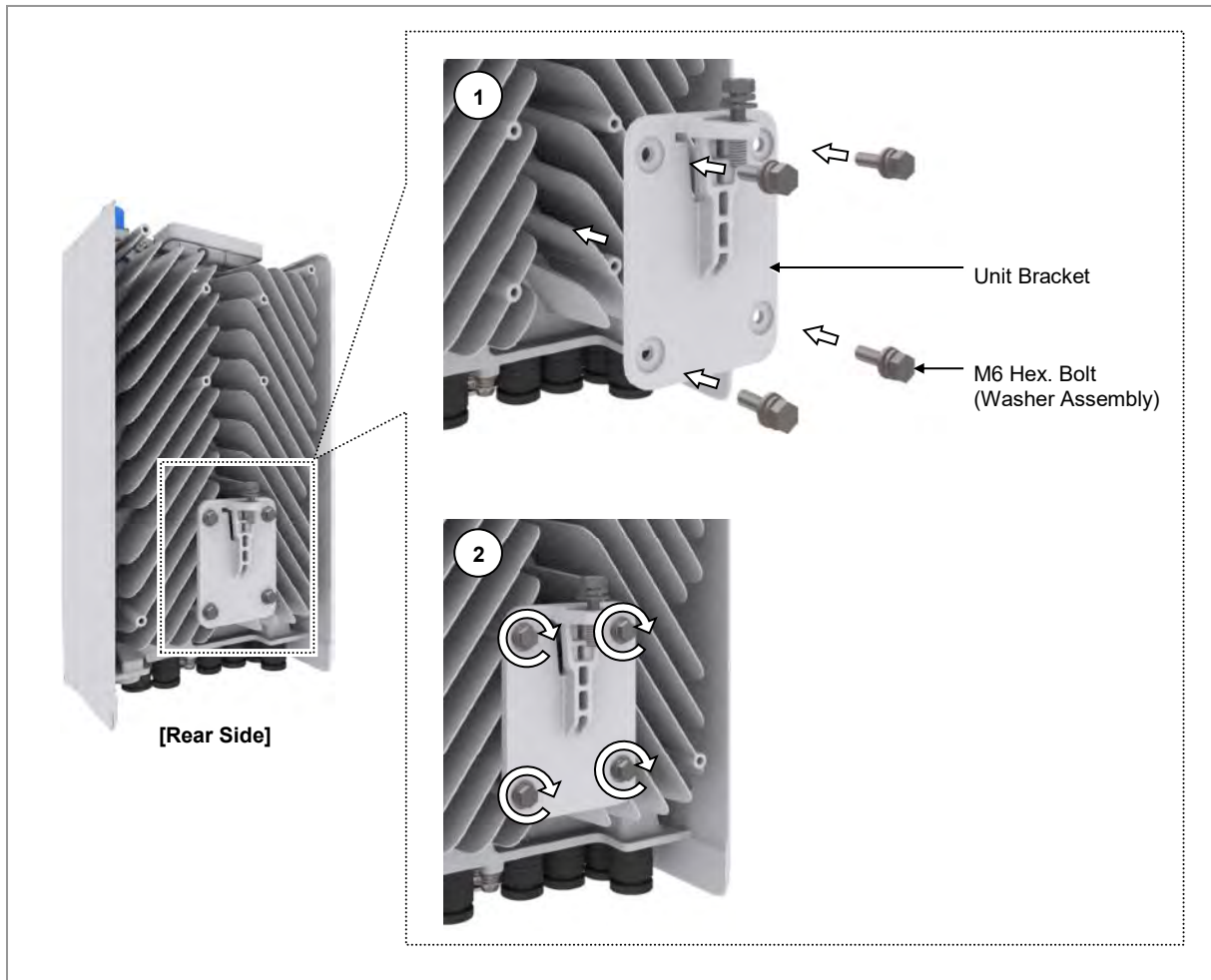

Fixing Pole Type

This section describes the procedures for fixing the system on the pole.



The standard of the pole on which the mounting bracket can be attached using steel bands is 50 A to 150 A. (When installing on a pole of 150 A, the steel band should be replaced.)



For installing three-sector AU, diameter of a pole must be 200 A or higher.

Fixing Mounting Bracket on the pole

To fix the mounting bracket on the pole, do the following:

Prerequisites

Before proceeding with assembling the mounting bracket, make sure that you have the items mentioned in the table below:

Table 4. Parts and Tools for Fixing Mounting Bracket on the Pole

Category	Description			
Parts	Mounting Bracket	1 Sector	1 EA	
		2 Sector	2 EA	
		3 Sector	3 EA	
	Fasteners	Steel Band	1 Sector or 2 Sector	2 EA
			3 Sector	3 EA
Recommended Torque Value	Steel Band Fixing Screw		48.5 lbf-in	
Working Tools	<ul style="list-style-type: none"> • Torque Driver (20 to 90 lbf-in) • Screw Driver Bit ('+', No. 3) • Antenna Alignment Tool 			

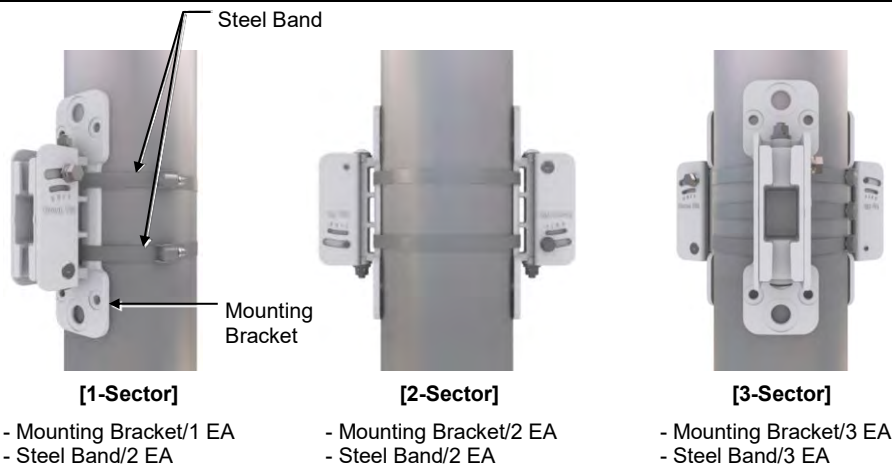

The process for attaching the one, two or three-sector mounting brackets to the pole is the same. (However, the number of mounting brackets and steel bands will differ depending on the sector.) This manual describes the installation process for attaching a one-sector bracket only.



The process for attaching the mounting bracket to the pole for down/up tilting is the same. (However, the upwards and downwards orientation of the mounting bracket will differ depending on whether the unit is tilted up or down.) This manual describes the installation process for down tilting only.

- 1 The upwards and downwards orientation of the mounting bracket will differ depending on whether the unit is installed with up tilting or down tilting, and the direction of tilting for installation should be indicated on the right-hand side of the mounting bracket.

Figure 18. Fixing Mounting Bracket on the Pole (1)

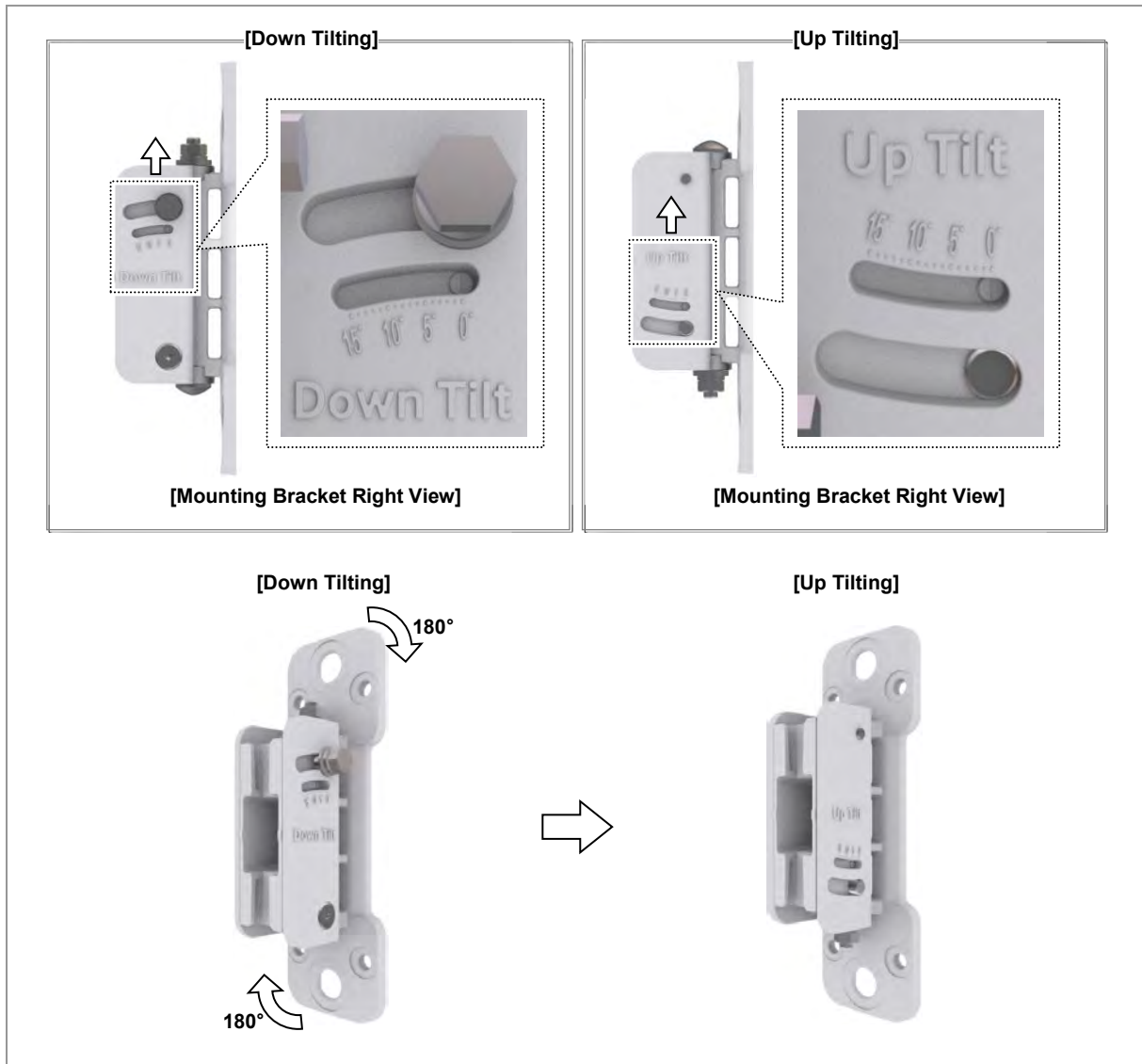

2 Pass the steel band through the fixing hole of the mounting bracket.

Figure 19. Fixing Mounting Bracket on the Pole (2)

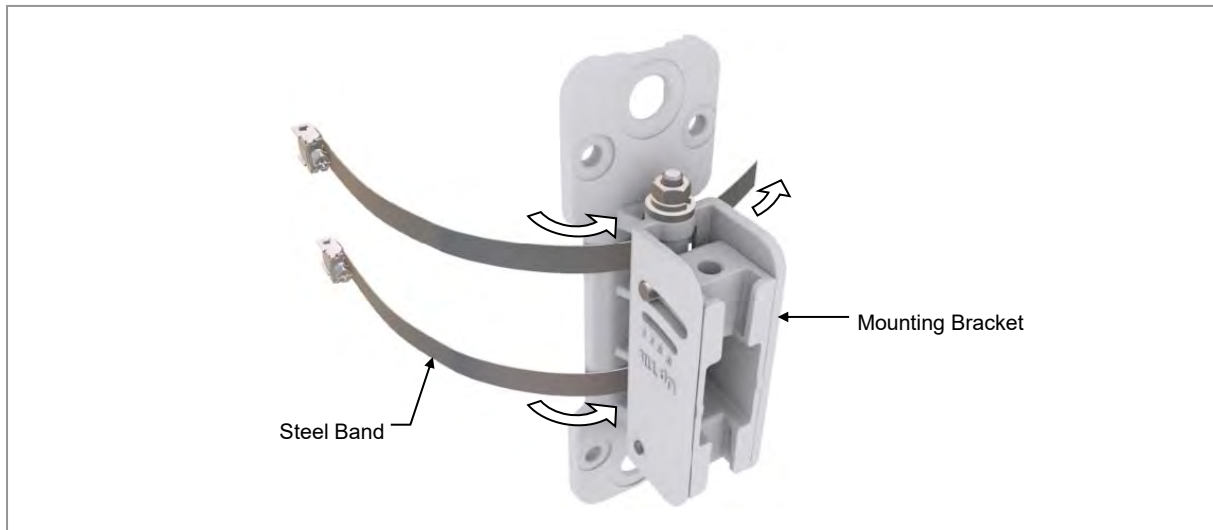

The mounting bracket and steel band assembly for the installation of a two or three-sector bracket are shown in the figure below.



[2-Sector]



[3-Sector]

- 3 Use antenna alignment tool to determine the azimuth of the AU to be installed on the pole.

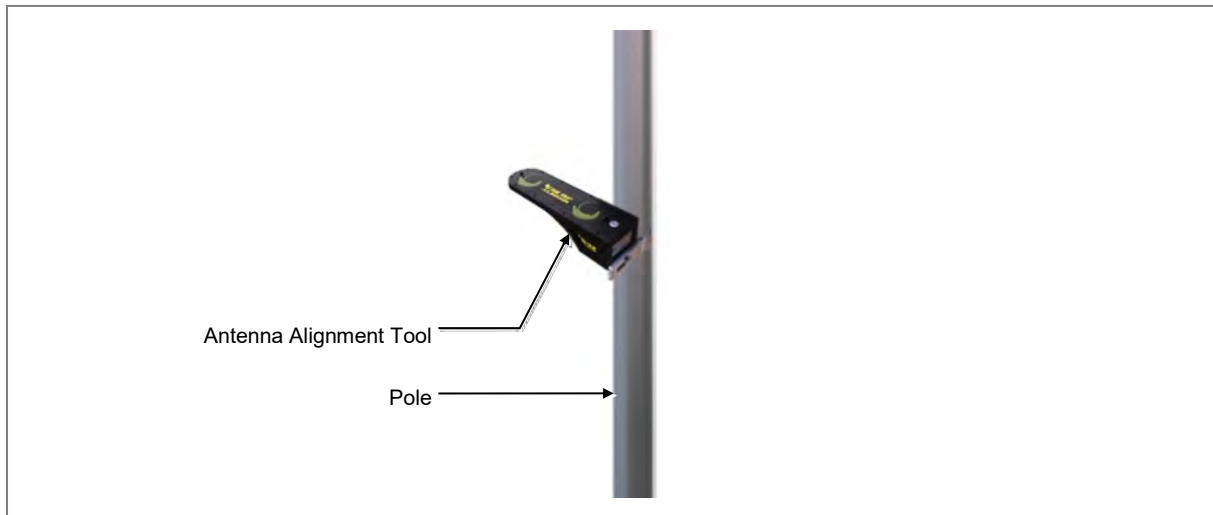
Figure 20. Fixing Mounting Bracket on the Pole (3)

- 4** Place a mounting bracket to the pole.

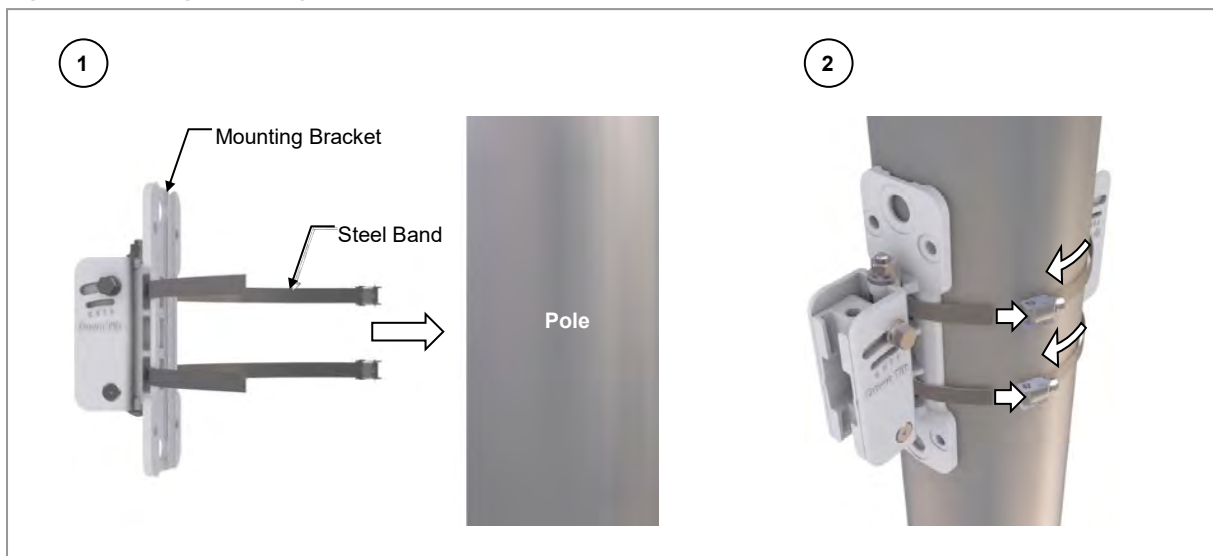
Figure 21. Fixing Mounting Bracket on the Pole (4)

- 5** Fix the mounting bracket to the pole using the steel band.

Figure 22. Fixing Mounting Bracket on the Pole (5)

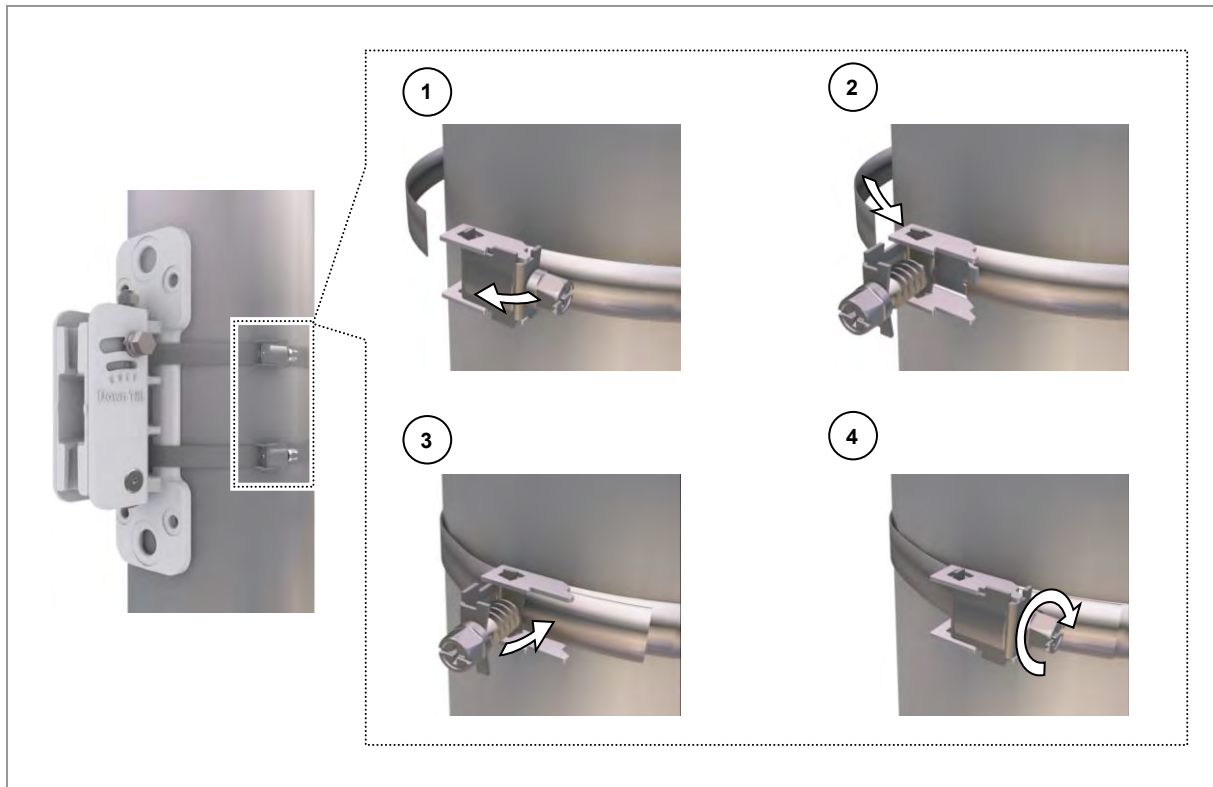

The mounting bracket fixing for the installation of a two or three-sector bracket is shown in the figure below.



[2-Sector]





[3-Sector]

- 6 Check the level of mounting bracket on the pole and adjust the level.

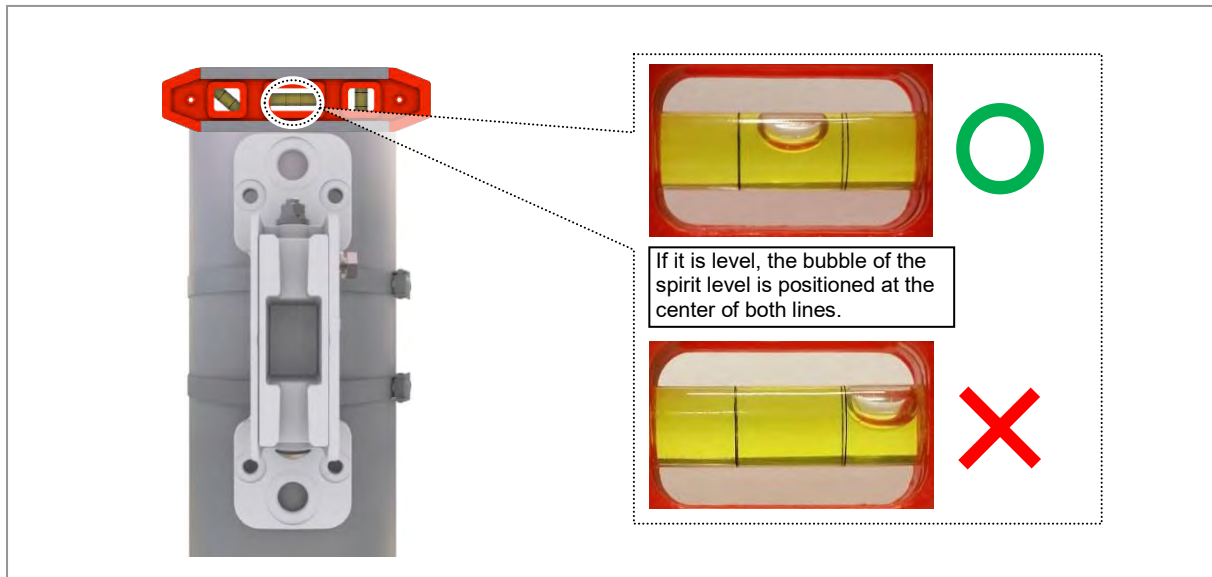
Figure 23. Fixing Mounting Bracket on the Pole (6)



-  When fixing the mounting bracket on the pole, be sure to check the level of bracket. After finishing the installation, adjust the level minutely.
-  When poor leveling happens, adjust the position of fasteners used to fix the mounting bracket.
-  After fixing the steel band, push the remainder of band inside the mounting bracket

Lifting AU

To lift the AU, do the following:

- 1 Lifting with a cherry picker.

Figure 24. Lifting AU

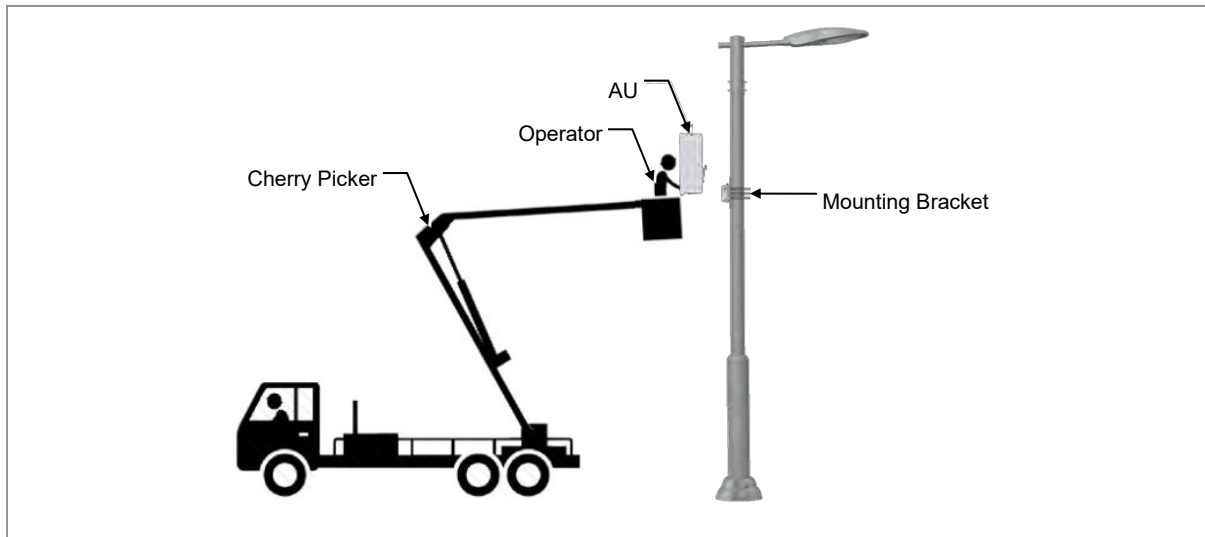

Fixing AU on the Pole

To fix the AU on the pole, do the following:

Prerequisites

Before proceeding with fixing the AU on the pole, make sure that you have the items mentioned in the table below:

Table 5. Parts and Tools for Fixing AU on the Pole

Category	Description	
Recommended Torque Value	M8 Hex. Bolt	110 lbf-in
Working Tools	<ul style="list-style-type: none"> • Torque Wrench (100 to 400 lbf-in) • Torque Wrench Spanner Head (apply Hex. head: 13 mm) • Antenna Alignment Tool 	

- 1 Place the unit bracket on the fixing groove of the mounting bracket.
- 2 Fix the AU using fasters.

Figure 25. Fixing AU on the Pole (1)

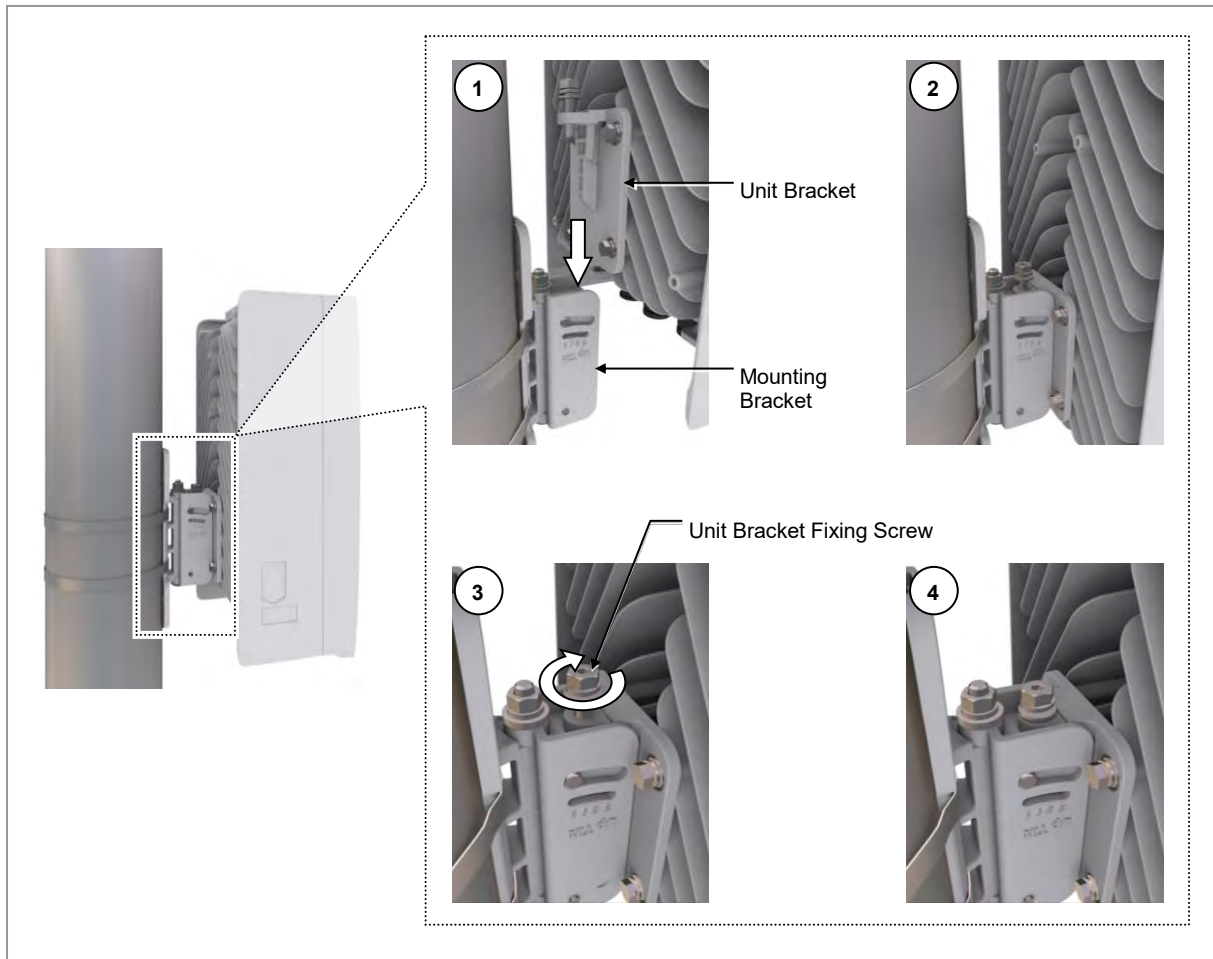

When installing the AU, the tilting angle pointer of the unit bracket should point to 0°.



Tilting angle scale of the unit bracket

[Angle pointer position for unit bracket with 0° tilt when installing the AU]

- 3 Use the antenna alignment tool to check the azimuth of the front of the AU.

Figure 26. Fixing AU on the Pole (2)

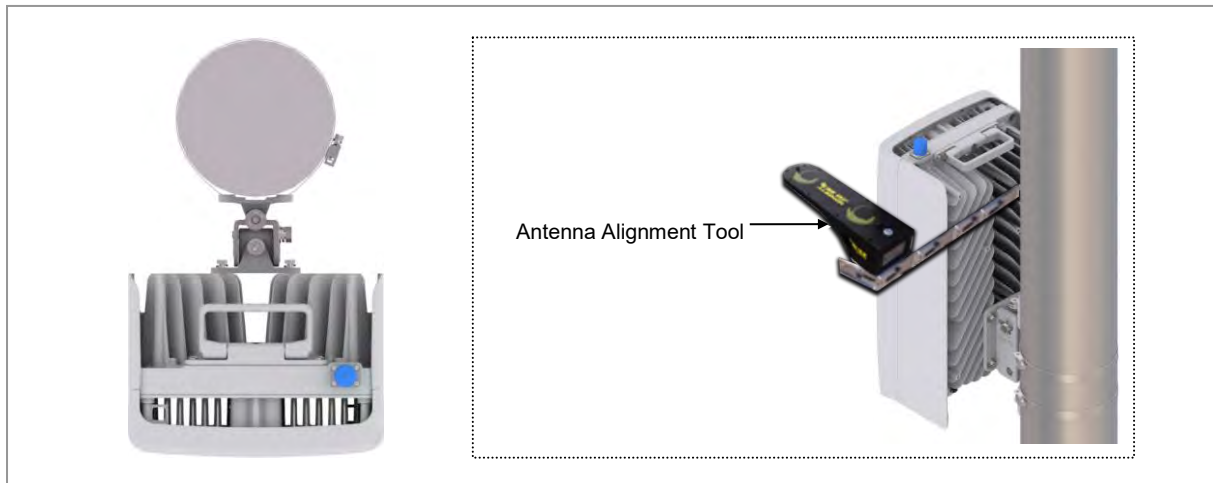

The AU fixing for the installation of a two or three-sector bracket is shown in the figure below.

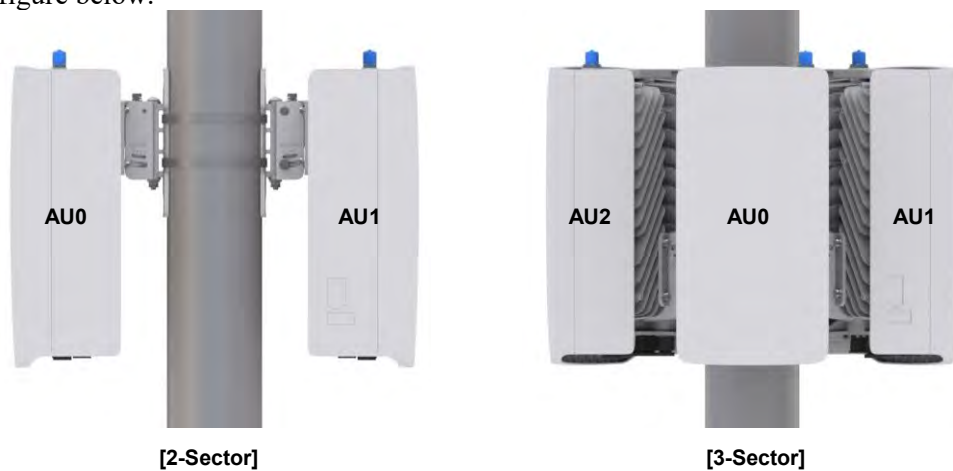

Fixing Wall Type

This section describes the procedures for fixing the system on the wall.

Fixing Mounting Bracket on the wall

To fix the mounting bracket on the wall, do the following:

Prerequisites

Before proceeding with fixing the mounting bracket for 1-sector on the wall, make sure that you have the items mentioned in the table below:

Table 6. Tools for Marking

Category	Description
Working Tools	<ul style="list-style-type: none"> • Tape Measure • Permanent Maker • Level



To mount the system on a wall, perform the leveling test by referring to the System Leveling to check the positions are marked to be horizontal or vertical before drilling. If the result shows they are not horizontal or vertical, modify the marking positions.



When the position where the system will be placed is determined, place the system on that position and then mark the positions where anchor bolts will be fixed. This will reduce marking error range.

- 1** Check the distance between the location for fixing the AU and the anchor bolt hole.

Figure 27. AU Marking Dimensions

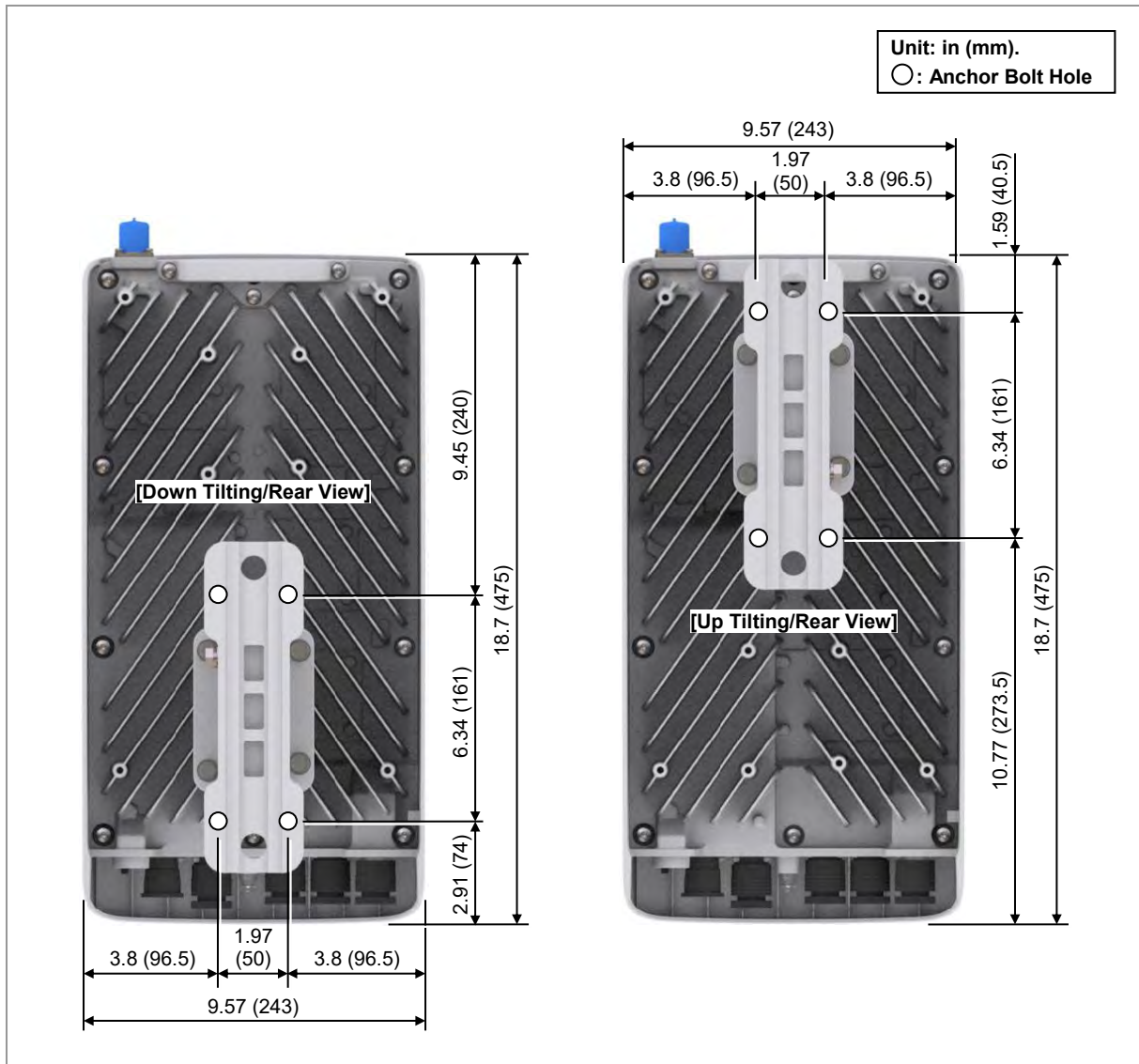

- 2 Place a mounting bracket on the fixing location, and then check the level status using a level and adjust the level of bracket assembly.
- 3 If the level status is normal, mark the anchor bolt holes on a wall.

Figure 28. Marking

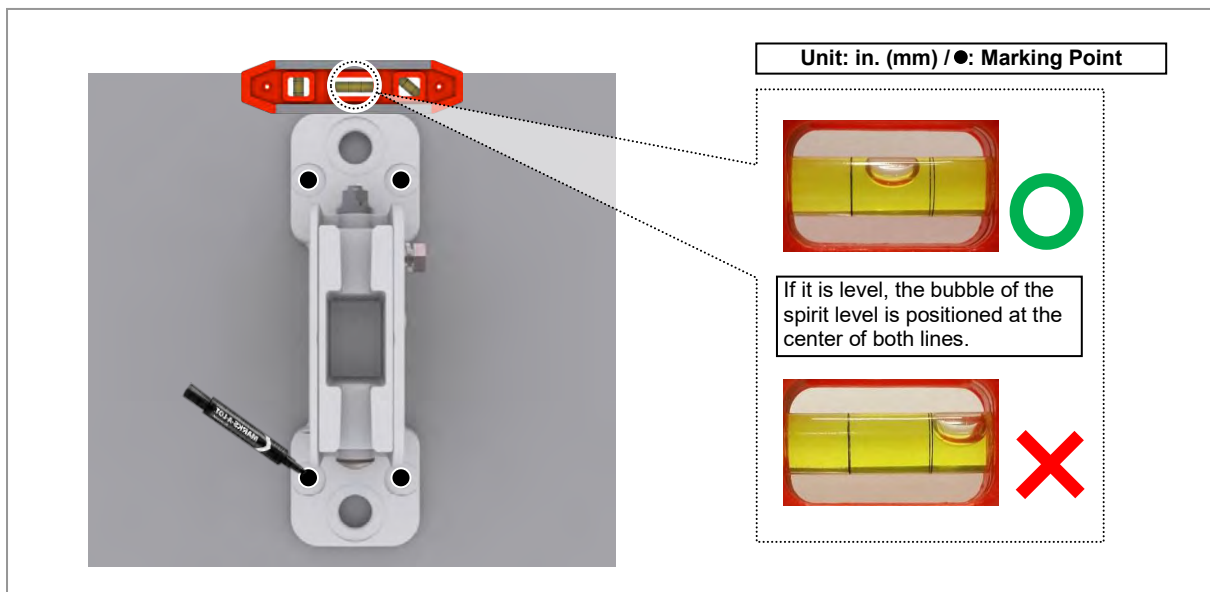

4 To drill an anchor hole, do the following:

Prerequisites

Before proceeding with the drilling process, make sure that you have items mentioned in the following table

Table 7. Parts and Tools for Drilling

Category	Description
Working Tools	<ul style="list-style-type: none"> • Hammer Drill • Concrete Drill Bit (12 mm) • Vacuum Cleaner

Table 8. Anchor Bolt Drill Bits and Hole Depth

Category	Anchor Bolt	Drill Bits	Hole Depth
AU (Wall Type)	M8	12 mm	38 mm

[Anchor Hole Cross Section]



* Remove the debris from the drilled hole.

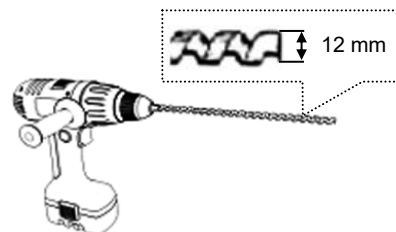

- 1 Drill the anchor holes at the marked points.
- 2 Remove dust from the holes using a vacuum cleaner.

Figure 29. Drilling

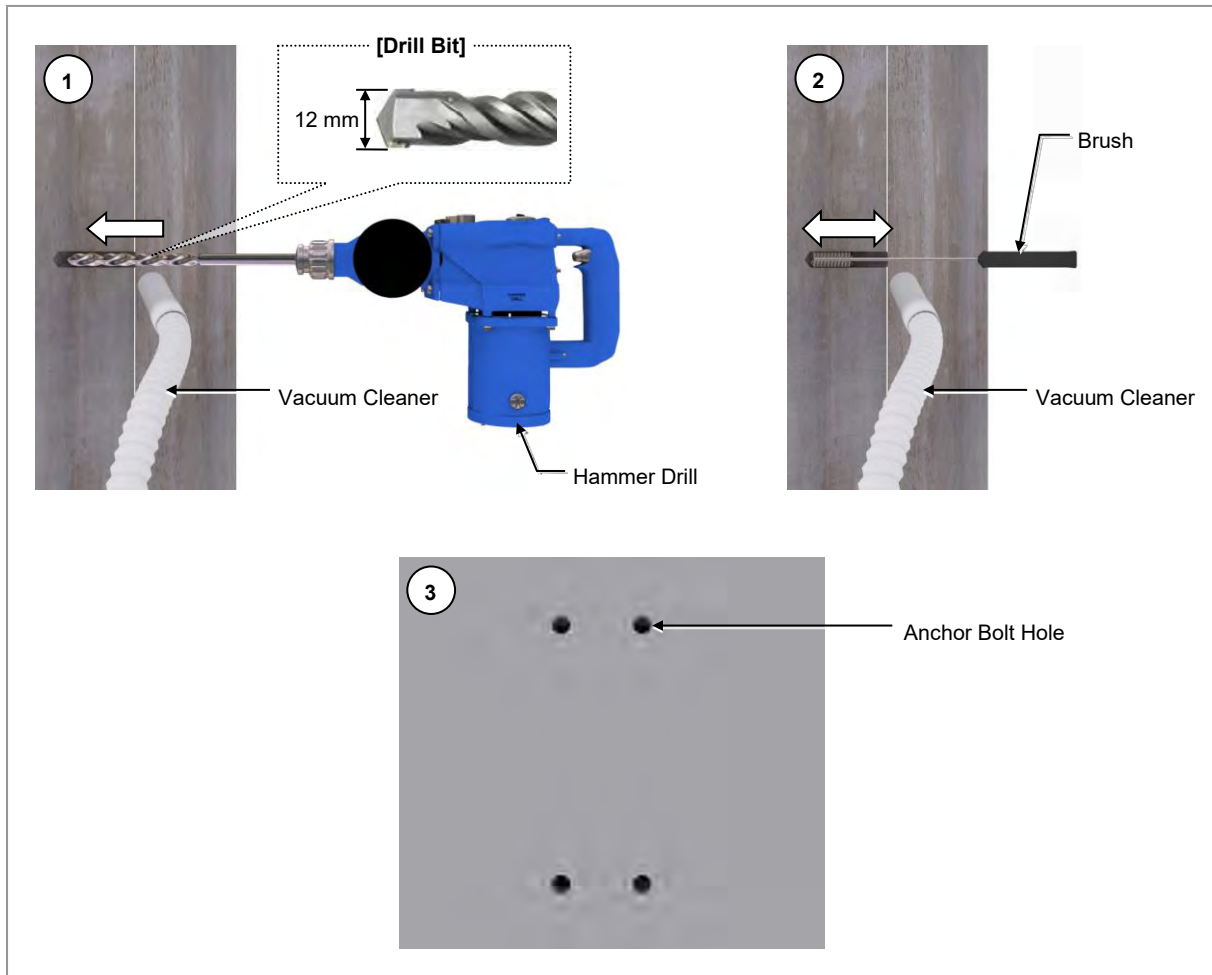

Fixing Mounting Bracket on the Wall

To fix the mounting bracket on the wall, do the following:

Prerequisites

Before proceeding with fixing the mounting bracket on the wall, ensure that you have the items mentioned in the table below:

Table 9. Parts and Tools for Fixing Mounting Bracket on the Wall

Category	Description	
Parts	Mounting Bracket	1 EA
	Fasteners	M8 × L60 Set Anchor Assembly • M8 × L60 Set Anchor • M8 Plain Washer • M8 Spring Washer • M8 Hex. Nut
Recommended Torque Value	M8 Hex. Nut	110 lbf-in
Working Tools	• Torque Wrench (100 to 400 lbf-in) • Torque Wrench Spanner head (apply Hex. head: 13 mm)	

Category	Description
	<ul style="list-style-type: none"> • Spanner (13 mm) • Hammer • Anchor Punch (for M8 set anchor bolt)

1 Fix the anchor to the drilled hole.

Figure 30. Fixing Mounting Bracket on the Wall (1)

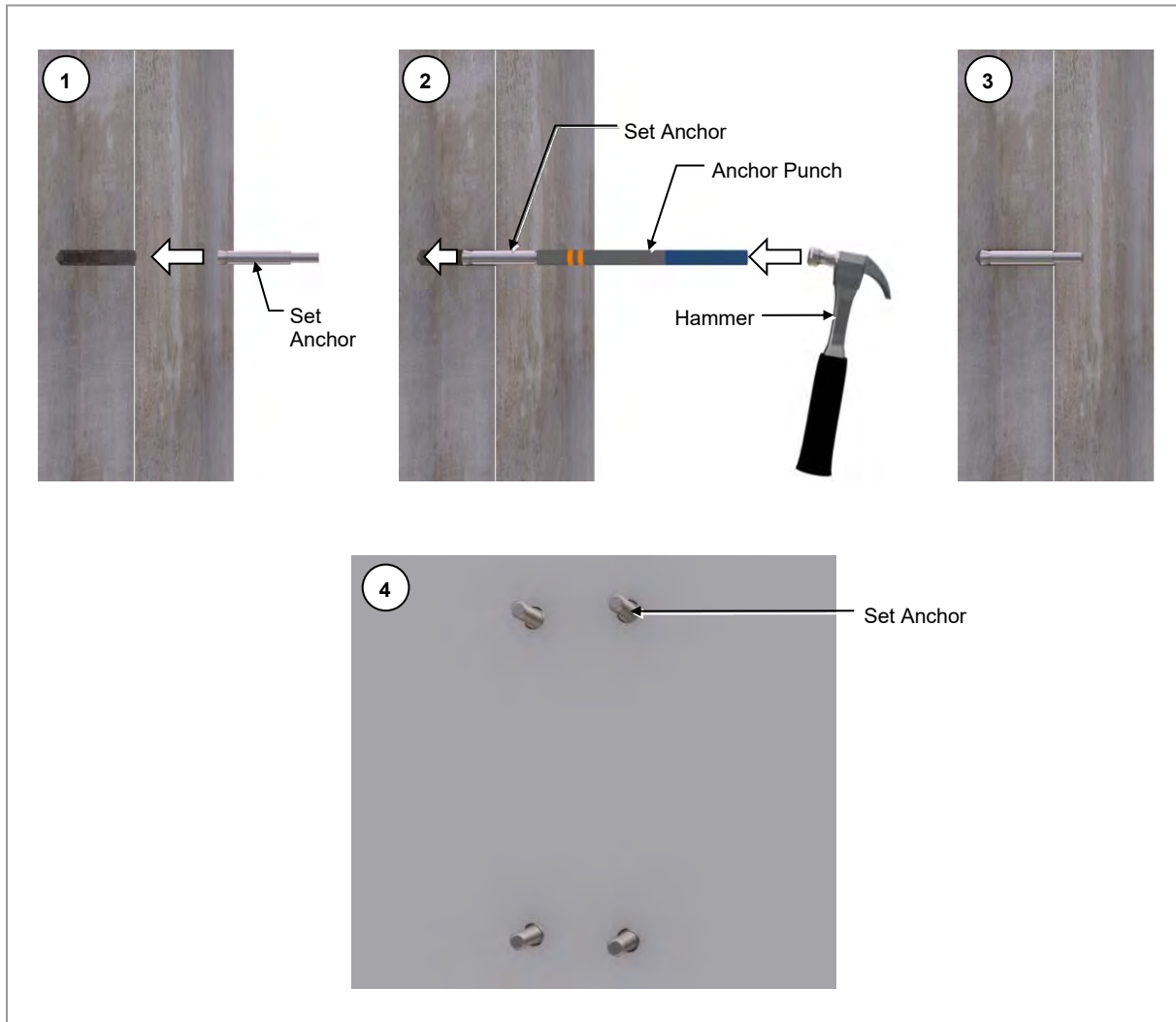

2 Place the mounting bracket on the wall and fix it using fasteners.

Figure 31. Fixing Mounting Bracket on the Wall (2)

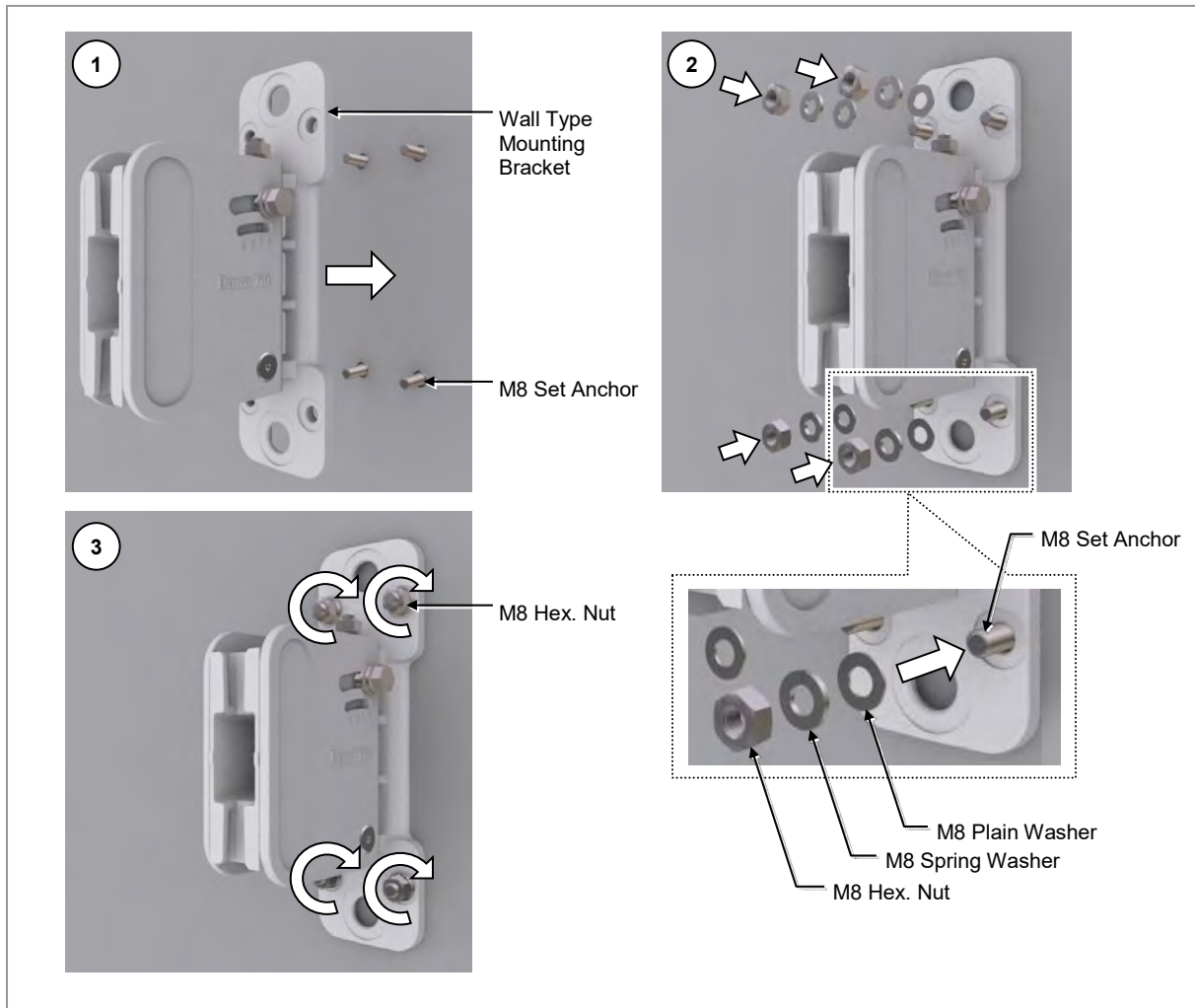

Fixing AU on the Wall

To fix the AU on the wall, do the following:

Prerequisites

Before proceeding with fixing the AU on the wall, ensure that you have the items mentioned in the table below:

Table 10. Parts and Tools for Fixing AU on the Wall

Category	Description	
Recommended Torque Value	M6 Hex. bolt	43 lbf-in
Working Tools	<ul style="list-style-type: none"> • Torque Wrench (10 to 50 lbf-in) • Torque Wrench Spanner Head (apply Hex. head: 10 mm) 	

- 1 Place the unit bracket on the fixing groove of the mounting bracket.
- 2 Fix the AU using the fasteners.

Figure 32. Fixing AU on the Wall

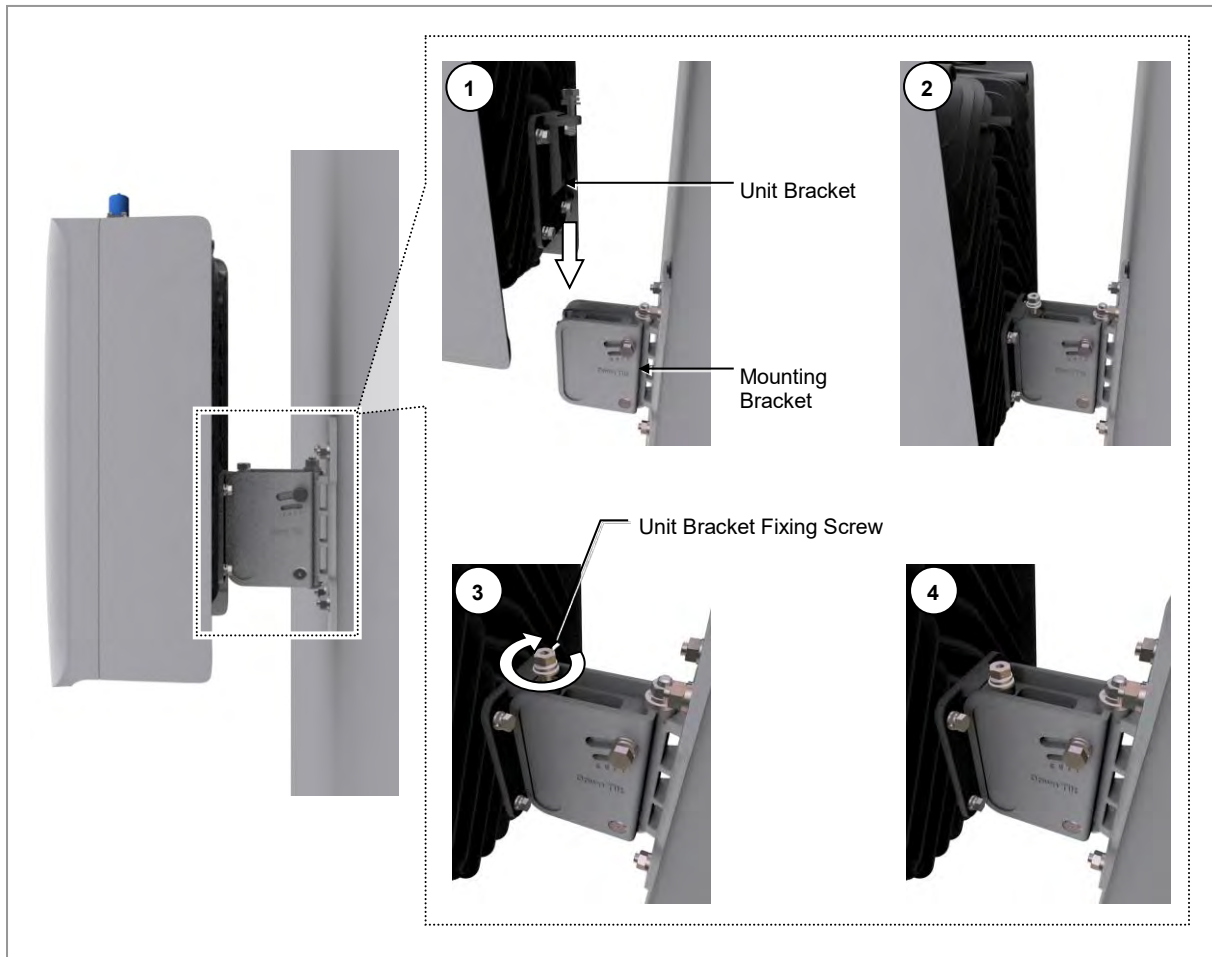

Tilting



The instructions for tilting the AU apply to all installation types.



The adjustable tilting range is as follows:

- Up tilting: 0° to 15°
- Down tilting: 0° to 15°

To adjust the AU tilting, do the following:

Prerequisites

Before proceeding with adjusting the AU tilting, make sure that you have the items mentioned in the table below:

Table 11. Tools for Tilting AU

Category	Description	
Recommended Torque Value	M8 Hex. bolt	110 lbf-in
Working Tools	• Torque Wrench (100 to 400 lbf-in)	

Category	Description
	<ul style="list-style-type: none">• Torque Wrench Spanner Head (apply Hex. head: 13 mm)• Spanner (13 mm)

- 1 Loosen the AU by turning M8 Hex. bolt of mounting bracket two or three times counter clockwise.
Do not separate it completely.

Figure 33. AU Tilting Adjustment (1)

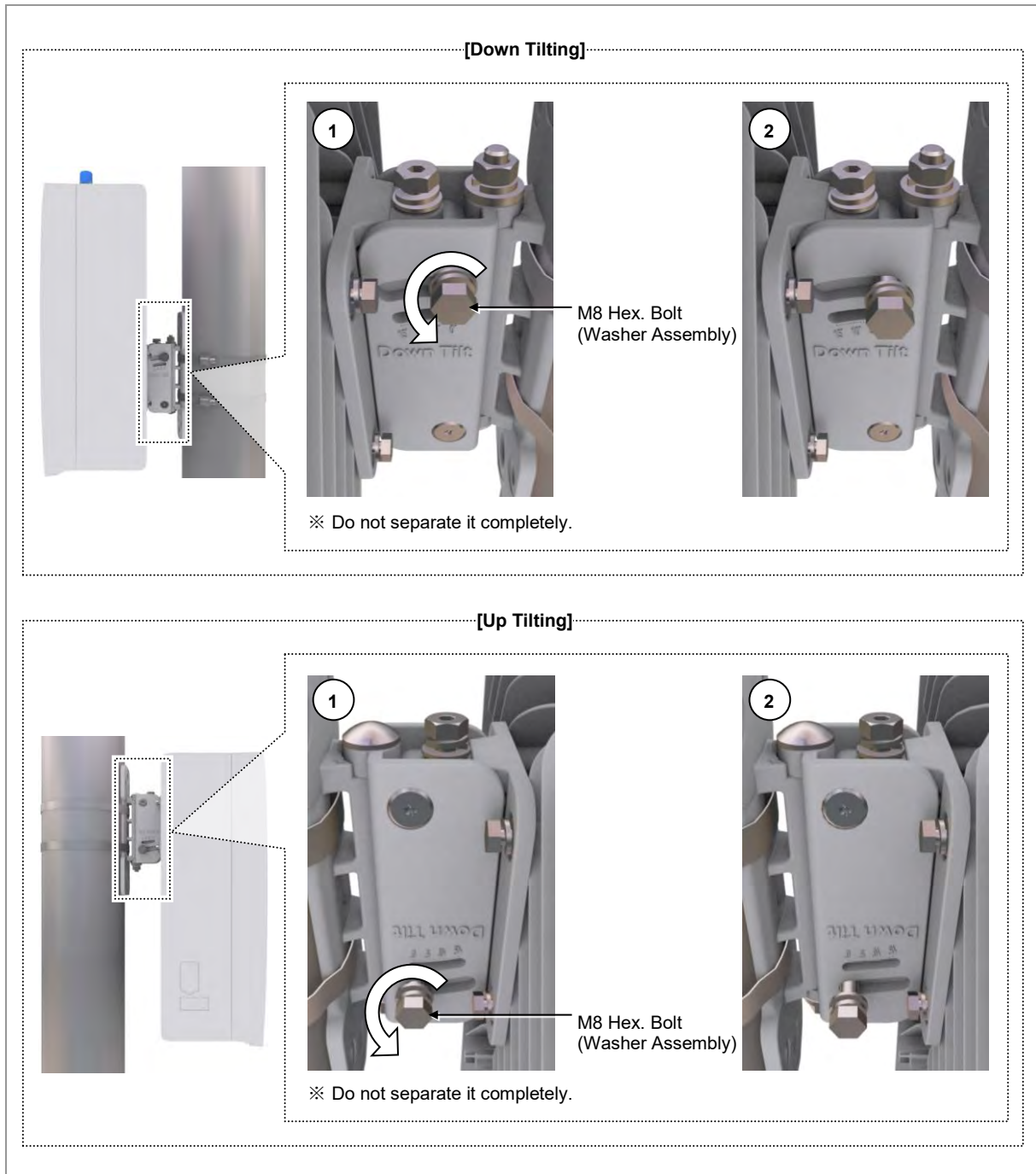

2 Pull the AU up/down to adjust the tilting angle.

Figure 34. AU Tilting Adjustment (2)

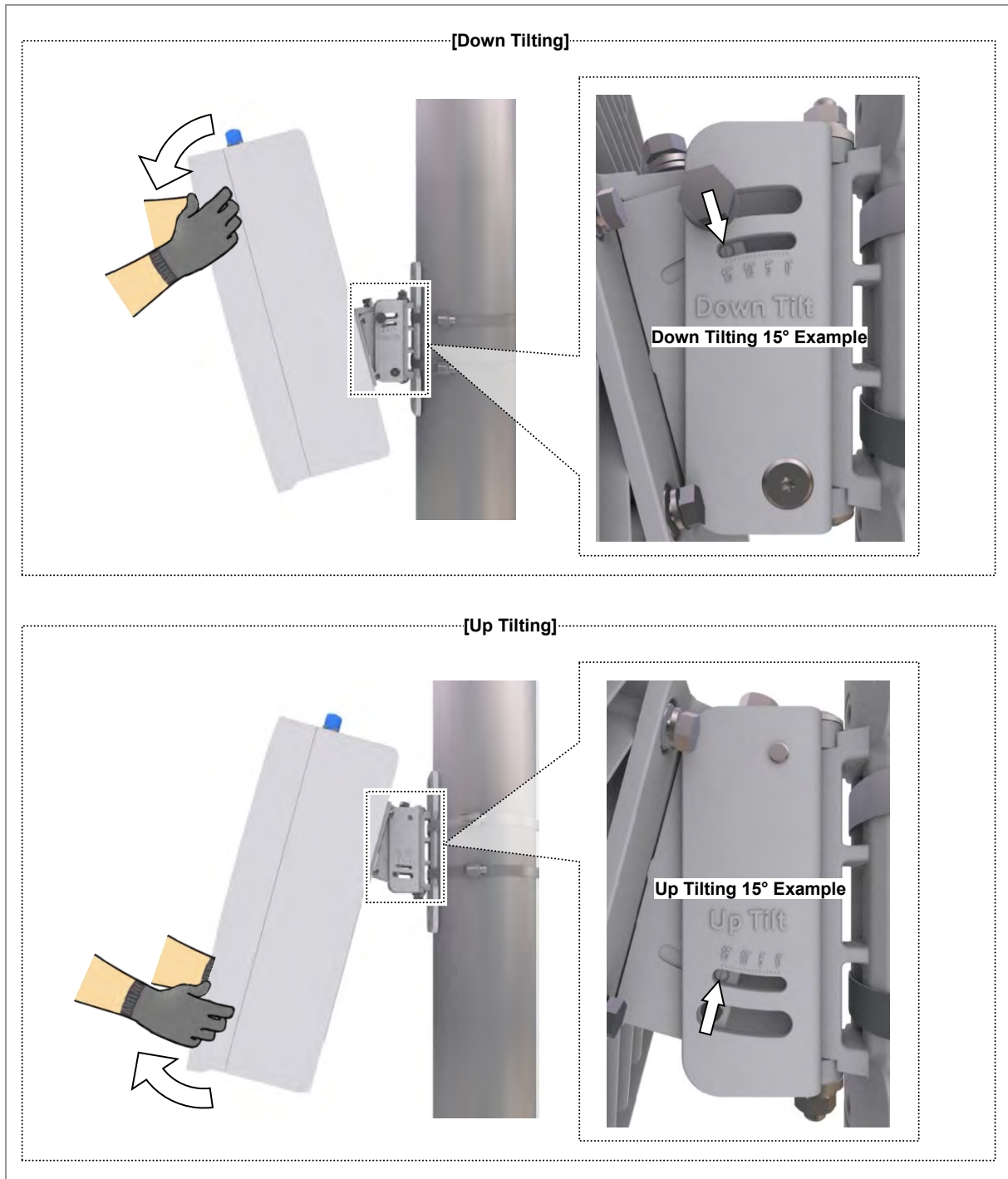

3 Fix the AU using the working tools.

Figure 35. AU Tilting Adjustment (3)

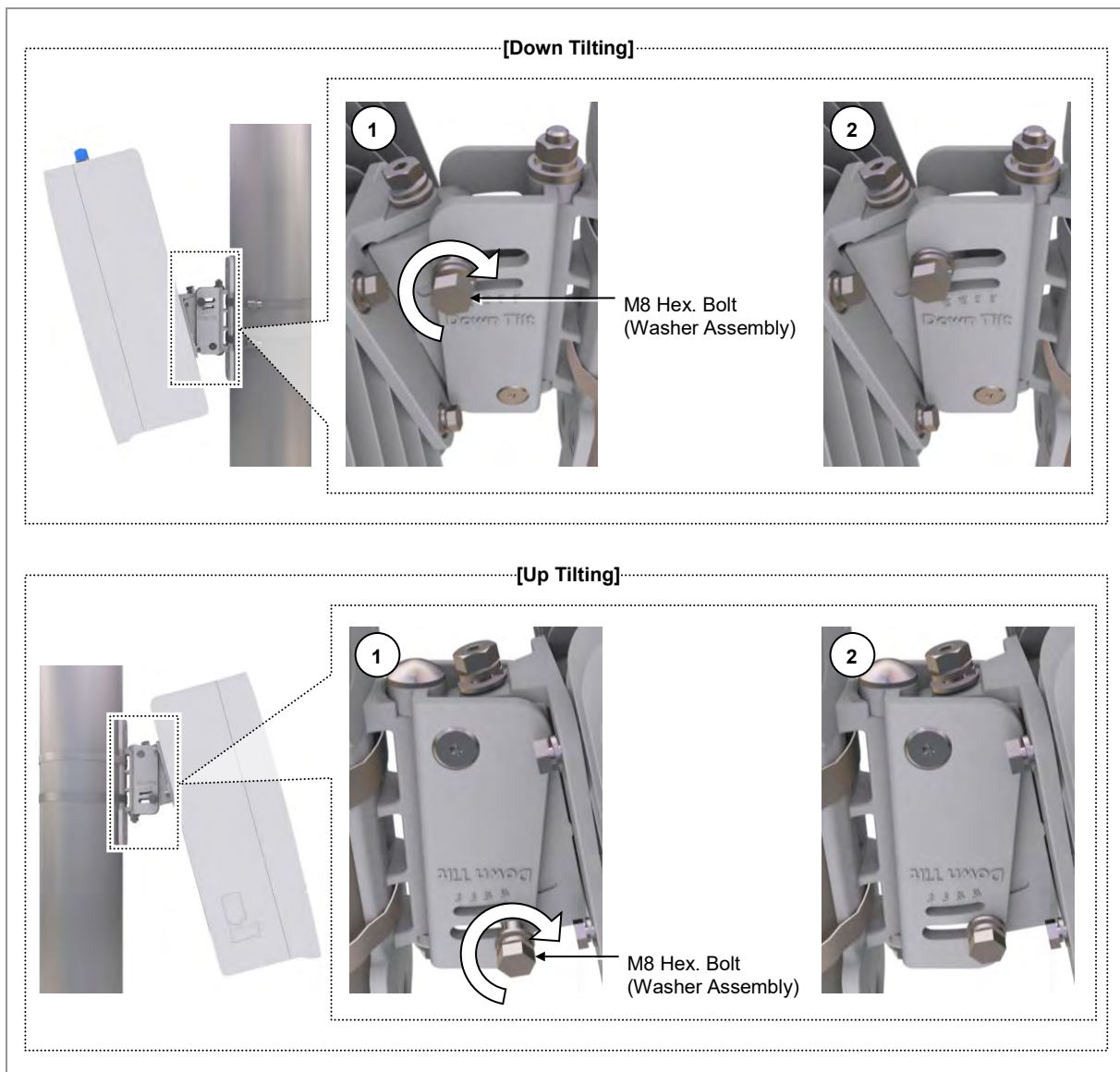

Swiveling



The instructions for swiveling the AU apply to all installation types.



The adjustable swiveling is as follows:

- Left Swiveling: 0° to 30°
- Right Swiveling: 0° to 30°

To adjust the AU swiveling, do the following

Prerequisites

Before proceeding with swiveling the AU, make sure that you have the items mentioned in the table below:

Table 12. Tools for Swiveling AU

Category	Description	
Recommended Torque Value	M8 Hex. Nut	110 lbf-in
Working Tools	<ul style="list-style-type: none"> • Torque Wrench (100 to 400 lbf-in) • Torque Wrench Spanner Head (apply Hex. head: 13 mm) • Spanner (13 mm) 	

- 1 Loosen the AU by turning M8 Hex. nut of mounting bracket two or three times counter clockwise.
Do not separate it completely.

Figure 36. AU Swiveling Adjustment (1)

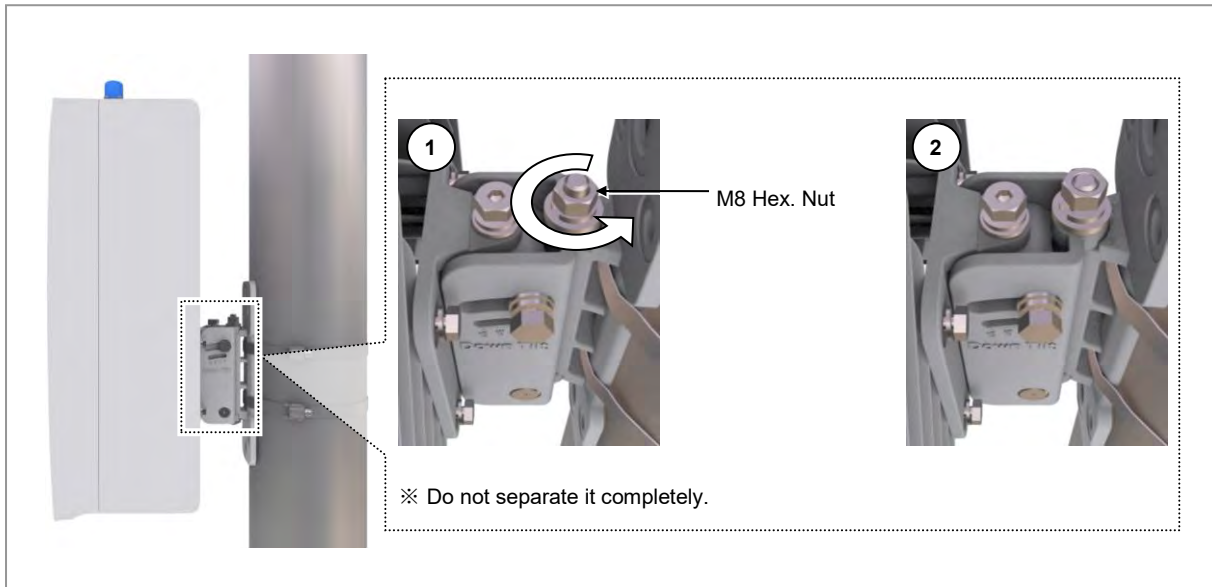

- 2 Pull the AU left/right to adjust the swiveling angle.

Figure 37. AU Swiveling Adjustment (2)

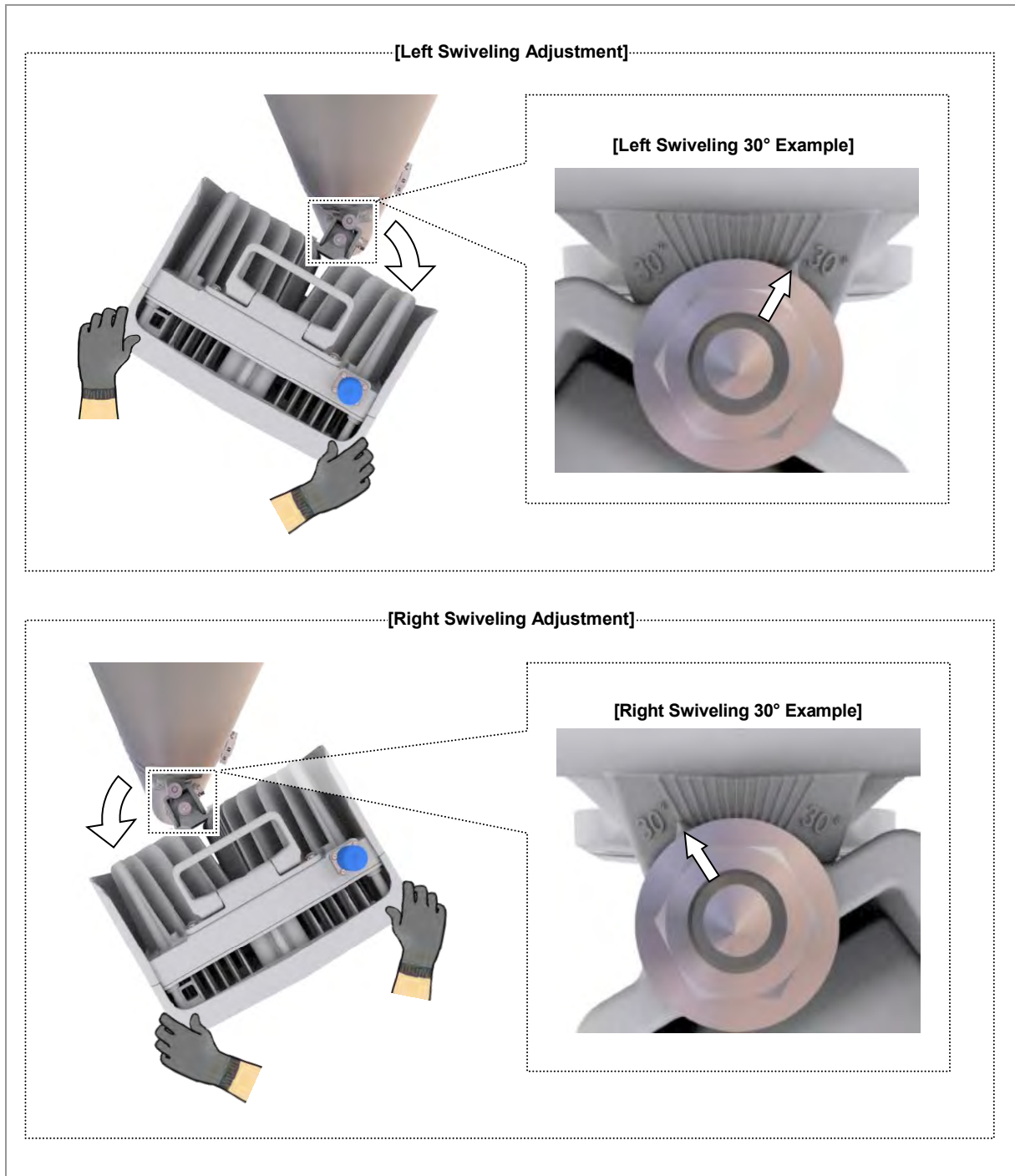

3 Fix the AU using working tools.

Figure 38. AU Swiveling Adjustment (3)

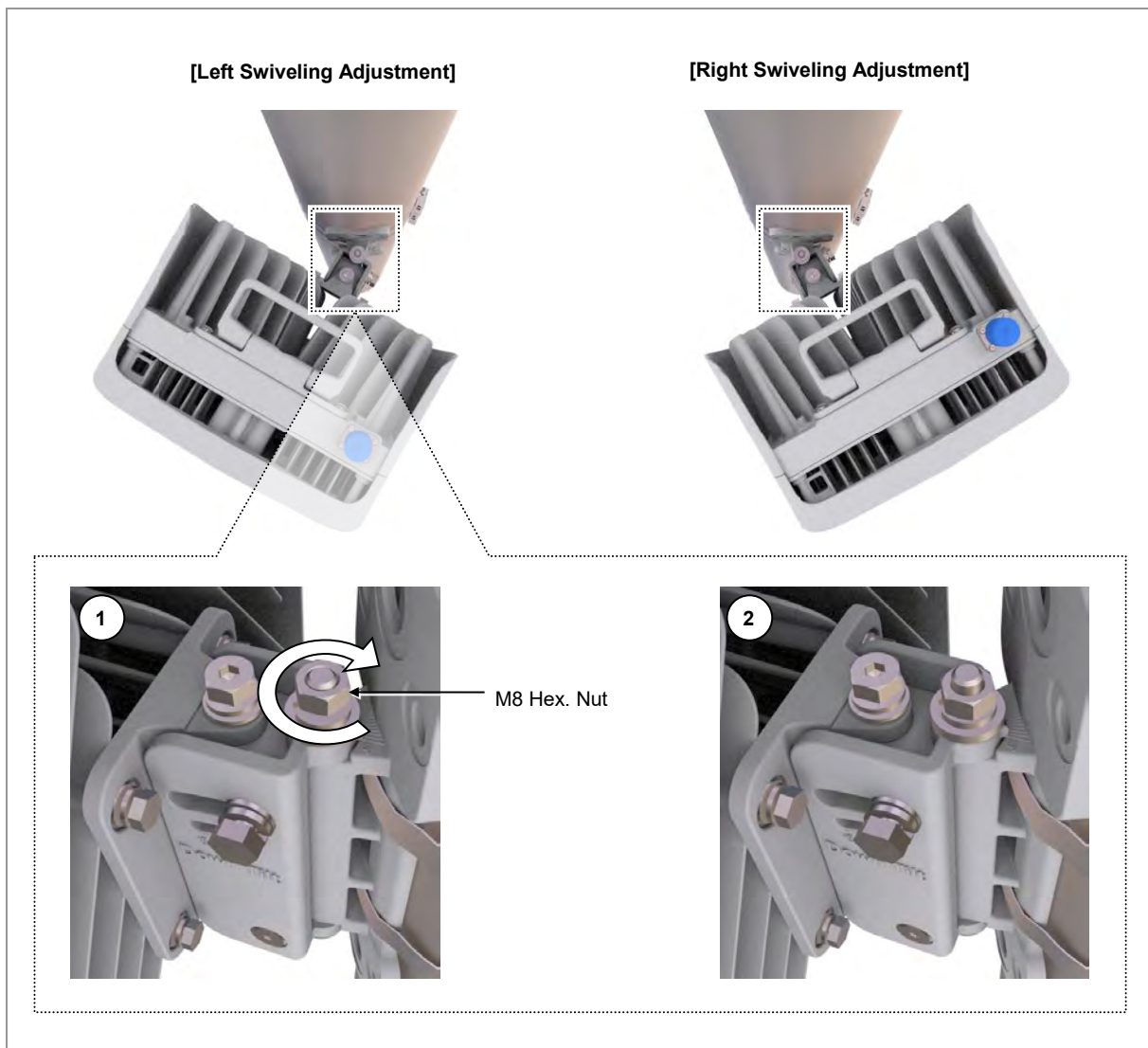

Using No Tilting Bracket

This section describes the procedures to fix the unit bracket and the mounting bracket.

Fixing Unit Bracket



The instructions for mounting a unit bracket to the AU apply to all installation types.

To fix the unit bracket with no tilting bracket, do the following:

Prerequisites

Before proceeding with fixing the unit bracket on the AU, make sure that you have the items mentioned in the table below:

Table 13. Parts and Tools for Fixing Unit Bracket on AU

Category	Description	
Parts	Unit Bracket	1 EA/AU
	Fasteners	M6 × L20 Hex. bolt (Washer assembly) 4 EA/AU
Recommended Torque Value	M6 Hex. bolt	43 lbf-in
Working Tools	<ul style="list-style-type: none"> • Torque Wrench (10 to 50 lbf-in) • Torque Wrench Spanner Head (apply Hex. head: 10 mm) 	

- 1 Check the position for mounting the unit bracket on the back of the AU and place it in that position.
- 2 Fix the unit bracket using the fasteners.

Figure 39. Fixing Unit Bracket

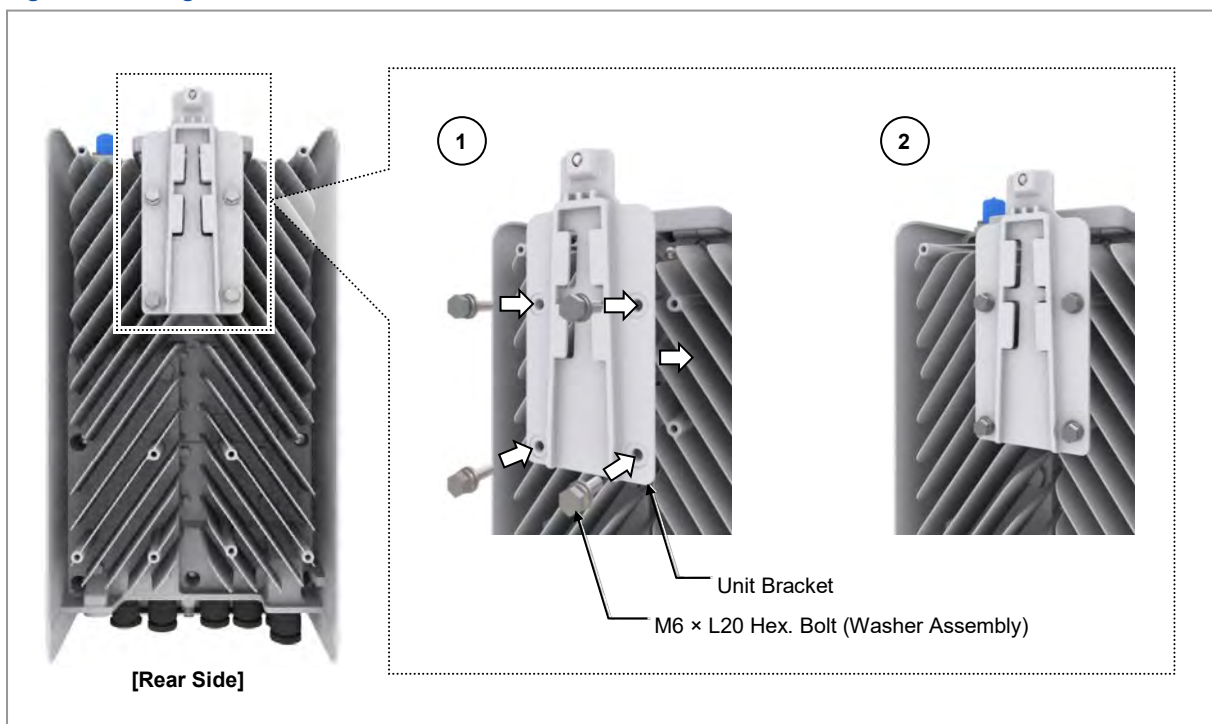

Fixing Pole Type



The standard of the pole on which the mounting bracket can be attached using steel bands is 50 to 125 A. (When installing on a pole of 125 A, the steel band should be replaced.)



For installing three-sector AU, diameter of a pole must be 200 A or higher.

Fixing Mounting Bracket on the pole

To fix the mounting bracket on the pole, do the following:

Prerequisites

Before proceeding with fixing the mounting bracket, make sure that you have the items mentioned in the table below:

Table 14. Parts and Tools for Fixing Mounting Bracket on the Pole

Category	Description			
Parts	Mounting Bracket	1 Sector	1 EA	
		2 Sector	2 EA	
		3 Sector	3 EA	
	Fasteners	Steel Band	1 Sector or 2 Sector	2 EA
			3 Sector	3 EA
Recommended Torque Value	Steel Band Fixing Screw		48.5 lbf-in	
Working Tools	<ul style="list-style-type: none"> • Torque Driver (20 to 90 lbf-in) • Screw Driver Bit ('+', No. 3) • Antenna Alignment Tool 			

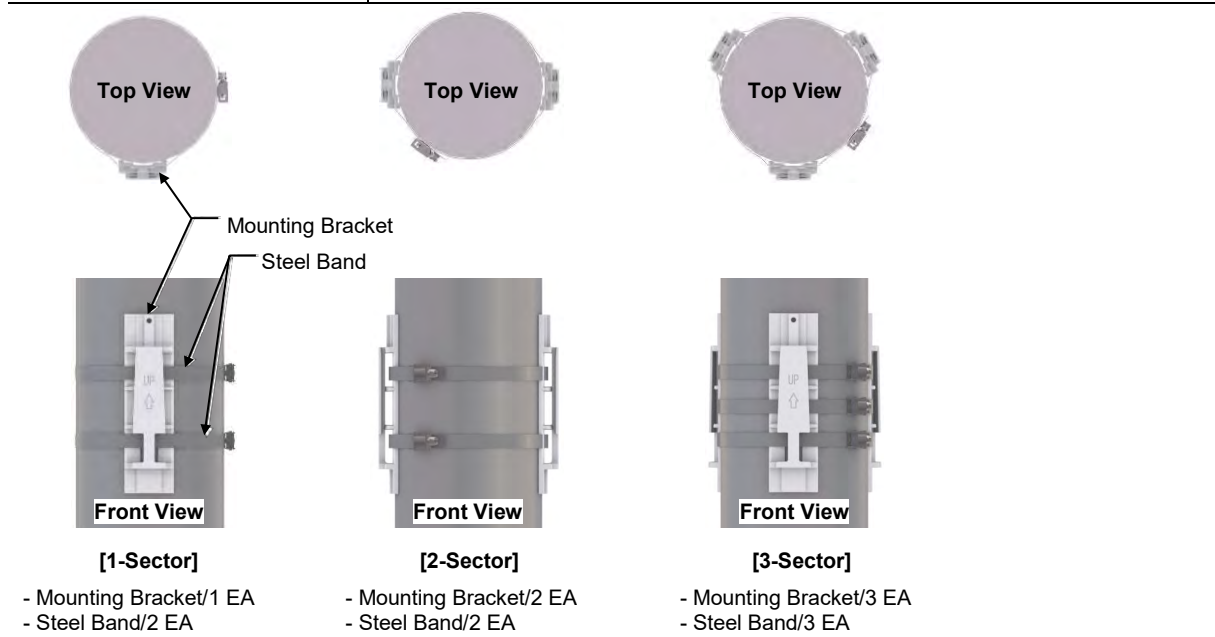

The process for attaching the one, two or three-sector mounting brackets to the pole is the same. (However, the number of mounting brackets and steel bands will differ depending on the sector.) This manual describes the installation process for attaching a one-sector bracket only.

- 1 Pass the steel band through the fixing hole of the mounting bracket.

Figure 40. Fixing Mounting Bracket on the Pole (1)

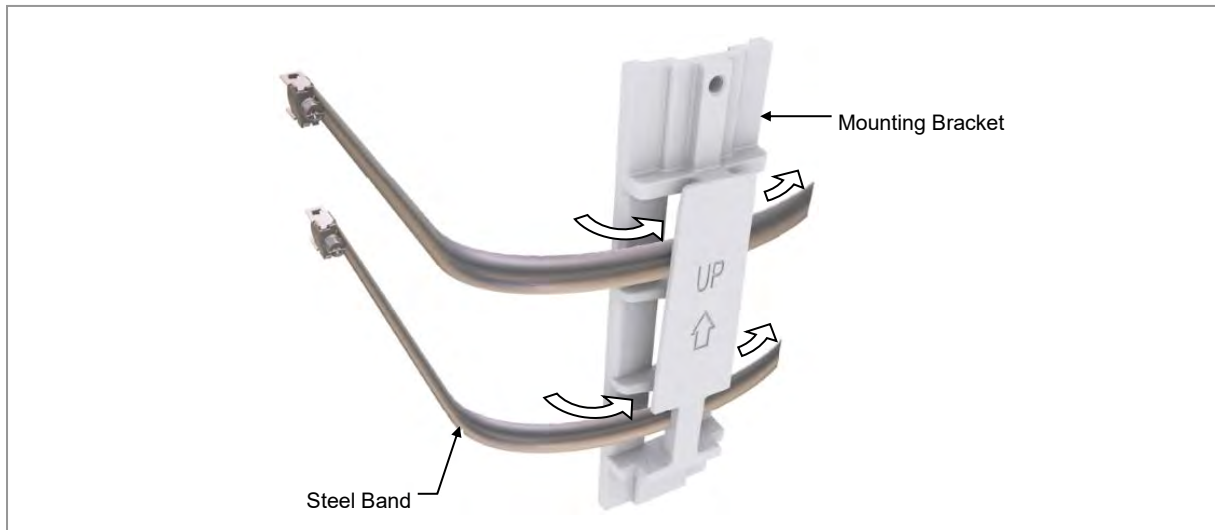

The mounting bracket and steel band assembly for the installation of a two or three-sector bracket are shown in the figure below.



[2-Sector]

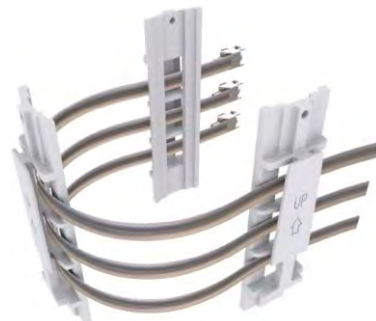

[3-Sector]

- 2** Use the antenna alignment tool to determine the azimuth of the AU to be installed on the pole.

Figure 41. Fixing Mounting Bracket on the Pole (2)

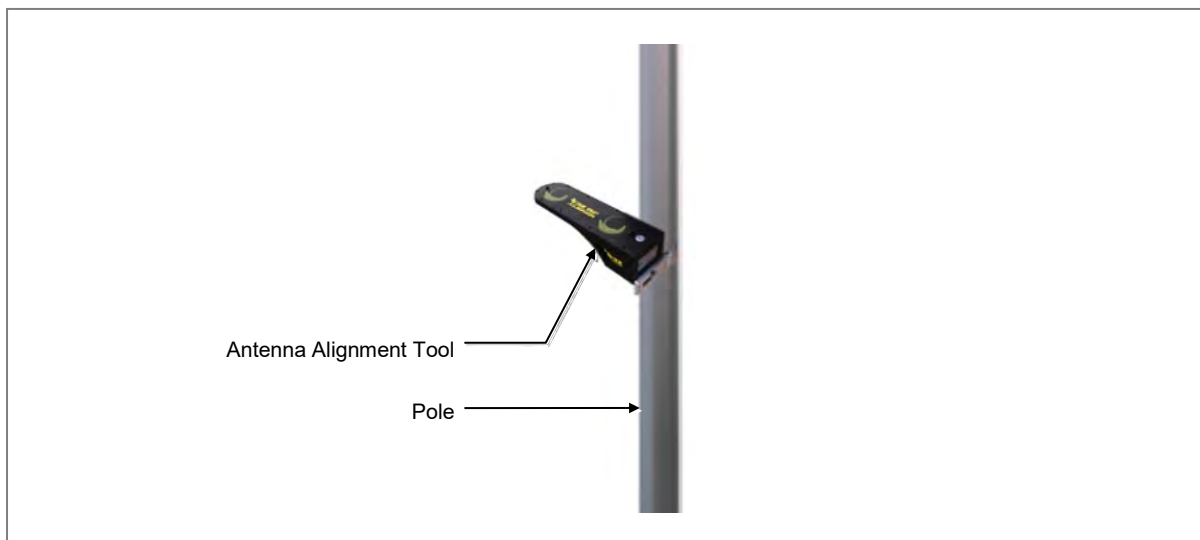

3 Place the mounting bracket to the pole.

Figure 42. Fixing Mounting Bracket on the Pole (3)

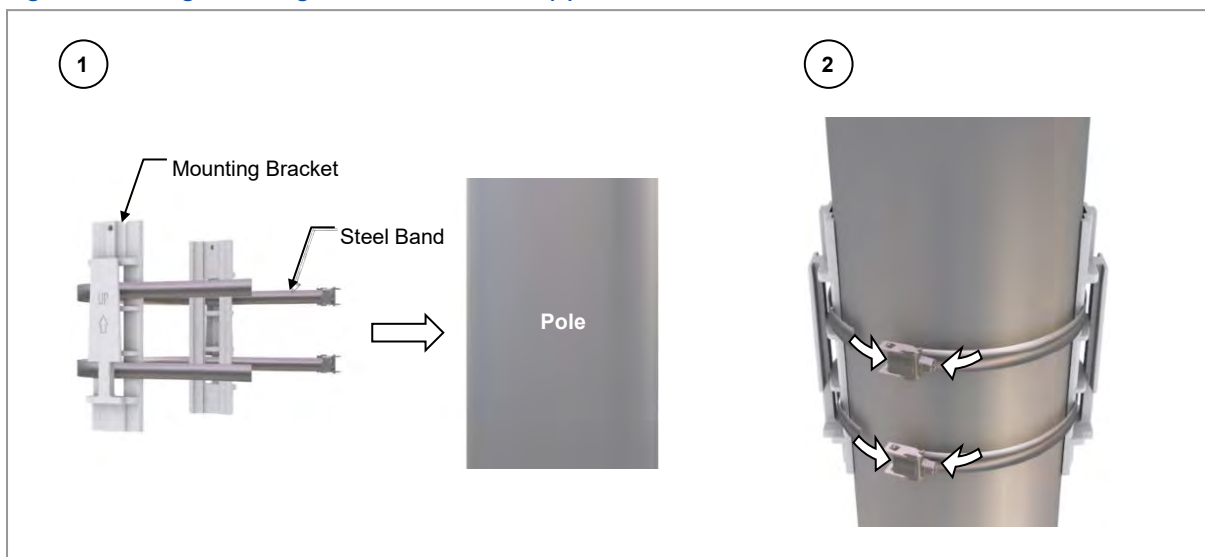

4 Fix the mounting bracket to the pole using the steel band.

Figure 43. Fixing Mounting Bracket on the Pole (4)

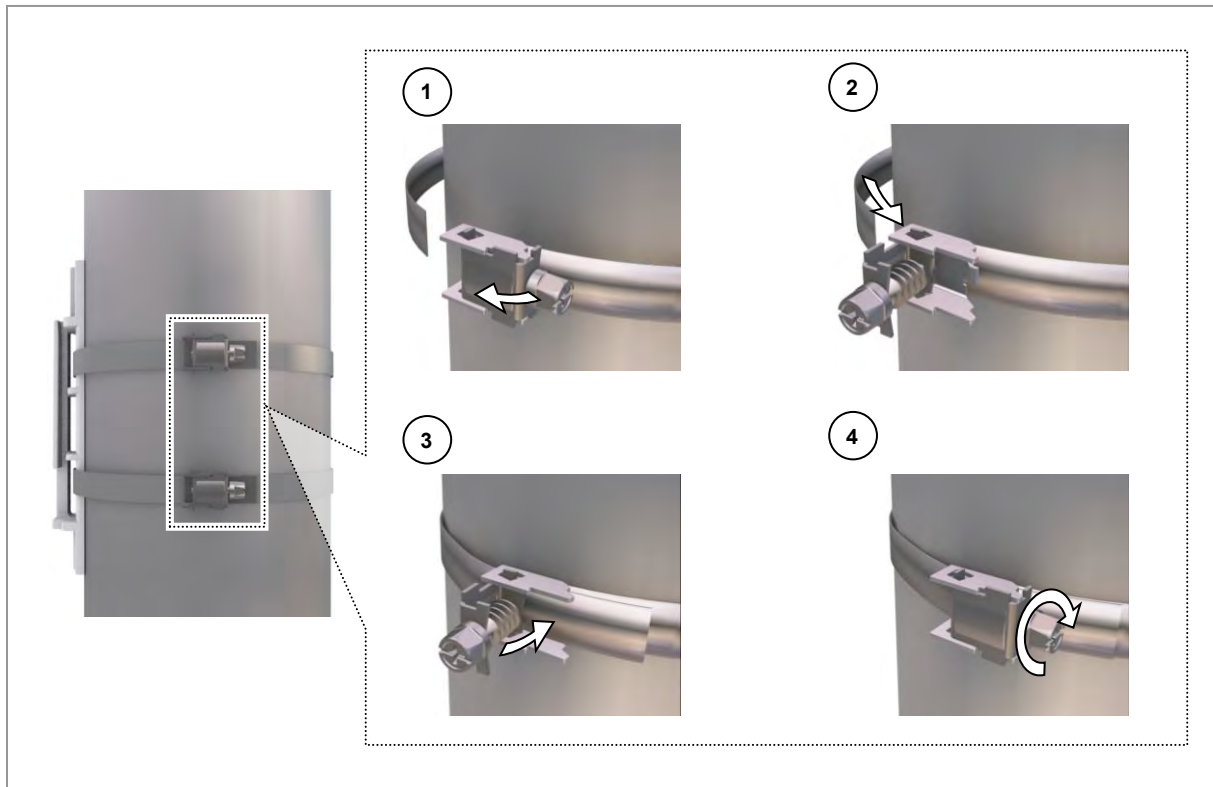

The mounting bracket fixing for the installation of a two or three-sector bracket is shown in the figure below.



[2-Sector]





[3-Sector]

5 Check the level of mounting bracket on the pole and adjust the level.

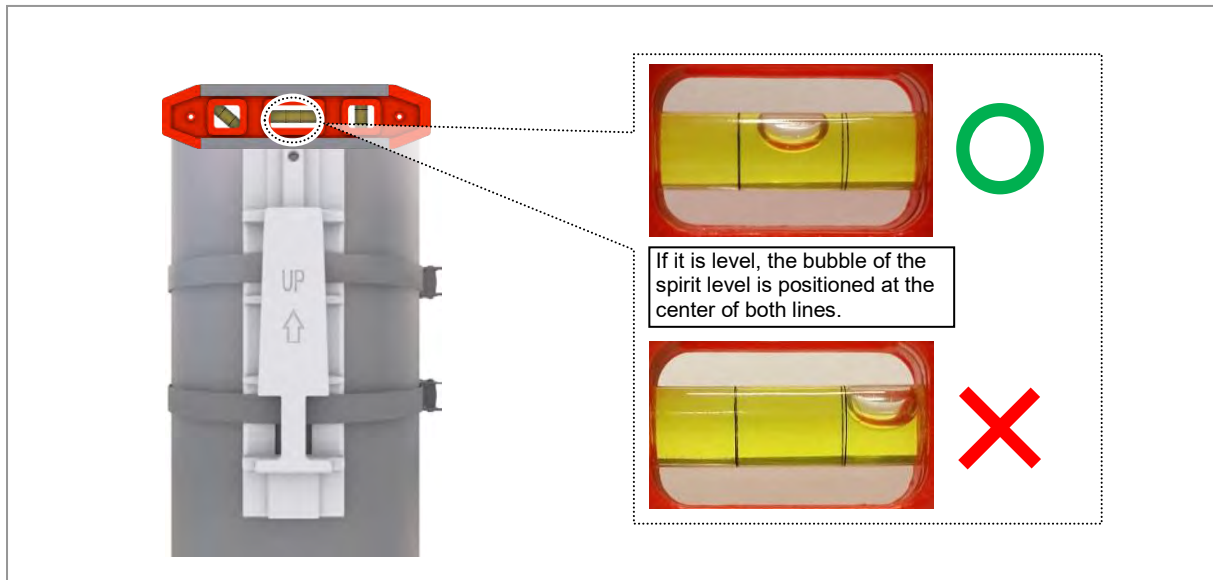
Figure 44. Fixing Mounting Bracket on the Pole (5)



-  When fixing the mounting bracket on the pole, be sure to check the level of bracket. After finishing the installation, adjust the level minutely.
-  When poor leveling happens, adjust the position of fasteners used to fix the mounting bracket.
-  After fixing the steel band, push the remainder of band inside the mounting bracket

Lifting AU

To lift the AU, do the following:

Lifting with a cherry picker.

Figure 45. Lifting AU

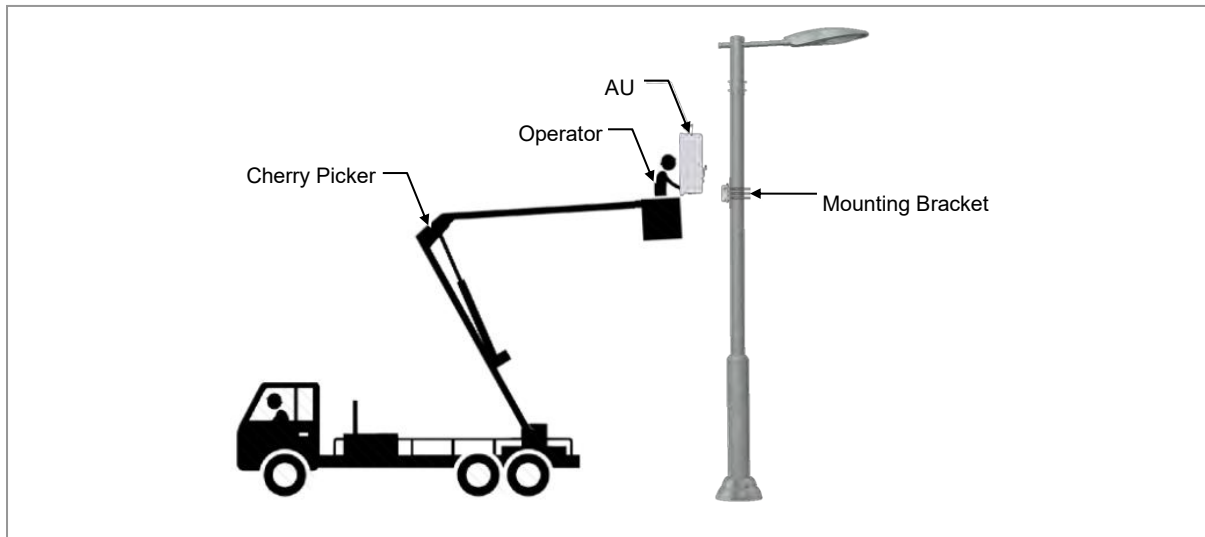

Fixing AU on the Pole

To fix the AU on the pole, do the following:

Prerequisites

Before proceeding with fixing the AU on the pole, make sure that you have the items mentioned in the table below:

Table 15. Tools for Fixing AU on the Pole

Category	Description	
Recommended Torque Value	M6 SEMS (Hex., +)	43 lbf·in
Working Tools	<ul style="list-style-type: none"> • Torque Wrench (10 to 50 lbf·in) • Torque Wrench Spanner Head (apply Hex. head: 10 mm) • Spanner (10 mm) • Antenna Alignment Tool 	

- 1 Pull out the fastening materials so that they do not get out from the fixing groove of the unit bracket.

Do not pull out completely.

Figure 46. Fixing AU on the Pole (1)

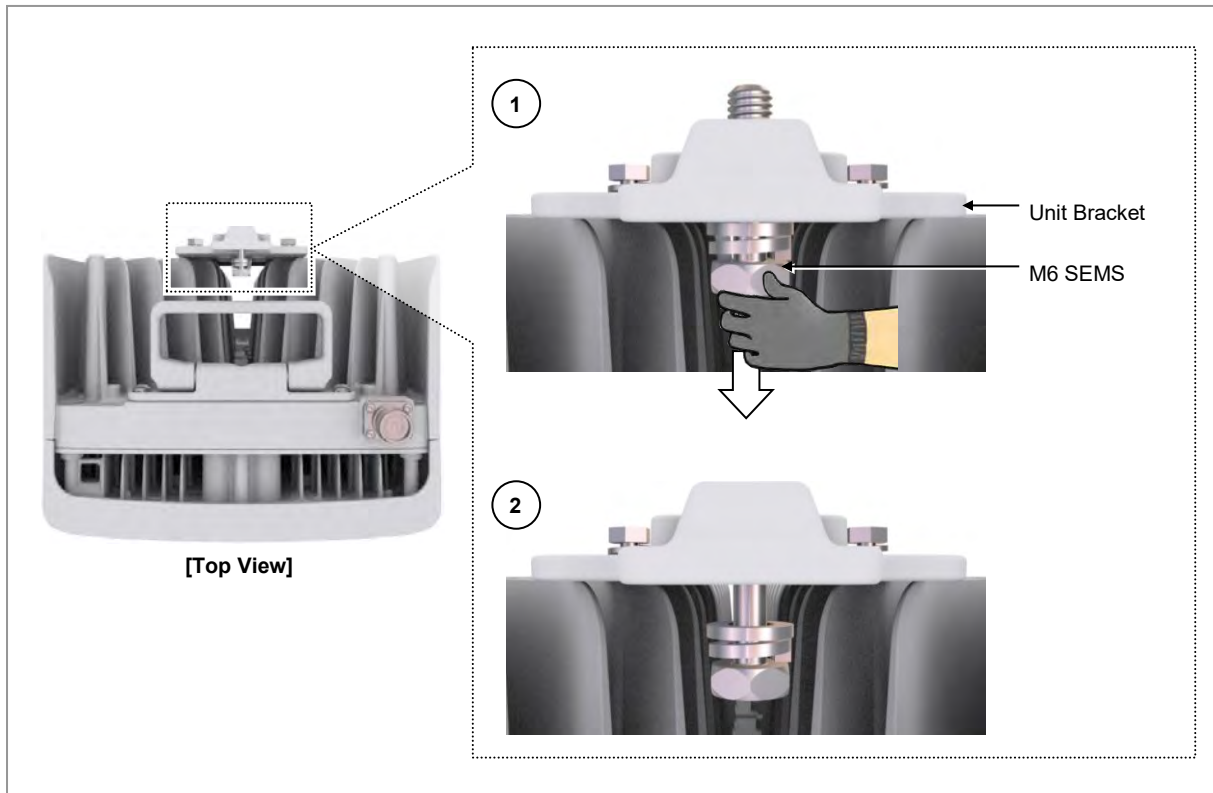

- 2 Place the unit bracket on the fixing grooves of the mounting bracket and push the unit bracket down to fix the AU in place.

Figure 47. Fixing AU on the Pole (2)

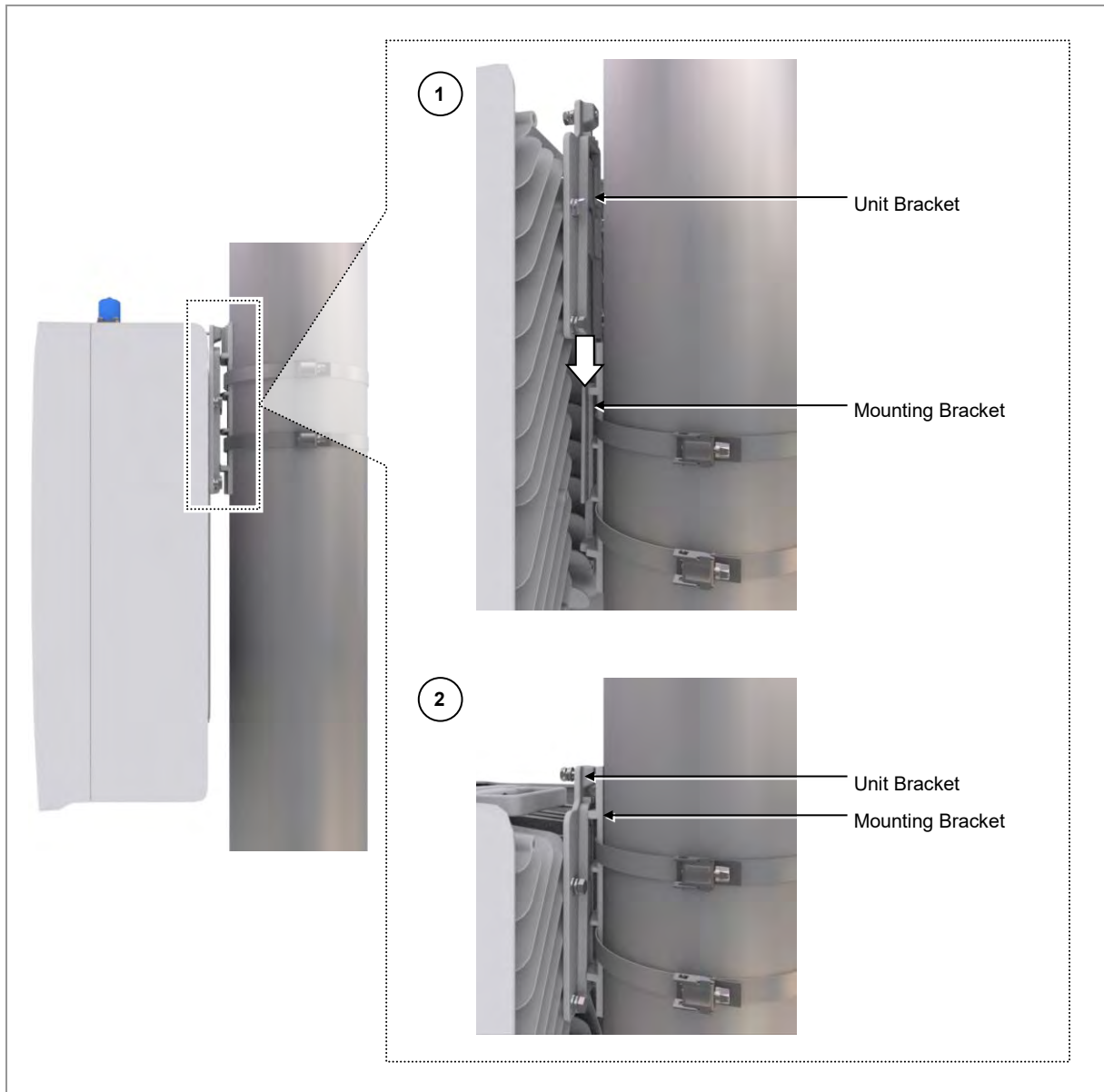

3 Fix the unit bracket to the mounting bracket using the fastener.

Figure 48. Fixing AU on the Pole (3)

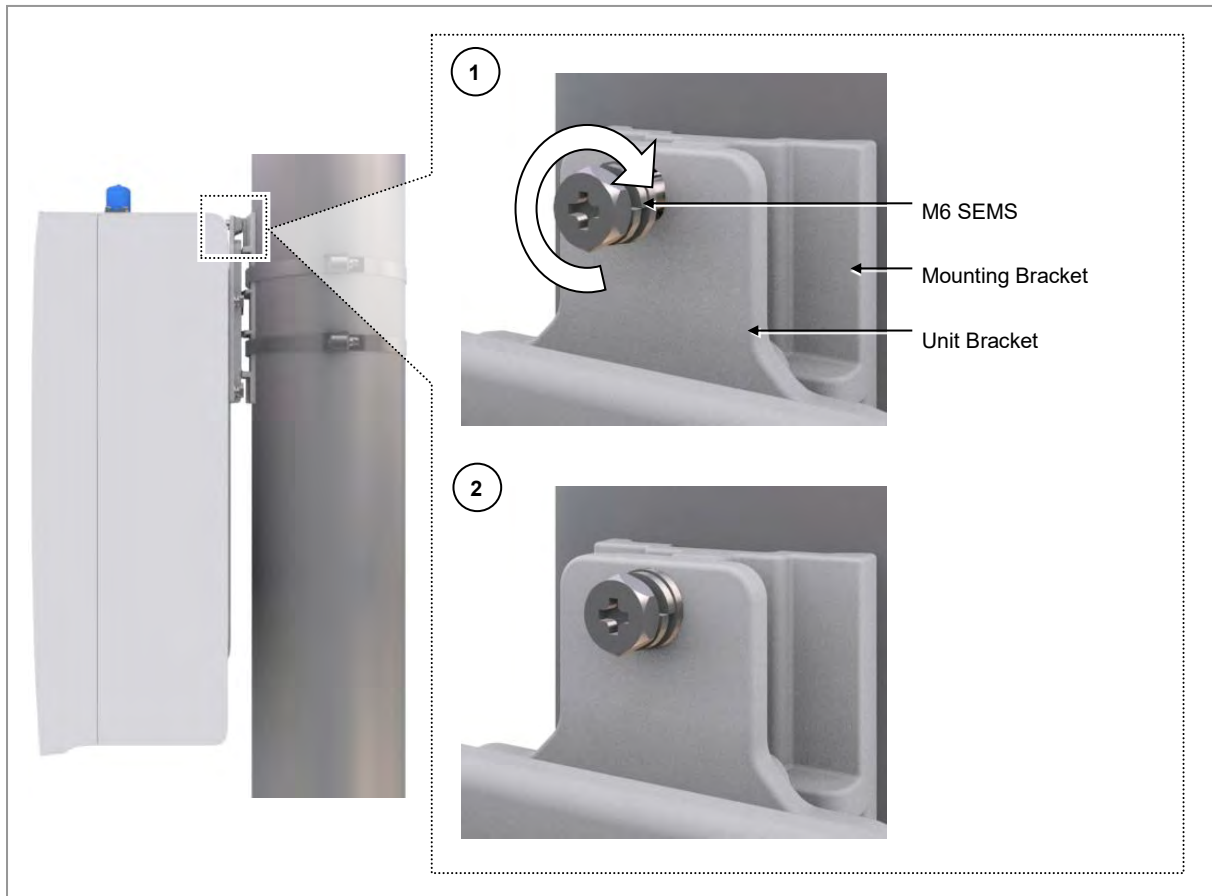

4 Use the antenna alignment tool to check the azimuth of the front of the AU.

Figure 49. Fixing AU on the Pole (4)



The AU fixing for the installation of a two or three-sector bracket is shown in the figure below.

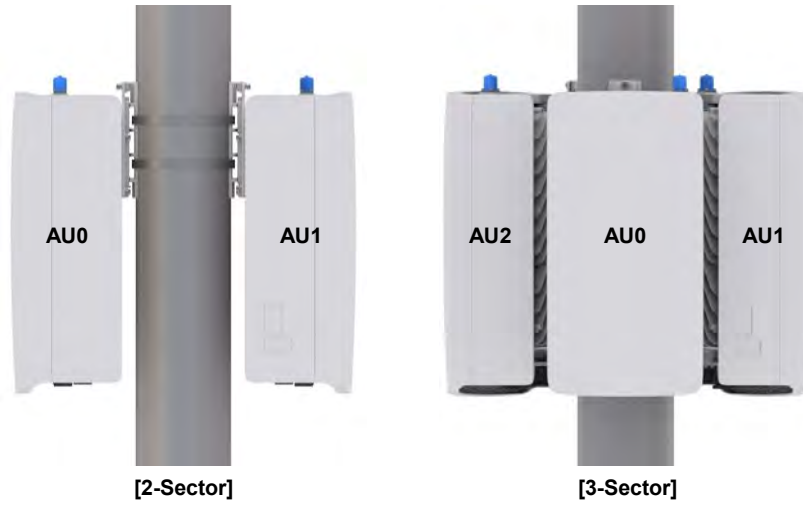

Chapter 3 Connecting Cables

This chapter describes the procedures to connect cables to the AU system and to label the cables.

Cabling Procedure

The figure below depicts the procedure to connect system cables:

Figure 50. Procedure to Connect System Cable

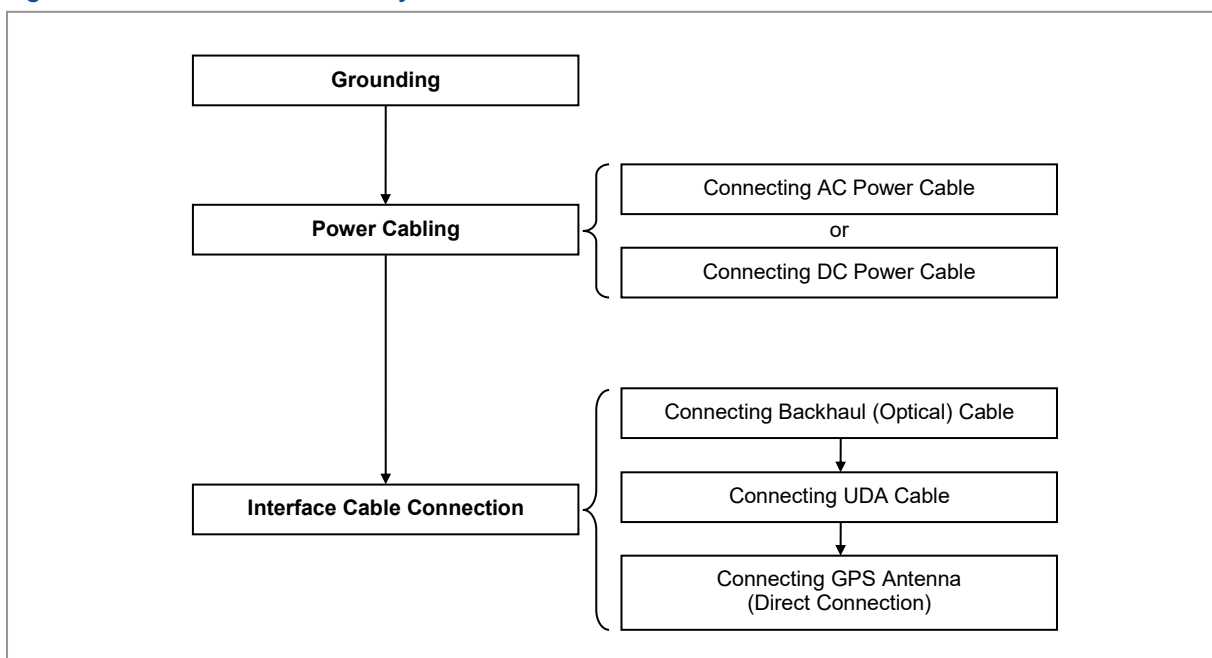

Guidelines for Cable Connections

The figure below depicts the sequence of operations for connecting cables to the system:

Figure 51. Cable Connection Procedure

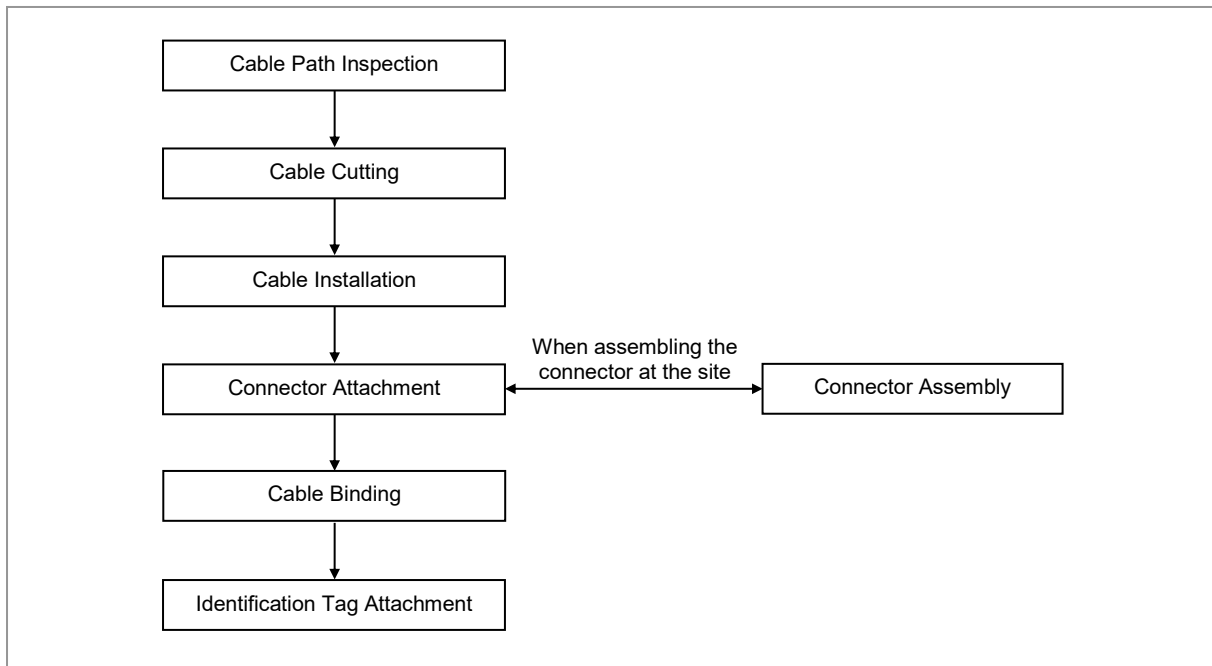

When cutting the cable after installation, ensure that the connector is disconnected. The cable installation while the connector is connected to the system may cause contact failure, or damage to the assembled connector and the cable, due to cable tension or operator mistakes.



The sequence of cable cutting and installation of the cable workflow can be changed depending on the field situation such as cutting after installing or installing after cutting.

Cable Path Inspection

When installing the cable that interconnects rectifier, Main Ground Bar (MGB), backhaul device, and so on within the system, the cable path, length, and cable installation method must be inspected.

To inspect the cable path, ensure the following.

- A minimum cable length must be selected, so that the length does not affect the cable installation and maintenance.

- The cable must be placed in a location where the cable is not damaged by external factors such as power line, flooding, and footpaths.
- In areas where the cable may be damaged by external factors, ensure that measures are taken to prevent damage to the cable, such as cable tray, ducts, and flexible pipe.

Cable Cutting

Measure the exact distance after carefully checking the route, and cut the cable using a cutting tool.

To cut the cable, follow these guidelines:

- Cut the cable to the length determined in the Cable Path Inspection step.
- Use a dedicated cable cutting tool.
- Cut the cable at right angles.
- Be careful to keep the cable away from moisture, iron, lead, dust, or other foreign material when cutting.
- Remove any foreign material attached to the cable using solvent and a brush.

Cable Installation

This process involves running the cable along the cabling path to the target connector of the system or an auxiliary device. This is done after cable path inspection and cable cutting are completed.

To install the cable, follow these guidelines:

- Be careful not to damage the cable.
- If the cable is damaged, cut out the damaged section before installing, or replace the cable.
- Run the cable so that it is not tangled. In particular, when installing the cable from a horizontal section to a vertical section, be careful not to reverse the upper and lower lines of the cable.
- Always use the maximum curvature radius possible, and ensure that the minimum curvature radius specification is complied with.
- If the cable needs to be protected, use suitable protective cover such as PVC channel, spiral sleeve, flexible pipe, and cable rack.
- Install the DC power cable and the data transmission cable away from the AC power cable to prevent electromagnetic induction.

The table below outlines the recommended minimum allowed cable bend radius for different types of cables:

Table 16. Recommended Minimum Allowed Cable Bending Radius

No	Type	Allowed Cable Bending Radius	
1	Ground Cable	8 × OD	
2	Power Cable	Operation: 8 × OD	Installation: 12 × OD
3	Optical Cable (Outdoor)	Operation: 10 × OD	Installation: 20 × OD
4	UTP/FTP/S-FTP Cable	5 × OD	



If the allowed cable bend radius is specified by the manufacturer, comply with the bend radius specified.
- OD: Outer Diameter

Connector Attachment

This process involves assembling a connector to an installed cable or to a device on the site.

Follow these guidelines when attaching the connector.

- Ensure operator is fully aware of the connector assembly method before assembling the connector. Assemble the connector in accordance with its pin map.
- Each connector has a hook to prevent its core positions from being changed.
- Check the corresponding grooves before connecting the connector to another connector.
- Use a weather proof tape at the connector connection for cables that are installed outdoor, such as feeder lines, to prevent water leakage and corrosion from occurring at the part exposed to the outside.
- Connect each cable of the connector assembly in a straight line.
- Be careful when connecting the cable so that contact failure does not occur at the connector connection due to tension.

Cable Binding

This process involves fixing and arranging an installed cable using binding thread, cable ties, binding wire, and ram clamps.

Follow these guidelines when binding a cable.

- Be careful not to damage the cable during binding.
- Use proper cable binding tools according to the target location (indoor or outdoor) and the type of the cable (power supply cable, optical cable, or feeder line).
- Ensure the cutting sections of the cable tie and the binding line are not exposed to the outside. This may cause damage to the cables or personal injury.
- Cut off the remainder of the cable thread by leaving about 50 mm of extra length to prevent the knot from easily getting untied.
- If there is a chance of contact-failure to occur in the connector connection due

to tension, bind the cable at the closest location to the connector.

Identification Tag Attachment

This process involves attaching a marker cable tie, a nameplate, and a label to both ends of a cable (connections to a connector) to identify the use of the cable and the cabling path.

Follow these guidelines when attaching an identification tag.

- When installing the cable outdoor, use relief engraving and coated labels to prevent the markings from being erased.
- Since the form and attachment method for identification tags are different for each provider, consult with the provider before attaching the tags.



When connecting the cables, always connect the ground cable first. If a worker contacts the equipment, connects a cable, or performs maintenance without connecting the ground cable, the system can be damaged or the worker may be injured due to static electricity and short circuit.



When performing cable work for the system, proceed with the ground work before any other work to prevent errors occurring due to static electricity and other reasons.



After completing cable installation, unused ports must be capped.



When installing, ensure not to overlap or tangle the cables. In addition, consider future expansion. Install the DC power cable and the data transmission cable away from the AC power cable to prevent electromagnetic induction.



Ensure the work is done by personnel properly trained for the cabling job.

Cabling Diagram

The figure below depicts the different cabling options of the AU:

Figure 52. Cable Diagram

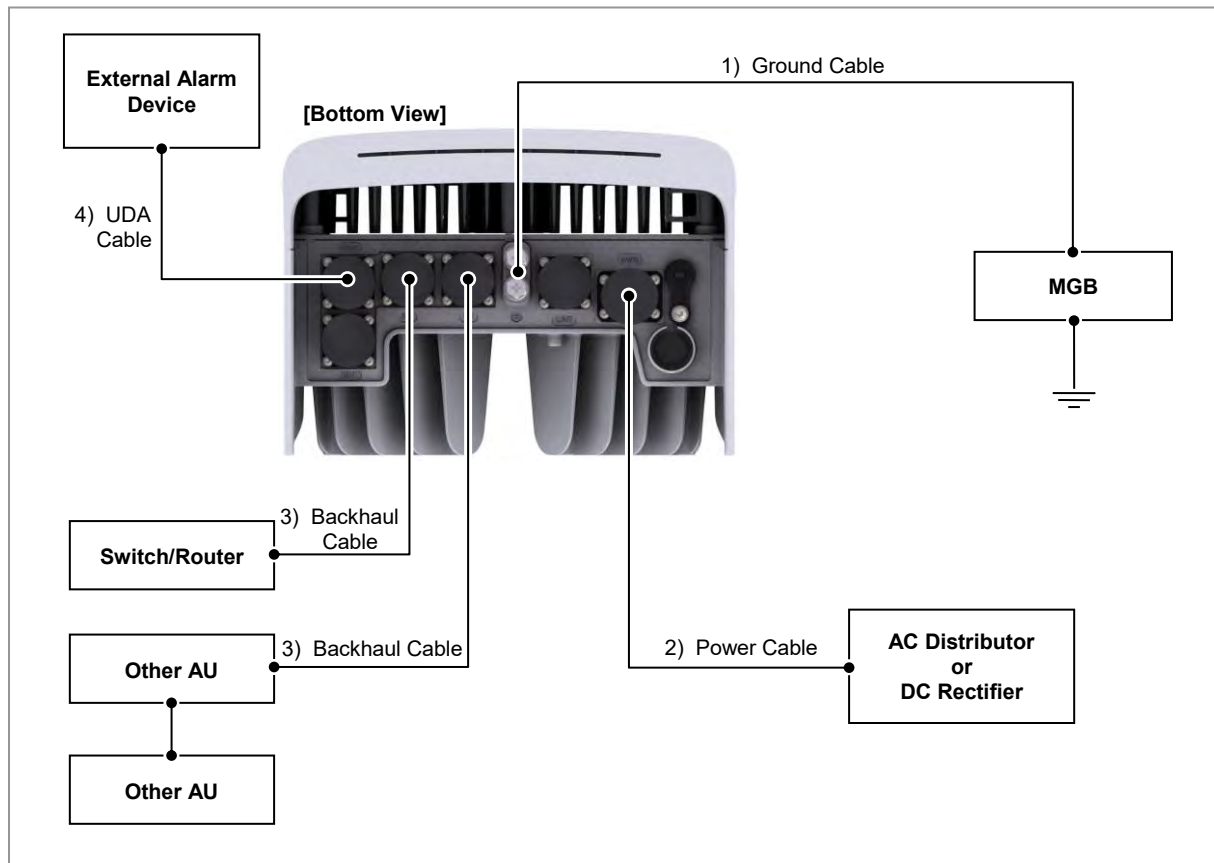

Table 17. AU Connection Cable

From	To	Cable
MGB	AU	1) Ground Cable: 6 AWG × 1C
AU	AC Distributor or DC Rectifier	2) Power Cable • AC: 12 AWG × 3C • DC: 10 AWG × 2C
	Switch/Router	3) Backhaul Cable: Single Mode (Optical, Outdoor Type)
	Other AU	
	External Alarm Device	4) UDA Cable Assembly



The inlet hole finishing method of external equipment must be done after consultation with operation company, if the cable is connected to external equipment, such as optical distribution box.

- Cables: Power cable, Backhaul (Optical) cables and UDA cable

Grounding

To comply with UL 60950 or 62368, the equipment must be connected to a safety grounding point via a permanent link. Grounding points are located on the product for this purpose. Always connect the ground cable before fitting other cables. The product must remain grounded continuously unless all connections to the power supply and data network are all removed.

If equipment is grounded through a cabinet or rack, make sure it is done so properly



Connect the ground cable first. In cabling, the connection of cables without the connection to the ground cable may cause damage of the equipment or bodily injury to personnel.

The purposes of the ground construction are as follows:

- To prevent human life and the system from over-current, over-voltage, and lightning.
- To provide a discharge path for surge voltage generated by lightning and power switch.
- To protect the system from static electricity.
- To eliminate or minimize the high-frequency potential in the system housing.
- To provide a conductor for the balance and stability of high-frequency current.
- To stabilize the potential of the circuit against the ground.

Connecting Ground Cable

To connect a ground cable, do the following:

Prerequisites

Before proceeding with connecting the ground cable, make sure that you have the items mentioned in the table below:

Table 18. Parts and Tools for Connecting Ground Cable

Category	Description	
Installation Section	MGB to AU Ground Terminal	
Cable	6 AWG × 1C	
Bending Radius	8 × OD	
Heat Shrink Tube (Spec/Color/Length)	Φ 0.47 in. (12 mm)/Clear/1.96 in. (50 mm)	
Pressure Terminal	MGB	Checking MGB specifications per site and preparing connecting parts
	AU	6 AWG, 2 Hole (90°), Hole diameter: 1/4 in. (6.4 mm), Hole spacing: 0.63 in. (16 mm)
Fastener	MGB	Checking MGB specifications per site and preparing connecting parts
	AU	M6 × L14 SEMS (Hex. +)/2 EA

Category	Description	
Recommended Torque Value	M6 SEMS	43 lbf·in (50 kgf·cm)
Working Tools	<ul style="list-style-type: none"> • Cable Cutter • Wire Stripper • Crimping tool • Heating Gun • Nipper • Screw Driver ('+', Number 3) • Torque Driver (20 to 90 lbf·in.) • Screw Driver Bit ('+', Number 3) 	



For the pressure terminals of the cable, the UL listed products or equivalent must be used.

For example, Manufacturer-Panduit
- 6 AWG Pressure Terminal (LCD6-14AF-L)



- 1 Install the ground cable from the MGB to the AU ground terminal, as shown in figure below:

Figure 53. Connecting Ground Cable (1)

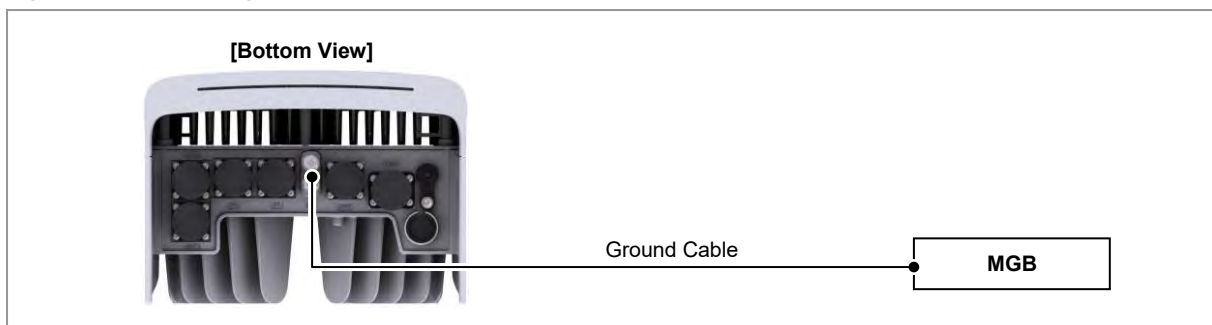

- 2 Remove the fastener (M6 SEMS) from the AU ground terminal.
- 3 Assemble a pressure terminal and a heat shrink tube at the end of the AU ground cable.
- 4 Align the pressure terminal to the mounting hole of the AU ground terminal.
- 5 Firmly fix the pressure terminal onto the AU ground terminal using fasteners.

Figure 54. Connecting Ground Cable (2)

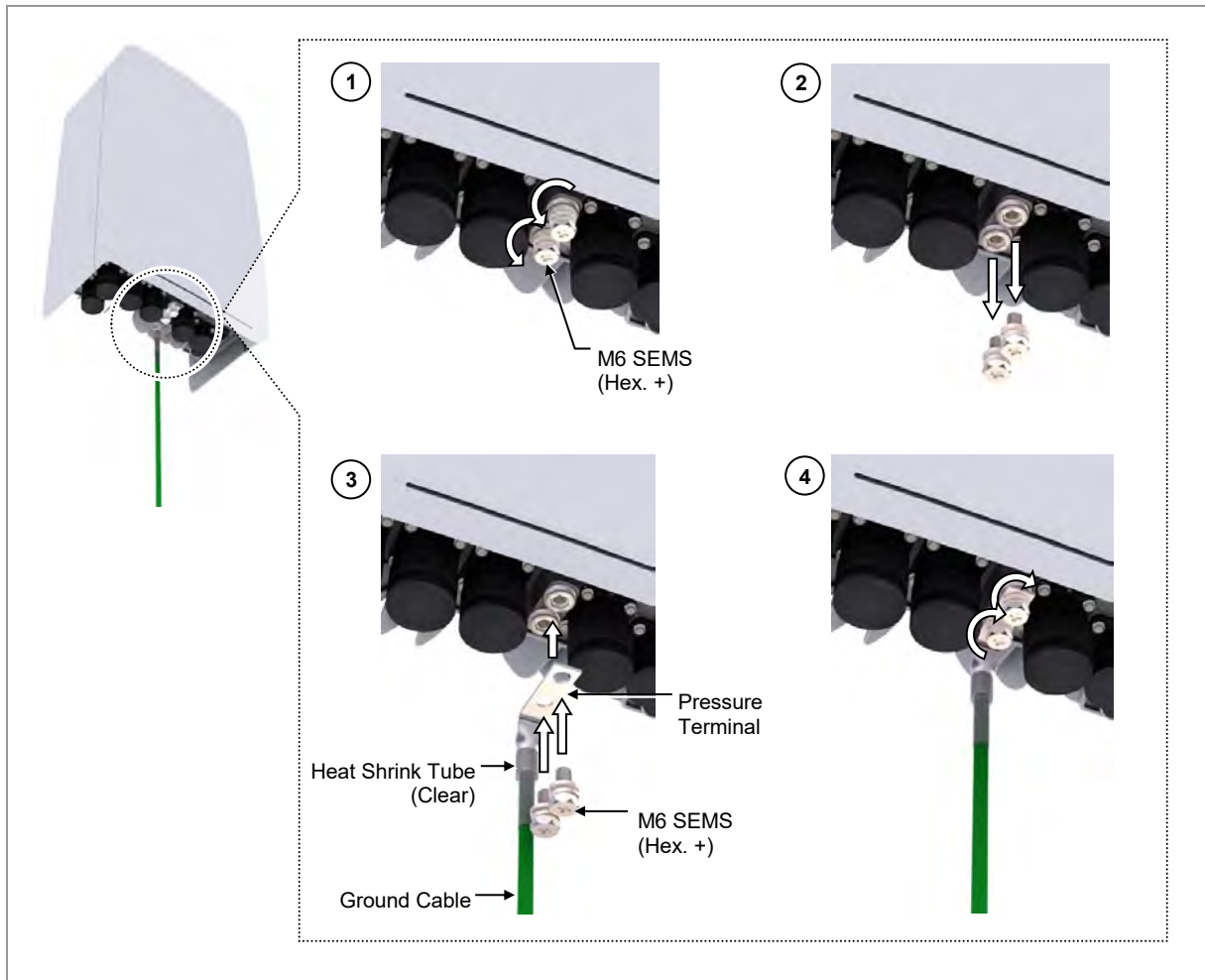

Power Cabling

The figure below depicts the elements of a power supply device:

Figure 55. Power Equipment Elements

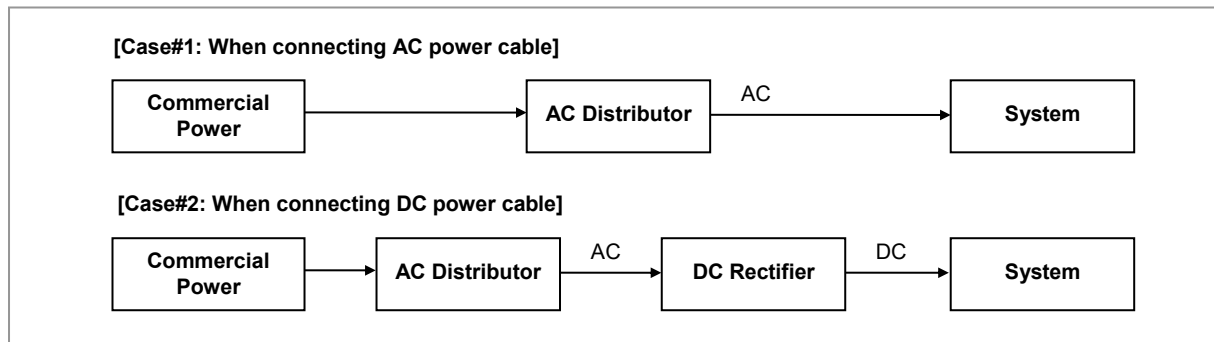

Since power is applied to the system where the power cable is connected by manipulating the circuit breaker of the rectifier, ensure to check the rectifier breaker is turned off (open) before connecting the power cable to the power connector. If the system is installed while the circuit breaker is on, the worker may get critically injured if the cable is connected in the wrong way.



Handling the power cable incorrectly may damage the rack or cause an electric short-circuit through the cable. Ensure the power switch of the rectifier or the system is turned off before handling the power.



The fasteners for power cable must be tightly secured to prevent electrical accidents.



The heat-resistant temperature of the power cable should be 90°C or more.



Install the power cable to the power port of the system by considering the radius of curvature of its cable specification and then cut the cable. If the operator installs the cable after cutting, there may be length difference among the core wires at the end of the cable because of cable curvature. This may result in poor contact after the cable is connected to the power port.



If you turn the power on and off rapidly (within 1 s), the counter electromotive force caused by cable inductance can damage the system.



Connecting more than one power cable together may increase power loss.



It must be verified that the rectifier or the power distributor has an output voltage within the specified system input range before the power line is connected.



Be sure to comply with the maximum length of use for the power cable. If the length of the power cable exceeds the maximum length of use, it may cause fire,

system damage or life damage.



Install a circuit breaker to a power distributor for the stable power. The capacity of the circuit breaker is AC 10 A (TBD), DC 16 A (TBD). (Use UL listed circuit breakers.)

Connecting Power Cable

▶ Case#1) Connecting AC Power Cable

To connect a AC power cable, do the following:

Prerequisites

Before proceeding with connecting the AC power cable, make sure that you have the items mentioned in the table below:

Table 19. Parts and Tools for Connecting Power Cable_AC

Category	Description	
Installation Section	AC Distributor to AU PWR port	
Cable	12 AWG × 3C	
Maximum available cable length	TBD	
Bending Radius	Operation: 8 × OD	Installation: 12 × OD
Connector	AC Distributor	Check specifications of AC distributor output terminal per site and prepare fasteners.
	AU (AC)	JONHON, Push Pull Type, CT48J-1503TSCBM-07 to OPEN
Working Tools	<ul style="list-style-type: none"> • Cable Cutter • Wire Stripper • Compressor • Heating Gun • Nipper 	

The table below outlines the AC power cable connector pin map:

Table 20. Power Cable/Connector Pin Map_AC

Power Connector Pin Number	Description	Color
1	Line	Black
2	PE	Green
3	Neutral	White

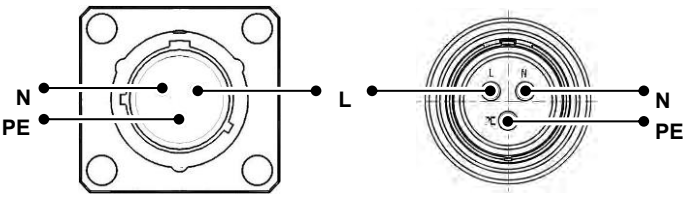
Power Connector Pin Number	Description	Color	
N		L	
PE			N
	[System Side Connector]	[Shell]	

- 1 Install the AC power cable from the distributor to the AU.

Figure 56. Connecting Power Cable_AC (1)

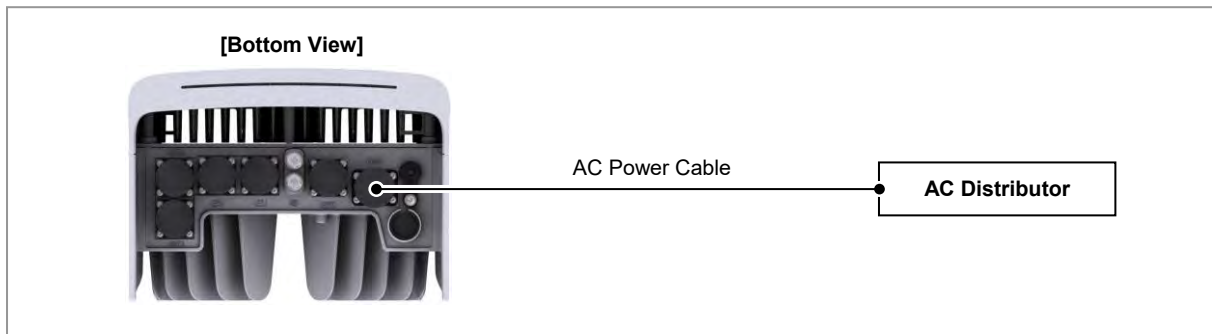

- 2 Separate the cap from the AU side and cable side connector.

Figure 57. Connecting Power Cable_AC (2)

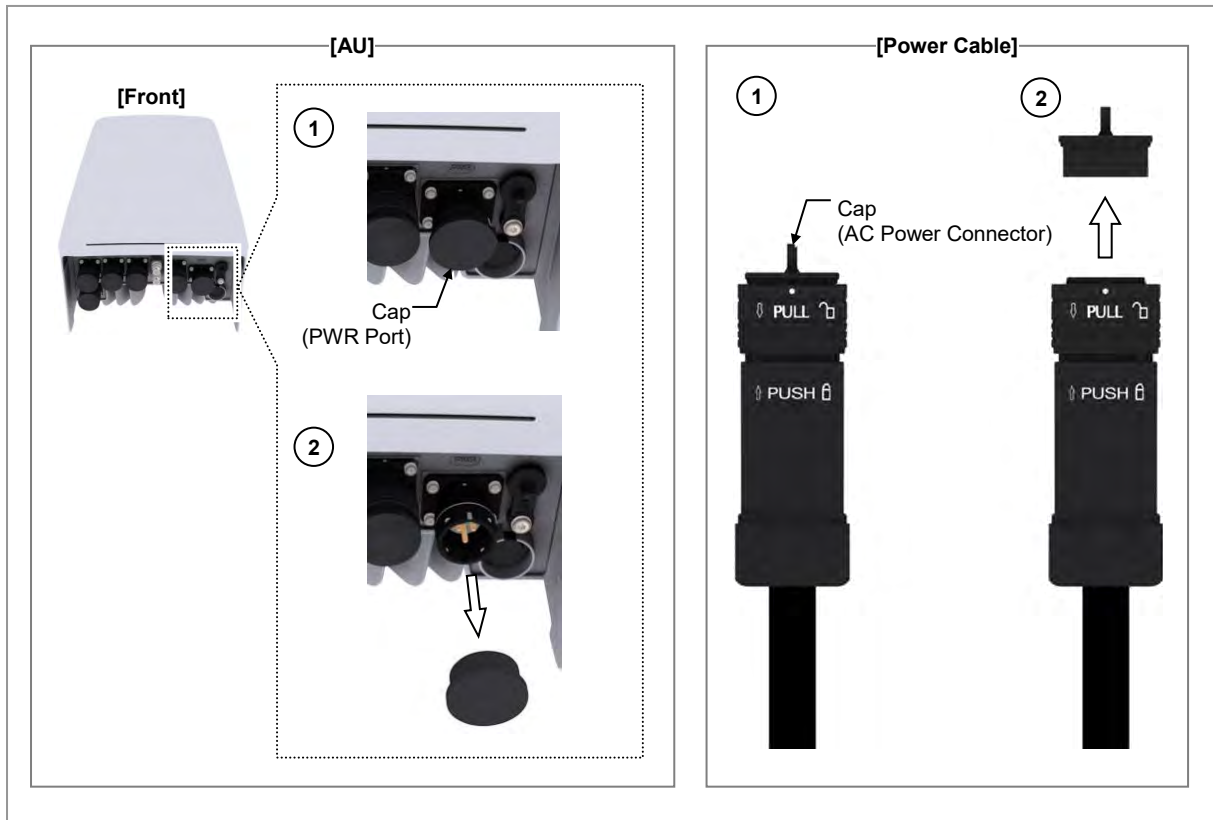

- 3 Insert the connector aligning white dot of the cable side connector and white dot of the system side connector.
- 4 When inserting the connector, push the shell to upper side.

Figure 58. Connecting Power Cable_AC (3)

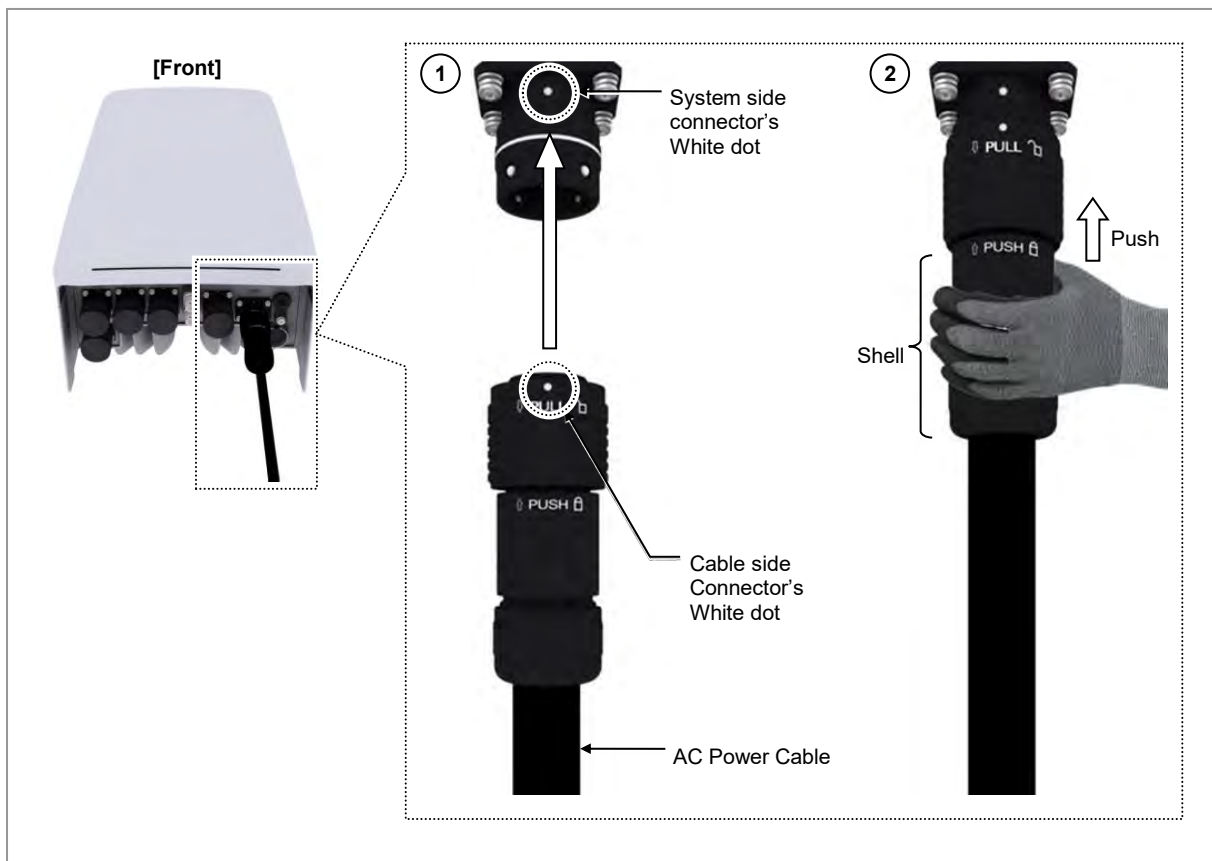

When the connector is fastened tight, the white line on the system side connector becomes invisible.



[White Line is invisible]

[White Line is visible]



The method for connecting or disconnecting the power connector is as follows:

- For connecting the connector, push the shell to upper side.
- For disconnecting the connector, pull the coupling nut to lower side.

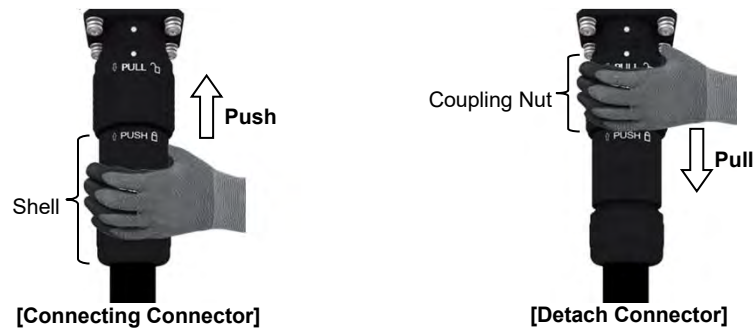

▶ Case#2) Connecting DC Power Cable

To connect a DC power cable, do the following:

Prerequisites

Before proceeding with connecting the DC power cable, make sure that you have the items mentioned in the table below:

Table 21. Parts and Tools for Connecting Power Cable_DC

Category	Description	
Installation Section	DC Rectifier to AU power input port	
Cable	10 AWG × 2C	
Maximum available cable length	TBD	
Bending Radius	Operation: 8 × OD	Installation: 12 × OD
Connector	DC Rectifier	Check specifications of DC rectifier output terminal per site and prepare fasteners.
	AU (DC)	JONHON, Push Pull Type, CT48J-1502TSCBM-07 to OPEN
Working Tools	<ul style="list-style-type: none"> • Cable Cutter • Wire Stripper • Compressor • Heating Gun • Nipper 	

The table below outlines the DC power cable connector pin map:

Table 22. Power Cable/Connector Pin Map_DC

Power Connector Pin Number	Description	Color
1	-48 V	Red
2	RTN	Black

Power Connector Pin Number	Description	Color
	Groove	Bump
Pin 1		
Pin 2		
	Groove	Bump
	[AU Side DC_PWR Port]	[Cable Side Connector]

- 1 Install the DC power cable from the DC rectifier to the AU.

Figure 59. Connecting Power Cable_DC (1)

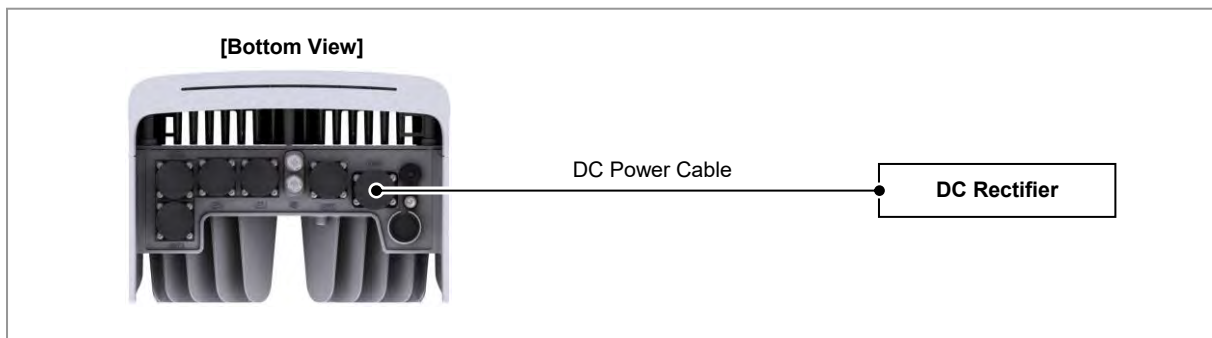

- 2 Separate the cap from the AU side and cable side connector.

Figure 60. Connecting Power Cable_DC (2)

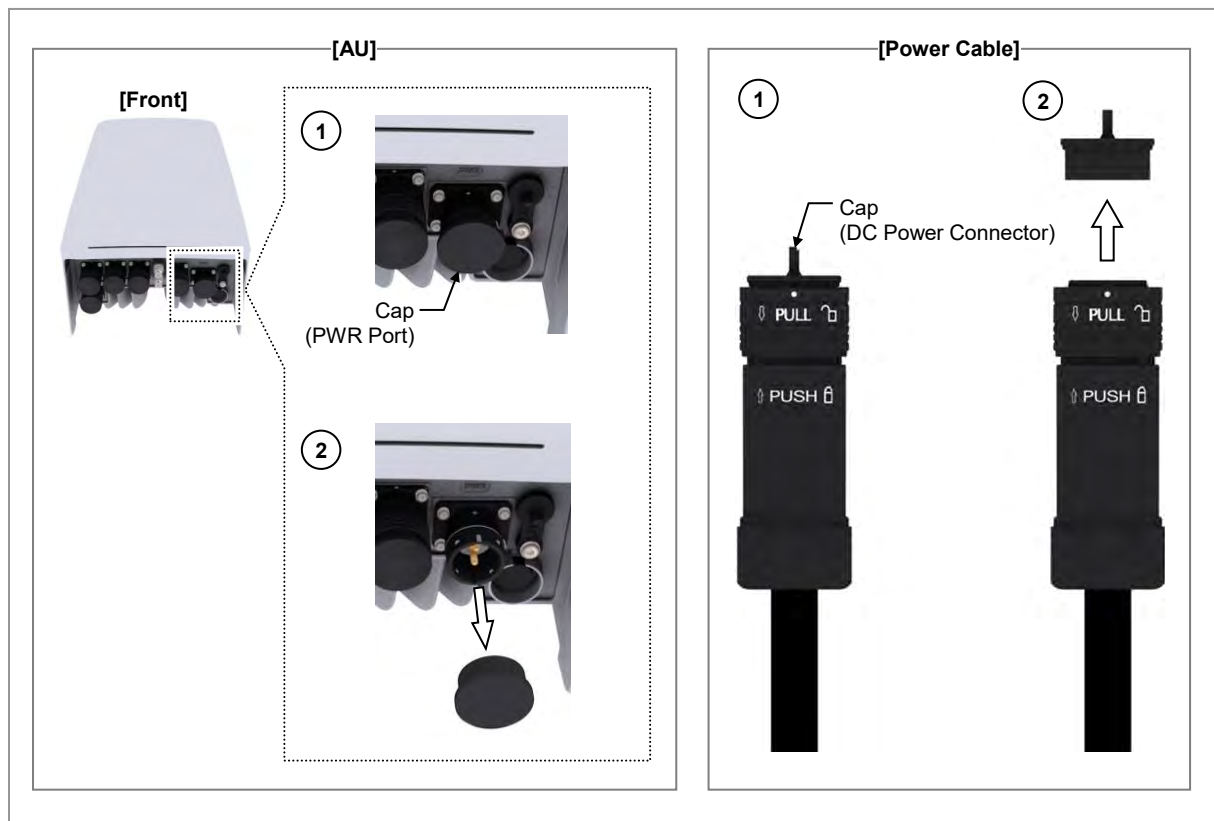

- 3 Insert the connector aligning white dot of the cable side connector and white dot of the system side connector.
- 4 When inserting the connector, push the shell to upper side.

Figure 61. Connecting Power Cable_DC (3)

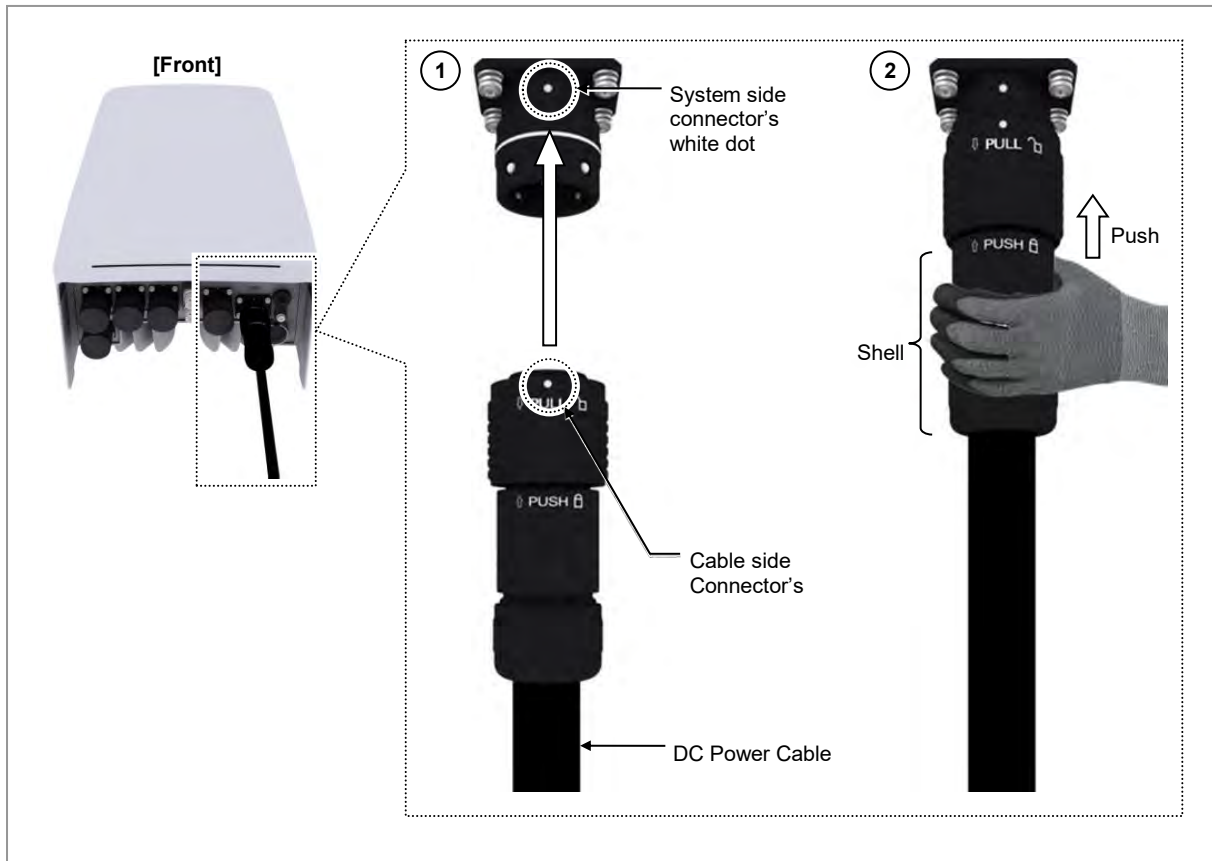

When the connector is fastened tight, the white line on the system side connector becomes invisible.



[White Line is invisible]

[White Line is visible]



The method for connecting or disconnecting the power connector is as follows:

- For connecting the connector, push the shell to upper side.
- For disconnecting the connector, pull the coupling nut to lower side.

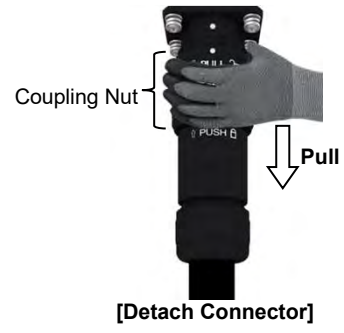
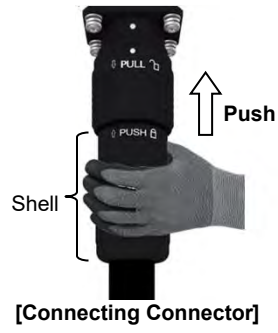

Interface Cable Connection

Remove/Insert Optical Module

If the optical module needs to be removed or inserted before connecting the cable, follow the below process.



Port quantity (Duplex/BiDi) and Bail of Optical module may differ from the figure.

To remove optical module, do the following:

- 1 Hang the optical transceiver removal tool's hook on the optical module's bail within the system.

Figure 62. Optical Module Removal (1)

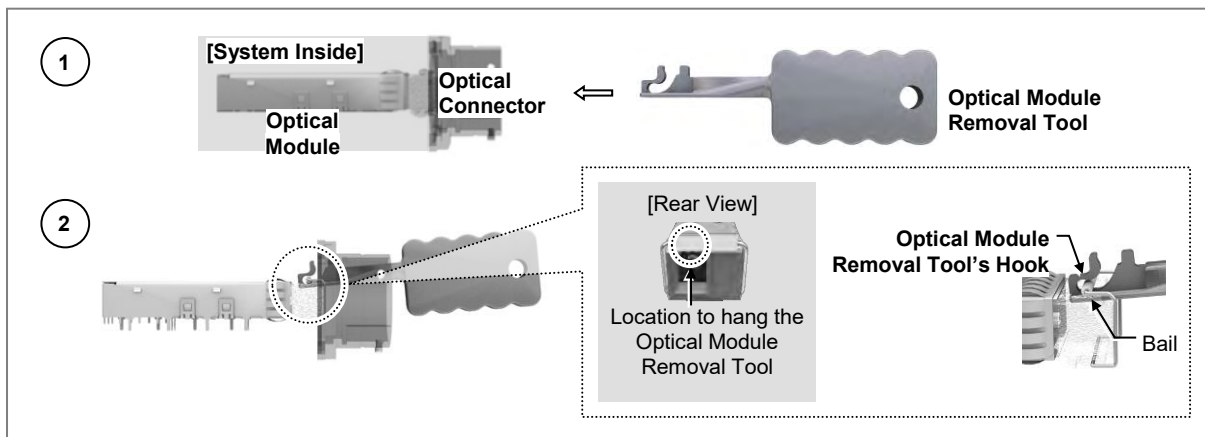

- 2 Completely remove the optical module from the optical module cage by pulling the optical module removal Tool.

Figure 63. Optical Module Removal (2)

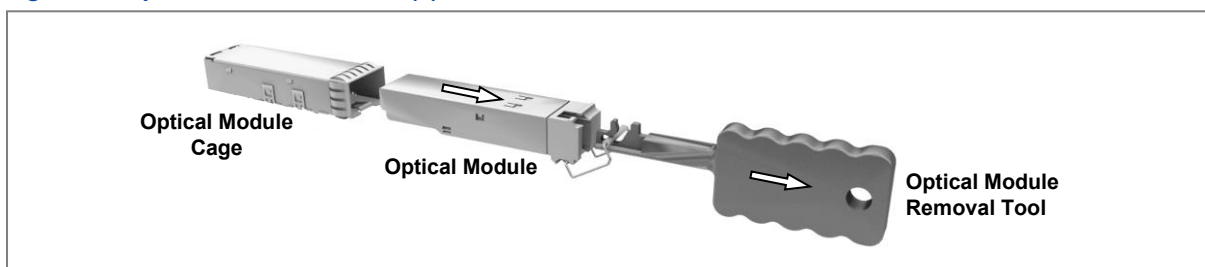

When desorbing an optical module, use a dedicated tool (optical module desorption tool) to remove the handle by opening it for about 90°. When the optical module is detached without using the dedicated tool, the optical module may be jammed and the handle may be damaged due to a lack of opening capacity of the minimum necessary handle.

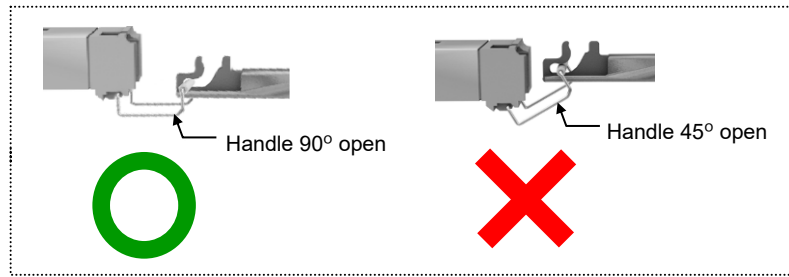

- 3 Remove the optical module and the jig by pressing the optical module Removal Tool's hook grip.

Figure 64. Optical Module Removal (3)



To inset optical module, do the following:

Push the optical module into the optical module cage within the connector.

Figure 65. Optical Module Insert

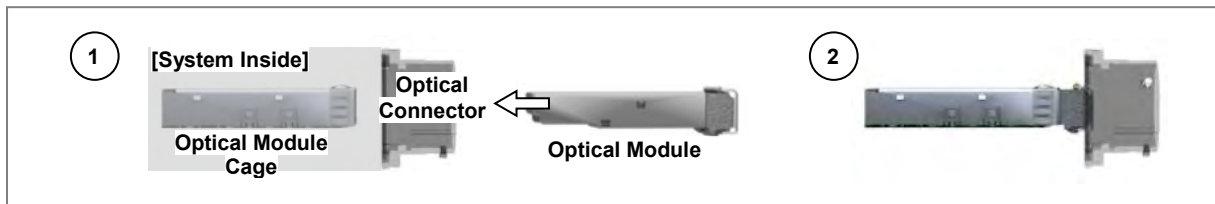

Inset the optical module's bail, facing the rear of the system, to the port.

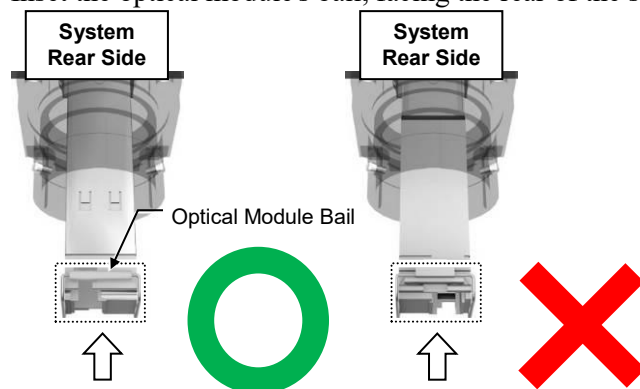

Do not inset when the optical module's bail is unlocked.

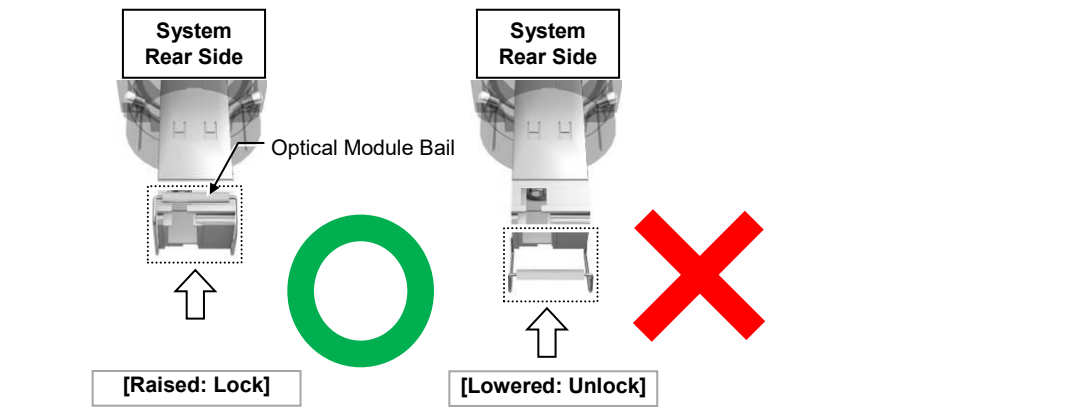

Connecting Backhaul Cable

To connect a backhaul cable, do the following:

Prerequisites

Before proceeding with connecting the backhaul cable, make sure that you have the items mentioned in the table below:

▶ Case#1) Connecting Backhaul Cable: Switch/Router to AU L0 Port

Table 23. Case#1) Parts and Tools for connecting Backhaul Cable

Category	Description	
Installation Section	Switch/Router to AU L0 Port	
Cable	Single Mode (Optical, Outdoor Type)	
Bending Radius	Operation: 10 × OD	Installation: 20 × OD
Connector	AU	JONHON, PDLC03T05 (DLC/UPC)
	Switch/Router	DLC/UPC
Working Tools	<ul style="list-style-type: none"> • Optical Connector Cleaner • SFP Tool (Jig) 	



In the system, the laser beam light runs through the optical cable. The exposure of the laser beam on worker's eye may cause serious injury so that it should be handled with care.



Remove the cap of the optical connector before connecting.
- Before connecting the optical cable, check if the ferrule of the connector is

soiled. Be careful to keep the cutting section away from dust or foreign material. If the cable is soiled with foreign material, do not blow to remove them.

- Make sure to clean the connector in accordance with the cleaning directions in Annex.
- Do not touch the ferrule at the end of optical cable because it is easy to be damaged.

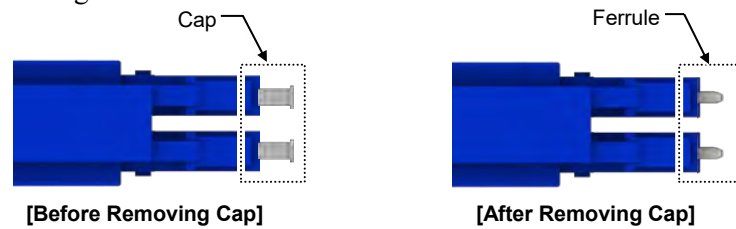

Before connecting the backhaul cable connector, the ferrule of the connector of cable side should be cleaned first by using the optical connector cleaner. (Appendix for more information.)

4 Install the backhaul cable from the switch/router to the AU L0 port.

Figure 66. Case#1) Connecting Backhaul Cable (1)

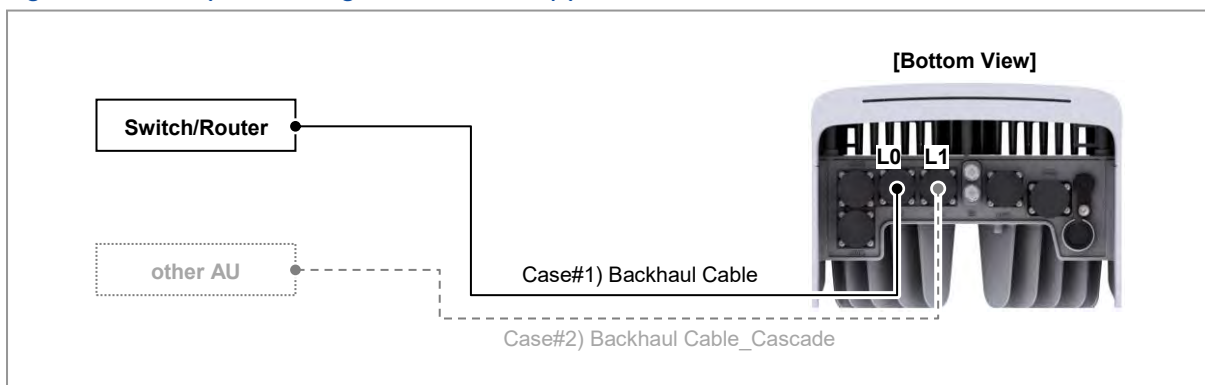

5 Separate the cap from the system side connector (L0 port).

Figure 67. Case#1) Connecting Backhaul Cable (2)

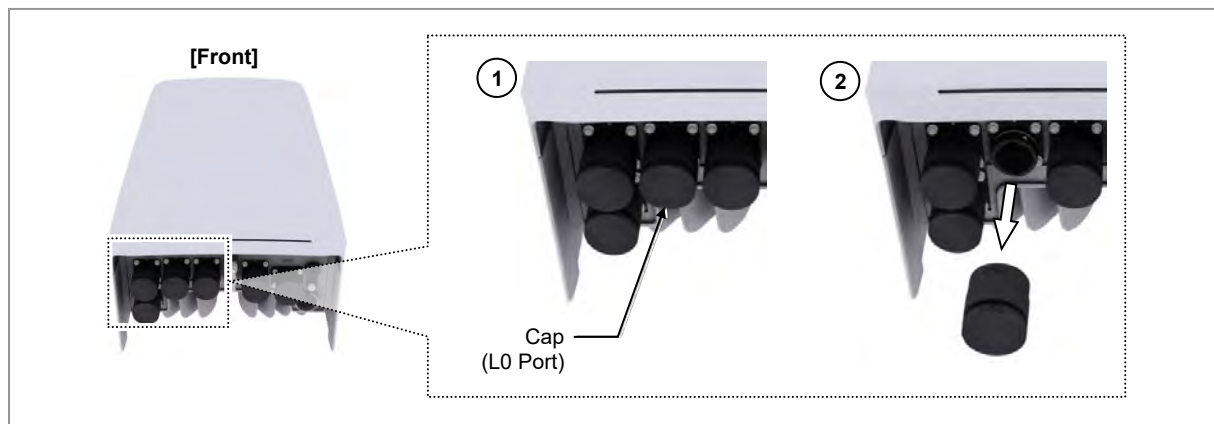

- 6 Separate the cap from the cable side connector.

Figure 68. Case#1) Connecting Backhaul Cable (3)

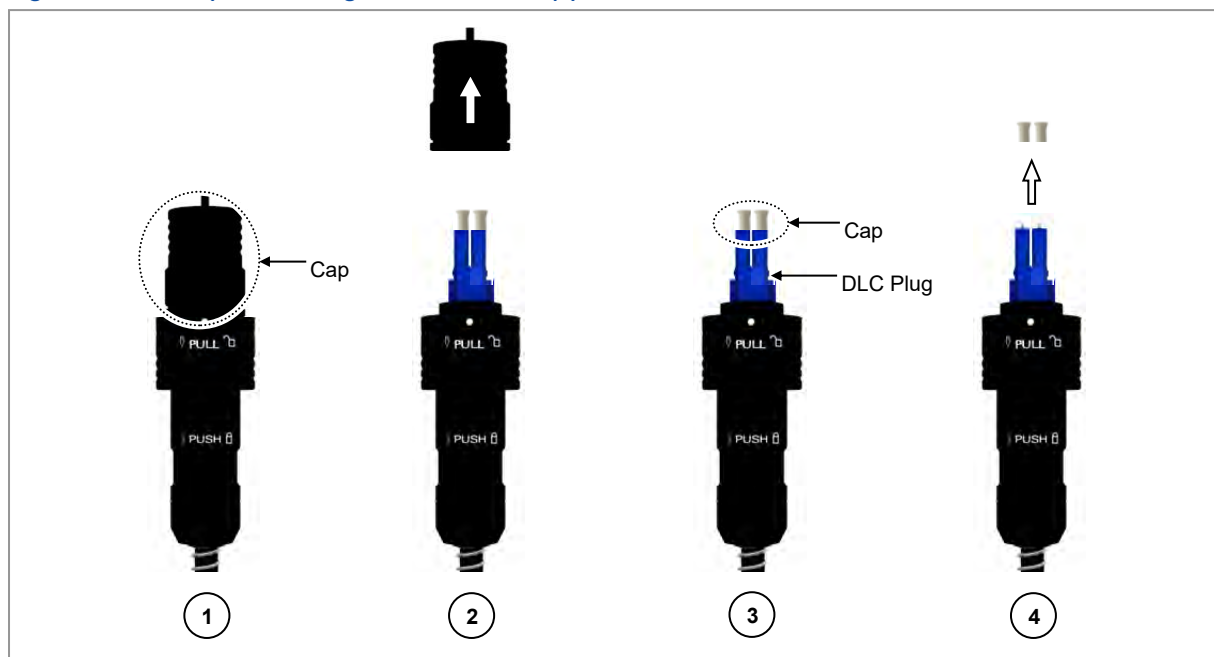

- 7 Insert the DLC plug to the system side's connector.
- 8 Insert the connector aligning the cable side connector's white dot and system side connector's white dot. When inserting the connector, push the shell to upper side.



Before connecting the backhaul cable connector, the ferrule of the connector of cable side should be cleaned first by using the optical connector cleaner. (Appendix for more information.)

Figure 69. Case#1) Connecting Backhaul Cable (4)

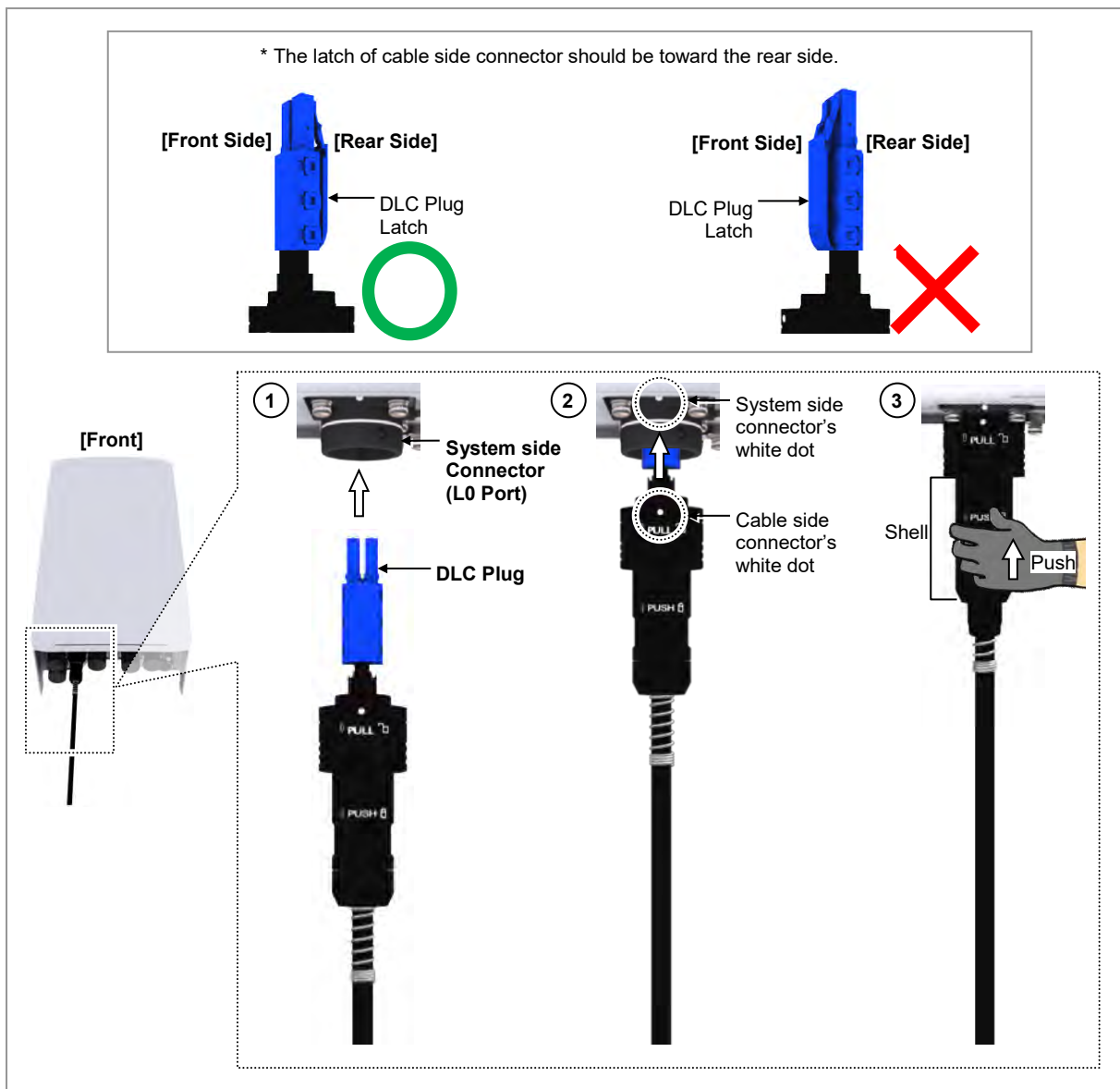

When the connector is fastened tight, the white line on the system side connector becomes invisible (or hidden).

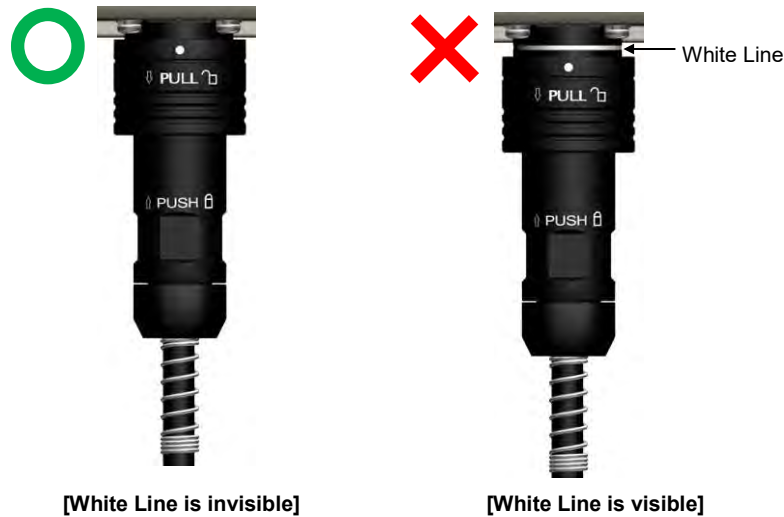

The method for connecting or disconnecting the backhaul connector is as follows:

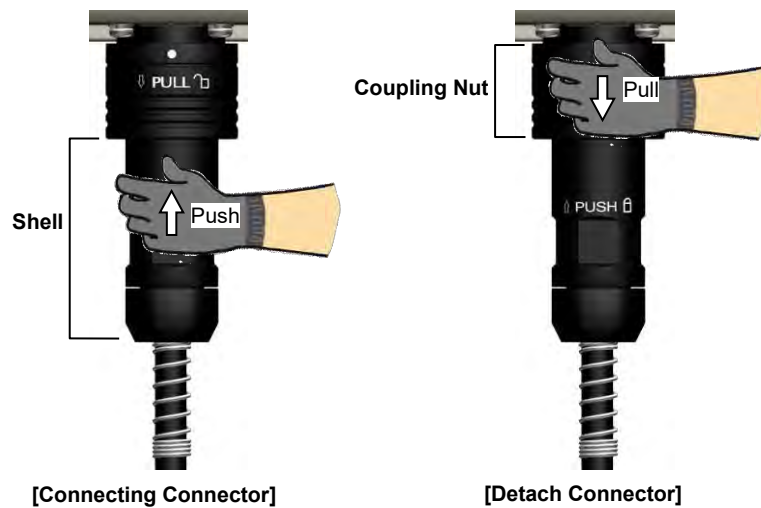

- For connecting the connector, push the shell to upper side.
- For disconnecting the connector, pull the coupling nut to lower side.



▶ Case#2) Connecting Backhaul Cable_Cascade: AU L1 Port to other AU

Table 24. Case#2) Parts and Tools for connecting Backhaul Cable_Cascade

Category	Description	
Installation Section	AU L1 Port to other AU	
Cable	Single Mode (Optical, Outdoor Type)	
Bending Radius	Operation: 10 × OD	Installation: 20 × OD
Connector	AU	JONHON, PDLC03T05 (DLC/UPC)
	other AU	JONHON, PDLC03T05 (DLC/UPC)
Working Tools	<ul style="list-style-type: none"> • Optical Connector Cleaner • SFP Tool (Jig) 	

Category	Description
 <p data-bbox="320 389 419 416">[AU Side]</p>	 <p data-bbox="1203 389 1362 416">[other AU Side]</p>



In the system, the laser beam light runs through the optical cable. The exposure of the laser beam on worker's eye may cause serious injury so that it should be handled with care.



Remove the cap of the optical connector before connecting.

- Before connecting the optical cable, check if the ferrule of the connector is soiled. Be careful to keep the cutting section away from dust or foreign material. If the cable is soiled with foreign material, do not blow to remove them.
- Make sure to clean the connector in accordance with the cleaning directions in Annex.
- Do not touch the ferrule at the end of optical cable because it is easy to be damaged.

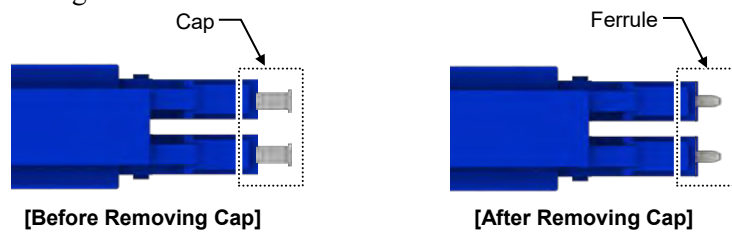

Before connecting the backhaul cable connector, the ferrule of the connector of cable side should be cleaned first by using the optical connector cleaner. (Appendix for more information.)

- 1 Install the backhaul cable from the AU L1 port to the other AU.

Figure 70. Case#2) Connecting Backhaul Cable_Cascade (1)

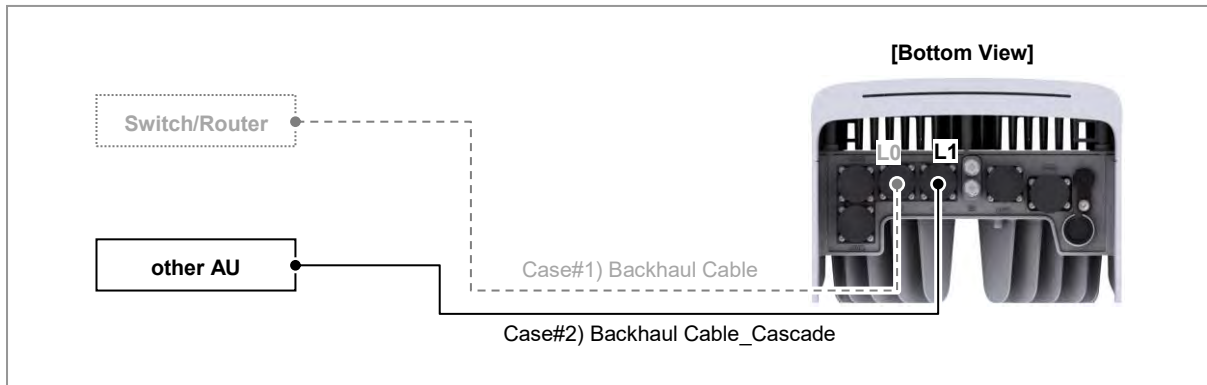

- 2 Separate the cap from the system side connector (L1 port).

Figure 71. Case#2) Connecting Backhaul Cable_Cascade (2)

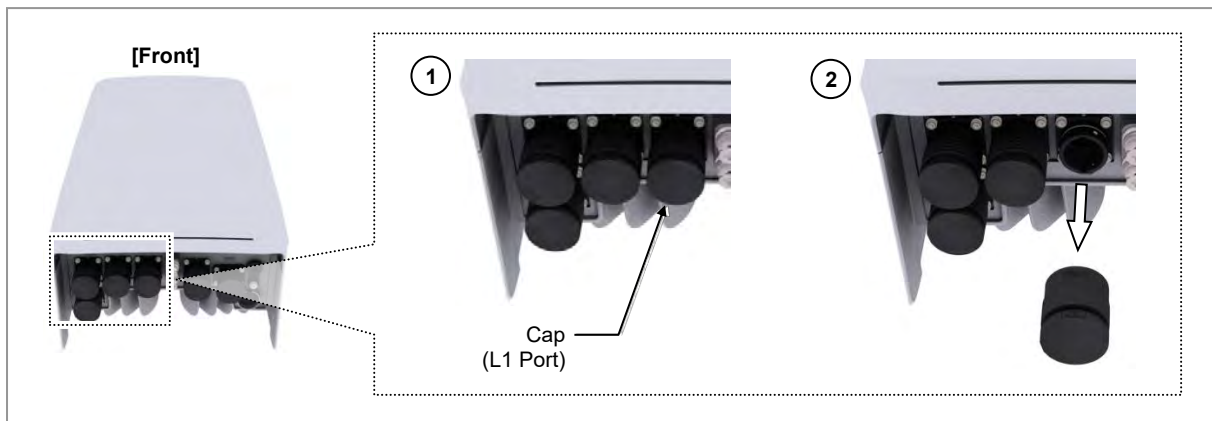

- 3 Separate the cap from the cable side connector.

Figure 72. Case#2) Connecting Backhaul Cable_Cascade (3)

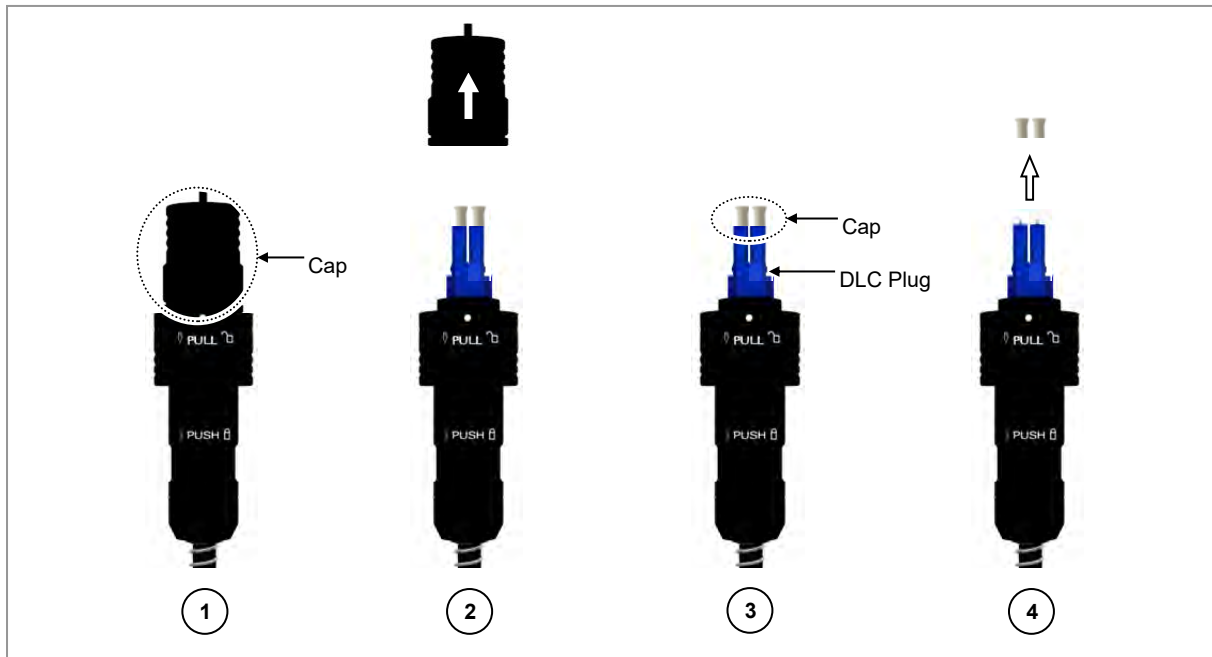

- 4 Insert the PDLC plug to the system side's connector.
- 5 Insert the connector aligning the cable side connector's white dot and system side connector's white dot. When inserting the connector, push the shell to upper side.



Before connecting the backhaul cable connector, the ferrule of the connector of cable side should be cleaned first by using the optical connector cleaner. (Appendix for more information.)

Figure 73. Case#2) Connecting Backhaul Cable_Cascade (4)

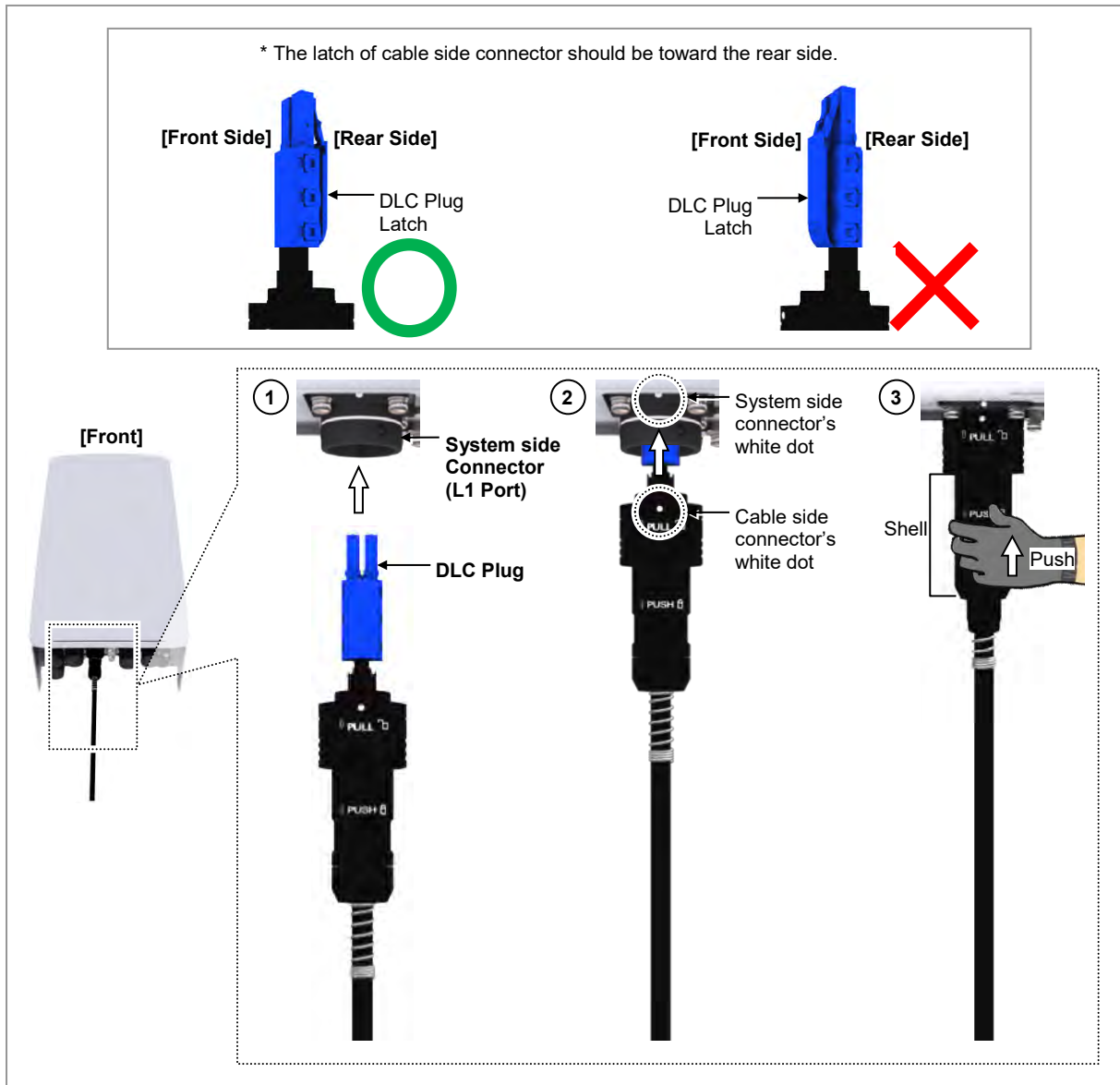

When the connector is fastened tight, the white line on the system side connector becomes invisible (or hidden).

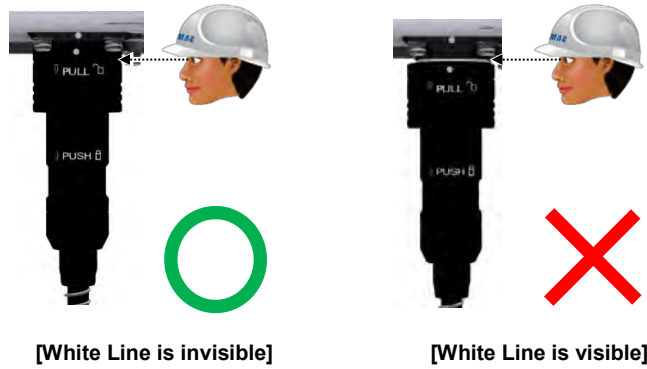

The method for connecting or disconnecting the backhaul connector is as follows:
 - For connecting the connector, push the shell to upper side.
 - For disconnecting the connector, pull the coupling nut to lower side.

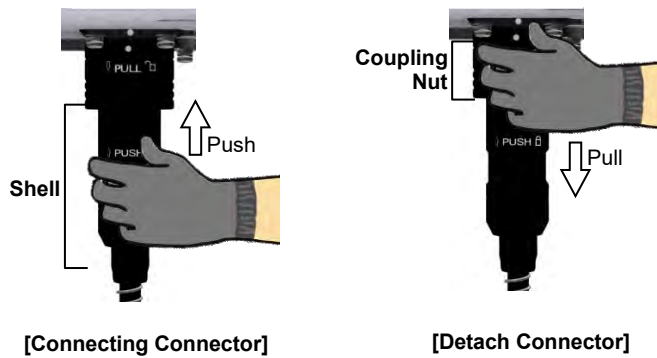

▶ Remove Backhaul cable:

Table 25. Parts and Tools for Remove Backhaul Cable

Category	Description
Working Tools	<ul style="list-style-type: none"> • Nipper • Screw Driver (-)

- 1 To disconnect the cable from the system, pull the backhaul connector coupling nut to the bottom.
- 2 Unlock the latch of the DLC plug by hand or using a screwdriver (-) and then remove the cable.

Figure 74. Remove Backhaul Cable (1)

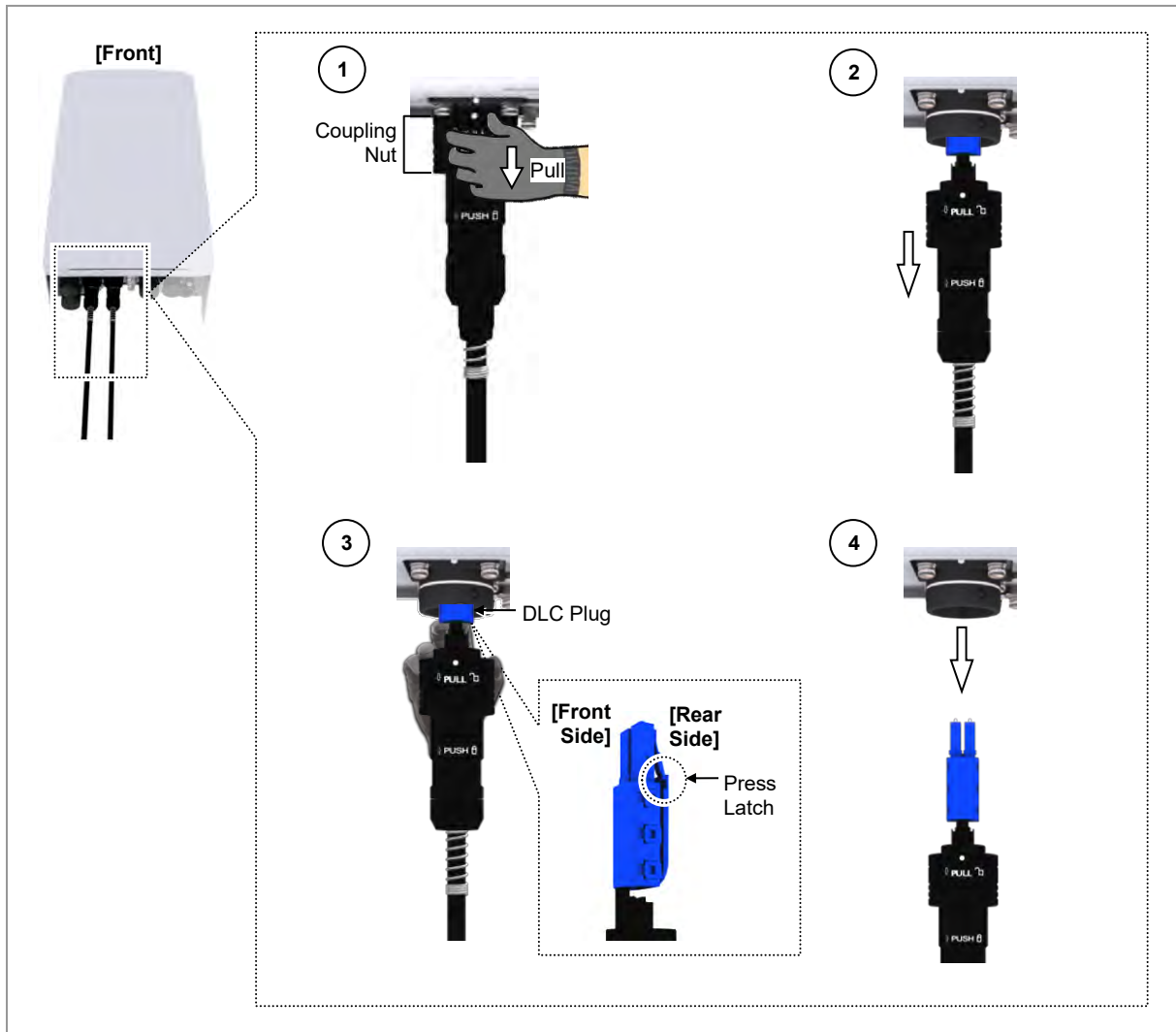

- 3 Fit the cap on the separated backhaul cable connector and the system connector.

Figure 75. Remove Backhaul Cable (2)

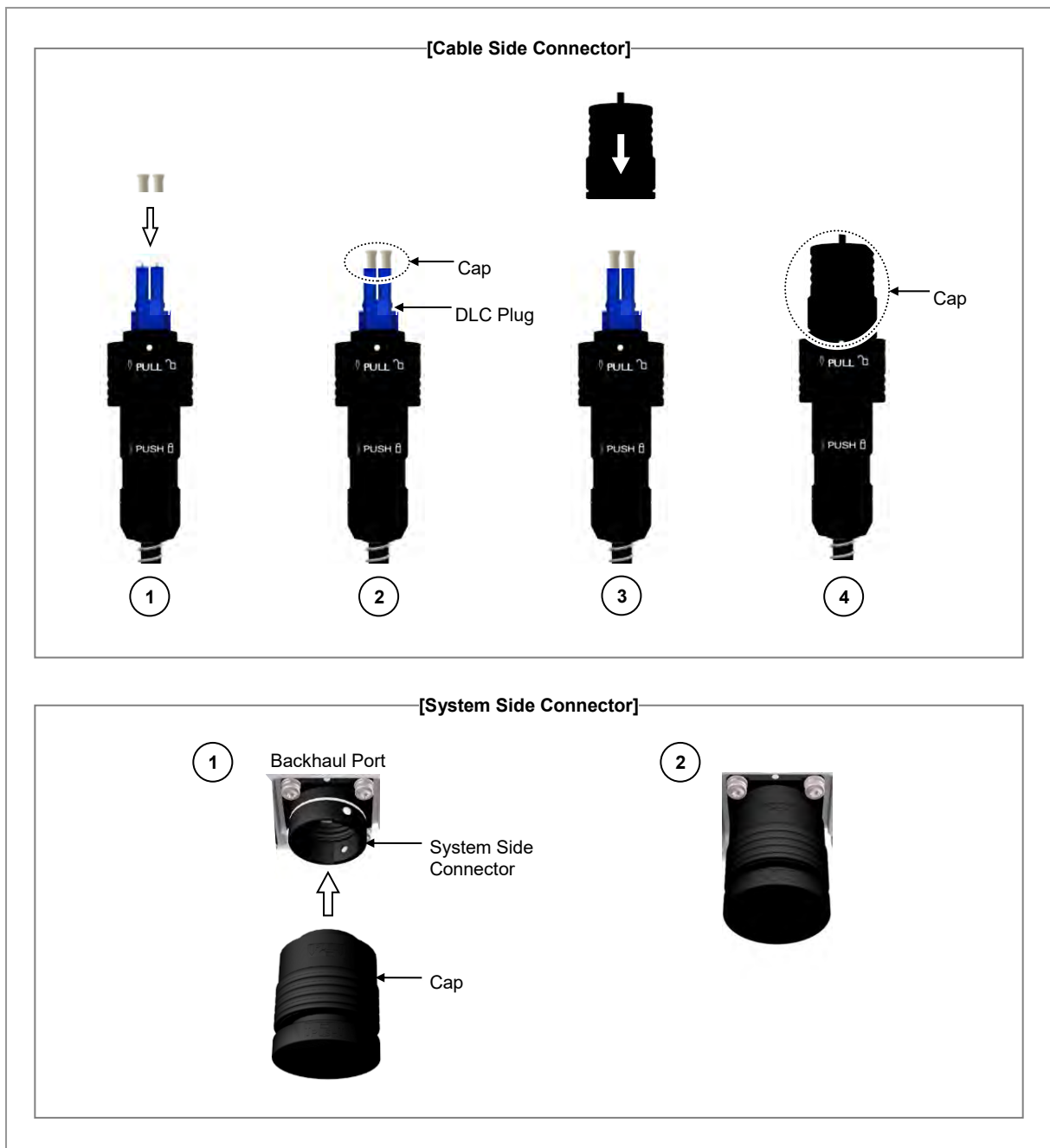

-  1) When removing the backhaul cable, be sure to release the lock by pressing the latch of the DLC plug first.

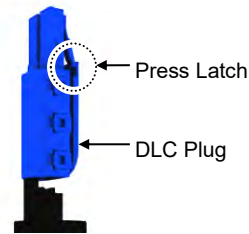

2) Avoid touching the ferrule (white part) at the end of the connector as it can be easily damaged. It must be sealed using the cap.

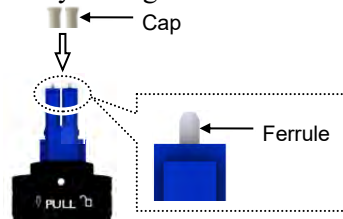

3) When removing or storing the cable, be sure to keep it at no less than its minimum bending radius and free of damage caused by other objects.

- Bending radius: $10 \times OD$

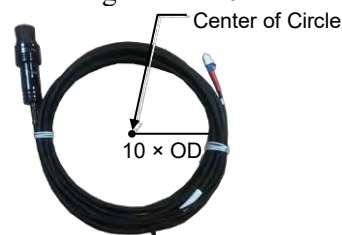

Connecting UDA Cable



To connect a UDA cable, do the following:

Prerequisites

Before proceeding with connecting the UDA cable, make sure that you have the items mentioned in the table below:

Table 26. Parts and Tools for Connecting UDA Cable

Category	Description	
Installation Section	External alarm device to AU UDA Port	
Cable	UDA Cable Assembly (SFTP, 24 AWG, 8C for Outdoor Type)	
Bending Radius	$5 \times OD$	
Connector	External alarm device	Check specifications of external device output terminal per site and prepare fasteners.
	AU	JONHON, Push Pull Type, RJ45MF-CT-07
Working Tools	<ul style="list-style-type: none"> • Cable Cutter • Wire Stripper • Nipper • LAN Tool 	

Category	Description
	
[AU Side]	[External Alarm Device Side]

The table below outlines the UDA cable pin map:

Table 27. UDA Cable Pin Map

System Side	Color Map	Description
1	White/Blue	UDA3_RTN
2	Blue	UDA3
3	White/Orange	UDA2_RTN
6	Orange	UDA2
4	White/Green	UDA1_RTN
5	Green	UDA1
7	White/Brown	UDA0_RTN
8	Brown	UDA0

- 1 Install the UDA cable from the external alarm device to the AU.

Figure 76. Connecting UDA Cable (1)

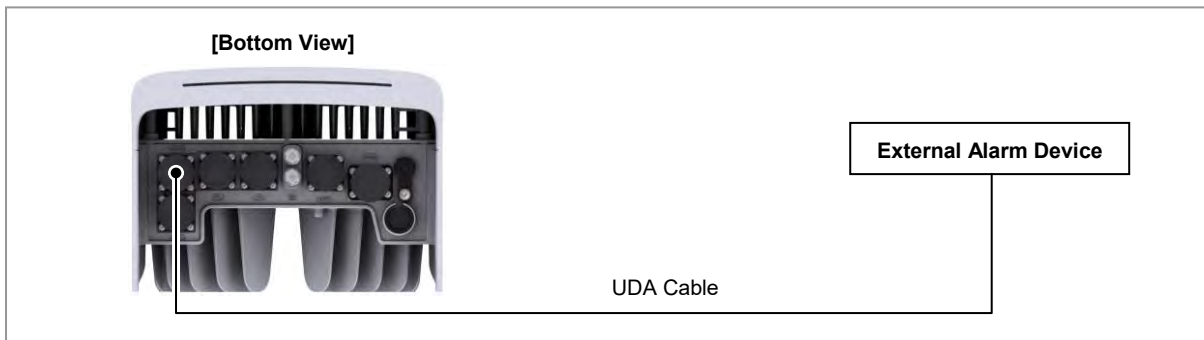

- 2 Separate the cap from the AU side and cable side connector.

Figure 77. Connecting UDA Cable (2)

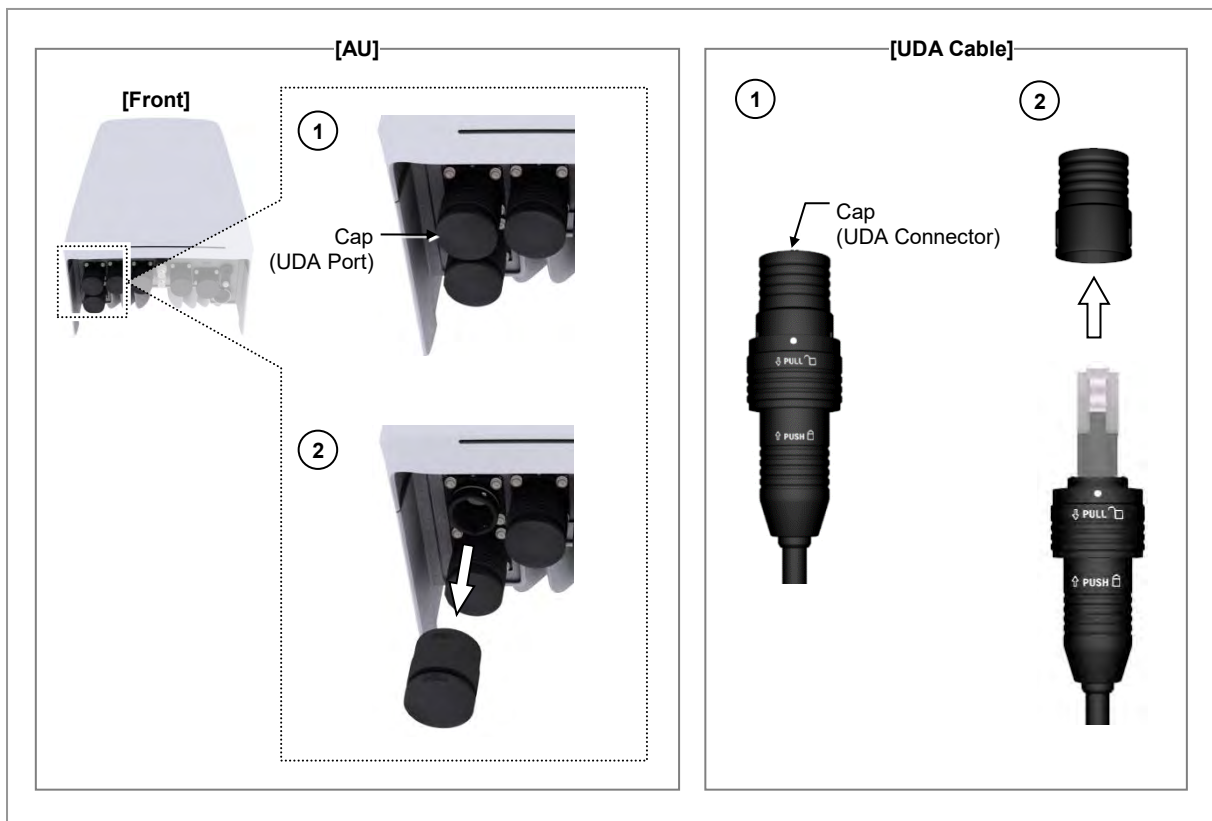

- 3 Insert the RJ-45 plug to the system side's connector.
- 4 Insert the connector aligning the cable side connector's white dot and system side connector's white dot. When inserting the connector, push the shell to upper side.

Figure 78. Connecting UDA Cable (3)

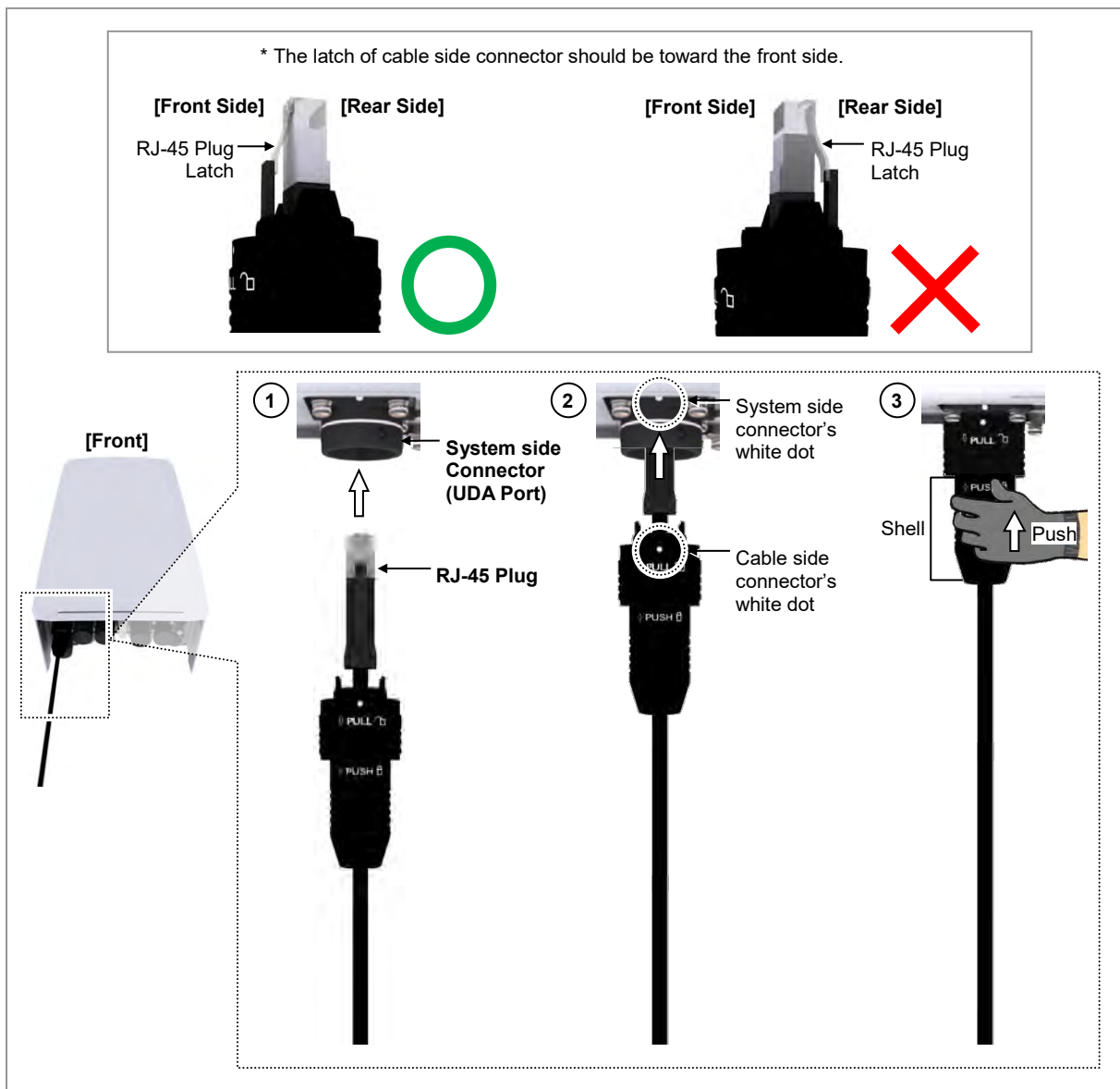

▶ Remove UDA cable:

Table 28. Parts and Tools for Remove UDA Cable

Category	Description
Working Tools	<ul style="list-style-type: none"> • Nipper • Screw Driver (-)

- 1 To disconnect the cable from the system, pull the UDA connector coupling nut to the bottom.
- 2 Unlock the latch of the RJ-45 plug using your hand or a screwdriver (-) and then remove the cable.

Figure 79. Remove UDA Cable (1)

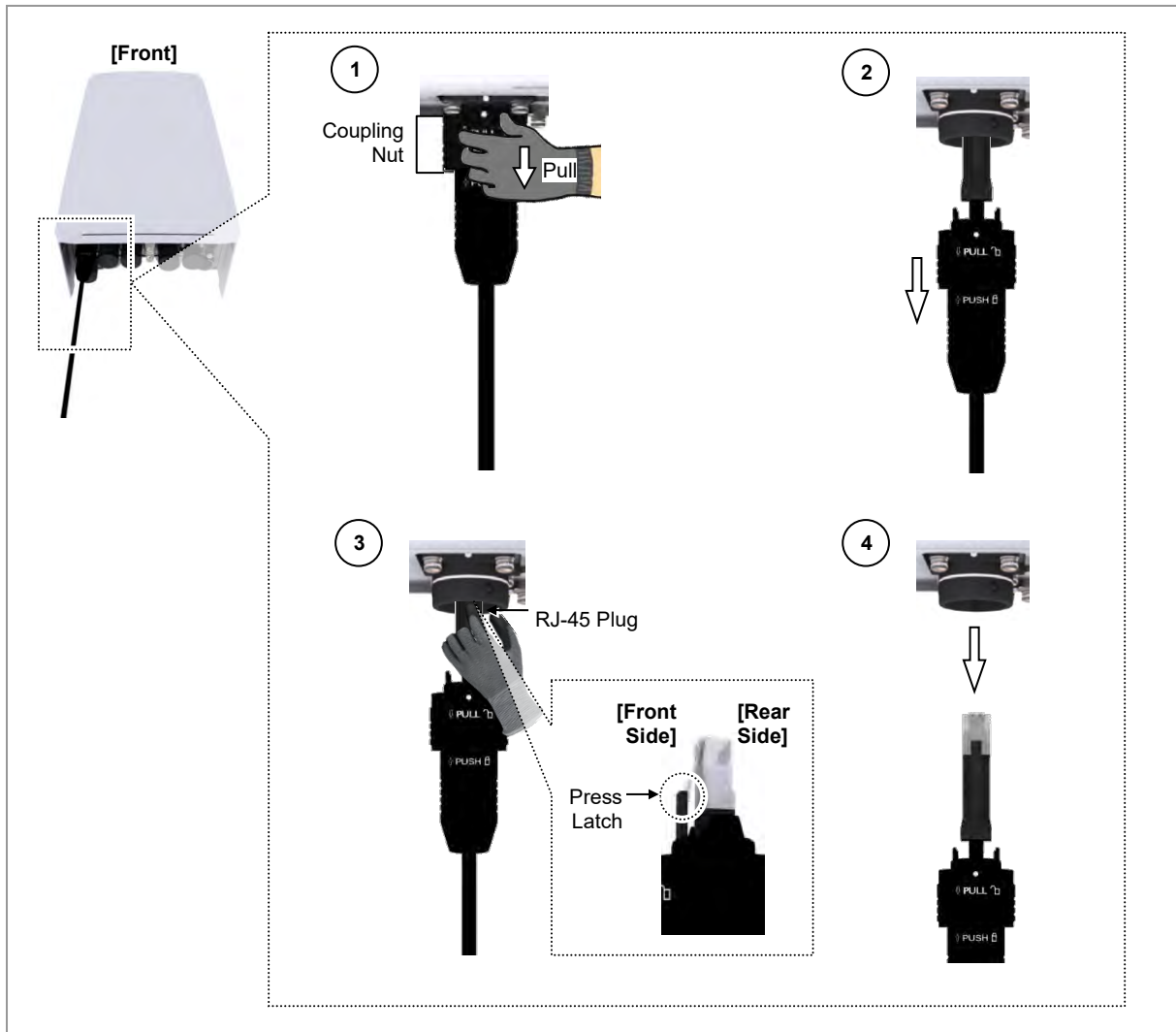

3 Fit the cap on the separated UDA cable connector and the system connector.

Figure 80. Remove UDA Cable (2)



- 1) When removing the UDA cable, be sure to release the lock by pressing the latch of the RJ-45 plug.

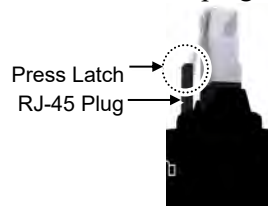

- 2) Once the cable has been removed, it must be sealed using the cap.
- 3) When removing or storing the cable, be sure to keep it at no less than its

minimum bending radius and free of damage caused by other objects.

- Bending radius: $5 \times OD$

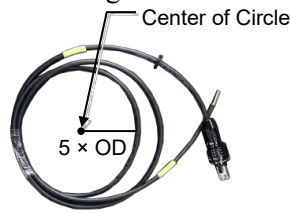

GPS Cable Connection

To connect GPS antenna (Direct Installation)

To connect a GPS antenna, do the following:

Prerequisites

Before proceeding with connecting the GPS antenna, make sure that you have the items mentioned in the table below:

Table 29. Parts and Tools for GPS Antenna (Direct Installation)

Category	Description	
Installation Section	GPS Antenna to AU GPS Port	
Connector	AU	4.3-10 Female
	GPS Antenna	4.3-10 Male
Recommended Torque Value	4.3-10 Male	44 lbf·in
Working Tool	<ul style="list-style-type: none"> • Torque Wrench (10 to 50 lbf·in.) • Torque Wrench Spanner head (Hex. Head: 22 mm) • Spanner (Hex. Head: 22 mm) 	

- 1 Separate the cap from the AU side connector.
- 2 Place GPS antenna 4.3-10 male port to 4.3-10 female port of AU, and turn clockwise direction for fixing.

Figure 81. GPS Antenna Connection_Direct Installation (1)

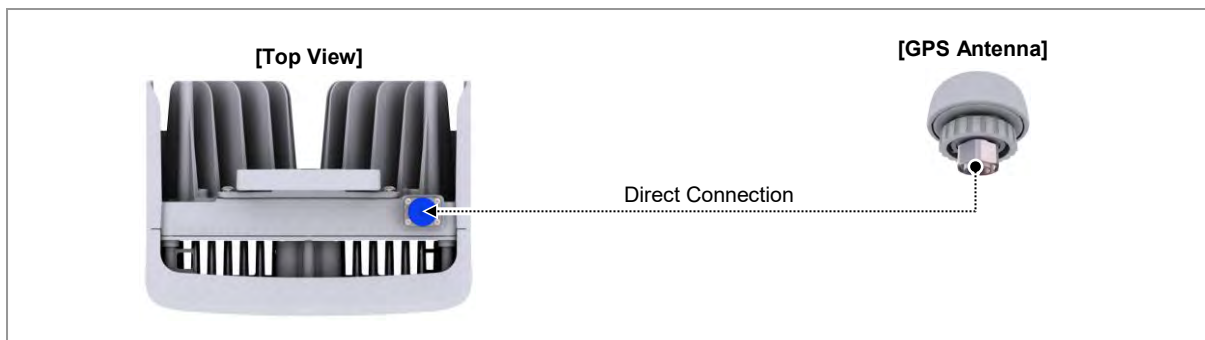
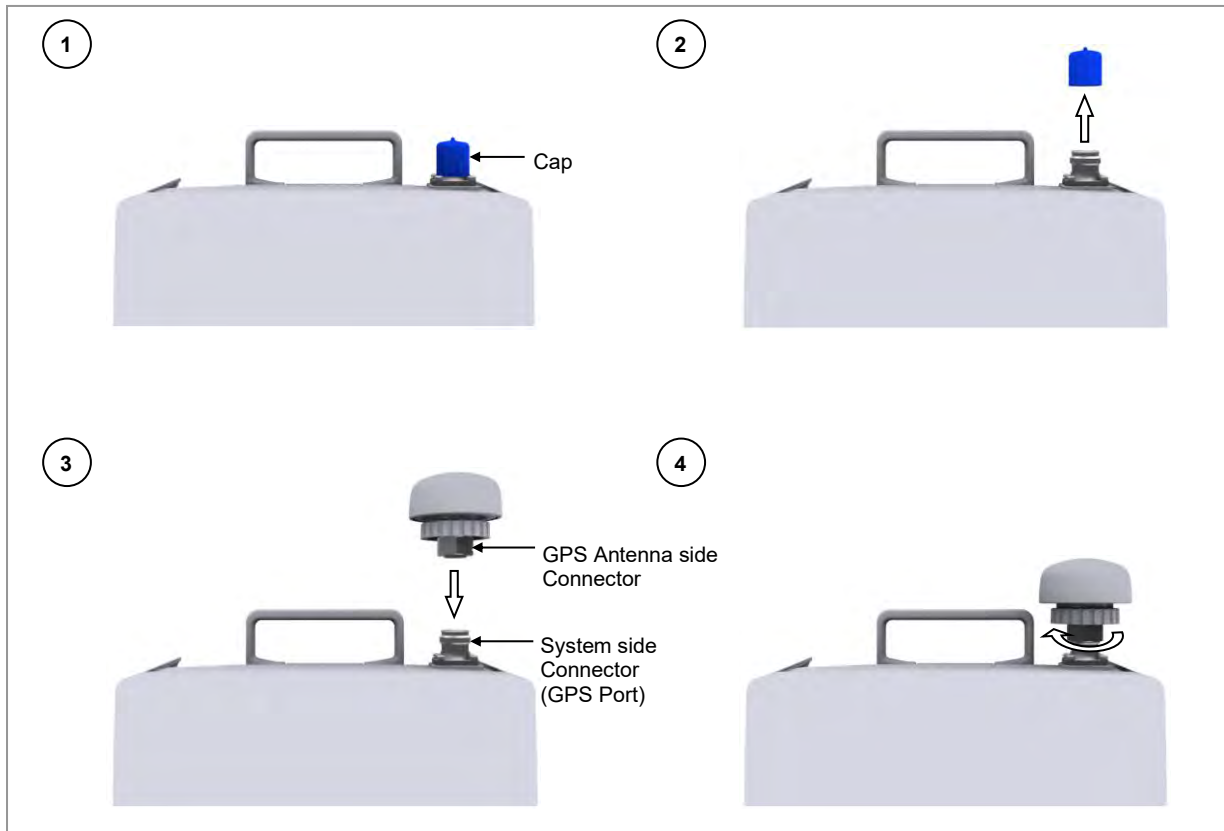

Figure 82. GPS Antenna Connection_Direct Installation (2)



Chapter 4 Inspect the Installation

This chapter describes the procedures to check installation status.

The figure below depicts the overall procedure for inspecting the installation status:

Figure 83. Installation Inspection Procedure

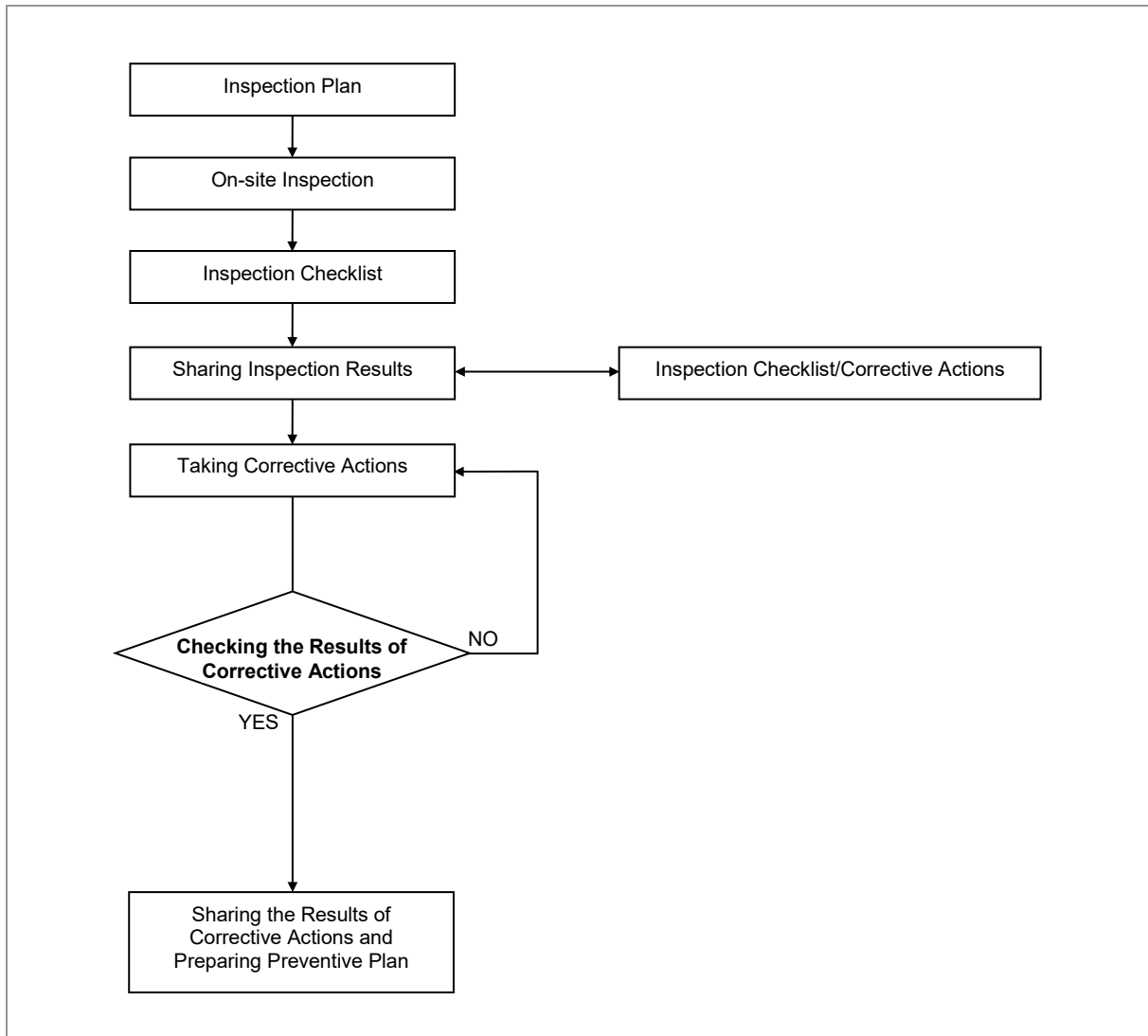

Inspection Plan

Create an inspection sheet per system and select an inspector to set an inspection schedule per site.

On-site Inspection and Inspection Checklist

The on-site inspection is to perform inspection visually or using instruments for each specification, standard, and installation status, based on the inspection checklist at the site where the system is installed.

The inspector must record the results onto the inspection checklist during or after field inspection.

Sharing Inspection Results and Taking Corrective Actions

The inspector must share the inspection results, inspection checklist and corrective actions, with an installation operator. The installation operator must take the corrective actions, if necessary, after reviewing the requirements.

Checking the Results of Corrective Actions

The inspector must check if the corrective actions are properly taken. If they are not sufficient, the inspector must ask the installation operator to take the corrective actions again.

Sharing the Results of Corrective Actions and Preparing Preventive Plan

After the corrective actions are all completed, the inspector must share the results with the installation operator and relevant departments. The inspector must prepare a preventive plan to avoid the reoccurrence of the similar problems.

Construction Situation Checklist

The table below outlines the checklist to inspect the installation of the AU and other devices.

Table 30. Construction Situation Checklist

Category	Check Items	Criteria	Result		
			Pass	Fail	
Installing Equipment	Appearance of equipment and mechanical parts	Equipment damage such as dent, scratch, and crack			
	Placement of equipment and mechanical parts	Maintenance and horizontal/vertical placement			
	Leveling condition of equipment and mechanical parts	Horizontal/vertical status			
	Validity of status and specifications of fastening bolt, nut, and washer		Checking fasteners omission		
			Compliance with assembly order of fasteners		
			Compliance with fastening torque value		
	Insulation status	Checking electrical contact between insulators (insulation resistance tester)			
Azimuth & Tilt	Checking the tilt result is right.				
Grounding	Installation of ground bar	Checking the separation of			

Category	Check Items	Criteria	Result	
			Pass	Fail
		communication/power/lightning grounding		
	Cable specification	Checking the specification		
	Cabling	Cable damage		
		Proper installation route		
		Compliance with the radius of curvature		
	Cable binding status	Binding status		
		Binding interval		
		Checking binding materials		
	Cable connection	Assembly condition of a pressure terminal		
		Fastening condition of a pressure terminal		
		Checking compliance with fastening torque value		
	Installation status of cable tag	Position		
		Marking content		
		Checking tag installation method		
	Power	Installation status of power supply	Power supply capacity	
Output voltage (tester)				
Installation of circuit breaker		Checking circuit breaker capacity		
Cable specification		Checking the specification		
		Checking the limit distance		
Cabling		Cable damage		
		Proper installation route		
		Compliance with the radius of curvature		
Cable binding status		Binding status		
		Binding interval		
		Checking binding materials		
Cable connection		Checking cable connection (Pin Map)		
		Input voltage		
		Assembly condition of a pressure terminal and connector		
		Fastening condition of a pressure terminal and connector		
	Checking compliance with fastening torque value			
Installation status of cable tag	Position			
	Marking content			
	Checking tag installation method			
Other data cables	Cable specification	Checking the specification		
	Cabling	Cable damage		

Category	Check Items	Criteria	Result	
			Pass	Fail
		Proper installation route		
		Compliance with the radius of curvature		
	Cable binding status	Binding status		
		Binding interval		
		Checking binding materials		
	Cable connection	Checking cable connection (Pin Map)		
		Assembly condition of a connector		
		Fastening condition of a connector		
		Checking compliance with fastening torque value		
	Installation status of cable tag	Position		
		Marking content		
		Checking tag installation method		
		Checking tag installation method		
	Others	Reserved ports	Checking port cap fastening status	
Cable inlet status/Connection of equipment I/O port		Checking fastening status (Conduit/Cable Gland)		
Cable tray and duct		Checking installation status		
Status of inside/outside of the equipment and system surrounding area		Checking the stocking condition (waste parts, waste materials, and packing materials)		
Opinion				



Appendix A Acronyms

AC	Alternating Current
AU	Access Unit
DC	Direct Current
DL	Down Link
MGB	Main Ground Bar
NR	New Radio
RTN	Return
SELV	Safe Extra Low Voltage
SEMS	pre-asSEMBled washers and screws
S-FTP	Screened-Foiled Twisted Pair
UL	UpLink

Appendix B GPS Antenna Installation

GPS Antenna System Configuration

The GPS antenna system is commonly configured as shown below:

Table 31. GPS Antenna system Configuration

Category	Description
GPS Antenna	Device receiving a signal from a GPS satellite
GPS Line amplifier (Option)	Device amplifying the GPS signal received from the GPS antenna (used to compensate the GPS signal loss caused by GPS antenna, GPS arrester, cable and connector)
GPS (Lightning) Arrester	Device protecting people or system from lightning

Figure 84. Example of a Common GPS Antenna System Configuration

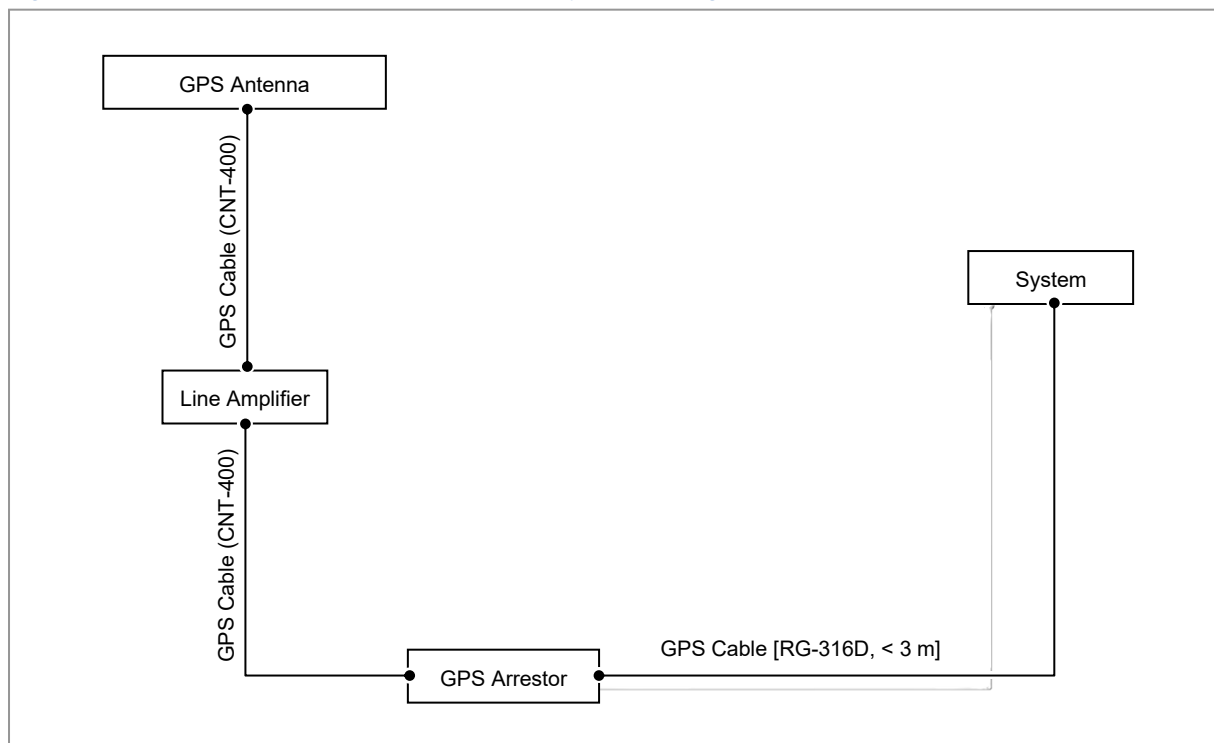

To satisfy the GPS specifications and operate the GPS antenna in a stable manner, the following GPS antenna configuration and installation requirements must be met.

Requirements

To satisfy the GPS specifications and operate the GPS antenna in a stable manner, the following GPS antenna configuration and installation requirements must be met:

- The GPS antenna must be installed in a location where it has the maximum amount of open sky. The ideal position is one where there are no obstacles that interfere with the antenna within 10 degrees or more of the horizon (the Elevation Angle). This allows the GPS receiver to select the best combination or distribution of GPS satellites which gives optimal performance.
- The GPS antenna installation location must avoid the following:
 - The effect of any obstacle or building that interferes with the reception of GPS signals or causes multi-path.
 - The interference of RF signal that is transmitted/received at any surrounding RF antenna (including steel-Columned structure for RF antenna) or microwave signal.
 - Any damage from lightning within the coverage area of a lightning rod.



If a GPS antenna is influenced by external interference signals or multi-paths at a certain place, it is best to re-install the antenna at another place. Anti-jamming GPS antenna is recommended if it is not possible to change the location of the antenna.

- To ensure the GPS receiver works properly, it is recommended you install one GPS antenna per GPS receiver. It is also recommended that you do not use a GPS-specific splitter unless absolutely necessary.
- For the GPS receiver to operate at its best, there must always be six GPS satellites with a healthy status, that is, there is no obstacle directly between it and the GPS antenna.
- When installing the GPS antenna using a steel cylinder structure shared by other RF antennas, it must be separated by more than 1~1.5 m from that steel structure.
- The GPS antenna must be installed in a place lower than the lightning rod and RF antenna, and must not be installed within a steel tower to avoid lightning current flows into the GPS antenna.
- When you install the antenna, the antenna must be within the protective angle (left/right side 45° each from the central axis) of the lightning rod to protect the antenna from lightning damage.

Figure 85. GPS Antenna Installation

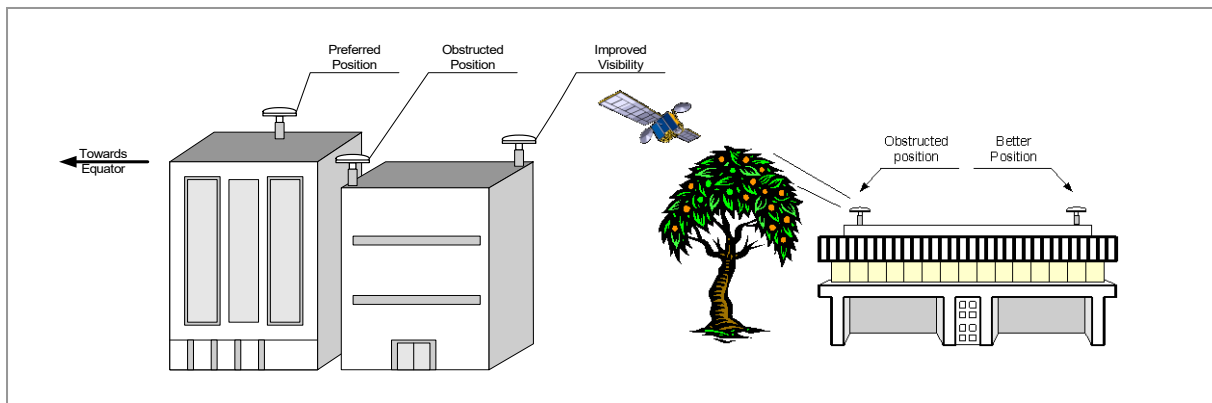

Lightning Arrestor

A lightning arrestor is required when there is a danger of lightning striking a cable or related part. The lightning arrestor must be installed in a place where the antenna cable or set of combined cables enters a building or station, or a place inside the building or station. The purpose of this is to protect the people and equipment inside the building or station.

A lightning arrestor must be grounded to the earth separately with lightning protection grounding in order to work properly.

If struck directly by lightning, the lightning arrestor, antenna, or cable must be replaced. Furthermore, you must inspect the lightning arrestor periodically, and replace the antenna and cable periodically to ensure protection if lightning occurs frequently at the site.

The lightning arrestor must be well grounded so that it can transmit a large current quickly.

Interference Signal

The GPS system is designed so that it has a strong immunity to noise and can endure interference.

The Samsung GPS receiver provides a quality timing clock in most installations.

However, to ensure that the GPS receiver performs locking successfully and guarantees uninterrupted timing performance, an interference-free environment is required for frequencies near the GPS L1 frequency (1575.42 ± 1 MHz).

Interference Types

There are two types of interference which affect the GPS L1 frequency.

- **Narrow band (inband) interference:** When a frequency deviation (3.5 kHz), such as an FM wave, inflows around the GPS L1 frequency (1575.42 MHz).

Narrow band interference is monitored by the spectrum analyzer. But because it has a time lag, a locking failure or a different type of alarm can occur.

- **Wideband interference:** When frequency deviation is more than 7 kHz around the GPS L1 frequency (1575.42 MHz).

Wideband interference includes the interference induced by the harmonics from a communication service with a different frequency bandwidth, increased thermal noise from communication services around the L1 band, inflow of interference due to unauthorized communication, saturation due to oscillation of an accessory device, and so on.

You cannot monitor these kinds of interference with a device such as a spectrum analyzer. If the system has a wideband interference problem, you should consult an expert in this area.

For bandwidths other than the GPS L1 frequency (1575.42 ± 1 MHz), a GPS Band Pass Filter (BPF) must be included within the GPS antenna to remove the interference from the GPS bandwidth. No outband interference must affect the GPS signals.

Avoiding Interference

If more than one antenna for other communications is installed in the surrounding area, such as an antenna for a base station or satellite communication, the GPS antenna must be installed in a location where no interference signals flow.

If interference exists within the GPS L1 frequency bandwidths (1575.42 ± 1 MHz), use a band pass filter (BPF) to prevent interference from affecting the GPS bandwidth.

Furthermore, if the GPS antenna is installed by a transmitter which operates with a bandwidth similar to the GPS L1 frequency, the possibility of interference increases (in this case, interference is caused by harmonics). If the GPS antenna has a problem due to interference, move it to a different location where interference signals can be avoided or minimized.

Inband noise includes narrow band noise and wide band noise that occur in an inband width. (L1, 1575.42 ± 1 MHz)

- Narrow band noise in an inband width: If it is higher than 108 dBm, it can affect the operation of the GPS receiver.
- Wideband noise in an inband width: It may not be detected by a measuring instrument and may impair the sensitivity of the GPS receiver, and thus affect its operation.

If there is an outband interference problem, reduce the effects of interference on the GPS receiver by applying one or more L1 GPS BPFs.

The filter should be installed at the following locations:

- The input connector of the Samsung GPS receiver
- Behind the antenna or the front end of a line amplifier

These filters are used to reject jamming tones for outband signals. If interferences occur in the inband signals, they will result in serious consequences.

GPS Antenna Installation

The GPS antenna can be fixed to a wall, floor, tower, or pole.

Ensure personal safety when fixing an anchor bolt to a wall and treat the anchor bolt fixing area with a silicon or waterproof finishing material.

 Install a concrete block that satisfies the specification regarding size and strength. When installing the concrete block, and before forming the concrete, arrange steel reinforcement bars in a mesh layout at 100 mm intervals. (Use either an anchor bolt assembly or a concrete anchor.)

 Install the antenna within the protective angle (left/right side 45° each from the central axis) to protect the antenna from lightning damage.

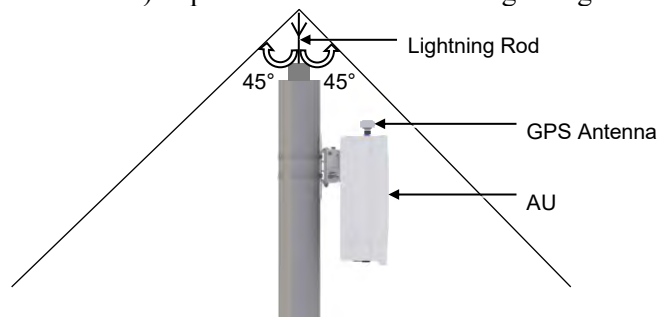

Appendix C Clean the Optical Connectors

This chapter describes the procedure to clean the MPO connector.

To clean the MPO connector, do the following:

Prerequisites

Before proceeding with cleaning the MPO connector, make sure that you have the items mentioned in the table below:

Table 32. MPO Connector Cleaning Tools

Category	Description
Working Tools	<ul style="list-style-type: none"> • MT ferrule cleaner (MT38II/US. Conec) • Cleaning Jig (Plug, Receptacle)

MPO Plug Side

- 1 Make the white key of the plug and groove of the jig at a straight line.

Figure 86. Cleaning MPO Connector_Plug side (1)

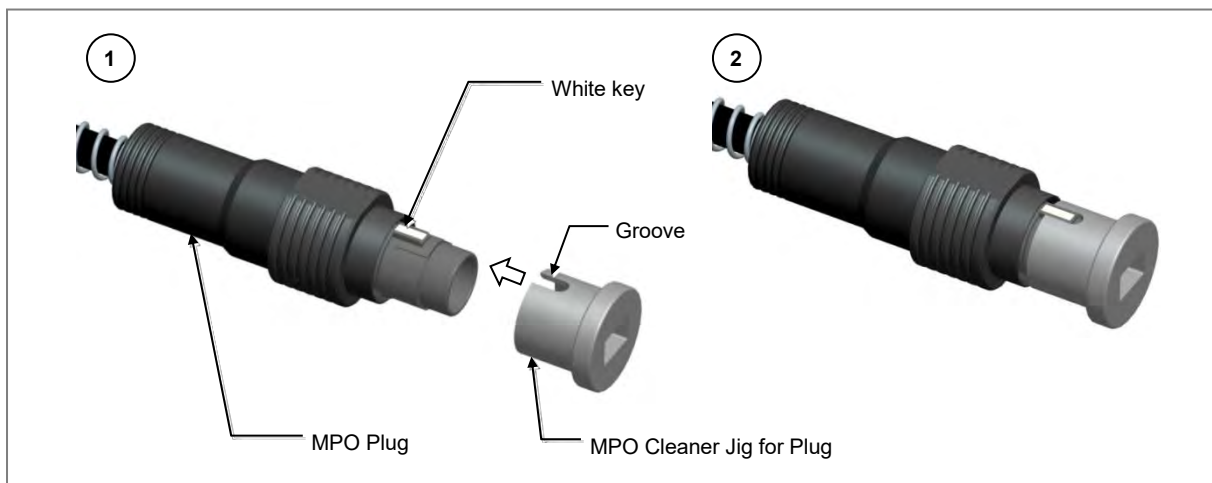

- 2 Use the cleaner to clean the MT ferrule of the plug.

Figure 87. Cleaning MPO Connector_Plug side (2)

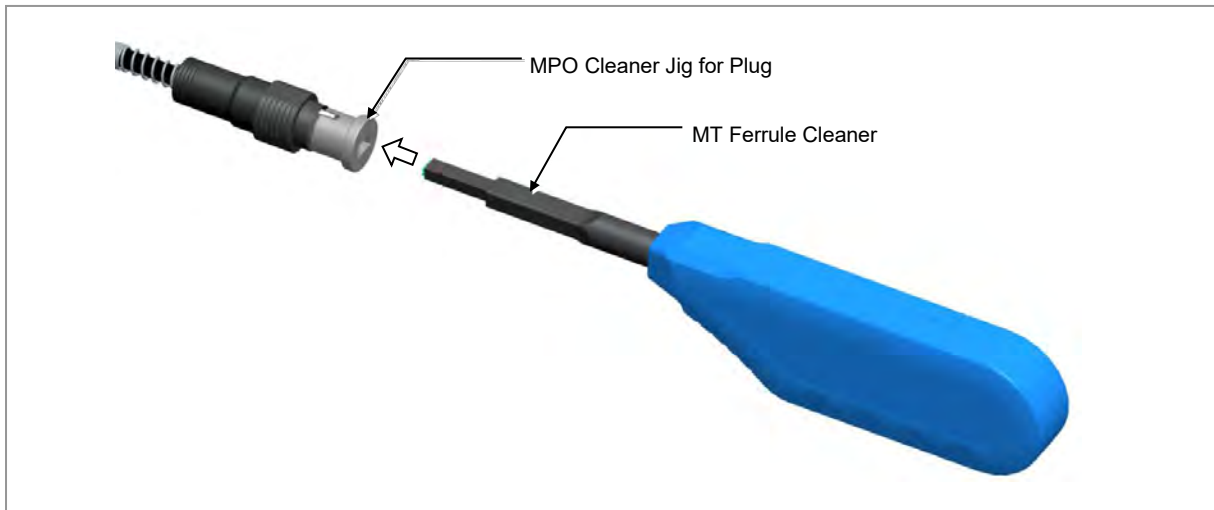

MPO Receptacle Side

- 1 Make the white dot of the receptacle and key of the jig at a straight line.

Figure 88. Cleaning MPO Connector_Receptacle side (1)

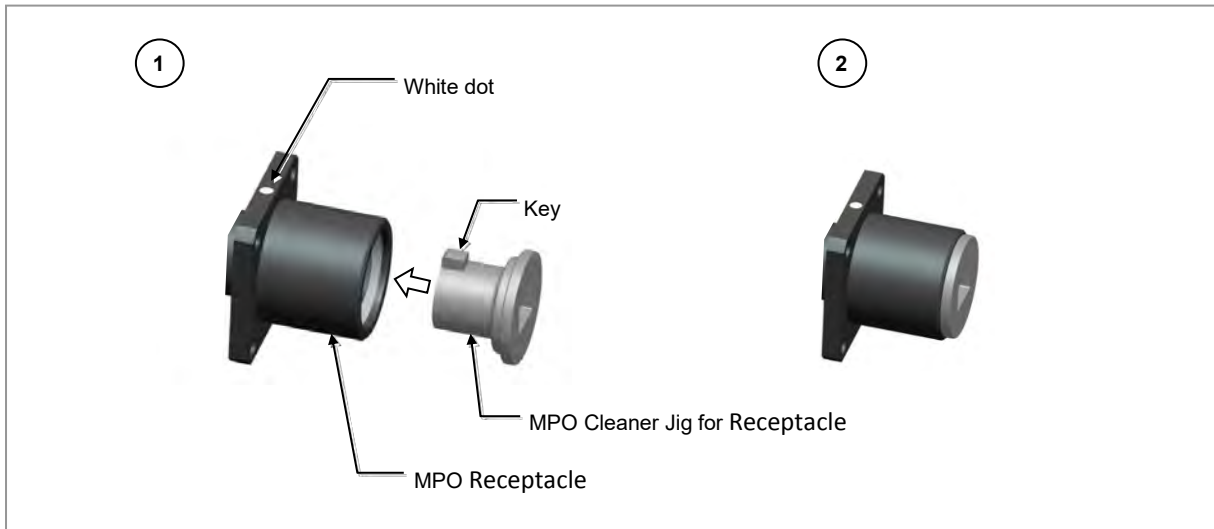

- 2 Use the cleaner to clean the MT ferrule of the receptacle.

Figure 89. Cleaning MPO Connector_Receptacle side (2)

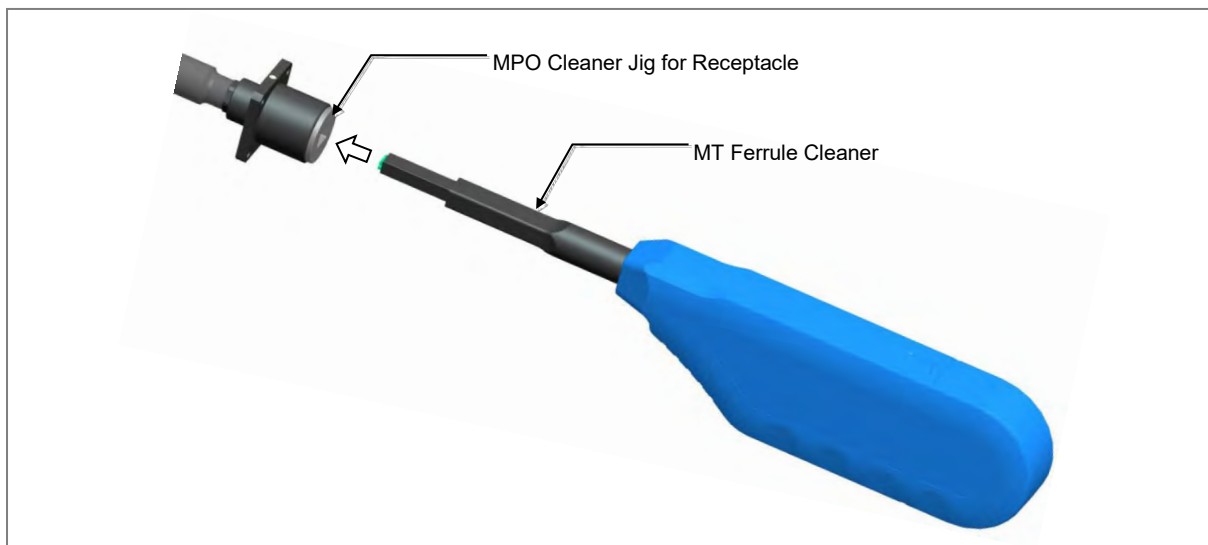

Appendix D Standard Torque

When fastening the bolt, use the standard torque values provided in tables below for tightening nuts and bolts to prevent damage to the equipment. If the torque value for each connection part is predefined, use the defined value.

Table 33. Standard Torque Value for Fastening Bolts

Bolt Spec.	Torque Value (N·m)	Torque Value (lbf-in)	Torque Value (kgf-cm)
M3	0.63	5.6	6.4
M4	1.5	13	15
M5	2.8	25	29
M6	4.9	43	50
M8	12	110	127
M10	25	217	250
M12	42	372	428

Table 34. Brass Bolts Torque Value

Bolt Spec.	Torque Value (N·m)	Torque Value (lbf-in)	Torque Value (kgf-cm)
M6	2.9	26	30
M8	6.3	56	64

Table 35. Connector Connection Torque Value

Connector	Torque Value (N·m)	Torque Value (lbf-in)	Torque Value (kgf-cm)
SMA connector	0.59	5.2	6
TNC connector	0.88	7.8	9
N-type connector	2	17	20
DIN-type connector	25	217	250
4.3-10-type connector	5	44	51



The torque values can be different, depending on the material, characteristic, and specification of the equipment and fastener. Ensure that you check the proper torque value for each specification of the equipment and the fastener.

**AT1K01 Series
Installation Manual**

Document Version 2.0

© 2019 Samsung Electronics Co., Ltd.
All rights reserved.