



FCC TEST REPORT (15.407)

REPORT NO.: RF980609H02A-1

MODEL NO.: WIS10ABGN

RECEIVED: Sep. 10, 2009

TESTED: Dec. 25, 2009 to Jan. 13, 2010

ISSUED: Jan. 15, 2010

APPLICANT: Samsung Electronics CO. LTD

ADDRESS: 416, Maetan-3Dong, Yeongtong-Gu
Suwon-City, Gyeonggi-Do, 443-742, Korea

ISSUED BY: Bureau Veritas Consumer Products Services (H.K.)
Ltd., Taoyuan Branch Hsin Chu Laboratory

ADDRESS: No. 81-1, Lu Liao Keng, 9th Ling, Wu Lung Tsuen,
Chiung Lin Hsiang, Hsin Chu Hsien 307, Taiwan

This test report consists of 129 pages in total. It may be duplicated completely for legal use with the approval of the applicant. It should not be reproduced except in full, without the written approval of our laboratory. The client should not use it to claim product endorsement by TAF or any government agencies. The test results in the report only apply to the tested sample.





Table of Contents

1.	CERTIFICATION	4
2.	SUMMARY OF TEST RESULTS	5
2.1	MEASUREMENT UNCERTAINTY.....	6
3.	GENERAL INFORMATION.....	7
3.1	GENERAL DESCRIPTION OF EUT	7
3.2	DESCRIPTION OF TEST MODES	10
3.2.1	TEST MODE APPLICABILITY AND TESTED CHANNEL DETAIL:	12
3.3	GENERAL DESCRIPTION OF APPLIED STANDARDS	15
3.4	DESCRIPTION OF SUPPORT UNITS.....	16
3.5	CONFIGURATION OF SYSTEM UNDER TEST.....	16
4.	TEST TYPES AND RESULTS	17
4.1	CONDUCTED EMISSION MEASUREMENT.....	17
4.1.1	LIMITS OF CONDUCTED EMISSION MEASUREMENT	17
4.1.2	TEST INSTRUMENTS	17
4.1.3	TEST PROCEDURES.....	18
4.1.4	DEVIATION FROM TEST STANDARD	18
4.1.5	TEST SETUP	19
4.1.6	EUT OPERATING CONDITIONS	19
4.1.7	TEST RESULTS	20
4.2	RADIATED EMISSION MEASUREMENT	22
4.2.1	LIMITS OF RADIATED EMISSION MEASUREMENT	22
4.2.2	LIMITS OF UNWANTED EMISSION OUT OF THE RESTRICTED BANDS.....	23
4.2.3	TEST INSTRUMENTS	24
4.2.4	TEST PROCEDURES.....	25
4.2.5	DEVIATION FROM TEST STANDARD	25
4.2.6	TEST SETUP	26
4.2.7	EUT OPERATING CONDITION.....	26
4.2.8	TEST RESULTS	27
4.3	PEAK TRANSMIT POWER MEASUREMENT.....	71
4.3.1	LIMITS OF PEAK TRANSMIT POWER MEASUREMENT	71
4.3.2	TEST INSTRUMENTS	71
4.3.3	TEST PROCEDURE.....	72
4.3.4	DEVIATION FROM TEST STANDARD	72
4.3.5	TEST SETUP	72
4.3.6	EUT OPERATING CONDITIONS	72
4.3.7	TEST RESULTS	73
4.4	PEAK POWER EXCURSION MEASUREMENT.....	88
4.4.1	LIMITS OF PEAK POWER EXCURSION MEASUREMENT	88
4.4.2	TEST INSTRUMENTS	88



A D T

4.4.3	TEST PROCEDURE.....	89
4.4.4	DEVIATION FROM TEST STANDARD	89
4.4.5	TEST SETUP	89
4.4.6	EUT OPERATING CONDITIONS	89
4.4.7	TEST RESULTS	90
4.5	PEAK POWER SPECTRAL DENSITY MEASUREMENT.....	99
4.5.1	LIMITS OF PEAK POWER SPECTRAL DENSITY MEASUREMENT	99
4.5.2	TEST INSTRUMENTS	99
4.5.3	TEST PROCEDURES.....	100
4.5.4	DEVIATION FROM TEST STANDARD	100
4.5.5	TEST SETUP	100
4.5.6	EUT OPERATING CONDITIONS	100
4.5.7	TEST RESULTS	101
4.6	FREQUENCY STABILITY	110
4.6.1	LIMITS OF FREQUENCY STABILITY MEASUREMENT	110
4.6.2	TEST INSTRUMENTS	110
4.6.3	TEST PROCEDURE	110
4.6.4	DEVIATION FROM TEST STANDARD	111
4.6.5	TEST SETUP	111
4.6.6	EUT OPERATING CONDITION.....	111
4.6.7	TEST RESULTS	112
4.7	ANTENNA PORT OUTPUT SPECTRUM PLOTS.....	113
4.7.1	TEST INSTRUMENTS	113
4.7.2	TEST PROCEDURE	113
4.7.3	EUT OPERATING CONDITION.....	113
4.7.4	TEST RESULTS	114
5.	INFORMATION ON THE TESTING LABORATORIES	128
6.	APPENDIX-A- MODIFICATIONS RECORDERS FOR ENGINEERING CHANGES TO THE EUT BY THE LAB	129



A D T

1. CERTIFICATION

PRODUCT: Wireless LAN adapter
BRAND NAME: SAMSUNG
MODEL NO.: WIS10ABGN
TEST SAMPLE: MASS-PRODUCTION
TESTED: Dec. 25, 2009 to Jan. 13, 2010
APPLICANT: Samsung Electronics CO. LTD
STANDARDS: FCC Part 15, Subpart E (Section 15.407),
ANSI C63.4-2003

The above equipment (Model: WIS10ABGN) has been tested by **Bureau Veritas Consumer Products Services (H.K.) Ltd., Taoyuan Branch**, and found compliance with the requirement of the above standards. The test record, data evaluation & Equipment Under Test (EUT) configurations represented herein are true and accurate accounts of the measurements of the sample's EMC characteristics under the conditions specified in this report.

PREPARED BY : Carol Liao , **DATE:** Jan. 15, 2010
(Carol Liao, Specialist)

TECHNICAL ACCEPTANCE : Hank Chung , **DATE:** Jan. 15, 2010
(Hank Chung, Deputy Manager)

APPROVED BY : May Chen , **DATE:** Jan. 15, 2010
(May Chen, Deputy Manager)



A D T

2. SUMMARY OF TEST RESULTS

The EUT has been tested according to the following specifications:

For 802.11a

APPLIED STANDARD: FCC Part 15, Subpart E (Section 15.407)			
Standard Section	Test Type	Result	Remark
15.407(b)(5)	AC Power Conducted Emission	PASS	Meet the requirement of limit. Minimum passing margin is -9.63dB at 1.770MHz
15.407(b/1/2/3) (b)(5)	Electric Field Strength Spurious Emissions, 30MHz ~ 40000MHz	PASS	Meet the requirement of limit. Minimum passing margin is -0.6dB at 5470.0MHz and 5725.0MHz
15.407(a/1/2/3)	Peak Transmit Power	PASS	Meet the requirement of limit.
15.407(a)(6)	Peak Power Excursion	PASS	Meet the requirement of limit.
15.407(a/1/2/3)	Peak Power Spectral Density	PASS	Meet the requirement of limit.
15.407(g)	Frequency Stability	PASS	Meet the requirement of limit.
15.203	Antenna Requirement	PASS	No antenna connector is used.

NOTE:

1. The EUT was operating in 2400 ~ 2483.5MHz, 5.15~5.35GHz, 5.47~5.725GHz and 5.725~5.850GHz frequencies band. This report was recorded the RF parameters including 5.15~5.35GHz and 5.47~5.725GHz. For the 2400 ~ 2483.5MHz and 5.725~5.850GHz RF parameters was recorded in another test report.

2.1 MEASUREMENT UNCERTAINTY

Where relevant, the following measurement uncertainty levels have been estimated for tests performed on the EUT as specified in CISPR 16-4-2:

This uncertainty represents an expanded uncertainty expressed at approximately the 95% confidence level using a coverage factor of $k=2$.

Measurement	Value
Conducted emissions	2.44 dB
Radiated emissions (30MHz-1GHz)	3.94 dB
Radiated emissions (1GHz -18GHz)	2.49 dB
Radiated emissions (18GHz -40GHz)	2.70 dB



A D T

3. GENERAL INFORMATION

3.1 GENERAL DESCRIPTION OF EUT

PRODUCT	Wireless LAN adapter
MODEL NO.	WIS10ABGN
FCC ID	A3L-WIS10ABGN
POWER SUPPLY	DC 5V from host equipment
MODULATION TYPE	CCK, DQPSK, DBPSK for DSSS 64QAM, 16QAM, QPSK, BPSK for OFDM
MODULATION TECHNOLOGY	DSSS, OFDM
TRANSFER RATE	802.11b: 11 / 5.5 / 2 / 1Mbps 802.11g: 54 / 48 / 36 / 24 / 18 / 12 / 9 / 6Mbps 802.11a: 54 / 48 / 36 / 24 / 18 / 12 / 9 / 6Mbps 802.11n (20MHz, 800ns GI MCS8~15): 130 / 117 / 104 / 78 / 52 / 39 / 26 / 13 802.11n (20MHz, 800ns GI MCS0~7): 65 / 58.5 / 52 / 39 / 26 / 19.5 / 13 / 6.5Mbps 802.11n (40MHz, 800ns GI MCS8~15): 270 / 243 / 216 / 162 / 108 / 81 / 54 / 27 802.11n (40MHz, 800ns GI MCS0~7): 135 / 121.5 / 108 / 81 / 54 / 40.5 / 27 / 13.5Mbps 802.11n (20MHz, 400ns GI MCS8~15): 144.444 / 130 / 115.556 / 86.667 / 57.778 / 43.333 / 28.889 / 14.444 802.11n (20MHz, 400ns GI MCS0~7): 72.2 / 65 / 57.8 / 43.3 / 28.9 / 21.7 / 14.4 / 7.2Mbps 802.11n (40MHz, 400ns GI MCS8~15): 300 / 270 / 240 / 180 / 120 / 90 / 60 / 30 802.11n (40MHz, 400ns GI MCS0~7): 150 / 135 / 120 / 90 / 60 / 45 / 30 / 15Mbps
FREQUENCY RANGE	For 15.407 802.11a: 5.18 ~ 5.24GHz, 5.26 ~ 5.32GHz, 5.50 ~ 5.70GHz For 15.247 802.11b & 802.11g: 2412 ~ 2462MHz 802.11a: 5.745 ~ 5.825GHz



A D T

NUMBER OF CHANNEL	For 15.407 19 for 802.11a, 802.11n (20MHz) 9 for 802.11n (40MHz)
	For 15.247(2.4GHz) 11 for 802.11b, 802.11g, 802.11n (20MHz) 7 for 802.11n (40MHz)
	For 15.247(5GHz) 5 for 802.11a, 802.11n (20MHz) 2 for 802.11n (40MHz)
MAXIMUM OUTPUT POWER	For 15.407 802.11a: 33.9mW 802.11n (20MHz): 94.6mW 802.11n (40MHz): 82.5mW For 15.247(2.4GHz) 802.11b: 239.9mW 802.11g: 269.2mW 802.11n (20MHz): 545.4mW 802.11n (40MHz): 571.1mW For 15.247(5GHz) 802.11a: 147.9mW 802.11n (20MHz): 303.0mW 802.11n (40MHz): 273.8mW
ANTENNA TYPE	Please see note 1
ANTENNA CONNECTOR	Please see note 1
DATA CABLE	NA
INTERFACE	USB interface
ASSOCIATED DEVICES	Cradle x 1



A D T

NOTE:

1. There are two antennas provided to this EUT, please refer to the following table:

No.	Antenna Type	For 2.4GHz Gain (dBi)	For 5GHz Gain (dBi)				Antenna Connector
			5.125 ~ 5.25 MHz	5.25 ~ 5.35 MHz	5.47 ~ 5.725 MHz	5.725 ~ 5.850 MHz	
CHAIN(0)	Printed	0.46	0.9	1.53	1.58	1.72	NA
CHAIN(1)	Printed	-0.04	-0.91	1.71	0.79	0.09	NA

2. The EUT was pre-tested in chamber as the following test modes:

Test Mode	Description
Mode 1	With Cradle
Mode 2	Without Cradle

From the above modes, the worse emission level was found in **Mode 1**. Therefore only the test data of the mode was recorded in this report individually.

3. The EUT incorporates a MIMO function with 802.11n. Physically, the EUT provides two completed transmitters and two completed receivers.
4. The EUT is 2 * 2 spatial MIMO (2Tx & 2Rx) without beam forming function. The antenna configurations are two transmitter antennas and two receiver antennas, as there are 2 Printed antennas. Spatial multiplexing modes for simultaneous transmission using 2 antennas, and for simultaneous receiver using 2 antennas.
5. The EUT complies with 802.11n standards and backwards compatible with 802. 11a, 802.11b, 802.11g products.
6. The above EUT information was declared by manufacturer and for more detailed features description, please refer to the manufacturer's specifications or user's manual.



A D T

3.2 DESCRIPTION OF TEST MODES

Operated in 5150MHz ~ 5350MHz bands:

Eight channels are provided for 802.11a and 802.11n (20MHz):

CHANNEL	FREQUENCY
36	5180 MHz
40	5200 MHz
44	5220 MHz
48	5240 MHz
52	5260 MHz
56	5280 MHz
60	5300 MHz
64	5320 MHz

Four channels are provided for 802.11n (40MHz):

CHANNEL	FREQUENCY
38	5190 MHz
46	5230 MHz
54	5270 MHz
62	5310 MHz



A D T

Operated in 5470MHz ~ 5725MHz bands:

Eleven channels are provided for 802.11a and 802.11n (20MHz):

CHANNEL	FREQUENCY
100	5500 MHz
104	5520 MHz
108	5540 MHz
112	5560 MHz
116	5580 MHz
120	5600 MHz
124	5620 MHz
128	5640 MHz
132	5660 MHz
136	5680 MHz
140	5700 MHz

Five channels are provided for 802.11n (40MHz):

CHANNEL	FREQUENCY
102	5510 MHz
110	5550 MHz
118	5590 MHz
126	5630 MHz
134	5670 MHz



3.2.1 TEST MODE APPLICABILITY AND TESTED CHANNEL DETAIL:

EUT CONFIGURE MODE	APPLICABLE TO				DESCRIPTION
	PLC	RE < 1G	RE ≥ 1G	APCM	
-	√	√	√	√	-

Where **PLC**: Power Line Conducted Emission

RE < 1G: Radiated Emission below 1GHz

RE ≥ 1G: Radiated Emission above 1GHz

APCM: Antenna Port Conducted Measurement

ANTENNA COMBINATION MODE:

COMBINATION MODE	OPERATION MODE	TX CHAIN(0)	TX CHAIN(1)
A	802.11 b	√	
B	802.11 g	√	
C	802.11 a	√	
D	802.11n(20MHz) for MCS0~7	√	√
E	802.11n(20MHz) for MCS8~15	√	√
F	802.11n(40MHz) for MCS0~7	√	√
G	802.11n(40MHz) for MCS8~15	√	√

Note:

1. The above information was declared by manufacturer and for more detailed features description, please refer to the manufacturer's specifications or user's manual.
2. Mode A, B, C, D and F the worst modes, were selected as representative mode for the report.

POWER LINE CONDUCTED EMISSION TEST:

- Pre-Scan has been conducted to determine the worst-case mode from all possible combinations between available modulations, data rates and antenna ports (if EUT with antenna diversity architecture).
- Following channel(s) was (were) selected for the final test as listed below.

MODE	AVAILABLE CHANNEL	TESTED CHANNEL	MODULATION TECHNOLOGY	MODULATION TYPE	DATA RATE (Mbps)	TX COMBINATION
802.11n (20MHz)	36 to 140	60	OFDM	BPSK	7.2	D

RADIATED EMISSION TEST (BELOW 1 GHz):

- Pre-Scan has been conducted to determine the worst-case mode from all possible combinations between available modulations, data rates and antenna ports (if EUT with antenna diversity architecture).
- Following channel(s) was (were) selected for the final test as listed below.

MODE	AVAILABLE CHANNEL	TESTED CHANNEL	MODULATION TECHNOLOGY	MODULATION TYPE	DATA RATE (Mbps)	TX COMBINATION
802.11n (20MHz)	36 to 140	60	OFDM	BPSK	7.2	D

RADIATED EMISSION TEST (ABOVE 1 GHz):

- Pre-Scan has been conducted to determine the worst-case mode from all possible combinations between available modulations, data rates and antenna ports (if EUT with antenna diversity architecture).
- Following channel(s) was (were) selected for the final test as listed below.

MODE	AVAILABLE CHANNEL	TESTED CHANNEL	MODULATION TECHNOLOGY	MODULATION TYPE	DATA RATE (Mbps)	TX COMBINATION
802.11a	36 to 140	36, 40, 48, 52, 60, 64, 100, 120, 140	OFDM	BPSK	6	C
802.11n (20MHz)	36 to 140	36, 40, 48, 52, 60, 64, 100, 120, 140	OFDM	BPSK	7.2	D
802.11n (40MHz)	38 to 134	38, 46, 54, 62, 102, 118, 134	OFDM	BPSK	15	F



A D T

ANTENNA PORT OUTPUT SPECTRUM PLOTS:

- Pre-Scan has been conducted to determine the worst-case mode from all possible combinations between available modulations, data rates and antenna ports (if EUT with antenna diversity architecture).
- Following channel(s) was (were) selected for the final test as listed below.

MODE	AVAILABLE CHANNEL	TESTED CHANNEL	MODULATION TECHNOLOGY	MODULATION TYPE	DATA RATE (Mbps)	TX COMBINATION
802.11a	36 to 140	36, 64, 100, 104	OFDM	BPSK	6	C
802.11n (20MHz)	36 to 140	36, 64, 100, 104	OFDM	BPSK	7.2	D
802.11n (40MHz)	38 to 134	38, 62, 102, 134	OFDM	BPSK	15	F

※ After verification, conducted out band emission as show worst chain in report by investigations.

ANTENNA PORT CONDUCTED MEASUREMENT:

- This item includes all test value of each mode, but only includes spectrum plot of worst value of each mode.
- Pre-Scan has been conducted to determine the worst-case mode from all possible combinations between available modulations, data rates and antenna ports (if EUT with antenna diversity architecture).
- Following channel(s) was (were) selected for the final test as listed below.

MODE	AVAILABLE CHANNEL	TESTED CHANNEL	MODULATION TECHNOLOGY	MODULATION TYPE	DATA RATE (Mbps)	TX COMBINATION
802.11a	36 to 140	36, 40, 48, 52, 60, 64, 100, 120, 140	OFDM	BPSK	6	C
802.11n (20MHz)	36 to 140	36, 40, 48, 52, 60, 64, 100, 120, 140	OFDM	BPSK	7.2	D
802.11n (40MHz)	38 to 134	38,46, 54, 62, 102, 118, 134	OFDM	BPSK	15	F

※ After verification, bandwidth as show worst chain in report by investigations.



ADT

TEST CONDITION:

APPLICABLE TO	ENVIRONMENTAL CONDITIONS	INPUT POWER (SYSTEM)	TESTED BY
RE ³ 1G	10deg. C, 50%RH, 1024 hPa	120Vac, 60Hz	Eric Lee
RE<1G	14deg. C, 70%RH, 1024 hPa	120Vac, 60Hz	Frank Liu
PLC	19deg. C, 58%RH, 1024 hPa	120Vac, 60Hz	Phoenix Huang
APCM	25deg. C, 60%RH, 1024 hPa	120Vac, 60Hz	Phoenix Huang

3.3 GENERAL DESCRIPTION OF APPLIED STANDARDS

The EUT is a Wireless LAN adapter. According to the specifications of the manufacturer, it must comply with the requirements of the following standards:

FCC Part 15, Subpart E (15.407)

ANSI C63.4-2003

All test items have been performed and recorded as per the above standards.

NOTE: The EUT is also considered as a kind of computer peripheral, because the connection to computer is necessary for typical use. It has been verified to comply with the requirements of FCC Part 15, Subpart B, Class B (DoC). The test report has been issued separately.



A D T

3.4 DESCRIPTION OF SUPPORT UNITS

The EUT has been tested as an independent unit together with other necessary accessories or support units. The following support units or accessories were used to form a representative test configuration during the tests.

NO.	PRODUCT	BRAND	MODEL NO.	SERIAL NO.	FCC ID
1	NOTEBOOK COMPUTER	DELL	PP18L	6976685584	DoC
2	iPod	Apple	A1137	6U6078FMUPR	DoC

NO.	SIGNAL CABLE DESCRIPTION OF THE ABOVE SUPPORT UNITS
1	NA
2	1.0 m shielded cable, terminated with USB connector, w/o core.

NOTE: 1. All power cords of the above support units are non shielded (1.8m).

3.5 CONFIGURATION OF SYSTEM UNDER TEST

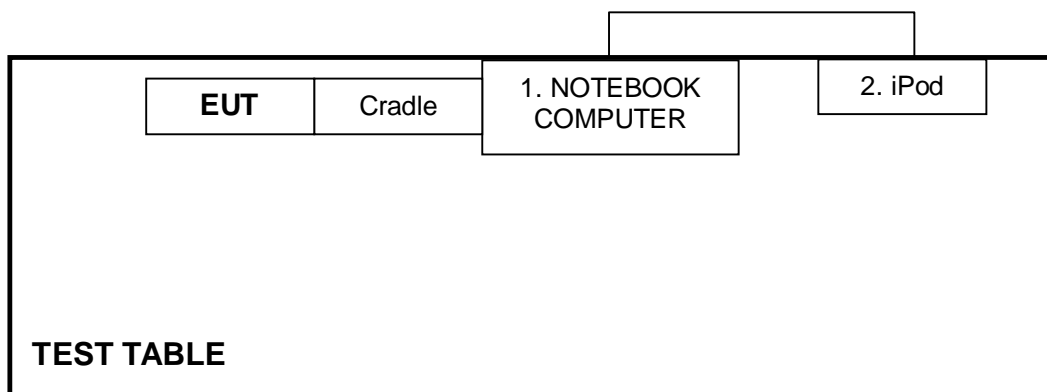



A D T

4. TEST TYPES AND RESULTS

4.1 CONDUCTED EMISSION MEASUREMENT

4.1.1 LIMITS OF CONDUCTED EMISSION MEASUREMENT

FREQUENCY OF EMISSION (MHz)	CONDUCTED LIMIT (dB μ V)	
	Quasi-peak	Average
0.15-0.5	66 to 56	56 to 46
0.5-5	56	46
5-30	60	50

- NOTE:**
1. The lower limit shall apply at the transition frequencies.
 2. The limit decreases in line with the logarithm of the frequency in the range of 0.15 to 0.50 MHz.
 3. All emanations from a class A/B digital device or system, including any network of conductors and apparatus connected thereto, shall not exceed the level of field strengths specified above.

4.1.2 TEST INSTRUMENTS

DESCRIPTION & MANUFACTURER	MODEL NO.	SERIAL NO.	CALIBRATED DATE	CALIBRATED UNTIL
Test Receiver	ESCS 30	100375	Mar. 23, 2009	Mar. 22, 2010
Line-Impedance Stabilization Network (for Peripheral)	ENV-216	100071	Nov. 30, 2009	Nov. 29, 2010
Line-Impedance Stabilization Network (for EUT)	ESH3-Z5	848773/004	Oct. 26, 2009	Oct. 25, 2010
RF Cable (JYEBAO)	5DFB	COBCAB-001	Aug. 14, 2009	Aug. 13, 2010
50 ohms Terminator	50	3	Oct. 28, 2009	Oct. 27, 2010
Software	BV ADT_ Cond_V7.3.7	NA	NA	NA

Note:

1. The calibration interval of the above test instruments is 12 months and the calibrations are traceable to NML/ROC and NIST/USA.
2. The test was performed in Shielded Room No. B.
- 3 The VCCI Con B Registration No. is C-2193.



A D T

4.1.3 TEST PROCEDURES

- a. The EUT was placed 0.4 meters from the conducting wall of the shielded room with EUT being connected to the power mains through a line impedance stabilization network (LISN). Other support units were connected to the power mains through another LISN. The two LISNs
- b. provide 50 ohm/ 50uH of coupling impedance for the measuring instrument.
- c. Both lines of the power mains connected to the EUT were checked for maximum conducted interference.
- d. The frequency range from 150kHz to 30MHz was searched. Emission level under (Limit – 20dB) was not recorded.

4.1.4 DEVIATION FROM TEST STANDARD

No deviation

4.1.5 TEST SETUP

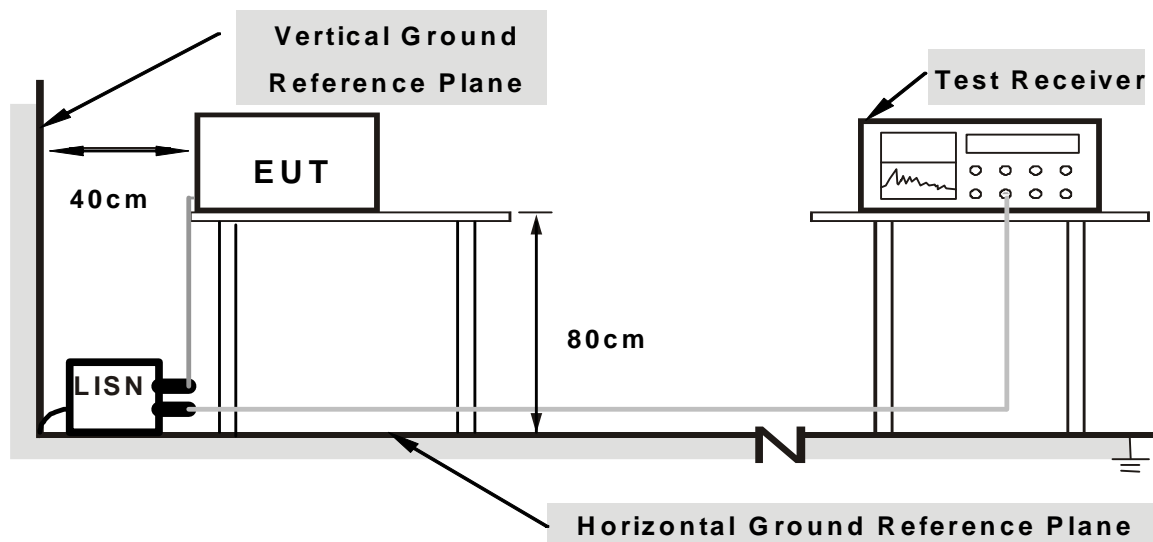

Note: 1.Support units were connected to second LISN.

2.Both of LISNs (AMN) are 80 cm from EUT and at least 80 from other units and other metal planes

For the actual test configuration, please refer to the related item – Photographs of the Test Configuration.

4.1.6 EUT OPERATING CONDITIONS

- a. Connect the EUT with the support unit 1 (Notebook Computer) which placed on a testing table via one Cradle.
- b. The communication partner run test program “RT3x7xQA.exe” to enable EUT under transmission/receiving condition continuously at specific channel frequency.

4.1.7 TEST RESULTS

802.11a OFDM MODULATION:

PHASE	Line (L)	6dB BANDWIDTH	9 kHz
--------------	----------	----------------------	-------

No	Freq. [MHz]	Corr. Factor (dB)	Reading Value		Emission Level		Limit		Margin	
			[dB (uV)]		[dB (uV)]		[dB (uV)]		(dB)	
			Q.P.	AV.	Q.P.	AV.	Q.P.	AV.	Q.P.	AV.
1	0.271	9.71	36.36	29.44	46.07	39.15	61.08	51.08	-15.01	-11.93
2	1.793	9.89	33.82	24.03	43.71	33.92	56.00	46.00	-12.29	-12.08
3	1.797	9.89	32.90	25.62	42.79	35.51	56.00	46.00	-13.21	-10.49
4	2.297	9.89	27.74	21.89	37.63	31.78	56.00	46.00	-18.37	-14.22
5	3.398	9.87	33.40	23.50	43.27	33.37	56.00	46.00	-12.73	-12.63
6	3.707	9.86	31.15	22.89	41.01	32.75	56.00	46.00	-14.99	-13.25
7	3.934	9.86	29.46	23.13	39.32	32.99	56.00	46.00	-16.68	-13.01

- REMARKS:**
1. Q.P. and AV. are abbreviations of quasi-peak and average individually.
 2. "-": The Quasi-peak reading value also meets average limit and measurement with the average detector is unnecessary.
 3. The emission levels of other frequencies were very low against the limit.
 4. Margin value = Emission level - Limit value
 5. Correction factor = Insertion loss + Cable loss
 6. Emission Level = Correction Factor + Reading Value.

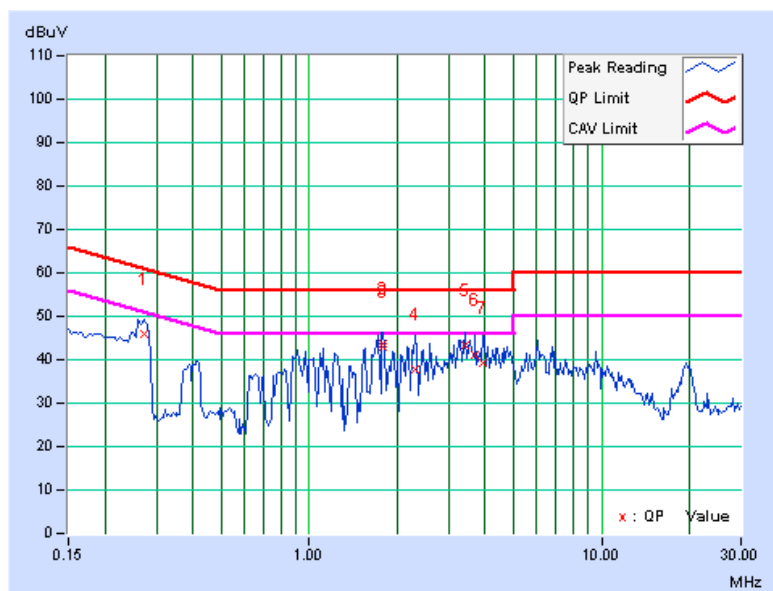

PHASE	Neutral (N)	6dB BANDWIDTH	9 kHz
--------------	-------------	----------------------	-------

No	Freq.	Corr.	Reading Value		Emission Level		Limit		Margin	
	[MHz]	Factor	[dB (uV)]		[dB (uV)]		[dB (uV)]		(dB)	
		(dB)	Q.P.	AV.	Q.P.	AV.	Q.P.	AV.	Q.P.	AV.
1	0.267	9.71	36.48	29.02	46.19	38.73	61.20	51.20	-15.01	-12.47
2	1.770	9.89	34.63	26.48	44.52	36.37	56.00	46.00	-11.48	-9.63
3	1.802	9.89	33.79	25.56	43.68	35.45	56.00	46.00	-12.32	-10.55
4	2.449	9.89	32.82	21.48	42.71	31.37	56.00	46.00	-13.29	-14.63
5	3.535	9.87	29.35	22.75	39.22	32.62	56.00	46.00	-16.78	-13.38
6	4.008	9.87	29.75	22.43	39.62	32.30	56.00	46.00	-16.38	-13.70

- REMARKS:**
1. Q.P. and AV. are abbreviations of quasi-peak and average individually.
 2. "-": The Quasi-peak reading value also meets average limit and measurement with the average detector is unnecessary.
 3. The emission levels of other frequencies were very low against the limit.
 4. Margin value = Emission level - Limit value
 5. Correction factor = Insertion loss + Cable loss
 6. Emission Level = Correction Factor + Reading Value.

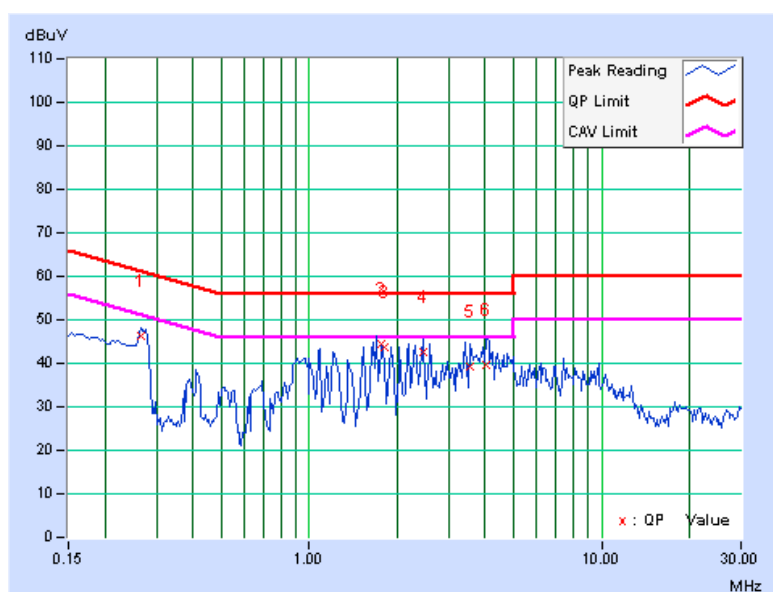

4.2 RADIATED EMISSION MEASUREMENT

4.2.1 LIMITS OF RADIATED EMISSION MEASUREMENT

Emissions radiated outside of the specified bands, shall be according to the general radiated limits in 15.209 as following:

Frequencies (MHz)	Field strength (microvolts/meter)	Measurement distance (meters)
0.009-0.490	2400/F(kHz)	300
0.490-1.705	24000/F(kHz)	30
1.705-30.0	30	30
30-88	100	3
88-216	150	3
216-960	200	3
Above 960	500	3

NOTE:

1. The lower limit shall apply at the transition frequencies.
2. Emission level (dBuV/m) = 20 log Emission level (uV/m).
3. As shown in 15.35(b), for frequencies above 1000MHz, the field strength limits are based on average detector, however, the peak field strength of any emission shall not exceed the maximum permitted average limits, specified above by more than 20dB under any condition of modulation.



A D T

4.2.2 LIMITS OF UNWANTED EMISSION OUT OF THE RESTRICTED BANDS

Frequencies (MHz)	EIRP Limit (dBm)	Equivalent Field Strength at 3m (dB μ V/m) *note 3
5150~5250	-27	68.3
5250~5350	-27	68.3
5470~5725	-27	68.3
5725~5825	-27 *note 1	68.3
	-17 *note 2	78.3

NOTE:

1. For frequencies 10MHz or greater above or below the band edge.
2. All emissions within the frequency range from the band edge to 10MHz above or below the band edge.
3. The following formula is used to convert the equipment isotropic radiated power (eirp) to field strength

$$E = \frac{1000000\sqrt{30P}}{3} \mu\text{V/m, where P is the eirp (Watts)}$$



A D T

4.2.3 TEST INSTRUMENTS

DESCRIPTION & MANUFACTURER	MODEL NO.	SERIAL NO.	CALIBRATED DATE	CALIBRATED UNTIL
ROHDE & SCHWARZ Spectrum Analyzer	FSP40	100036	Apr. 03 , 2009	Apr. 02 , 2010
Agilent PSA Spectrum Analyzer	E4446A	MY46180622	Apr. 24 , 2009	Apr. 23 , 2010
HP Pre_Amplifier	8449B	3008A01923	Nov. 02, 2009	Nov. 01, 2010
ROHDE & SCHWARZ Test Receiver	ESCS30	847124/029	Aug. 28, 2009	Aug. 28, 2010
SCHWARZBECK TRILOG Broadband Antenna	VULB 9168	138	April 29, 2009	April 28, 2010
Schwarzbeck Horn_Antenna	BBHA9120	D124	Dec. 18, 2009	Dec. 17, 2010
Schwarzbeck Horn_Antenna	BBHA 9170	BBHA9170153	Jan. 22, 2009	Jan. 21, 2010
RF Switches	EMH-011	08009	Sep. 26, 2009	Sep. 25, 2010
RF CABLE (Chaintek)	Sucoflex 106	28077	Aug. 14, 2009	Aug. 13, 2010
RF Cable	8D	STCCAB-001	Sep. 26, 2009	Sep. 25, 2010
Software	ADT_Radiated_V7.6.15.9.2	NA	NA	NA
CT Antenna Tower & Turn Table	NA	NA	NA	NA

Note: 1. The calibration interval of the above test instruments is 12 months and the calibrations are traceable to NML/ROC and NIST/USA.

2. The horn antenna, HP preamplifier (model: 8449B) and Spectrum Analyzer (model: FSP40) are used only for the measurement of emission frequency above 1GHz if tested.
3. The test was performed in Open Site No. C.
4. The FCC Site Registration No. is 656396.
5. The VCCI Site Registration No. is R-1626.
6. The CANADA Site Registration No. is IC 7450G-3.

4.2.4 TEST PROCEDURES

- a. The EUT was placed on the top of a rotating table 0.8 meters above the ground at a 10 meter open area test site. The table was rotated 360 degrees to determine the position of the highest radiation.
- b. The EUT was set 3 meters away from the interference-receiving antenna, which was mounted on the top of a variable-height antenna tower.
- c. The antenna is a broadband antenna, and its height is varied from one meter to four meters above the ground to determine the maximum value of the field strength. Both horizontal and vertical polarizations of the antenna are set to make the measurement.
- d. For each suspected emission, the EUT was arranged to its worst case and then the antenna was tuned to heights from 1 meter to 4 meters and the rotatable table was turned from 0 degrees to 360 degrees to find the maximum reading.
- e. The test-receiver system was set to Peak Detect Function and Specified Bandwidth with Maximum Hold Mode.
- f. If the emission level of the EUT in peak mode was 10dB lower than the limit specified, then testing could be stopped and the peak values of the EUT would be reported. Otherwise the emissions that did not have 10dB margin would be re-tested one by one using peak, quasi-peak or average method as specified and then reported in a data sheet.

NOTE:

1. The resolution bandwidth and video bandwidth of test receiver/spectrum analyzer is 120kHz for Peak detection (PK) and Quasi-peak detection (QP) at frequency below 1GHz.
2. The resolution bandwidth of test receiver/spectrum analyzer is 1 MHz and the video bandwidth is 3 MHz for Peak detection (PK) at frequency above 1GHz.
3. The resolution bandwidth of test receiver/spectrum analyzer is 1 MHz and the video bandwidth is 10 Hz for Average detection (AV) at frequency above 1GHz.

4.2.5 DEVIATION FROM TEST STANDARD

No deviation

4.2.6 TEST SETUP

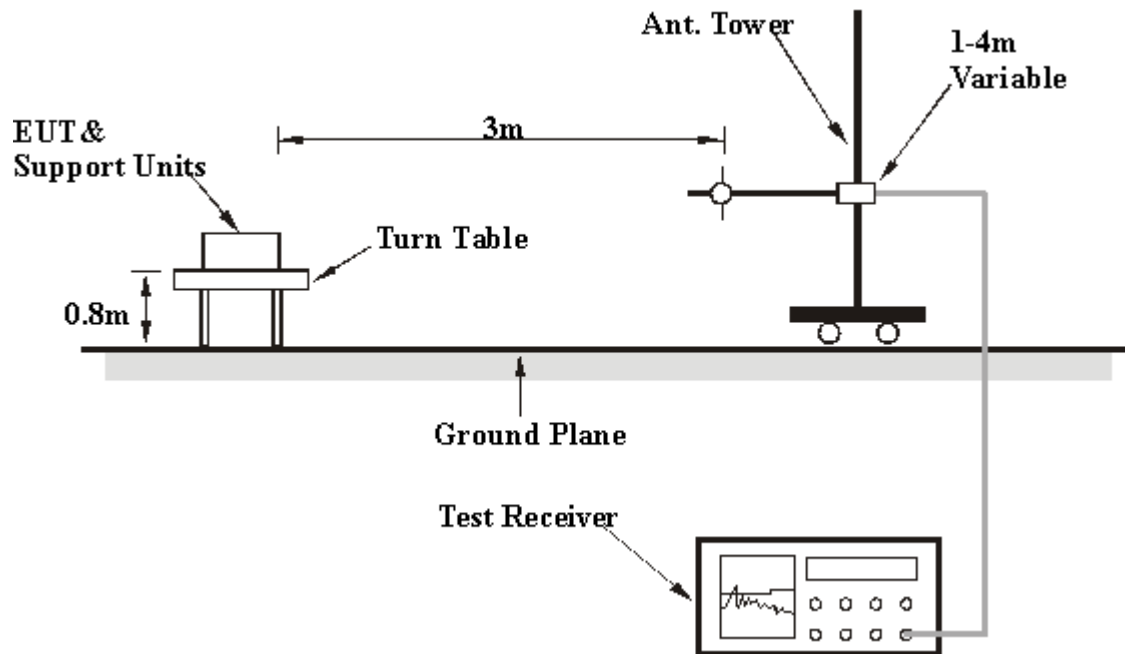

For the actual test configuration, please refer to the related item – Photographs of the Test Configuration.

4.2.7 EUT OPERATING CONDITION

Same as 4.1.6



A D T

4.2.8 TEST RESULTS

BELOW 1GHz WORST-CASE DATA : 802.11n (20MHz) OFDM MODULATION

EUT TEST CONDITION		MEASUREMENT DETAIL	
CHANNEL	Channel 36	FREQUENCY RANGE	Below 1000MHz
INPUT POWER (SYSTEM)	120Vac, 60 Hz	DETECTOR FUNCTION	Quasi-Peak
ENVIRONMENTAL CONDITIONS	14deg. C, 70%RH 1024 hPa	TESTED BY	Frank Liu

ANTENNA POLARITY & TEST DISTANCE: HORIZONTAL AT 3 M								
NO.	FREQ. (MHz)	EMISSION LEVEL (dBuV/m)	LIMIT (dBuV/m)	MARGIN (dB)	ANTENNA HEIGHT (m)	TABLE ANGLE (Degree)	RAW VALUE (dBuV)	CORRECTION FACTOR (dB/m)
1	114.42	18.2 QP	43.5	-25.3	1.04 H	66	6.86	11.38
2	240.00	31.2 QP	46.0	-14.8	1.09 H	27	17.89	13.33
3	360.00	32.3 QP	46.0	-13.7	1.14 H	68	14.75	17.52
4	480.00	43.0 QP	46.0	-3.0	1.62 H	159	22.26	20.74
5	839.99	43.0 QP	46.0	-3.0	1.04 H	211	15.78	27.21
6	960.00	33.2 QP	46.0	-12.8	1.07 H	284	4.56	28.68
ANTENNA POLARITY & TEST DISTANCE: VERTICAL AT 3 M								
NO.	FREQ. (MHz)	EMISSION LEVEL (dBuV/m)	LIMIT (dBuV/m)	MARGIN (dB)	ANTENNA HEIGHT (m)	TABLE ANGLE (Degree)	RAW VALUE (dBuV)	CORRECTION FACTOR (dB/m)
1	240.00	37.5 QP	46.0	-8.5	1.12 V	203	24.20	13.33
2	360.00	42.1 QP	46.0	-3.9	1.04 V	23	24.59	17.52
3	480.00	42.8 QP	46.0	-3.2	1.09 V	77	22.10	20.74
4	600.00	42.1 QP	46.0	-3.9	1.09 V	84	18.25	23.87
5	840.00	42.2 QP	46.0	-3.8	1.06 V	222	15.01	27.21
6	960.00	39.2 QP	46.0	-6.8	1.04 V	59	10.56	28.68

- REMARKS:**
1. Emission level (dBuV/m) = Raw Value (dBuV) + Correction Factor (dB/m).
 2. Correction Factor (dB/m) = Antenna Factor (dB/m) + Cable Factor (dB).
 3. The other emission levels were very low against the limit.
 4. Margin value = Emission level – Limit value.



A D T

ABOVE 1GHz WORST-CASE DATA

802.11a OFDM MODULATION

EUT TEST CONDITION		MEASUREMENT DETAIL	
CHANNEL	Channel 36	FREQUENCY RANGE	1 ~ 40GHz
INPUT POWER (SYSTEM)	120Vac, 60 Hz	DETECTOR FUNCTION	Peak (PK) Average (AV)
ENVIRONMENTAL CONDITIONS	10deg. C, 50%RH 1024 hPa	TESTED BY	Eric Lee

ANTENNA POLARITY & TEST DISTANCE: HORIZONTAL AT 3 M								
NO.	FREQ. (MHz)	EMISSION LEVEL (dBuV/m)	LIMIT (dBuV/m)	MARGIN (dB)	ANTENNA HEIGHT (m)	TABLE ANGLE (Degree)	RAW VALUE (dBuV)	CORRECTION FACTOR (dB/m)
1	5150.00	52.8 PK	74.0	-21.2	1.28 H	186	16.81	36.00
2	5150.00	41.3 AV	54.0	-12.7	1.28 H	186	5.30	36.00
3	*5180.00	92.7 PK			1.27 H	186	56.68	36.05
4	*5180.00	84.4 AV			1.27 H	186	48.32	36.05
5	#10360.00	56.2 PK	68.3	-12.1	1.56 H	324	10.05	46.15
ANTENNA POLARITY & TEST DISTANCE: VERTICAL AT 3 M								
NO.	FREQ. (MHz)	EMISSION LEVEL (dBuV/m)	LIMIT (dBuV/m)	MARGIN (dB)	ANTENNA HEIGHT (m)	TABLE ANGLE (Degree)	RAW VALUE (dBuV)	CORRECTION FACTOR (dB/m)
1	5127.20	57.2 PK	74.0	-16.8	1.27 V	143	21.26	35.96
2	5127.20	47.8 AV	54.0	-6.2	1.27 V	143	11.85	35.96
3	*5180.00	100.9 PK			1.28 V	109	64.88	36.05
4	*5180.00	92.4 AV			1.28 V	109	56.39	36.05
5	#10360.00	56.9 PK	68.3	-11.4	1.40 V	5	10.71	46.15

REMARKS: 1. Emission level (dBuV/m) = Raw Value (dBuV) + Correction Factor (dB/m).

2. Correction Factor (dB/m) = Antenna Factor (dB/m) + Cable Factor (dB).

3. The other emission levels were very low against the limit.

4. Margin value = Emission level – Limit value.

5. “ * “: Fundamental frequency.

6. "#": The radiated frequency is out the restricted band.



A D T

EUT TEST CONDITION		MEASUREMENT DETAIL	
CHANNEL	Channel 40	FREQUENCY RANGE	1 ~ 40GHz
INPUT POWER (SYSTEM)	120Vac, 60 Hz	DETECTOR FUNCTION	Peak (PK) Average (AV)
ENVIRONMENTAL CONDITIONS	20deg. C, 67%RH 1024 hPa	TESTED BY	Eric Lee

ANTENNA POLARITY & TEST DISTANCE: HORIZONTAL AT 3 M								
NO.	FREQ. (MHz)	EMISSION LEVEL (dBuV/m)	LIMIT (dBuV/m)	MARGIN (dB)	ANTENNA HEIGHT (m)	TABLE ANGLE (Degree)	RAW VALUE (dBuV)	CORRECTION FACTOR (dB/m)
1	*5200.00	93.3 PK			1.30 H	201	57.21	36.08
2	*5200.00	85.4 AV			1.30 H	201	49.32	36.08
3	#10400.00	55.5 PK	68.3	-12.8	1.29 H	188	9.49	45.99
ANTENNA POLARITY & TEST DISTANCE: VERTICAL AT 3 M								
NO.	FREQ. (MHz)	EMISSION LEVEL (dBuV/m)	LIMIT (dBuV/m)	MARGIN (dB)	ANTENNA HEIGHT (m)	TABLE ANGLE (Degree)	RAW VALUE (dBuV)	CORRECTION FACTOR (dB/m)
1	*5200.00	101.1 PK			1.29 V	110	65.03	36.08
2	*5200.00	92.9 AV			1.29 V	110	56.81	36.08
3	#10400.00	55.7 PK	68.3	-12.6	1.14 V	87	9.73	45.99

- REMARKS:**
1. Emission level (dBuV/m) = Raw Value (dBuV) + Correction Factor (dB/m).
 2. Correction Factor (dB/m) = Antenna Factor (dB/m) + Cable Factor (dB).
 3. The other emission levels were very low against the limit.
 4. Margin value = Emission level – Limit value.
 5. “ * “: Fundamental frequency.
 6. "#":The radiated frequency is out the restricted band.



A D T

EUT TEST CONDITION		MEASUREMENT DETAIL	
CHANNEL	Channel 48	FREQUENCY RANGE	1 ~ 40GHz
INPUT POWER (SYSTEM)	120Vac, 60 Hz	DETECTOR FUNCTION	Peak (PK) Average (AV)
ENVIRONMENTAL CONDITIONS	20deg. C, 67%RH 1024 hPa	TESTED BY	Eric Lee

ANTENNA POLARITY & TEST DISTANCE: HORIZONTAL AT 3 M								
NO.	FREQ. (MHz)	EMISSION LEVEL (dBuV/m)	LIMIT (dBuV/m)	MARGIN (dB)	ANTENNA HEIGHT (m)	TABLE ANGLE (Degree)	RAW VALUE (dBuV)	CORRECTION FACTOR (dB/m)
1	*5240.00	93.3 PK			1.28 H	201	57.19	36.14
2	*5240.00	84.9 AV			1.28 H	201	48.75	36.14
3	#10480.00	54.7 PK	68.3	-13.6	1.26 H	81	8.59	46.12
ANTENNA POLARITY & TEST DISTANCE: VERTICAL AT 3 M								
NO.	FREQ. (MHz)	EMISSION LEVEL (dBuV/m)	LIMIT (dBuV/m)	MARGIN (dB)	ANTENNA HEIGHT (m)	TABLE ANGLE (Degree)	RAW VALUE (dBuV)	CORRECTION FACTOR (dB/m)
1	*5240.00	100.9 PK			1.30 V	120	64.72	36.14
2	*5240.00	92.8 AV			1.30 V	120	56.62	36.14
3	#10480.00	55.9 PK	68.3	-12.4	1.18 V	91	9.82	46.12

- REMARKS:**
1. Emission level (dBuV/m) = Raw Value (dBuV) + Correction Factor (dB/m).
 2. Correction Factor (dB/m) = Antenna Factor (dB/m) + Cable Factor (dB).
 3. The other emission levels were very low against the limit.
 4. Margin value = Emission level – Limit value.
 5. “ * “: Fundamental frequency.
 6. “#”:The radiated frequency is out the restricted band.



A D T

EUT TEST CONDITION		MEASUREMENT DETAIL	
CHANNEL	Channel 52	FREQUENCY RANGE	1 ~ 40GHz
INPUT POWER (SYSTEM)	120Vac, 60 Hz	DETECTOR FUNCTION	Peak (PK) Average (AV)
ENVIRONMENTAL CONDITIONS	20deg. C, 67%RH 1024 hPa	TESTED BY	Eric Lee

ANTENNA POLARITY & TEST DISTANCE: HORIZONTAL AT 3 M								
NO.	FREQ. (MHz)	EMISSION LEVEL (dBuV/m)	LIMIT (dBuV/m)	MARGIN (dB)	ANTENNA HEIGHT (m)	TABLE ANGLE (Degree)	RAW VALUE (dBuV)	CORRECTION FACTOR (dB/m)
1	*5260.00	93.8 PK			1.26 H	189	57.66	36.18
2	*5260.00	84.7 AV			1.26 H	189	48.49	36.18
3	#10520.00	55.1 PK	68.3	-13.2	1.28 H	91	8.90	46.19
ANTENNA POLARITY & TEST DISTANCE: VERTICAL AT 3 M								
NO.	FREQ. (MHz)	EMISSION LEVEL (dBuV/m)	LIMIT (dBuV/m)	MARGIN (dB)	ANTENNA HEIGHT (m)	TABLE ANGLE (Degree)	RAW VALUE (dBuV)	CORRECTION FACTOR (dB/m)
1	*5260.00	101.5 PK			1.33 V	102	65.30	36.18
2	*5260.00	92.7 AV			1.33 V	102	56.53	36.18
3	#10520.00	56.1 PK	68.3	-12.2	1.21 V	68	9.92	46.19

- REMARKS:**
1. Emission level (dBuV/m) = Raw Value (dBuV) + Correction Factor (dB/m).
 2. Correction Factor (dB/m) = Antenna Factor (dB/m) + Cable Factor (dB).
 3. The other emission levels were very low against the limit.
 4. Margin value = Emission level – Limit value.
 5. “ * “: Fundamental frequency.
 6. "#":The radiated frequency is out the restricted band.



A D T

EUT TEST CONDITION		MEASUREMENT DETAIL	
CHANNEL	Channel 60	FREQUENCY RANGE	1 ~ 40GHz
INPUT POWER (SYSTEM)	120Vac, 60 Hz	DETECTOR FUNCTION	Peak (PK) Average (AV)
ENVIRONMENTAL CONDITIONS	20deg. C, 67%RH 1024 hPa	TESTED BY	Eric Lee

ANTENNA POLARITY & TEST DISTANCE: HORIZONTAL AT 3 M								
NO.	FREQ. (MHz)	EMISSION LEVEL (dBuV/m)	LIMIT (dBuV/m)	MARGIN (dB)	ANTENNA HEIGHT (m)	TABLE ANGLE (Degree)	RAW VALUE (dBuV)	CORRECTION FACTOR (dB/m)
1	*5300.00	94.68 PK			1.12 H	187	58.44	36.24
2	*5300.00	86.73 AV			1.12 H	187	50.49	36.24
3	10600.00	54.71 PK	74.00	-19.29	1.33 H	89	8.34	46.37
4	10600.00	43.44 AV	54.00	-10.56	1.33 H	89	-2.93	46.37
ANTENNA POLARITY & TEST DISTANCE: VERTICAL AT 3 M								
NO.	FREQ. (MHz)	EMISSION LEVEL (dBuV/m)	LIMIT (dBuV/m)	MARGIN (dB)	ANTENNA HEIGHT (m)	TABLE ANGLE (Degree)	RAW VALUE (dBuV)	CORRECTION FACTOR (dB/m)
1	*5300.00	102.7 PK			1.29 V	91	66.44	36.24
2	*5300.00	93.7 AV			1.29 V	91	57.45	36.24
3	10600.00	55.8 PK	74.0	-18.2	1.16 V	82	9.44	46.37
4	10600.00	43.5 AV	54.0	-10.5	1.16 V	82	-2.87	46.37

- REMARKS:**
1. Emission level (dBuV/m) = Raw Value (dBuV) + Correction Factor (dB/m).
 2. Correction Factor (dB/m) = Antenna Factor (dB/m) + Cable Factor (dB).
 3. The other emission levels were very low against the limit.
 4. Margin value = Emission level – Limit value.
 5. “ * “: Fundamental frequency.



A D T

EUT TEST CONDITION		MEASUREMENT DETAIL	
CHANNEL	Channel 64	FREQUENCY RANGE	1 ~ 40GHz
INPUT POWER (SYSTEM)	120Vac, 60 Hz	DETECTOR FUNCTION	Peak (PK) Average (AV)
ENVIRONMENTAL CONDITIONS	10deg. C, 50%RH 1024 hPa	TESTED BY	Eric Lee

ANTENNA POLARITY & TEST DISTANCE: HORIZONTAL AT 3 M								
NO.	FREQ. (MHz)	EMISSION LEVEL (dBuV/m)	LIMIT (dBuV/m)	MARGIN (dB)	ANTENNA HEIGHT (m)	TABLE ANGLE (Degree)	RAW VALUE (dBuV)	CORRECTION FACTOR (dB/m)
1	*5320.00	95.4 PK			1.33 H	213	59.12	36.27
2	*5320.00	87.1 AV			1.33 H	213	50.82	36.27
3	5350.00	52.4 PK	74.0	-21.6	1.26 H	83	16.05	36.32
4	5350.00	41.5 AV	54.0	-12.5	1.26 H	83	5.14	36.32
5	10640.00	54.0 PK	74.0	-20.0	1.36 H	74	7.38	46.63
6	10640.00	43.3 AV	54.0	-10.7	1.36 H	74	-3.34	46.63
ANTENNA POLARITY & TEST DISTANCE: VERTICAL AT 3 M								
NO.	FREQ. (MHz)	EMISSION LEVEL (dBuV/m)	LIMIT (dBuV/m)	MARGIN (dB)	ANTENNA HEIGHT (m)	TABLE ANGLE (Degree)	RAW VALUE (dBuV)	CORRECTION FACTOR (dB/m)
1	*5320.00	102.8 PK			1.30 V	86	66.54	36.27
2	*5320.00	93.4 AV			1.30 V	86	57.17	36.27
3	5372.00	56.0 PK	74.0	-18.0	1.29 V	91	19.60	36.36
4	5372.00	44.3 AV	54.0	-9.7	1.29 V	91	7.95	36.36
5	10640.00	54.3 PK	74.0	-19.7	1.26 V	181	7.71	46.63
6	10640.00	42.3 AV	54.0	-11.7	1.26 V	181	-4.30	46.63

- REMARKS:**
1. Emission level (dBuV/m) = Raw Value (dBuV) + Correction Factor (dB/m).
 2. Correction Factor (dB/m) = Antenna Factor (dB/m) + Cable Factor (dB).
 3. The other emission levels were very low against the limit.
 4. Margin value = Emission level – Limit value.
 5. “ * “: Fundamental frequency.



A D T

EUT TEST CONDITION		MEASUREMENT DETAIL	
CHANNEL	Channel 100	FREQUENCY RANGE	1 ~ 40GHz
INPUT POWER (SYSTEM)	120Vac, 60 Hz	DETECTOR FUNCTION	Peak (PK) Average (AV)
ENVIRONMENTAL CONDITIONS	10deg. C, 50%RH 1024 hPa	TESTED BY	Eric Lee

ANTENNA POLARITY & TEST DISTANCE: HORIZONTAL AT 3 M								
NO.	FREQ. (MHz)	EMISSION LEVEL (dBuV/m)	LIMIT (dBuV/m)	MARGIN (dB)	ANTENNA HEIGHT (m)	TABLE ANGLE (Degree)	RAW VALUE (dBuV)	CORRECTION FACTOR (dB/m)
1	5460.00	52.8 PK	74.0	-21.2	1.00 H	80	16.32	36.50
2	5460.00	41.6 AV	54.0	-12.4	1.00 H	80	5.14	36.50
3	#5470.00	58.2 PK	68.3	-10.1	1.00 H	79	21.73	36.51
4	*5500.00	95.8 PK			1.33 H	219	59.23	36.56
5	*5500.00	87.2 AV			1.33 H	219	50.68	36.56
6	11000.00	55.4 PK	74.0	-18.6	1.26 H	57	8.06	47.35
7	11000.00	43.3 AV	54.0	-10.7	1.26 H	57	-4.06	47.35

ANTENNA POLARITY & TEST DISTANCE: VERTICAL AT 3 M								
NO.	FREQ. (MHz)	EMISSION LEVEL (dBuV/m)	LIMIT (dBuV/m)	MARGIN (dB)	ANTENNA HEIGHT (m)	TABLE ANGLE (Degree)	RAW VALUE (dBuV)	CORRECTION FACTOR (dB/m)
1	5447.00	56.0 PK	74.0	-18.0	1.29 V	108	19.50	36.48
2	5447.00	46.1 AV	54.0	-7.9	1.29 V	108	9.64	36.48
3	#5470.00	67.7 PK	68.3	-0.6	1.30 V	110	31.21	36.51
4	*5500.00	103.6 PK			1.28 V	102	66.99	36.56
5	*5500.00	94.4 AV			1.28 V	102	57.82	36.56
6	11000.00	55.1 PK	74.0	-18.9	1.30 V	99	7.74	47.35
7	11000.00	43.9 AV	54.0	-10.1	1.30 V	99	-3.48	47.35

- REMARKS:**
1. Emission level (dBuV/m) = Raw Value (dBuV) + Correction Factor (dB/m).
 2. Correction Factor (dB/m) = Antenna Factor (dB/m) + Cable Factor (dB).
 3. The other emission levels were very low against the limit.
 4. Margin value = Emission level – Limit value.
 5. “ * “: Fundamental frequency.
 6. "#":The radiated frequency is out the restricted band.



A D T

EUT TEST CONDITION		MEASUREMENT DETAIL	
CHANNEL	Channel 120	FREQUENCY RANGE	1 ~ 40GHz
INPUT POWER (SYSTEM)	120Vac, 60 Hz	DETECTOR FUNCTION	Peak (PK) Average (AV)
ENVIRONMENTAL CONDITIONS	20deg. C, 67%RH 1024 hPa	TESTED BY	Eric Lee

ANTENNA POLARITY & TEST DISTANCE: HORIZONTAL AT 3 M								
NO.	FREQ. (MHz)	EMISSION LEVEL (dBuV/m)	LIMIT (dBuV/m)	MARGIN (dB)	ANTENNA HEIGHT (m)	TABLE ANGLE (Degree)	RAW VALUE (dBuV)	CORRECTION FACTOR (dB/m)
1	*5600.00	95.7 PK			1.34 H	231	58.88	36.82
2	*5600.00	87.4 AV			1.34 H	231	50.58	36.82
3	11200.00	55.8 PK	74.0	-18.2	1.27 H	58	8.64	47.16
4	11200.00	44.7 AV	54.0	-9.3	1.27 H	58	-2.46	47.16

ANTENNA POLARITY & TEST DISTANCE: VERTICAL AT 3 M								
NO.	FREQ. (MHz)	EMISSION LEVEL (dBuV/m)	LIMIT (dBuV/m)	MARGIN (dB)	ANTENNA HEIGHT (m)	TABLE ANGLE (Degree)	RAW VALUE (dBuV)	CORRECTION FACTOR (dB/m)
1	*5600.00	105.1 PK			1.29 V	103	68.29	36.82
2	*5600.00	95.8 AV			1.29 V	103	58.97	36.82
3	11200.00	54.7 PK	74.0	-19.3	1.46 V	87	7.58	47.16
4	11200.00	43.5 AV	54.0	-10.5	1.46 V	87	-3.68	47.16

- REMARKS:**
1. Emission level (dBuV/m) = Raw Value (dBuV) + Correction Factor (dB/m).
 2. Correction Factor (dB/m) = Antenna Factor (dB/m) + Cable Factor (dB).
 3. The other emission levels were very low against the limit.
 4. Margin value = Emission level – Limit value.
 5. “ * “: Fundamental frequency.



A D T

EUT TEST CONDITION		MEASUREMENT DETAIL	
CHANNEL	Channel 140	FREQUENCY RANGE	1 ~ 40GHz
INPUT POWER (SYSTEM)	120Vac, 60 Hz	DETECTOR FUNCTION	Peak (PK) Average (AV)
ENVIRONMENTAL CONDITIONS	20deg. C, 67%RH 1024 hPa	TESTED BY	Eric Lee

ANTENNA POLARITY & TEST DISTANCE: HORIZONTAL AT 3 M								
NO.	FREQ. (MHz)	EMISSION LEVEL (dBuV/m)	LIMIT (dBuV/m)	MARGIN (dB)	ANTENNA HEIGHT (m)	TABLE ANGLE (Degree)	RAW VALUE (dBuV)	CORRECTION FACTOR (dB/m)
1	*5700.00	96.2 PK			1.36 H	242	59.11	37.09
2	*5700.00	87.6 AV			1.36 H	242	50.51	37.09
3	#5725.00	59.6 PK	68.3	-8.7	1.00 H	76	22.49	37.15
4	11400.00	55.7 PK	74.0	-18.3	1.24 H	69	8.63	47.07
5	11400.00	44.2 AV	54.0	-9.8	1.24 H	69	-2.87	47.07
ANTENNA POLARITY & TEST DISTANCE: VERTICAL AT 3 M								
NO.	FREQ. (MHz)	EMISSION LEVEL (dBuV/m)	LIMIT (dBuV/m)	MARGIN (dB)	ANTENNA HEIGHT (m)	TABLE ANGLE (Degree)	RAW VALUE (dBuV)	CORRECTION FACTOR (dB/m)
1	*5700.00	104.9 PK			1.31 V	102	67.80	37.09
2	*5700.00	95.7 AV			1.31 V	102	58.59	37.09
3	#5725.00	67.7 PK	68.3	-0.6	1.30 V	105	30.55	37.15
4	11400.00	54.5 PK	74.0	-19.5	1.38 V	101	7.41	47.07
5	11400.00	43.4 AV	54.0	-10.6	1.38 V	101	-3.68	47.07

- REMARKS:**
1. Emission level (dBuV/m) = Raw Value (dBuV) + Correction Factor (dB/m).
 2. Correction Factor (dB/m) = Antenna Factor (dB/m) + Cable Factor (dB).
 3. The other emission levels were very low against the limit.
 4. Margin value = Emission level – Limit value.
 5. “ * “: Fundamental frequency.
 6. “ # “: The radiated frequency is out the restricted band.



A D T

RESTRICTED BANDEDGE (802.11a MODE, CH36, HORIZONTAL)

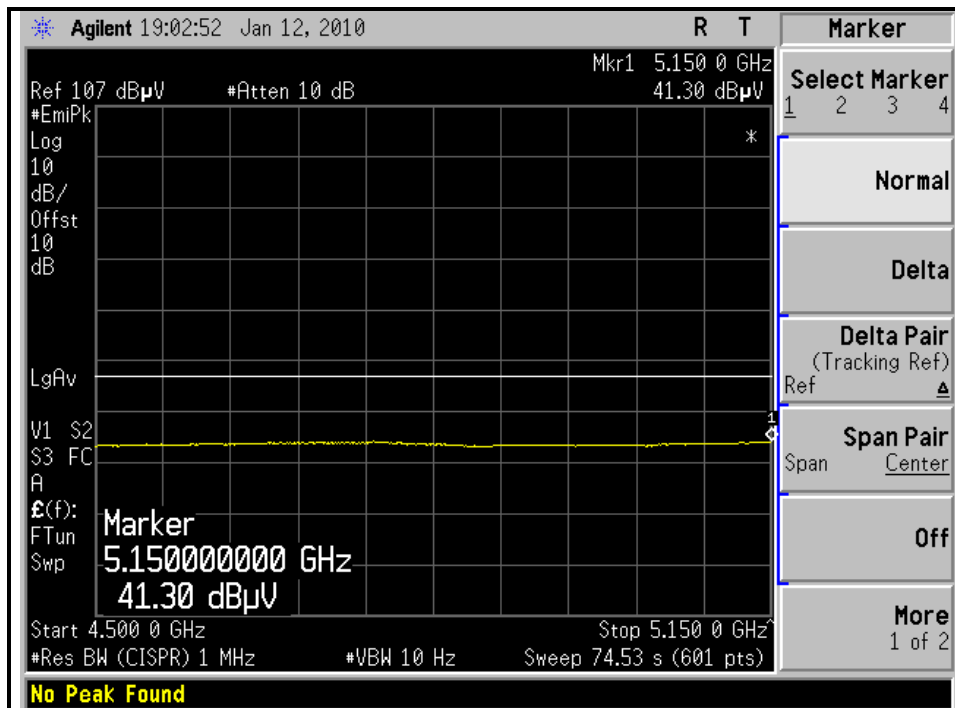
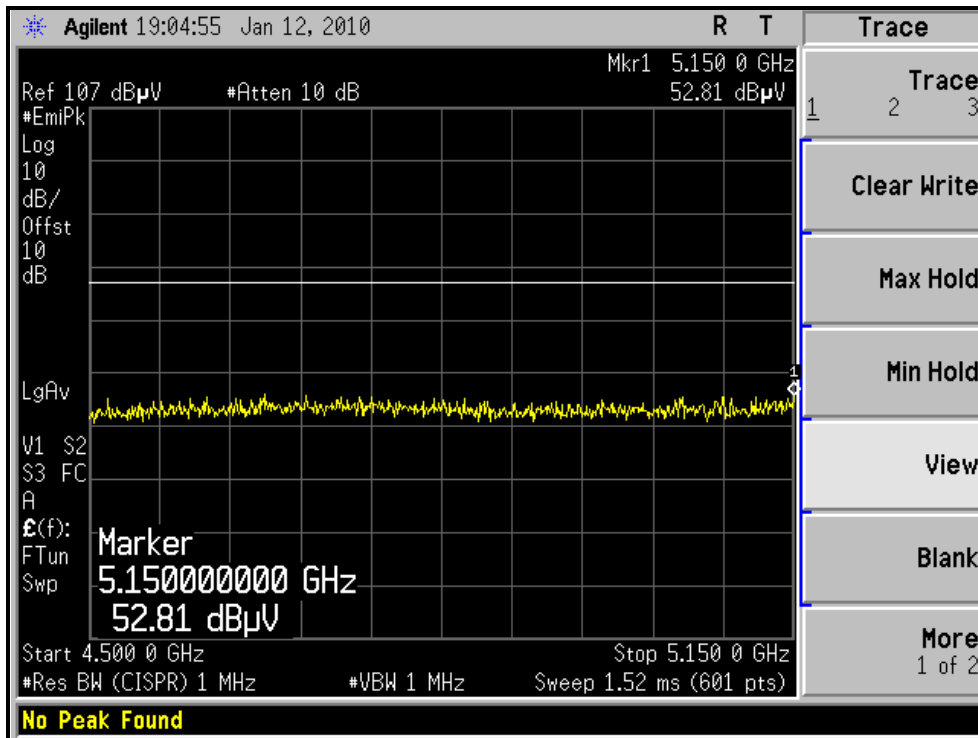



A D T

RESTRICTED BANDEDGE (802.11a MODE, CH36, VERTICAL)

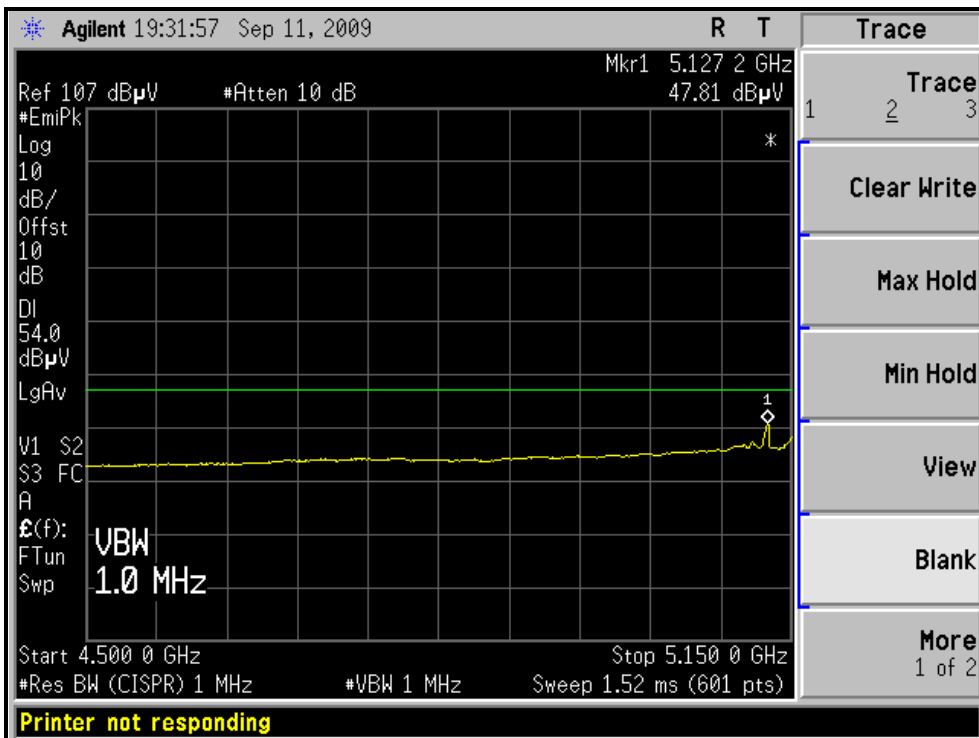
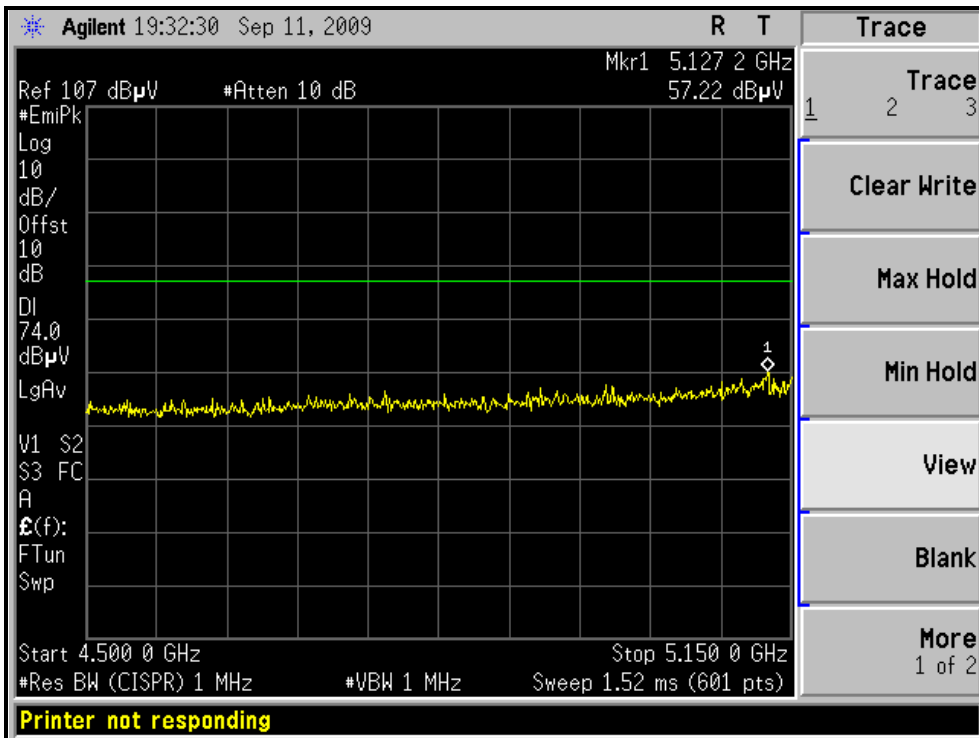



A D T

RESTRICTED BANDEDGE (802.11a MODE, CH64, HORIZONTAL)

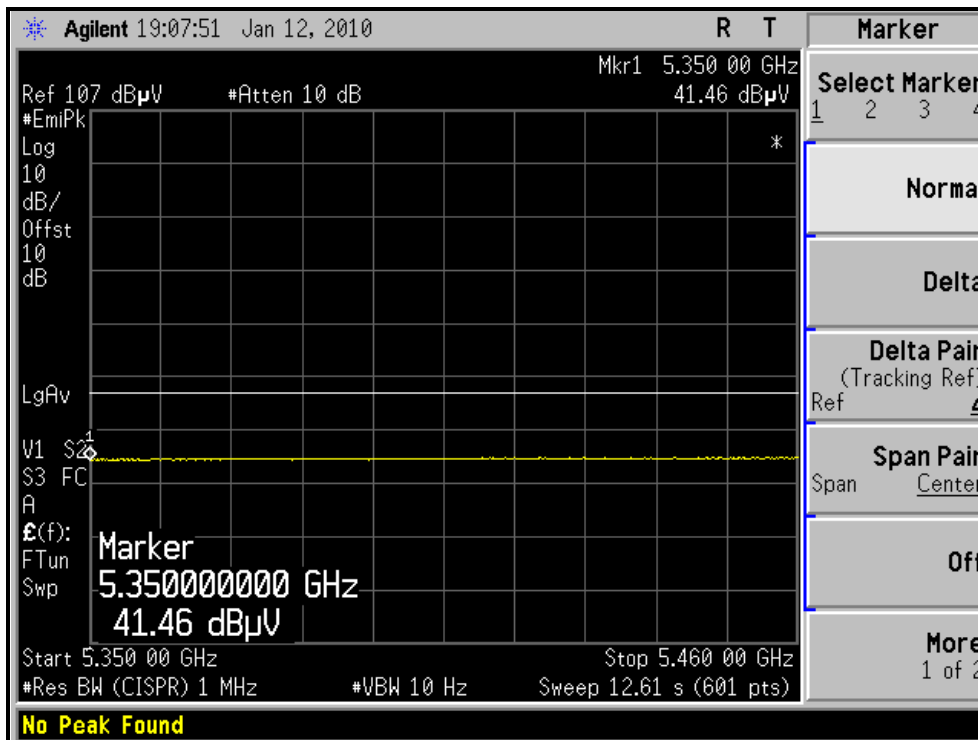
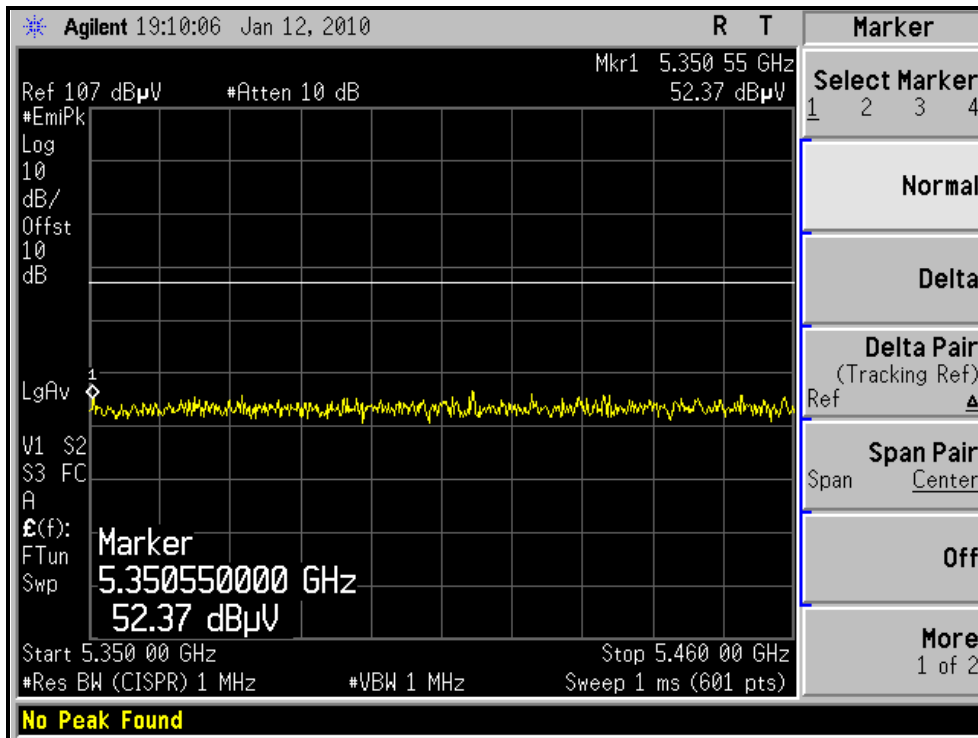



A D T

RESTRICTED BANDEDGE (802.11a MODE, CH64, VERTICAL)

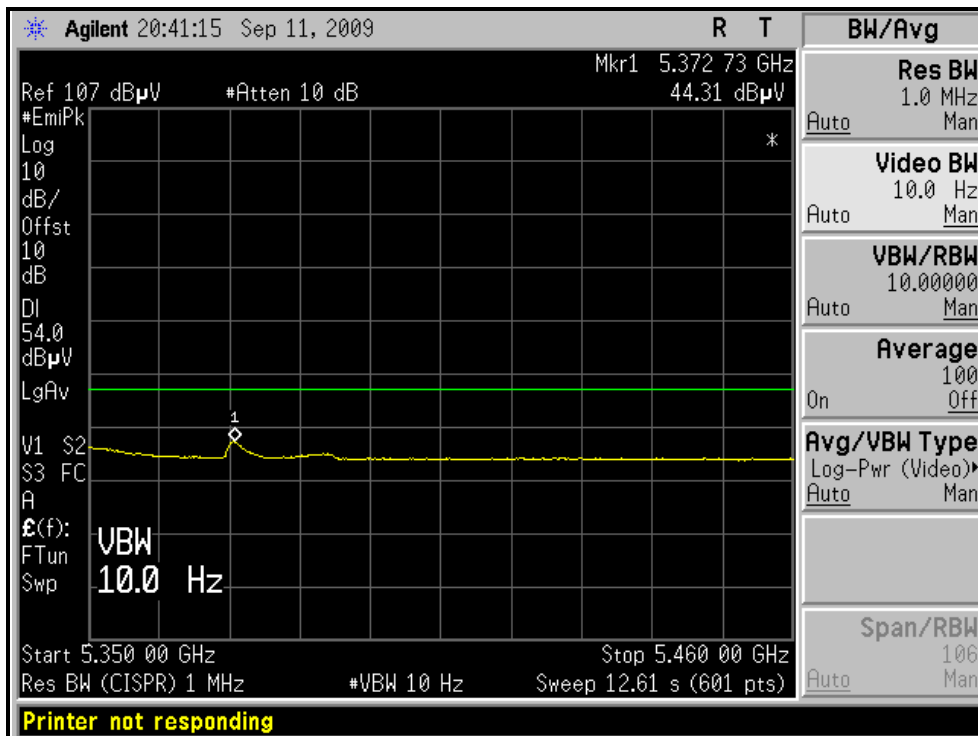
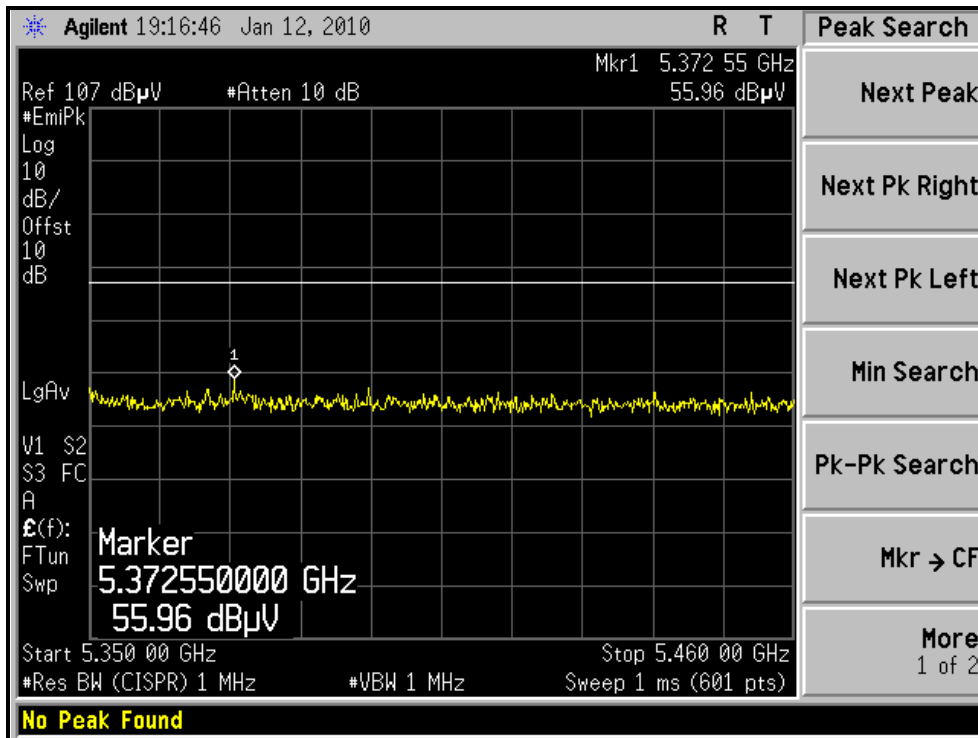



A D T

RESTRICTED BANDEDGE (802.11a MODE, CH100, HORIZONTAL)

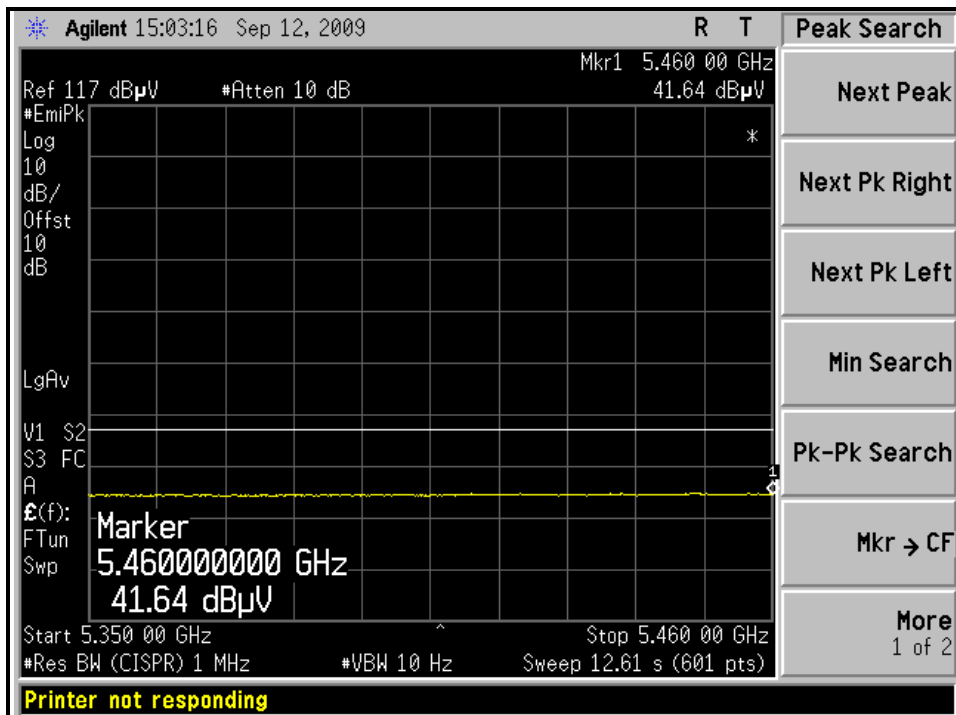
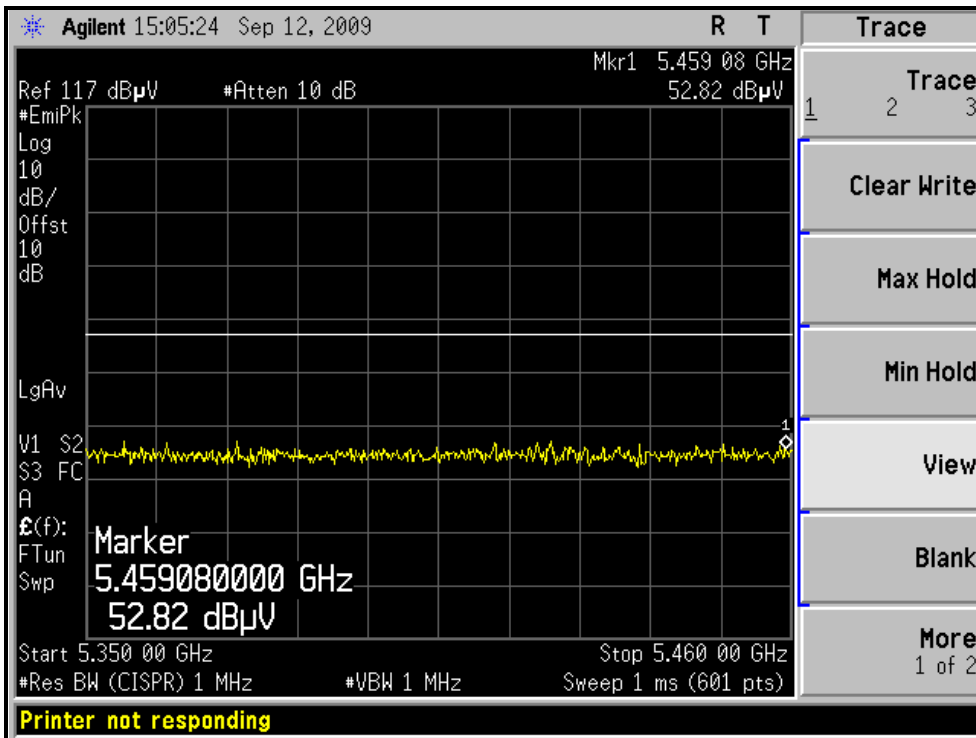



A D T

RESTRICTED BANDEDGE (802.11a MODE, CH100, VERTICAL)

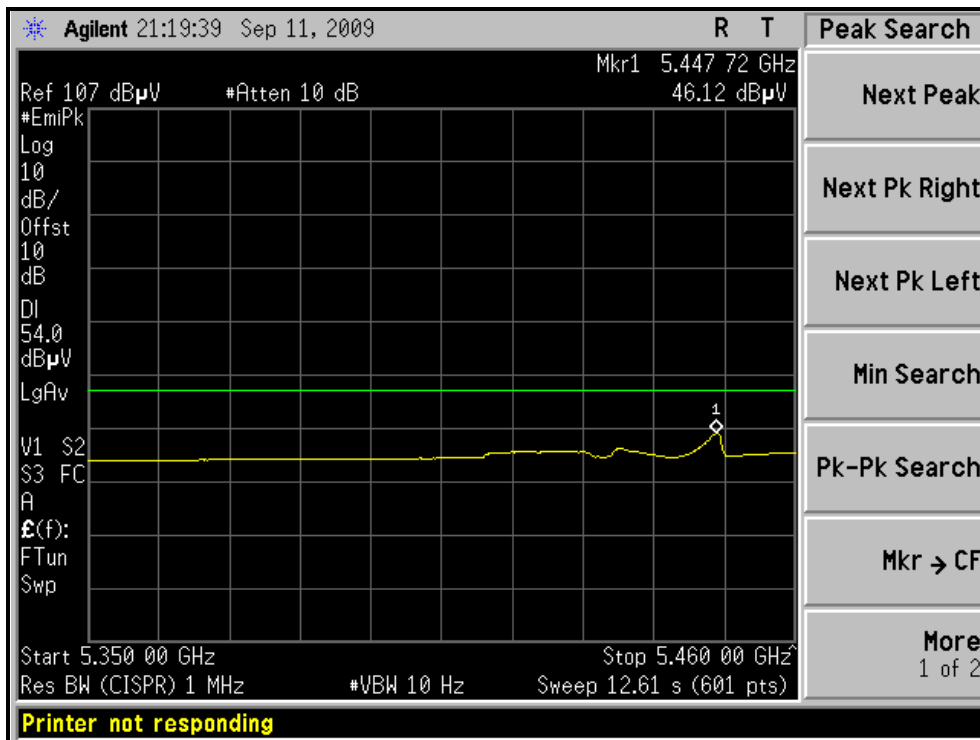
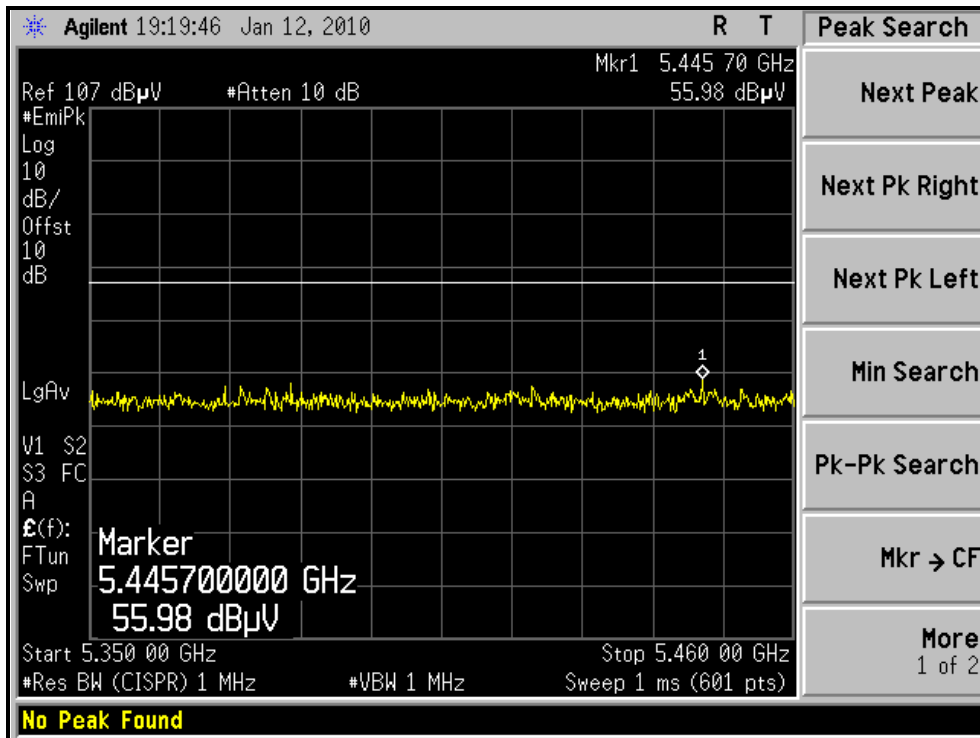



A D T

802.11n (20MHz) OFDM MODULATION

EUT TEST CONDITION		MEASUREMENT DETAIL	
CHANNEL	Channel 36	FREQUENCY RANGE	1 ~ 40GHz
INPUT POWER (SYSTEM)	120Vac, 60 Hz	DETECTOR FUNCTION	Peak (PK) Average (AV)
ENVIRONMENTAL CONDITIONS	10deg. C, 50%RH 1024 hPa	TESTED BY	Eric Lee

ANTENNA POLARITY & TEST DISTANCE: HORIZONTAL AT 3 M								
NO.	FREQ. (MHz)	EMISSION LEVEL (dBuV/m)	LIMIT (dBuV/m)	MARGIN (dB)	ANTENNA HEIGHT (m)	TABLE ANGLE (Degree)	RAW VALUE (dBuV)	CORRECTION FACTOR (dB/m)
1	5128.30	53.8 PK	74.0	-20.2	1.00 H	21	17.80	35.97
2	5128.30	43.9 AV	54.0	-10.1	1.00 H	21	7.89	35.97
3	*5180.00	96.2 PK			1.06 H	69	60.15	36.05
4	*5180.00	86.9 AV			1.06 H	69	50.85	36.05
5	#10360.00	55.6 PK	68.3	-12.7	1.43 H	274	9.45	46.15
ANTENNA POLARITY & TEST DISTANCE: VERTICAL AT 3 M								
NO.	FREQ. (MHz)	EMISSION LEVEL (dBuV/m)	LIMIT (dBuV/m)	MARGIN (dB)	ANTENNA HEIGHT (m)	TABLE ANGLE (Degree)	RAW VALUE (dBuV)	CORRECTION FACTOR (dB/m)
1	5127.20	56.4 PK	74.0	-17.6	1.15 V	144	20.41	35.96
2	5127.20	45.4 AV	54.0	-8.6	1.15 V	144	9.45	35.96
3	*5180.00	105.2 PK			1.10 V	143	69.17	36.05
4	*5180.00	96.9 AV			1.10 V	143	60.80	36.05
5	#10360.00	56.0 PK	68.3	-12.3	1.18 V	143	9.83	46.15

- REMARKS:**
1. Emission level (dBuV/m) = Raw Value (dBuV) + Correction Factor (dB/m).
 2. Correction Factor (dB/m) = Antenna Factor (dB/m) + Cable Factor (dB).
 3. The other emission levels were very low against the limit.
 4. Margin value = Emission level – Limit value.
 5. “ * “: Fundamental frequency.
 6. “#“:The radiated frequency is out the restricted band.



A D T

EUT TEST CONDITION		MEASUREMENT DETAIL	
CHANNEL	Channel 40	FREQUENCY RANGE	1 ~ 40GHz
INPUT POWER (SYSTEM)	120Vac, 60 Hz	DETECTOR FUNCTION	Peak (PK) Average (AV)
ENVIRONMENTAL CONDITIONS	20deg. C, 67%RH 1024 hPa	TESTED BY	Eric Lee

ANTENNA POLARITY & TEST DISTANCE: HORIZONTAL AT 3 M								
NO.	FREQ. (MHz)	EMISSION LEVEL (dBuV/m)	LIMIT (dBuV/m)	MARGIN (dB)	ANTENNA HEIGHT (m)	TABLE ANGLE (Degree)	RAW VALUE (dBuV)	CORRECTION FACTOR (dB/m)
1	*5200.00	96.1 PK			1.04 H	63	60.02	36.08
2	*5200.00	86.3 AV			1.04 H	63	50.22	36.08
3	#10400.00	55.8 PK	68.3	-12.5	1.46 H	277	9.81	45.99
ANTENNA POLARITY & TEST DISTANCE: VERTICAL AT 3 M								
NO.	FREQ. (MHz)	EMISSION LEVEL (dBuV/m)	LIMIT (dBuV/m)	MARGIN (dB)	ANTENNA HEIGHT (m)	TABLE ANGLE (Degree)	RAW VALUE (dBuV)	CORRECTION FACTOR (dB/m)
1	*5200.00	105.5 PK			1.11 V	153	69.40	36.08
2	*5200.00	97.0 AV			1.11 V	153	60.93	36.08
3	#10400.00	56.2 PK	68.3	-12.1	1.27 V	150	10.21	45.99

- REMARKS:**
1. Emission level (dBuV/m) = Raw Value (dBuV) + Correction Factor (dB/m).
 2. Correction Factor (dB/m) = Antenna Factor (dB/m) + Cable Factor (dB).
 3. The other emission levels were very low against the limit.
 4. Margin value = Emission level – Limit value.
 5. “ * “: Fundamental frequency.
 6. "#":The radiated frequency is out the restricted band.



A D T

EUT TEST CONDITION		MEASUREMENT DETAIL	
CHANNEL	Channel 48	FREQUENCY RANGE	1 ~ 40GHz
INPUT POWER (SYSTEM)	120Vac, 60 Hz	DETECTOR FUNCTION	Peak (PK) Average (AV)
ENVIRONMENTAL CONDITIONS	20deg. C, 67%RH 1024 hPa	TESTED BY	Eric Lee

ANTENNA POLARITY & TEST DISTANCE: HORIZONTAL AT 3 M								
NO.	FREQ. (MHz)	EMISSION LEVEL (dBuV/m)	LIMIT (dBuV/m)	MARGIN (dB)	ANTENNA HEIGHT (m)	TABLE ANGLE (Degree)	RAW VALUE (dBuV)	CORRECTION FACTOR (dB/m)
1	*5240.00	95.9 PK			1.04 H	73	59.76	36.14
2	*5240.00	86.2 AV			1.04 H	73	50.06	36.14
3	#10480.00	55.9 PK	68.3	-12.4	1.47 H	284	9.78	46.12
ANTENNA POLARITY & TEST DISTANCE: VERTICAL AT 3 M								
NO.	FREQ. (MHz)	EMISSION LEVEL (dBuV/m)	LIMIT (dBuV/m)	MARGIN (dB)	ANTENNA HEIGHT (m)	TABLE ANGLE (Degree)	RAW VALUE (dBuV)	CORRECTION FACTOR (dB/m)
1	*5240.00	105.3 PK			1.13 V	89	69.19	36.14
2	*5240.00	96.9 AV			1.13 V	89	60.73	36.14
3	#10480.00	55.7 PK	68.3	-12.6	1.43 V	168	9.59	46.12

- REMARKS:**
1. Emission level (dBuV/m) = Raw Value (dBuV) + Correction Factor (dB/m).
 2. Correction Factor (dB/m) = Antenna Factor (dB/m) + Cable Factor (dB).
 3. The other emission levels were very low against the limit.
 4. Margin value = Emission level – Limit value.
 5. “ * “: Fundamental frequency.
 6. “#”:The radiated frequency is out the restricted band.



A D T

EUT TEST CONDITION		MEASUREMENT DETAIL	
CHANNEL	Channel 52	FREQUENCY RANGE	1 ~ 40GHz
INPUT POWER (SYSTEM)	120Vac, 60 Hz	DETECTOR FUNCTION	Peak (PK) Average (AV)
ENVIRONMENTAL CONDITIONS	20deg. C, 67%RH 1024 hPa	TESTED BY	Eric Lee

ANTENNA POLARITY & TEST DISTANCE: HORIZONTAL AT 3 M								
NO.	FREQ. (MHz)	EMISSION LEVEL (dBuV/m)	LIMIT (dBuV/m)	MARGIN (dB)	ANTENNA HEIGHT (m)	TABLE ANGLE (Degree)	RAW VALUE (dBuV)	CORRECTION FACTOR (dB/m)
1	*5260.00	95.8 PK			1.03 H	34	59.62	36.18
2	*5260.00	86.9 AV			1.03 H	34	50.72	36.18
3	#10520.00	56.2 PK	68.3	-12.1	1.54 H	289	10.01	46.19
ANTENNA POLARITY & TEST DISTANCE: VERTICAL AT 3 M								
NO.	FREQ. (MHz)	EMISSION LEVEL (dBuV/m)	LIMIT (dBuV/m)	MARGIN (dB)	ANTENNA HEIGHT (m)	TABLE ANGLE (Degree)	RAW VALUE (dBuV)	CORRECTION FACTOR (dB/m)
1	*5260.00	105.1 PK			1.08 V	150	68.96	36.18
2	*5260.00	96.8 AV			1.08 V	150	60.65	36.18
3	#10520.00	54.9 PK	68.3	-13.4	1.39 V	171	8.74	46.19

- REMARKS:**
1. Emission level (dBuV/m) = Raw Value (dBuV) + Correction Factor (dB/m).
 2. Correction Factor (dB/m) = Antenna Factor (dB/m) + Cable Factor (dB).
 3. The other emission levels were very low against the limit.
 4. Margin value = Emission level – Limit value.
 5. “ * “: Fundamental frequency.
 6. “ # “: The radiated frequency is out the restricted band.



A D T

EUT TEST CONDITION		MEASUREMENT DETAIL	
CHANNEL	Channel 60	FREQUENCY RANGE	1 ~ 40GHz
INPUT POWER (SYSTEM)	120Vac, 60 Hz	DETECTOR FUNCTION	Peak (PK) Average (AV)
ENVIRONMENTAL CONDITIONS	20deg. C, 67%RH 1024 hPa	TESTED BY	Eric Lee

ANTENNA POLARITY & TEST DISTANCE: HORIZONTAL AT 3 M								
NO.	FREQ. (MHz)	EMISSION LEVEL (dBuV/m)	LIMIT (dBuV/m)	MARGIN (dB)	ANTENNA HEIGHT (m)	TABLE ANGLE (Degree)	RAW VALUE (dBuV)	CORRECTION FACTOR (dB/m)
1	*5300.00	95.7 PK			1.00 H	31	59.46	36.24
2	*5300.00	86.4 AV			1.00 H	31	50.16	36.24
3	10600.00	56.4 PK	74.0	-17.6	1.56 H	274	10.03	46.37
4	10600.00	43.6 AV	54.0	-10.4	1.56 H	274	-2.77	46.37

ANTENNA POLARITY & TEST DISTANCE: VERTICAL AT 3 M								
NO.	FREQ. (MHz)	EMISSION LEVEL (dBuV/m)	LIMIT (dBuV/m)	MARGIN (dB)	ANTENNA HEIGHT (m)	TABLE ANGLE (Degree)	RAW VALUE (dBuV)	CORRECTION FACTOR (dB/m)
1	*5300.00	104.9 PK			1.10 V	109	68.63	36.24
2	*5300.00	95.9 AV			1.10 V	109	59.63	36.24
3	10600.00	55.7 PK	74.0	-18.3	1.42 V	182	9.32	46.37
4	10600.00	46.9 AV	54.0	-7.1	1.42 V	182	0.50	46.37

- REMARKS:**
1. Emission level (dBuV/m) = Raw Value (dBuV) + Correction Factor (dB/m).
 2. Correction Factor (dB/m) = Antenna Factor (dB/m) + Cable Factor (dB).
 3. The other emission levels were very low against the limit.
 4. Margin value = Emission level – Limit value.
 5. “ * “: Fundamental frequency.



A D T

EUT TEST CONDITION		MEASUREMENT DETAIL	
CHANNEL	Channel 64	FREQUENCY RANGE	1 ~ 40GHz
INPUT POWER (SYSTEM)	120Vac, 60 Hz	DETECTOR FUNCTION	Peak (PK) Average (AV)
ENVIRONMENTAL CONDITIONS	20deg. C, 67%RH 1024 hPa	TESTED BY	Eric Lee

ANTENNA POLARITY & TEST DISTANCE: HORIZONTAL AT 3 M								
NO.	FREQ. (MHz)	EMISSION LEVEL (dBuV/m)	LIMIT (dBuV/m)	MARGIN (dB)	ANTENNA HEIGHT (m)	TABLE ANGLE (Degree)	RAW VALUE (dBuV)	CORRECTION FACTOR (dB/m)
1	*5320.00	95.4 PK			1.00 H	29	59.13	36.27
2	*5320.00	86.3 AV			1.00 H	29	50.03	36.27
3	5372.10	53.8 PK	74.0	-20.2	1.00 H	34	17.45	36.36
4	5372.10	43.6 AV	54.0	-10.4	1.00 H	34	7.27	36.36
5	10640.00	56.2 PK	74.0	-17.8	1.54 H	289	9.74	46.46
6	10640.00	43.4 AV	54.0	-10.6	1.54 H	289	-3.06	46.46
ANTENNA POLARITY & TEST DISTANCE: VERTICAL AT 3 M								
NO.	FREQ. (MHz)	EMISSION LEVEL (dBuV/m)	LIMIT (dBuV/m)	MARGIN (dB)	ANTENNA HEIGHT (m)	TABLE ANGLE (Degree)	RAW VALUE (dBuV)	CORRECTION FACTOR (dB/m)
1	*5320.00	104.1 PK			1.18 V	104	67.84	36.27
2	*5320.00	95.7 AV			1.18 V	104	59.42	36.27
3	5372.00	57.6 PK	74.0	-16.4	1.07 V	145	21.22	36.36
4	5372.00	47.2 AV	54.0	-6.8	1.07 V	145	10.85	36.36
5	10640.00	56.7 PK	74.0	-17.3	1.39 V	201	10.25	46.46
6	10640.00	45.9 AV	54.0	-8.1	1.39 V	201	-0.58	46.46

- REMARKS:**
1. Emission level (dBuV/m) = Raw Value (dBuV) + Correction Factor (dB/m).
 2. Correction Factor (dB/m) = Antenna Factor (dB/m) + Cable Factor (dB).
 3. The other emission levels were very low against the limit.
 4. Margin value = Emission level – Limit value.
 5. “ * “: Fundamental frequency.



A D T

EUT TEST CONDITION		MEASUREMENT DETAIL	
CHANNEL	Channel 100	FREQUENCY RANGE	1 ~ 40GHz
INPUT POWER (SYSTEM)	120Vac, 60 Hz	DETECTOR FUNCTION	Peak (PK) Average (AV)
ENVIRONMENTAL CONDITIONS	20deg. C, 67%RH 1024 hPa	TESTED BY	Eric Lee

ANTENNA POLARITY & TEST DISTANCE: HORIZONTAL AT 3 M								
NO.	FREQ. (MHz)	EMISSION LEVEL (dBuV/m)	LIMIT (dBuV/m)	MARGIN (dB)	ANTENNA HEIGHT (m)	TABLE ANGLE (Degree)	RAW VALUE (dBuV)	CORRECTION FACTOR (dB/m)
1	5460.00	54.0 PK	74.0	-20.0	1.03 H	25	17.54	36.50
2	5460.00	42.4 AV	54.0	-11.6	1.03 H	25	5.89	36.50
3	#5470.00	58.4 PK	68.3	-9.9	1.24 H	29	21.89	36.51
4	*5500.00	95.6 PK			1.00 H	27	59.07	36.56
5	*5500.00	86.4 AV			1.00 H	27	49.84	36.56
6	11000.00	55.3 PK	74.0	-18.7	1.57 H	312	8.05	47.25
7	11000.00	43.2 AV	54.0	-10.8	1.57 H	312	-4.05	47.25

ANTENNA POLARITY & TEST DISTANCE: VERTICAL AT 3 M								
NO.	FREQ. (MHz)	EMISSION LEVEL (dBuV/m)	LIMIT (dBuV/m)	MARGIN (dB)	ANTENNA HEIGHT (m)	TABLE ANGLE (Degree)	RAW VALUE (dBuV)	CORRECTION FACTOR (dB/m)
1	5447.92	56.63 PK	74.00	-17.37	1.30 V	105	20.15	36.48
2	5447.92	46.47 AV	54.00	-7.53	1.30 V	105	9.99	36.48
3	#5470.00	66.51 PK	68.30	-1.79	1.29 V	100	30.00	36.51
4	*5500.00	104.66 PK			1.26 V	101	68.10	36.56
5	*5500.00	95.86 AV			1.26 V	101	59.30	36.56
6	11000.00	56.45 PK	74.00	-17.55	1.30 V	204	9.20	47.25
7	11000.00	43.94 AV	54.00	-10.06	1.30 V	204	-3.31	47.25

- REMARKS:**
1. Emission level (dBuV/m) = Raw Value (dBuV) + Correction Factor (dB/m).
 2. Correction Factor (dB/m) = Antenna Factor (dB/m) + Cable Factor (dB).
 3. The other emission levels were very low against the limit.
 4. Margin value = Emission level – Limit value.
 5. “ * “: Fundamental frequency.
 6. "#":The radiated frequency is out the restricted band.



A D T

EUT TEST CONDITION		MEASUREMENT DETAIL	
CHANNEL	Channel 120	FREQUENCY RANGE	1 ~ 40GHz
INPUT POWER (SYSTEM)	120Vac, 60 Hz	DETECTOR FUNCTION	Peak (PK) Average (AV)
ENVIRONMENTAL CONDITIONS	20deg. C, 67%RH 1024 hPa	TESTED BY	Eric Lee

ANTENNA POLARITY & TEST DISTANCE: HORIZONTAL AT 3 M								
NO.	FREQ. (MHz)	EMISSION LEVEL (dBuV/m)	LIMIT (dBuV/m)	MARGIN (dB)	ANTENNA HEIGHT (m)	TABLE ANGLE (Degree)	RAW VALUE (dBuV)	CORRECTION FACTOR (dB/m)
1	*5600.00	95.9 PK			1.00 H	32	59.08	36.82
2	*5600.00	86.7 AV			1.00 H	32	49.88	36.82
3	11200.00	55.6 PK	74.0	-18.4	1.54 H	321	8.44	47.16
4	11200.00	43.7 AV	54.0	-10.3	1.54 H	321	-3.46	47.16
ANTENNA POLARITY & TEST DISTANCE: VERTICAL AT 3 M								
NO.	FREQ. (MHz)	EMISSION LEVEL (dBuV/m)	LIMIT (dBuV/m)	MARGIN (dB)	ANTENNA HEIGHT (m)	TABLE ANGLE (Degree)	RAW VALUE (dBuV)	CORRECTION FACTOR (dB/m)
1	*5600.00	105.0 PK			1.28 V	98	68.16	36.82
2	*5600.00	95.9 AV			1.28 V	98	59.12	36.82
3	11200.00	55.8 PK	74.0	-18.2	1.30 V	222	8.68	47.16
4	11200.00	44.3 AV	54.0	-9.7	1.30 V	222	-2.88	47.16

- REMARKS:**
1. Emission level (dBuV/m) = Raw Value (dBuV) + Correction Factor (dB/m).
 2. Correction Factor (dB/m) = Antenna Factor (dB/m) + Cable Factor (dB).
 3. The other emission levels were very low against the limit.
 4. Margin value = Emission level – Limit value.
 5. “ * “: Fundamental frequency.



A D T

EUT TEST CONDITION		MEASUREMENT DETAIL	
CHANNEL	Channel 140	FREQUENCY RANGE	1 ~ 40GHz
INPUT POWER (SYSTEM)	120Vac, 60 Hz	DETECTOR FUNCTION	Peak (PK) Average (AV)
ENVIRONMENTAL CONDITIONS	20deg. C, 67%RH 1024 hPa	TESTED BY	Eric Lee

ANTENNA POLARITY & TEST DISTANCE: HORIZONTAL AT 3 M								
NO.	FREQ. (MHz)	EMISSION LEVEL (dBuV/m)	LIMIT (dBuV/m)	MARGIN (dB)	ANTENNA HEIGHT (m)	TABLE ANGLE (Degree)	RAW VALUE (dBuV)	CORRECTION FACTOR (dB/m)
1	*5700.00	96.2 PK			1.00 H	42	59.11	37.09
2	*5700.00	86.9 AV			1.00 H	42	49.81	37.09
3	#5725.00	56.3 PK	68.3	-12.0	1.59 H	324	19.15	37.15
4	11400.00	55.8 PK	74.0	-18.2	1.59 H	324	8.73	47.07
5	11400.00	43.3 AV	54.0	-10.7	1.59 H	324	-3.77	47.07

ANTENNA POLARITY & TEST DISTANCE: VERTICAL AT 3 M								
NO.	FREQ. (MHz)	EMISSION LEVEL (dBuV/m)	LIMIT (dBuV/m)	MARGIN (dB)	ANTENNA HEIGHT (m)	TABLE ANGLE (Degree)	RAW VALUE (dBuV)	CORRECTION FACTOR (dB/m)
1	*5700.00	105.1 PK			1.31 V	69	68.02	37.09
2	*5700.00	95.9 AV			1.31 V	69	58.82	37.09
3	#5725.00	61.0 PK	68.3	-7.3	1.29 V	78	23.86	37.15
4	11400.00	54.7 PK	74.0	-19.3	1.28 V	61	7.66	47.07
5	11400.00	44.2 AV	54.0	-9.8	1.28 V	61	-2.85	47.07

- REMARKS:**
1. Emission level (dBuV/m) = Raw Value (dBuV) + Correction Factor (dB/m).
 2. Correction Factor (dB/m) = Antenna Factor (dB/m) + Cable Factor (dB).
 3. The other emission levels were very low against the limit.
 4. Margin value = Emission level – Limit value.
 5. “ * “: Fundamental frequency.
 6. “ # “: The radiated frequency is out the restricted band.



A D T

RESTRICTED BANDEDGE (802.11n (20MHz) MODE,CH36, HORIZONTAL)

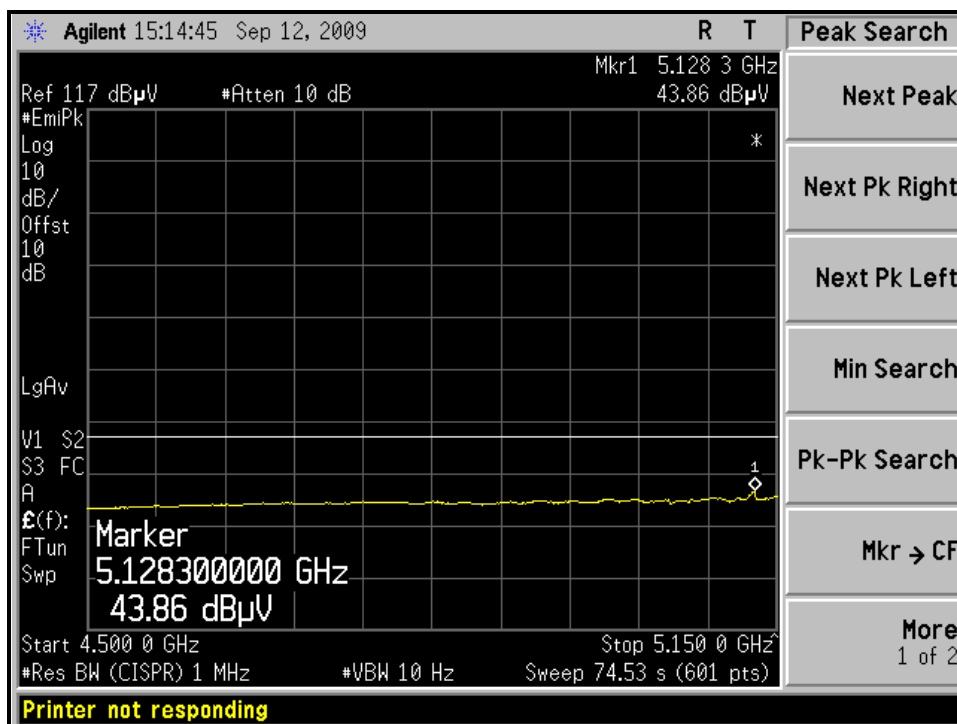
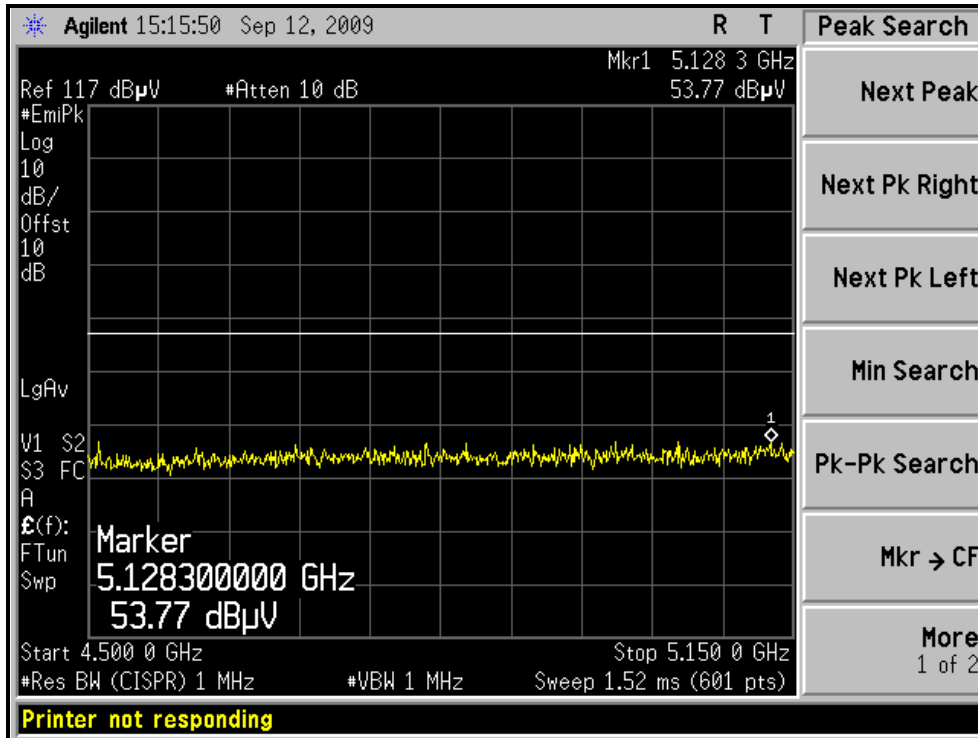



A D T

RESTRICTED BANDEDGE (802.11n (20MHz) MODE,CH36, VERTICAL)

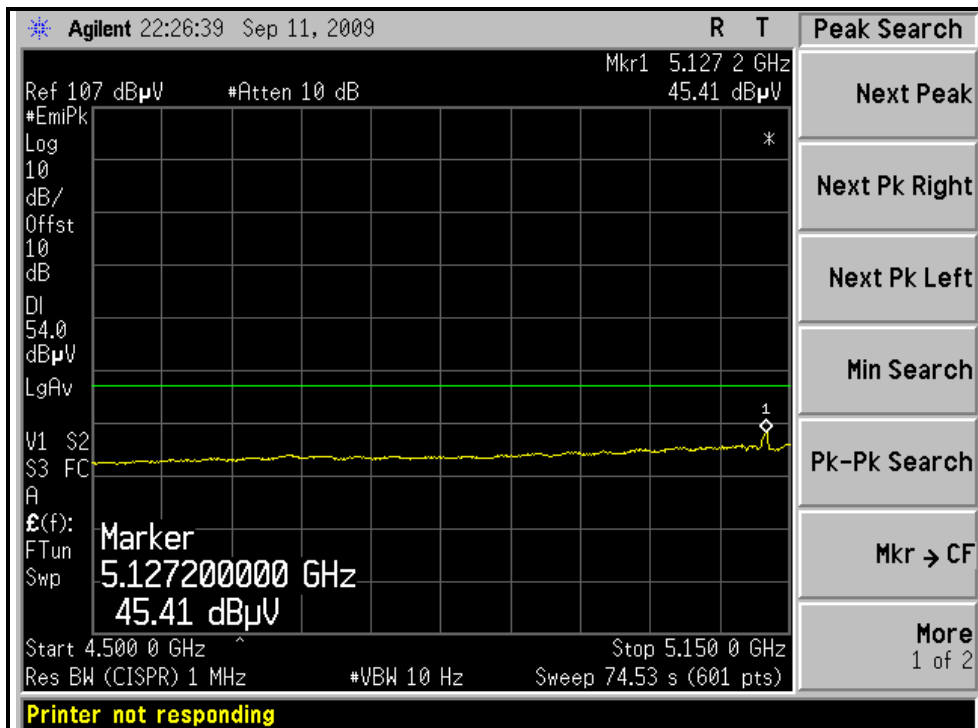
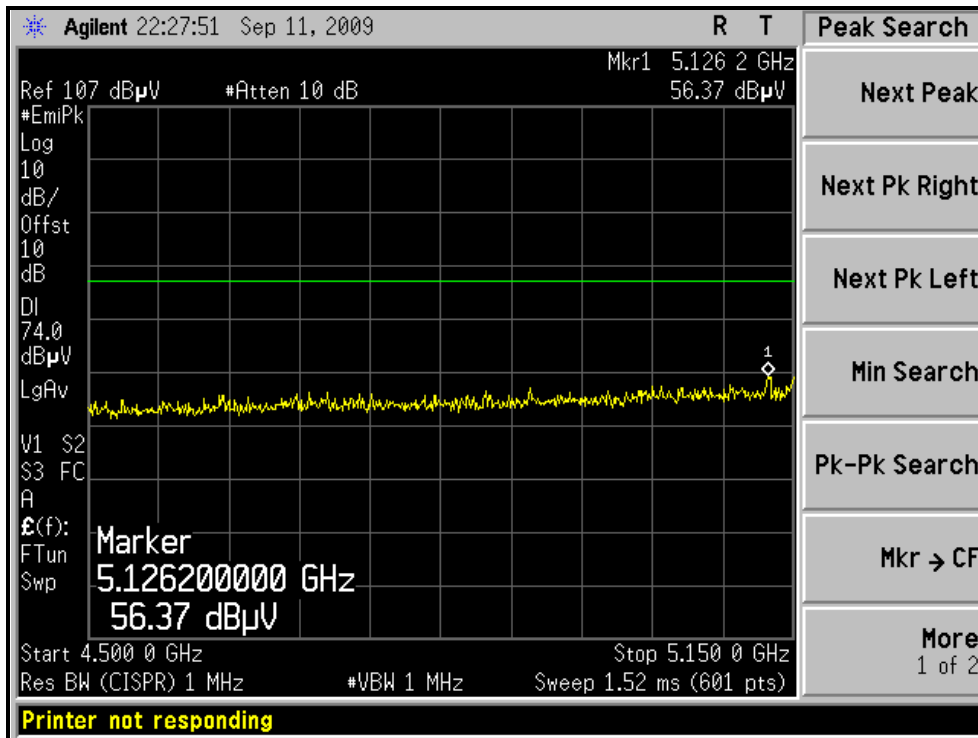



A D T

RESTRICTED BANDEDGE (802.11n (20MHz) MODE,CH64, HORIZONTAL)

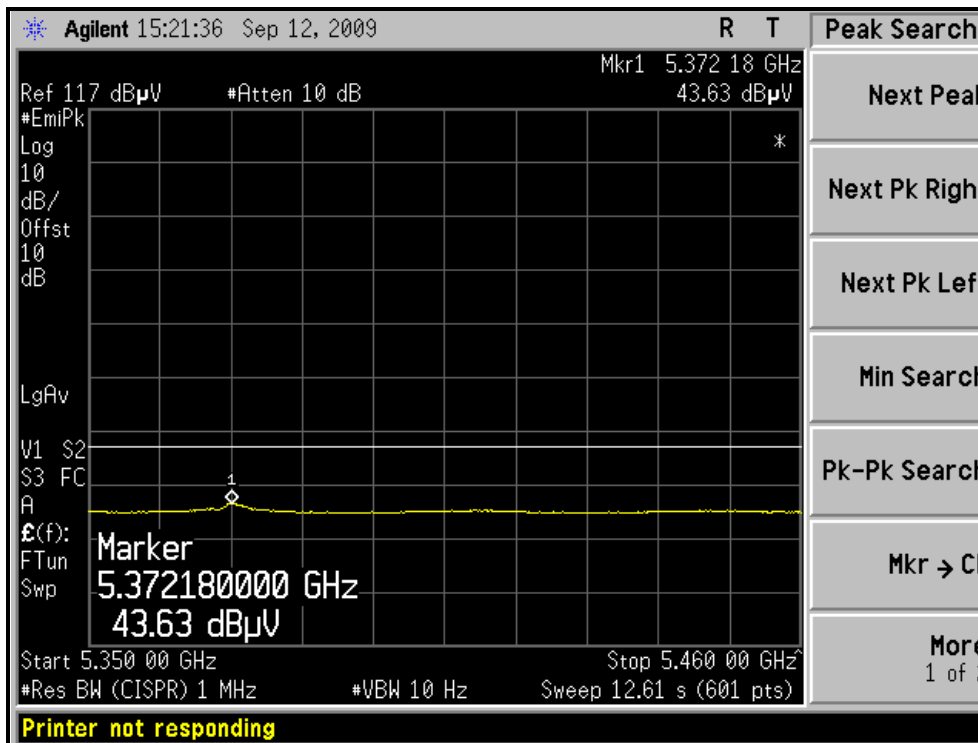
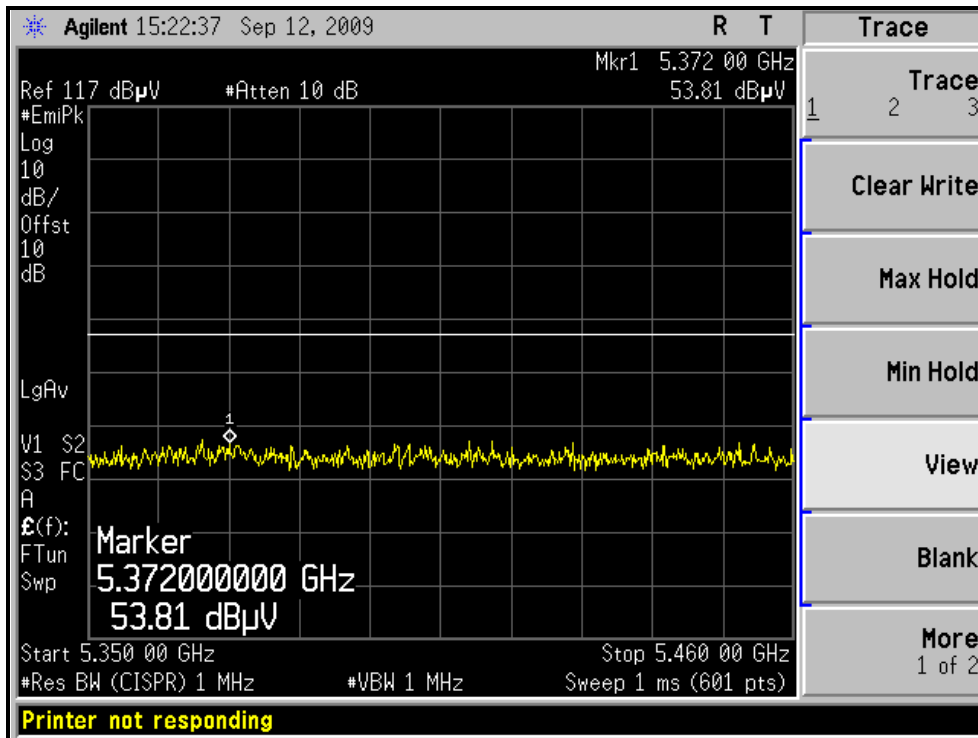



A D T

RESTRICTED BANDEDGE (802.11n (20MHz) MODE,CH64, VERTICAL)

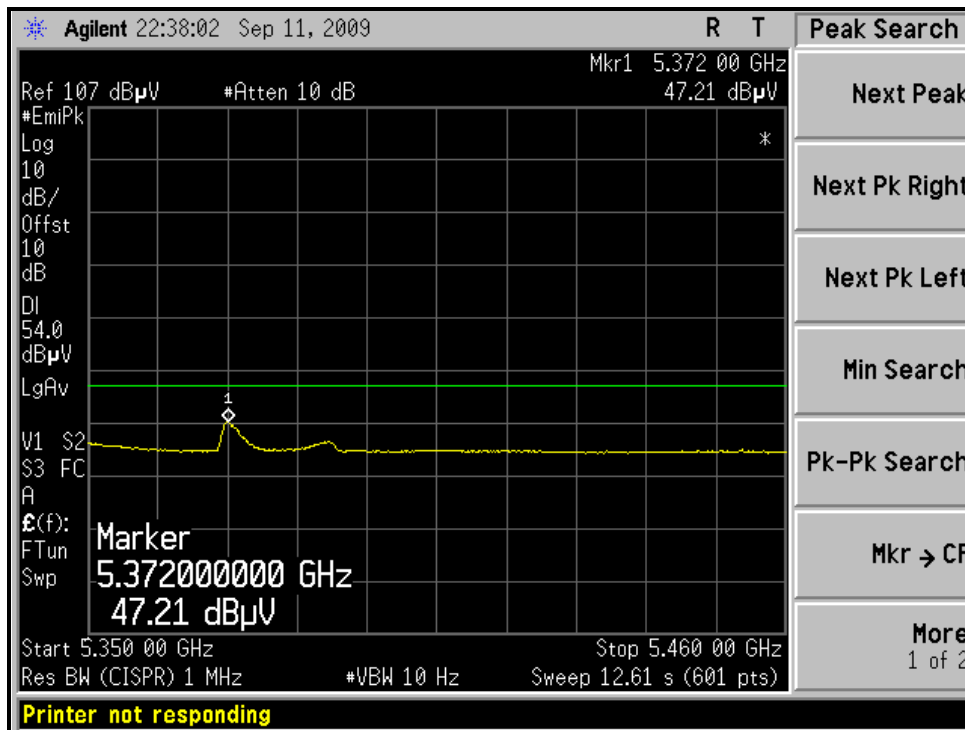
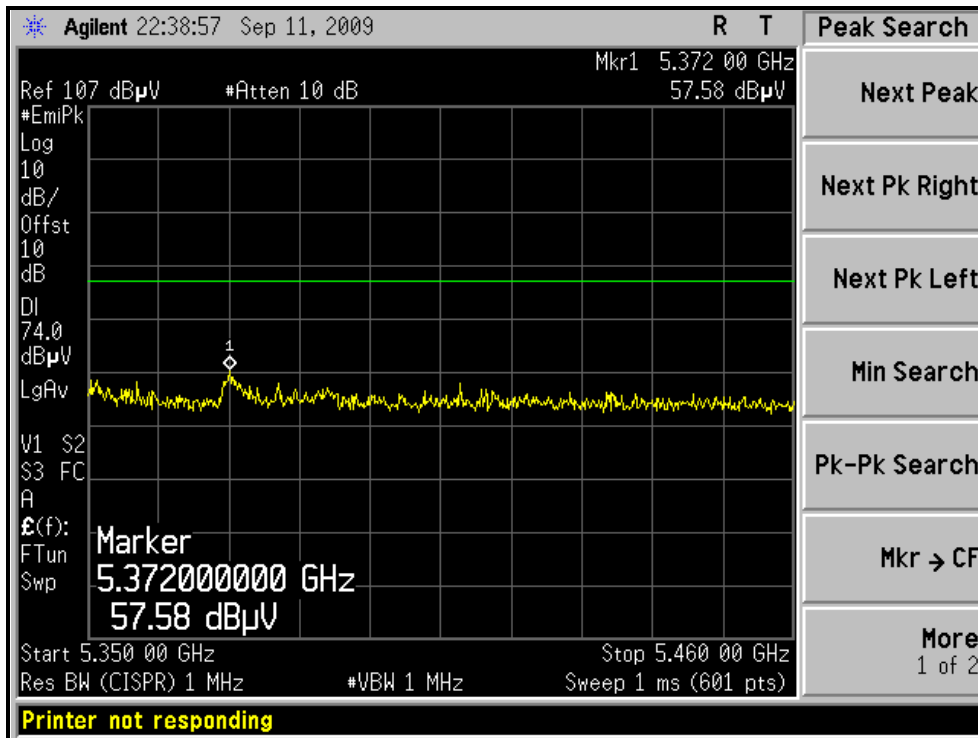



A D T

RESTRICTED BANDEDGE (802.11n (20MHz) MODE, CH100, HORIZONTAL)

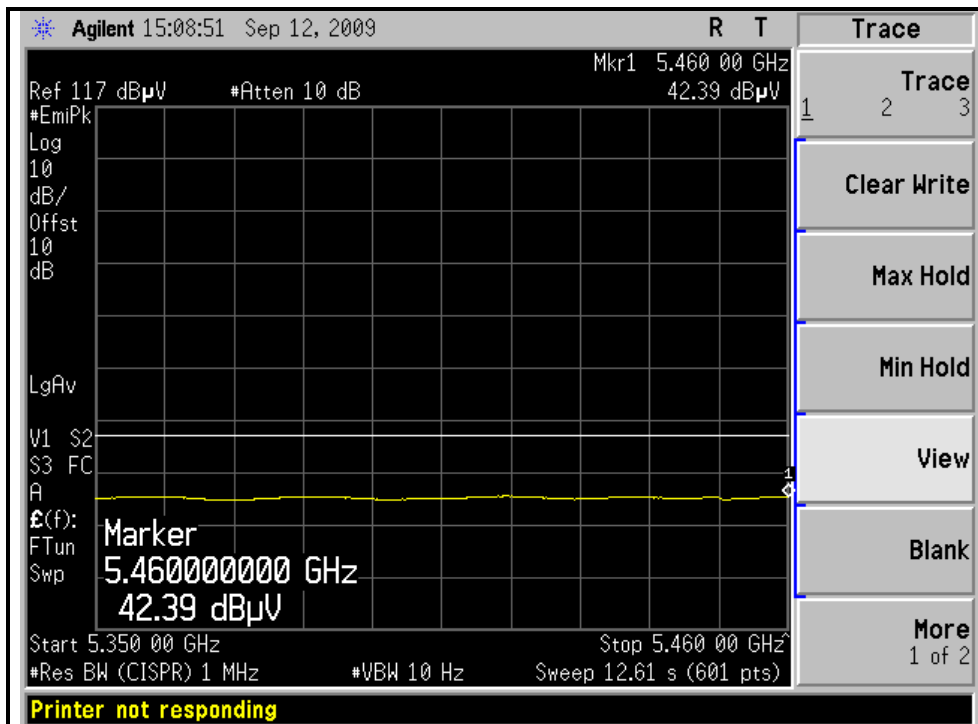
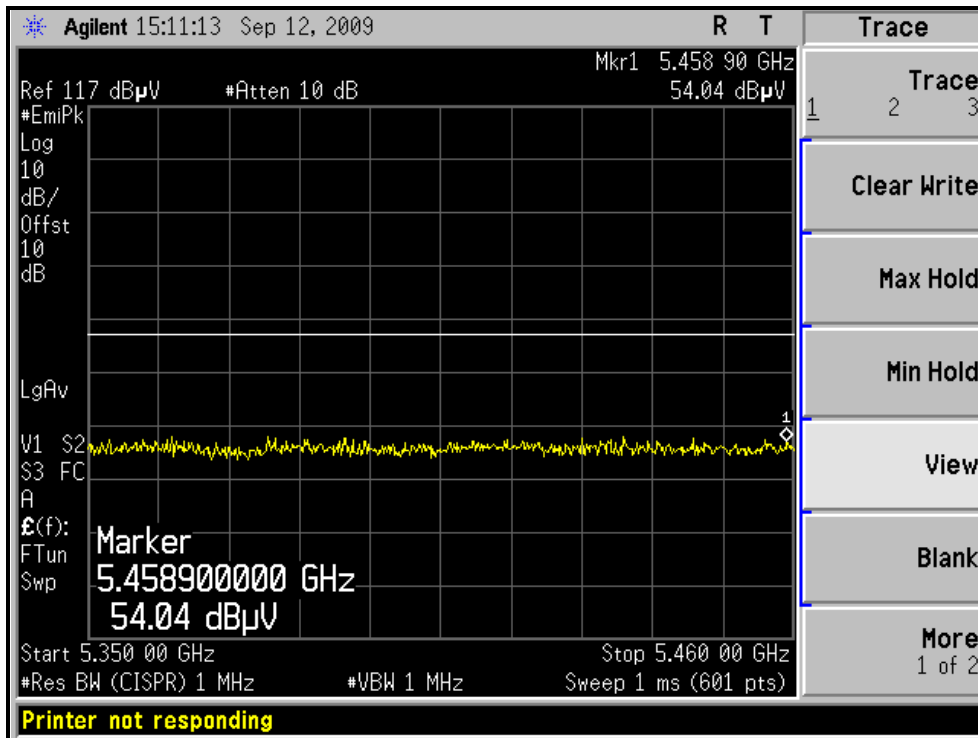



A D T

RESTRICTED BANDEDGE (802.11n (20MHz) MODE,CH100, VERTICAL)

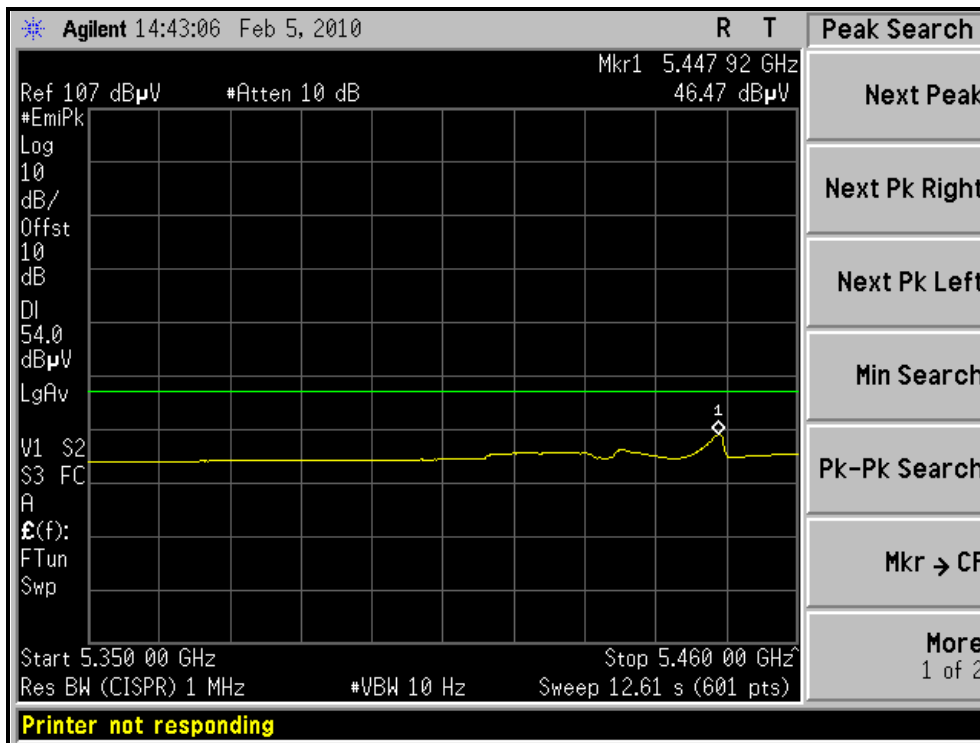
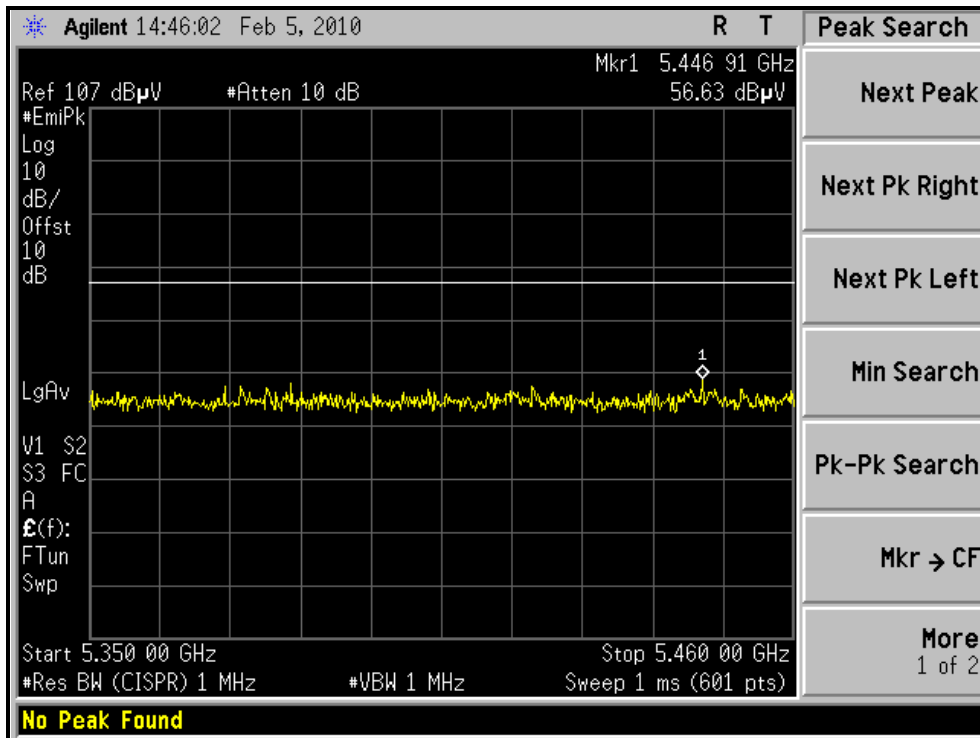



A D T

802.11n (40MHz) OFDM MODULATION

EUT TEST CONDITION		MEASUREMENT DETAIL	
CHANNEL	Channel 38	FREQUENCY RANGE	1 ~ 40GHz
INPUT POWER (SYSTEM)	120Vac, 60 Hz	DETECTOR FUNCTION	Peak (PK) Average (AV)
ENVIRONMENTAL CONDITIONS	20deg. C, 67%RH 1024 hPa	TESTED BY	Eric Lee

ANTENNA POLARITY & TEST DISTANCE: HORIZONTAL AT 3 M								
NO.	FREQ. (MHz)	EMISSION LEVEL (dBuV/m)	LIMIT (dBuV/m)	MARGIN (dB)	ANTENNA HEIGHT (m)	TABLE ANGLE (Degree)	RAW VALUE (dBuV)	CORRECTION FACTOR (dB/m)
1	5146.80	53.9 PK	74.0	-20.1	1.29 H	4	17.93	35.99
2	5146.80	43.2 AV	54.0	-10.8	1.29 H	4	7.23	35.99
3	*5190.00	100.9 PK			1.24 H	73	64.84	36.06
4	*5190.00	90.6 AV			1.24 H	73	54.54	36.06
5	#10380.00	55.4 PK	68.3	-12.9	1.56 H	322	9.44	45.96
6	15570.00	57.1 PK	74.0	-16.9	1.02 H	23	9.25	47.85
7	15570.00	44.6 AV	54.0	-9.4	1.02 H	23	-3.25	47.85

ANTENNA POLARITY & TEST DISTANCE: VERTICAL AT 3 M								
NO.	FREQ. (MHz)	EMISSION LEVEL (dBuV/m)	LIMIT (dBuV/m)	MARGIN (dB)	ANTENNA HEIGHT (m)	TABLE ANGLE (Degree)	RAW VALUE (dBuV)	CORRECTION FACTOR (dB/m)
1	5150.00	65.1 PK	74.0	-8.9	1.26 V	143	29.13	36.00
2	5150.00	53.3 AV	54.0	-0.7	1.26 V	143	17.27	36.00
3	*5190.00	106.3 PK			1.11 V	141	70.24	36.06
4	*5190.00	96.2 AV			1.11 V	141	60.14	36.06
5	#10380.00	55.1 PK	68.3	-13.2	1.57 V	316	9.14	45.96
6	15570.00	57.4 PK	74.0	-16.6	1.03 V	232	9.55	47.85
7	15570.00	45.5 AV	54.0	-8.5	1.03 V	232	-2.35	47.85

- REMARKS:**
1. Emission level (dBuV/m) = Raw Value (dBuV) + Correction Factor (dB/m).
 2. Correction Factor (dB/m) = Antenna Factor (dB/m) + Cable Factor (dB).
 3. The other emission levels were very low against the limit.
 4. Margin value = Emission level – Limit value.
 5. “ * “: Fundamental frequency.
 6. "#":The radiated frequency is out the restricted band.



A D T

EUT TEST CONDITION		MEASUREMENT DETAIL	
CHANNEL	Channel 46	FREQUENCY RANGE	1 ~ 40GHz
INPUT POWER (SYSTEM)	120Vac, 60 Hz	DETECTOR FUNCTION	Peak (PK) Average (AV)
ENVIRONMENTAL CONDITIONS	20deg. C, 67%RH 1024 hPa	TESTED BY	Eric Lee

ANTENNA POLARITY & TEST DISTANCE: HORIZONTAL AT 3 M								
NO.	FREQ. (MHz)	EMISSION LEVEL (dBuV/m)	LIMIT (dBuV/m)	MARGIN (dB)	ANTENNA HEIGHT (m)	TABLE ANGLE (Degree)	RAW VALUE (dBuV)	CORRECTION FACTOR (dB/m)
1	*5230.00	100.7 PK			1.29 H	36	64.57	36.13
2	*5230.00	90.8 AV			1.29 H	36	54.67	36.13
3	#10460.00	56.1 PK	68.3	-12.2	1.57 H	316	10.01	46.09
4	15690.00	57.3 PK	74.0	-16.7	1.00 H	20	9.74	47.56
5	15690.00	44.7 AV	54.0	-9.3	1.00 H	20	-2.86	47.56

ANTENNA POLARITY & TEST DISTANCE: VERTICAL AT 3 M								
NO.	FREQ. (MHz)	EMISSION LEVEL (dBuV/m)	LIMIT (dBuV/m)	MARGIN (dB)	ANTENNA HEIGHT (m)	TABLE ANGLE (Degree)	RAW VALUE (dBuV)	CORRECTION FACTOR (dB/m)
1	*5230.00	106.7 PK			1.10 V	146	70.57	36.13
2	*5230.00	96.4 AV			1.10 V	146	60.27	36.13
3	#10460.00	55.2 PK	68.3	-13.1	1.44 V	6	9.11	46.09
4	15690.00	57.6 PK	74.0	-16.4	1.04 V	219	10.04	47.56
5	15690.00	45.1 AV	54.0	-8.9	1.04 V	219	-2.46	47.56

- REMARKS:**
1. Emission level (dBuV/m) = Raw Value (dBuV) + Correction Factor (dB/m).
 2. Correction Factor (dB/m) = Antenna Factor (dB/m) + Cable Factor (dB).
 3. The other emission levels were very low against the limit.
 4. Margin value = Emission level – Limit value.
 5. “ * “: Fundamental frequency.
 6. “#”:The radiated frequency is out the restricted band.



A D T

EUT TEST CONDITION		MEASUREMENT DETAIL	
CHANNEL	Channel 54	FREQUENCY RANGE	1 ~ 40GHz
INPUT POWER (SYSTEM)	120Vac, 60 Hz	DETECTOR FUNCTION	Peak (PK) Average (AV)
ENVIRONMENTAL CONDITIONS	20deg. C, 67%RH 1024 hPa	TESTED BY	Eric Lee

ANTENNA POLARITY & TEST DISTANCE: HORIZONTAL AT 3 M								
NO.	FREQ. (MHz)	EMISSION LEVEL (dBuV/m)	LIMIT (dBuV/m)	MARGIN (dB)	ANTENNA HEIGHT (m)	TABLE ANGLE (Degree)	RAW VALUE (dBuV)	CORRECTION FACTOR (dB/m)
1	*5270.00	100.3 PK			1.31 H	34	64.11	36.19
2	*5270.00	90.4 AV			1.31 H	34	54.21	36.19
3	#10540.00	55.7 PK	68.3	-12.6	1.54 H	324	9.46	46.24
4	15810.00	57.4 PK	74.0	-16.6	1.03 H	24	10.15	47.25
5	15810.00	44.9 AV	54.0	-9.1	1.03 H	24	-2.35	47.25

ANTENNA POLARITY & TEST DISTANCE: VERTICAL AT 3 M								
NO.	FREQ. (MHz)	EMISSION LEVEL (dBuV/m)	LIMIT (dBuV/m)	MARGIN (dB)	ANTENNA HEIGHT (m)	TABLE ANGLE (Degree)	RAW VALUE (dBuV)	CORRECTION FACTOR (dB/m)
1	*5270.00	105.4 PK			1.04 V	137	69.21	36.19
2	*5270.00	96.6 AV			1.04 V	137	60.41	36.19
3	#10540.00	55.6 PK	68.3	-12.7	1.44 V	9	9.36	46.24
4	15810.00	57.6 PK	74.0	-16.4	1.02 V	231	10.35	47.25
5	15810.00	45.4 AV	54.0	-8.6	1.02 V	231	-1.85	47.25

- REMARKS:**
1. Emission level (dBuV/m) = Raw Value (dBuV) + Correction Factor (dB/m).
 2. Correction Factor (dB/m) = Antenna Factor (dB/m) + Cable Factor (dB).
 3. The other emission levels were very low against the limit.
 4. Margin value = Emission level – Limit value.
 5. “ * “: Fundamental frequency.
 6. “#”:The radiated frequency is out the restricted band.



A D T

EUT TEST CONDITION		MEASUREMENT DETAIL	
CHANNEL	Channel 62	FREQUENCY RANGE	1 ~ 40GHz
INPUT POWER (SYSTEM)	120Vac, 60 Hz	DETECTOR FUNCTION	Peak (PK) Average (AV)
ENVIRONMENTAL CONDITIONS	20deg. C, 67%RH 1024 hPa	TESTED BY	Eric Lee

ANTENNA POLARITY & TEST DISTANCE: HORIZONTAL AT 3 M

NO.	FREQ. (MHz)	EMISSION LEVEL (dBuV/m)	LIMIT (dBuV/m)	MARGIN (dB)	ANTENNA HEIGHT (m)	TABLE ANGLE (Degree)	RAW VALUE (dBuV)	CORRECTION FACTOR (dB/m)
1	*5310.00	100.6 PK			1.32 H	20	64.34	36.26
2	*5310.00	90.6 AV			1.32 H	20	54.34	36.26
3	5350.00	62.5 PK	74.0	-11.5	1.33 H	19	26.19	36.32
4	5350.00	49.3 AV	54.0	-4.7	1.33 H	19	12.94	36.32
5	10620.00	57.1 PK	74.0	-16.9	1.54 H	311	10.69	46.41
6	10620.00	44.2 AV	54.0	-9.8	1.54 H	311	-2.21	46.41
7	15930.00	57.6 PK	74.0	-16.4	1.00 H	24	10.65	46.95
8	15930.00	45.7 AV	54.0	-8.3	1.00 H	24	-1.25	46.95

ANTENNA POLARITY & TEST DISTANCE: VERTICAL AT 3 M

NO.	FREQ. (MHz)	EMISSION LEVEL (dBuV/m)	LIMIT (dBuV/m)	MARGIN (dB)	ANTENNA HEIGHT (m)	TABLE ANGLE (Degree)	RAW VALUE (dBuV)	CORRECTION FACTOR (dB/m)
1	*5310.00	105.4 PK			1.08 V	144	69.14	36.26
2	*5310.00	97.0 AV			1.08 V	144	60.74	36.26
3	5350.00	66.7 PK	74.0	-7.3	1.07 V	143	30.38	36.32
4	5350.00	52.3 AV	54.0	-1.7	1.07 V	143	15.97	36.32
5	10620.00	57.6 PK	74.0	-16.4	1.60 V	0	11.19	46.41
6	10620.00	44.7 AV	54.0	-9.3	1.60 V	0	-1.71	46.41
7	15930.00	57.2 PK	74.0	-16.8	1.06 V	231	10.25	46.95
8	15930.00	45.2 AV	54.0	-8.8	1.06 V	231	-1.75	46.95

- REMARKS:**
1. Emission level (dBuV/m) = Raw Value (dBuV) + Correction Factor (dB/m).
 2. Correction Factor (dB/m) = Antenna Factor (dB/m) + Cable Factor (dB).
 3. The other emission levels were very low against the limit.
 4. Margin value = Emission level – Limit value.
 5. “ * “: Fundamental frequency.



A D T

EUT TEST CONDITION		MEASUREMENT DETAIL	
CHANNEL	Channel 102	FREQUENCY RANGE	1 ~ 40GHz
INPUT POWER (SYSTEM)	120Vac, 60 Hz	DETECTOR FUNCTION	Peak (PK) Average (AV)
ENVIRONMENTAL CONDITIONS	20deg. C, 67%RH 1024 hPa	TESTED BY	Eric Lee

ANTENNA POLARITY & TEST DISTANCE: HORIZONTAL AT 3 M								
NO.	FREQ. (MHz)	EMISSION LEVEL (dBuV/m)	LIMIT (dBuV/m)	MARGIN (dB)	ANTENNA HEIGHT (m)	TABLE ANGLE (Degree)	RAW VALUE (dBuV)	CORRECTION FACTOR (dB/m)
1	5407.00	55.7 PK	74.0	-18.3	1.33 H	20	19.25	36.41
2	5407.00	43.6 AV	54.0	-10.4	1.33 H	20	7.20	36.41
3	#5470.00	59.2 PK	68.3	-9.1	1.13 H	351	22.69	36.51
4	*5510.00	100.2 PK			1.33 H	19	63.61	36.59
5	*5510.00	90.3 AV			1.33 H	19	53.71	36.59
6	11020.00	57.4 PK	74.0	-16.6	1.59 H	314	10.16	47.24
7	11020.00	44.6 AV	54.0	-9.4	1.59 H	314	-2.64	47.24

ANTENNA POLARITY & TEST DISTANCE: VERTICAL AT 3 M								
NO.	FREQ. (MHz)	EMISSION LEVEL (dBuV/m)	LIMIT (dBuV/m)	MARGIN (dB)	ANTENNA HEIGHT (m)	TABLE ANGLE (Degree)	RAW VALUE (dBuV)	CORRECTION FACTOR (dB/m)
1	5407.38	57.6 PK	74.0	-16.4	1.06 V	105	21.16	36.41
2	5407.38	46.7 AV	54.0	-7.3	1.06 V	105	10.33	36.41
3	#5470.00	66.5 PK	68.3	-1.9	1.27 V	147	29.94	36.51
4	*5510.00	103.7 PK			1.16 V	140	67.11	36.59
5	*5510.00	96.0 AV			1.16 V	140	59.41	36.59
6	11020.00	55.4 PK	74.0	-18.6	1.64 V	12	8.16	47.24
7	11020.00	44.3 AV	54.0	-9.7	1.64 V	12	-2.94	47.24
8	#16530.00	60.7 PK	68.3	-7.6	1.04 V	31	13.12	47.58

- REMARKS:**
1. Emission level (dBuV/m) = Raw Value (dBuV) + Correction Factor (dB/m).
 2. Correction Factor (dB/m) = Antenna Factor (dB/m) + Cable Factor (dB).
 3. The other emission levels were very low against the limit.
 4. Margin value = Emission level – Limit value.
 5. “ * “: Fundamental frequency.
 6. “#”: The radiated frequency is out the restricted band.



A D T

EUT TEST CONDITION		MEASUREMENT DETAIL	
CHANNEL	Channel 118	FREQUENCY RANGE	1 ~ 40GHz
INPUT POWER (SYSTEM)	120Vac, 60 Hz	DETECTOR FUNCTION	Peak (PK) Average (AV)
ENVIRONMENTAL CONDITIONS	20deg. C, 67%RH 1024 hPa	TESTED BY	Eric Lee

ANTENNA POLARITY & TEST DISTANCE: HORIZONTAL AT 3 M								
NO.	FREQ. (MHz)	EMISSION LEVEL (dBuV/m)	LIMIT (dBuV/m)	MARGIN (dB)	ANTENNA HEIGHT (m)	TABLE ANGLE (Degree)	RAW VALUE (dBuV)	CORRECTION FACTOR (dB/m)
1	*5590.00	100.4 PK			1.13 H	352	63.60	36.80
2	*5590.00	90.1 AV			1.13 H	352	53.30	36.80
3	11180.00	58.2 PK	74.0	-15.8	1.54 H	326	11.03	47.17
4	11180.00	44.7 AV	54.0	-9.3	1.54 H	326	-2.47	47.17
ANTENNA POLARITY & TEST DISTANCE: VERTICAL AT 3 M								
NO.	FREQ. (MHz)	EMISSION LEVEL (dBuV/m)	LIMIT (dBuV/m)	MARGIN (dB)	ANTENNA HEIGHT (m)	TABLE ANGLE (Degree)	RAW VALUE (dBuV)	CORRECTION FACTOR (dB/m)
1	*5590.00	105.3 PK			1.14 V	137	68.50	36.80
2	*5590.00	97.4 AV			1.14 V	137	60.60	36.80
3	11180.00	55.1 PK	74.0	-18.9	1.60 V	10	7.93	47.17
4	11180.00	44.2 AV	54.0	-9.8	1.60 V	10	-2.97	47.17
5	#16770.00	60.6 PK	68.3	-7.7	1.05 V	27	12.14	48.46

- REMARKS:**
1. Emission level (dBuV/m) = Raw Value (dBuV) + Correction Factor (dB/m).
 2. Correction Factor (dB/m) = Antenna Factor (dB/m) + Cable Factor (dB).
 3. The other emission levels were very low against the limit.
 4. Margin value = Emission level – Limit value.
 5. “ * “: Fundamental frequency.
 6. "#":The radiated frequency is out the restricted band.



A D T

EUT TEST CONDITION		MEASUREMENT DETAIL	
CHANNEL	Channel 134	FREQUENCY RANGE	1 ~ 40GHz
INPUT POWER (SYSTEM)	120Vac, 60 Hz	DETECTOR FUNCTION	Peak (PK) Average (AV)
ENVIRONMENTAL CONDITIONS	20deg. C, 67%RH 1024 hPa	TESTED BY	Eric Lee

ANTENNA POLARITY & TEST DISTANCE: HORIZONTAL AT 3 M								
NO.	FREQ. (MHz)	EMISSION LEVEL (dBuV/m)	LIMIT (dBuV/m)	MARGIN (dB)	ANTENNA HEIGHT (m)	TABLE ANGLE (Degree)	RAW VALUE (dBuV)	CORRECTION FACTOR (dB/m)
1	*5670.00	100.0 PK			1.14 H	347	62.99	37.01
2	*5670.00	90.6 AV			1.14 H	347	53.59	37.01
3	#5725.00	54.2 PK	68.3	-14.1	1.14 H	349	17.05	37.15
4	11340.00	57.9 PK	74.0	-16.1	1.57 H	319	10.80	47.10
5	11340.00	44.8 AV	54.0	-9.2	1.57 H	319	-2.30	47.10
ANTENNA POLARITY & TEST DISTANCE: VERTICAL AT 3 M								
NO.	FREQ. (MHz)	EMISSION LEVEL (dBuV/m)	LIMIT (dBuV/m)	MARGIN (dB)	ANTENNA HEIGHT (m)	TABLE ANGLE (Degree)	RAW VALUE (dBuV)	CORRECTION FACTOR (dB/m)
1	*5670.00	105.4 PK			1.16 V	121	68.39	37.01
2	*5670.00	97.2 AV			1.16 V	121	60.19	37.01
3	#5725.00	56.1 PK	68.3	-12.2	1.00 V	142	18.95	37.15
4	11340.00	55.4 PK	74.0	-18.6	1.52 V	13	8.30	47.10
5	11340.00	44.6 AV	54.0	-9.4	1.52 V	13	-2.50	47.10
6	#17010.00	60.8 PK	68.3	-7.5	1.00 V	26	11.44	49.36

- REMARKS:**
1. Emission level (dBuV/m) = Raw Value (dBuV) + Correction Factor (dB/m).
 2. Correction Factor (dB/m) = Antenna Factor (dB/m) + Cable Factor (dB).
 3. The other emission levels were very low against the limit.
 4. Margin value = Emission level – Limit value.
 5. “ * “: Fundamental frequency.
 6. “#”: The radiated frequency is out the restricted band.



A D T

RESTRICTED BANDEDGE (802.11n (40MHz) MODE, CH38, HORIZONTAL)

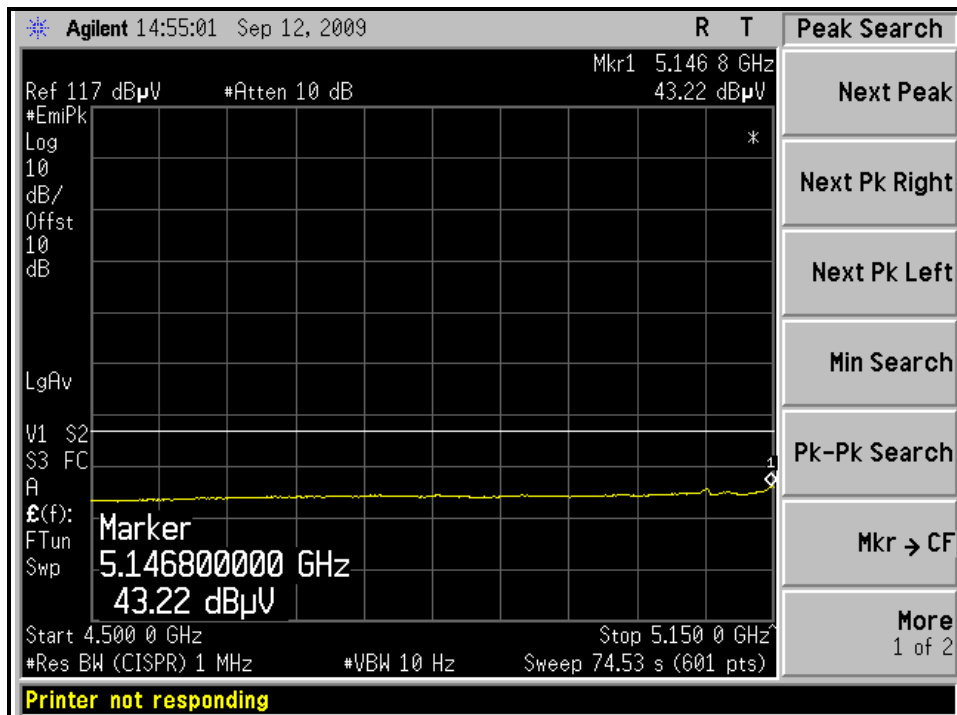
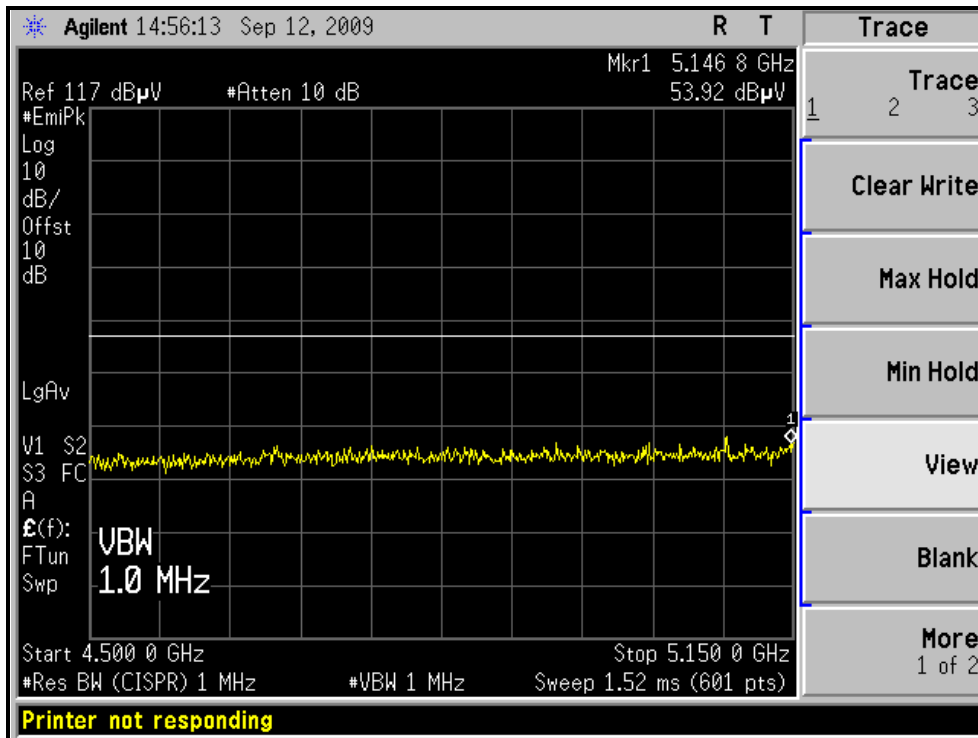



A D T

RESTRICTED BANDEDGE (802.11n (40MHz) MODE,CH38, VERTICAL)

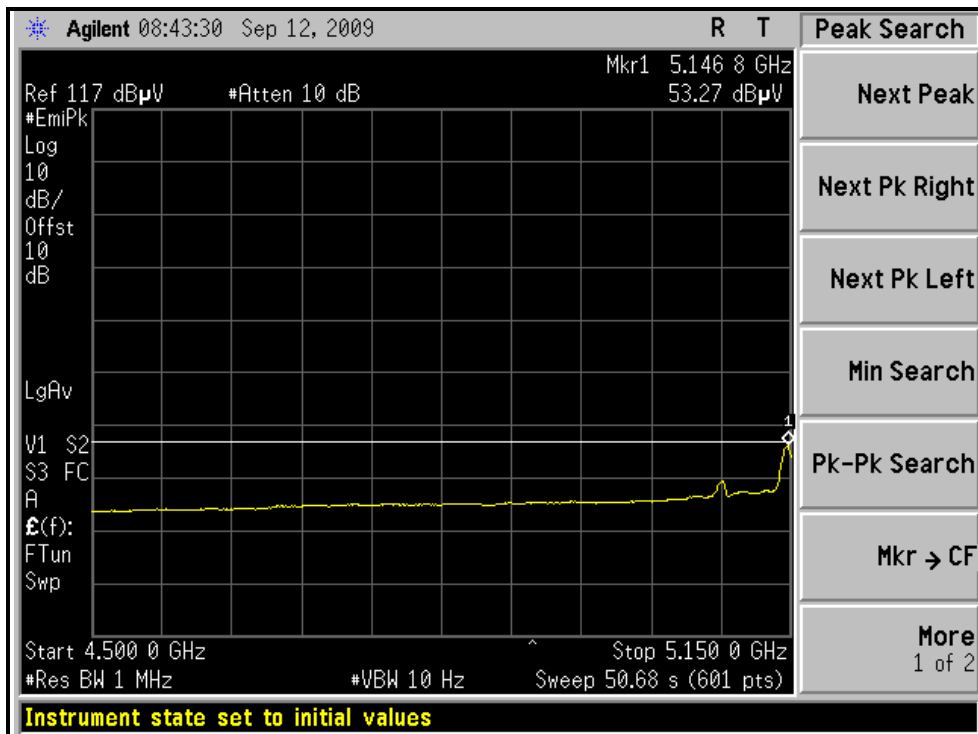
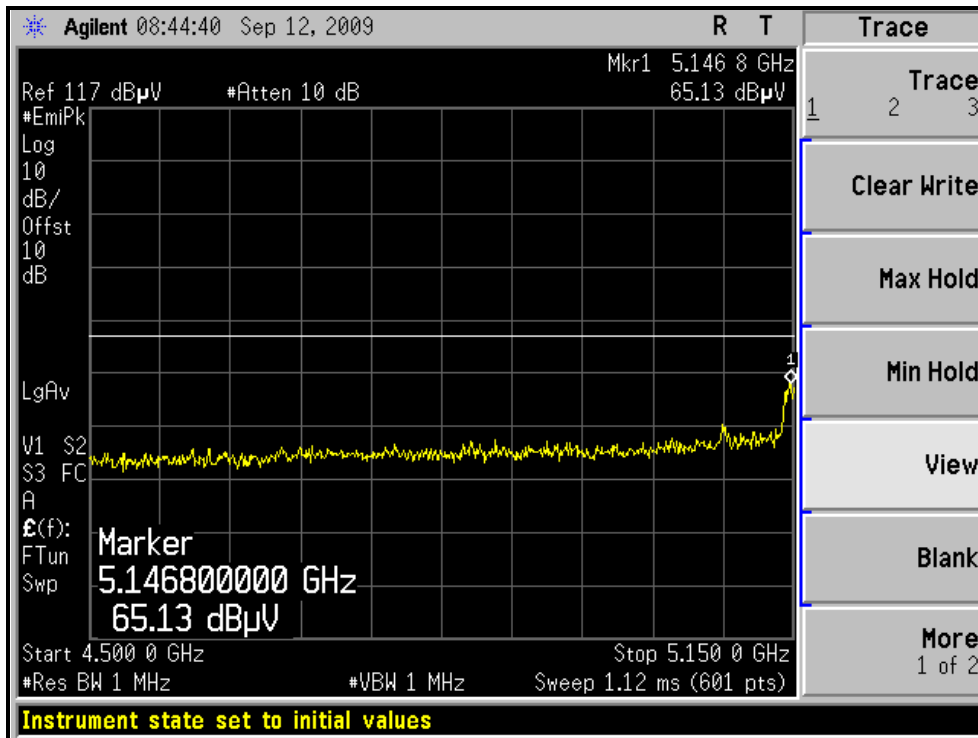



A D T

RESTRICTED BANDEDGE (802.11n (40MHz) MODE, CH62, HORIZONTAL)

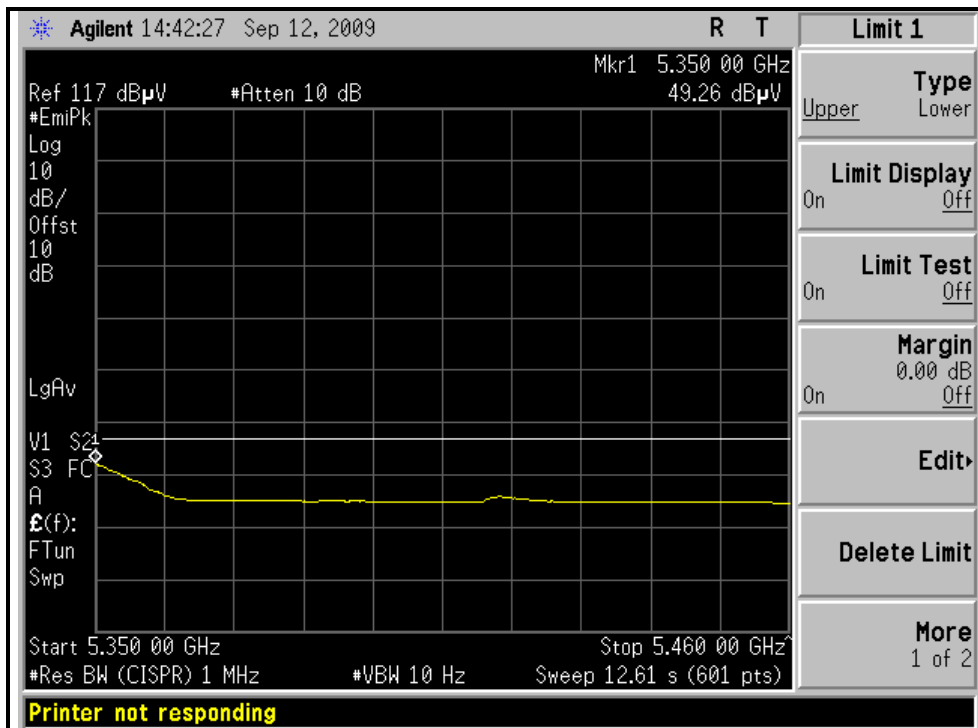
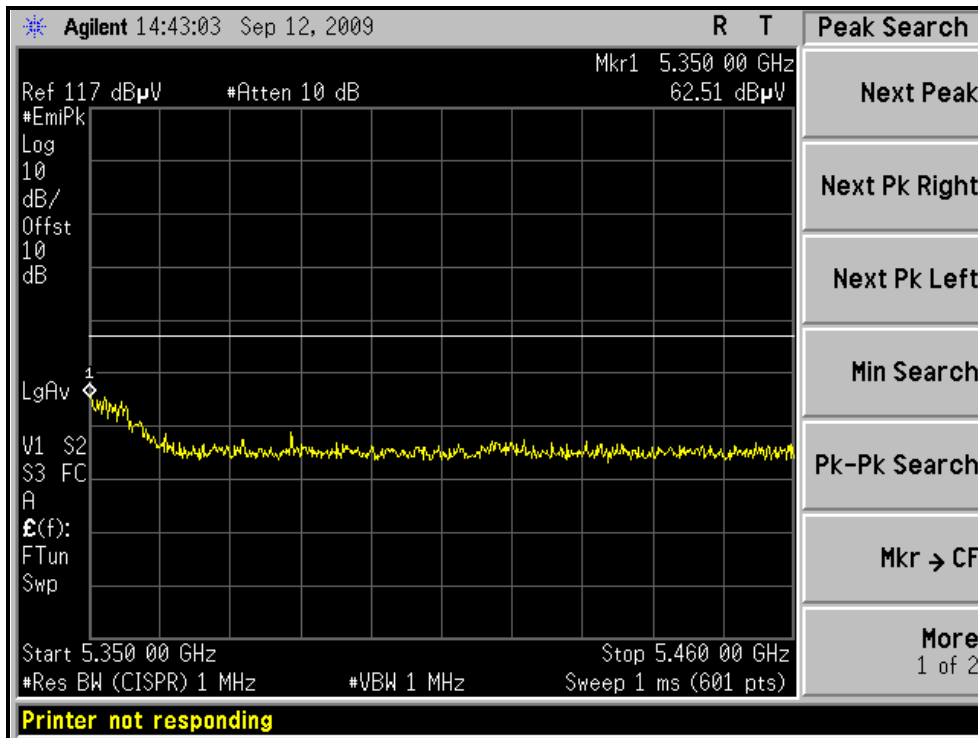



A D T

RESTRICTED BANDEDGE (802.11n (40MHz) MODE, CH62, VERTICAL)

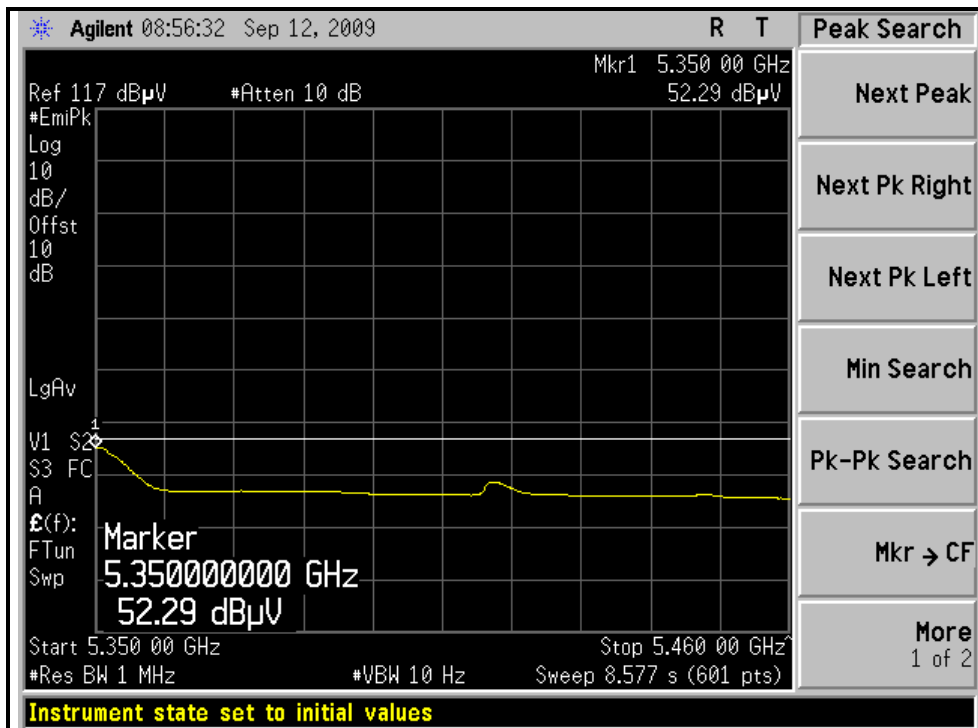
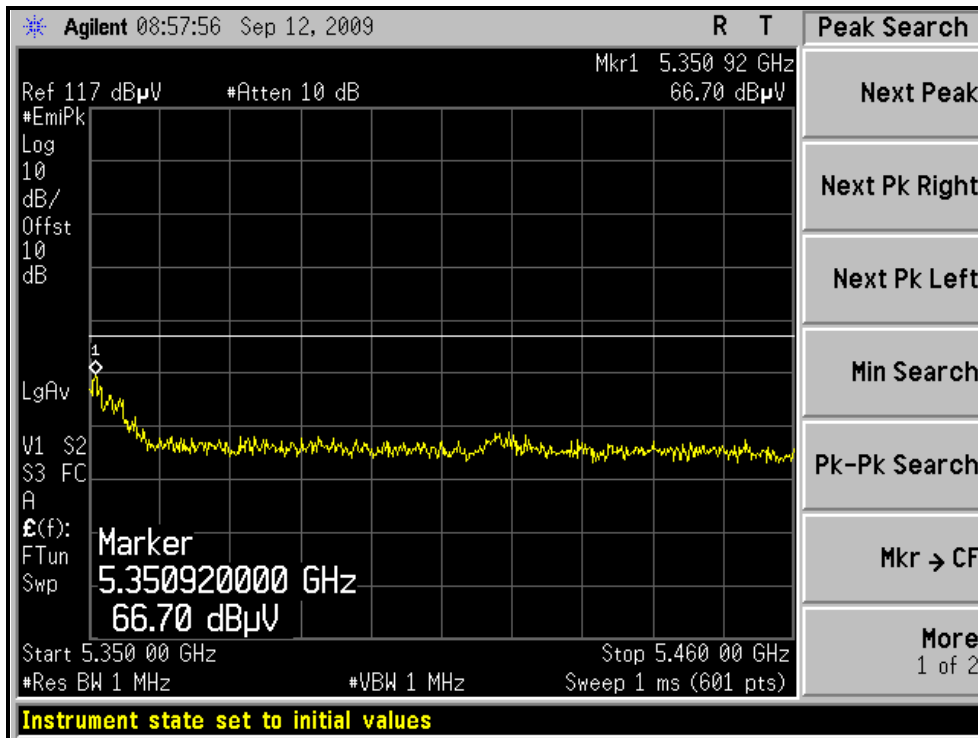



A D T

RESTRICTED BANDEDGE (802.11n (40MHz) MODE, CH102, HORIZONTAL)

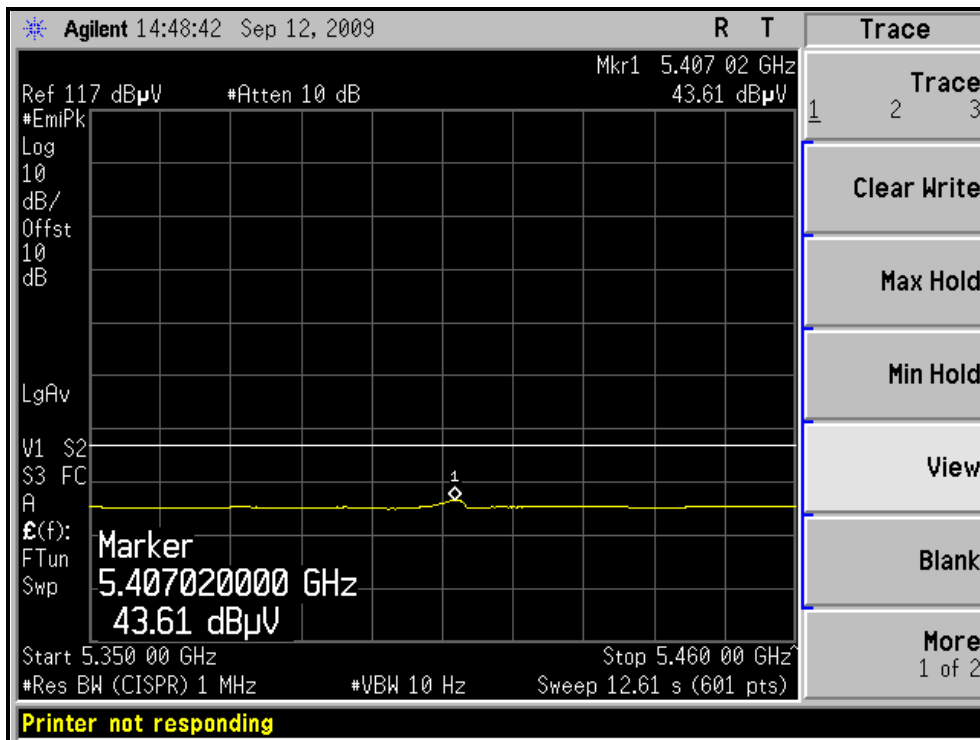
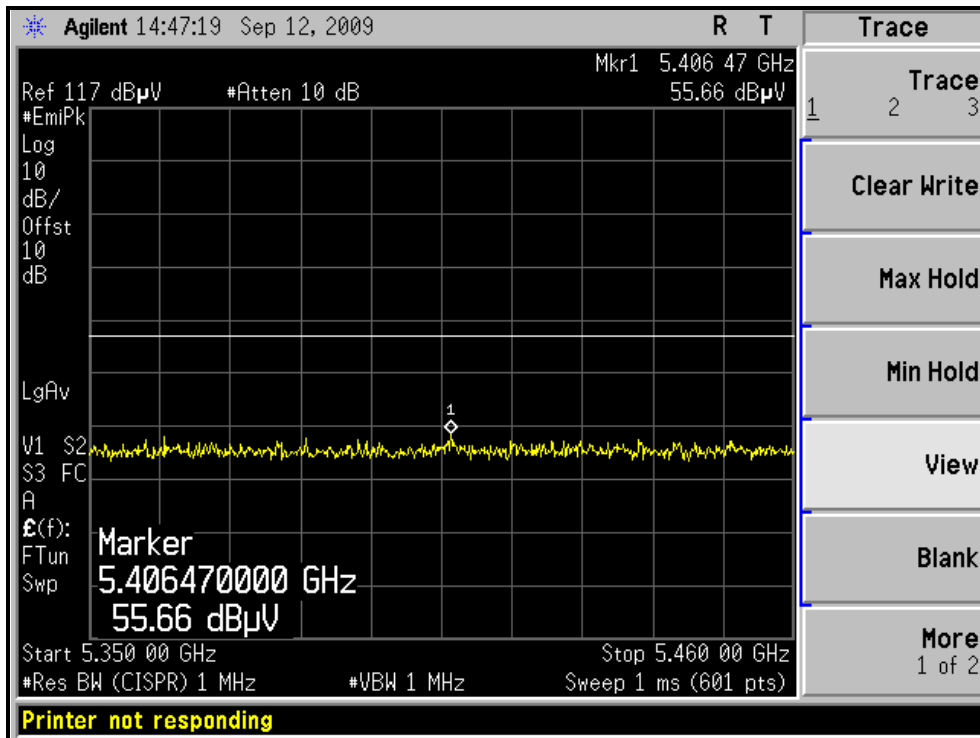



A D T

RESTRICTED BANDEDGE (802.11n (40MHz) MODE, CH102, VERTICAL)

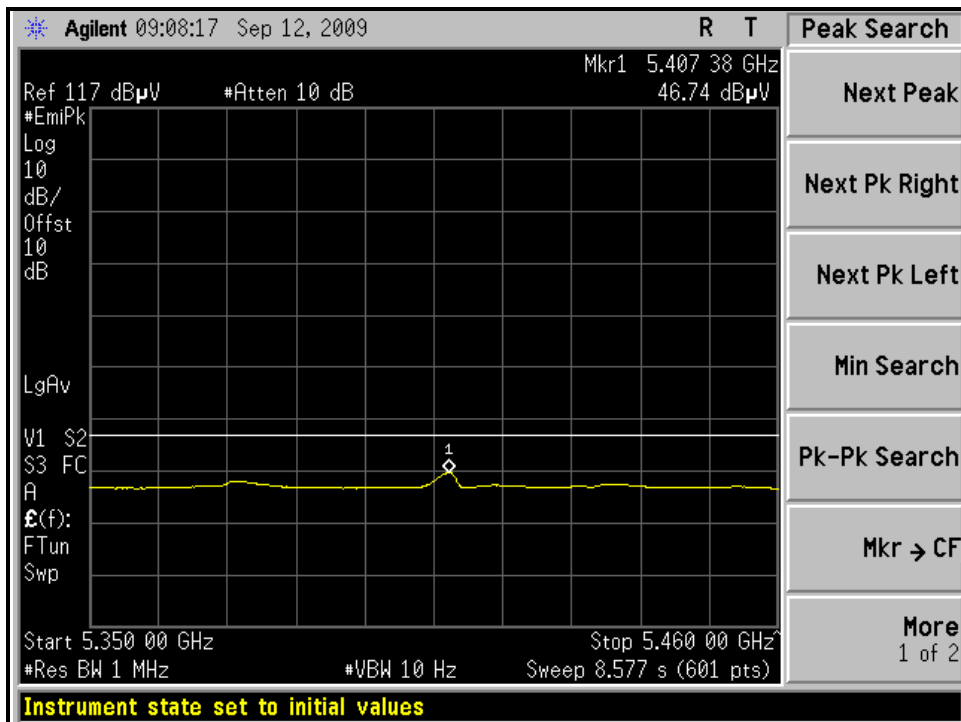
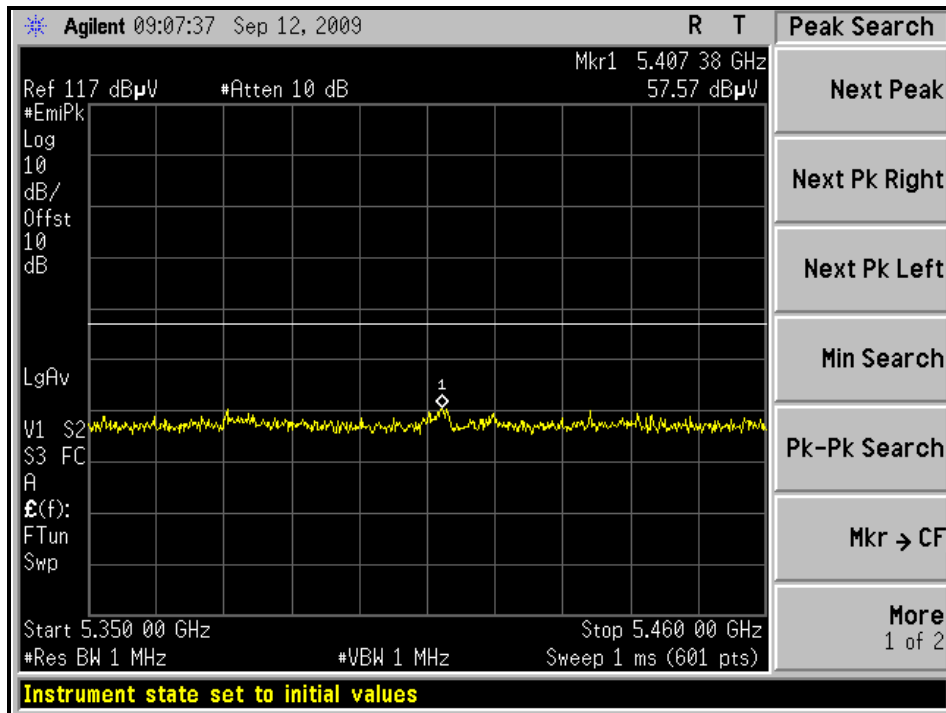

4.3 PEAK TRANSMIT POWER MEASUREMENT

4.3.1 LIMITS OF PEAK TRANSMIT POWER MEASUREMENT

Frequency Band	Limit
5.15 – 5.25GHz	The lesser of 50mW (17dBm) or 4dBm + 10logB
5.25 – 5.35GHz	The lesser of 250mW (24dBm) or 11dBm + 10logB
5.47 – 5.725GHz	The lesser of 250mW (24dBm) or 11dBm + 10logB
5.725 – 5.825GHz	The lesser of 1W (30dBm) or 17dBm + 10logB

NOTE: Where B is the 26dB emission bandwidth in MHz.

4.3.2 TEST INSTRUMENTS

DESCRIPTION & MANUFACTURER	MODEL NO.	SERIAL NO.	CALIBRATED DATE	CALIBRATED UNTIL
ADVANTEST SPECTRUM ANALYZER	U3772	160100280	Sep. 21, 2009	Sep. 20, 2010

NOTE:

1. The calibration interval of the above test instruments is 12 months and the calibrations are traceable to NML/ROC and NIST/USA.

4.3.3 TEST PROCEDURE

1. The transmitter output was connected to the spectrum analyzer.
2. Set span to encompass the entire emission bandwidth of the signal.
3. Set RBW to 1MHz, VBW to 3MHz.
4. Using the spectrum analyzer's channel power measurement function to measure the output power.

NOTE:

The test is performed in accordance with FCC Public Notice: APPENDIX A Guidelines for Assessing Unlicensed National Information Infrastructure (U-NII) Devices – Part 15, Subpart E, August 2002.

The transmitter output operates continuously therefore Method # 1 is used.

4.3.4 DEVIATION FROM TEST STANDARD

No deviation

4.3.5 TEST SETUP

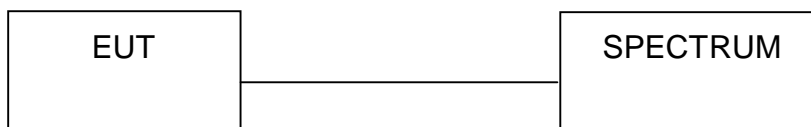

4.3.6 EUT OPERATING CONDITIONS

The software provided by client to enable the EUT under transmission condition continuously at specific channel frequencies individually.



A D T

4.3.7 TEST RESULTS

802.11a OFDM MODULATION:

CHANNEL	CHANNEL FREQUENCY (MHz)	PEAK POWER OUTPUT (dBm)	PEAK POWER OUTPUT (mW)	PEAK POWER LIMIT (dBm)	26dBc Occupied Bandwidth (MHz)	PASS/FAIL
36	5180	14.0	25.1	17	25.17	PASS
40	5200	14.6	28.8	17	24.75	PASS
48	5240	14.1	25.7	17	25.17	PASS
52	5260	15.3	33.9	24	33.42	PASS
60	5300	15.0	31.6	24	31.25	PASS
64	5320	14.8	30.2	24	27.17	PASS
100	5500	12.6	18.2	24	22.5	PASS
120	5600	15.2	33.1	24	34.58	PASS
140	5700	15.1	32.4	24	30.92	PASS

NOTE: The 26dBc Occupied Bandwidth plot, please refer to the following pages.



A D T

Peak Power Output: CH40

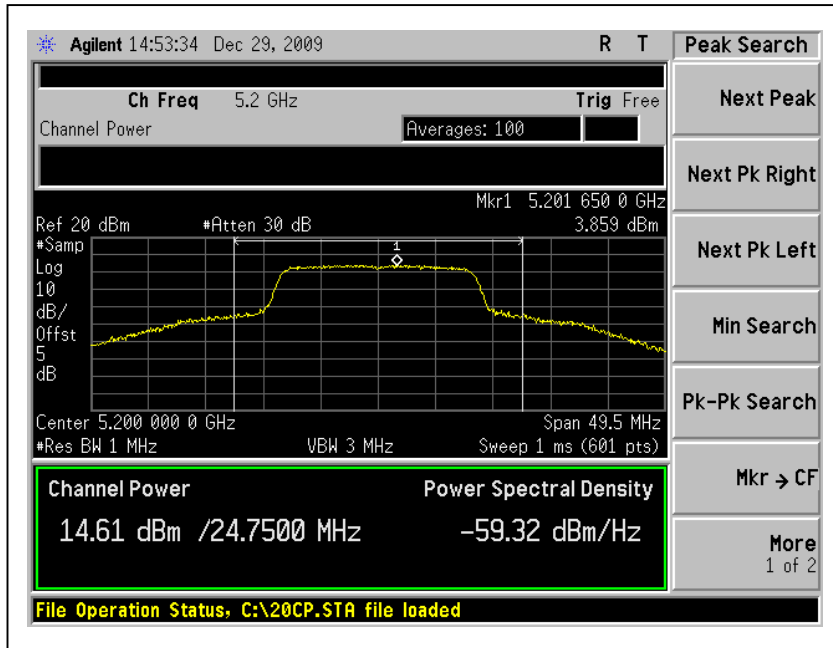

CH52

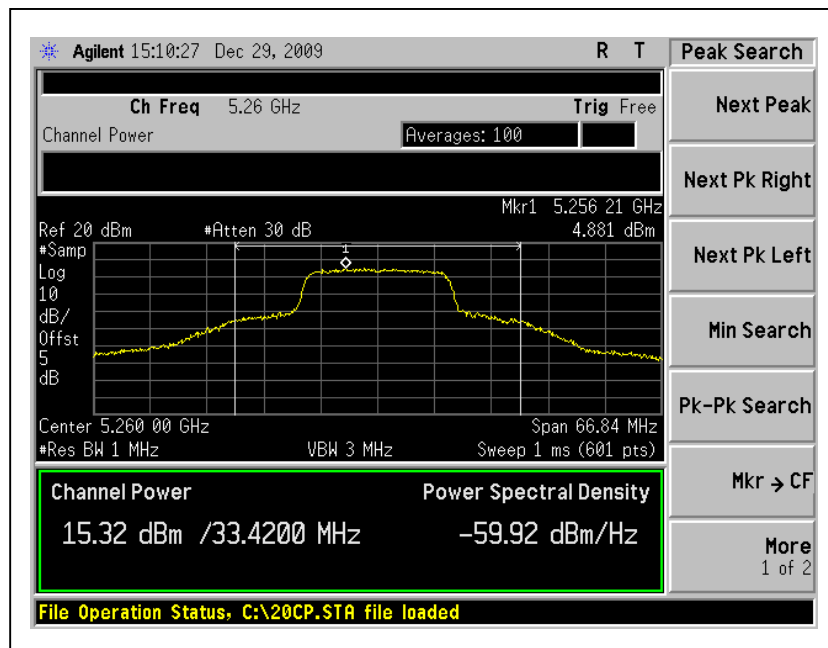



A D T

CH120

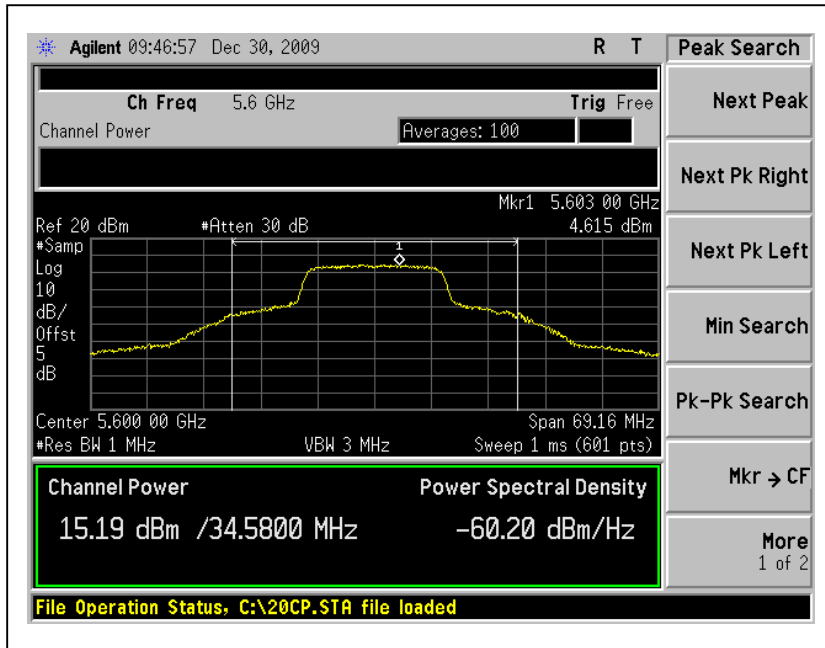

26dB Occupied Bandwidth: CH48

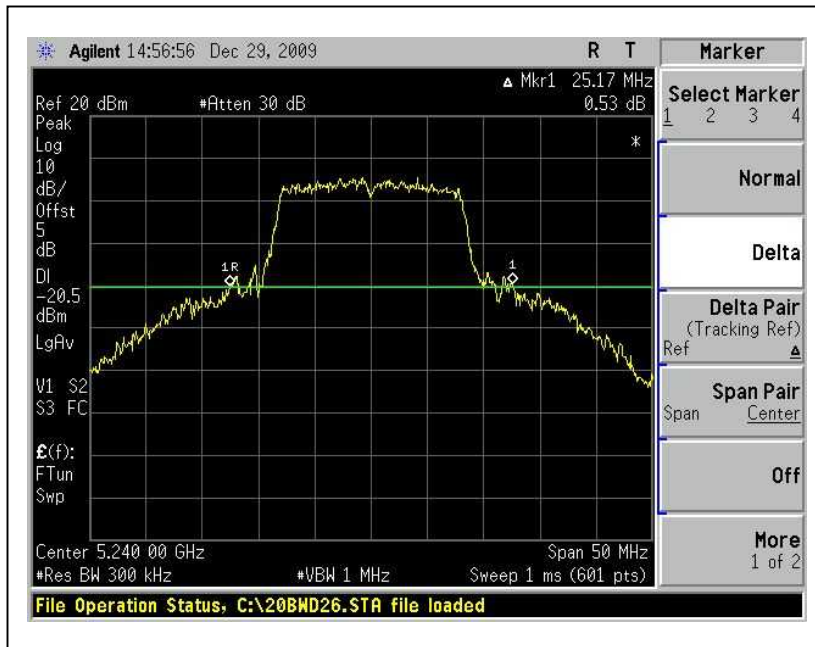

CH52

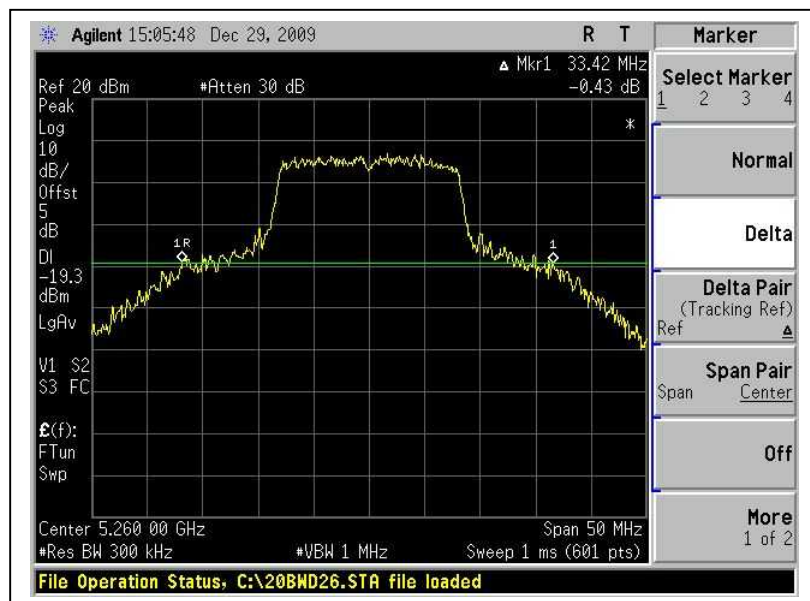



A D T

CH120

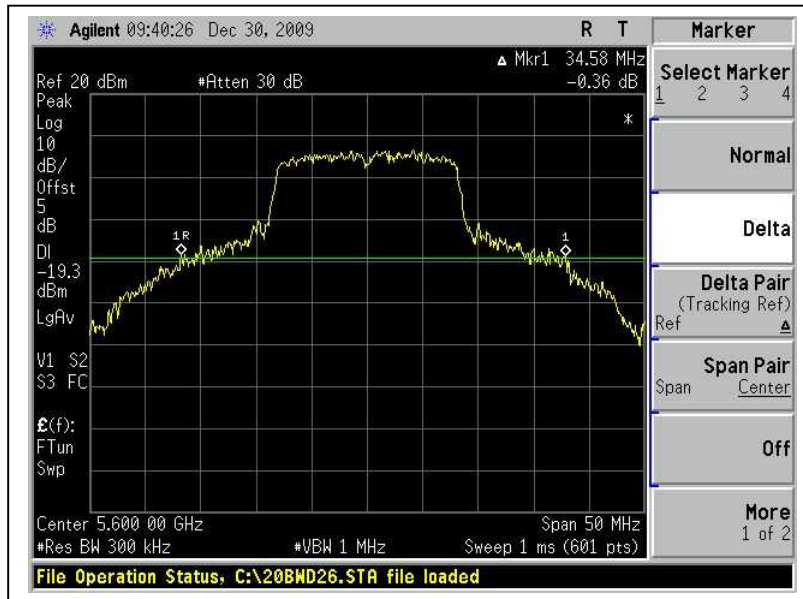



802.11n (20MHz) OFDM modulation:

CHANNEL	CHANNEL FREQUENCY (MHz)	PEAK POWER OUTPUT (dBm)		TOTAL PEAK POWER (dBm)	TOTAL PEAK POWER (mW)	PEAK POWER LIMIT (dBm)	26dBc Occupied Bandwidth (MHz)	PASS/ FAIL
		Chain 0	Chain 1					
36	5180	10.7	10.8	13.8	23.8	17	19.58	PASS
40	5200	10.8	11.5	14.2	26.1	17	19.75	PASS
48	5240	10.8	11.3	14.1	25.5	17	19.83	PASS
52	5260	16.5	16.4	19.5	88.3	24	29.58	PASS
60	5300	16.8	16.7	19.8	94.6	24	28.42	PASS
64	5320	16.2	16.6	19.4	87.4	24	31.17	PASS
100	5500	14.9	15.8	18.4	68.9	24	34.5	PASS
120	5600	14.7	15.0	17.9	61.1	24	34.5	PASS
140	5700	15.5	14.7	18.1	65.0	24	29.75	PASS

NOTE: The 26dBc Occupied Bandwidth plot, please refer to the following pages.



A D T

Peak Power Output: For Chain (1) :CH40

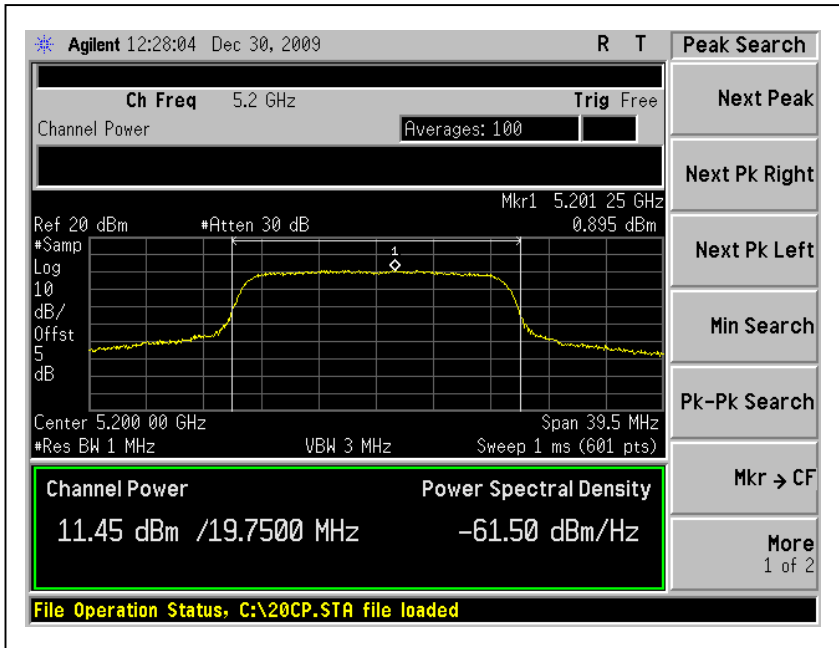

For Chain (0) :CH60

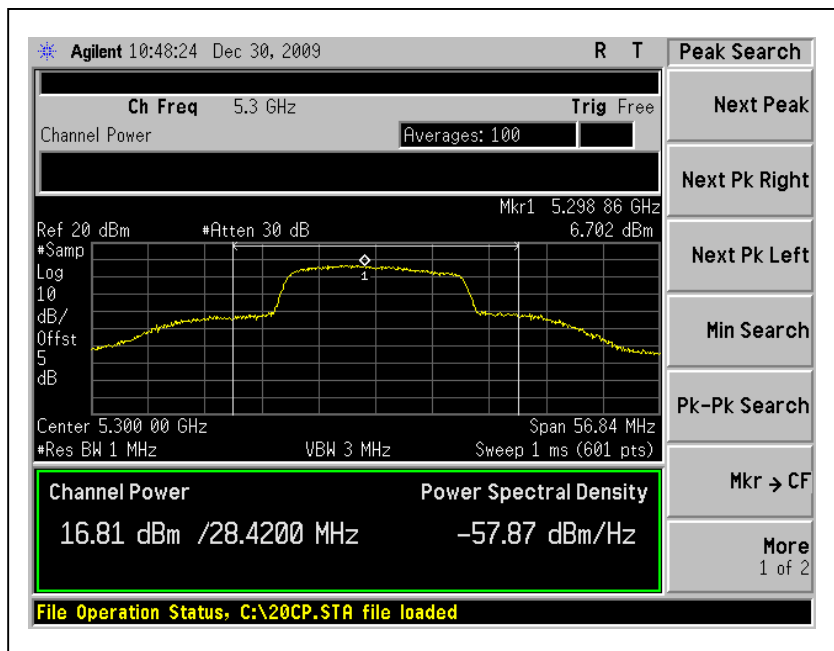



A D T

For Chain (1) :CH100

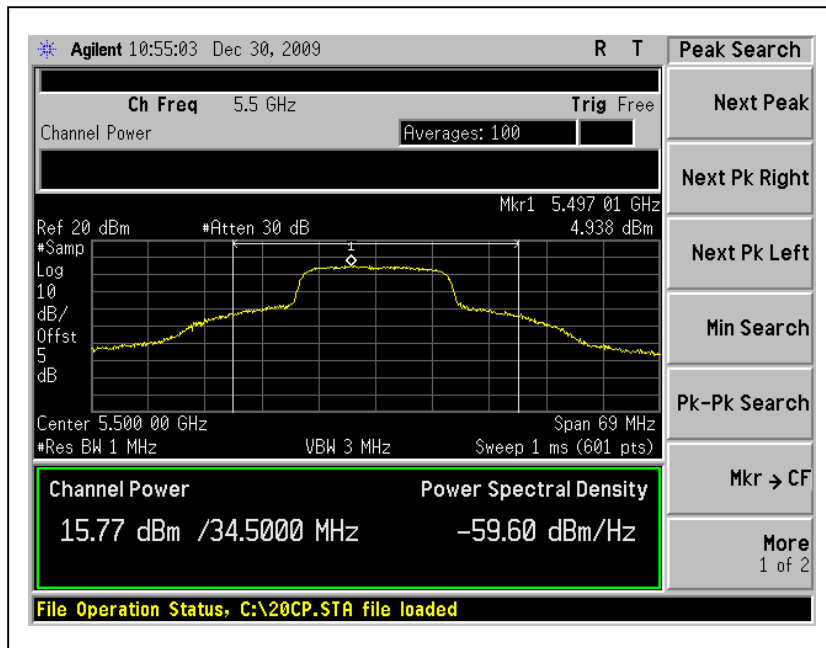

26dB Occupied Bandwidth: CH48

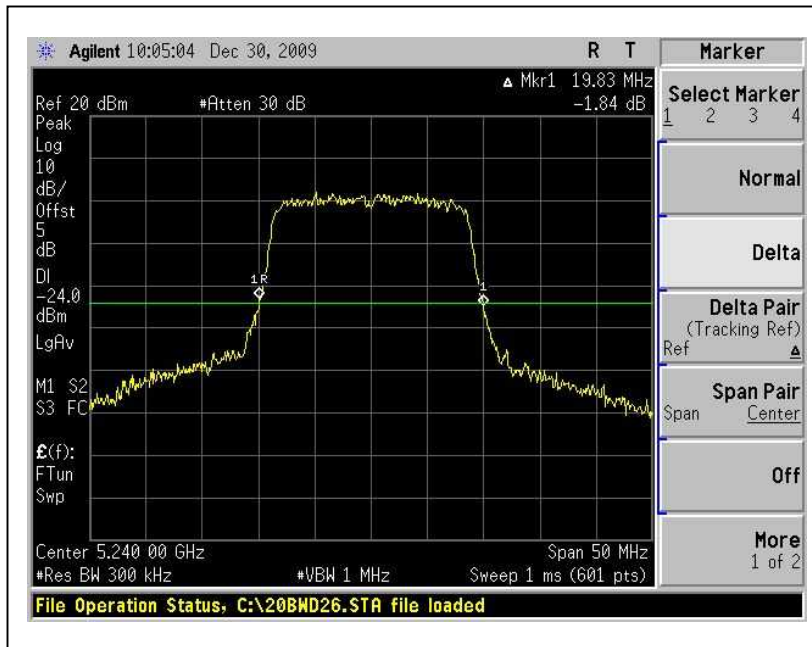

CH64

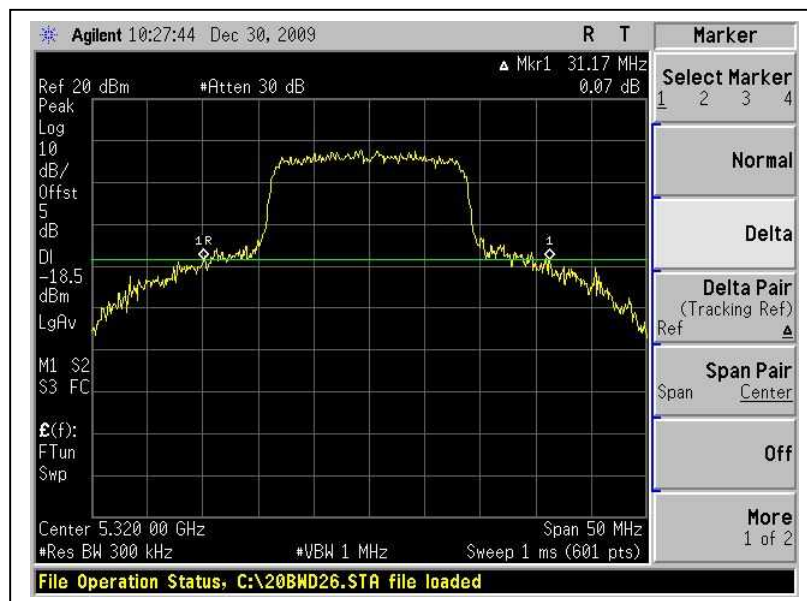



A D T

CH100





A D T

802.11n (40MHz) OFDM MODULATION:

CHANNEL	CHANNEL FREQUENCY (MHz)	PEAK POWER OUTPUT (dBm)		TOTAL PEAK POWER (dBm)	TOTAL PEAK POWER (mW)	PEAK POWER LIMIT (dBm)	26dBc Occupied Bandwidth (MHz)	PASS/ FAIL
		Chain 0	Chain 1					
38	5190	13.6	13.4	16.5	44.8	17	39.33	PASS
46	5230	13.5	14.1	16.8	48.1	17	39.33	PASS
54	5270	15.5	16.7	19.2	82.3	24	59.83	PASS
62	5310	15.4	16.8	19.2	82.5	24	57.67	PASS
102	5510	13.9	15.1	17.6	56.9	24	62.67	PASS
118	5590	13.7	13.6	16.7	46.4	24	64.17	PASS
134	5670	14.7	13.5	17.2	51.9	24	56.67	PASS

NOTE: The 26dBc Occupied Bandwidth plot, please refer to the following pages.



A D T

Peak Power Output: For Chain (1) :CH46

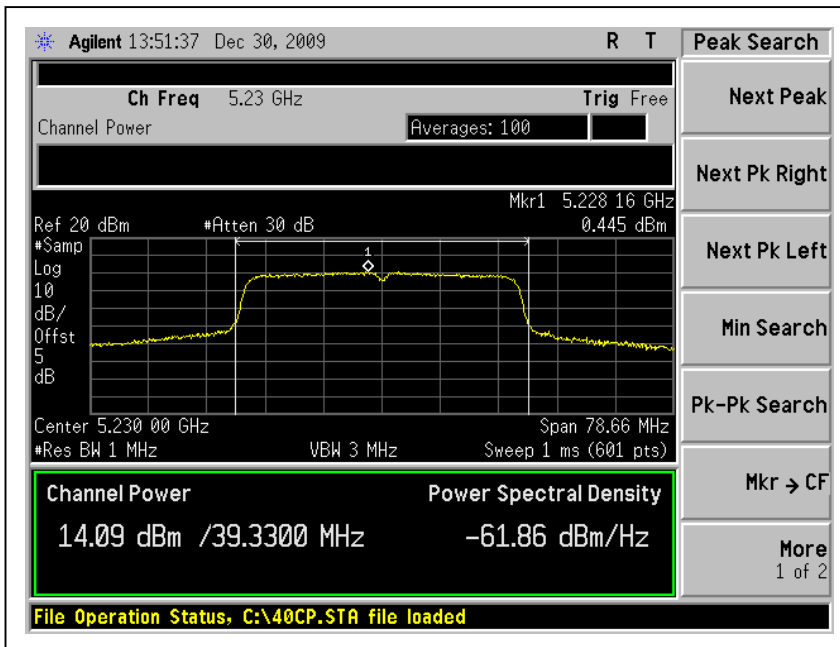

For Chain (1) :CH62

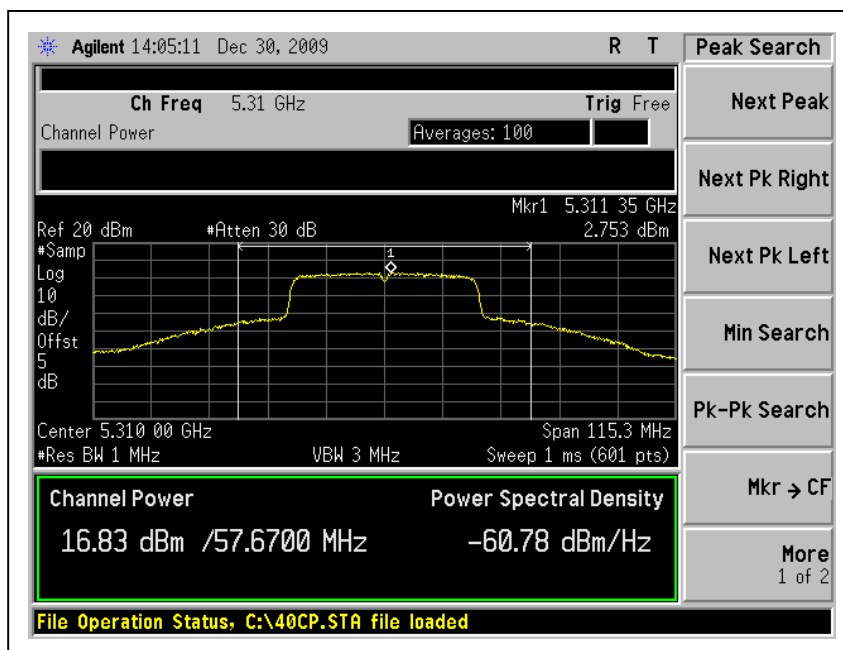



A D T

For Chain (1) :CH102

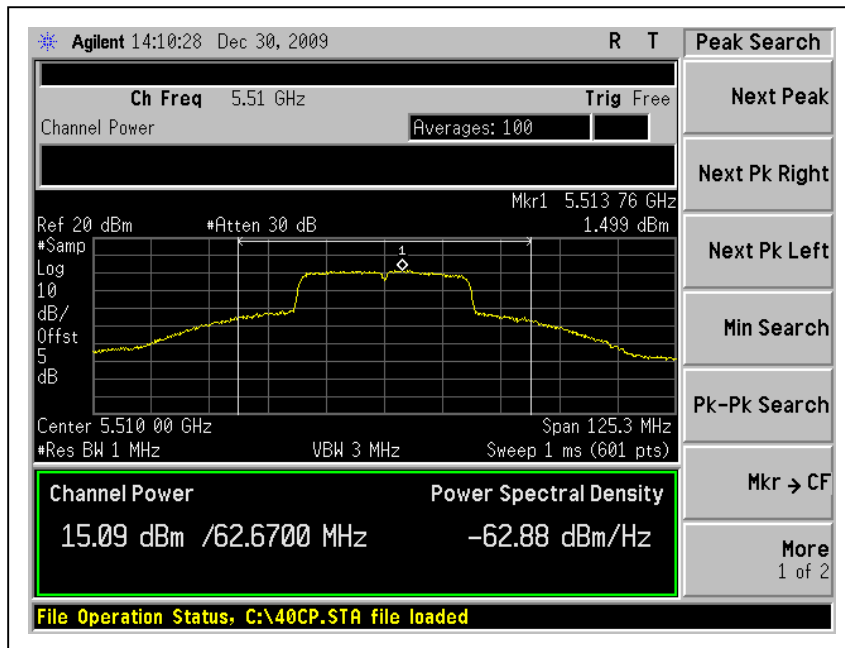



A D T

26dB Occupied Bandwidth: CH46

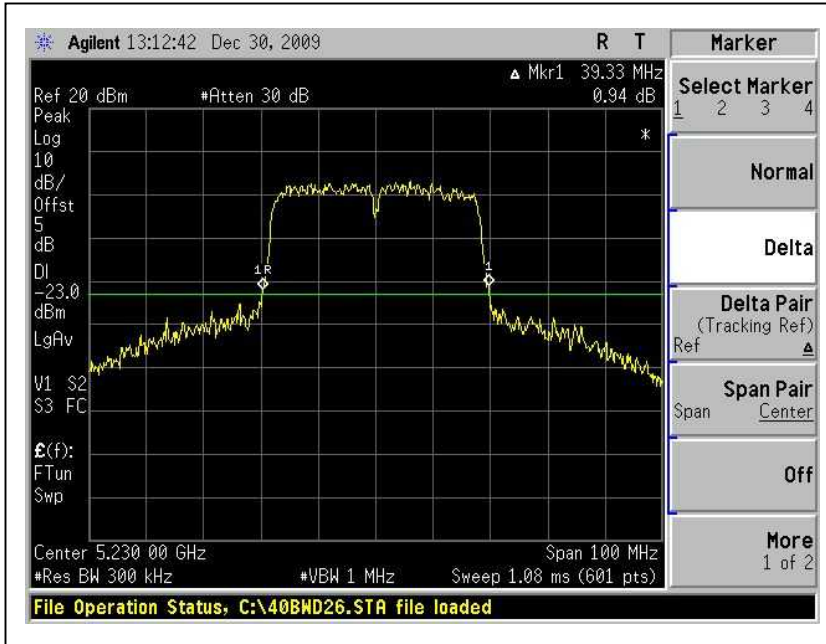

CH54

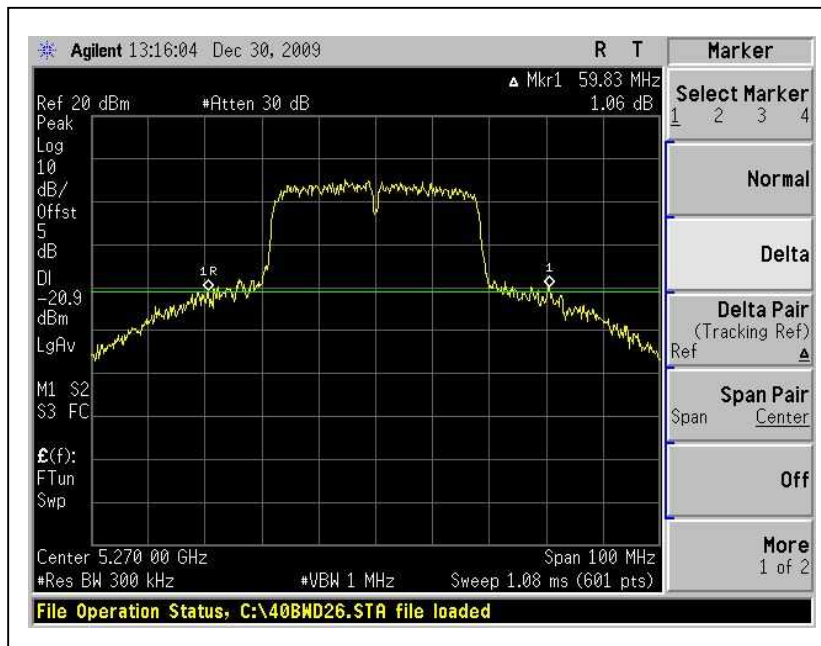



A D T

CH118

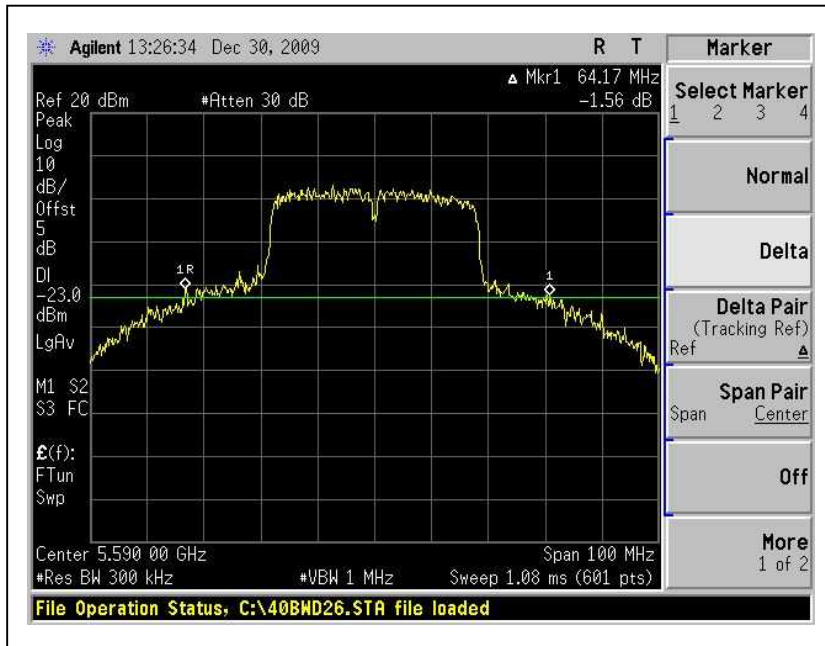



A D T

4.4 PEAK POWER EXCURSION MEASUREMENT

4.4.1 LIMITS OF PEAK POWER EXCURSION MEASUREMENT

Frequency Band	Limit
5.15 – 5.25 GHz	13dB
5.25 – 5.35 GHz	13dB
5.47 – 5.725GHz	13dB
5.725 – 5.825 GHz	13dB

4.4.2 TEST INSTRUMENTS

DESCRIPTION & MANUFACTURER	MODEL NO.	SERIAL NO.	CALIBRATED DATE	CALIBRATED UNTIL
ADVANTEST SPECTRUM ANALYZER	U3772	160100280	Sep. 21, 2009	Sep. 20, 2010

NOTE:

1. The calibration interval of the above test instruments is 12 months and the calibrations are traceable to NML/ROC and NIST/USA.

4.4.3 TEST PROCEDURE

1. The transmitter output was connected to the spectrum analyzer.
2. Set the spectrum bandwidth span to view the entire spectrum.
3. Using peak detector and Max-hold function for Trace 1 (RB=1MHz, VB=3MHz) and 2 (RB=1MHz, VB=300kHz).
4. The largest difference between Trace 1 and Trace 2 in any 1MHz band on any frequency was recorded.

4.4.4 DEVIATION FROM TEST STANDARD

No deviation

4.4.5 TEST SETUP

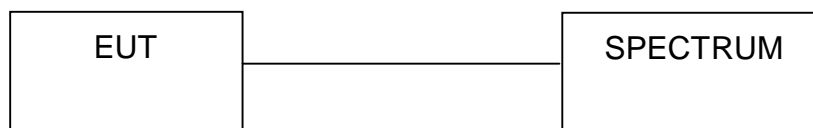

4.4.6 EUT OPERATING CONDITIONS

The software provided by client to enable the EUT under transmission condition continuously at specific channel frequencies individually.



A D T

4.4.7 TEST RESULTS

802.11a OFDM modulation

CHANNEL	CHANNEL FREQUENCY (MHz)	PEAK POWER EXCURSION (dB)	PEAK to AVERAGE EXCURSION LIMIT (dB)	PASS/FAIL
36	5180	8.21	13	PASS
40	5200	8.34	13	PASS
48	5240	8.19	13	PASS
52	5260	8.33	13	PASS
60	5300	7.95	13	PASS
64	5320	7.68	13	PASS
100	5500	8.25	13	PASS
120	5600	7.68	13	PASS
140	5700	8.42	13	PASS



A D T

CH40

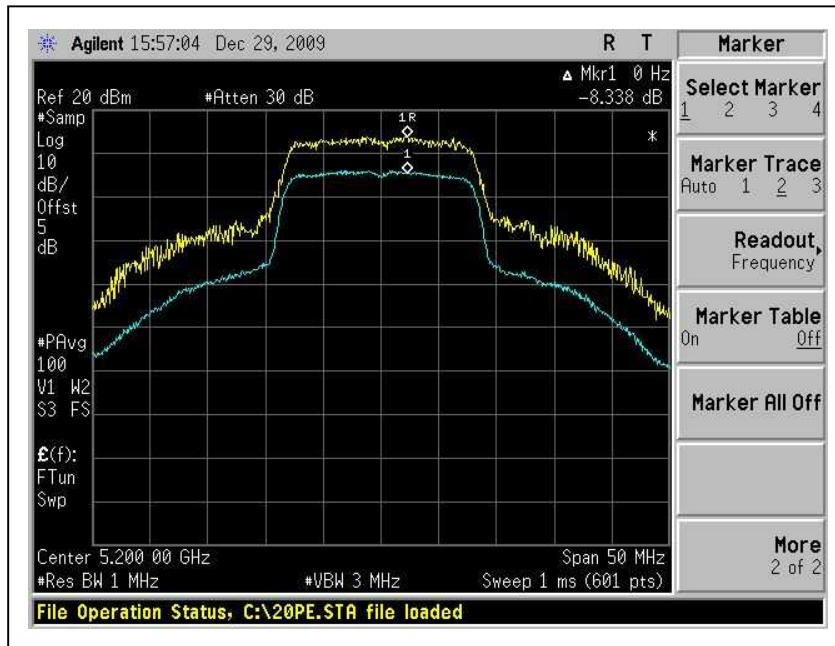

CH52

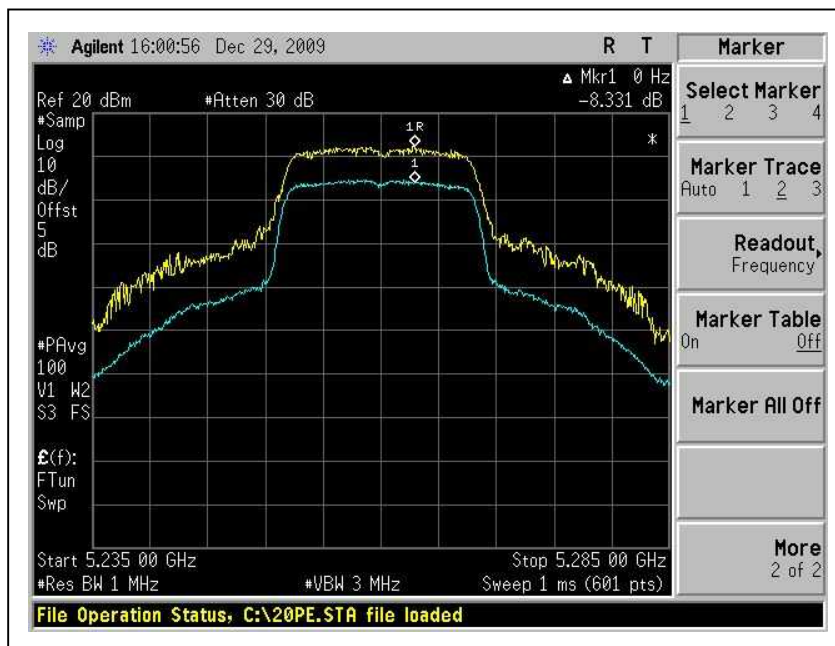



A D T

CH140

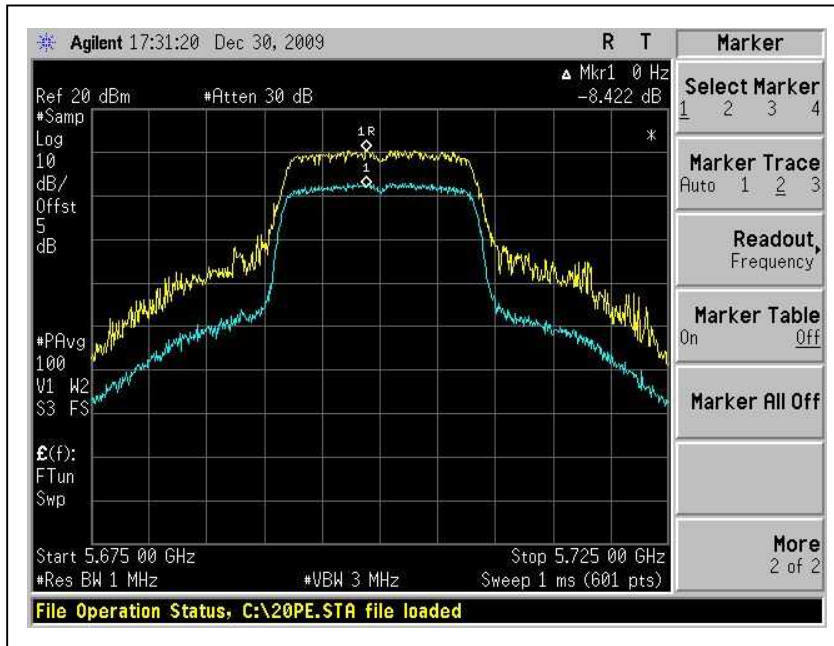



A D T

802.11n (20MHz) OFDM MODULATION:

CHANNEL	CHANNEL FREQUENCY (MHz)	PEAK POWER EXCURSION (dB)	PEAK to AVERAGE EXCURSION LIMIT (dB)	PASS/FAIL
36	5180	8.97	13	PASS
40	5200	9.31	13	PASS
48	5240	8.71	13	PASS
52	5260	8.21	13	PASS
60	5300	7.82	13	PASS
64	5320	8.51	13	PASS
100	5500	8.92	13	PASS
120	5600	9.24	13	PASS
140	5700	9.01	13	PASS



A D T

CH40

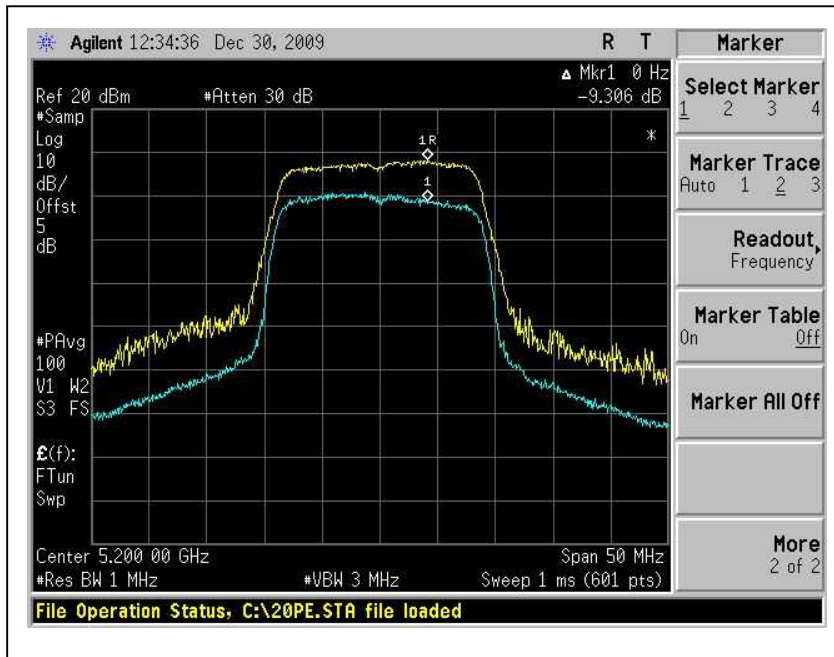

CH64

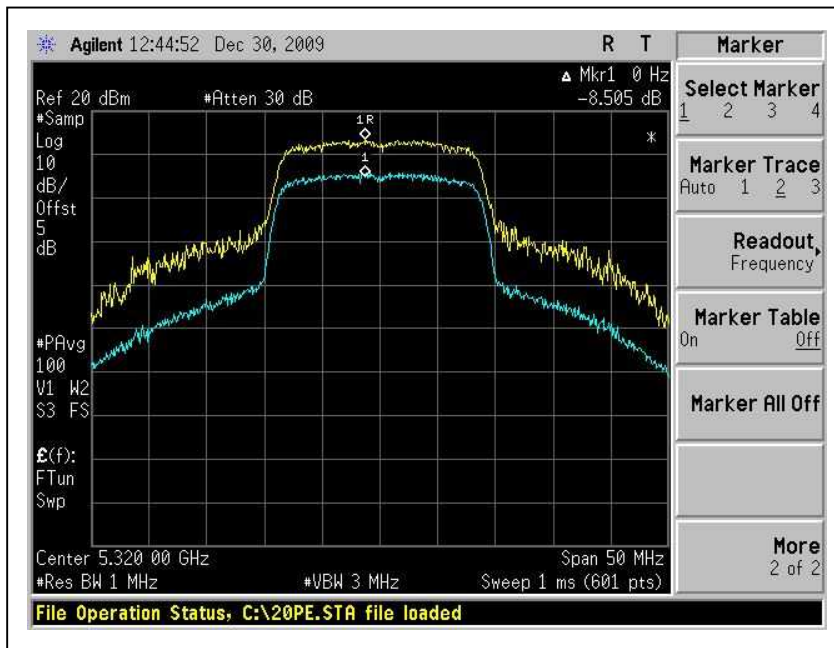



A D T

CH120

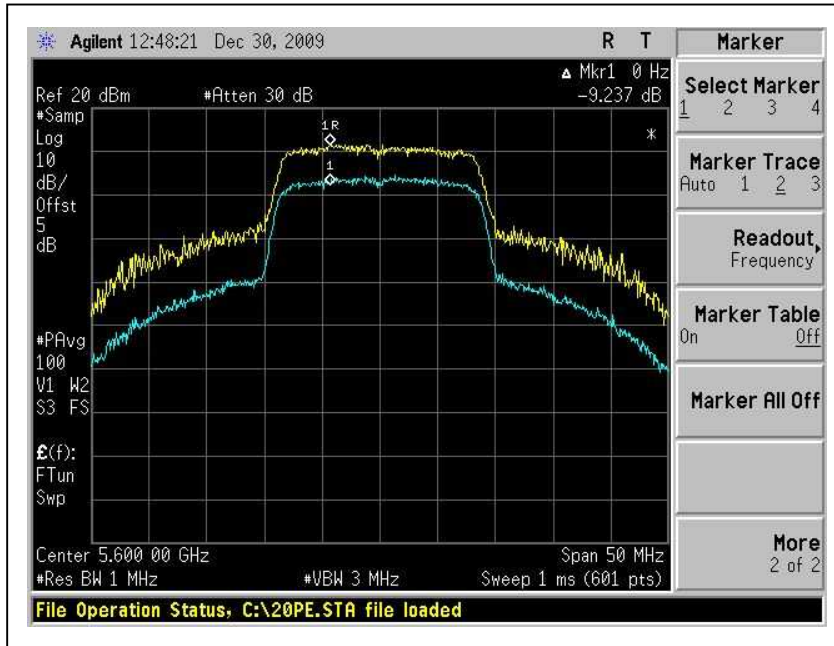



A D T

802.11n (40MHz) OFDM MODULATION:

CHANNEL	CHANNEL FREQUENCY (MHz)	PEAK POWER EXCURSION (dB)	PEAK to AVERAGE EXCURSION LIMIT (dB)	PASS/FAIL
38	5190	11.09	13	PASS
46	5230	11.23	13	PASS
54	5270	8.23	13	PASS
62	5310	8.02	13	PASS
102	5510	7.81	13	PASS
118	5590	8.30	13	PASS
134	5670	9.00	13	PASS



A D T

CH46

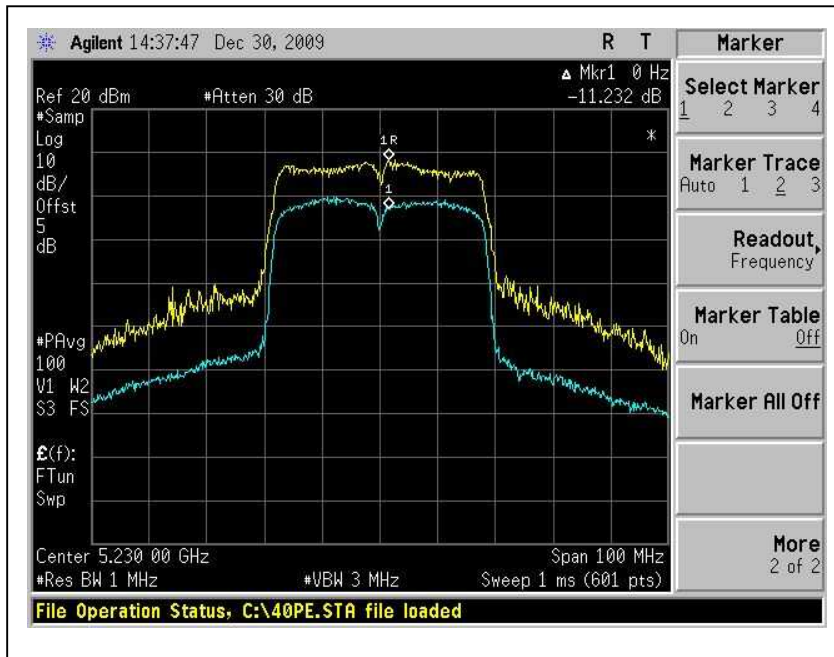

CH54

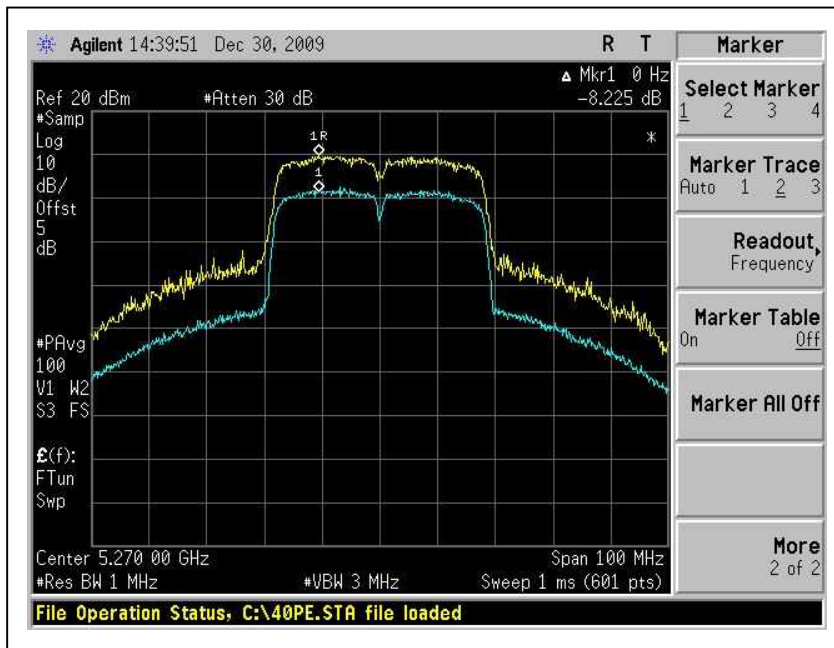



A D T

CH134

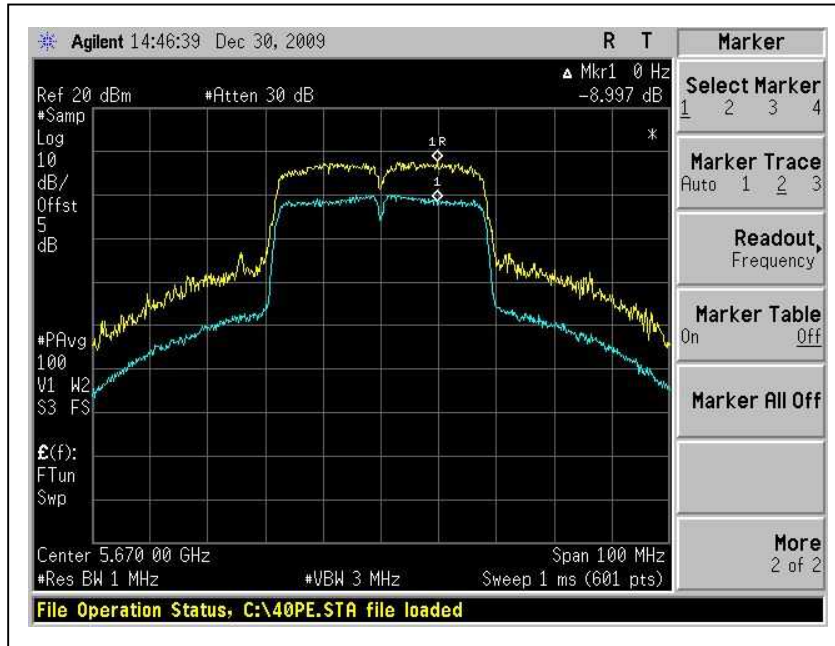

4.5 PEAK POWER SPECTRAL DENSITY MEASUREMENT

4.5.1 LIMITS OF PEAK POWER SPECTRAL DENSITY MEASUREMENT

Frequency Band	Limit
5.15 ~ 5.25GHz	4dBm
5.25 ~ 5.35GHz	11dBm
5.47 – 5.725GHz	11dBm
5.725 ~ 5.825GHz	17dBm

4.5.2 TEST INSTRUMENTS

DESCRIPTION & MANUFACTURER	MODEL NO.	SERIAL NO.	CALIBRATED DATE	CALIBRATED UNTIL
ADVANTEST SPECTRUM ANALYZER	U3772	160100280	Sep. 21, 2009	Sep. 20, 2010

NOTE:

1. The calibration interval of the above test instruments is 12 months and the calibrations are traceable to NML/ROC and NIST/USA.

4.5.3 TEST PROCEDURES

1. The transmitter output was connected to the spectrum analyzer.
2. Set RBW=1MHz, VBW=3MHz. The PPSD is the highest level found across the emission in any 1MHz band.

4.5.4 DEVIATION FROM TEST STANDARD

No deviation

4.5.5 TEST SETUP



4.5.6 EUT OPERATING CONDITIONS

Same as 4.3.6



A D T

4.5.7 TEST RESULTS

802.11a OFDM modulation

CHANNEL	CHANNEL FREQUENCY (MHz)	RF POWER LEVEL IN 1MHz BW (dBm)	MAXIMUM LIMIT (dBm)	PASS/FAIL
36	5180	3.5	4	PASS
40	5200	3.9	4	PASS
48	5240	3.5	4	PASS
52	5260	4.9	11	PASS
60	5300	4.3	11	PASS
64	5320	4.4	11	PASS
100	5500	2	11	PASS
120	5600	4.6	11	PASS
140	5700	4.2	11	PASS



A D T

CH40

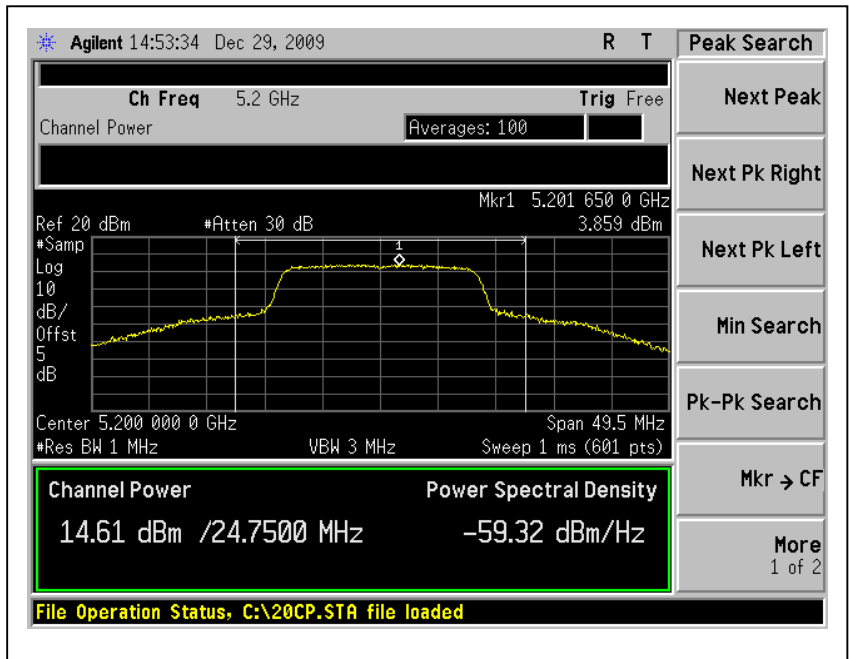

CH52

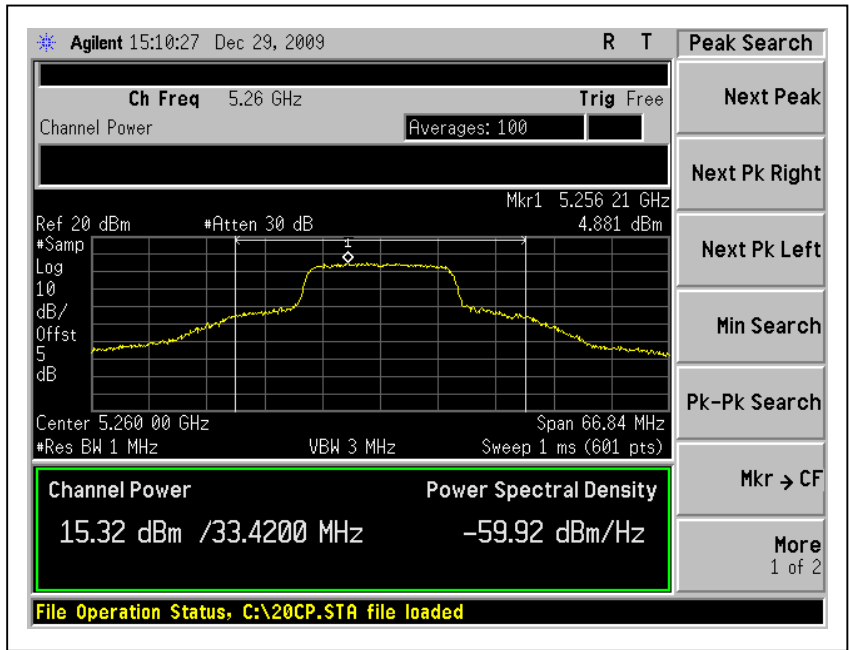



A D T

CH120

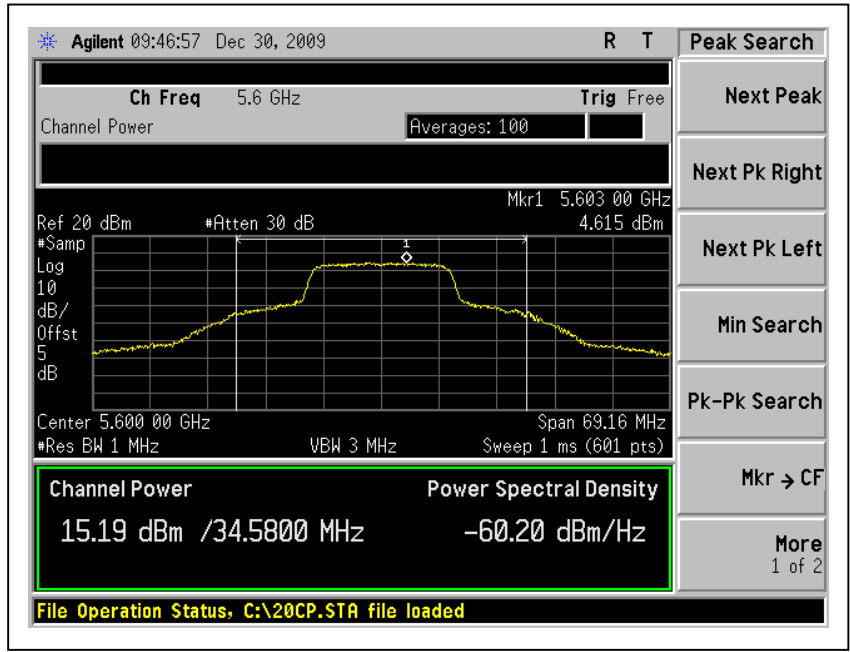



A D T

802.11n (20MHz) OFDM MODULATION:

CHANNEL	CHANNEL FREQUENCY (MHz)	RF POWER LEVEL IN 1MHz BW (dBm)		TOTAL OUTPUT POWER DENSITY (dBm)	MAXIMUM LIMIT (dBm)	PASS/FAIL
		Chain (0)	Chain(1)			
36	5180	0.9	0.5	3.7	4	PASS
40	5200	0.8	0.9	3.9	4	PASS
48	5240	1.1	0.6	3.9	4	PASS
52	5260	5.3	5.6	8.5	11	PASS
60	5300	6.7	6.0	9.4	11	PASS
64	5320	5.7	5.5	8.6	11	PASS
100	5500	4.1	4.9	7.5	11	PASS
120	5600	4.1	4.2	7.2	11	PASS
140	5700	4.4	3.8	7.1	11	PASS



A D T

For Chain (0) : CH48

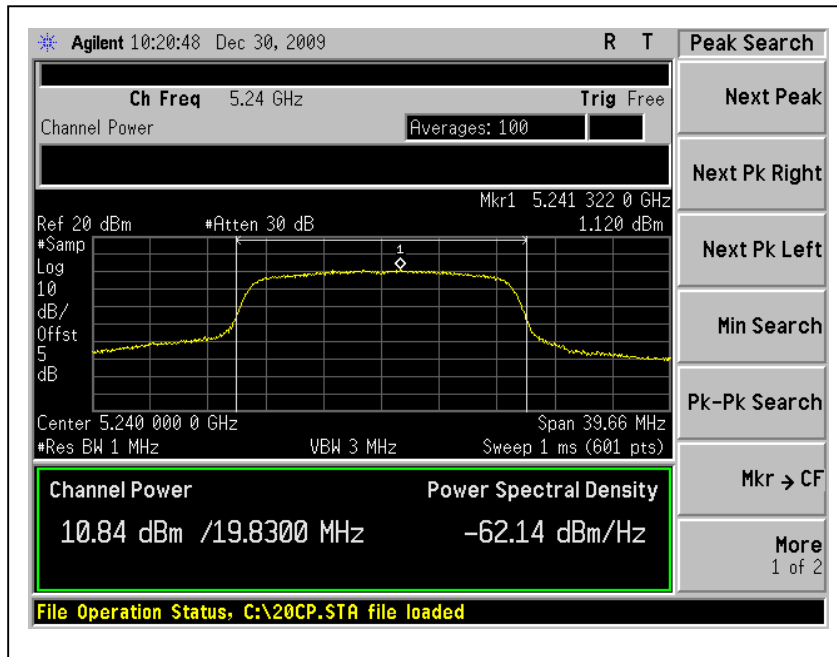

For Chain (0) : CH60

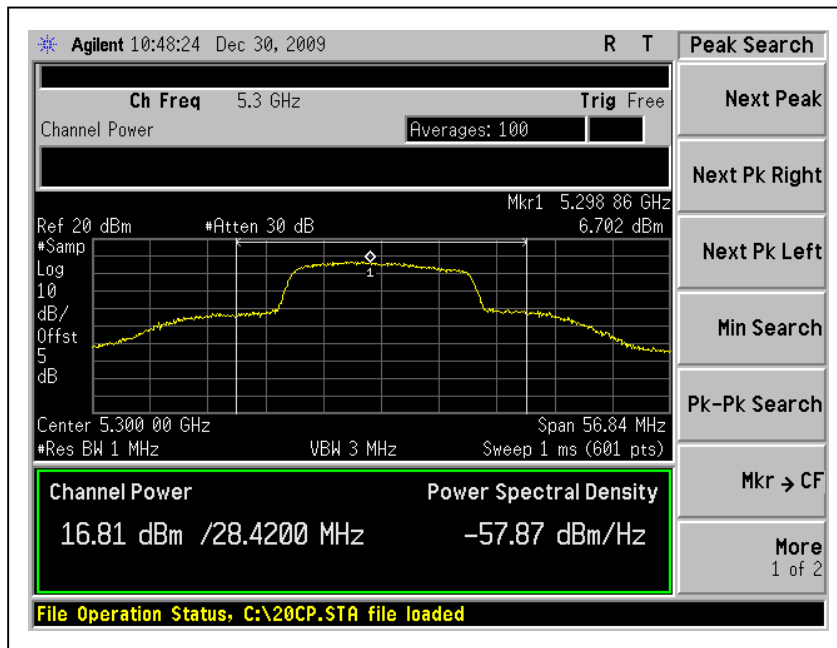



A D T

For Chain (1) : CH100

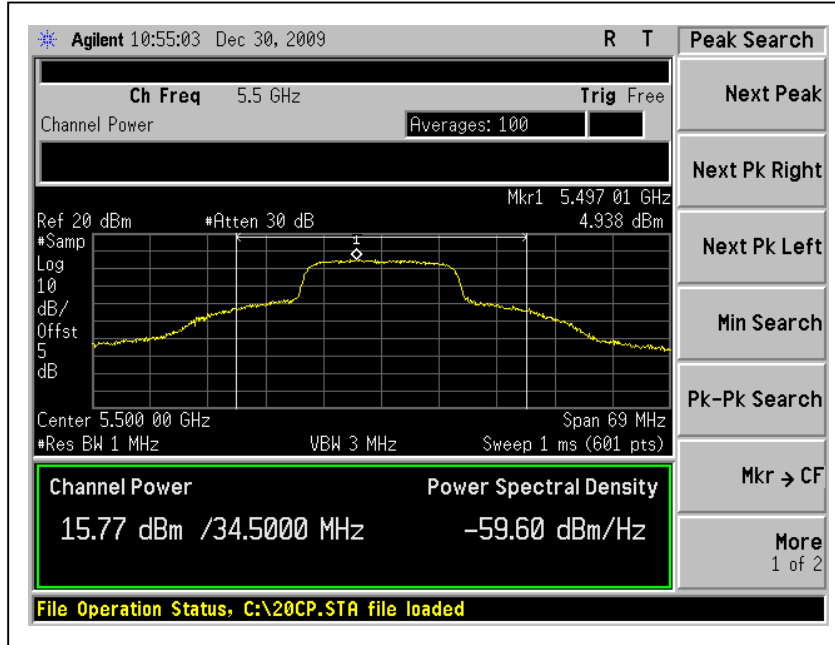



A D T

802.11n (40MHz) OFDM modulation:

CHANNEL	CHANNEL FREQUENCY (MHz)	RF POWER LEVEL IN 1MHz BW (dBm)		TOTAL OUTPUT POWER DENSITY (dBm)	MAXIMUM LIMIT (dBm)	PASS/FAIL
		Chain (0)	Chain(1)			
38	5190	1.7	-0.5	3.7	4	PASS
46	5230	-0.1	0.4	3.2	4	PASS
54	5270	2.7	2.6	5.7	11	PASS
62	5310	1.8	2.8	5.3	11	PASS
102	5510	0.1	1.5	3.9	11	PASS
118	5590	0.2	-0.3	3.0	11	PASS
134	5670	1.0	-0.4	3.4	11	PASS



A D T

For Chain (0) : CH38

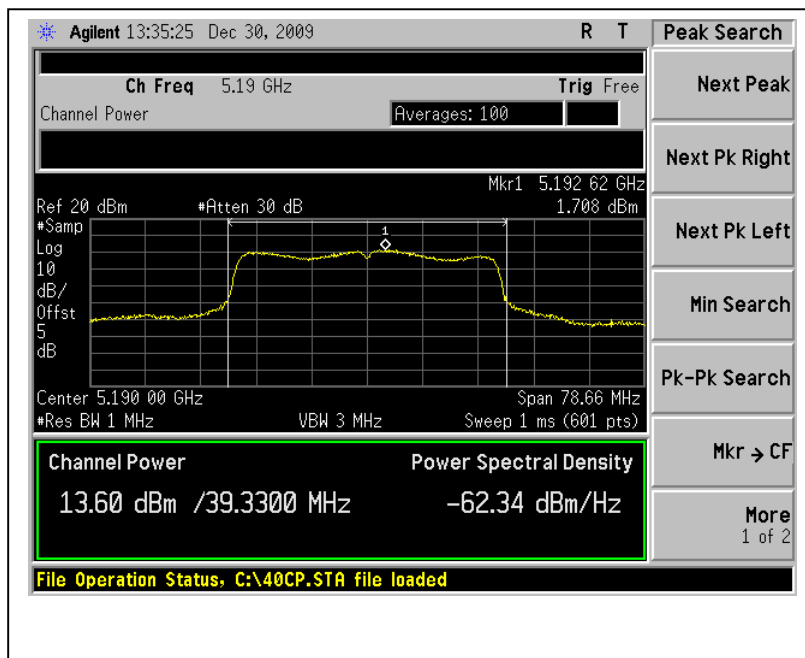

For Chain (1) : CH62

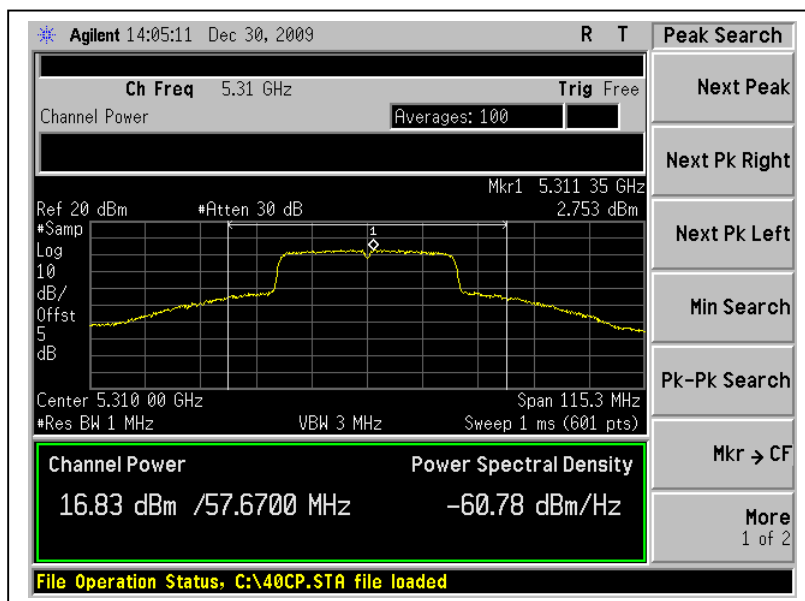



A D T

For Chain (1) : CH102

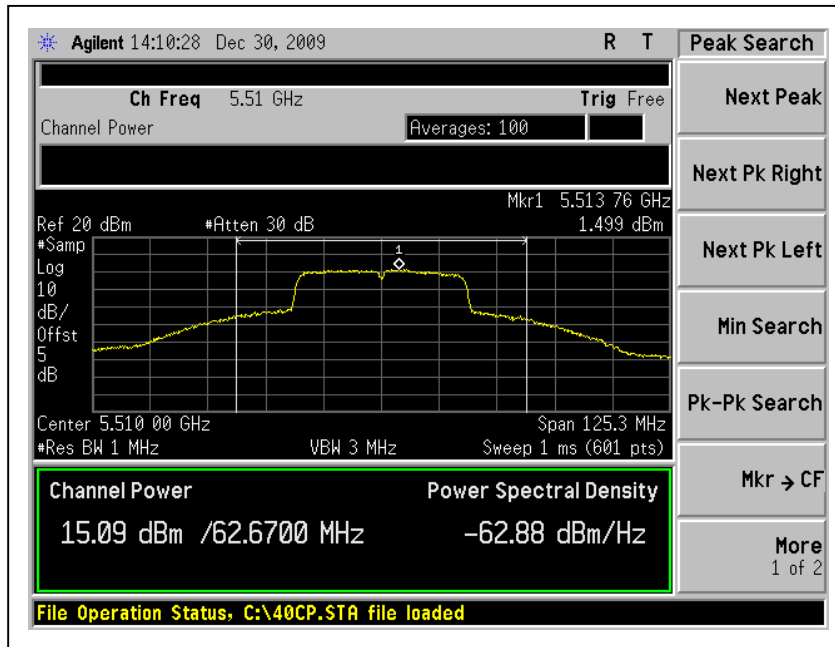



A D T

4.6 FREQUENCY STABILITY

4.6.1 LIMITS OF FREQUENCY STABILITY MEASUREMENT

The frequency tolerance of the carrier signal shall be maintained within +/- 0.02% of the operating frequency over a temperature variation of -30 degrees to 50 degrees C at normal supply voltage, and for a variation in the primary supply voltage from 85% to 115% of the rated supply voltage at a temperature of 20 degrees C.

4.6.2 TEST INSTRUMENTS

DESCRIPTION & MANUFACTURER	MODEL NO.	SERIAL NO.	CALIBRATED DATE	CALIBRATED UNTIL
R&S SPECTRUM ANALYZER	FSP40	100037	Aug. 03, 2009	Aug. 02, 2010

NOTE:

1. The calibration interval of the above test instruments is 12 months and the calibrations are traceable to NML/ROC and NIST/USA.

4.6.3 TEST PROCEDURE

1. The EUT was placed inside the environmental test chamber and powered by nominal DC voltage.
2. Turn the EUT on and couple its output to a spectrum analyzer.
3. Turn the EUT off and set the chamber to the highest temperature specified.
4. Allow sufficient time (approximately 30 min) for the temperature of the chamber to stabilize, turn the EUT on and measure the operating frequency after 2, 5, and 10 minutes.
5. Repeat step 2 and 3 with the temperature chamber set to the lowest temperature.
6. The test chamber was allowed to stabilize at +20 degree C for a minimum of 30 minutes. The supply voltage was then adjusted on the EUT from 85% to 115% and the frequency record.

4.6.4 DEVIATION FROM TEST STANDARD

No deviation

4.6.5 TEST SETUP

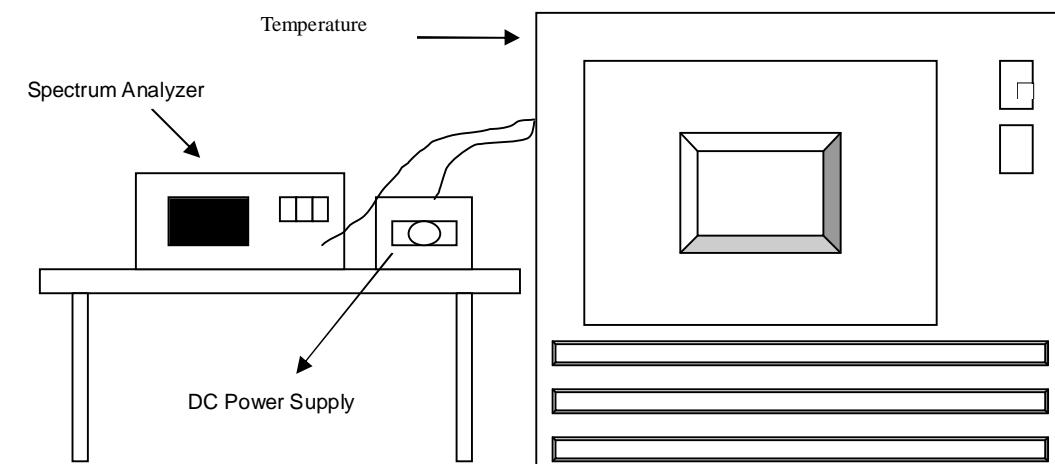

4.6.6 EUT OPERATING CONDITION

The software provided by client to enable the EUT under transmission condition continuously at specific channel frequencies individually.



A D T

4.6.7 TEST RESULTS

		Operating frequency: 5180MHz				Limit : $\pm 0.02\%$	
Temp. (°C)	Power supply (VAC)	2 minute		5 minute		10 minute	
		(MHz)	(%)	(MHz)	(%)	(MHz)	(%)
50	138	5319.9612	0.000729	5319.9627	0.000701	5319.9623	0.000709
	120	5319.9602	0.000748	5319.9612	0.000729	5319.9619	0.000716
	102	5319.9575	0.000799	5319.9624	0.000707	5319.9622	0.000711
40	138	5319.9586	0.000778	5319.9586	0.000778	5319.9579	0.000791
	120	5319.9582	0.000786	5319.9586	0.000778	5319.9588	0.000774
	102	5319.9577	0.000795	5319.9583	0.000784	5319.9589	0.000773
30	138	5319.9587	0.000776	5319.9586	0.000778	5319.9578	0.000793
	120	5319.9582	0.000786	5319.9583	0.000784	5319.9579	0.000791
	102	5319.9588	0.000774	5319.9585	0.000780	5319.9575	0.000799
20	138	5319.9588	0.000774	5319.9577	0.000795	5319.9571	0.000806
	120	5319.9593	0.000765	5319.9578	0.000793	5319.9572	0.000805
	102	5319.9622	0.000711	5319.9575	0.000799	5319.9576	0.000797
10	138	5319.9687	0.000588	5319.9706	0.000553	5319.9704	0.000556
	120	5319.9689	0.000585	5319.9688	0.000586	5319.9694	0.000575
	102	5319.9686	0.000590	5319.9701	0.000562	5319.9685	0.000592
0	138	5319.9695	0.000573	5319.9694	0.000575	5319.9695	0.000573
	120	5319.9687	0.000588	5319.9693	0.000577	5319.9694	0.000575
	102	5319.9712	0.000541	5319.9697	0.000570	5319.9689	0.000585
-10	138	5319.9697	0.000570	5319.9693	0.000577	5319.9686	0.000590
	120	5319.9695	0.000573	5319.9688	0.000586	5319.9684	0.000594
	102	5319.9691	0.000581	5319.9687	0.000588	5319.9682	0.000598
-20	138	5319.9672	0.000617	5319.9674	0.000613	5319.9673	0.000615
	120	5319.9676	0.000609	5319.9672	0.000617	5319.9671	0.000618
	102	5319.9671	0.000618	5319.9678	0.000605	5319.9674	0.000613
-30	138	5319.966	0.000639	5319.9665	0.000630	5319.9665	0.000630
	120	5319.9662	0.000635	5319.9667	0.000626	5319.9668	0.000624
	102	5319.9664	0.000632	5319.9662	0.000635	5319.9667	0.000626



A D T

4.7 ANTENNA PORT OUTPUT SPECTRUM PLOTS

4.7.1 TEST INSTRUMENTS

DESCRIPTION & MANUFACTURER	MODEL NO.	SERIAL NO.	CALIBRATED DATE	CALIBRATED UNTIL
R&S SPECTRUM ANALYZER	FSP40	100037	Aug. 03, 2009	Aug. 02, 2010

NOTE:

1. The calibration interval of the above test instruments is 12 months and the calibrations are traceable to NML/ROC and NIST/USA.

4.7.2 TEST PROCEDURE

The transmitter output was connected to the spectrum analyzer via a low loss cable. Set RBW of spectrum analyzer to 1MHz with suitable frequency span including 100 MHz bandwidth from band edge. The band edges were measured and recorded.

4.7.3 EUT OPERATING CONDITION

The software provided by client to enable the EUT under transmission condition continuously at specific channel frequencies individually.

4.7.4 TEST RESULTS

For 5.15 to 5.35GHz band:

The spectrum plots (Peak RBW=1MHz, VBW=3MHz) are attached on the following pages.



A D T

802.11a OFDM modulation

CH 36

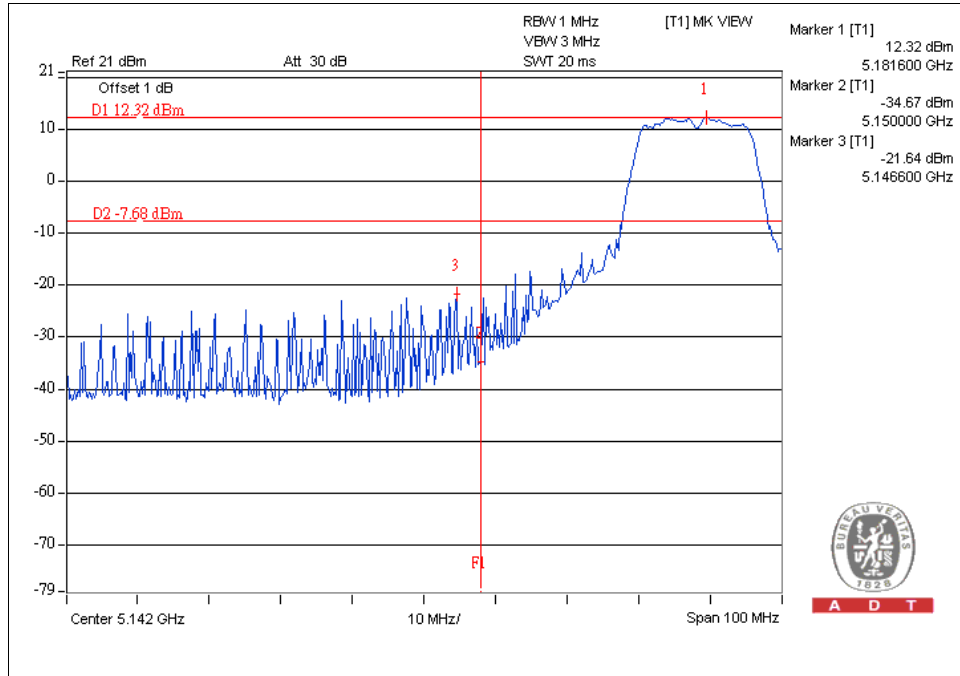

CH 64

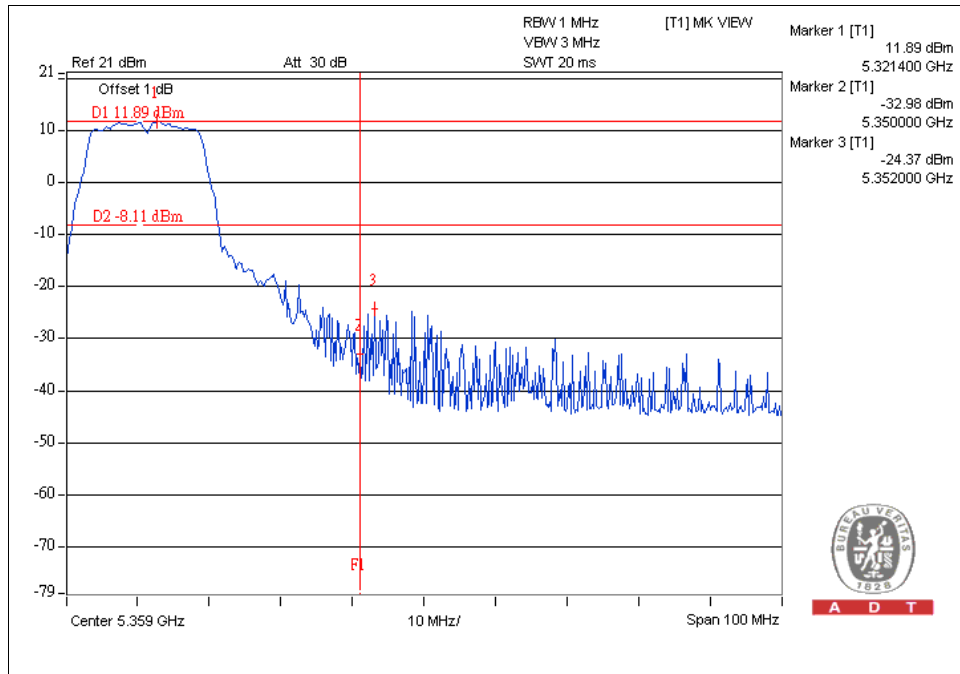



A D T

CH 36

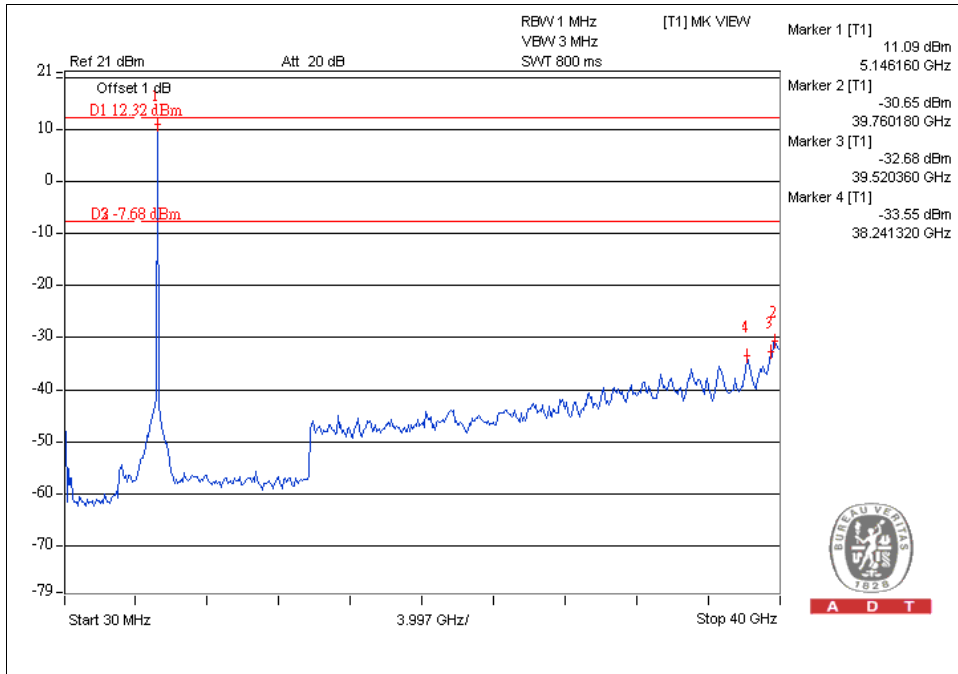

CH 64

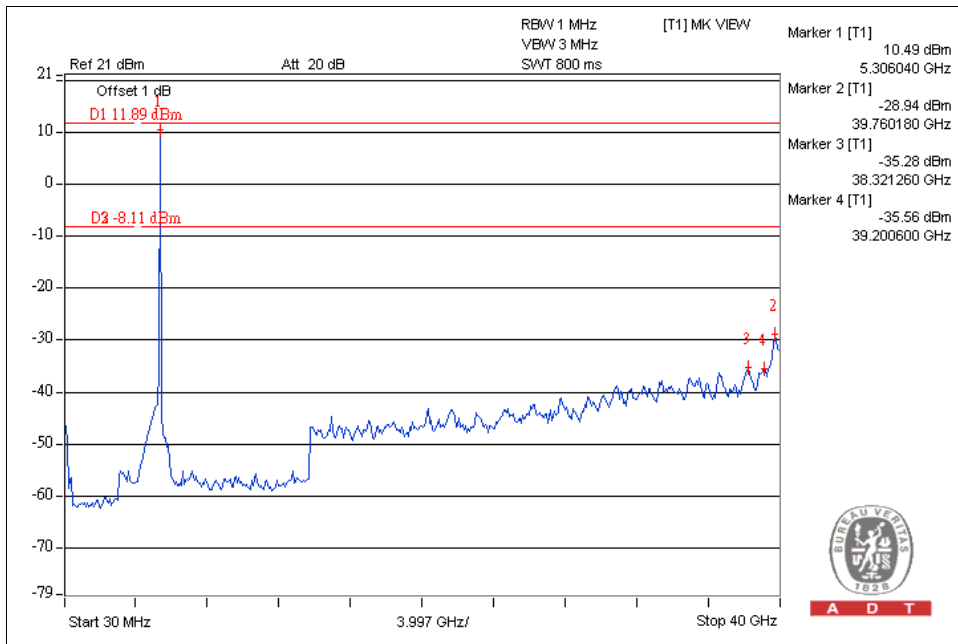



A D T

802.11n (20MHz) OFDM MODULATION:

CH36

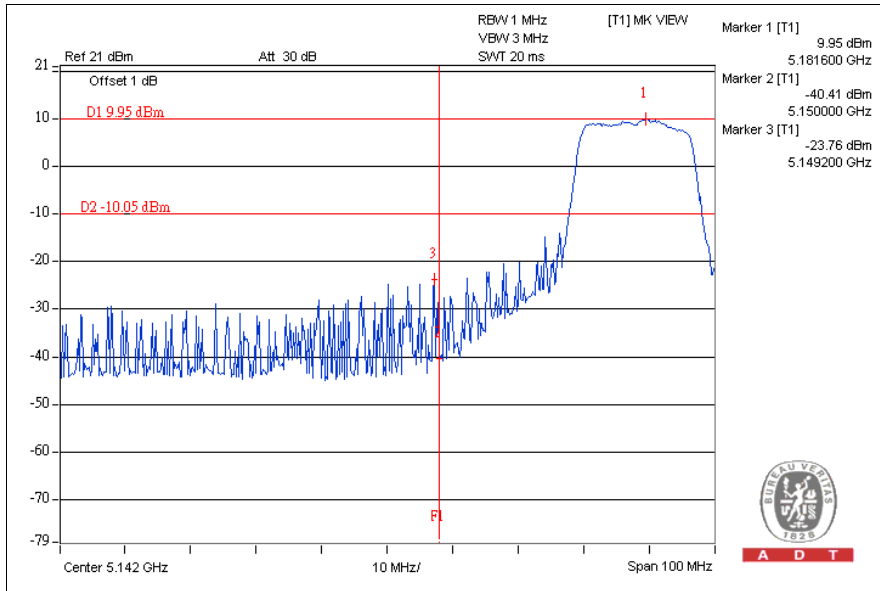

CH64

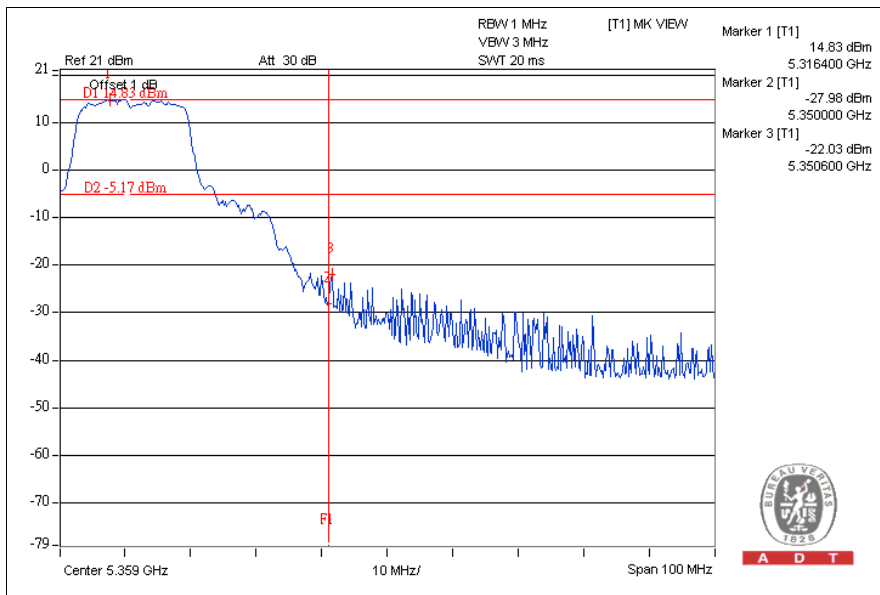



A D T

CH36

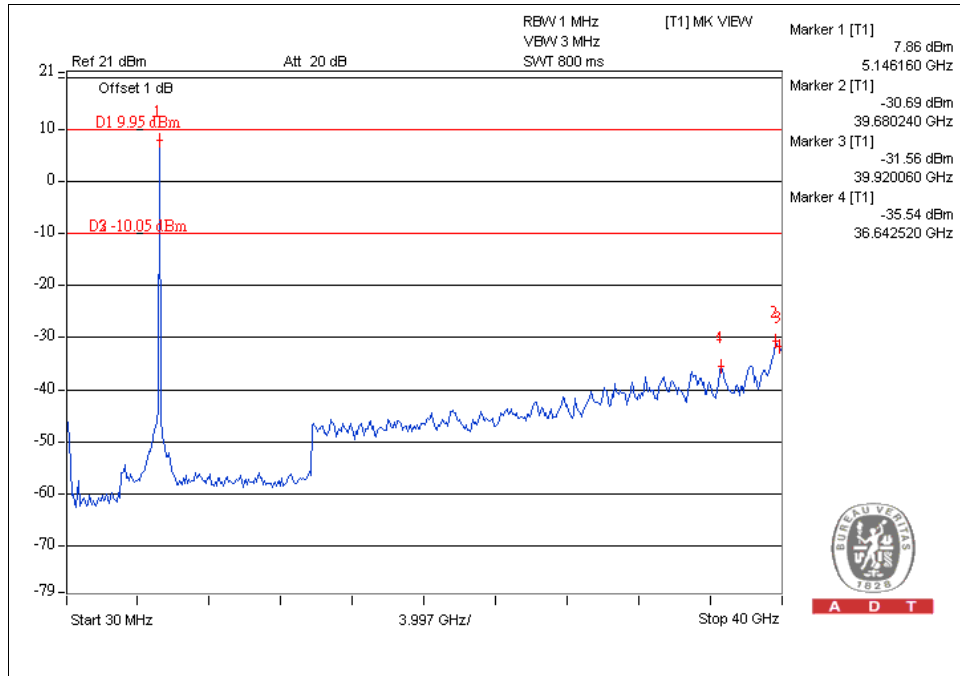

CH64

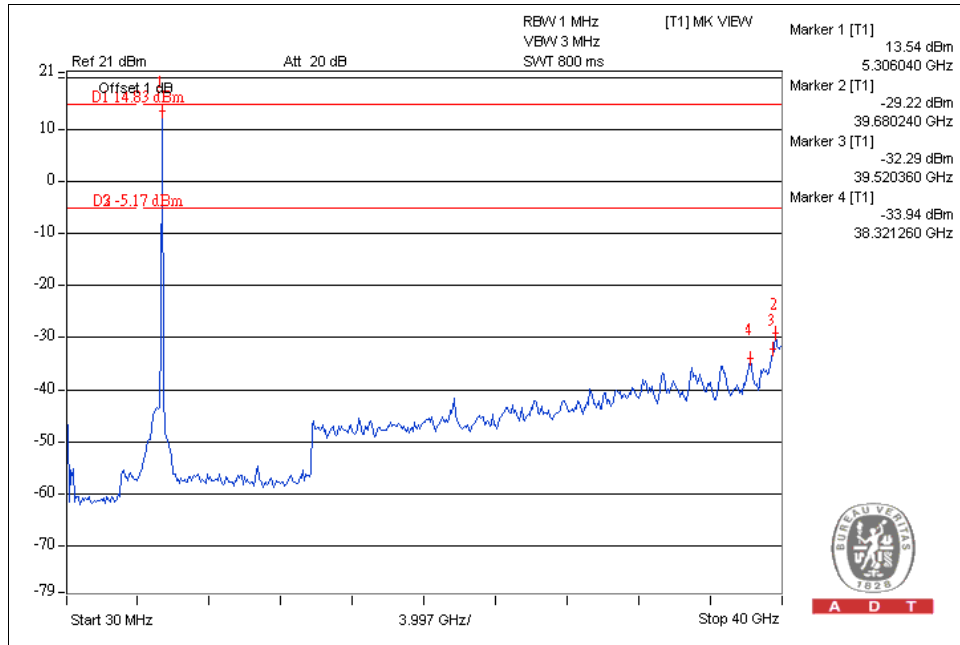

802.11n (40MHz) OFDM MODULATION:

CH38

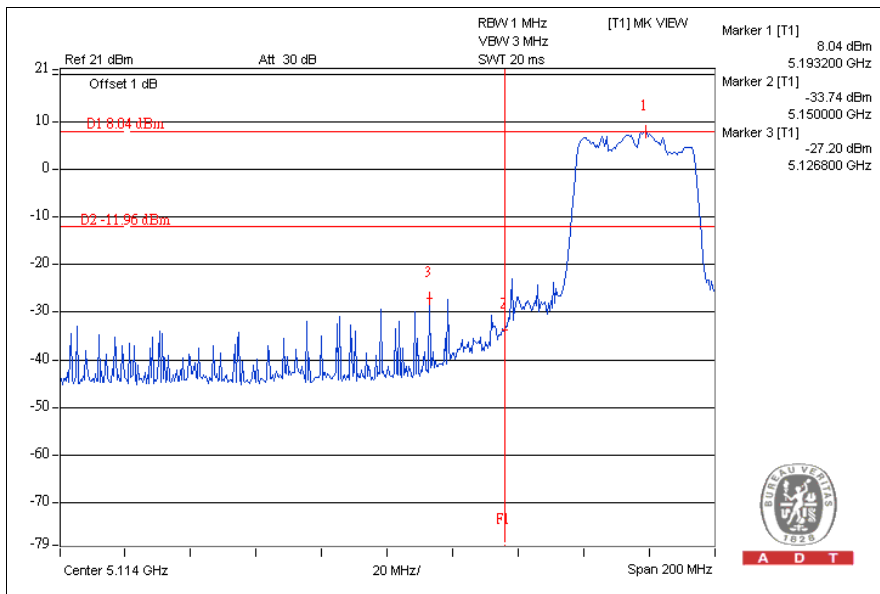

CH62

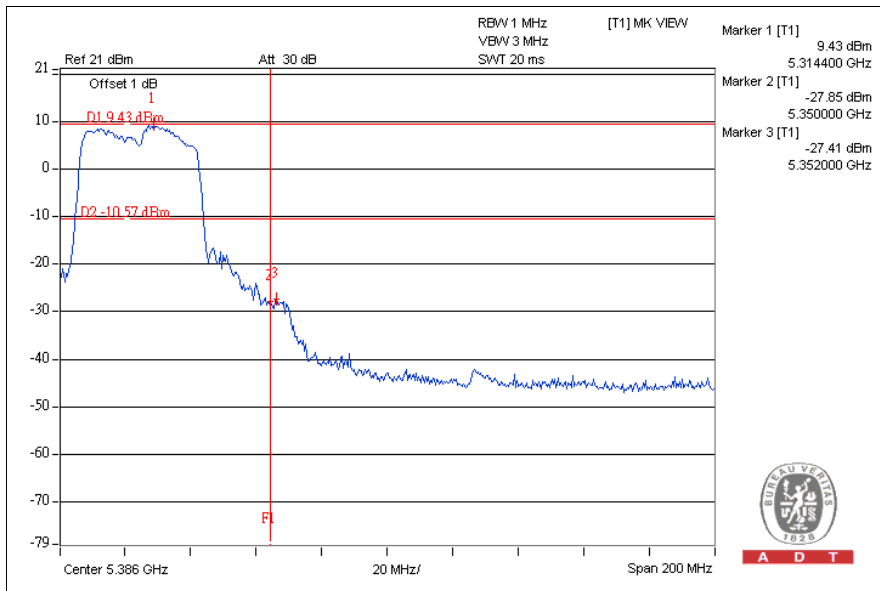



A D T

CH38

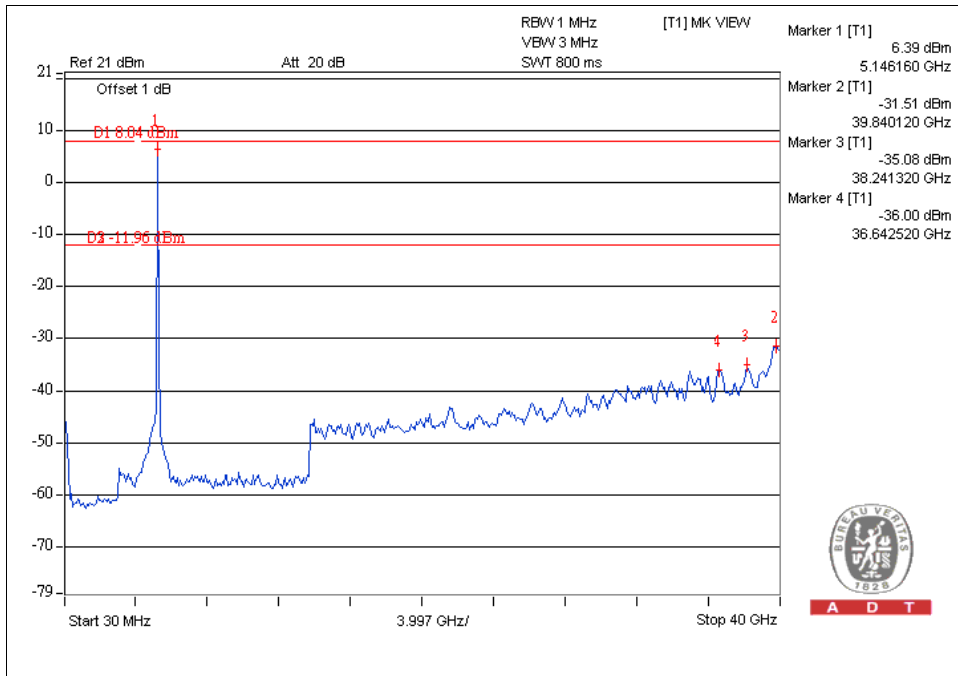

CH62

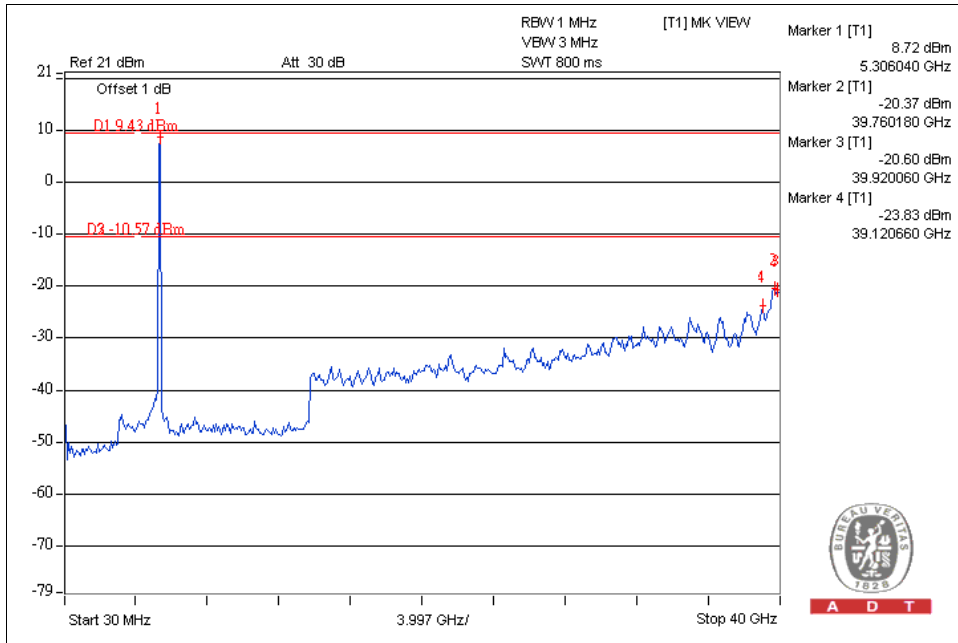

For 5.47 to 5.725GHz band:

The spectrum plots (Peak RBW=1MHz, VBW=3MHz) are attached on the following pages.



A D T

802.11a OFDM modulation

CH 100

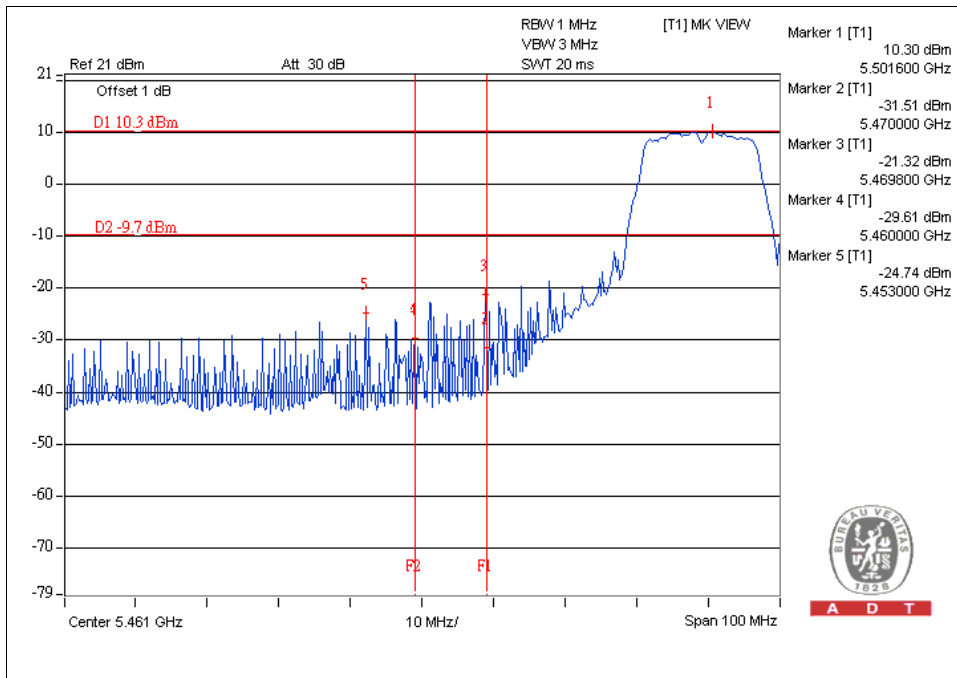

CH 140

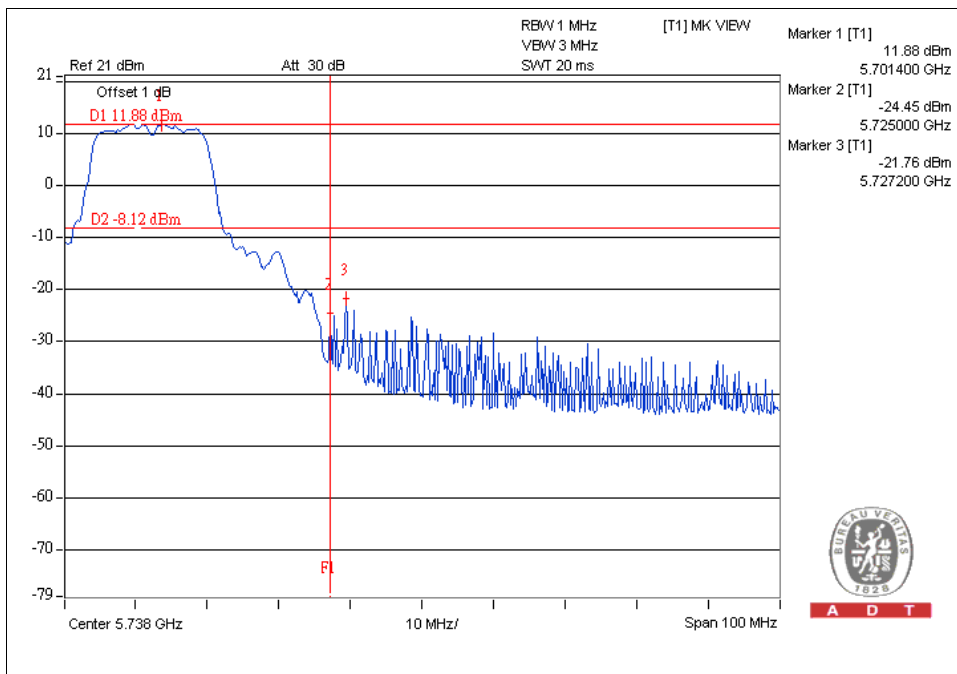



A D T

CH 100

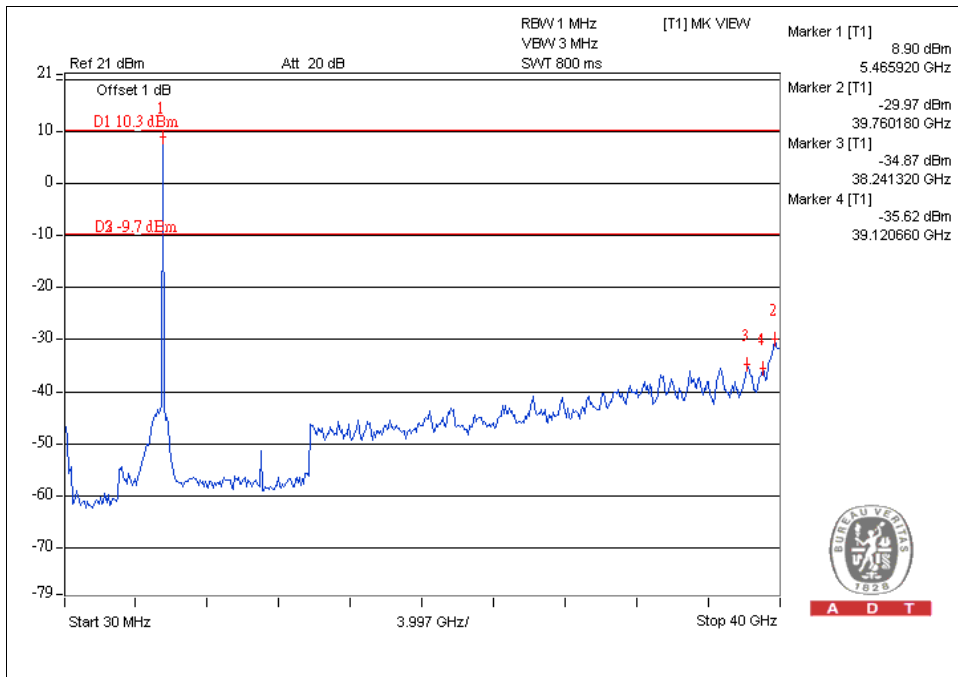

CH 140

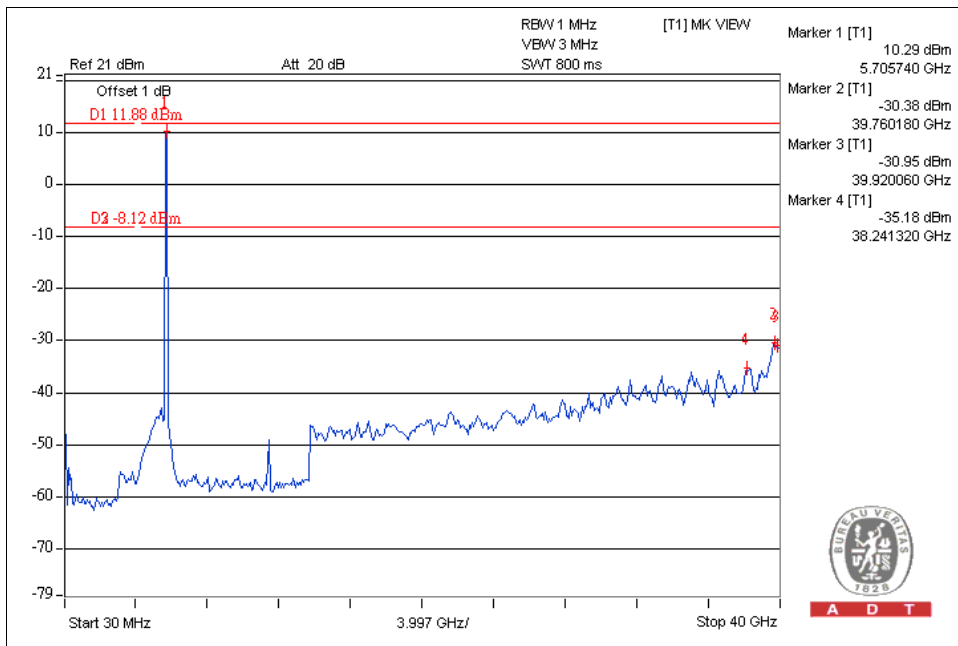

802.11n (20MHz) OFDM MODULATION:

CH100

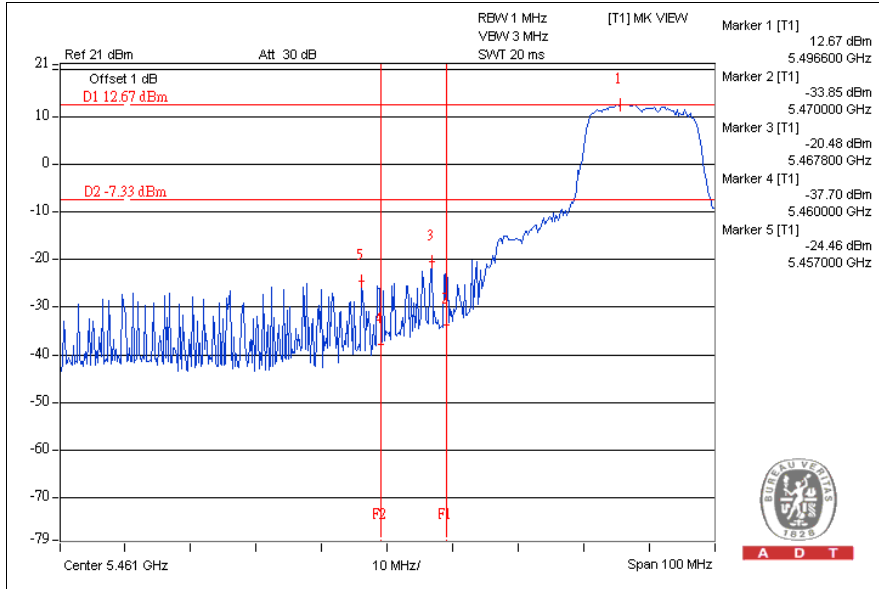

CH140

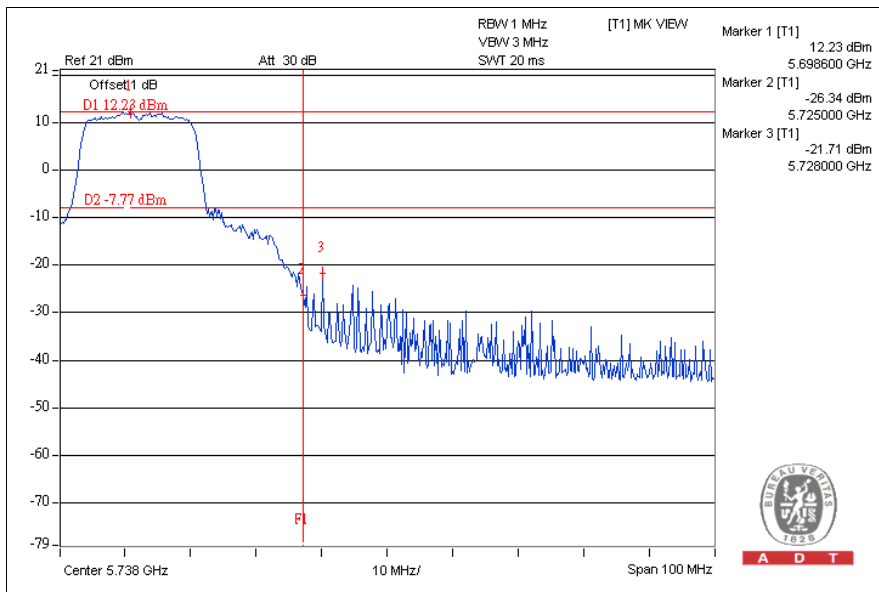



A D T

CH100

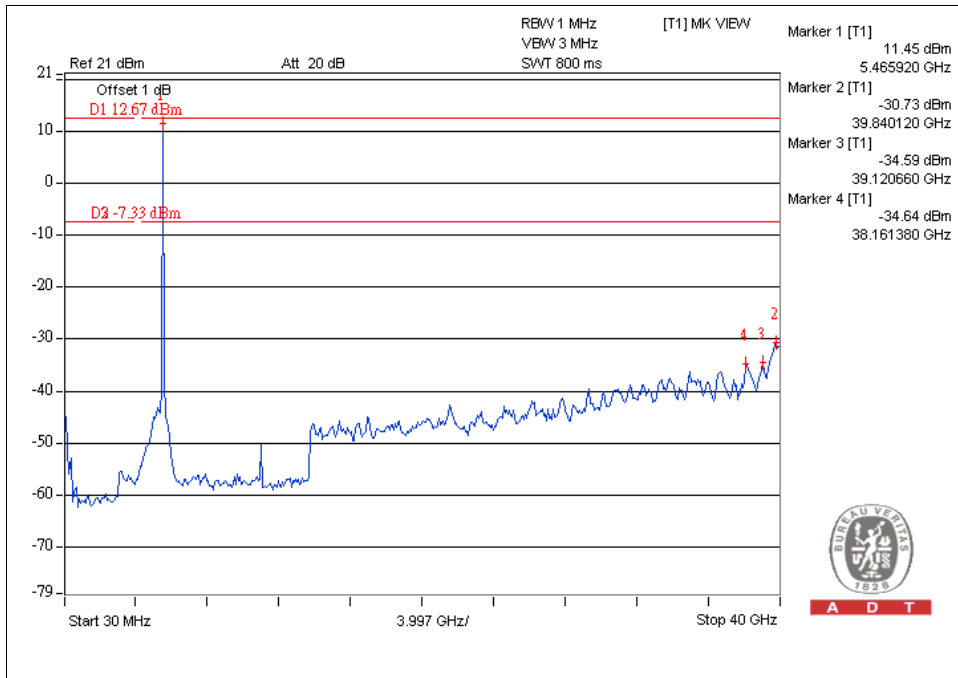

CH140

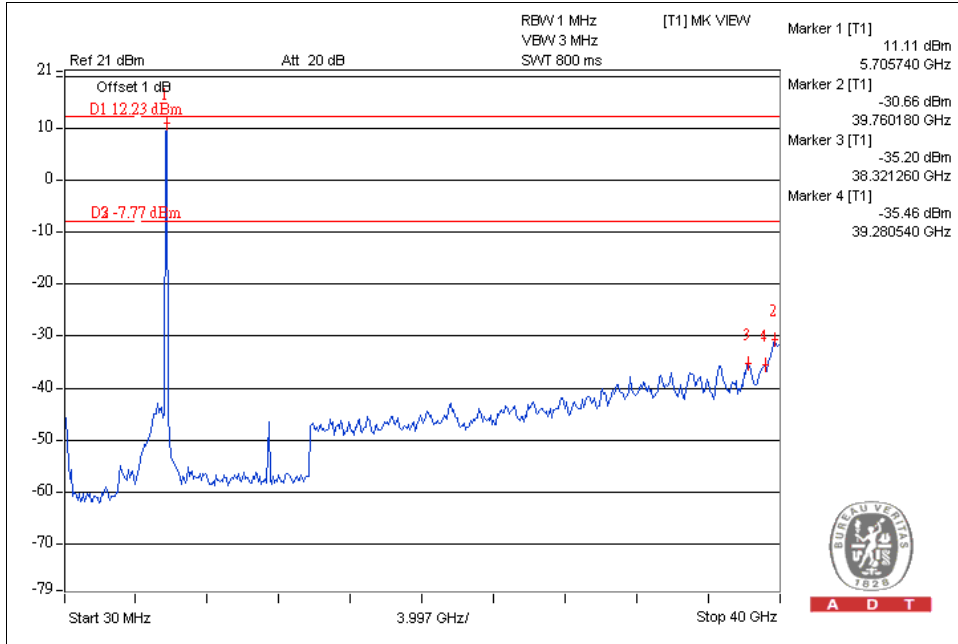

802.11n (40MHz) OFDM MODULATION:

CH102

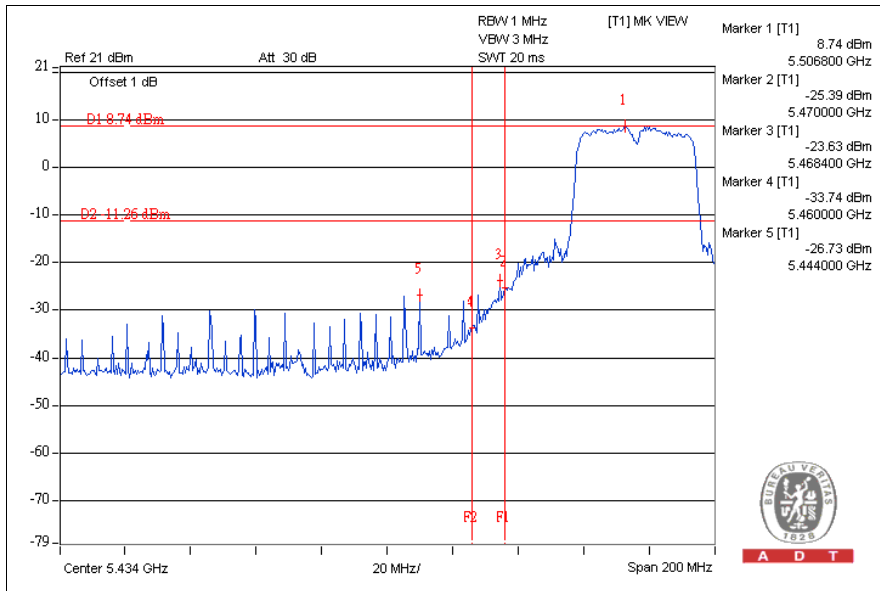

CH134

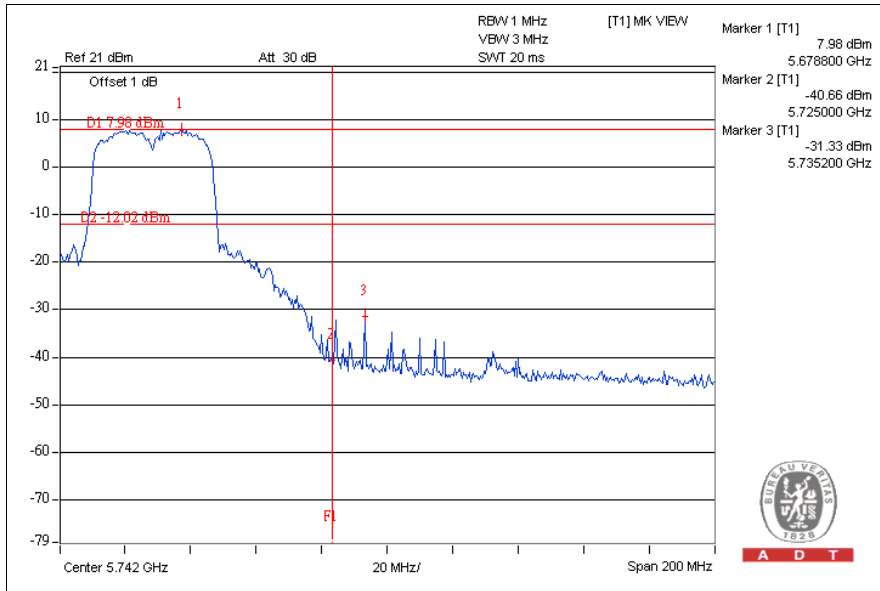



A D T

CH102

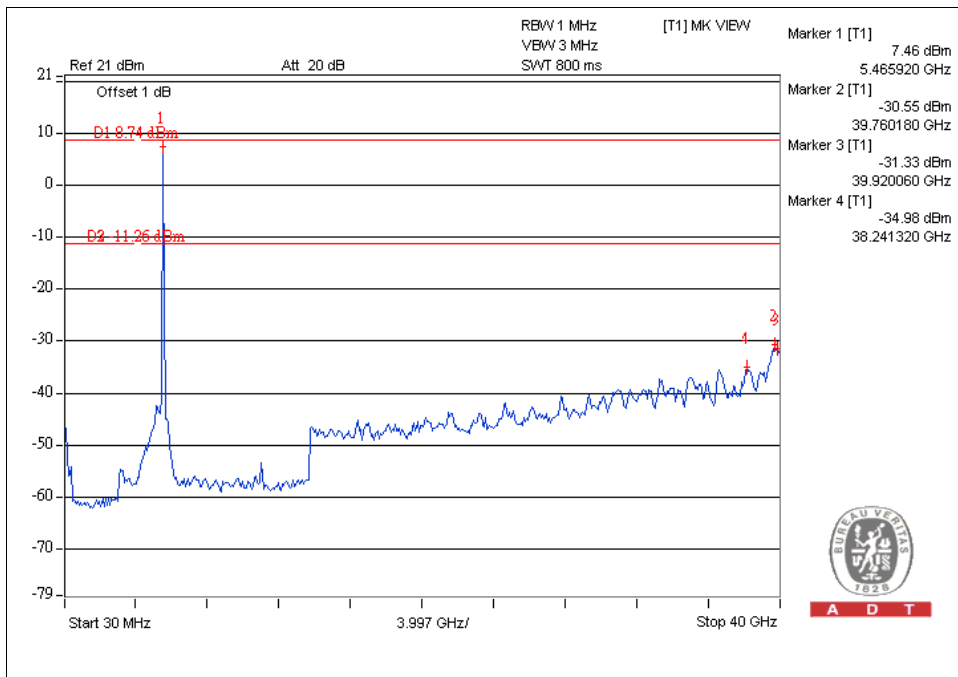

A D T

CH134

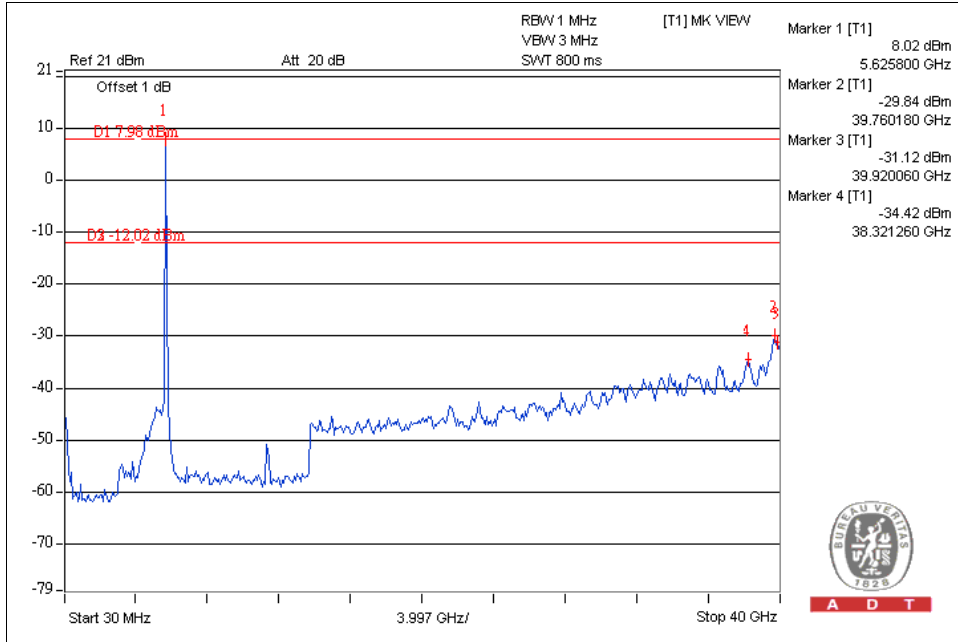

A D T



5. INFORMATION ON THE TESTING LABORATORIES

We, Bureau Veritas Consumer Products Services (H.K.) Ltd., Taoyuan Branch, were founded in 1988 to provide our best service in EMC, Radio, Telecom and Safety consultation. Our laboratories are accredited and approved according to ISO/IEC 17025:

Copies of accreditation certificates of our laboratories obtained from approval agencies can be downloaded from our web site:

www.adt.com.tw/index.5/phtml. If you have any comments, please feel free to contact us at the following:

Linko EMC/RF Lab:

Tel: 886-2-26052180

Fax: 886-2-26052943

Hsin Chu EMC/RF Lab:

Tel: 886-3-5935343

Fax: 886-3-5935342

Hwa Ya EMC/RF/Safety/Telecom Lab:

Tel: 886-3-3183232

Fax: 886-3-3185050

Email: service@mail.adt.com.tw

Web Site: www.adt.com.tw

The address and road map of all our labs can be found in our web site also.



A D T

6.APPENDIX-A- MODIFICATIONS RECORDERS FOR ENGINEERING CHANGES TO THE EUT BY THE LAB

No any modifications are made to the EUT by the lab during the test.

---END---