



FCC TEST REPORT (15.247)

REPORT NO.: RF980609H02A

MODEL NO.: WIS10ABGN

RECEIVED: Sep. 10, 2009

TESTED: Dec. 25, 2009 to Jan. 13, 2010

ISSUED: Jan. 14, 2010

APPLICANT: Samsung Electronics CO. LTD

ADDRESS: 416, Maetan-3Dong, Yeongtong-Gu
Suwon-City, Gyeonggi-Do, 443-742, Korea

ISSUED BY: Bureau Veritas Consumer Products Services (H.K.)
Ltd., Taoyuan Branch Hsin Chu Laboratory

ADDRESS: No. 81-1, Lu Liao Keng, 9th Ling, Wu Lung Tsuen,
Chiung Lin Hsiang, Hsin Chu Hsien 307, Taiwan

This test report consists of 122 pages in total. It may be duplicated completely for legal use with the approval of the applicant. It should not be reproduced except in full, without the written approval of our laboratory. The client should not use it to claim product endorsement by TAF or any government agencies. The test results in the report only apply to the tested sample.





A D T

Table of Contents

1.	CERTIFICATION	5
2.	SUMMARY OF TEST RESULTS	6
2.1	MEASUREMENT UNCERTAINTY	8
3.	GENERAL INFORMATION.....	9
3.1	GENERAL DESCRIPTION OF EUT	9
3.2	DESCRIPTION OF TEST MODES	12
3.2.1	TEST MODE APPLICABILITY AND TESTED CHANNEL DETAIL	13
3.3	GENERAL DESCRIPTION OF APPLIED STANDARDS	16
3.4	DESCRIPTION OF SUPPORT UNITS.....	17
3.5	CONFIGURATION OF SYSTEM UNDER TEST.....	17
4.	TEST TYPES AND RESULTS (802.11b & g, 2400 ~ 2483.5MHz Band)	18
4.1	CONDUCTED EMISSION MEASUREMENT.....	18
4.1.1	LIMITS OF CONDUCTED EMISSION MEASUREMENT	18
4.1.2	TEST INSTRUMENTS	18
4.1.3	TEST PROCEDURES.....	19
4.1.4	DEVIATION FROM TEST STANDARD	19
4.1.5	TEST SETUP	20
4.1.6	EUT OPERATING CONDITIONS	20
4.1.7	TEST RESULTS	21
4.2	RADIATED EMISSION MEASUREMENT	23
4.2.1	LIMITS OF RADIATED EMISSION MEASUREMENT	23
4.2.2	TEST INSTRUMENTS	24
4.2.3	TEST PROCEDURES.....	25
4.2.4	DEVIATION FROM TEST STANDARD	25
4.2.5	TEST SETUP	26
4.2.6	EUT OPERATING CONDITIONS	26
4.2.7	TEST RESULTS	27
4.3	6dB BANDWIDTH MEASUREMENT	56
4.3.1	LIMITS OF 6dB BANDWIDTH MEASUREMENT	56
4.3.2	TEST INSTRUMENTS	56
4.3.3	TEST PROCEDURE.....	57
4.3.4	DEVIATION FROM TEST STANDARD	57
4.3.5	TEST SETUP	57
4.3.6	EUT OPERATING CONDITIONS	57
4.3.7	TEST RESULTS	58
4.4	MAXIMUM PEAK OUTPUT POWER.....	62
4.4.1	LIMITS OF MAXIMUM PEAK OUTPUT POWER MEASUREMENT	62
4.4.2	INSTRUMENTS.....	62
4.4.3	TEST PROCEDURES.....	62



4.4.4	DEVIATION FROM TEST STANDARD	62
4.4.5	TEST SETUP	62
4.4.6	EUT OPERATING CONDITIONS	63
4.4.7	TEST RESULTS	64
4.5	POWER SPECTRAL DENSITY MEASUREMENT.....	66
4.5.1	LIMITS OF POWER SPECTRAL DENSITY MEASUREMENT	66
4.5.2	TEST INSTRUMENTS	66
4.5.3	TEST PROCEDURE	67
4.5.4	DEVIATION FROM TEST STANDARD	67
4.5.5	TEST SETUP	67
4.5.6	EUT OPERATING CONDITION.....	67
4.5.7	TEST RESULTS	68
4.6	CONDUCTED OUT-BAND EMISSION MEASUREMENT	72
4.6.1	LIMITS OF CONDUCTED OUT-BAND EMISSION MEASUREMENT.....	72
4.6.2	TEST INSTRUMENTS	72
4.6.3	TEST PROCEDURE	72
4.6.4	DEVIATION FROM TEST STANDARD	73
4.6.5	EUT OPERATING CONDITION.....	73
4.6.6	TEST RESULTS	73
5.	TEST TYPES AND RESULTS (802.11a, 5725~5850MHz Band)	82
5.1	CONDUCTED EMISSION MEASUREMENT.....	82
5.1.1	LIMITS OF CONDUCTED EMISSION MEASUREMENT	82
5.1.2	TEST INSTRUMENTS	82
5.1.3	TEST PROCEDURES.....	83
5.1.4	DEVIATION FROM TEST STANDARD	83
5.1.5	TEST SETUP	84
5.1.6	EUT OPERATING CONDITIONS	84
5.1.7	TEST RESULTS	85
5.2	RADIATED EMISSION MEASUREMENT	87
5.2.1	LIMITS OF RADIATED EMISSION MEASUREMENT.....	87
5.2.2	TEST INSTRUMENTS	88
5.2.3	TEST PROCEDURES.....	89
5.2.4	DEVIATION FROM TEST STANDARD	89
5.2.5	TEST SETUP	90
5.2.6	EUT OPERATING CONDITIONS	90
5.2.7	TEST RESULTS	91
	ABOVE 1GHz DATA	92
5.3	6dB BANDWIDTH MEASUREMENT	100
5.3.1	LIMITS OF 6dB BANDWIDTH MEASUREMENT.....	100
5.3.2	TEST INSTRUMENTS	100



5.3.3	TEST PROCEDURE.....	101
5.3.4	DEVIATION FROM TEST STANDARD	101
5.3.5	TEST SETUP	101
5.3.6	EUT OPERATING CONDITIONS	101
5.3.7	TEST RESULTS	102
5.4	MAXIMUM PEAK OUTPUT POWER.....	105
5.4.1	LIMITS OF MAXIMUM PEAK OUTPUT POWER MEASUREMENT	105
5.4.2	INSTRUMENTS.....	105
5.4.3	TEST PROCEDURES.....	105
5.4.4	DEVIATION FROM TEST STANDARD	105
5.4.5	TEST SETUP	105
5.4.6	EUT OPERATING CONDITIONS	105
5.4.7	TEST RESULTS	106
5.5	POWER SPECTRAL DENSITY MEASUREMENT.....	107
5.5.1	LIMITS OF POWER SPECTRAL DENSITY MEASUREMENT	107
5.5.2	TEST INSTRUMENTS	107
5.5.3	TEST PROCEDURE.....	108
5.5.4	DEVIATION FROM TEST STANDARD	108
5.5.5	TEST SETUP	108
5.5.6	EUT OPERATING CONDITION.....	108
5.5.7	TEST RESULTS	109
5.6	CONDUCTED OUT-BAND EMISSION MEASUREMENT	112
5.6.1	LIMITS OF CONDUCTED OUT-BAND EMISSION MEASUREMENT.....	112
5.6.2	TEST INSTRUMENTS	112
5.6.3	TEST PROCEDURE.....	113
5.6.4	DEVIATION FROM TEST STANDARD	113
5.6.5	EUT OPERATING CONDITION.....	113
5.6.6	TEST RESULTS	114
6.	INFORMATION ON THE TESTING LABORATORIES	121
7.	APPENDIX-A- MODIFICATIONS RECORDERS FOR ENGINEERING CHANGES TO THE EUT BY THE LAB	122



A D T

1. CERTIFICATION

PRODUCT: Wireless LAN adapter
BRAND NAME: SAMSUNG
MODEL NO.: WIS10ABGN
TEST SAMPLE: MASS-PRODUCTION
TESTED: Dec. 25, 2009 to Jan. 13, 2010
APPLICANT: Samsung Electronics CO. LTD
STANDARDS: FCC Part 15, Subpart C (Section 15.247),
ANSI C63.4-2003

The above equipment (Model: WIS10ABGN) has been tested by **Bureau Veritas Consumer Products Services (H.K.) Ltd., Taoyuan Branch**, and found compliance with the requirement of the above standards. The test record, data evaluation & Equipment Under Test (EUT) configurations represented herein are true and accurate accounts of the measurements of the sample's EMC characteristics under the conditions specified in this report.

PREPARED BY : Carol Liao , **DATE:** Jan. 14, 2010
(Carol Liao, Specialist)

TECHNICAL ACCEPTANCE : Hank Chung , **DATE:** Jan. 14, 2010
(Hank Chung, Deputy Manager)

APPROVED BY : May Chen , **DATE:** Jan. 14, 2010
(May Chen, Deputy Manager)



A D T

2. SUMMARY OF TEST RESULTS

The EUT has been tested according to the following specifications:

For 802.11b & g, 2412~2462MHz Band

APPLIED STANDARD: FCC Part 15, Subpart C (Section 15.247)			
Standard Section	Test Type and Limit	Result	Remark
15.207	AC Power Conducted Emission	PASS	Meet the requirement of limit. Minimum passing margin is -12.14dB at 1.922MHz
15.247(a)(2)	Spectrum Bandwidth of a Direct Sequence Spread Spectrum System Limit: min. 500kHz	PASS	Meet the requirement of limit.
15.247(b)	Maximum Peak Output Power Limit: max. 30dBm	PASS	Meet the requirement of limit.
15.247(d)	Radiated Emissions Limit: Table 15.209	PASS	Meet the requirement of limit. Minimum passing margin is -1.0dB at 2390.00MHz
15.247(e)	Power Spectral Density Limit: max. 8dBm	PASS	Meet the requirement of limit.
15.247(d)	Conducted Out-Band Emission Measurement Limit: 20dB less than the peak value of fundamental frequency	PASS	Meet the requirement of limit.
15.203	Antenna Requirement	PASS	No antenna connector is used.



A D T

For 802.11a, 5725~5850MHz Band

APPLIED STANDARD: FCC Part 15, Subpart C (Section 15.247)			
Standard Section	Test Type and Limit	Result	Remark
15.207	AC Power Conducted Emission	PASS	Meet the requirement of limit. Minimum passing margin is -11.37dB at 1.906MHz
15.247(a)(2)	Spectrum Bandwidth of a Direct Sequence Spread Spectrum System Limit: min. 500kHz	PASS	Meet the requirement of limit.
15.247(b)	Maximum Peak Output Power Limit: max. 30dBm	PASS	Meet the requirement of limit.
15.247(d)	Radiated Emissions Limit: Table 15.209	PASS	Meet the requirement of limit. Minimum passing margin is -3.1dB at 840.00MHz
15.247(e)	Power Spectral Density Limit: max. 8dBm	PASS	Meet the requirement of limit.
15.247(d)	Conducted Out-Band Emission Measurement Limit: 20dB less than the peak value of fundamental frequency	PASS	Meet the requirement of limit.
15.203	Antenna Requirement	PASS	No antenna connector is used.

NOTE:

1. The EUT was operating in 2400 ~ 2483.5MHz, 5.15~5.35GHz, 5.47~5.725GHz and 5.725~5.850GHz frequencies band. This report was recorded the RF parameters including 2400 ~ 2483.5MHz and 5.725~5.850GHz. For the 5.15~5.35GHz and 5.47~5.725GHz RF parameters was recorded in another test report.

2.1 MEASUREMENT UNCERTAINTY

Where relevant, the following measurement uncertainty levels have been estimated for tests performed on the EUT as specified in CISPR 16-4-2:

This uncertainty represents an expanded uncertainty expressed at approximately the 95% confidence level using a coverage factor of $k=2$.

Measurement	Value
Conducted emissions	2.44 dB
Radiated emissions (30MHz-1GHz)	3.94 dB
Radiated emissions (1GHz -18GHz)	2.49 dB
Radiated emissions (18GHz -40GHz)	2.70 dB



A D T

3. GENERAL INFORMATION

3.1 GENERAL DESCRIPTION OF EUT

PRODUCT	Wireless LAN adapter
MODEL NO.	WIS10ABGN
FCC ID	A3L-WIS10ABGN
POWER SUPPLY	DC 5V from host equipment
MODULATION TYPE	CCK, DQPSK, DBPSK for DSSS 64QAM, 16QAM, QPSK, BPSK for OFDM
MODULATION TECHNOLOGY	DSSS, OFDM
TRANSFER RATE	802.11b: 11 / 5.5 / 2 / 1Mbps 802.11g: 54 / 48 / 36 / 24 / 18 / 12 / 9 / 6Mbps 802.11a: 54 / 48 / 36 / 24 / 18 / 12 / 9 / 6Mbps 802.11n (20MHz, 800ns GI MCS8~15): 130 / 117 / 104 / 78 / 52 / 39 / 26 / 13 802.11n (20MHz, 800ns GI MCS0~7): 65 / 58.5 / 52 / 39 / 26 / 19.5 / 13 / 6.5Mbps 802.11n (40MHz, 800ns GI MCS8~15): 270 / 243 / 216 / 162 / 108 / 81 / 54 / 27 802.11n (40MHz, 800ns GI MCS0~7): 135 / 121.5 / 108 / 81 / 54 / 40.5 / 27 / 13.5Mbps 802.11n (20MHz, 400ns GI MCS8~15): 144.444 / 130 / 115.556 / 86.667 / 57.778 / 43.333 / 28.889 / 14.444 802.11n (20MHz, 400ns GI MCS0~7): 72.2 / 65 / 57.8 / 43.3 / 28.9 / 21.7 / 14.4 / 7.2Mbps 802.11n (40MHz, 400ns GI MCS8~15): 300 / 270 / 240 / 180 / 120 / 90 / 60 / 30 802.11n (40MHz, 400ns GI MCS0~7): 150 / 135 / 120 / 90 / 60 / 45 / 30 / 15Mbps
FREQUENCY RANGE	For 15.407 802.11a: 5.18 ~ 5.24GHz, 5.26 ~ 5.32GHz, 5.50 ~ 5.70GHz For 15.247 802.11b & 802.11g: 2412 ~ 2462MHz 802.11a: 5.745 ~ 5.825GHz



A D T

NUMBER OF CHANNEL	For 15.407 19 for 802.11a, 802.11n (20MHz) 9 for 802.11n (40MHz)
	For 15.247(2.4GHz) 11 for 802.11b, 802.11g, 802.11n (20MHz) 7 for 802.11n (40MHz)
	For 15.247(5GHz) 5 for 802.11a, 802.11n (20MHz) 2 for 802.11n (40MHz)
MAXIMUM OUTPUT POWER	For 15.407 802.11a: 33.9mW 802.11n (20MHz): 94.6mW 802.11n (40MHz): 82.5mW For 15.247(2.4GHz) 802.11b: 239.9mW 802.11g: 269.2mW 802.11n (20MHz): 545.4mW 802.11n (40MHz): 571.1mW For 15.247(5GHz) 802.11a: 147.9mW 802.11n (20MHz): 303.0mW 802.11n (40MHz): 273.8mW
ANTENNA TYPE	Please see note 1
ANTENNA CONNECTOR	Please see note 1
DATA CABLE	NA
INTERFACE	USB interface
ASSOCIATED DEVICES	Cradle x 1



A D T

NOTE:

1. There are two antennas provided to this EUT, please refer to the following table:

No.	Antenna Type	For 2.4GHz Gain (dBi)	For 5GHz Gain (dBi)				Antenna Connector
			5.125 ~ 5.25 MHz	5.25 ~ 5.35 MHz	5.47 ~ 5.725 MHz	5.725 ~ 5.850 MHz	
CHAIN(0)	Printed	0.46	0.9	1.53	1.58	1.72	NA
CHAIN(1)	Printed	-0.04	-0.91	1.71	0.79	0.09	NA

2. The EUT was pre-tested in chamber as the following test modes:

Test Mode	Description
Mode 1	With Cradle
Mode 2	Without Cradle

From the above modes, the worse emission level was found in **Mode 1**. Therefore only the test data of the mode was recorded in this report individually.

3. The EUT incorporates a MIMO function with 802.11n. Physically, the EUT provides two completed transmitters and two completed receivers.
4. The EUT is 2 * 2 spatial MIMO (2Tx & 2Rx) without beam forming function. The antenna configurations are two transmitter antennas and two receiver antennas, as there are 2 Printed antennas. Spatial multiplexing modes for simultaneous transmission using 2 antennas, and for simultaneous receiver using 2 antennas.
5. The EUT complies with 802.11n standards and backwards compatible with 802.11a, 802.11b, 802.11g products.
6. The above EUT information was declared by manufacturer and for more detailed features description, please refer to the manufacturer's specifications or user's manual.

3.2 DESCRIPTION OF TEST MODES

Operated in 2400 ~ 2483.5MHz band:

Eleven channels are provided for 802.11b, 802.11g, 802.11n (20MHz):

CHANNEL	FREQUENCY	CHANNEL	FREQUENCY
1	2412MHz	7	2442MHz
2	2417MHz	8	2447MHz
3	2422MHz	9	2452MHz
4	2427MHz	10	2457MHz
5	2432MHz	11	2462MHz
6	2437MHz		

Seven channels are provided for 802.11n (40MHz):

CHANNEL	FREQUENCY	CHANNEL	FREQUENCY
1	2422MHz	5	2442MHz
2	2427MHz	6	2447MHz
3	2432MHz	7	2452MHz
4	2437MHz		

Operated in 5725 ~ 5850MHz band:

Five channels are provided for 802.11a, 802.11n (20MHz):

CHANNEL	FREQUENCY	CHANNEL	FREQUENCY
149	5745 MHz	161	5805 MHz
153	5765 MHz	165	5825 MHz
157	5785 MHz		

Two channels are provided for 802.11n (40MHz):

CHANNEL	FREQUENCY
151	5755 MHz
159	5795 MHz

3.2.1 TEST MODE APPLICABILITY AND TESTED CHANNEL DETAIL

EUT CONFIGURE MODE	APPLICABLE TO				DESCRIPTION
	PLC	RE < 1G	RE ≥ 1G	APCM	
-	√	√	√	√	-

Where **PLC**: Power Line Conducted Emission **RE < 1G**: Radiated Emission below 1GHz
RE ≥ 1G: Radiated Emission above 1GHz **APCM**: Antenna Port Conducted Measurement

ANTENNA COMBINATION MODE:

COMBINATION MODE	OPERATION MODE	TX CHAIN(0)	TX CHAIN(1)
A	802.11 b	√	
B	802.11 g	√	
C	802.11 a	√	
D	802.11n(20MHz) for MCS0~7	√	√
E	802.11n(20MHz) for MCS8~15	√	√
F	802.11n(40MHz) for MCS0~7	√	√
G	802.11n(40MHz) for MCS8~15	√	√

Note:

1. The above information was declared by manufacturer and for more detailed features description, please refer to the manufacturer's specifications or user's manual.
2. Mode A, B, C, D and F the worst modes, were selected as representative mode for the report.

POWER LINE CONDUCTED EMISSION TEST:

- Pre-Scan has been conducted to determine the worst-case mode from all possible combinations between available modulations, data rates and antenna ports (if EUT with antenna diversity architecture).
- Following channel(s) was (were) selected for the final test as listed below.

MODE	AVAILABLE CHANNEL	TESTED CHANNEL	MODULATION TECHNOLOGY	MODULATION TYPE	DATA RATE (Mbps)	COMBINATION MODE
For 2.4 GHz 802.11n (40MHz)	1 to 7	4	OFDM	BPSK	15	F
For 5 GHz 802.11n (20MHz)	149 to 165	157	OFDM	BPSK	7.2	D



A D T

RADIATED EMISSION TEST (BELOW 1 GHz):

- Pre-Scan has been conducted to determine the worst-case mode from all possible combinations between available modulations, data rates and antenna ports (if EUT with antenna diversity architecture).
- Following channel(s) was (were) selected for the final test as listed below.

MODE	AVAILABLE CHANNEL	TESTED CHANNEL	MODULATION TECHNOLOGY	MODULATION TYPE	DATA RATE (Mbps)	COMBINATION MODE
For 2.4 GHz 802.11n (40MHz)	1 to 7	4	OFDM	BPSK	15	F
For 5 GHz 802.11n (20MHz)	149 to 165	157	OFDM	BPSK	7.2	D

RADIATED EMISSION TEST (ABOVE 1 GHz):

- Pre-Scan has been conducted to determine the worst-case mode from all possible combinations between available modulations, data rates and antenna ports (if EUT with antenna diversity architecture).
- Following channel(s) was (were) selected for the final test as listed below.

MODE	AVAILABLE CHANNEL	TESTED CHANNEL	MODULATION TECHNOLOGY	MODULATION TYPE	DATA RATE (Mbps)	COMBINATION MODE
802.11b	1 to 11	1, 6, 11	DSSS	DBPSK	1	A
802.11g	1 to 11	1, 6, 11	OFDM	BPSK	6	B
For 2.4 GHz 802.11n (20MHz)	1 to 11	1, 6, 11	OFDM	BPSK	7.2	D
For 2.4 GHz 802.11n (40MHz)	1 to 7	1, 4, 7	OFDM	BPSK	15	F
802.11a	149 to 165	149, 157, 165	OFDM	BPSK	6	C
For 5 GHz 802.11n (20MHz)	149 to 165	149, 157, 165	OFDM	BPSK	7.2	D
For 5 GHz 802.11n (40MHz)	151 to 159	151, 159	OFDM	BPSK	15	F



A D T

CONDUCTED OUT-BAND EMISSION MEASUREMENT:

- Pre-Scan has been conducted to determine the worst-case mode from all possible combinations between available modulations, data rates and antenna ports (if EUT with antenna diversity architecture).
- Following channel(s) was (were) selected for the final test as listed below.

MODE	AVAILABLE CHANNEL	TESTED CHANNEL	MODULATION TECHNOLOGY	MODULATION TYPE	DATA RATE (Mbps)	COMBINATION MODE
802.11b	1 to 11	1, 11	DSSS	DBPSK	1	A
802.11g	1 to 11	1, 11	OFDM	BPSK	6	B
For 2.4 GHz 802.11n (20MHz)	1 to 11	1, 11	OFDM	BPSK	7.2	D
For 2.4 GHz 802.11n (40MHz)	1 to 7	1, 7	OFDM	BPSK	15	F
802.11a	149 to 165	149, 165	OFDM	BPSK	6	C
For 5 GHz 802.11n (20MHz)	149 to 165	149, 165	OFDM	BPSK	7.2	D
For 5 GHz 802.11n (40MHz)	151 to 159	151, 159	OFDM	BPSK	15	F

※ After verification, conducted out band emission as show worst chain in report by investigations.

ANTENNA PORT CONDUCTED MEASUREMENT:

- This item includes all test value of each mode, but only includes spectrum plot of worst value of each mode.
- Pre-Scan has been conducted to determine the worst-case mode from all possible combinations between available modulations, data rates and antenna ports (if EUT with antenna diversity architecture).
- Following channel(s) was (were) selected for the final test as listed below.

MODE	AVAILABLE CHANNEL	TESTED CHANNEL	MODULATION TECHNOLOGY	MODULATION TYPE	DATA RATE (Mbps)	COMBINATION MODE
802.11b	1 to 11	1, 6, 11	DSSS	DBPSK	1	A
802.11g	1 to 11	1, 6, 11	OFDM	BPSK	6	B
For 2.4 GHz 802.11n (20MHz)	1 to 11	1, 6, 11	OFDM	BPSK	7.2	D
For 2.4 GHz 802.11n (40MHz)	1 to 7	1, 4, 7	OFDM	BPSK	15	F
802.11a	149 to 165	149, 157, 165	OFDM	BPSK	6	C
For 5 GHz 802.11n (20MHz)	149 to 165	149, 157, 165	OFDM	BPSK	7.2	D
For 5 GHz 802.11n (40MHz)	151 to 159	151, 159	OFDM	BPSK	15	F

※ After verification, bandwidth as show worst chain in report by investigations.



ADT

TEST CONDITION:

APPLICABLE TO	ENVIRONMENTAL CONDITIONS	INPUT POWER (SYSTEM)	TESTED BY
RE ³ 1G	15deg. C, 69%RH, 1024 hPa	120Vac, 60Hz	Frank Liu
RE<1G	14deg. C, 70%RH, 1024 hPa	120Vac, 60Hz	Frank Liu
PLC	19deg. C, 58%RH, 1024 hPa	120Vac, 60Hz	Phoenix Huang
APCM	25deg. C, 60%RH, 1024 hPa	120Vac, 60Hz	Phoenix Huang

3.3 GENERAL DESCRIPTION OF APPLIED STANDARDS

The EUT is a Wireless LAN adapter. According to the specifications of the manufacturer, it must comply with the requirements of the following standards:

FCC Part 15, Subpart C. (15.247)

ANSI C63.4-2003

All test items have been performed and recorded as per the above standards.

NOTE: The EUT is also considered as a kind of computer peripheral, because the connection to computer is necessary for typical use. It has been verified to comply with the requirements of FCC Part 15, Subpart B, Class B (DoC). The test report has been issued separately.



A D T

3.4 DESCRIPTION OF SUPPORT UNITS

The EUT has been tested as an independent unit together with other necessary accessories or support units. The following support units or accessories were used to form a representative test configuration during the tests.

NO.	PRODUCT	BRAND	MODEL NO.	SERIAL NO.	FCC ID
1	NOTEBOOK COMPUTER	DELL	PP18L	6976685584	DoC
2	iPod	Apple	A1137	6U6078FMUPR	DoC

NO.	SIGNAL CABLE DESCRIPTION OF THE ABOVE SUPPORT UNITS
1	NA
2	1.0 m shielded cable, terminated with USB connector, w/o core.

NOTE: 1. All power cords of the above support units are non shielded (1.8m).

3.5 CONFIGURATION OF SYSTEM UNDER TEST

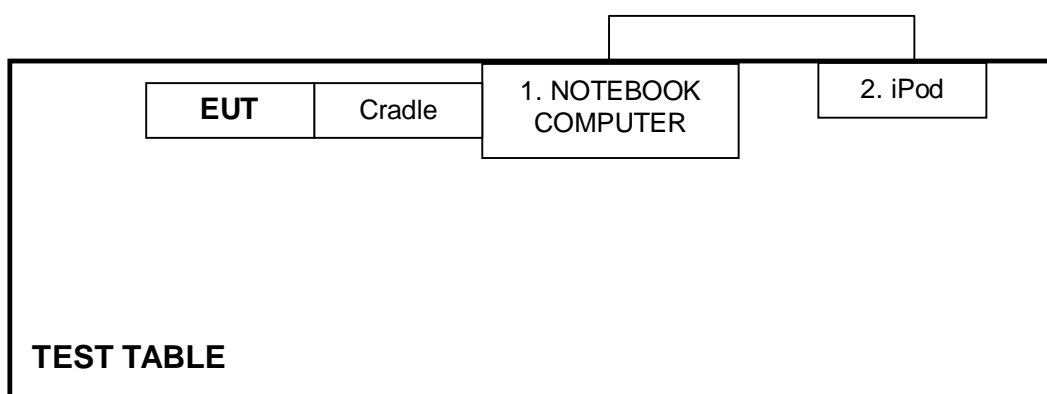



A D T

4. TEST TYPES AND RESULTS (802.11b & g, 2400 ~ 2483.5MHz Band)

4.1 CONDUCTED EMISSION MEASUREMENT

4.1.1 LIMITS OF CONDUCTED EMISSION MEASUREMENT

FREQUENCY OF EMISSION (MHz)	CONDUCTED LIMIT (dBµV)	
	Quasi-peak	Average
0.15-0.5	66 to 56	56 to 46
0.5-5	56	46
5-30	60	50

- NOTE:**
1. The lower limit shall apply at the transition frequencies.
 2. The limit decreases in line with the logarithm of the frequency in the range of 0.15 to 0.50 MHz.
 3. All emanations from a class A/B digital device or system, including any network of conductors and apparatus connected thereto, shall not exceed the level of field strengths specified above.

4.1.2 TEST INSTRUMENTS

DESCRIPTION & MANUFACTURER	MODEL NO.	SERIAL NO.	CALIBRATED DATE	CALIBRATED UNTIL
Test Receiver	ESCS 30	100375	Mar. 23, 2009	Mar. 22, 2010
Line-Impedance Stabilization Network (for Peripheral)	ENV-216	100071	Nov. 30, 2009	Nov. 29, 2010
Line-Impedance Stabilization Network (for EUT)	ESH3-Z5	848773/004	Oct. 26, 2009	Oct. 25, 2010
RF Cable (JYEBAO)	5DFB	COBCAB-001	Aug. 14, 2009	Aug. 13, 2010
50 ohms Terminator	50	3	Oct. 28, 2009	Oct. 27, 2010
Software	BV ADT_ Cond_V7.3.7	NA	NA	NA

Note:

1. The calibration interval of the above test instruments is 12 months and the calibrations are traceable to NML/ROC and NIST/USA.
2. The test was performed in Shielded Room No. B.
3. The VCCI Con B Registration No. is C-2193.

4.1.3 TEST PROCEDURES

- a. The EUT was placed 0.4 meters from the conducting wall of the shielded room with EUT being connected to the power mains through a line impedance stabilization network (LISN). Other support units were connected to the power mains through another LISN. The two LISNs provide 50 ohm/ 50uH of coupling impedance for the measuring instrument.
- b. Both lines of the power mains connected to the EUT were checked for maximum conducted interference.
- c. The frequency range from 150kHz to 30MHz was searched. Emission levels under (Limit - 20dB) were not recorded.

4.1.4 DEVIATION FROM TEST STANDARD

No deviation

4.1.5 TEST SETUP

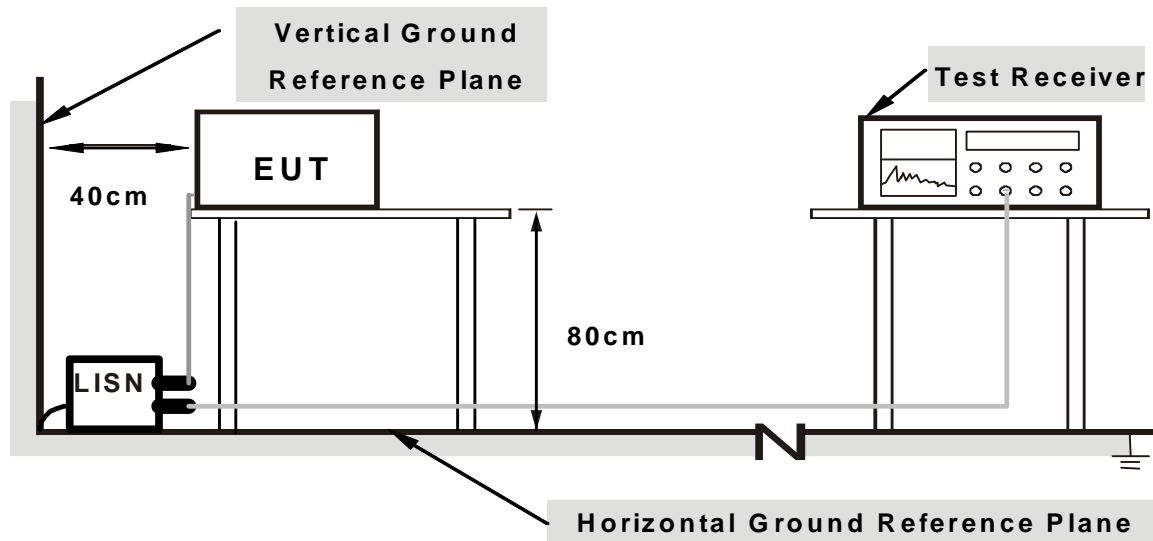

Note: 1. Support units were connected to second LISN.

2. Both of LISNs (AMN) are 80 cm from EUT and at least 80 from other units and other metal planes

For the actual test configuration, please refer to the related item – Photographs of the Test Configuration.

4.1.6 EUT OPERATING CONDITIONS

- a. Connect the EUT with the support unit 1 (Notebook Computer) which placed on a testing table via one Cradle.
- b. The communication partner run test program “RT3x7xQA.exe” to enable EUT under transmission/receiving condition continuously at specific channel frequency.

4.1.7 TEST RESULTS

802.11n (40MHz) OFDM MODULATION:

PHASE	Line (L)	6dB BANDWIDTH	9 kHz
--------------	----------	----------------------	-------

No	Freq.	Corr.	Reading Value		Emission Level		Limit		Margin	
	[MHz]	Factor	[dB (uV)]		[dB (uV)]		[dB (uV)]		(dB)	
		(dB)	Q.P.	AV.	Q.P.	AV.	Q.P.	AV.	Q.P.	AV.
1	0.260	9.71	36.44	26.47	46.15	36.18	61.44	51.44	-15.28	-15.25
2	1.672	9.88	32.14	23.26	42.02	33.14	56.00	46.00	-13.98	-12.86
3	2.621	9.88	30.70	25.51	40.58	35.39	56.00	46.00	-15.42	-10.61
4	3.313	9.87	32.32	23.66	42.19	33.53	56.00	46.00	-13.81	-12.47
5	3.742	9.86	32.54	22.70	42.40	32.56	56.00	46.00	-13.60	-13.44
6	3.867	9.86	30.81	22.68	40.67	32.54	56.00	46.00	-15.33	-13.46

- REMARKS:**
1. Q.P. and AV. are abbreviations of quasi-peak and average individually.
 2. "-": The Quasi-peak reading value also meets average limit and measurement with the average detector is unnecessary.
 3. The emission levels of other frequencies were very low against the limit.
 4. Margin value = Emission level - Limit value
 5. Correction factor = Insertion loss + Cable loss
 6. Emission Level = Correction Factor + Reading Value.

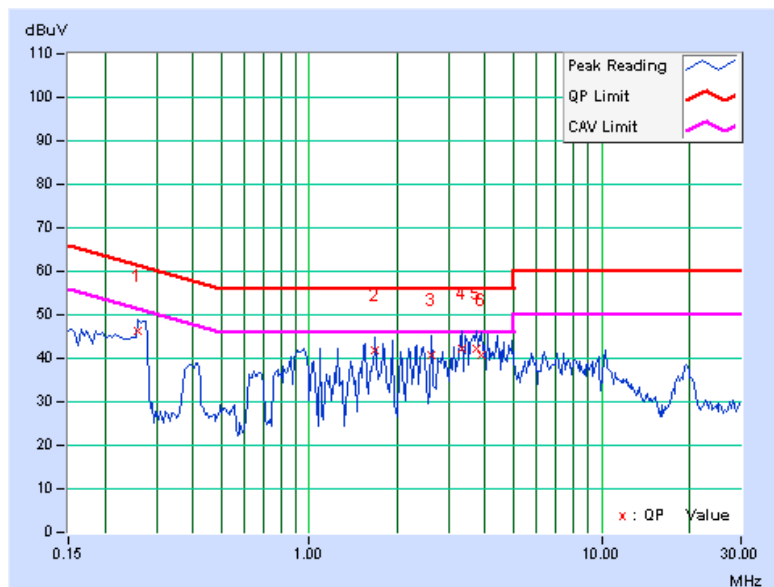

PHASE	Neutral (N)	6dB BANDWIDTH	9 kHz
--------------	-------------	----------------------	-------

No	Freq.	Corr.	Reading Value		Emission Level		Limit		Margin	
	[MHz]	Factor	[dB (uV)]		[dB (uV)]		[dB (uV)]		(dB)	
		(dB)	Q.P.	AV.	Q.P.	AV.	Q.P.	AV.	Q.P.	AV.
1	0.259	9.71	35.23	21.75	44.94	31.46	61.45	51.45	-16.51	-19.99
2	1.773	9.89	33.82	27.18	43.71	37.07	56.00	46.00	-12.29	-8.93
3	1.922	9.89	33.97	26.45	43.86	36.34	56.00	46.00	-12.14	-9.66
4	2.313	9.89	32.15	26.24	42.04	36.13	56.00	46.00	-13.96	-9.87
5	2.478	9.89	32.87	26.31	42.76	36.20	56.00	46.00	-13.24	-9.80
6	3.414	9.88	32.67	18.22	42.55	28.10	56.00	46.00	-13.45	-17.90
7	3.742	9.87	30.09	22.32	39.96	32.19	56.00	46.00	-16.04	-13.81

- REMARKS:**
1. Q.P. and AV. are abbreviations of quasi-peak and average individually.
 2. "-": The Quasi-peak reading value also meets average limit and measurement with the average detector is unnecessary.
 3. The emission levels of other frequencies were very low against the limit.
 4. Margin value = Emission level - Limit value
 5. Correction factor = Insertion loss + Cable loss
 6. Emission Level = Correction Factor + Reading Value.

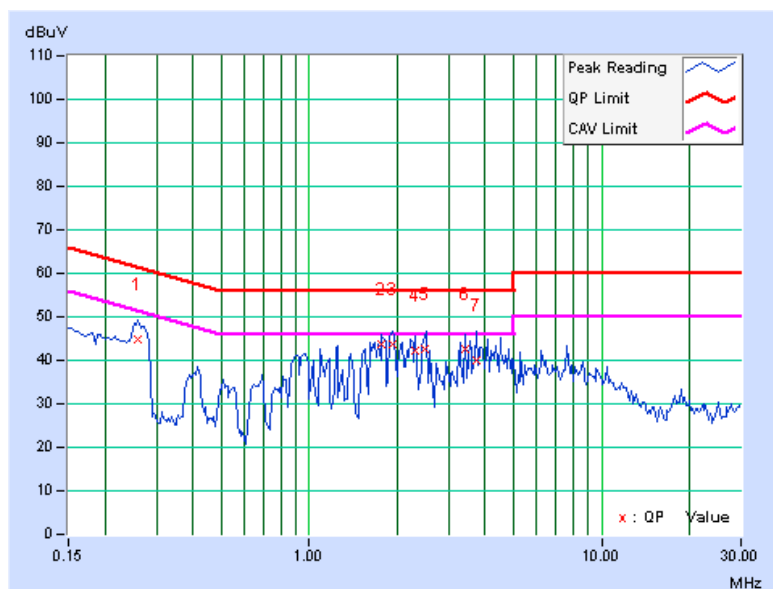

4.2 RADIATED EMISSION MEASUREMENT

4.2.1 LIMITS OF RADIATED EMISSION MEASUREMENT

Emissions radiated outside of the specified bands, shall be according to the general radiated limits in 15.209 as following:

Frequencies (MHz)	Field strength (microvolts/meter)	Measurement distance (meters)
0.009-0.490	2400/F(kHz)	300
0.490-1.705	24000/F(kHz)	30
1.705-30.0	30	30
30-88	100	3
88-216	150	3
216-960	200	3
Above 960	500	3

NOTE:

1. The lower limit shall apply at the transition frequencies.
2. Emission level (dBuV/m) = 20 log Emission level (uV/m).
3. As shown in 15.35(b), for frequencies above 1000MHz, the field strength limits are based on average detector, however, the peak field strength of any emission shall not exceed the maximum permitted average limits, specified above by more than 20dB under any condition of modulation.



A D T

4.2.2 TEST INSTRUMENTS

DESCRIPTION & MANUFACTURER	MODEL NO.	SERIAL NO.	CALIBRATED DATE	CALIBRATED UNTIL
ROHDE & SCHWARZ Spectrum Analyzer	FSP40	100036	Apr. 03 , 2009	Apr. 02 , 2010
Agilent PSA Spectrum Analyzer	E4446A	MY46180622	Apr. 24 , 2009	Apr. 23 , 2010
HP Pre_Amplifier	8449B	3008A01923	Nov. 02, 2009	Nov. 01, 2010
ROHDE & SCHWARZ Test Receiver	ESCS30	847124/029	Aug. 28, 2009	Aug. 28, 2010
SCHWARZBECK TRILOG Broadband Antenna	VULB 9168	138	April 29, 2009	April 28, 2010
Schwarzbeck Horn_Antenna	BBHA9120	D124	Dec. 18, 2009	Dec. 17, 2010
Schwarzbeck Horn_Antenna	BBHA 9170	BBHA9170153	Jan. 22, 2009	Jan. 21, 2010
RF Switches	EMH-011	08009	Sep. 26, 2009	Sep. 25, 2010
RF CABLE (Chaintek)	Sucoflex 106	28077	Aug. 14, 2009	Aug. 13, 2010
RF Cable	8D	STCCAB-001	Sep. 26, 2009	Sep. 25, 2010
Software	ADT_Radiated_V7.6.15.9.2	NA	NA	NA
CT Antenna Tower & Turn Table	NA	NA	NA	NA

Note: 1. The calibration interval of the above test instruments is 12 months and the calibrations are traceable to NML/ROC and NIST/USA.

2. The horn antenna, HP preamplifier (model: 8449B) and Spectrum Analyzer (model: FSP40) are used only for the measurement of emission frequency above 1GHz if tested.
3. The test was performed in Open Site No. C.
4. The FCC Site Registration No. is 656396.
5. The VCCI Site Registration No. is R-1626.
6. The CANADA Site Registration No. is IC 7450G-3.

4.2.3 TEST PROCEDURES

- a. The EUT was placed on the top of a rotating table 0.8 meters above the ground at a 10 meter open area test site. The table was rotated 360 degrees to determine the position of the highest radiation.
- b. The EUT was set 3 meters away from the interference-receiving antenna, which was mounted on the top of a variable-height antenna tower.
- c. The antenna is a broadband antenna, and its height is varied from one meter to four meters above the ground to determine the maximum value of the field strength. Both horizontal and vertical polarizations of the antenna are set to make the measurement.
- d. For each suspected emission, the EUT was arranged to its worst case and then the antenna was tuned to heights from 1 meter to 4 meters and the rotatable table was turned from 0 degrees to 360 degrees to find the maximum reading.
- e. The test-receiver system was set to Peak Detect Function and Specified Bandwidth with Maximum Hold Mode.
- f. If the emission level of the EUT in peak mode was 10dB lower than the limit specified, then testing could be stopped and the peak values of the EUT would be reported. Otherwise the emissions that did not have 10dB margin would be re-tested one by one using peak, quasi-peak or average method as specified and then reported in a data sheet.

NOTE:

1. The resolution bandwidth and video bandwidth of test receiver/spectrum analyzer is 120kHz for Peak detection (PK) and Quasi-peak detection (QP) at frequency below 1GHz.
2. The resolution bandwidth of test receiver/spectrum analyzer is 1 MHz and the video bandwidth is 3 MHz for Peak detection (PK) at frequency above 1GHz.
3. The resolution bandwidth of test receiver/spectrum analyzer is 1 MHz and the video bandwidth is 10 Hz for Average detection (AV) at frequency above 1GHz.

4.2.4 DEVIATION FROM TEST STANDARD

No deviation

4.2.5 TEST SETUP

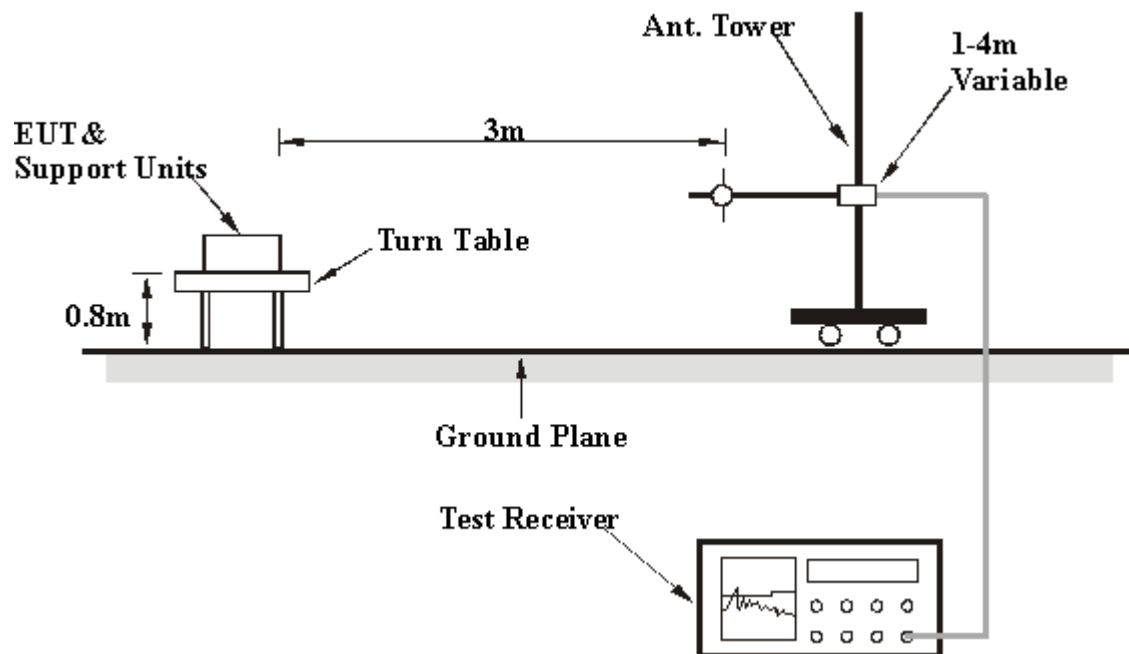

For the actual test configuration, please refer to the related item – Photographs of the Test Configuration.

4.2.6 EUT OPERATING CONDITIONS

Same as the 4.1.6



A D T

4.2.7 TEST RESULTS

BELOW 1GHz WORST-CASE DATA : 802.11n (40MHz) OFDM MODULATION

EUT TEST CONDITION		MEASUREMENT DETAIL	
CHANNEL	Channel 4	FREQUENCY RANGE	Below 1000MHz
INPUT POWER (SYSTEM)	120Vac, 60 Hz	DETECTOR FUNCTION	Quasi-Peak
ENVIRONMENTAL CONDITIONS	14deg. C, 70%RH 1024 hPa	TESTED BY	Kent Liu

ANTENNA POLARITY & TEST DISTANCE: HORIZONTAL AT 3 M								
NO.	FREQ. (MHz)	EMISSION LEVEL (dBuV/m)	LIMIT (dBuV/m)	MARGIN (dB)	ANTENNA HEIGHT (m)	TABLE ANGLE (Degree)	RAW VALUE (dBuV)	CORRECTION FACTOR (dB/m)
1	114.42	19.1 QP	43.5	-24.4	1.00 H	0	7.72	11.38
2	240.00	33.5 QP	46.0	-12.5	1.20 H	86	20.16	13.33
3	360.00	33.5 QP	46.0	-12.5	1.20 H	86	15.97	17.52
4	480.00	42.6 QP	46.0	-3.4	1.75 H	189	21.86	20.74
5	839.99	42.2 QP	46.0	-3.8	1.00 H	207	15.01	27.21
6	960.00	34.5 QP	46.0	-11.5	1.00 H	247	5.84	28.68

ANTENNA POLARITY & TEST DISTANCE: VERTICAL AT 3 M								
NO.	FREQ. (MHz)	EMISSION LEVEL (dBuV/m)	LIMIT (dBuV/m)	MARGIN (dB)	ANTENNA HEIGHT (m)	TABLE ANGLE (Degree)	RAW VALUE (dBuV)	CORRECTION FACTOR (dB/m)
1	240.00	37.2 QP	46.0	-8.8	1.08 V	212	23.84	13.33
2	360.00	42.8 QP	46.0	-3.2	1.00 V	0	25.29	17.52
3	480.00	42.6 QP	46.0	-3.4	1.11 V	36	21.90	20.74
4	600.00	42.5 QP	46.0	-3.5	1.00 V	325	18.64	23.87
5	840.00	42.8 QP	46.0	-3.2	1.00 V	233	15.58	27.21
6	960.00	40.1 QP	46.0	-5.9	1.01 V	0	11.42	28.68

- REMARKS:**
1. Emission level (dBuV/m) = Raw Value (dBuV) + Correction Factor (dB/m).
 2. Correction Factor (dB/m) = Antenna Factor (dB/m) + Cable Factor (dB).
 3. The other emission levels were very low against the limit.
 4. Margin value = Emission level – Limit value.



A D T

ABOVE 1GHz WORST-CASE DATA

802.11b DSSS MODULATION

EUT TEST CONDITION		MEASUREMENT DETAIL	
CHANNEL	Channel 1	FREQUENCY RANGE	1 ~ 25GHz
INPUT POWER (SYSTEM)	120Vac, 60 Hz	DETECTOR FUNCTION	Peak (PK) Average (AV)
ENVIRONMENTAL CONDITIONS	15deg. C, 69%RH 1024 hPa	TESTED BY	Frank Liu

ANTENNA POLARITY & TEST DISTANCE: HORIZONTAL AT 3 M								
NO.	FREQ. (MHz)	EMISSION LEVEL (dBuV/m)	LIMIT (dBuV/m)	MARGIN (dB)	ANTENNA HEIGHT (m)	TABLE ANGLE (Degree)	RAW VALUE (dBuV)	CORRECTION FACTOR (dB/m)
1	2390.00	61.1 PK	74.0	-13.0	1.28 H	344	30.77	30.28
2	2390.00	44.5 AV	54.0	-9.5	1.28 H	344	14.21	30.28
3	*2412.00	98.4 PK			1.23 H	340	68.03	30.36
4	*2412.00	95.9 AV			1.23 H	340	65.52	30.36
5	4824.00	46.5 PK	74.0	-27.5	1.27 H	136	9.68	36.79
6	4824.00	40.1 AV	54.0	-13.9	1.27 H	136	3.31	36.79
ANTENNA POLARITY & TEST DISTANCE: VERTICAL AT 3 M								
NO.	FREQ. (MHz)	EMISSION LEVEL (dBuV/m)	LIMIT (dBuV/m)	MARGIN (dB)	ANTENNA HEIGHT (m)	TABLE ANGLE (Degree)	RAW VALUE (dBuV)	CORRECTION FACTOR (dB/m)
1	2386.27	65.1 PK	74.0	-8.9	1.64 V	84	34.84	30.27
2	2386.27	48.3 AV	54.0	-5.7	1.64 V	84	18.02	30.27
3	*2412.00	102.7 PK			1.61 V	84	72.34	30.36
4	*2412.00	100.4 AV			1.61 V	84	69.99	30.36
5	4824.00	45.3 PK	74.0	-28.7	1.61 V	350	8.54	36.79
6	4824.00	37.1 AV	54.0	-16.9	1.61 V	350	0.32	36.79

- REMARKS:**
1. Emission level (dBuV/m) = Raw Value (dBuV) + Correction Factor (dB/m).
 2. Correction Factor (dB/m) = Antenna Factor (dB/m) + Cable Factor (dB).
 3. The other emission levels were very low against the limit.
 4. Margin value = Emission level – Limit value.
 5. “ * ”: Fundamental frequency.



A D T

EUT TEST CONDITION		MEASUREMENT DETAIL	
CHANNEL	Channel 6	FREQUENCY RANGE	1 ~ 25GHz
INPUT POWER (SYSTEM)	120Vac, 60 Hz	DETECTOR FUNCTION	Peak (PK) Average (AV)
ENVIRONMENTAL CONDITIONS	15deg. C, 69%RH 1024 hPa	TESTED BY	Frank Liu

ANTENNA POLARITY & TEST DISTANCE: HORIZONTAL AT 3 M								
NO.	FREQ. (MHz)	EMISSION LEVEL (dBuV/m)	LIMIT (dBuV/m)	MARGIN (dB)	ANTENNA HEIGHT (m)	TABLE ANGLE (Degree)	RAW VALUE (dBuV)	CORRECTION FACTOR (dB/m)
1	*2437.00	99.8 PK			1.10 H	345	69.35	30.46
2	*2437.00	97.4 AV			1.10 H	345	66.94	30.46
3	4874.00	47.3 PK	74.0	-26.8	1.12 H	134	10.33	36.92
4	4874.00	41.6 AV	54.0	-12.4	1.12 H	134	4.65	36.92
5	7311.00	52.8 PK	74.0	-21.2	1.08 H	255	9.66	43.14
6	7311.00	43.5 AV	54.0	-10.5	1.08 H	255	0.40	43.14
ANTENNA POLARITY & TEST DISTANCE: VERTICAL AT 3 M								
NO.	FREQ. (MHz)	EMISSION LEVEL (dBuV/m)	LIMIT (dBuV/m)	MARGIN (dB)	ANTENNA HEIGHT (m)	TABLE ANGLE (Degree)	RAW VALUE (dBuV)	CORRECTION FACTOR (dB/m)
1	*2437.00	104.7 PK			1.55 V	90	74.28	30.46
2	*2437.00	101.2 AV			1.55 V	90	70.77	30.46
3	4874.00	48.5 PK	74.0	-25.5	1.09 V	160	11.60	36.92
4	4874.00	45.7 AV	54.0	-8.3	1.09 V	160	8.79	36.92
5	7311.00	50.8 PK	74.0	-23.2	1.24 V	93	7.66	43.14
6	7311.00	40.2 AV	54.0	-13.8	1.24 V	93	-2.95	43.14

- REMARKS:**
1. Emission level (dBuV/m) = Raw Value (dBuV) + Correction Factor (dB/m).
 2. Correction Factor (dB/m) = Antenna Factor (dB/m) + Cable Factor (dB).
 3. The other emission levels were very low against the limit.
 4. Margin value = Emission level – Limit value.
 5. “ * “: Fundamental frequency.



A D T

EUT TEST CONDITION		MEASUREMENT DETAIL	
CHANNEL	Channel 11	FREQUENCY RANGE	1 ~ 25GHz
INPUT POWER (SYSTEM)	120Vac, 60 Hz	DETECTOR FUNCTION	Peak (PK) Average (AV)
ENVIRONMENTAL CONDITIONS	15deg. C, 69%RH 1024 hPa	TESTED BY	Frank Liu

ANTENNA POLARITY & TEST DISTANCE: HORIZONTAL AT 3 M								
NO.	FREQ. (MHz)	EMISSION LEVEL (dBuV/m)	LIMIT (dBuV/m)	MARGIN (dB)	ANTENNA HEIGHT (m)	TABLE ANGLE (Degree)	RAW VALUE (dBuV)	CORRECTION FACTOR (dB/m)
1	*2462.00	98.2 PK			1.42 H	69	67.65	30.55
2	*2462.00	95.4 AV			1.42 H	69	64.85	30.55
3	2483.50	60.0 PK	74.0	-14.0	1.45 H	73	29.40	30.63
4	2483.50	43.3 AV	54.0	-10.7	1.45 H	73	12.65	30.63
5	4924.00	46.7 PK	74.0	-27.3	1.24 H	127	9.64	37.06
6	4924.00	40.3 AV	54.0	-13.7	1.24 H	127	3.24	37.06
7	7386.00	51.6 PK	74.0	-22.4	1.04 H	247	8.47	43.13
8	7386.00	42.3 AV	54.0	-11.7	1.04 H	247	-0.83	43.13
ANTENNA POLARITY & TEST DISTANCE: VERTICAL AT 3 M								
NO.	FREQ. (MHz)	EMISSION LEVEL (dBuV/m)	LIMIT (dBuV/m)	MARGIN (dB)	ANTENNA HEIGHT (m)	TABLE ANGLE (Degree)	RAW VALUE (dBuV)	CORRECTION FACTOR (dB/m)
1	*2462.00	102.8 PK			1.57 V	63	72.21	30.55
2	*2462.00	100.3 AV			1.57 V	63	69.74	30.55
3	2487.76	68.4 PK	74.0	-5.6	1.54 V	92	37.74	30.64
4	2487.76	51.0 AV	54.0	-3.0	1.54 V	92	20.32	30.64
5	4924.00	46.4 PK	74.0	-27.6	1.04 V	57	9.34	37.06
6	4924.00	40.2 AV	54.0	-13.8	1.04 V	57	3.14	37.06
7	7386.00	50.9 PK	74.0	-23.1	1.27 V	64	7.79	43.13
8	7386.00	40.3 AV	54.0	-13.7	1.27 V	64	-2.80	43.13

- REMARKS:**
1. Emission level (dBuV/m) = Raw Value (dBuV) + Correction Factor (dB/m).
 2. Correction Factor (dB/m) = Antenna Factor (dB/m) + Cable Factor (dB).
 3. The other emission levels were very low against the limit.
 4. Margin value = Emission level – Limit value.
 5. “ * “: Fundamental frequency.



A D T

RESTRICTED BANDEDGE (802.11b MODE,CH1, HORIZONTAL)

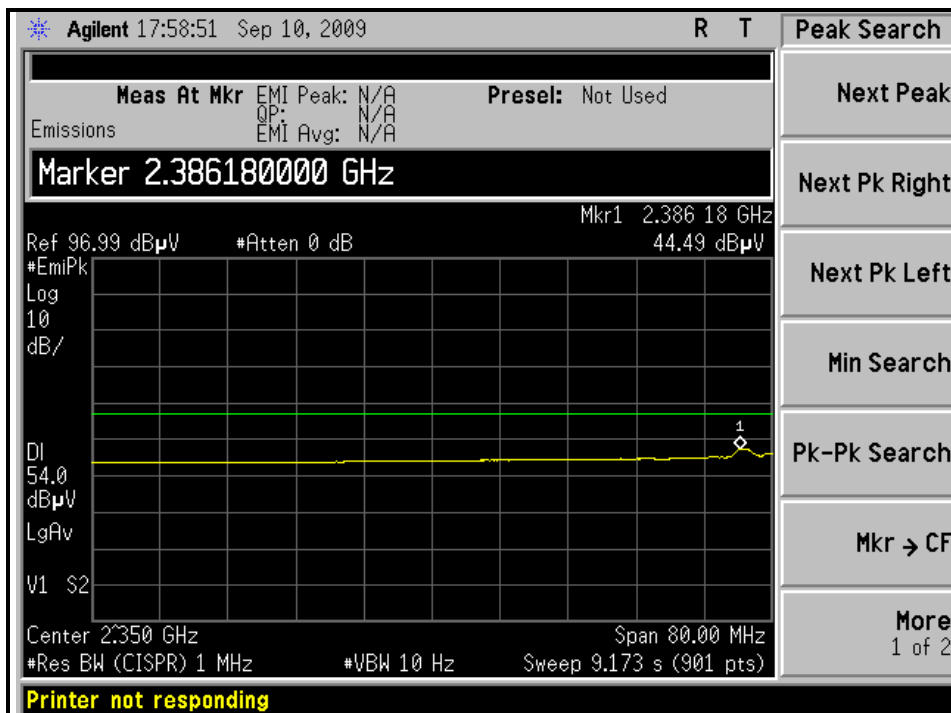
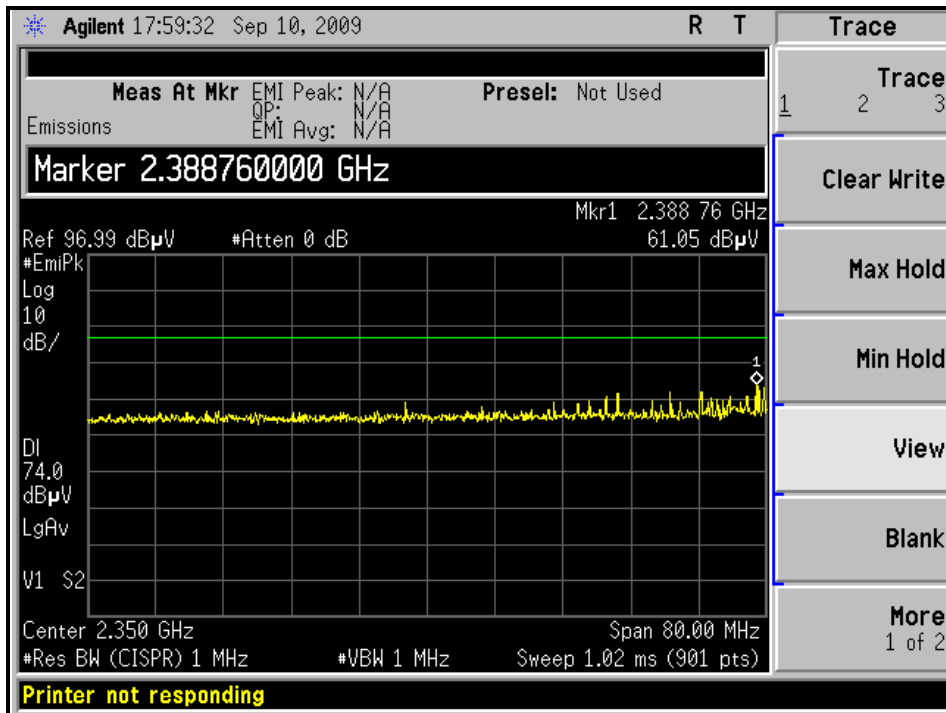



A D T

RESTRICTED BANDEDGE (802.11b MODE, CH1, VERTICAL)

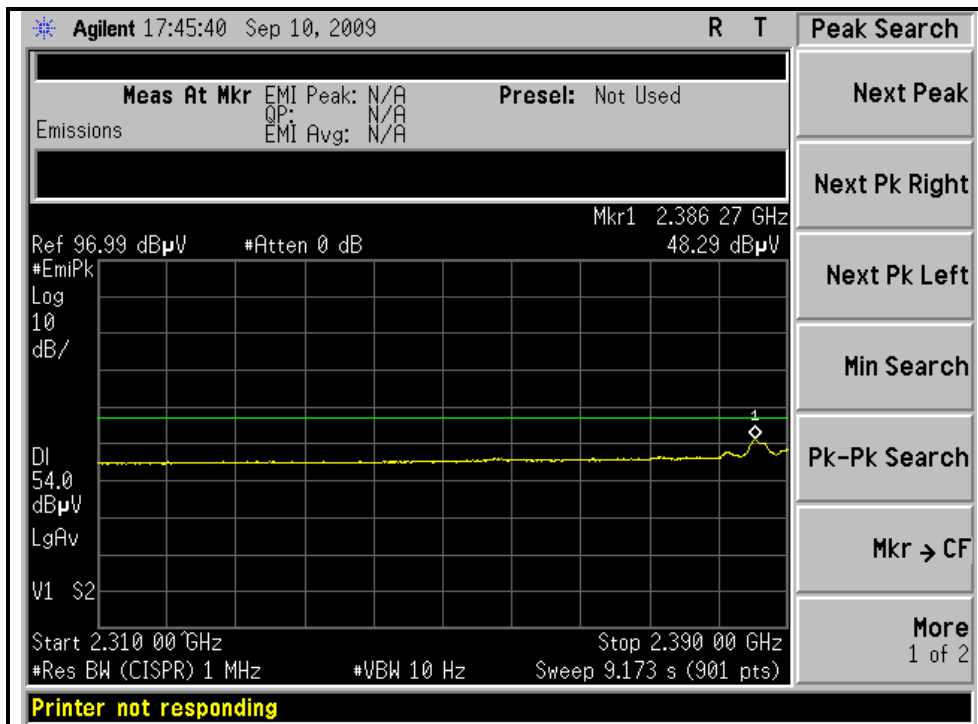
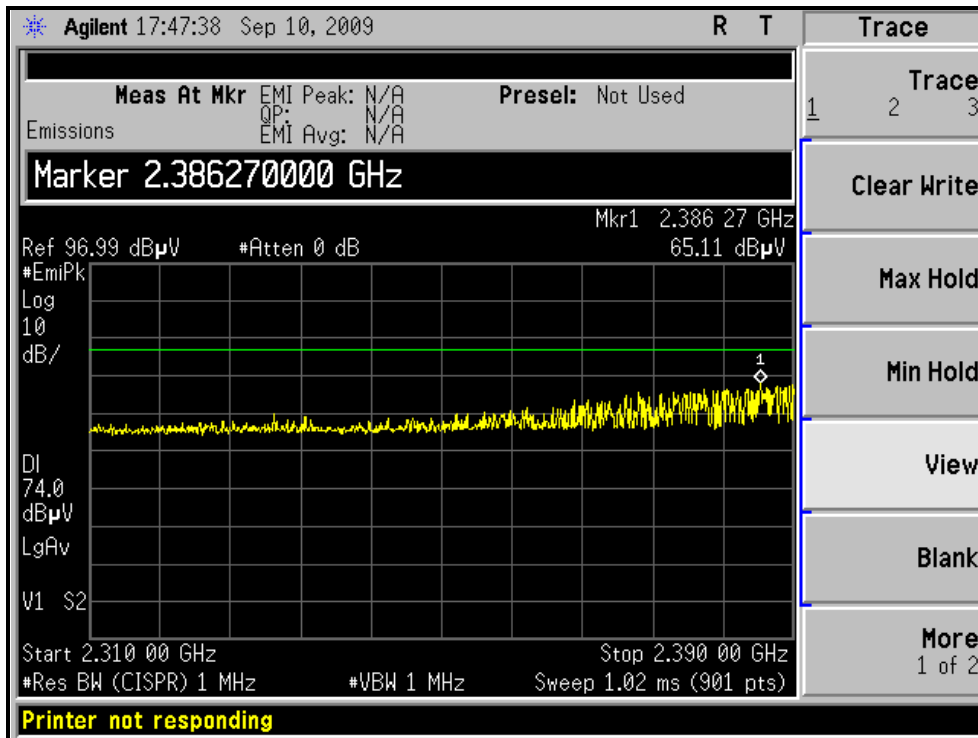



A D T

RESTRICTED BANDEDGE (802.11b MODE, CH11, HORIZONTAL)

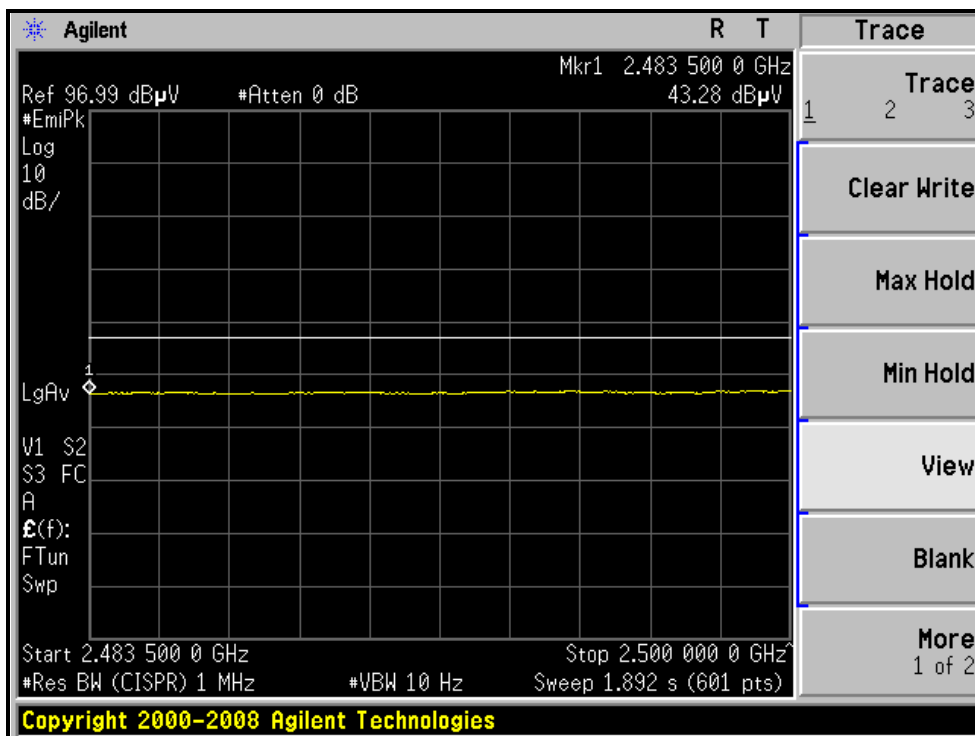
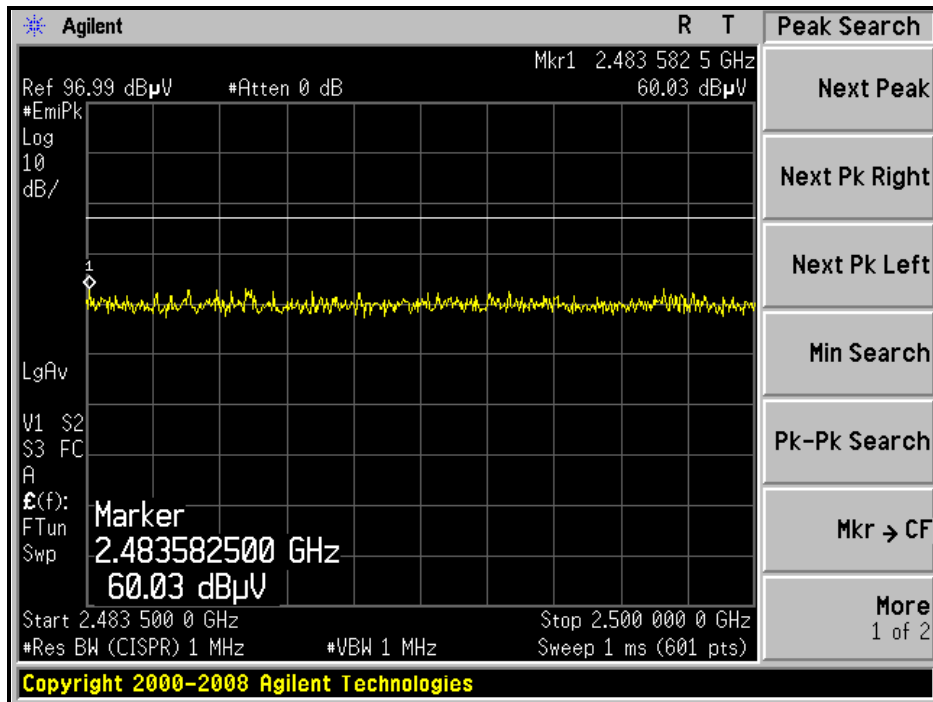



A D T

RESTRICTED BANDEDGE (802.11b MODE, CH11, VERTICAL)

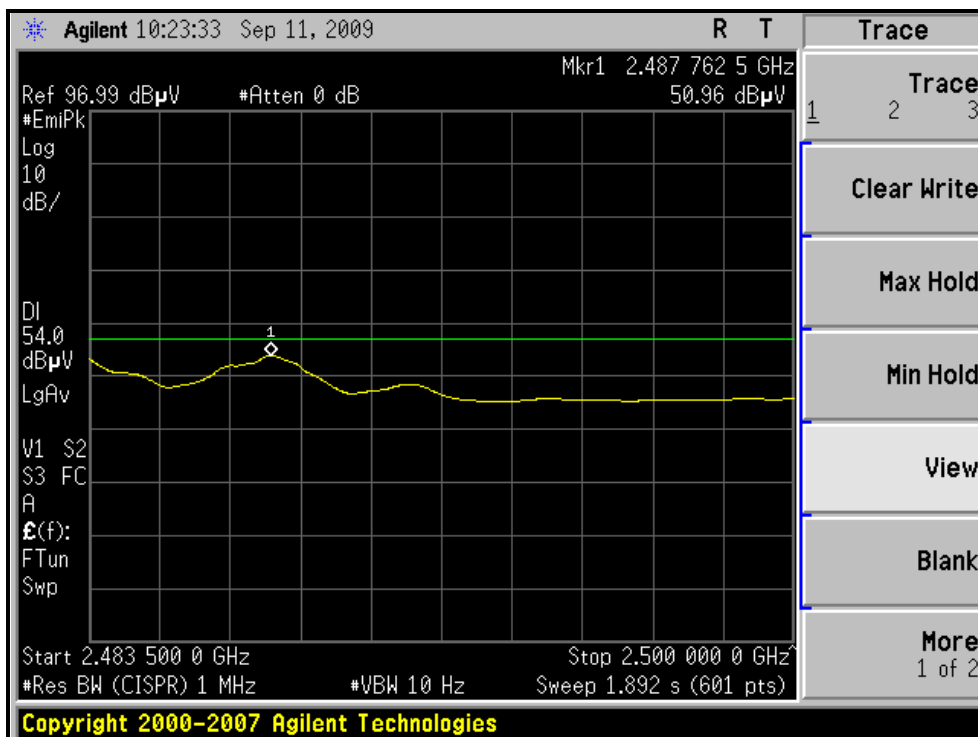
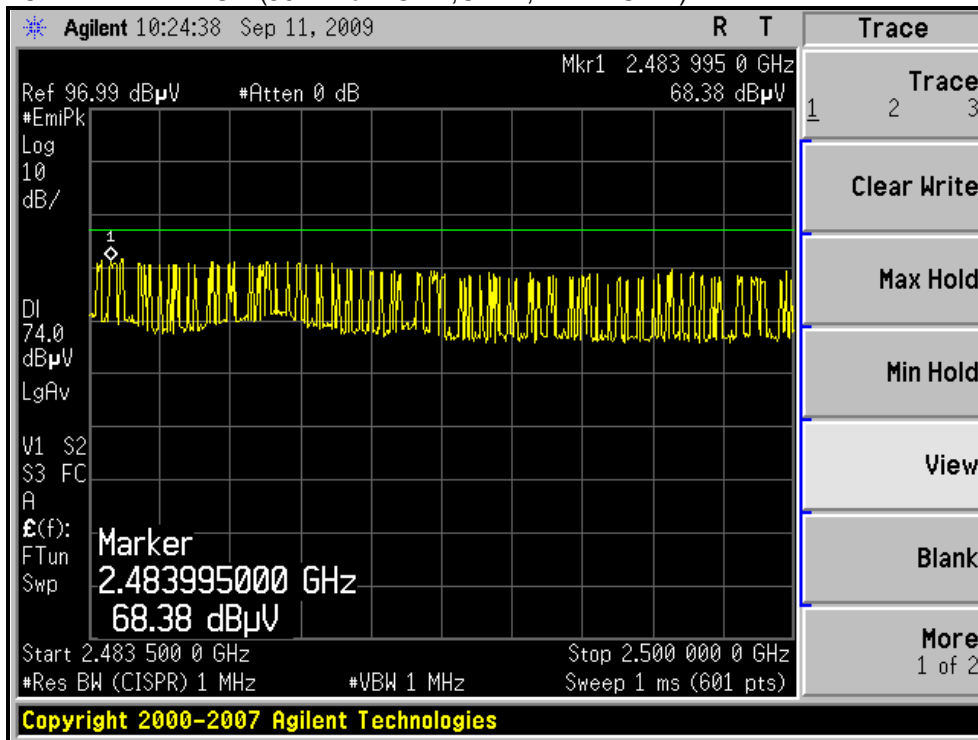



A D T

802.11g OFDM MODULATION

EUT TEST CONDITION		MEASUREMENT DETAIL	
CHANNEL	Channel 1	FREQUENCY RANGE	1 ~ 25GHz
INPUT POWER (SYSTEM)	120Vac, 60 Hz	DETECTOR FUNCTION	Peak (PK) Average (AV)
ENVIRONMENTAL CONDITIONS	15deg. C, 69%RH 1024 hPa	TESTED BY	Frank Liu

ANTENNA POLARITY & TEST DISTANCE: HORIZONTAL AT 3 M								
NO.	FREQ. (MHz)	EMISSION LEVEL (dBuV/m)	LIMIT (dBuV/m)	MARGIN (dB)	ANTENNA HEIGHT (m)	TABLE ANGLE (Degree)	RAW VALUE (dBuV)	CORRECTION FACTOR (dB/m)
1	2390.00	59.3 PK	74.0	-14.7	1.54 H	113	29.04	30.28
2	2390.00	44.2 AV	54.0	-9.8	1.54 H	113	13.90	30.28
3	*2412.00	97.2 PK			1.59 H	126	66.84	30.36
4	*2412.00	90.1 AV			1.59 H	126	59.74	30.36
5	4824.00	45.3 PK	74.0	-28.7	1.24 H	337	8.47	36.79
6	4824.00	34.5 AV	54.0	-19.5	1.24 H	337	-2.28	36.79
ANTENNA POLARITY & TEST DISTANCE: VERTICAL AT 3 M								
NO.	FREQ. (MHz)	EMISSION LEVEL (dBuV/m)	LIMIT (dBuV/m)	MARGIN (dB)	ANTENNA HEIGHT (m)	TABLE ANGLE (Degree)	RAW VALUE (dBuV)	CORRECTION FACTOR (dB/m)
1	2390.00	72.8 PK	74.0	-1.2	1.63 V	82	42.55	30.28
2	2390.00	52.8 AV	54.0	-1.3	1.63 V	82	22.47	30.28
3	*2412.00	105.0 PK			1.59 V	91	74.60	30.36
4	*2412.00	95.9 AV			1.59 V	91	65.53	30.36
5	4824.00	51.4 PK	74.0	-22.6	1.07 V	324	14.60	36.79
6	4824.00	36.5 AV	54.0	-17.5	1.07 V	324	-0.29	36.79

- REMARKS:**
1. Emission level (dBuV/m) = Raw Value (dBuV) + Correction Factor (dB/m).
 2. Correction Factor (dB/m) = Antenna Factor (dB/m) + Cable Factor (dB).
 3. The other emission levels were very low against the limit.
 4. Margin value = Emission level – Limit value.
 5. “ * “: Fundamental frequency.



A D T

EUT TEST CONDITION		MEASUREMENT DETAIL	
CHANNEL	Channel 6	FREQUENCY RANGE	1 ~ 25GHz
INPUT POWER (SYSTEM)	120Vac, 60 Hz	DETECTOR FUNCTION	Peak (PK) Average (AV)
ENVIRONMENTAL CONDITIONS	15deg. C, 69%RH 1024 hPa	TESTED BY	Frank Liu

ANTENNA POLARITY & TEST DISTANCE: HORIZONTAL AT 3 M								
NO.	FREQ. (MHz)	EMISSION LEVEL (dBuV/m)	LIMIT (dBuV/m)	MARGIN (dB)	ANTENNA HEIGHT (m)	TABLE ANGLE (Degree)	RAW VALUE (dBuV)	CORRECTION FACTOR (dB/m)
1	*2437.00	103.3 PK			1.27 H	155	72.84	30.46
2	*2437.00	93.9 AV			1.27 H	155	63.40	30.46
3	4874.00	45.1 PK	74.0	-28.9	1.21 H	334	8.18	36.92
4	4874.00	34.1 AV	54.0	-19.9	1.21 H	334	-2.80	36.92
5	7311.00	51.5 PK	74.0	-22.5	1.08 H	231	8.32	43.14
6	7311.00	40.6 AV	54.0	-13.4	1.08 H	231	-2.51	43.14
ANTENNA POLARITY & TEST DISTANCE: VERTICAL AT 3 M								
NO.	FREQ. (MHz)	EMISSION LEVEL (dBuV/m)	LIMIT (dBuV/m)	MARGIN (dB)	ANTENNA HEIGHT (m)	TABLE ANGLE (Degree)	RAW VALUE (dBuV)	CORRECTION FACTOR (dB/m)
1	*2437.00	107.0 PK			1.56 V	89	76.56	30.46
2	*2437.00	98.2 AV			1.56 V	89	67.73	30.46
3	4874.00	48.5 PK	74.0	-25.5	1.06 V	331	11.61	36.92
4	4874.00	36.3 AV	54.0	-17.7	1.06 V	331	-0.62	36.92
5	7311.00	51.2 PK	74.0	-22.8	1.18 V	237	8.07	43.14
6	7311.00	38.6 AV	54.0	-15.4	1.18 V	237	-4.54	43.14

- REMARKS:**
1. Emission level (dBuV/m) = Raw Value (dBuV) + Correction Factor (dB/m).
 2. Correction Factor (dB/m) = Antenna Factor (dB/m) + Cable Factor (dB).
 3. The other emission levels were very low against the limit.
 4. Margin value = Emission level – Limit value.
 5. “ * “: Fundamental frequency.



A D T

EUT TEST CONDITION		MEASUREMENT DETAIL	
CHANNEL	Channel 11	FREQUENCY RANGE	1 ~ 25GHz
INPUT POWER (SYSTEM)	120Vac, 60 Hz	DETECTOR FUNCTION	Peak (PK) Average (AV)
ENVIRONMENTAL CONDITIONS	15deg. C, 69%RH 1024 hPa	TESTED BY	Frank Liu

ANTENNA POLARITY & TEST DISTANCE: HORIZONTAL AT 3 M								
NO.	FREQ. (MHz)	EMISSION LEVEL (dBuV/m)	LIMIT (dBuV/m)	MARGIN (dB)	ANTENNA HEIGHT (m)	TABLE ANGLE (Degree)	RAW VALUE (dBuV)	CORRECTION FACTOR (dB/m)
1	*2462.00	97.9 PK			1.53 H	29	67.31	30.55
2	*2462.00	90.2 AV			1.53 H	29	59.67	30.55
3	2483.50	66.8 PK	74.0	-7.2	1.90 H	342	36.16	30.63
4	2483.50	48.3 AV	54.0	-5.7	1.90 H	342	17.68	30.63
5	4924.00	45.3 PK	74.0	-28.7	1.26 H	351	8.21	37.06
6	4924.00	34.3 AV	54.0	-19.7	1.26 H	351	-2.80	37.06
7	7386.00	51.6 PK	74.0	-22.4	1.04 H	239	8.47	43.13
8	7386.00	40.7 AV	54.0	-13.3	1.04 H	239	-2.43	43.13
ANTENNA POLARITY & TEST DISTANCE: VERTICAL AT 3 M								
NO.	FREQ. (MHz)	EMISSION LEVEL (dBuV/m)	LIMIT (dBuV/m)	MARGIN (dB)	ANTENNA HEIGHT (m)	TABLE ANGLE (Degree)	RAW VALUE (dBuV)	CORRECTION FACTOR (dB/m)
1	*2462.00	102.7 PK			1.56 V	93	72.11	30.55
2	*2462.00	93.1 AV			1.56 V	93	62.56	30.55
3	2483.50	71.5 PK	74.0	-2.6	1.59 V	81	40.82	30.63
4	2483.50	52.3 AV	54.0	-1.7	1.59 V	81	21.68	30.63
5	4924.00	48.9 PK	74.0	-25.1	1.04 V	327	11.84	37.06
6	4924.00	36.6 AV	54.0	-17.4	1.04 V	327	-0.46	37.06
7	7386.00	51.1 PK	74.0	-22.9	1.10 V	327	7.97	43.13
8	7386.00	38.5 AV	54.0	-15.5	1.10 V	327	-4.63	43.13

- REMARKS:**
1. Emission level (dBuV/m) = Raw Value (dBuV) + Correction Factor (dB/m).
 2. Correction Factor (dB/m) = Antenna Factor (dB/m) + Cable Factor (dB).
 3. The other emission levels were very low against the limit.
 4. Margin value = Emission level – Limit value.
 5. “ * “: Fundamental frequency.



A D T

RESTRICTED BANDEDGE (802.11g MODE,CH1, HORIZONTAL)

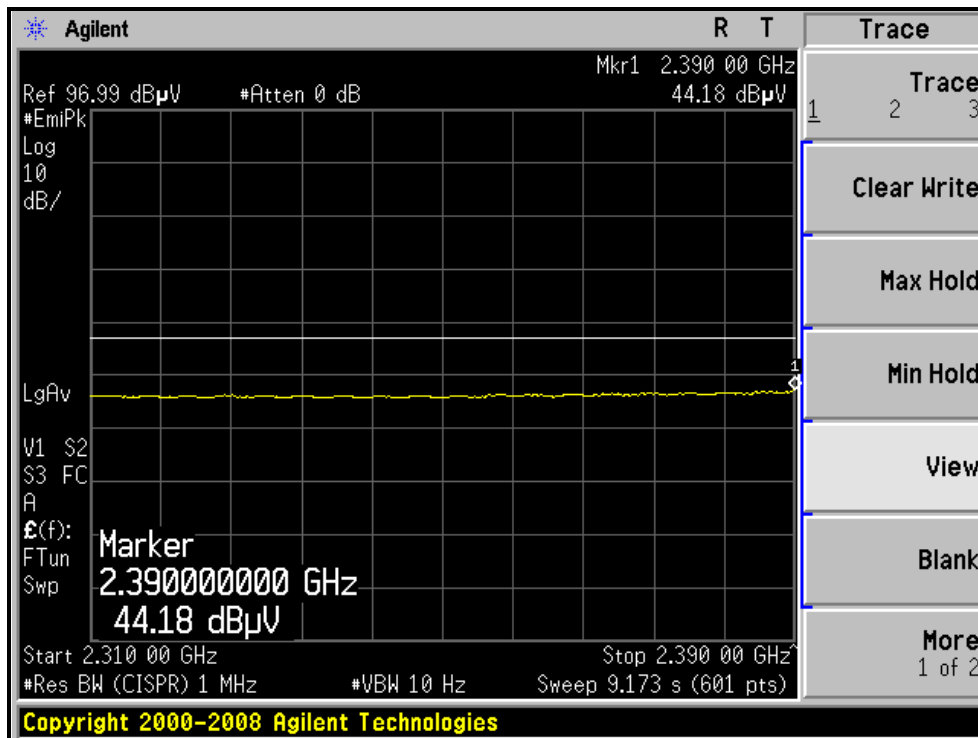
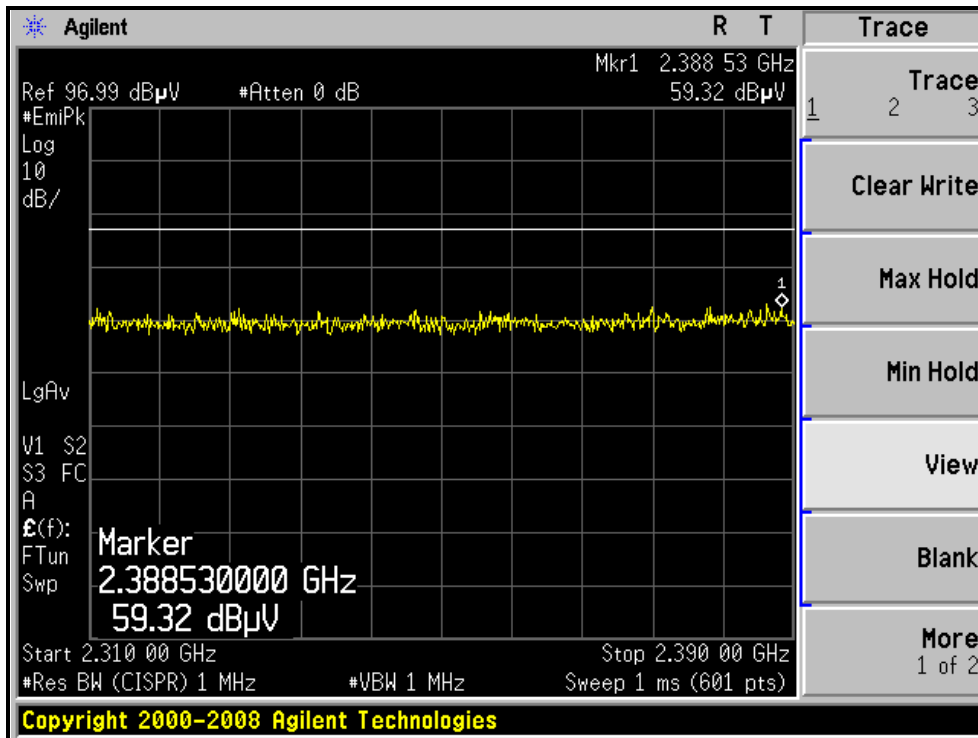



A D T

RESTRICTED BANDEDGE (802.11g MODE,CH1, VERTICAL)

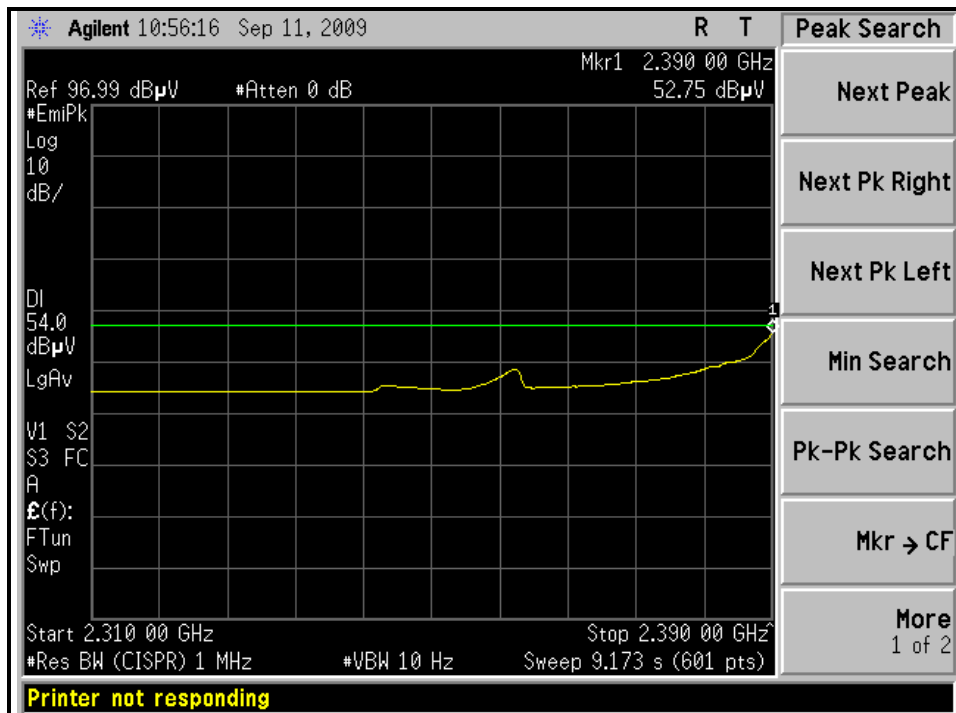
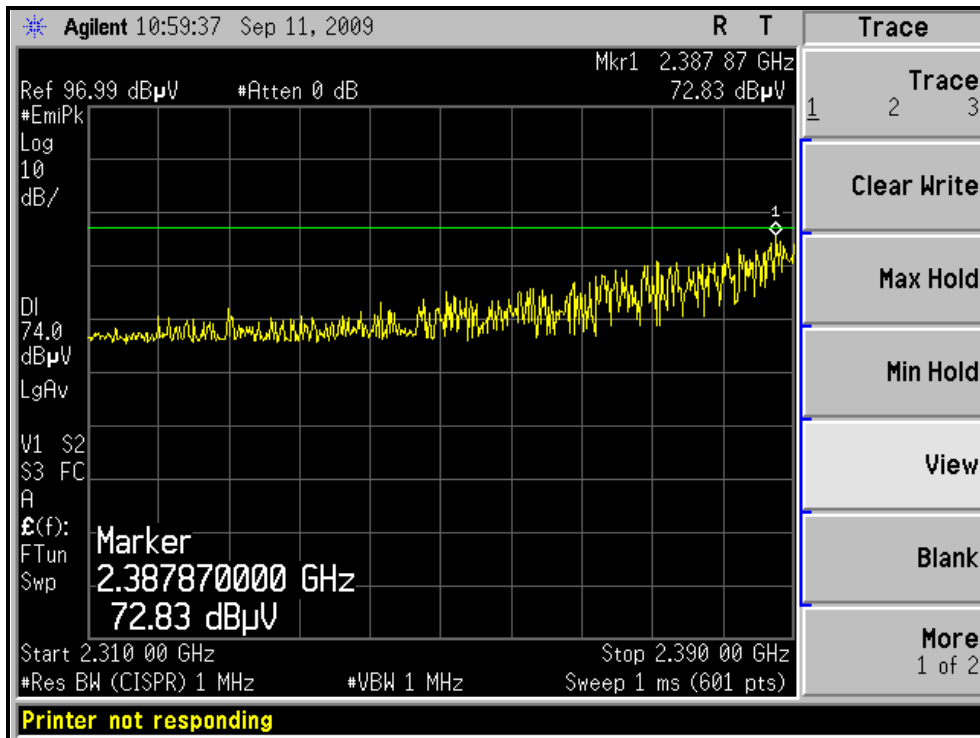



A D T

RESTRICTED BANDEDGE (802.11g MODE,CH11, HORIZONTAL)

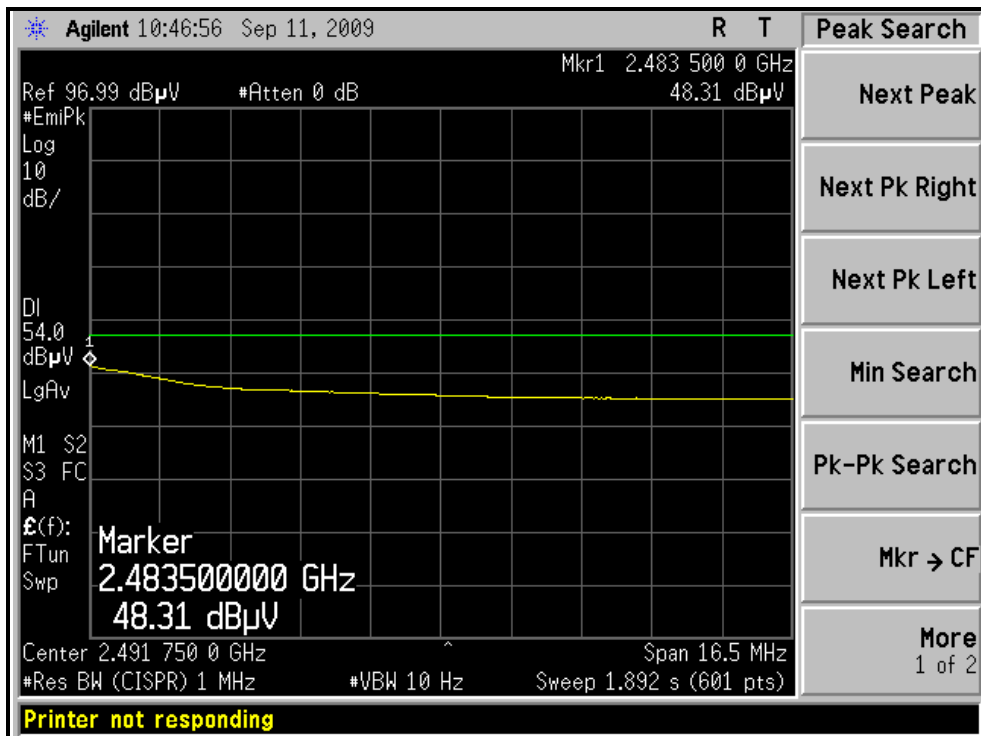
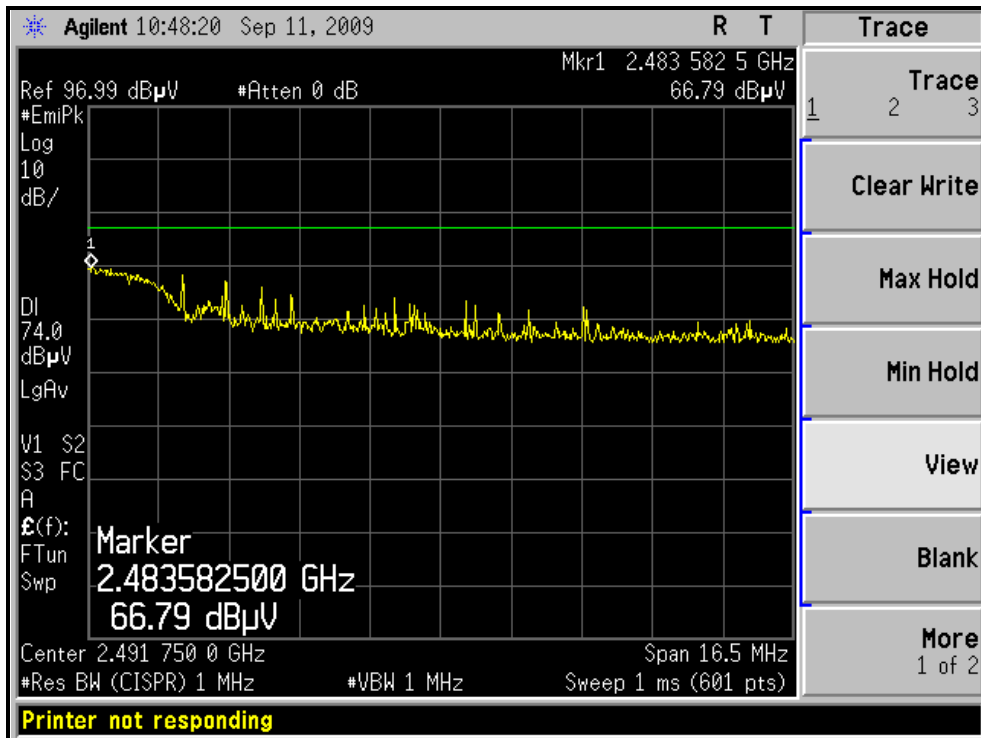



A D T

RESTRICTED BANDEDGE (802.11g MODE, CH11, VERTICAL)

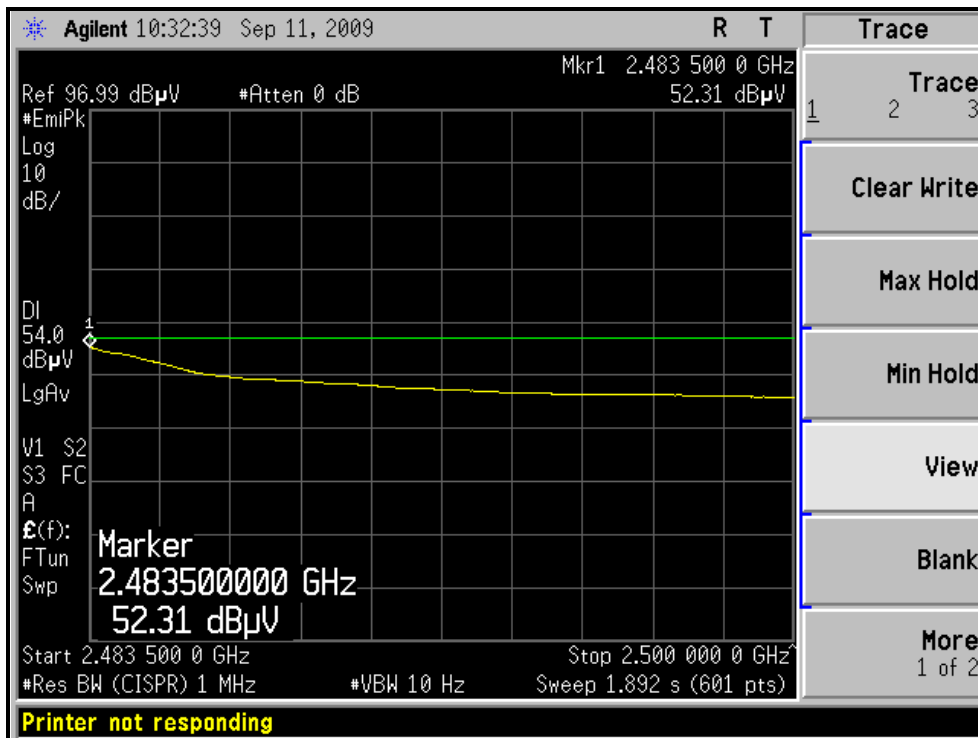
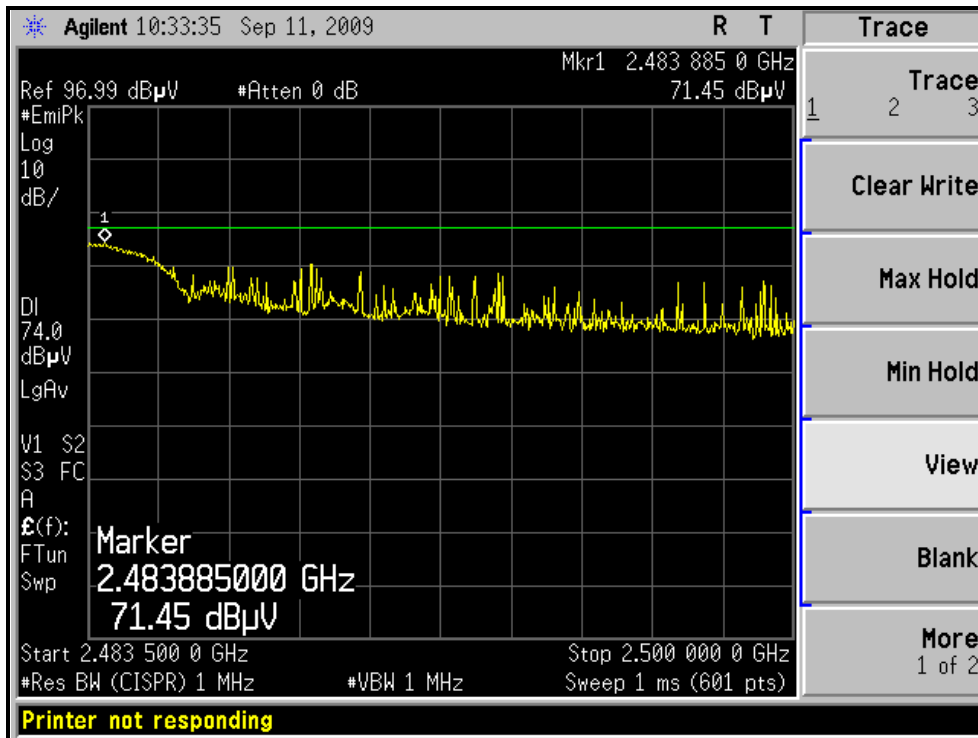



A D T

802.11n (20MHz) OFDM MODULATION

EUT TEST CONDITION		MEASUREMENT DETAIL	
CHANNEL	Channel 1	FREQUENCY RANGE	1 ~ 25GHz
INPUT POWER (SYSTEM)	120Vac, 60 Hz	DETECTOR FUNCTION	Peak (PK) Average (AV)
ENVIRONMENTAL CONDITIONS	20deg. C, 67%RH 1024 hPa	TESTED BY	Frank Liu

ANTENNA POLARITY & TEST DISTANCE: HORIZONTAL AT 3 M								
NO.	FREQ. (MHz)	EMISSION LEVEL (dBuV/m)	LIMIT (dBuV/m)	MARGIN (dB)	ANTENNA HEIGHT (m)	TABLE ANGLE (Degree)	RAW VALUE (dBuV)	CORRECTION FACTOR (dB/m)
1	2390.00	63.3 PK	74.0	-10.7	1.37 H	0	33.26	30.06
2	2390.00	53.0 AV	54.0	-1.0	1.37 H	0	22.97	30.06
3	*2412.00	105.7 PK			1.39 H	177	75.56	30.15
4	*2412.00	96.7 AV			1.39 H	177	66.57	30.15
5	4824.00	47.9 PK	74.0	-26.1	1.00 H	12	12.44	35.46
6	4824.00	34.6 AV	54.0	-19.4	1.00 H	12	-0.86	35.46
ANTENNA POLARITY & TEST DISTANCE: VERTICAL AT 3 M								
NO.	FREQ. (MHz)	EMISSION LEVEL (dBuV/m)	LIMIT (dBuV/m)	MARGIN (dB)	ANTENNA HEIGHT (m)	TABLE ANGLE (Degree)	RAW VALUE (dBuV)	CORRECTION FACTOR (dB/m)
1	2390.00	69.6 PK	74.0	-4.4	1.65 V	90	39.56	30.06
2	2390.00	52.3 AV	54.0	-1.7	1.65 V	90	22.21	30.06
3	*2412.00	103.9 PK			1.59 V	81	73.79	30.15
4	*2412.00	95.3 AV			1.59 V	81	65.19	30.15
5	4824.00	42.5 PK	74.0	-31.5	1.11 V	79	7.04	35.46
6	4824.00	33.6 AV	54.0	-20.4	1.11 V	79	-1.86	35.46

- REMARKS:**
1. Emission level (dBuV/m) = Raw Value (dBuV) + Correction Factor (dB/m).
 2. Correction Factor (dB/m) = Antenna Factor (dB/m) + Cable Factor (dB).
 3. The other emission levels were very low against the limit.
 4. Margin value = Emission level – Limit value.
 5. “ * “: Fundamental frequency.



A D T

EUT TEST CONDITION		MEASUREMENT DETAIL	
CHANNEL	Channel 6	FREQUENCY RANGE	1 ~ 25GHz
INPUT POWER (SYSTEM)	120Vac, 60 Hz	DETECTOR FUNCTION	Peak (PK) Average (AV)
ENVIRONMENTAL CONDITIONS	20deg. C, 67%RH 1024 hPa	TESTED BY	Frank Liu

ANTENNA POLARITY & TEST DISTANCE: HORIZONTAL AT 3 M								
NO.	FREQ. (MHz)	EMISSION LEVEL (dBuV/m)	LIMIT (dBuV/m)	MARGIN (dB)	ANTENNA HEIGHT (m)	TABLE ANGLE (Degree)	RAW VALUE (dBuV)	CORRECTION FACTOR (dB/m)
1	*2437.00	104.9 PK			1.40 H	10	74.69	30.24
2	*2437.00	96.3 AV			1.40 H	10	66.06	30.24
3	4874.00	47.7 PK	74.0	-26.3	1.00 H	0	12.17	35.55
4	4874.00	34.1 AV	54.0	-19.9	1.00 H	0	-1.45	35.55
5	7311.00	50.6 PK	74.0	-23.4	1.21 H	33	8.60	42.04
6	7311.00	38.2 AV	54.0	-15.8	1.21 H	33	-3.88	42.04
ANTENNA POLARITY & TEST DISTANCE: VERTICAL AT 3 M								
NO.	FREQ. (MHz)	EMISSION LEVEL (dBuV/m)	LIMIT (dBuV/m)	MARGIN (dB)	ANTENNA HEIGHT (m)	TABLE ANGLE (Degree)	RAW VALUE (dBuV)	CORRECTION FACTOR (dB/m)
1	*2437.00	102.8 PK			1.40 V	235	72.59	30.24
2	*2437.00	94.0 AV			1.40 V	235	63.77	30.24
3	4874.00	42.4 PK	74.0	-31.6	1.11 V	38	6.86	35.55
4	4874.00	33.4 AV	54.0	-20.6	1.11 V	38	-2.15	35.55
5	7311.00	50.8 PK	74.0	-23.2	1.00 V	29	8.80	42.04
6	7311.00	38.7 AV	54.0	-15.3	1.00 V	29	-3.34	42.04

- REMARKS:**
1. Emission level (dBuV/m) = Raw Value (dBuV) + Correction Factor (dB/m).
 2. Correction Factor (dB/m) = Antenna Factor (dB/m) + Cable Factor (dB).
 3. The other emission levels were very low against the limit.
 4. Margin value = Emission level – Limit value.
 5. “ * “: Fundamental frequency.



A D T

EUT TEST CONDITION		MEASUREMENT DETAIL	
CHANNEL	Channel 11	FREQUENCY RANGE	1 ~ 25GHz
INPUT POWER (SYSTEM)	120Vac, 60 Hz	DETECTOR FUNCTION	Peak (PK) Average (AV)
ENVIRONMENTAL CONDITIONS	20deg. C, 67%RH 1024 hPa	TESTED BY	Frank Liu

ANTENNA POLARITY & TEST DISTANCE: HORIZONTAL AT 3 M								
NO.	FREQ. (MHz)	EMISSION LEVEL (dBuV/m)	LIMIT (dBuV/m)	MARGIN (dB)	ANTENNA HEIGHT (m)	TABLE ANGLE (Degree)	RAW VALUE (dBuV)	CORRECTION FACTOR (dB/m)
1	*2462.00	102.2 PK			1.44 H	145	71.82	30.34
2	*2462.00	93.6 AV			1.44 H	145	63.26	30.34
3	2483.50	62.9 PK	74.0	-11.1	1.34 H	108	32.48	30.43
4	2483.50	48.6 AV	54.0	-5.4	1.34 H	108	18.14	30.43
5	4924.00	47.8 PK	74.0	-26.2	1.00 H	4	12.17	35.63
6	4924.00	34.6 AV	54.0	-19.4	1.00 H	4	-1.03	35.63
7	7386.00	50.8 PK	74.0	-23.2	1.24 H	39	8.57	42.23
8	7386.00	38.2 AV	54.0	-15.8	1.24 H	39	-4.03	42.23
ANTENNA POLARITY & TEST DISTANCE: VERTICAL AT 3 M								
NO.	FREQ. (MHz)	EMISSION LEVEL (dBuV/m)	LIMIT (dBuV/m)	MARGIN (dB)	ANTENNA HEIGHT (m)	TABLE ANGLE (Degree)	RAW VALUE (dBuV)	CORRECTION FACTOR (dB/m)
1	*2462.00	106.0 PK			1.60 V	92	75.65	30.34
2	*2462.00	96.8 AV			1.60 V	92	66.46	30.34
3	2483.50	71.0 PK	74.0	-3.1	1.58 V	91	40.52	30.43
4	2483.50	52.5 AV	54.0	-1.5	1.58 V	91	22.05	30.43
5	4924.00	42.7 PK	74.0	-31.3	1.14 V	72	7.07	35.63
6	4924.00	33.9 AV	54.0	-20.1	1.14 V	72	-1.73	35.63
7	7386.00	51.2 PK	74.0	-22.8	1.04 V	64	8.97	42.23
8	7386.00	38.9 AV	54.0	-15.1	1.04 V	64	-3.33	42.23

- REMARKS:**
1. Emission level (dBuV/m) = Raw Value (dBuV) + Correction Factor (dB/m).
 2. Correction Factor (dB/m) = Antenna Factor (dB/m) + Cable Factor (dB).
 3. The other emission levels were very low against the limit.
 4. Margin value = Emission level – Limit value.
 5. “ * “: Fundamental frequency.



A D T

RESTRICTED BANDEDGE (802.11n (20MHz) MODE,CH1, HORIZONTAL)

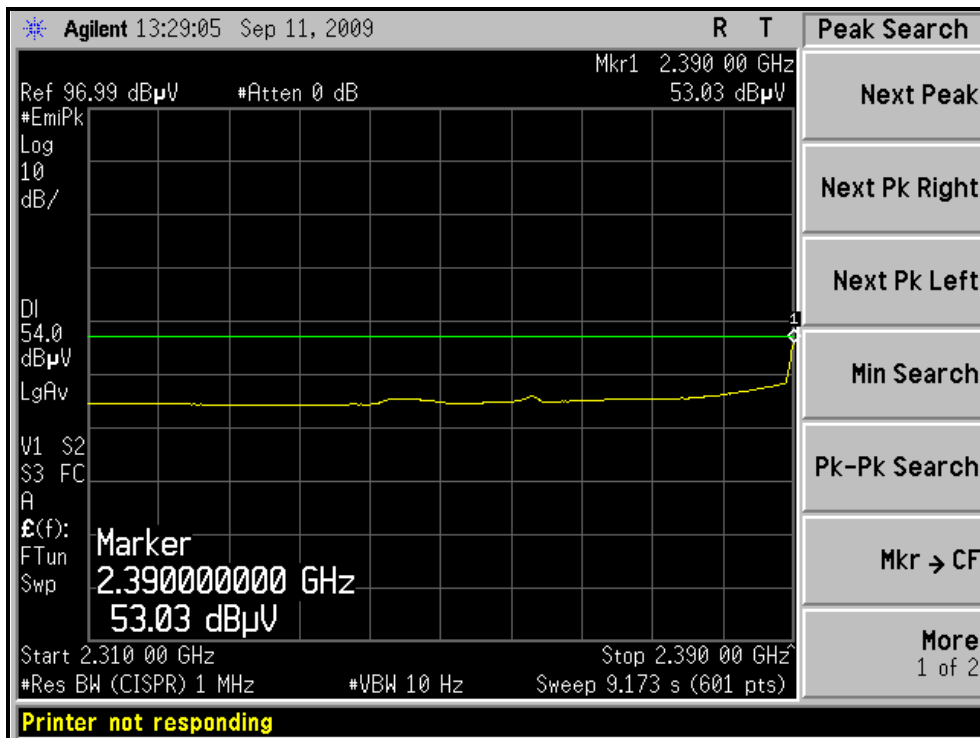
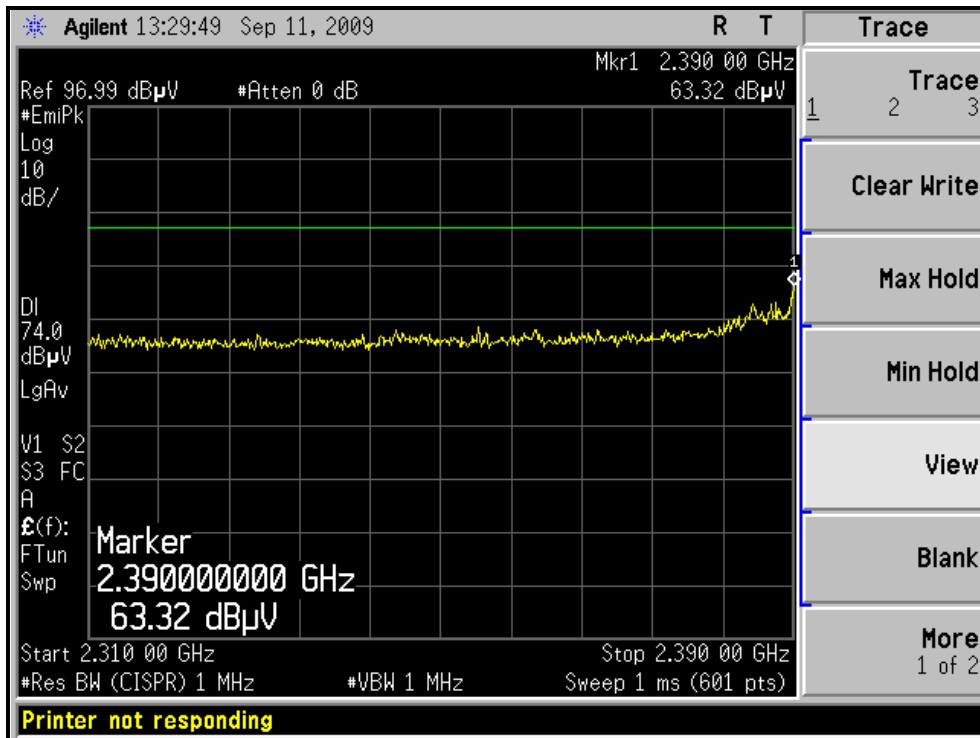



A D T

RESTRICTED BANDEDGE (802.11n (20MHz) MODE,CH1, VERTICAL)

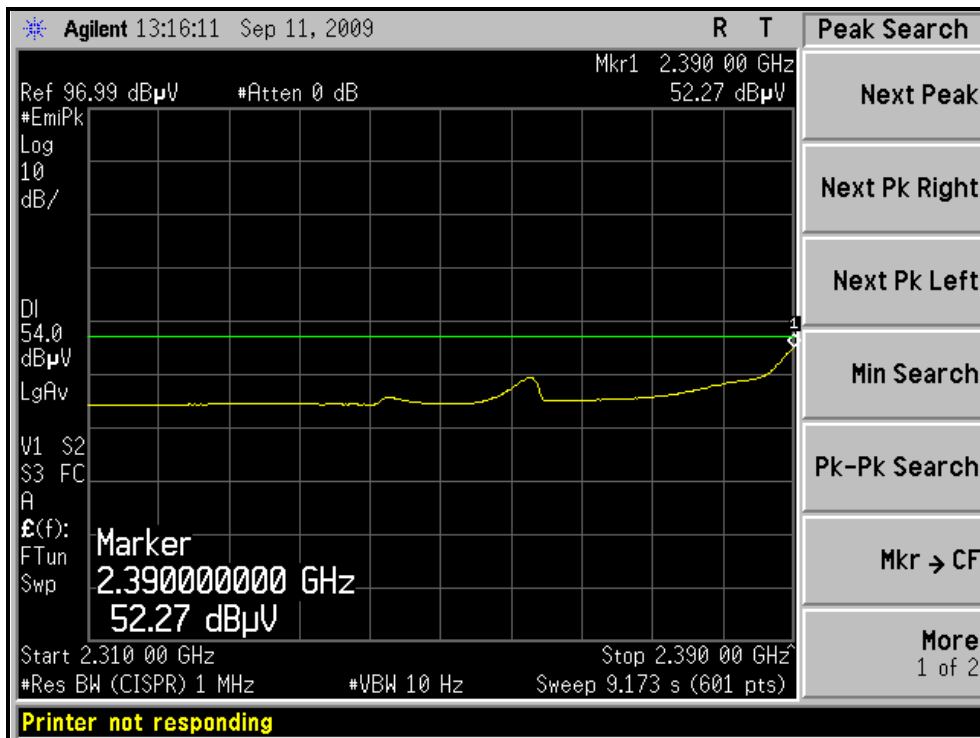



A D T

RESTRICTED BANDEDGE (802.11n (20MHz) MODE, CH11, HORIZONTAL)

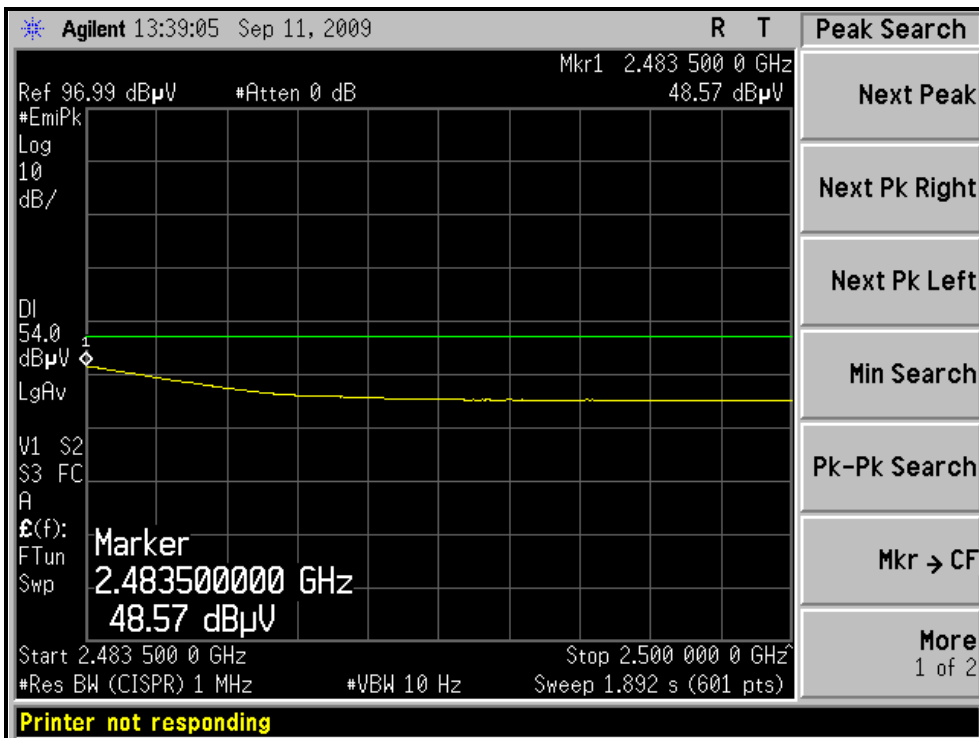
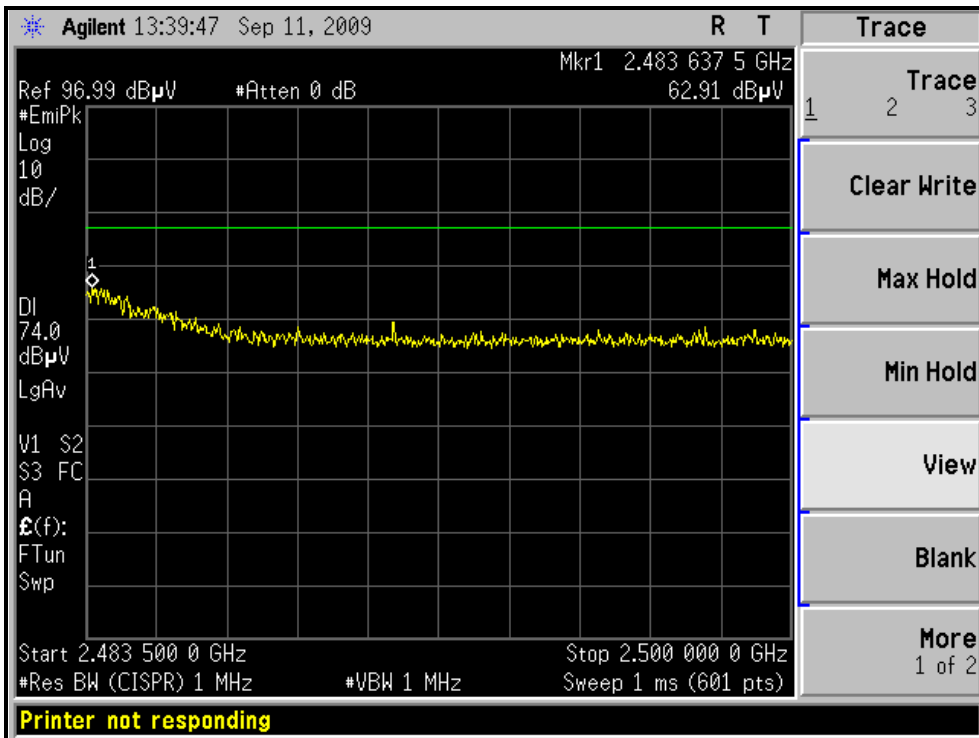



A D T

RESTRICTED BANDEDGE (802.11n (20MHz) MODE,CH11, VERTICAL)

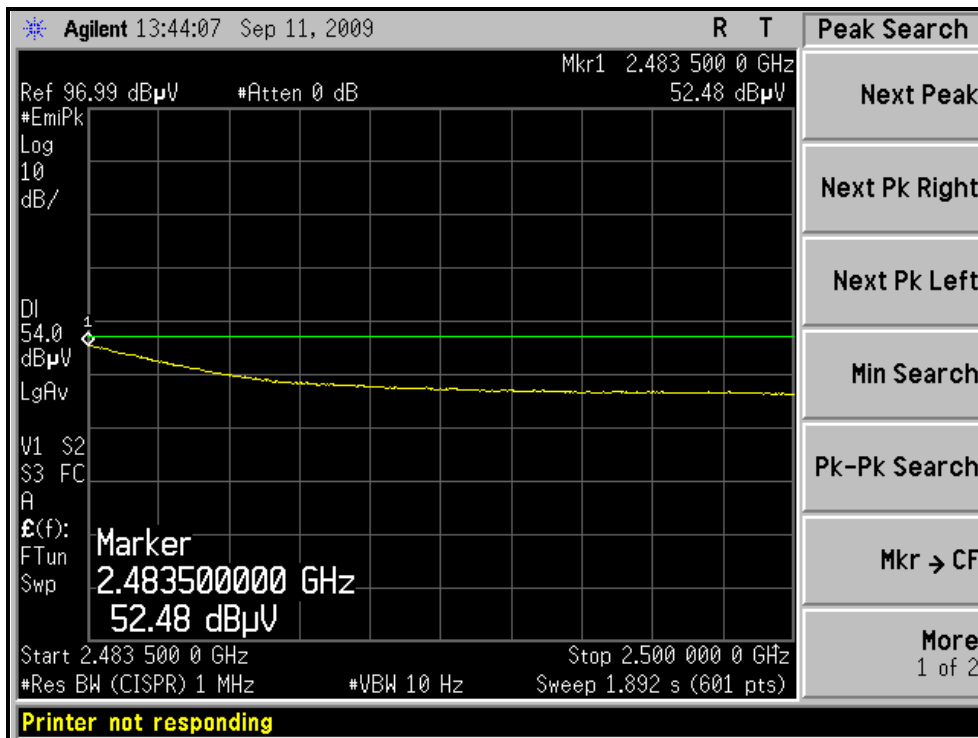
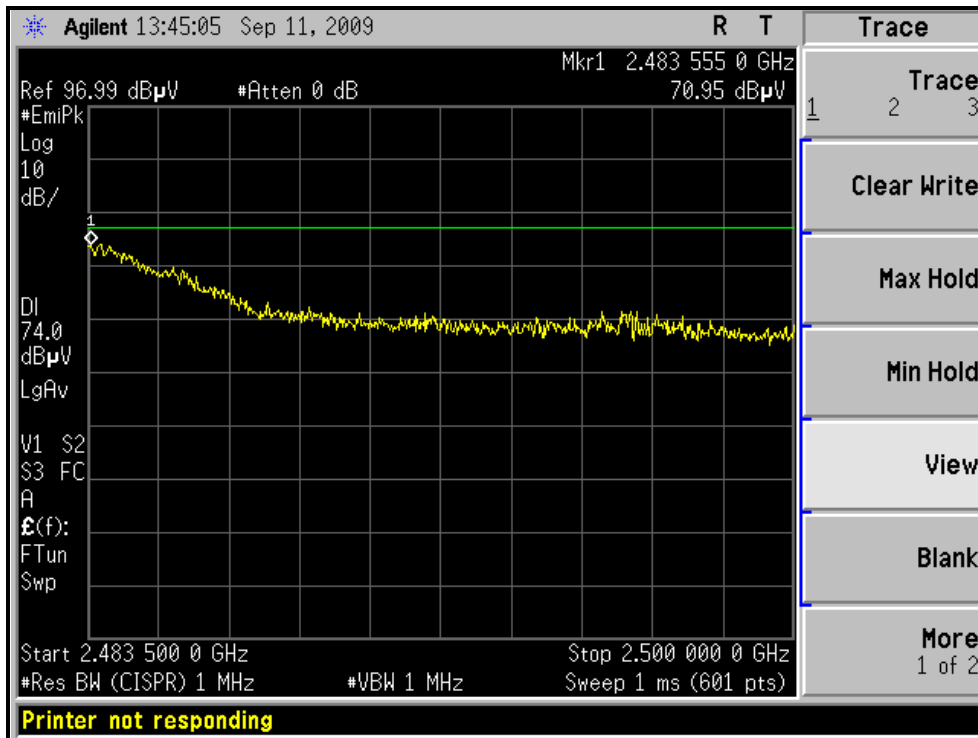



A D T

802.11n (40MHz) OFDM MODULATION

EUT TEST CONDITION		MEASUREMENT DETAIL	
CHANNEL	Channel 1	FREQUENCY RANGE	1 ~ 25GHz
INPUT POWER (SYSTEM)	120Vac, 60 Hz	DETECTOR FUNCTION	Peak (PK) Average (AV)
ENVIRONMENTAL CONDITIONS	20deg. C, 67%RH 1024 hPa	TESTED BY	Frank Liu

ANTENNA POLARITY & TEST DISTANCE: HORIZONTAL AT 3 M								
NO.	FREQ. (MHz)	EMISSION LEVEL (dBuV/m)	LIMIT (dBuV/m)	MARGIN (dB)	ANTENNA HEIGHT (m)	TABLE ANGLE (Degree)	RAW VALUE (dBuV)	CORRECTION FACTOR (dB/m)
1	2390.00	68.8 PK	74.0	-5.2	1.71 H	162	38.73	30.06
2	2390.00	52.6 AV	54.0	-1.4	1.71 H	162	22.58	30.06
3	*2422.00	104.8 PK			1.70 H	216	74.62	30.19
4	*2422.00	94.3 AV			1.70 H	216	64.11	30.19
5	4844.00	46.2 PK	74.0	-27.8	1.46 H	2	10.70	35.50
6	4844.00	33.6 AV	54.0	-20.4	1.46 H	2	-1.90	35.50
7	7266.00	50.4 PK	74.0	-23.6	1.09 H	12	8.47	41.93
8	7266.00	38.2 AV	54.0	-15.8	1.09 H	12	-3.73	41.93
ANTENNA POLARITY & TEST DISTANCE: VERTICAL AT 3 M								
NO.	FREQ. (MHz)	EMISSION LEVEL (dBuV/m)	LIMIT (dBuV/m)	MARGIN (dB)	ANTENNA HEIGHT (m)	TABLE ANGLE (Degree)	RAW VALUE (dBuV)	CORRECTION FACTOR (dB/m)
1	2390.00	67.4 PK	74.0	-6.6	1.71 V	162	37.34	30.06
2	2390.00	52.2 AV	54.0	-1.8	1.71 V	162	22.14	30.06
3	*2422.00	103.7 PK			1.27 V	360	73.50	30.19
4	*2422.00	93.7 AV			1.27 V	360	63.46	30.19
5	4844.00	42.7 PK	74.0	-31.3	1.00 V	104	7.20	35.50
6	4844.00	32.9 AV	54.0	-21.1	1.00 V	104	-2.60	35.50
7	7266.00	51.9 PK	74.0	-22.1	1.13 V	129	9.97	41.93
8	7266.00	38.6 AV	54.0	-15.4	1.13 V	129	-3.33	41.93

- REMARKS:**
1. Emission level (dBuV/m) = Raw Value (dBuV) + Correction Factor (dB/m).
 2. Correction Factor (dB/m) = Antenna Factor (dB/m) + Cable Factor (dB).
 3. The other emission levels were very low against the limit.
 4. Margin value = Emission level – Limit value.
 5. “ * “: Fundamental frequency.



A D T

EUT TEST CONDITION		MEASUREMENT DETAIL	
CHANNEL	Channel 4	FREQUENCY RANGE	1 ~ 25GHz
INPUT POWER (SYSTEM)	120Vac, 60 Hz	DETECTOR FUNCTION	Peak (PK) Average (AV)
ENVIRONMENTAL CONDITIONS	20deg. C, 67%RH 1024 hPa	TESTED BY	Frank Liu

ANTENNA POLARITY & TEST DISTANCE: HORIZONTAL AT 3 M								
NO.	FREQ. (MHz)	EMISSION LEVEL (dBuV/m)	LIMIT (dBuV/m)	MARGIN (dB)	ANTENNA HEIGHT (m)	TABLE ANGLE (Degree)	RAW VALUE (dBuV)	CORRECTION FACTOR (dB/m)
1	*2437.00	105.9 PK			1.64 H	213	75.66	30.24
2	*2437.00	95.1 AV			1.64 H	213	64.86	30.24
3	4874.00	45.1 PK	74.0	-28.9	1.47 H	272	9.53	35.55
4	4874.00	33.2 AV	54.0	-20.8	1.47 H	272	-2.34	35.55
5	7311.00	50.8 PK	74.0	-23.2	1.07 H	22	8.77	42.04
6	7311.00	38.2 AV	54.0	-15.9	1.07 H	22	-3.89	42.04
ANTENNA POLARITY & TEST DISTANCE: VERTICAL AT 3 M								
NO.	FREQ. (MHz)	EMISSION LEVEL (dBuV/m)	LIMIT (dBuV/m)	MARGIN (dB)	ANTENNA HEIGHT (m)	TABLE ANGLE (Degree)	RAW VALUE (dBuV)	CORRECTION FACTOR (dB/m)
1	2390.00	63.7 PK	74.0	-10.3	1.34 V	251	33.64	30.06
2	2390.00	49.6 AV	54.0	-4.4	1.34 V	251	19.54	30.06
3	*2437.00	104.1 PK			1.71 V	126	73.87	30.24
4	*2437.00	94.7 AV			1.71 V	126	64.44	30.24
5	2483.50	64.1 PK	74.0	-9.9	1.21 V	67	33.67	30.43
6	2483.50	48.4 AV	54.0	-5.6	1.21 V	67	17.97	30.43
7	4874.00	42.2 PK	74.0	-31.8	1.00 V	103	6.68	35.55
8	4874.00	32.3 AV	54.0	-21.7	1.00 V	103	-3.22	35.55
9	7311.00	51.7 PK	74.0	-22.3	1.12 V	127	9.65	42.04
10	7311.00	38.1 AV	54.0	-15.9	1.12 V	127	-3.93	42.04

- REMARKS:**
1. Emission level (dBuV/m) = Raw Value (dBuV) + Correction Factor (dB/m).
 2. Correction Factor (dB/m) = Antenna Factor (dB/m) + Cable Factor (dB).
 3. The other emission levels were very low against the limit.
 4. Margin value = Emission level – Limit value.
 5. “ * “: Fundamental frequency.



A D T

EUT TEST CONDITION		MEASUREMENT DETAIL	
CHANNEL	Channel 7	FREQUENCY RANGE	1 ~ 25GHz
INPUT POWER (SYSTEM)	120Vac, 60 Hz	DETECTOR FUNCTION	Peak (PK) Average (AV)
ENVIRONMENTAL CONDITIONS	20deg. C, 67%RH 1024 hPa	TESTED BY	Frank Liu

ANTENNA POLARITY & TEST DISTANCE: HORIZONTAL AT 3 M								
NO.	FREQ. (MHz)	EMISSION LEVEL (dBuV/m)	LIMIT (dBuV/m)	MARGIN (dB)	ANTENNA HEIGHT (m)	TABLE ANGLE (Degree)	RAW VALUE (dBuV)	CORRECTION FACTOR (dB/m)
1	*2452.00	102.4 PK			1.56 H	204	72.08	30.30
2	*2452.00	94.1 AV			1.56 H	204	63.83	30.30
3	2483.50	67.8 PK	74.0	-6.2	1.38 H	164	37.33	30.43
4	2483.50	52.3 AV	54.0	-1.7	1.38 H	164	21.85	30.43
5	4904.00	45.3 PK	74.0	-28.7	1.42 H	2	9.70	35.60
6	4904.00	33.5 AV	54.0	-20.5	1.42 H	2	-2.10	35.60
7	7356.00	50.9 PK	74.0	-23.1	1.04 H	29	8.74	42.16
8	7356.00	38.4 AV	54.0	-15.6	1.04 H	29	-3.76	42.16
ANTENNA POLARITY & TEST DISTANCE: VERTICAL AT 3 M								
NO.	FREQ. (MHz)	EMISSION LEVEL (dBuV/m)	LIMIT (dBuV/m)	MARGIN (dB)	ANTENNA HEIGHT (m)	TABLE ANGLE (Degree)	RAW VALUE (dBuV)	CORRECTION FACTOR (dB/m)
1	*2452.00	101.8 PK			1.57 V	256	71.53	30.30
2	*2452.00	92.7 AV			1.57 V	256	62.40	30.30
3	2483.50	66.6 PK	74.0	-7.4	1.57 V	113	36.13	30.43
4	2483.50	52.7 AV	54.0	-1.3	1.57 V	113	22.28	30.43
5	4904.00	42.1 PK	74.0	-31.9	1.00 V	106	6.50	35.60
6	4904.00	32.6 AV	54.0	-21.4	1.00 V	106	-3.00	35.60
7	7356.00	51.9 PK	74.0	-22.1	1.14 V	127	9.74	42.16
8	7356.00	38.4 AV	54.0	-15.6	1.14 V	127	-3.76	42.16

- REMARKS:**
1. Emission level (dBuV/m) = Raw Value (dBuV) + Correction Factor (dB/m).
 2. Correction Factor (dB/m) = Antenna Factor (dB/m) + Cable Factor (dB).
 3. The other emission levels were very low against the limit.
 4. Margin value = Emission level – Limit value.
 5. “ * “: Fundamental frequency.



A D T

RESTRICTED BANDEDGE (802.11n (40MHz) MODE,CH1, HORIZONTAL)

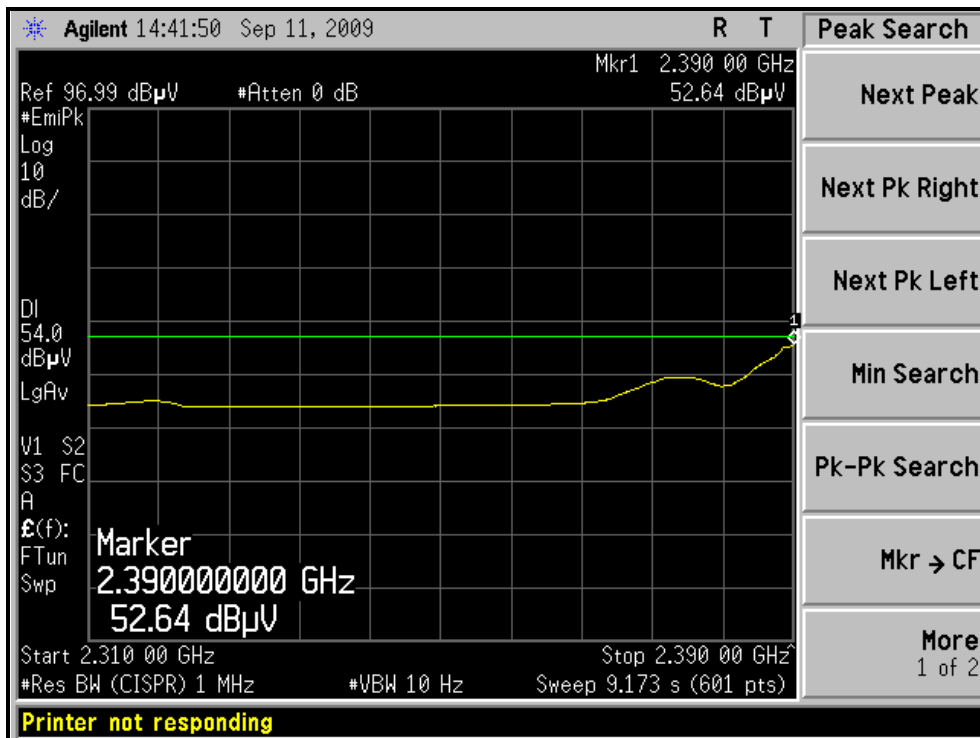
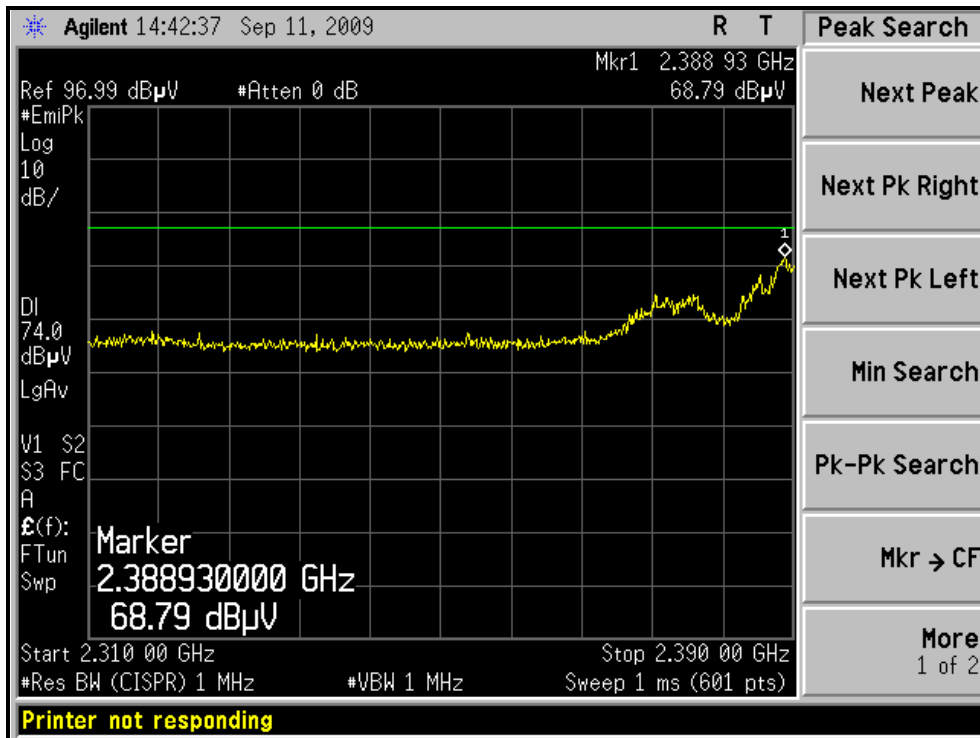



A D T

RESTRICTED BANDEDGE (802.11n (40MHz) MODE,CH1, VERTICAL)

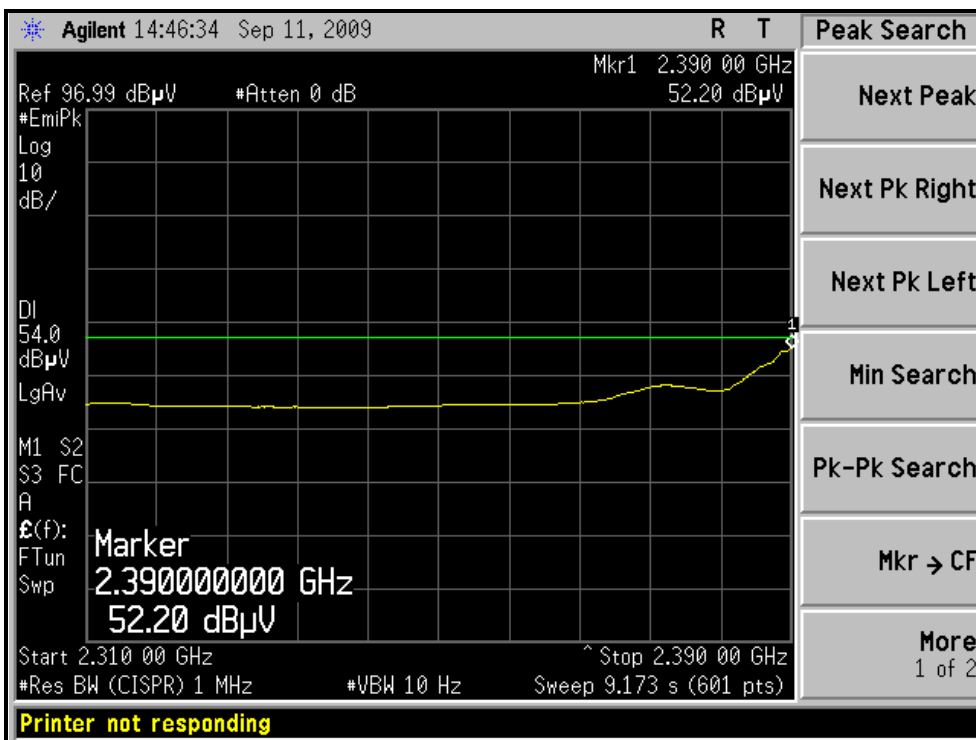



A D T

RESTRICTED BANDEDGE (802.11n (40MHz) MODE,CH7, HORIZONTAL)

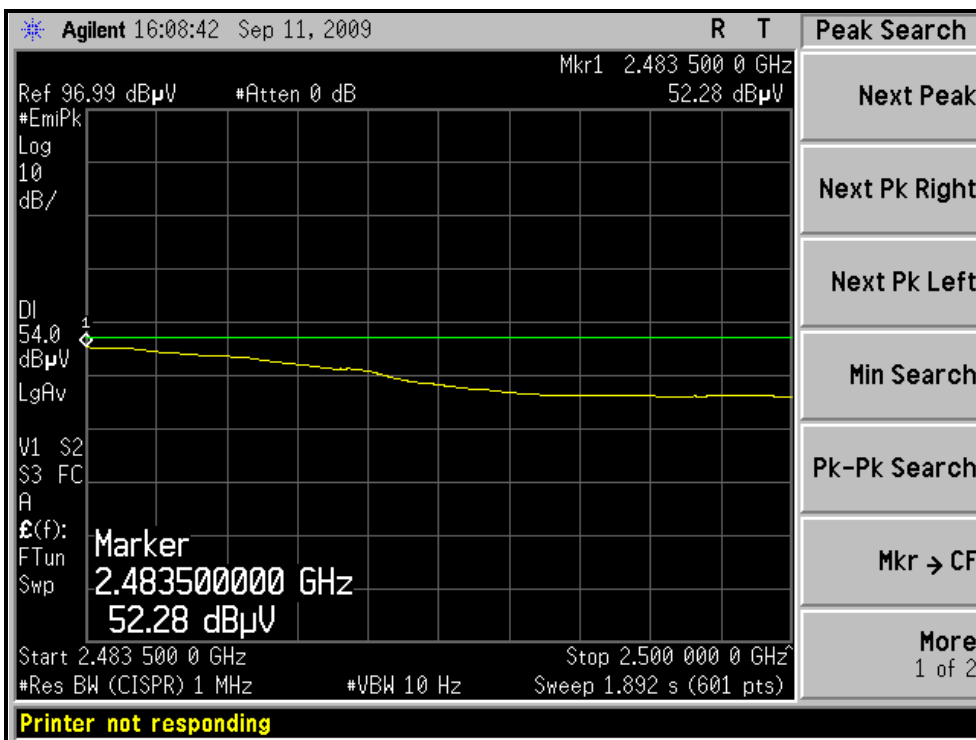
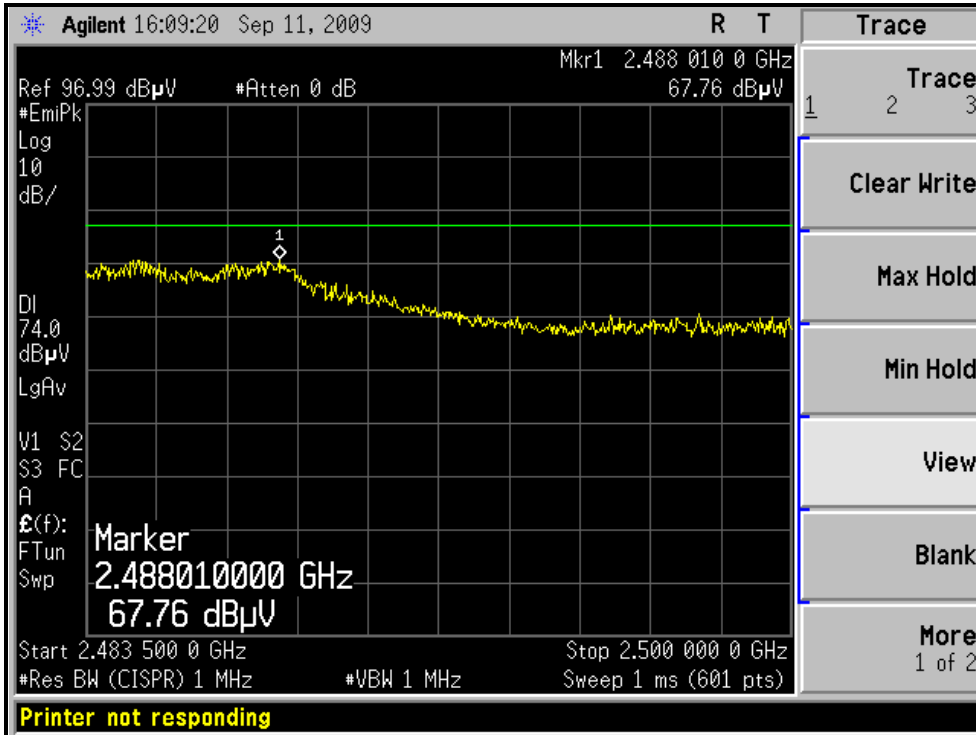



A D T

RESTRICTED BANDEDGE (802.11n (40MHz) MODE,CH7, VERTICAL)

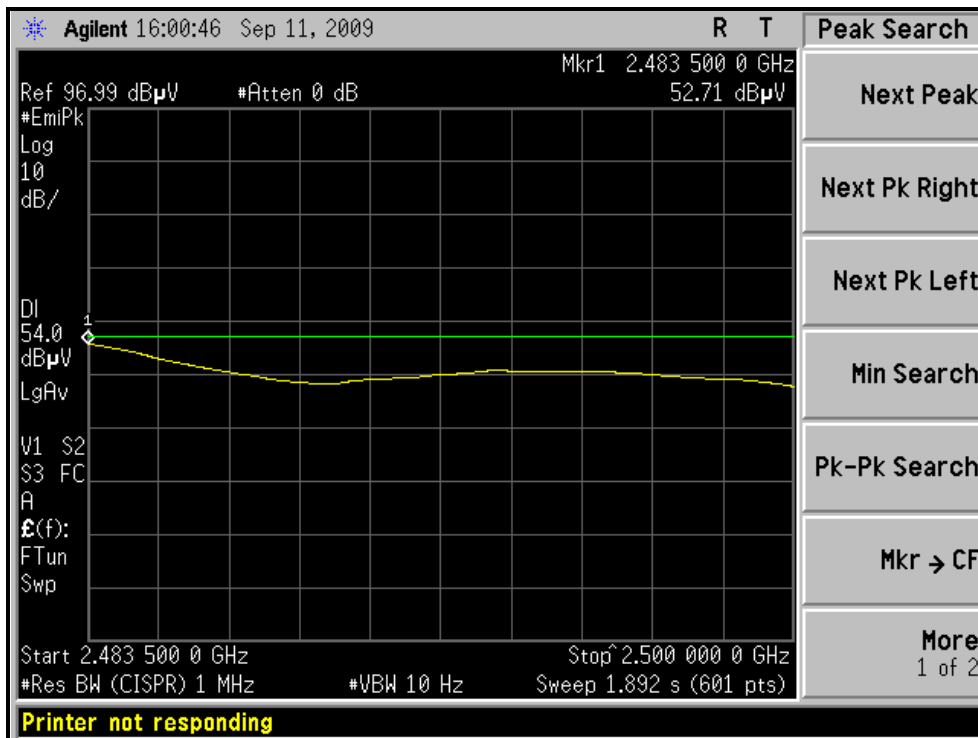
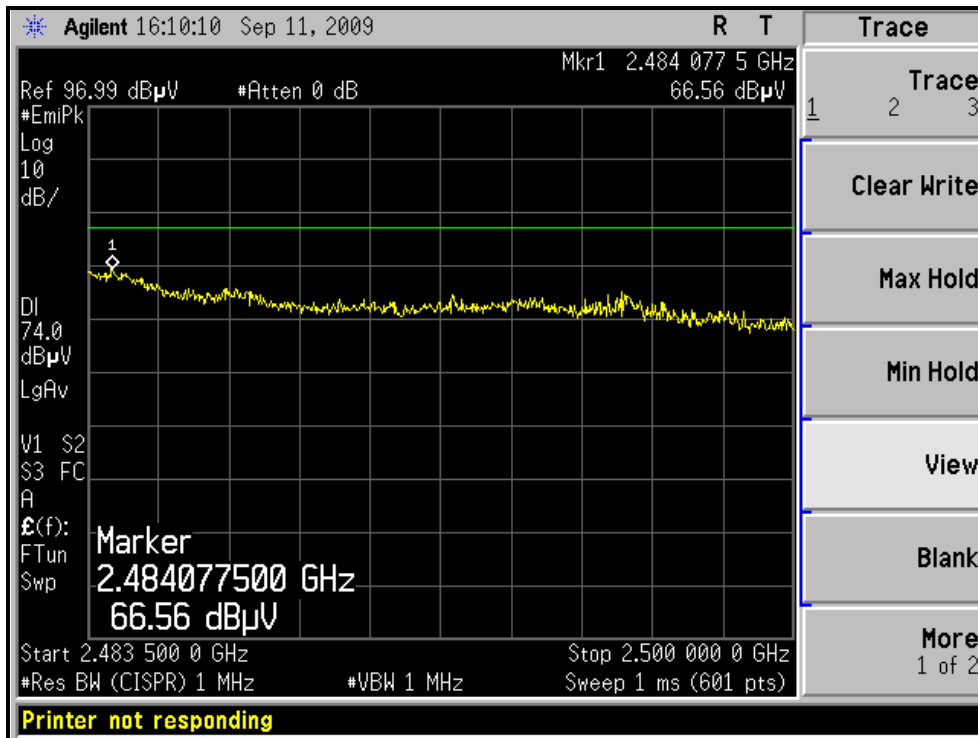



4.3 6dB BANDWIDTH MEASUREMENT

4.3.1 LIMITS OF 6dB BANDWIDTH MEASUREMENT

The minimum of 6dB Bandwidth Measurement is 0.5 MHz.

4.3.2 TEST INSTRUMENTS

DESCRIPTION & MANUFACTURER	MODEL NO.	SERIAL NO.	CALIBRATED DATE	CALIBRATED UNTIL
R&S SPECTRUM ANALYZER	FSP40	100037	Aug. 03, 2009	Aug. 02, 2010

NOTE:

1. The calibration interval of the above test instruments is 12 months and the calibrations are traceable to NML/ROC and NIST/USA.

4.3.3 TEST PROCEDURE

The transmitter output was connected to the spectrum analyzer through an attenuator. The bandwidth of the fundamental frequency was measured by spectrum analyzer with 100kHz RBW and 100kHz VBW. The 6dB bandwidth is defined as the total spectrum the power of which is higher than peak power minus 6dB.

4.3.4 DEVIATION FROM TEST STANDARD

No deviation

4.3.5 TEST SETUP



4.3.6 EUT OPERATING CONDITIONS

The software provided by client to enable the EUT under transmission condition continuously at lowest, middle and highest channel frequencies individually.

4.3.7 TEST RESULTS

802.11b DSSS MODULATION:

CHANNEL	CHANNEL FREQUENCY (MHz)	6dB BANDWIDTH (MHz)	MINIMUM LIMIT (MHz)	PASS / FAIL
1	2412	11.22	0.5	PASS
6	2437	11.22	0.5	PASS
11	2462	11.23	0.5	PASS

CH11

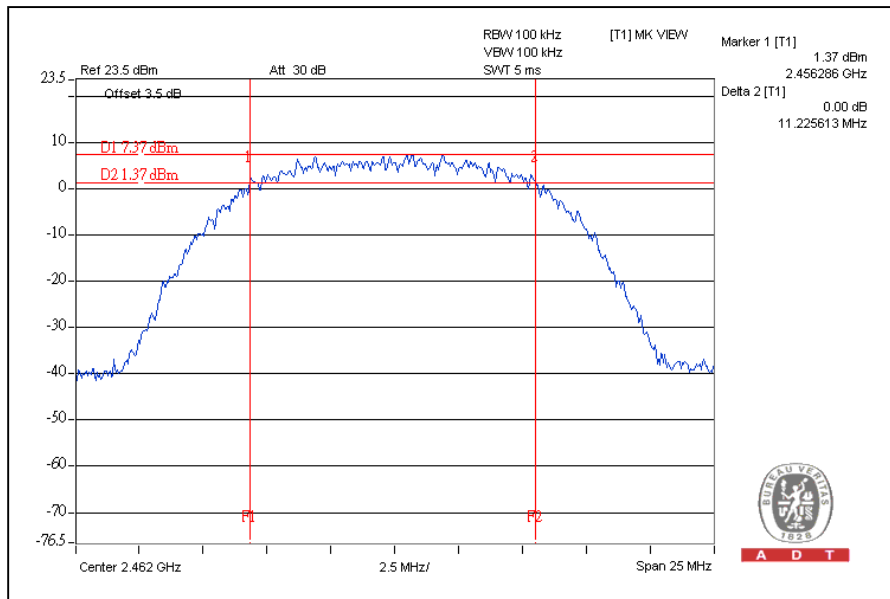



A D T

802.11g OFDM MODULATION:

CHANNEL	CHANNEL FREQUENCY (MHz)	6dB BANDWIDTH (MHz)	MINIMUM LIMIT (MHz)	PASS / FAIL
1	2412	16.42	0.5	PASS
6	2437	16.46	0.5	PASS
11	2462	16.44	0.5	PASS

CH6

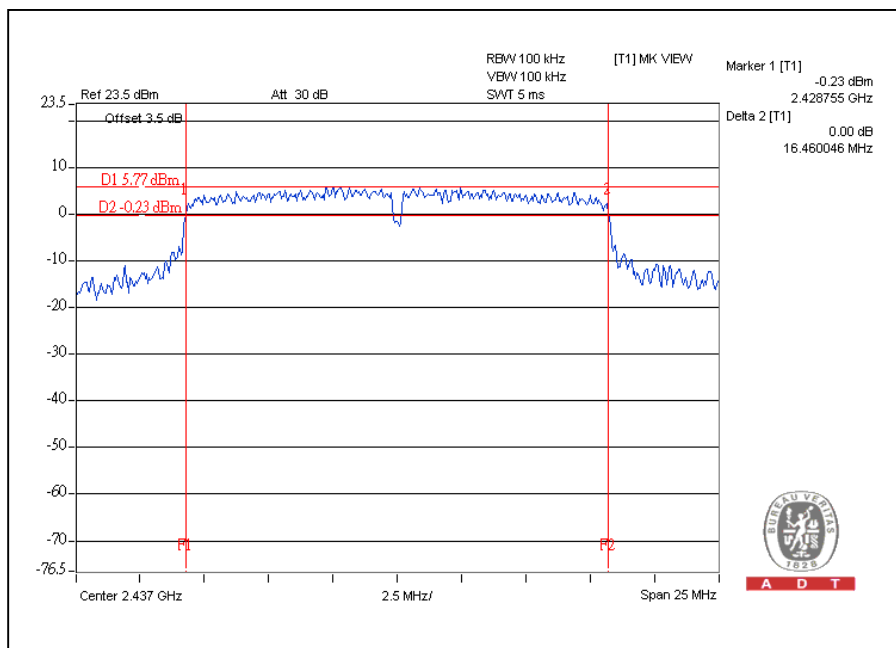



A D T

802.11n (20MHz) OFDM MODULATION:

CHANNEL	CHANNEL FREQUENCY (MHz)	6dB BANDWIDTH (MHz)	MINIMUM LIMIT (MHz)	PASS / FAIL
1	2412	17.62	0.5	PASS
6	2437	17.67	0.5	PASS
11	2462	17.14	0.5	PASS

CH6

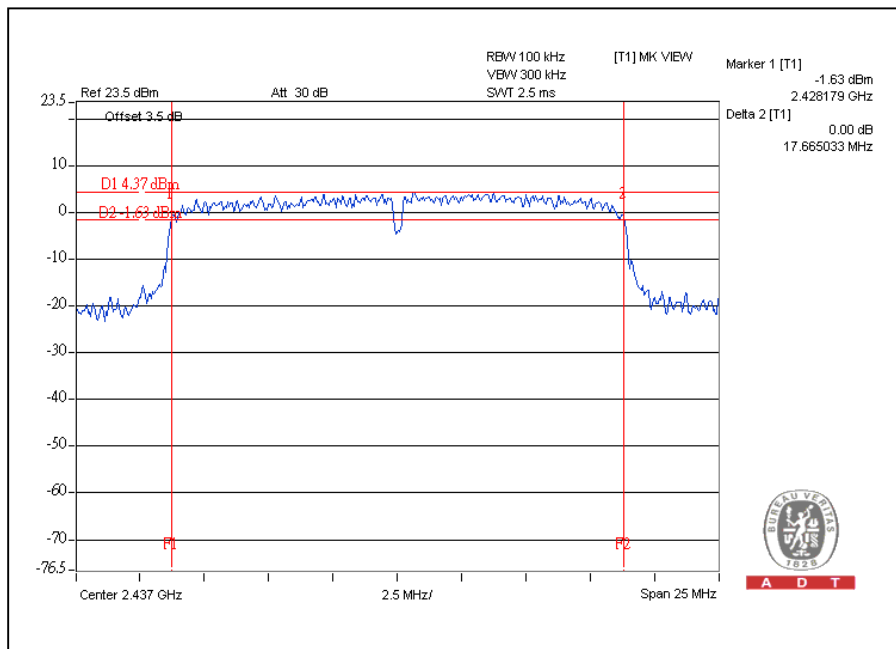



A D T

802.11n (40MHz) OFDM MODULATION:

CHANNEL	CHANNEL FREQUENCY (MHz)	6dB BANDWIDTH (MHz)	MINIMUM LIMIT (MHz)	PASS / FAIL
1	2422	36.16	0.5	PASS
4	2437	36.18	0.5	PASS
7	2452	36.43	0.5	PASS

CH7

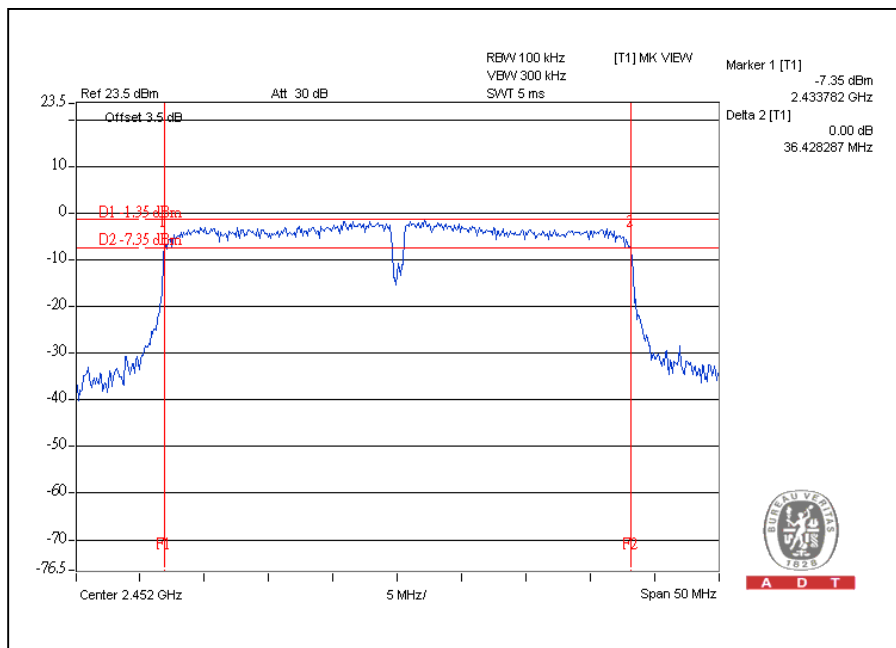

4.4 MAXIMUM PEAK OUTPUT POWER

4.4.1 LIMITS OF MAXIMUM PEAK OUTPUT POWER MEASUREMENT

The Maximum Peak Output Power Measurement is 30dBm.

4.4.2 INSTRUMENTS

DESCRIPTION & MANUFACTURER	MODEL NO.	SERIAL NO.	CALIBRATED DATE	CALIBRATED UNTIL
Anritsu Power Meter	ML2495A	0824006	April 25, 2009	April 24, 2010
Pulse Power Sensor	MA2411B	0738172	April 25, 2009	April 24, 2010

NOTE:

The calibration interval of the above test instruments is 12 months and the calibrations are traceable to NML/ROC and NIST/USA.

4.4.3 TEST PROCEDURES

1. The transmitter output was connected to the power meter through an attenuator; the bandwidth of the fundamental frequency was measured with the power meter.
2. Record the power level.

4.4.4 DEVIATION FROM TEST STANDARD

No deviation

4.4.5 TEST SETUP

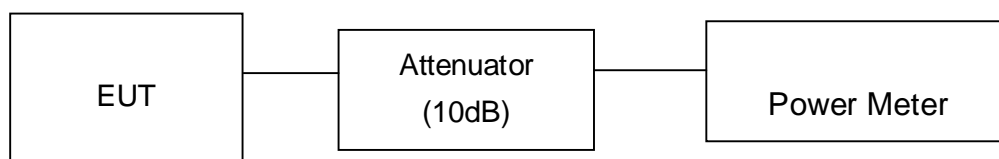

4.4.6 EUT OPERATING CONDITIONS

Same as Item 4.3.6



A D T

4.4.7 TEST RESULTS

802.11b DSSS MODULATION:

CHANNEL	CHANNEL FREQUENCY (MHz)	PEAK POWER OUTPUT (dBm)	PEAK POWER OUTPUT (mW)	PEAK POWER LIMIT (dBm)	PASS / FAIL
1	2412	21.2	131.8	30	PASS
6	2437	23.8	239.9	30	PASS
11	2462	20.8	120.2	30	PASS

802.11g OFDM MODULATION:

CHANNEL	CHANNEL FREQUENCY (MHz)	PEAK POWER OUTPUT (dBm)	PEAK POWER OUTPUT (mW)	PEAK POWER LIMIT (dBm)	PASS / FAIL
1	2412	21.1	128.8	30	PASS
6	2437	24.3	269.2	30	PASS
11	2462	24.3	269.2	30	PASS

802.11n (20MHz) OFDM MODULATION:

CHANNEL	CHANNEL FREQUENCY (MHz)	PEAK POWER OUTPUT (dBm)		TOTAL PEAK POWER (mW)	TOTAL PEAK POWER (dBm)	PEAK POWER LIMIT (dBm)	PASS / FAIL
		CHAIN(0)	CHAIN(1)				
1	2412	24.3	24.2	532.2	27.3	30	PASS
6	2437	24.1	24.6	545.4	27.4	30	PASS
11	2462	23.8	24.0	491.1	26.9	30	PASS



A D T

802.11n (40MHz) OFDM MODULATION:

CHANNEL	CHANNEL FREQUENCY (MHz)	PEAK POWER OUTPUT (dBm)		TOTAL PEAK POWER (mW)	TOTAL PEAK POWER (dBm)	PEAK POWER LIMIT (dBm)	PASS / FAIL
		CHAIN(0)	CHAIN(1)				
1	2422	22.7	22.4	360.0	25.6	30	PASS
4	2437	24.8	24.3	571.1	27.6	30	PASS
7	2452	22.3	22.6	351.8	25.5	30	PASS



4.5 POWER SPECTRAL DENSITY MEASUREMENT

4.5.1 LIMITS OF POWER SPECTRAL DENSITY MEASUREMENT

The Maximum of Power Spectral Density Measurement is 8dBm.

4.5.2 TEST INSTRUMENTS

DESCRIPTION & MANUFACTURER	MODEL NO.	SERIAL NO.	CALIBRATED DATE	CALIBRATED UNTIL
R&S SPECTRUM ANALYZER	FSP40	100037	Aug. 03, 2009	Aug. 02, 2010

NOTE:

- 1.The calibration interval of the above test instruments is 12 months and the calibrations are traceable to NML/ROC and NIST/USA.

4.5.3 TEST PROCEDURE

The transmitter output was connected to the spectrum analyzer through an attenuator, the bandwidth of the fundamental frequency was measured with the spectrum analyzer using 3kHz RBW and 30kHz VBW, set sweep time = span/3kHz. The power spectral density was measured and recorded. The sweep time is allowed to be longer than span/3kHz for a full response of the mixer in the spectrum analyzer.

4.5.4 DEVIATION FROM TEST STANDARD

No deviation

4.5.5 TEST SETUP

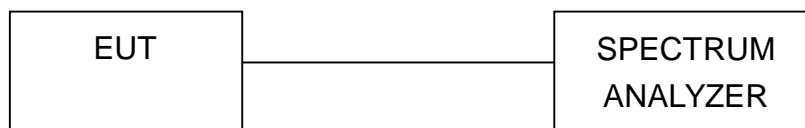

4.5.6 EUT OPERATING CONDITION

Same as Item 4.3.6



A D T

4.5.7 TEST RESULTS

802.11b DSSS MODULATION:

CHANNEL	CHANNEL FREQUENCY (MHz)	RF POWER LEVEL IN 3kHz BW (dBm)	MAXIMUM LIMIT (dBm)	PASS / FAIL
1	2412	-4.9	8	PASS
6	2437	-3.1	8	PASS
11	2462	-5.5	8	PASS

CH6

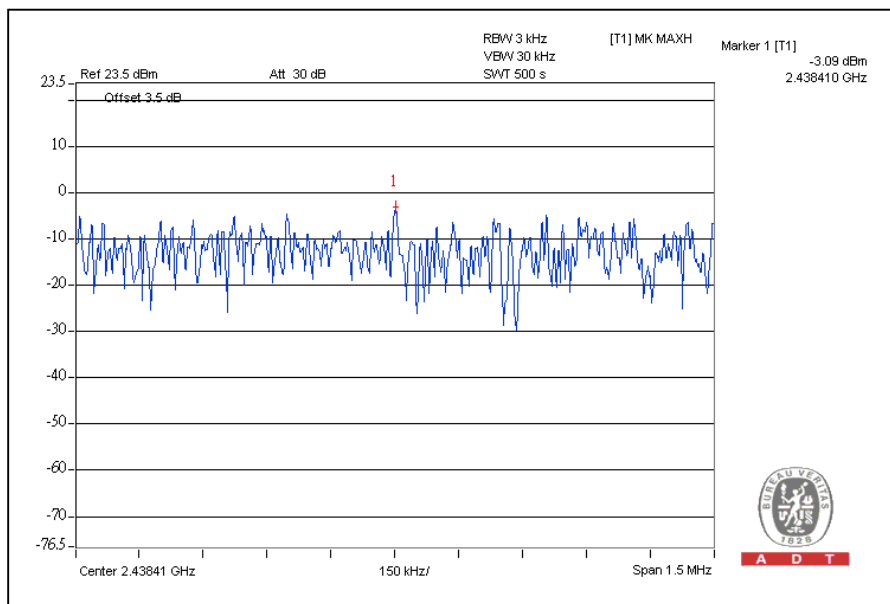



A D T

802.11g OFDM MODULATION:

CHANNEL	CHANNEL FREQUENCY (MHz)	RF POWER LEVEL IN 3kHz BW (dBm)	MAXIMUM LIMIT (dBm)	PASS / FAIL
1	2412	-9.7	8	PASS
6	2437	-8.0	8	PASS
11	2462	-8.5	8	PASS

CH6

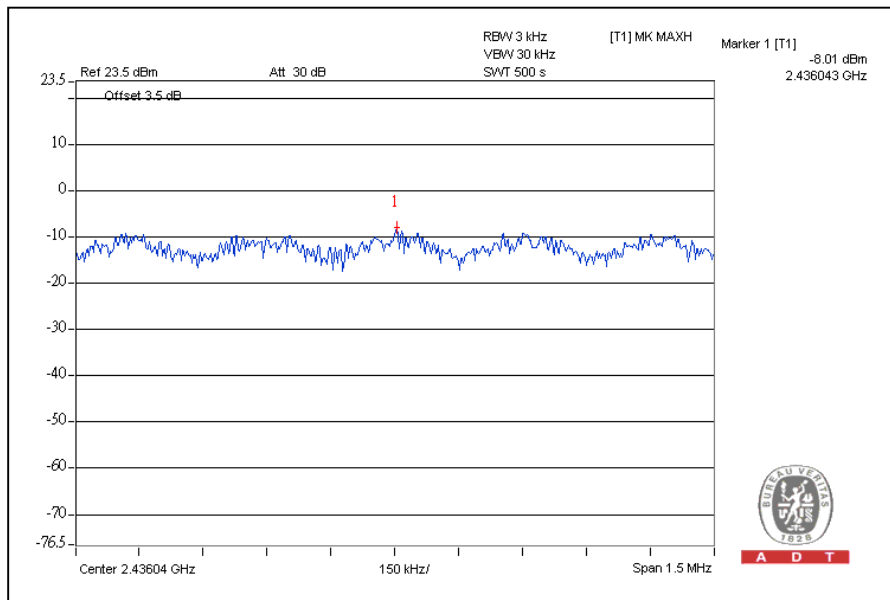

802.11n (20MHz) OFDM MODULATION:

CHANNEL	CHANNEL FREQUENCY (MHz)	RF POWER LEVEL IN 3kHz BW (dBm)		TOTAL POWER DENSITY (dBm)	MAXIMUM LIMIT (dBm)	PASS / FAIL
		CHAIN(0)	CHAIN(1)			
1	2412	-9.2	-9.2	-6.2	8	PASS
6	2437	-10.1	-9.6	-6.8	8	PASS
11	2462	-8.8	-10.2	-6.4	8	PASS

For Chain(0): CH11

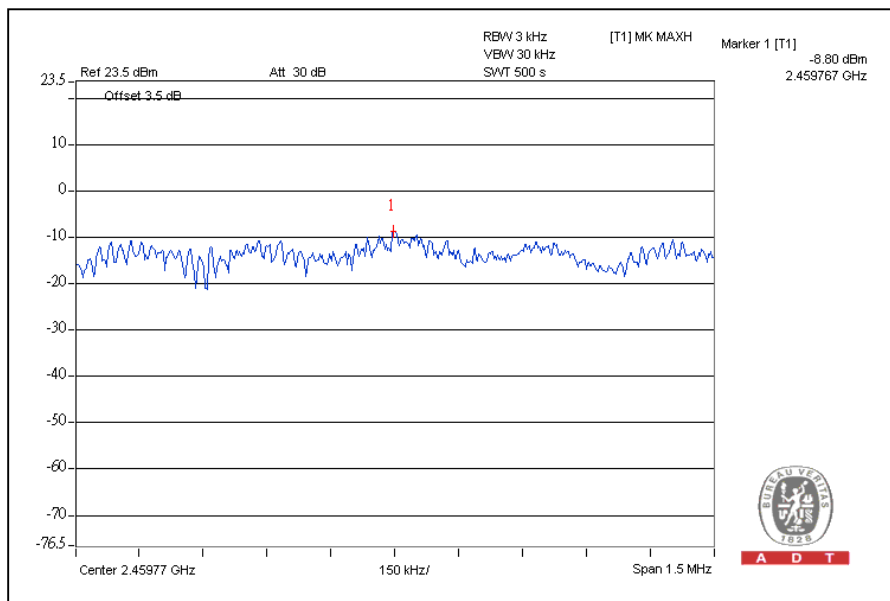



A D T

802.11n (40MHz) OFDM MODULATION:

CHANNEL	CHANNEL FREQUENCY (MHz)	RF POWER LEVEL IN 3kHz BW (dBm)		TOTAL POWER DENSITY (dBm)	MAXIMUM LIMIT (dBm)	PASS / FAIL
		CHAIN(0)	CHAIN(1)			
1	2422	-13.7	-12.7	-10.1	8	PASS
4	2437	-12.3	-8.9	-7.3	8	PASS
7	2452	-13.8	-10.2	-8.6	8	PASS

For Chain (1): CH4

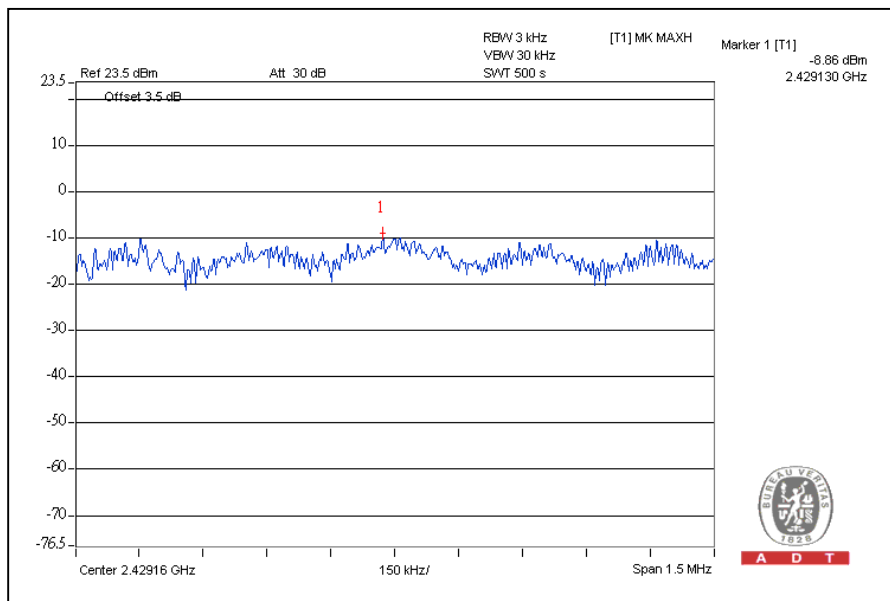

4.6 CONDUCTED OUT-BAND EMISSION MEASUREMENT

4.6.1 LIMITS OF CONDUCTED OUT-BAND EMISSION MEASUREMENT

Below -20dB of the highest emission level of operating band (in 100kHz Resolution Bandwidth).

4.6.2 TEST INSTRUMENTS

DESCRIPTION & MANUFACTURER	MODEL NO.	SERIAL NO.	CALIBRATED DATE	CALIBRATED UNTIL
R&S SPECTRUM ANALYZER	FSP40	100037	Aug. 03, 2009	Aug. 02, 2010

NOTE:

1. The calibration interval of the above test instruments is 12 months and the calibrations are traceable to NML/ROC and NIST/USA.

4.6.3 TEST PROCEDURE

The transmitter output was connected to the spectrum analyzer via a low loss cable. Set RBW of spectrum analyzer to 100kHz and VBW of spectrum analyzer to 300kHz with suitable frequency span including 100 MHz bandwidth from band edge. The band edges was measured and recorded.

The spectrum plots (RBW = 100kHz, VBW = 300kHz) are attached on the following pages.

4.6.4 DEVIATION FROM TEST STANDARD

No deviation

4.6.5 EUT OPERATING CONDITION

Same as Item 4.3.6

4.6.6 TEST RESULTS

The spectrum plots are attached on the following images. D1 line indicates the highest level, and D2 line indicates the 20dB offset below D1. It shows compliance with the requirement in part 15.247(d).

802.11b DSSS MODULATION:

CH1

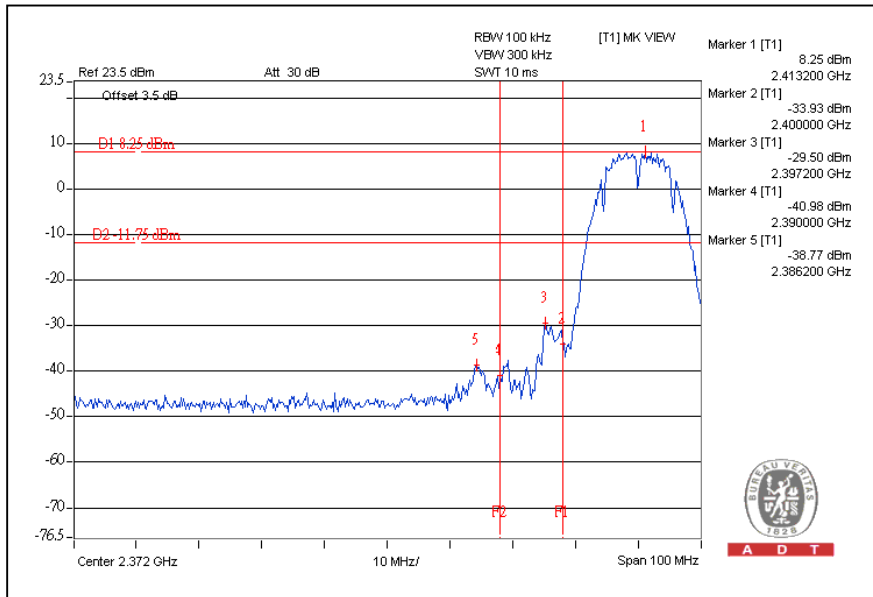

CH11

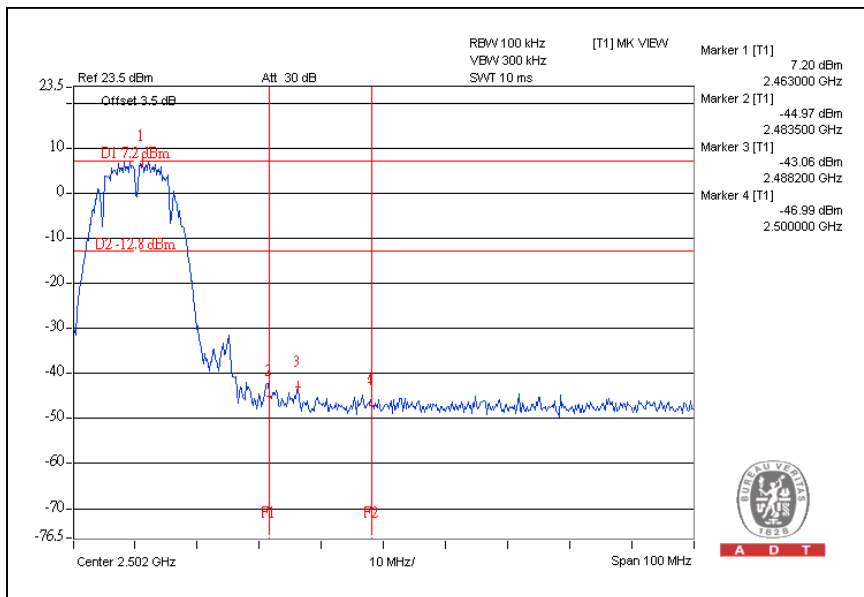



A D T

CH1

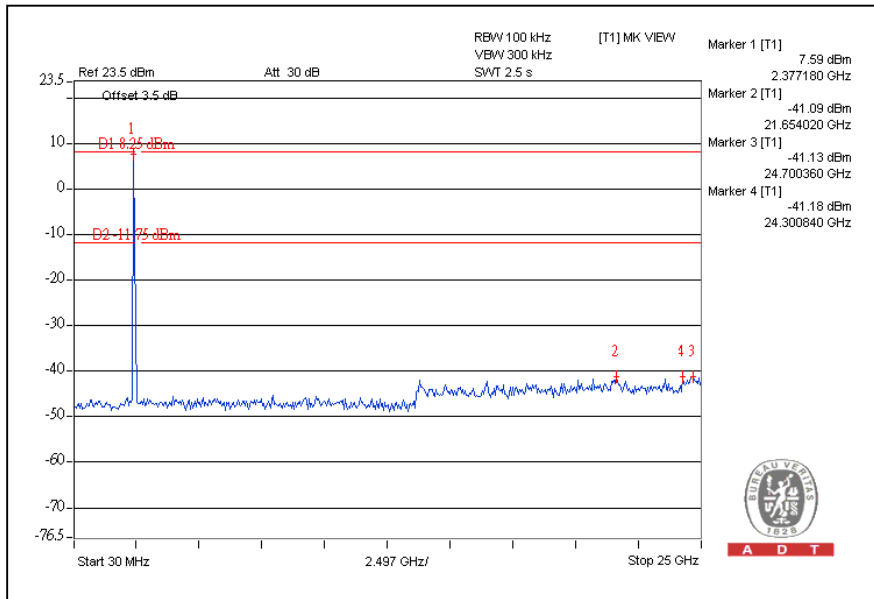

CH11

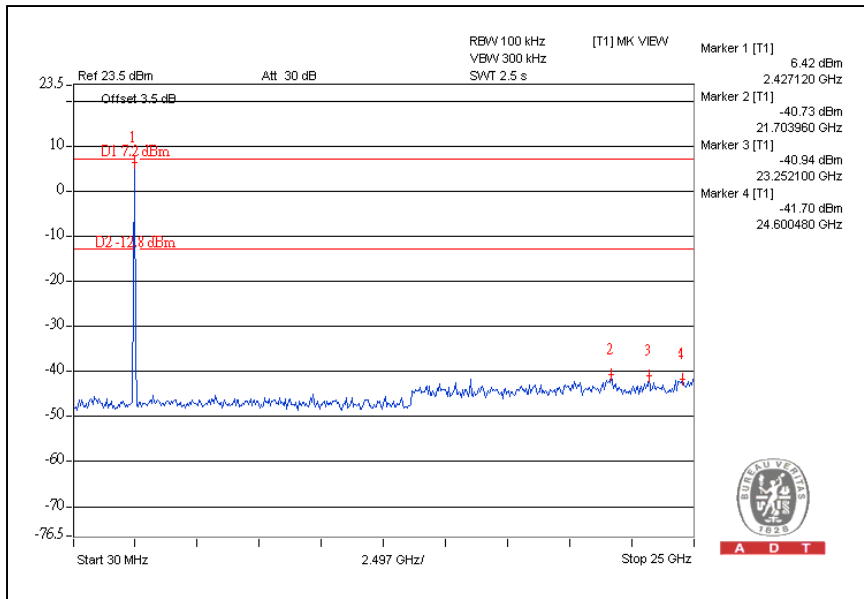

802.11g OFDM MODULATION::

CH1

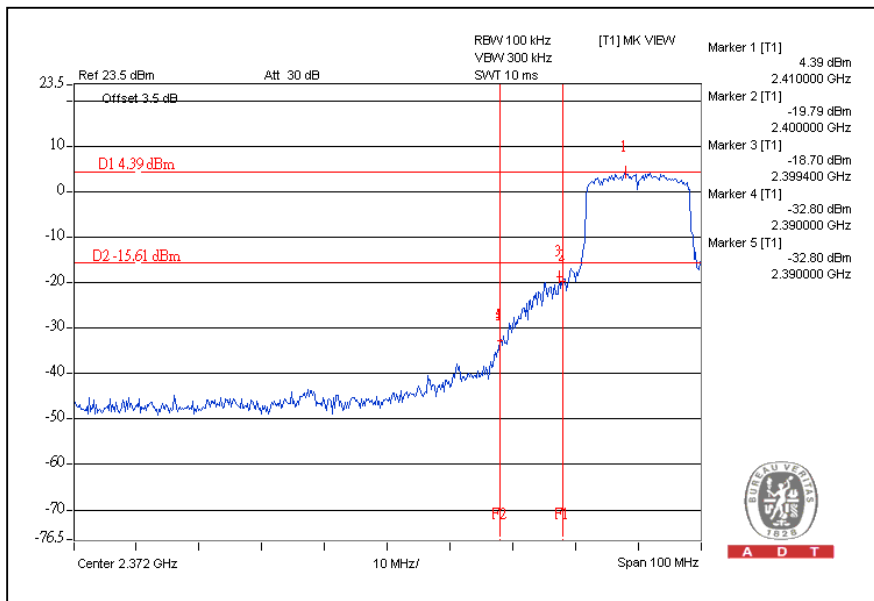

CH11

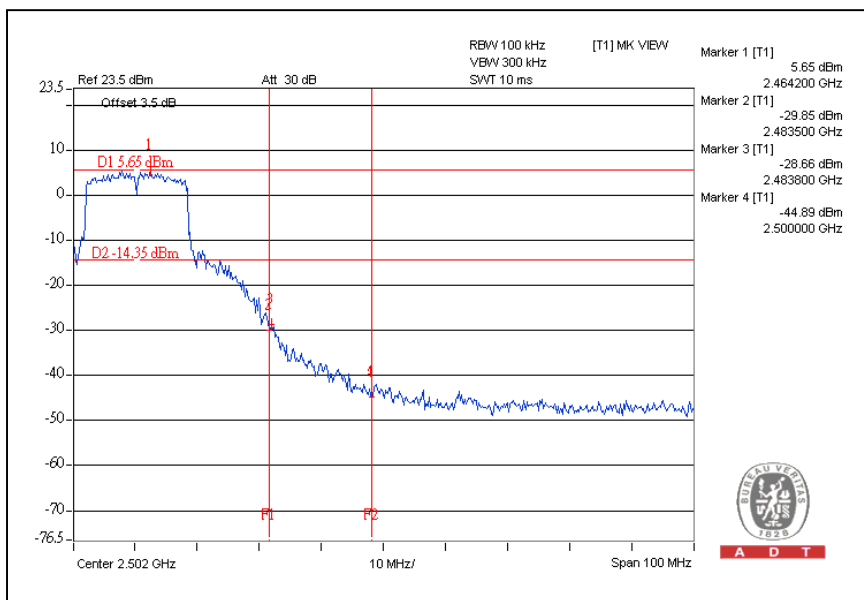



A D T

CH1

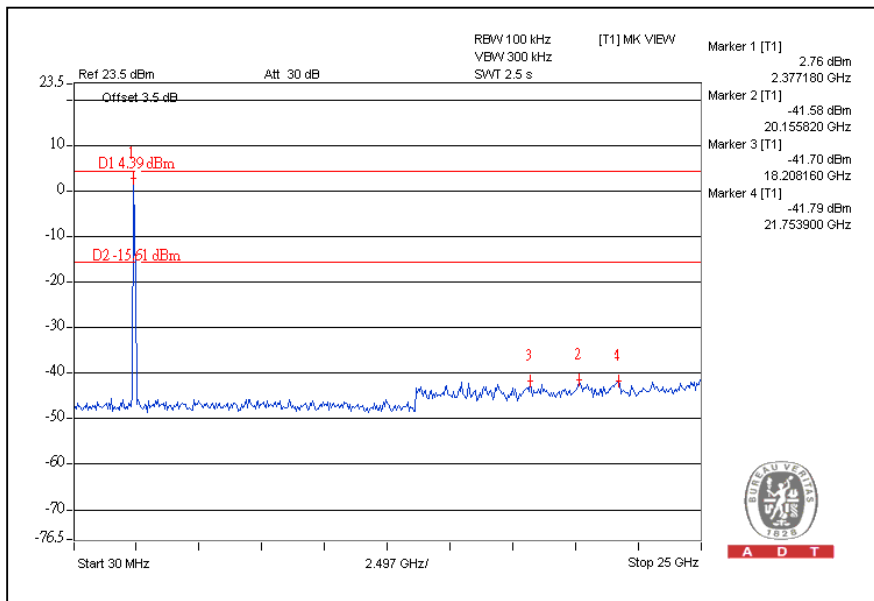

CH11

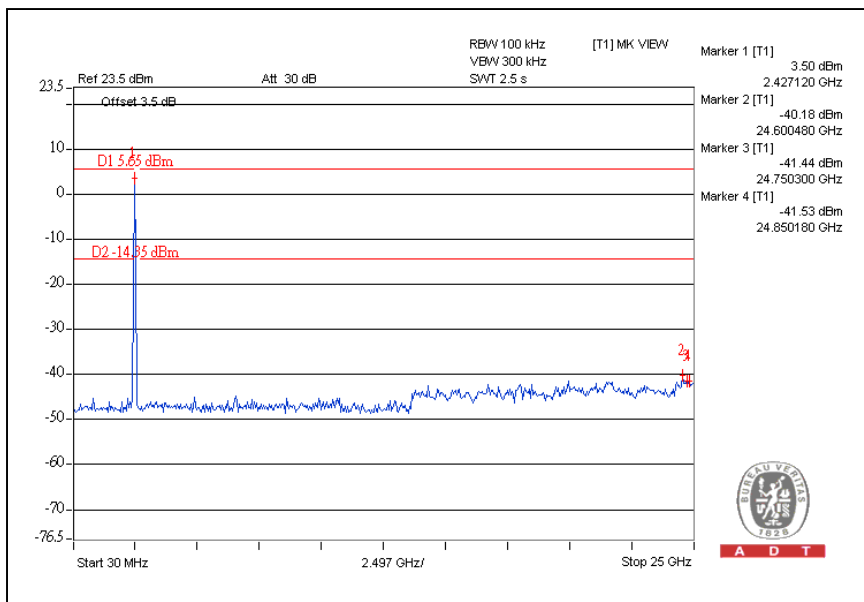

802.11n (20MHz) OFDM MODULATION:

CH1

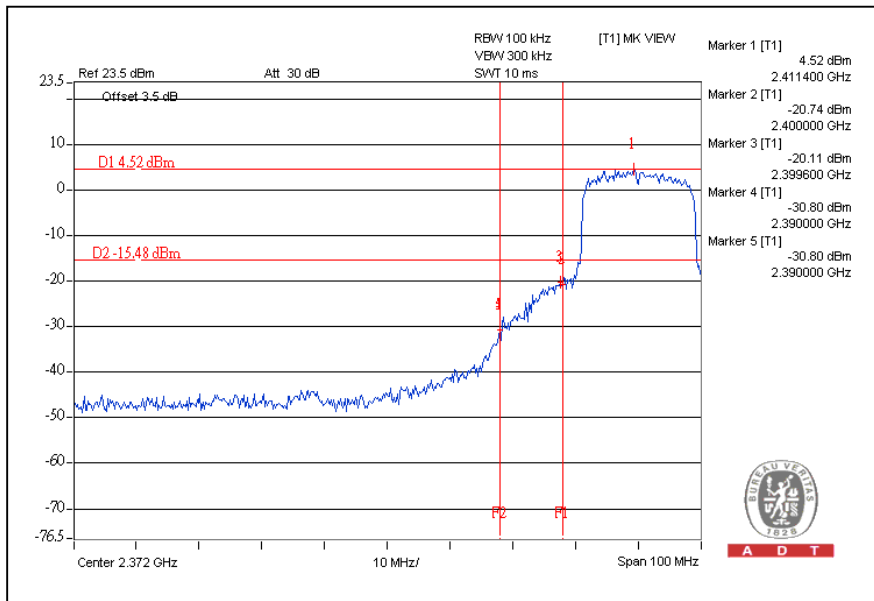

CH11

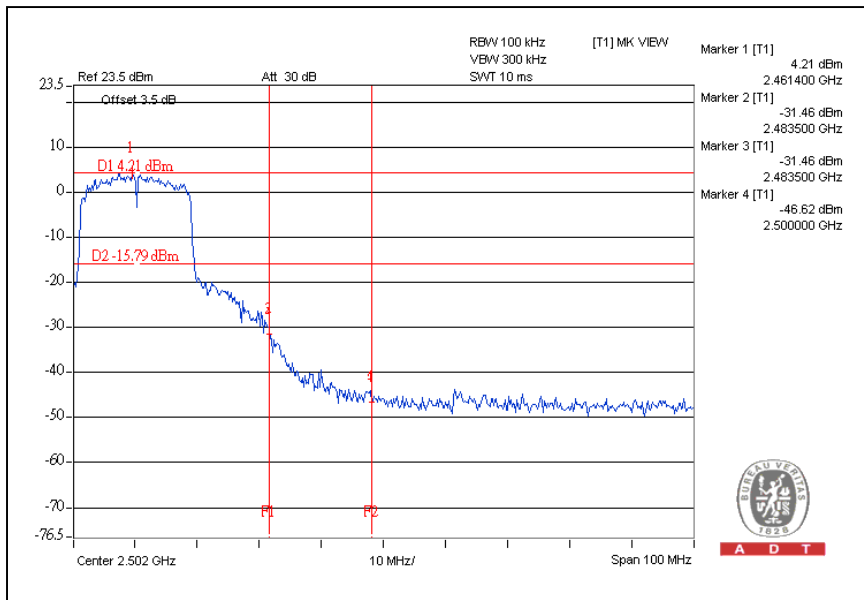



A D T

CH1

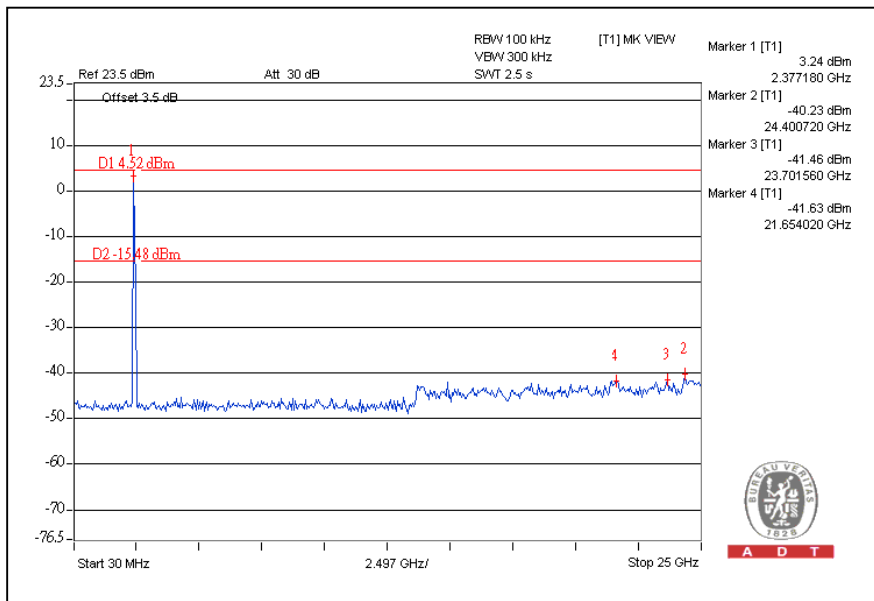

CH11

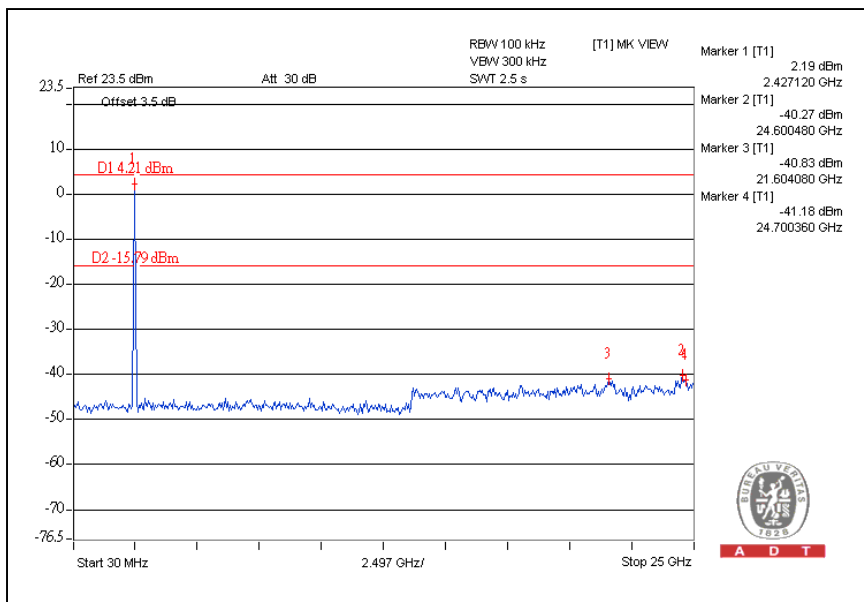

802.11n (40MHz) OFDM MODULATION:

CH1

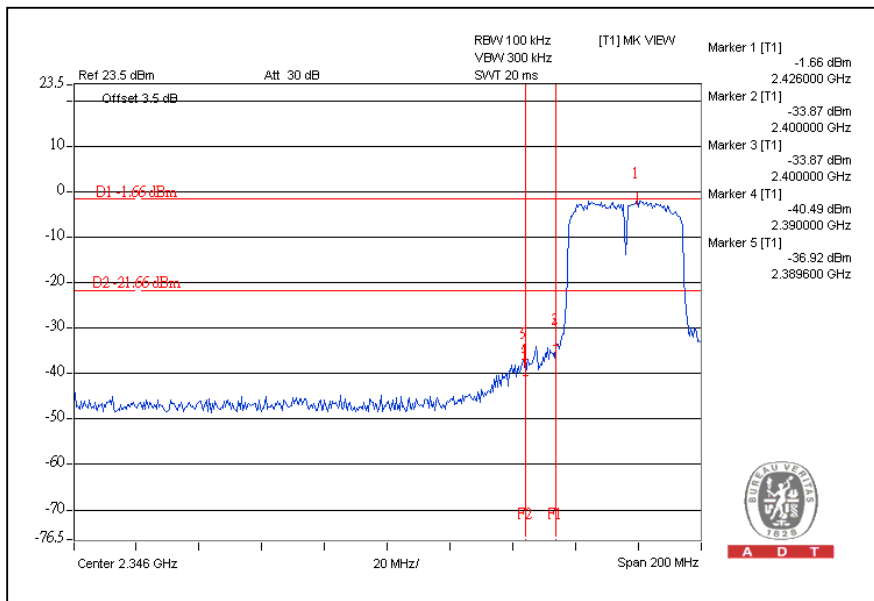

CH7

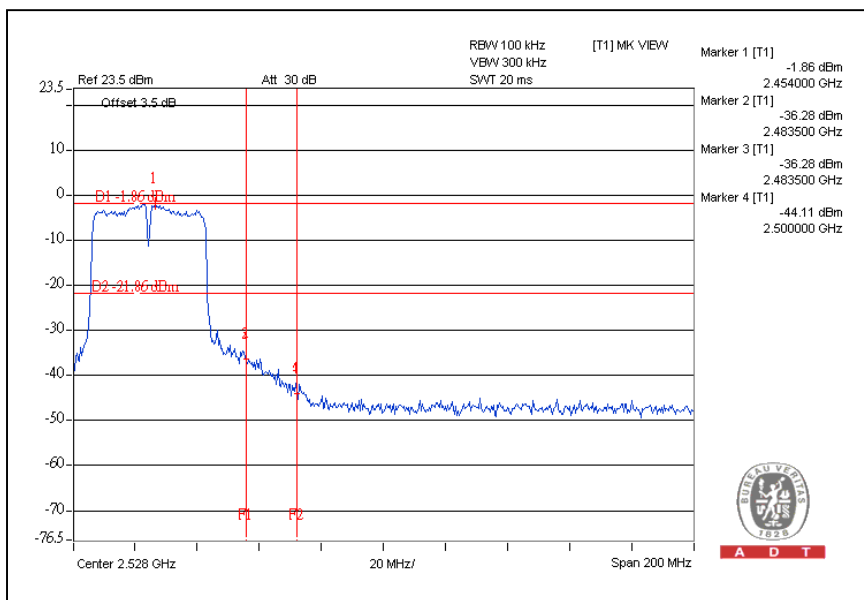



A D T

CH1

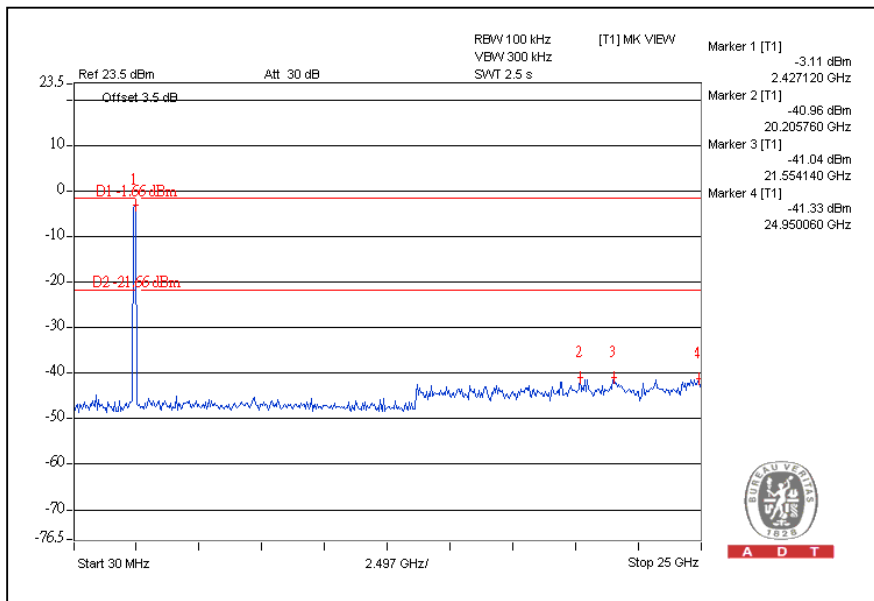

CH7

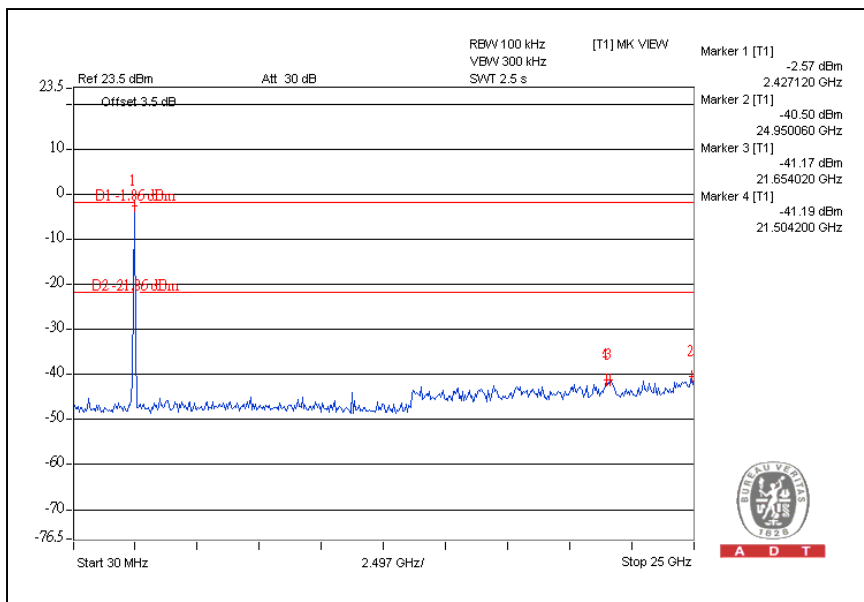



5. TEST TYPES AND RESULTS (802.11a, 5725~5850MHz Band)

5.1 CONDUCTED EMISSION MEASUREMENT

5.1.1 LIMITS OF CONDUCTED EMISSION MEASUREMENT

FREQUENCY OF EMISSION (MHz)	CONDUCTED LIMIT (dBµV)	
	Quasi-peak	Average
0.15-0.5	66 to 56	56 to 46
0.5-5	56	46
5-30	60	50

- NOTE:**
1. The lower limit shall apply at the transition frequencies.
 2. The limit decreases in line with the logarithm of the frequency in the range of 0.15 to 0.50 MHz.
 3. All emanations from a class A/B digital device or system, including any network of conductors and apparatus connected thereto, shall not exceed the level of field strengths specified above.

5.1.2 TEST INSTRUMENTS

DESCRIPTION & MANUFACTURER	MODEL NO.	SERIAL NO.	CALIBRATED DATE	CALIBRATED UNTIL
Test Receiver	ESCS 30	100375	Mar. 23, 2009	Mar. 22, 2010
Line-Impedance Stabilization Network (for Peripheral)	ENV-216	100071	Nov. 30, 2009	Nov. 29, 2010
Line-Impedance Stabilization Network (for EUT)	ESH3-Z5	848773/004	Oct. 26, 2009	Oct. 25, 2010
RF Cable (JYEBAO)	5DFB	COBCAB-001	Aug. 14, 2009	Aug. 13, 2010
50 ohms Terminator	50	3	Oct. 28, 2009	Oct. 27, 2010
Software	BV ADT_ Cond_V7.3.7	NA	NA	NA

Note:

1. The calibration interval of the above test instruments is 12 months and the calibrations are traceable to NML/ROC and NIST/USA.
2. The test was performed in Shielded Room No. B.
- 3 The VCCI Con B Registration No. is C-2193.

5.1.3 TEST PROCEDURES

- a. The EUT was placed 0.4 meters from the conducting wall of the shielded room with EUT being connected to the power mains through a line impedance stabilization network (LISN). Other support units were connected to the power mains through another LISN. The two LISNs provide 50 ohm/ 50uH of coupling impedance for the measuring instrument.
- b. Both lines of the power mains connected to the EUT were checked for maximum conducted interference.
- c. The frequency range from 150kHz to 30MHz was searched. Emission levels under (Limit – 20dB) were not recorded.

5.1.4 DEVIATION FROM TEST STANDARD

No deviation

5.1.5 TEST SETUP

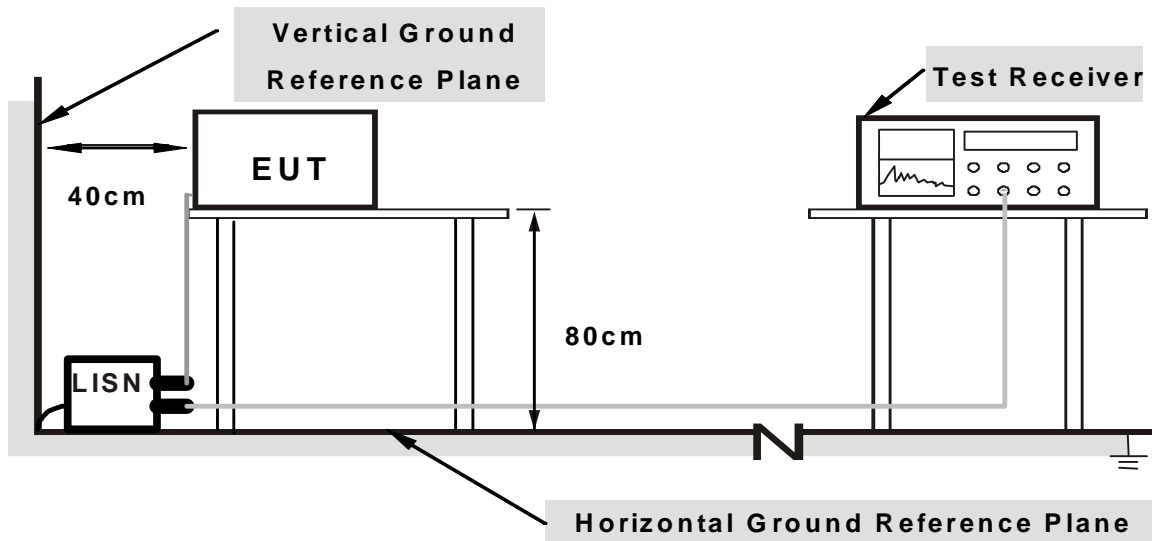

Note: 1. Support units were connected to second LISN.

2. Both of LISNs (AMN) are 80 cm from EUT and at least 80 from other units and other metal planes

For the actual test configuration, please refer to the related item – Photographs of the Test Configuration.

5.1.6 EUT OPERATING CONDITIONS

Same as the 4.1.6

5.1.7 TEST RESULTS

802.11a OFDM MODULATION:

PHASE	Line (L)	6dB BANDWIDTH	9 kHz
--------------	----------	----------------------	-------

No	Freq. [MHz]	Corr. Factor (dB)	Reading Value		Emission Level		Limit		Margin	
			[dB (uV)]		[dB (uV)]		[dB (uV)]		(dB)	
			Q.P.	AV.	Q.P.	AV.	Q.P.	AV.	Q.P.	AV.
1	0.267	9.71	36.48	29.62	46.19	39.33	61.20	51.20	-15.01	-11.87
2	1.800	9.89	31.96	24.66	41.85	34.55	56.00	46.00	-14.15	-11.45
3	1.898	9.89	32.84	25.03	42.73	34.92	56.00	46.00	-13.27	-11.08
4	3.414	9.87	33.54	24.90	43.41	34.77	56.00	46.00	-12.59	-11.23
5	3.781	9.86	32.14	20.71	42.00	30.57	56.00	46.00	-14.00	-15.43
6	4.305	9.88	28.85	23.02	38.73	32.90	56.00	46.00	-17.27	-13.10

- REMARKS:**
1. Q.P. and AV. are abbreviations of quasi-peak and average individually.
 2. "-": The Quasi-peak reading value also meets average limit and measurement with the average detector is unnecessary.
 3. The emission levels of other frequencies were very low against the limit.
 4. Margin value = Emission level - Limit value
 5. Correction factor = Insertion loss + Cable loss
 6. Emission Level = Correction Factor + Reading Value.

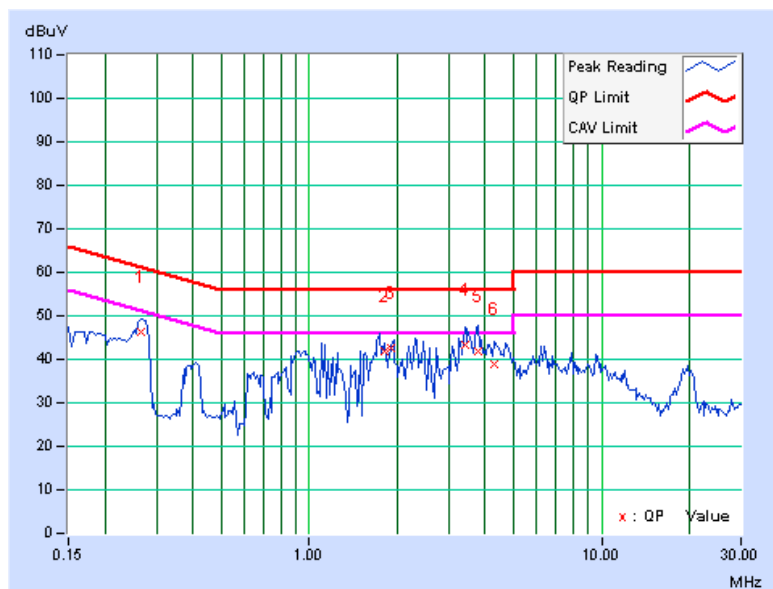

PHASE	Neutral (N)	6dB BANDWIDTH	9 kHz
--------------	-------------	----------------------	-------

No	Freq. [MHz]	Corr. Factor (dB)	Reading Value [dB (uV)]		Emission Level [dB (uV)]		Limit [dB (uV)]		Margin (dB)	
			Q.P.	AV.	Q.P.	AV.	Q.P.	AV.	Q.P.	AV.
			1	0.259	9.71	35.05	28.12	44.76	37.83	61.45
2	1.633	9.88	31.65	23.86	41.53	33.74	56.00	46.00	-14.47	-12.26
3	1.805	9.89	31.82	26.87	41.71	36.76	56.00	46.00	-14.29	-9.24
4	1.906	9.89	34.74	26.29	44.63	36.18	56.00	46.00	-11.37	-9.82
5	2.316	9.89	32.11	26.60	42.00	36.49	56.00	46.00	-14.00	-9.51
6	3.430	9.88	32.16	22.61	42.04	32.49	56.00	46.00	-13.96	-13.51

- REMARKS:**
1. Q.P. and AV. are abbreviations of quasi-peak and average individually.
 2. "-": The Quasi-peak reading value also meets average limit and measurement with the average detector is unnecessary.
 3. The emission levels of other frequencies were very low against the limit.
 4. Margin value = Emission level - Limit value
 5. Correction factor = Insertion loss + Cable loss
 6. Emission Level = Correction Factor + Reading Value.

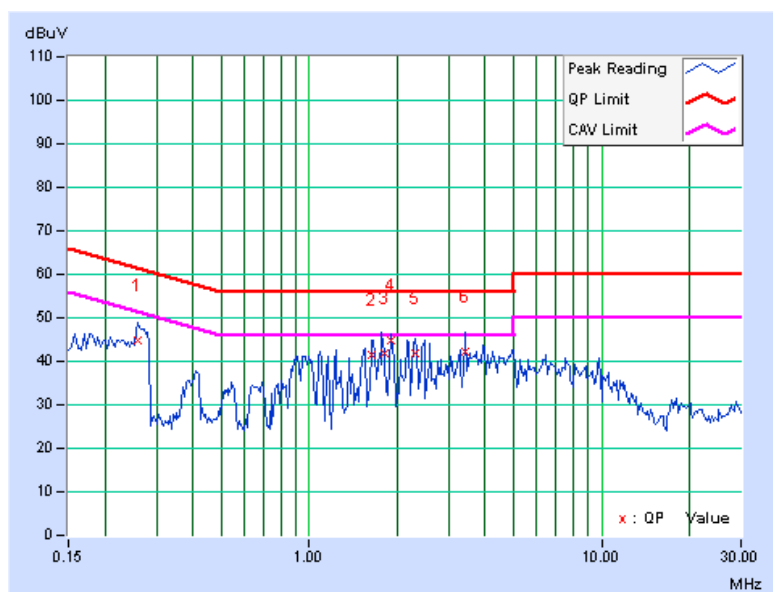

5.2 RADIATED EMISSION MEASUREMENT

5.2.1 LIMITS OF RADIATED EMISSION MEASUREMENT

Emissions radiated outside of the specified bands, shall be according to the general radiated limits in 15.209 as following:

Frequencies (MHz)	Field strength (microvolts/meter)	Measurement distance (meters)
0.009-0.490	2400/F(kHz)	300
0.490-1.705	24000/F(kHz)	30
1.705-30.0	30	30
30-88	100	3
88-216	150	3
216-960	200	3
Above 960	500	3

NOTE:

1. The lower limit shall apply at the transition frequencies.
2. Emission level (dBuV/m) = 20 log Emission level (uV/m).
3. As shown in 15.35(b), for frequencies above 1000MHz, the field strength limits are based on average detector, however, the peak field strength of any emission shall not exceed the maximum permitted average limits, specified above by more than 20dB under any condition of modulation.



A D T

5.2.2 TEST INSTRUMENTS

DESCRIPTION & MANUFACTURER	MODEL NO.	SERIAL NO.	CALIBRATED DATE	CALIBRATED UNTIL
ROHDE & SCHWARZ Spectrum Analyzer	FSP40	100036	Apr. 03 , 2009	Apr. 02 , 2010
Agilent PSA Spectrum Analyzer	E4446A	MY46180622	Apr. 24 , 2009	Apr. 23 , 2010
HP Pre_Amplifier	8449B	3008A01923	Nov. 02, 2009	Nov. 01, 2010
ROHDE & SCHWARZ Test Receiver	ESCS30	847124/029	Aug. 28, 2009	Aug. 28, 2010
SCHWARZBECK TRILOG Broadband Antenna	VULB 9168	138	April 29, 2009	April 28, 2010
Schwarzbeck Horn_Antenna	BBHA9120	D124	Dec. 18, 2009	Dec. 17, 2010
Schwarzbeck Horn_Antenna	BBHA 9170	BBHA9170153	Jan. 22, 2009	Jan. 21, 2010
RF Switches	EMH-011	08009	Sep. 26, 2009	Sep. 25, 2010
RF CABLE (Chaintek)	Sucoflex 106	28077	Aug. 14, 2009	Aug. 13, 2010
RF Cable	8D	STCCAB-001	Sep. 26, 2009	Sep. 25, 2010
Software	ADT_Radiated_V7.6.15.9.2	NA	NA	NA
CT Antenna Tower & Turn Table	NA	NA	NA	NA

Note: 1. The calibration interval of the above test instruments is 12 months and the calibrations are traceable to NML/ROC and NIST/USA.

2. The horn antenna, HP preamplifier (model: 8449B) and Spectrum Analyzer (model: FSP40) are used only for the measurement of emission frequency above 1GHz if tested.
3. The test was performed in Open Site No. C.
4. The FCC Site Registration No. is 656396.
5. The VCCI Site Registration No. is R-1626.
6. The CANADA Site Registration No. is IC 7450G-3.

5.2.3 TEST PROCEDURES

- a. The EUT was placed on the top of a rotating table 0.8 meters above the ground at a 10 meter open area test site. The table was rotated 360 degrees to determine the position of the highest radiation.
- b. The EUT was set 3 meters away from the interference-receiving antenna, which was mounted on the top of a variable-height antenna tower.
- c. The antenna is a broadband antenna, and its height is varied from one meter to four meters above the ground to determine the maximum value of the field strength. Both horizontal and vertical polarizations of the antenna are set to make the measurement.
- d. For each suspected emission, the EUT was arranged to its worst case and then the antenna was tuned to heights from 1 meter to 4 meters and the rotatable table was turned from 0 degrees to 360 degrees to find the maximum reading.
- e. The test-receiver system was set to Peak Detect Function and Specified Bandwidth with Maximum Hold Mode.
- f. If the emission level of the EUT in peak mode was 10dB lower than the limit specified, then testing could be stopped and the peak values of the EUT would be reported. Otherwise the emissions that did not have 10dB margin would be re-tested one by one using peak, quasi-peak or average method as specified and then reported in a data sheet.

NOTE:

1. The resolution bandwidth and video bandwidth of test receiver/spectrum analyzer is 120kHz for Peak detection (PK) and Quasi-peak detection (QP) at frequency below 1GHz.
2. The resolution bandwidth of test receiver/spectrum analyzer is 1 MHz and the video bandwidth is 3 MHz for Peak detection (PK) at frequency above 1GHz.
3. The resolution bandwidth of test receiver/spectrum analyzer is 1 MHz and the video bandwidth is 10 Hz for Average detection (AV) at frequency above 1GHz.

5.2.4 DEVIATION FROM TEST STANDARD

No deviation

5.2.5 TEST SETUP

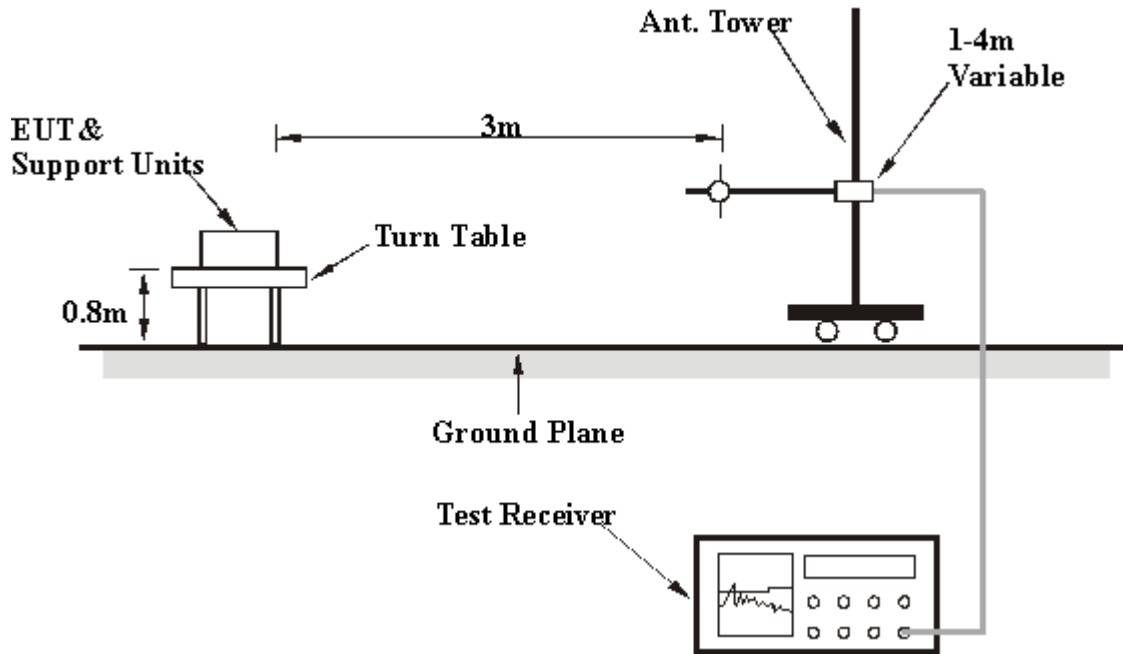

For the actual test configuration, please refer to the related item – Photographs of the Test Configuration.

5.2.6 EUT OPERATING CONDITIONS

Same as the 4.1.6



A D T

5.2.7 TEST RESULTS

BELOW 1GHz WORST-CASE DATA : 802.11n (20MHz) OFDM MODULATION

EUT TEST CONDITION		MEASUREMENT DETAIL	
CHANNEL	Channel 157	FREQUENCY RANGE	Below 1000MHz
INPUT POWER (SYSTEM)	120Vac, 60 Hz	DETECTOR FUNCTION	Quasi-Peak
ENVIRONMENTAL CONDITIONS	11deg. C, 55%RH 1024 hPa	TESTED BY	Wen Yu

ANTENNA POLARITY & TEST DISTANCE: HORIZONTAL AT 3 M								
NO.	FREQ. (MHz)	EMISSION LEVEL (dBuV/m)	LIMIT (dBuV/m)	MARGIN (dB)	ANTENNA HEIGHT (m)	TABLE ANGLE (Degree)	RAW VALUE (dBuV)	CORRECTION FACTOR (dB/m)
1	114.42	19.2 QP	43.5	-24.3	1.00 H	12	7.85	11.38
2	240.00	33.6 QP	46.0	-12.4	1.22 H	91	20.23	13.33
3	360.00	33.6 QP	46.0	-12.4	1.21 H	85	16.11	17.52
4	480.00	42.7 QP	46.0	-3.3	1.84 H	170	21.94	20.74
5	840.00	42.6 QP	46.0	-3.4	1.00 H	211	15.43	27.21
6	960.00	34.7 QP	46.0	-11.4	1.00 H	251	5.97	28.68
ANTENNA POLARITY & TEST DISTANCE: VERTICAL AT 3 M								
NO.	FREQ. (MHz)	EMISSION LEVEL (dBuV/m)	LIMIT (dBuV/m)	MARGIN (dB)	ANTENNA HEIGHT (m)	TABLE ANGLE (Degree)	RAW VALUE (dBuV)	CORRECTION FACTOR (dB/m)
1	240.00	37.3 QP	46.0	-8.7	1.10 V	221	23.93	13.33
2	360.00	42.8 QP	46.0	-3.2	1.00 V	12	25.30	17.52
3	480.00	42.7 QP	46.0	-3.3	1.16 V	54	22.00	20.74
4	600.00	42.7 QP	46.0	-3.3	1.02 V	328	18.82	23.87
5	840.00	42.9 QP	46.0	-3.1	1.00 V	236	15.64	27.21
6	960.00	40.3 QP	46.0	-5.7	1.00 V	25	11.66	28.68

- REMARKS:**
1. Emission level (dBuV/m) = Raw Value (dBuV) + Correction Factor (dB/m).
 2. Correction Factor (dB/m) = Antenna Factor (dB/m) + Cable Factor (dB).
 3. The other emission levels were very low against the limit.
 4. Margin value = Emission level – Limit value.



A D T

ABOVE 1GHz DATA

802.11a OFDM MODULATION

EUT TEST CONDITION		MEASUREMENT DETAIL	
CHANNEL	Channel 149	FREQUENCY RANGE	1 ~ 40GHz
INPUT POWER (SYSTEM)	120Vac, 60 Hz	DETECTOR FUNCTION	Peak (PK) Average (AV)
ENVIRONMENTAL CONDITIONS	20deg. C, 67%RH 1024 hPa	TESTED BY	Eric Lee

ANTENNA POLARITY & TEST DISTANCE: HORIZONTAL AT 3 M								
NO.	FREQ. (MHz)	EMISSION LEVEL (dBuV/m)	LIMIT (dBuV/m)	MARGIN (dB)	ANTENNA HEIGHT (m)	TABLE ANGLE (Degree)	RAW VALUE (dBuV)	CORRECTION FACTOR (dB/m)
1	*5745.00	96.4 PK			1.31 H	263	59.19	37.21
2	*5745.00	87.9 AV			1.31 H	263	50.69	37.21
3	11490.00	54.2 PK	74.0	-19.8	1.29 H	73	7.17	47.03
4	11490.00	44.6 AV	54.0	-9.4	1.29 H	73	-2.43	47.03
ANTENNA POLARITY & TEST DISTANCE: VERTICAL AT 3 M								
NO.	FREQ. (MHz)	EMISSION LEVEL (dBuV/m)	LIMIT (dBuV/m)	MARGIN (dB)	ANTENNA HEIGHT (m)	TABLE ANGLE (Degree)	RAW VALUE (dBuV)	CORRECTION FACTOR (dB/m)
1	*5745.00	104.8 PK			1.28 V	111	67.57	37.21
2	*5745.00	95.9 AV			1.28 V	111	58.66	37.21
3	11490.00	53.9 PK	74.0	-20.1	1.29 V	204	6.84	47.03
4	11490.00	44.7 AV	54.0	-9.3	1.29 V	204	-2.34	47.03

- REMARKS:**
1. Emission level (dBuV/m) = Raw Value (dBuV) + Correction Factor (dB/m).
 2. Correction Factor (dB/m) = Antenna Factor (dB/m) + Cable Factor (dB).
 3. The other emission levels were very low against the limit.
 4. Margin value = Emission level – Limit value.
 5. “ * “: Fundamental frequency.
 6. The limit value is defined as per 15.247.



A D T

EUT TEST CONDITION		MEASUREMENT DETAIL	
CHANNEL	Channel 157	FREQUENCY RANGE	1 ~ 40GHz
INPUT POWER (SYSTEM)	120Vac, 60 Hz	DETECTOR FUNCTION	Peak (PK) Average (AV)
ENVIRONMENTAL CONDITIONS	20deg. C, 67%RH 1024 hPa	TESTED BY	Eric Lee

ANTENNA POLARITY & TEST DISTANCE: HORIZONTAL AT 3 M								
NO.	FREQ. (MHz)	EMISSION LEVEL (dBuV/m)	LIMIT (dBuV/m)	MARGIN (dB)	ANTENNA HEIGHT (m)	TABLE ANGLE (Degree)	RAW VALUE (dBuV)	CORRECTION FACTOR (dB/m)
1	*5785.00	96.8 PK			1.34 H	267	59.49	37.31
2	*5785.00	88.2 AV			1.34 H	267	50.89	37.31
3	11570.00	54.6 PK	74.0	-19.4	1.24 H	89	7.63	46.97
4	11570.00	44.7 AV	54.0	-9.3	1.24 H	89	-2.27	46.97
ANTENNA POLARITY & TEST DISTANCE: VERTICAL AT 3 M								
NO.	FREQ. (MHz)	EMISSION LEVEL (dBuV/m)	LIMIT (dBuV/m)	MARGIN (dB)	ANTENNA HEIGHT (m)	TABLE ANGLE (Degree)	RAW VALUE (dBuV)	CORRECTION FACTOR (dB/m)
1	*5785.00	105.2 PK			1.27 V	120	67.89	37.31
2	*5785.00	95.7 AV			1.27 V	120	58.39	37.31
3	11570.00	54.1 PK	74.0	-19.9	1.30 V	219	7.17	46.97
4	11570.00	45.1 AV	54.0	-8.9	1.30 V	219	-1.86	46.97

- REMARKS:**
1. Emission level (dBuV/m) = Raw Value (dBuV) + Correction Factor (dB/m).
 2. Correction Factor (dB/m) = Antenna Factor (dB/m) + Cable Factor (dB).
 3. The other emission levels were very low against the limit.
 4. Margin value = Emission level – Limit value.
 5. “ * “: Fundamental frequency.
 6. The limit value is defined as per 15.247.



A D T

EUT TEST CONDITION		MEASUREMENT DETAIL	
CHANNEL	Channel 165	FREQUENCY RANGE	1 ~ 40GHz
INPUT POWER (SYSTEM)	120Vac, 60 Hz	DETECTOR FUNCTION	Peak (PK) Average (AV)
ENVIRONMENTAL CONDITIONS	20deg. C, 67%RH 1024 hPa	TESTED BY	Eric Lee

ANTENNA POLARITY & TEST DISTANCE: HORIZONTAL AT 3 M								
NO.	FREQ. (MHz)	EMISSION LEVEL (dBuV/m)	LIMIT (dBuV/m)	MARGIN (dB)	ANTENNA HEIGHT (m)	TABLE ANGLE (Degree)	RAW VALUE (dBuV)	CORRECTION FACTOR (dB/m)
1	*5825.00	97.2 PK			1.28 H	264	59.78	37.42
2	*5825.00	89.4 AV			1.28 H	264	51.98	37.42
3	11650.00	54.7 PK	74.0	-19.3	1.26 H	93	7.80	46.90
4	11650.00	45.1 AV	54.0	-8.9	1.26 H	93	-1.80	46.90
ANTENNA POLARITY & TEST DISTANCE: VERTICAL AT 3 M								
NO.	FREQ. (MHz)	EMISSION LEVEL (dBuV/m)	LIMIT (dBuV/m)	MARGIN (dB)	ANTENNA HEIGHT (m)	TABLE ANGLE (Degree)	RAW VALUE (dBuV)	CORRECTION FACTOR (dB/m)
1	*5825.00	105.1 PK			1.36 V	200	67.69	37.42
2	*5825.00	96.0 AV			1.36 V	200	58.55	37.42
3	11650.00	53.9 PK	74.0	-20.1	1.20 V	228	6.97	46.90
4	11650.00	44.9 AV	54.0	-9.1	1.20 V	228	-2.03	46.90

- REMARKS:**
1. Emission level (dBuV/m) = Raw Value (dBuV) + Correction Factor (dB/m).
 2. Correction Factor (dB/m) = Antenna Factor (dB/m) + Cable Factor (dB).
 3. The other emission levels were very low against the limit.
 4. Margin value = Emission level – Limit value.
 5. “ * “: Fundamental frequency.
 6. The limit value is defined as per 15.247.



A D T

802.11n (20MHz) OFDM MODULATION

EUT TEST CONDITION		MEASUREMENT DETAIL	
CHANNEL	Channel 149	FREQUENCY RANGE	1 ~ 40GHz
INPUT POWER (SYSTEM)	120Vac, 60 Hz	DETECTOR FUNCTION	Peak (PK) Average (AV)
ENVIRONMENTAL CONDITIONS	20deg. C, 67%RH 1024 hPa	TESTED BY	Eric Lee

ANTENNA POLARITY & TEST DISTANCE: HORIZONTAL AT 3 M								
NO.	FREQ. (MHz)	EMISSION LEVEL (dBuV/m)	LIMIT (dBuV/m)	MARGIN (dB)	ANTENNA HEIGHT (m)	TABLE ANGLE (Degree)	RAW VALUE (dBuV)	CORRECTION FACTOR (dB/m)
1	*5745.00	96.4 PK			1.00 H	44	59.19	37.21
2	*5745.00	87.2 AV			1.00 H	44	49.99	37.21
3	11490.00	56.3 PK	74.0	-17.7	1.62 H	321	9.27	47.03
4	11490.00	43.7 AV	54.0	-10.3	1.62 H	321	-3.33	47.03
ANTENNA POLARITY & TEST DISTANCE: VERTICAL AT 3 M								
NO.	FREQ. (MHz)	EMISSION LEVEL (dBuV/m)	LIMIT (dBuV/m)	MARGIN (dB)	ANTENNA HEIGHT (m)	TABLE ANGLE (Degree)	RAW VALUE (dBuV)	CORRECTION FACTOR (dB/m)
1	*5745.00	105.1 PK			1.38 V	22	67.87	37.21
2	*5745.00	95.4 AV			1.38 V	22	58.17	37.21
3	11490.00	55.8 PK	74.0	-18.2	1.49 V	82	8.73	47.03
4	11490.00	45.6 AV	54.0	-8.4	1.49 V	82	-1.40	47.03

- REMARKS:**
1. Emission level (dBuV/m) = Raw Value (dBuV) + Correction Factor (dB/m).
 2. Correction Factor (dB/m) = Antenna Factor (dB/m) + Cable Factor (dB).
 3. The other emission levels were very low against the limit.
 4. Margin value = Emission level – Limit value.
 5. “ * “: Fundamental frequency.
 6. The limit value is defined as per 15.247.



A D T

EUT TEST CONDITION		MEASUREMENT DETAIL	
CHANNEL	Channel 157	FREQUENCY RANGE	1 ~ 40GHz
INPUT POWER (SYSTEM)	120Vac, 60 Hz	DETECTOR FUNCTION	Peak (PK) Average (AV)
ENVIRONMENTAL CONDITIONS	20deg. C, 67%RH 1024 hPa	TESTED BY	Eric Lee

ANTENNA POLARITY & TEST DISTANCE: HORIZONTAL AT 3 M								
NO.	FREQ. (MHz)	EMISSION LEVEL (dBuV/m)	LIMIT (dBuV/m)	MARGIN (dB)	ANTENNA HEIGHT (m)	TABLE ANGLE (Degree)	RAW VALUE (dBuV)	CORRECTION FACTOR (dB/m)
1	*5785.00	96.8 PK			1.02 H	49	59.49	37.31
2	*5785.00	87.6 AV			1.02 H	49	50.29	37.31
3	11570.00	56.9 PK	74.0	-17.1	1.62 H	336	9.93	46.97
4	11570.00	44.2 AV	54.0	-9.8	1.62 H	336	-2.77	46.97
ANTENNA POLARITY & TEST DISTANCE: VERTICAL AT 3 M								
NO.	FREQ. (MHz)	EMISSION LEVEL (dBuV/m)	LIMIT (dBuV/m)	MARGIN (dB)	ANTENNA HEIGHT (m)	TABLE ANGLE (Degree)	RAW VALUE (dBuV)	CORRECTION FACTOR (dB/m)
1	*5785.00	104.3 PK			1.40 V	90	67.02	37.31
2	*5785.00	95.4 AV			1.40 V	90	58.12	37.31
3	11570.00	55.7 PK	74.0	-18.3	1.24 V	111	8.72	46.97
4	11570.00	45.8 AV	54.0	-8.2	1.24 V	111	-1.21	46.97

- REMARKS:**
1. Emission level (dBuV/m) = Raw Value (dBuV) + Correction Factor (dB/m).
 2. Correction Factor (dB/m) = Antenna Factor (dB/m) + Cable Factor (dB).
 3. The other emission levels were very low against the limit.
 4. Margin value = Emission level – Limit value.
 5. “ * “: Fundamental frequency.
 6. The limit value is defined as per 15.247.



A D T

EUT TEST CONDITION		MEASUREMENT DETAIL	
CHANNEL	Channel 165	FREQUENCY RANGE	1 ~ 40GHz
INPUT POWER (SYSTEM)	120Vac, 60 Hz	DETECTOR FUNCTION	Peak (PK) Average (AV)
ENVIRONMENTAL CONDITIONS	20deg. C, 67%RH 1024 hPa	TESTED BY	Eric Lee

ANTENNA POLARITY & TEST DISTANCE: HORIZONTAL AT 3 M								
NO.	FREQ. (MHz)	EMISSION LEVEL (dBuV/m)	LIMIT (dBuV/m)	MARGIN (dB)	ANTENNA HEIGHT (m)	TABLE ANGLE (Degree)	RAW VALUE (dBuV)	CORRECTION FACTOR (dB/m)
1	*5825.00	96.9 PK			1.06 H	59	59.48	37.42
2	*5825.00	87.7 AV			1.06 H	59	50.28	37.42
3	11650.00	57.2 PK	74.0	-16.8	1.63 H	321	10.30	46.90
4	11650.00	44.6 AV	54.0	-9.4	1.63 H	321	-2.30	46.90
ANTENNA POLARITY & TEST DISTANCE: VERTICAL AT 3 M								
NO.	FREQ. (MHz)	EMISSION LEVEL (dBuV/m)	LIMIT (dBuV/m)	MARGIN (dB)	ANTENNA HEIGHT (m)	TABLE ANGLE (Degree)	RAW VALUE (dBuV)	CORRECTION FACTOR (dB/m)
1	*5825.00	103.6 PK			1.38 V	94	66.20	37.42
2	*5825.00	94.9 AV			1.38 V	94	57.45	37.42
3	11650.00	56.3 PK	74.0	-17.7	1.30 V	84	9.41	46.90
4	11650.00	44.8 AV	54.0	-9.2	1.30 V	84	-2.10	46.90

- REMARKS:**
1. Emission level (dBuV/m) = Raw Value (dBuV) + Correction Factor (dB/m).
 2. Correction Factor (dB/m) = Antenna Factor (dB/m) + Cable Factor (dB).
 3. The other emission levels were very low against the limit.
 4. Margin value = Emission level – Limit value.
 5. “ * “: Fundamental frequency.
 6. The limit value is defined as per 15.247.



A D T

802.11n (40MHz) OFDM MODULATION

EUT TEST CONDITION		MEASUREMENT DETAIL	
CHANNEL	Channel 151	FREQUENCY RANGE	1 ~ 40GHz
INPUT POWER (SYSTEM)	120Vac, 60 Hz	DETECTOR FUNCTION	Peak (PK) Average (AV)
ENVIRONMENTAL CONDITIONS	20deg. C, 67%RH 1024 hPa	TESTED BY	Eric Lee

ANTENNA POLARITY & TEST DISTANCE: HORIZONTAL AT 3 M								
NO.	FREQ. (MHz)	EMISSION LEVEL (dBuV/m)	LIMIT (dBuV/m)	MARGIN (dB)	ANTENNA HEIGHT (m)	TABLE ANGLE (Degree)	RAW VALUE (dBuV)	CORRECTION FACTOR (dB/m)
1	*5755.00	100.2 PK			1.13 H	359	62.97	37.23
2	*5755.00	90.4 AV			1.13 H	359	53.17	37.23
3	11510.00	58.3 PK	74.0	-15.7	1.56 H	324	11.28	47.02
4	11510.00	45.2 AV	54.0	-8.8	1.56 H	324	-1.82	47.02
ANTENNA POLARITY & TEST DISTANCE: VERTICAL AT 3 M								
NO.	FREQ. (MHz)	EMISSION LEVEL (dBuV/m)	LIMIT (dBuV/m)	MARGIN (dB)	ANTENNA HEIGHT (m)	TABLE ANGLE (Degree)	RAW VALUE (dBuV)	CORRECTION FACTOR (dB/m)
1	*5755.00	105.6 PK			1.17 V	129	68.37	37.23
2	*5755.00	97.8 AV			1.17 V	129	60.57	37.23
3	11510.00	55.6 PK	74.0	-18.4	1.54 V	0	8.58	47.02
4	11510.00	44.9 AV	54.0	-9.1	1.54 V	0	-2.12	47.02
5	#17265.00	61.2 PK	85.6	-24.4	1.06 V	31	10.54	50.66
6	#17265.00	49.3 AV	77.8	-28.5	1.06 V	31	-1.36	50.66

- REMARKS:**
1. Emission level (dBuV/m) = Raw Value (dBuV) + Correction Factor (dB/m).
 2. Correction Factor (dB/m) = Antenna Factor (dB/m) + Cable Factor (dB).
 3. The other emission levels were very low against the limit.
 4. Margin value = Emission level – Limit value.
 5. “ * “: Fundamental frequency.
 6. The limit value is defined as per 15.247.
 7. “#“:The radiated frequency is out the restricted band.



A D T

EUT TEST CONDITION		MEASUREMENT DETAIL	
CHANNEL	Channel 159	FREQUENCY RANGE	1 ~ 40GHz
INPUT POWER (SYSTEM)	120Vac, 60 Hz	DETECTOR FUNCTION	Peak (PK) Average (AV)
ENVIRONMENTAL CONDITIONS	20deg. C, 67%RH 1024 hPa	TESTED BY	Eric Lee

ANTENNA POLARITY & TEST DISTANCE: HORIZONTAL AT 3 M								
NO.	FREQ. (MHz)	EMISSION LEVEL (dBuV/m)	LIMIT (dBuV/m)	MARGIN (dB)	ANTENNA HEIGHT (m)	TABLE ANGLE (Degree)	RAW VALUE (dBuV)	CORRECTION FACTOR (dB/m)
1	*5795.00	100.6 PK			1.17 H	324	63.26	37.34
2	*5795.00	90.2 AV			1.17 H	324	52.86	37.34
3	11590.00	59.2 PK	74.0	-14.8	1.54 H	327	12.25	46.95
4	11590.00	45.6 AV	54.0	-8.4	1.54 H	327	-1.35	46.95

ANTENNA POLARITY & TEST DISTANCE: VERTICAL AT 3 M								
NO.	FREQ. (MHz)	EMISSION LEVEL (dBuV/m)	LIMIT (dBuV/m)	MARGIN (dB)	ANTENNA HEIGHT (m)	TABLE ANGLE (Degree)	RAW VALUE (dBuV)	CORRECTION FACTOR (dB/m)
1	*5795.00	105.7 PK			1.14 V	126	68.36	37.34
2	*5795.00	98.1 AV			1.14 V	126	60.76	37.34
3	11590.00	56.2 PK	74.0	-17.8	1.59 V	2	9.25	46.95
4	11590.00	45.3 AV	54.0	-8.7	1.59 V	2	-1.65	46.95
5	#17385.00	61.6 PK	85.7	-24.1	1.04 V	29	10.33	51.27
6	#17385.00	49.7 AV	78.1	-28.4	1.04 V	29	-1.57	51.27

- REMARKS:**
1. Emission level (dBuV/m) = Raw Value (dBuV) + Correction Factor (dB/m).
 2. Correction Factor (dB/m) = Antenna Factor (dB/m) + Cable Factor (dB).
 3. The other emission levels were very low against the limit.
 4. Margin value = Emission level – Limit value.
 5. “ * “: Fundamental frequency.
 6. The limit value is defined as per 15.247.
 7. "#":The radiated frequency is out the restricted band.



5.3 6dB BANDWIDTH MEASUREMENT

5.3.1 LIMITS OF 6dB BANDWIDTH MEASUREMENT

The minimum of 6dB Bandwidth Measurement is 0.5 MHz.

5.3.2 TEST INSTRUMENTS

DESCRIPTION & MANUFACTURER	MODEL NO.	SERIAL NO.	CALIBRATED DATE	CALIBRATED UNTIL
R&S SPECTRUM ANALYZER	FSP40	100037	Aug. 03, 2009	Aug. 02, 2010

NOTE:

- 1.The calibration interval of the above test instruments is 12 months and the calibrations are traceable to NML/ROC and NIST/USA.

5.3.3 TEST PROCEDURE

The transmitter output was connected to the spectrum analyzer through an attenuator. The bandwidth of the fundamental frequency was measured by spectrum analyzer with 100kHz RBW and 100kHz VBW. The 6dB bandwidth is defined as the total spectrum the power of which is higher than peak power minus 6dB.

5.3.4 DEVIATION FROM TEST STANDARD

No deviation

5.3.5 TEST SETUP

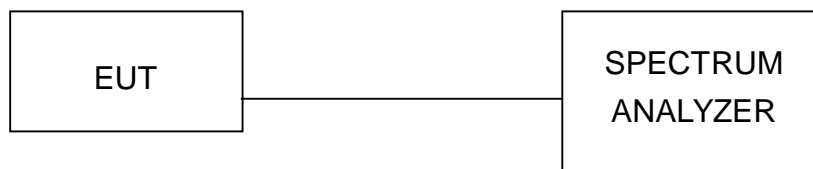

5.3.6 EUT OPERATING CONDITIONS

The software provided by client to enable the EUT under transmission condition continuously at lowest, middle and highest channel frequencies individually.



A D T

5.3.7 TEST RESULTS

802.11a OFDM MODULATION:

CHANNEL	CHANNEL FREQUENCY (MHz)	6dB BANDWIDTH (MHz)	MINIMUM LIMIT (MHz)	PASS / FAIL
149	5745	16.47	0.5	PASS
157	5785	16.47	0.5	PASS
165	5825	16.49	0.5	PASS

CH165

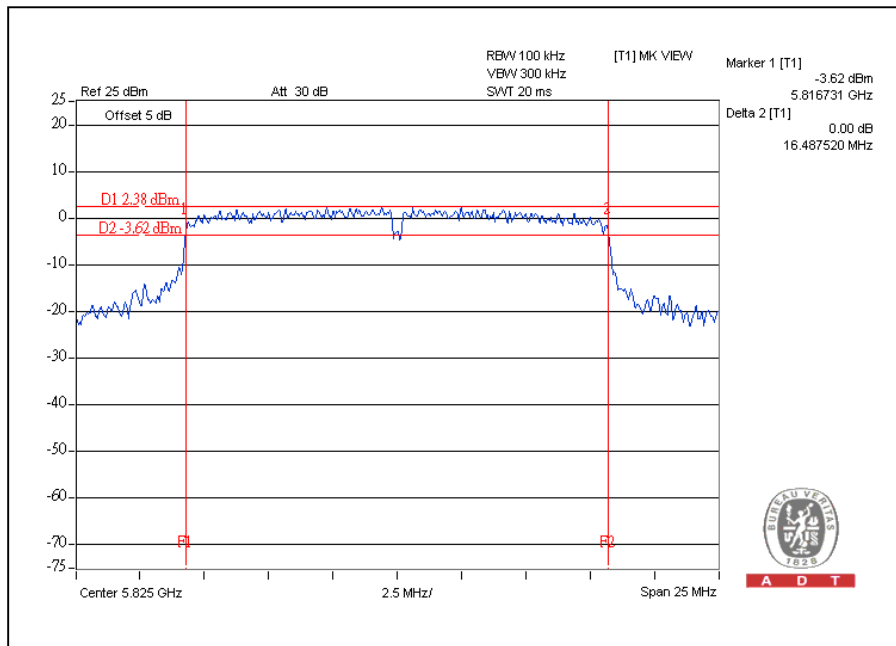

802.11n (20MHz) OFDM MODULATION:

CHANNEL	CHANNEL FREQUENCY (MHz)	6dB BANDWIDTH (MHz)	MINIMUM LIMIT (MHz)	PASS / FAIL
149	5745	17.64	0.5	PASS
157	5785	17.68	0.5	PASS
165	5825	17.28	0.5	PASS

CH157

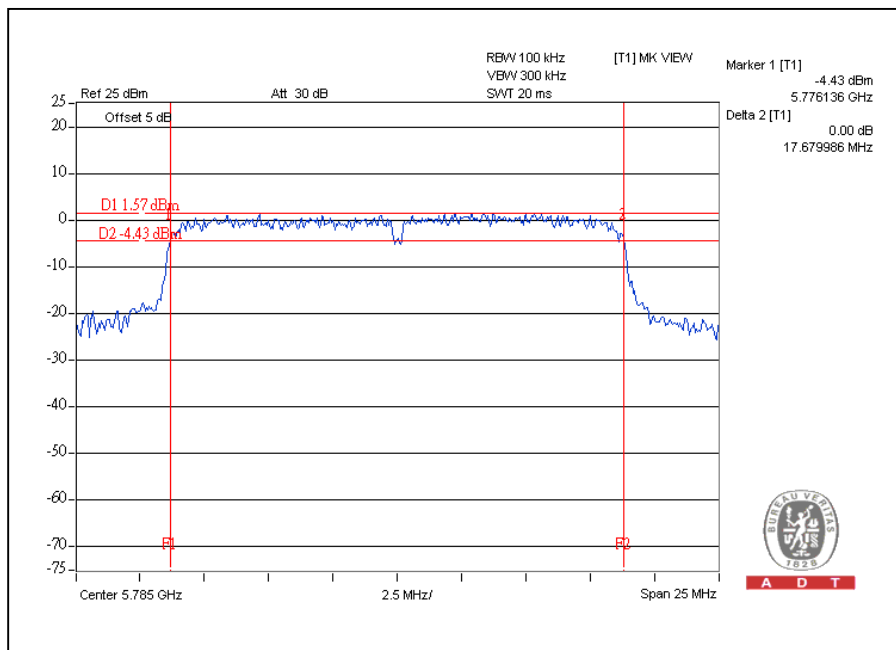

802.11n (40MHz) OFDM MODULATION:

CHANNEL	CHANNEL FREQUENCY (MHz)	6dB BANDWIDTH (MHz)	MINIMUM LIMIT (MHz)	PASS / FAIL
151	5755	36.43	0.5	PASS
159	5795	36.12	0.5	PASS

CH151

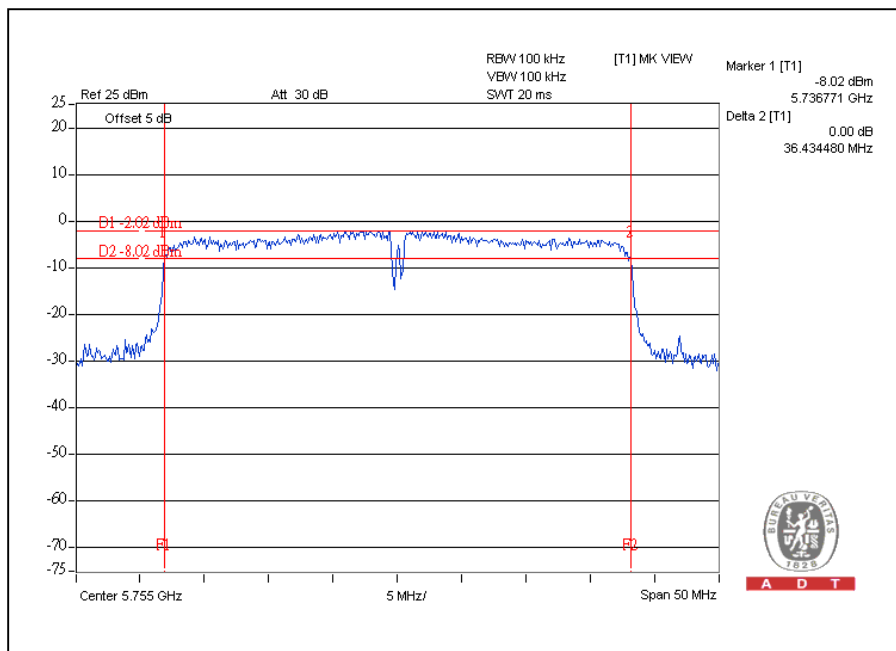

5.4 MAXIMUM PEAK OUTPUT POWER

5.4.1 LIMITS OF MAXIMUM PEAK OUTPUT POWER MEASUREMENT

The Maximum Peak Output Power Measurement is 30dBm.

5.4.2 INSTRUMENTS

DESCRIPTION & MANUFACTURER	MODEL NO.	SERIAL NO.	CALIBRATED DATE	CALIBRATED UNTIL
Anritsu Power Meter	ML2495A	0824006	April 25, 2009	April 24, 2010
Pulse Power Sensor	MA2411B	0738172	April 25, 2009	April 24, 2010

NOTE:

The calibration interval of the above test instruments is 12 months and the calibrations are traceable to NML/ROC and NIST/USA.

5.4.3 TEST PROCEDURES

1. The transmitter output was connected to the power meter through an attenuator; the bandwidth of the fundamental frequency was measured with the power meter.
2. Record the power level.

5.4.4 DEVIATION FROM TEST STANDARD

No deviation

5.4.5 TEST SETUP

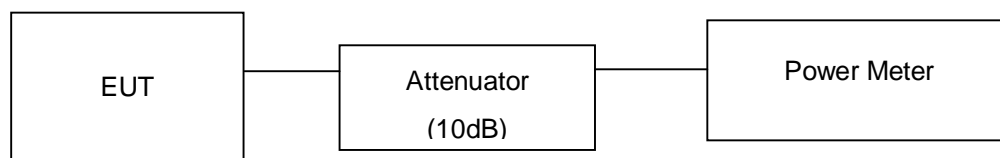

5.4.6 EUT OPERATING CONDITIONS

Same as Item 4.3.6

5.4.7 TEST RESULTS

802.11a OFDM modulation

CHANNEL	CHANNEL FREQUENCY (MHz)	PEAK POWER OUTPUT (dBm)	PEAK POWER OUTPUT (mW)	PEAK POWER LIMIT (dBm)	PASS / FAIL
149	5745	21.6	144.5	30	PASS
157	5785	21.7	147.9	30	PASS
165	5825	21.3	134.9	30	PASS

802.11n (20MHz) OFDM MODULATION:

CHANNEL	CHANNEL FREQUENCY (MHz)	PEAK POWER OUTPUT (dBm)		TOTAL PEAK POWER (mW)	TOTAL PEAK POWER (dBm)	PEAK POWER LIMIT (dBm)	PASS / FAIL
		CHAIN(0)	CHAIN(1)				
149	5745	22.0	21.6	303.0	24.8	30	PASS
157	5785	21.8	21.5	292.6	24.7	30	PASS
165	5825	21.3	21.0	260.8	24.2	30	PASS

802.11n (40MHz) OFDM MODULATION:

CHANNEL	CHANNEL FREQUENCY (MHz)	PEAK POWER OUTPUT (dBm)		TOTAL PEAK POWER (mW)	TOTAL PEAK POWER (dBm)	PEAK POWER LIMIT (dBm)	PASS / FAIL
		CHAIN(0)	CHAIN(1)				
151	5755	21.7	21.0	273.8	24.4	30	PASS
159	5795	21.4	20.9	261.1	24.2	30	PASS



A D T

5.5 POWER SPECTRAL DENSITY MEASUREMENT

5.5.1 LIMITS OF POWER SPECTRAL DENSITY MEASUREMENT

The Maximum of Power Spectral Density Measurement is 8dBm.

5.5.2 TEST INSTRUMENTS

DESCRIPTION & MANUFACTURER	MODEL NO.	SERIAL NO.	CALIBRATED DATE	CALIBRATED UNTIL
R&S SPECTRUM ANALYZER	FSP40	100037	Aug. 03, 2009	Aug. 02, 2010

NOTE:

1. The calibration interval of the above test instruments is 12 months and the calibrations are traceable to NML/ROC and NIST/USA.

5.5.3 TEST PROCEDURE

The transmitter output was connected to the spectrum analyzer through an attenuator, the bandwidth of the fundamental frequency was measured with the spectrum analyzer using 3 kHz RBW and 30 kHz VBW, set sweep time = span/3 kHz. The power spectral density was measured and recorded.

The sweep time is allowed to be longer than span/3 kHz for a full response of the mixer in the spectrum analyzer.

5.5.4 DEVIATION FROM TEST STANDARD

No deviation

5.5.5 TEST SETUP

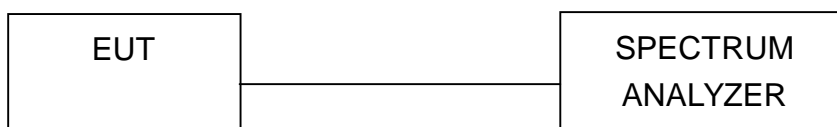

5.5.6 EUT OPERATING CONDITION

Same as Item 4.3.6



A D T

5.5.7 TEST RESULTS

802.11a OFDM modulation

CHANNEL	CHANNEL FREQUENCY (MHz)	RF POWER LEVEL IN 3kHz BW (dBm)	MAXIMUM LIMIT (dBm)	PASS / FAIL
149	5745	-12.5	8	PASS
157	5785	-12.7	8	PASS
165	5825	-10.0	8	PASS

CH165

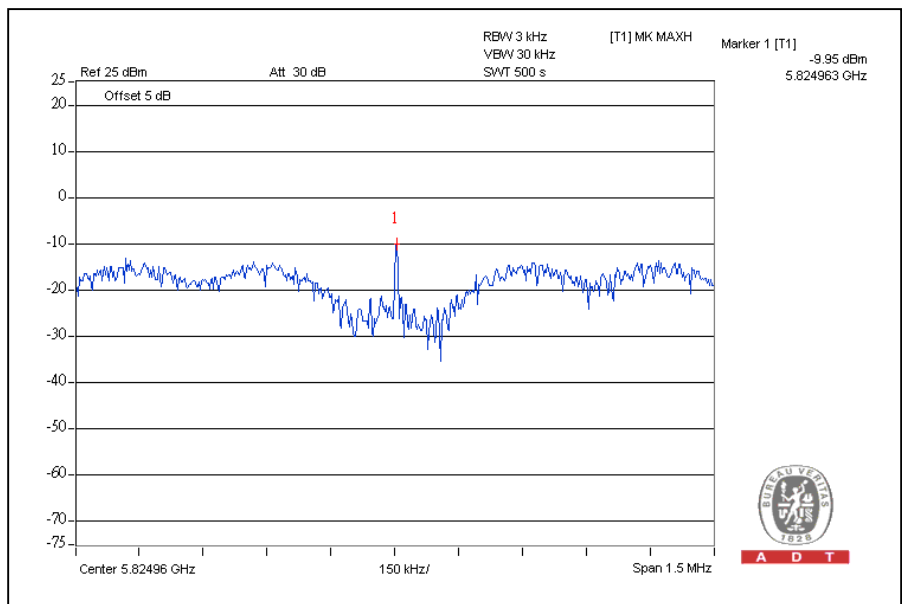



A D T

802.11n (20MHz) OFDM MODULATION:

CHANNEL	CHANNEL FREQUENCY (MHz)	RF POWER LEVEL IN 3kHz BW (dBm)		TOTAL POWER DENSITY (dBm)	MAXIMUM LIMIT (dBm)	PASS / FAIL
		CHAIN(0)	CHAIN(1)			
149	5745	-10.6	-10.6	-7.6	8	PASS
157	5785	-10.9	-10.2	-7.5	8	PASS
165	5825	-10.2	-10.5	-7.4	8	PASS

For Chain(1): CH157

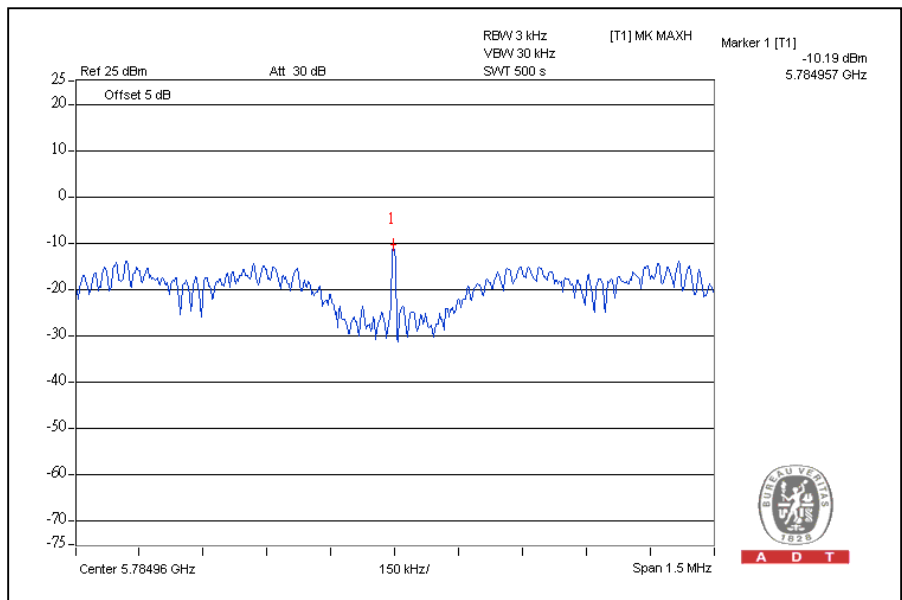

802.11n (40MHz) OFDM MODULATION:

CHANNEL	CHANNEL FREQUENCY (MHz)	RF POWER LEVEL IN 3kHz BW (dBm)		TOTAL POWER DENSITY (dBm)	MAXIMUM LIMIT (dBm)	PASS / FAIL
		CHAIN(0)	CHAIN(1)			
151	5755	-9.5	-10.1	-6.80	8	PASS
159	5795	-10.3	-9.6	-6.90	8	PASS

For Chain(0): CH151

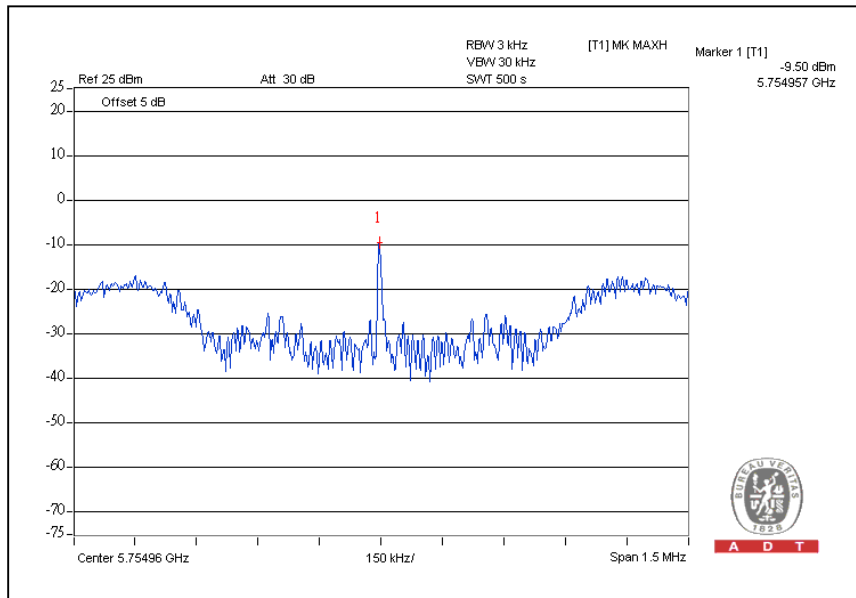



A D T

5.6 CONDUCTED OUT-BAND EMISSION MEASUREMENT

5.6.1 LIMITS OF CONDUCTED OUT-BAND EMISSION MEASUREMENT

Below -20dB of the highest emission level of operating band (in 100kHz Resolution Bandwidth).

5.6.2 TEST INSTRUMENTS

DESCRIPTION & MANUFACTURER	MODEL NO.	SERIAL NO.	CALIBRATED DATE	CALIBRATED UNTIL
R&S SPECTRUM ANALYZER	FSP40	100037	Aug. 03, 2009	Aug. 02, 2010

NOTE:

1. The calibration interval of the above test instruments is 12 months and the calibrations are traceable to NML/ROC and NIST/USA.

5.6.3 TEST PROCEDURE

The transmitter output was connected to the spectrum analyzer via a low loss cable. Set RBW of spectrum analyzer to 100 kHz with suitable frequency span including 100 MHz bandwidth from band edge. The band edges was measured and recorded.

5.6.4 DEVIATION FROM TEST STANDARD

No deviation

5.6.5 EUT OPERATING CONDITION

Same as Item 4.3.6

5.6.6 TEST RESULTS

The spectrum plots are attached on the following pages. D2 line indicates the highest level, D1 line indicates the 20dB offset below D2. It shows compliance with the requirement in part 15.247(d).



A D T

802.11a OFDM modulation

CH149

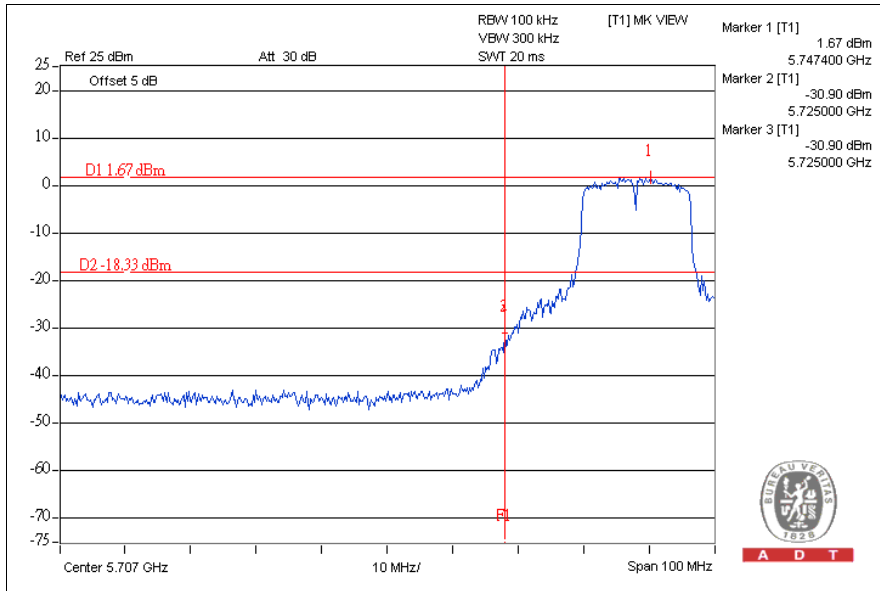

CH165

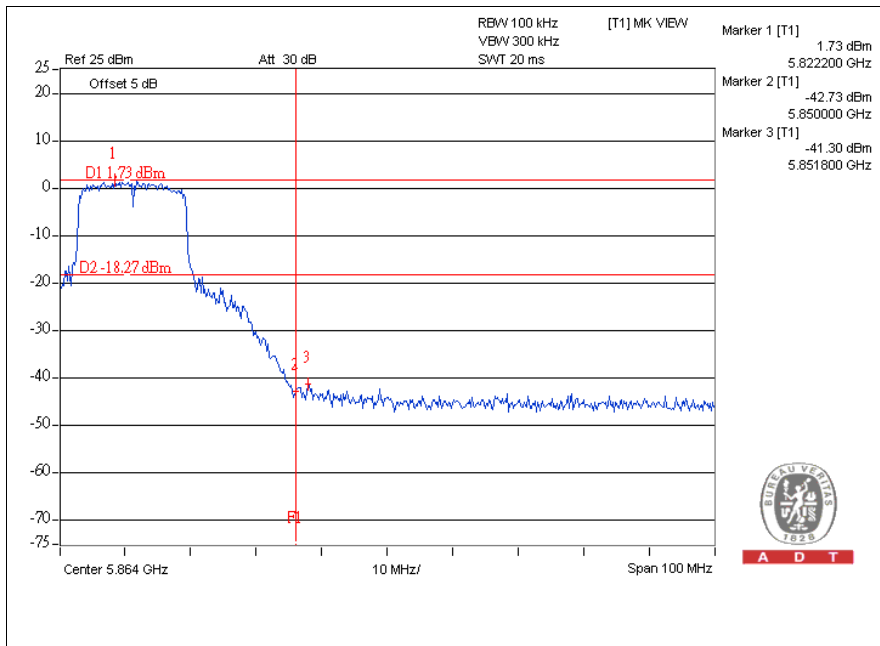



A D T

CH149

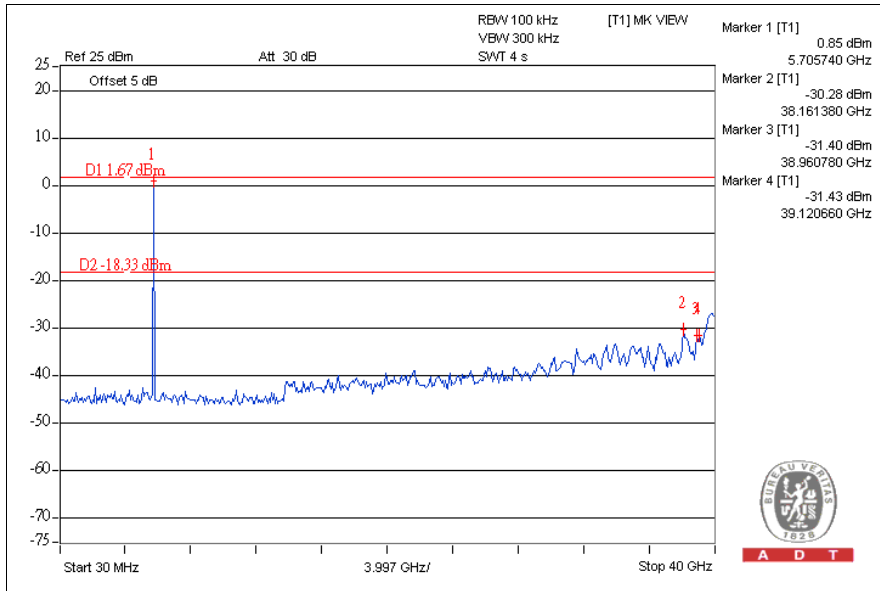

CH165

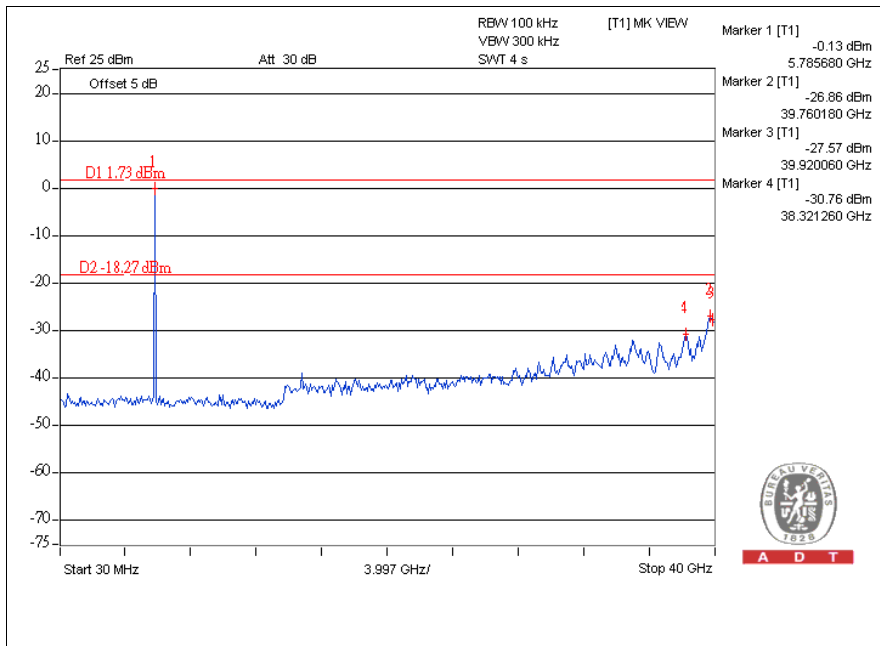



A D T

802.11n (20MHz) OFDM MODULATION:

CH149

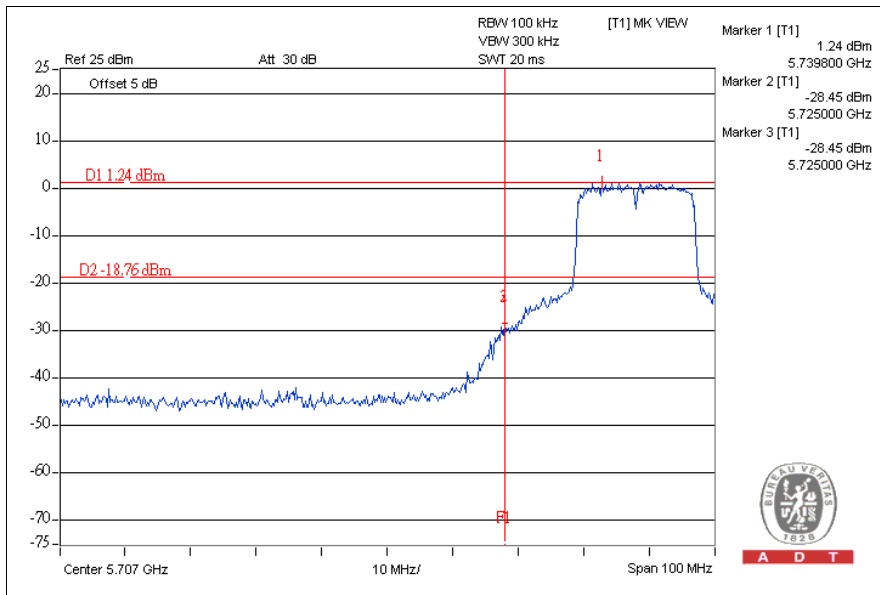

CH165

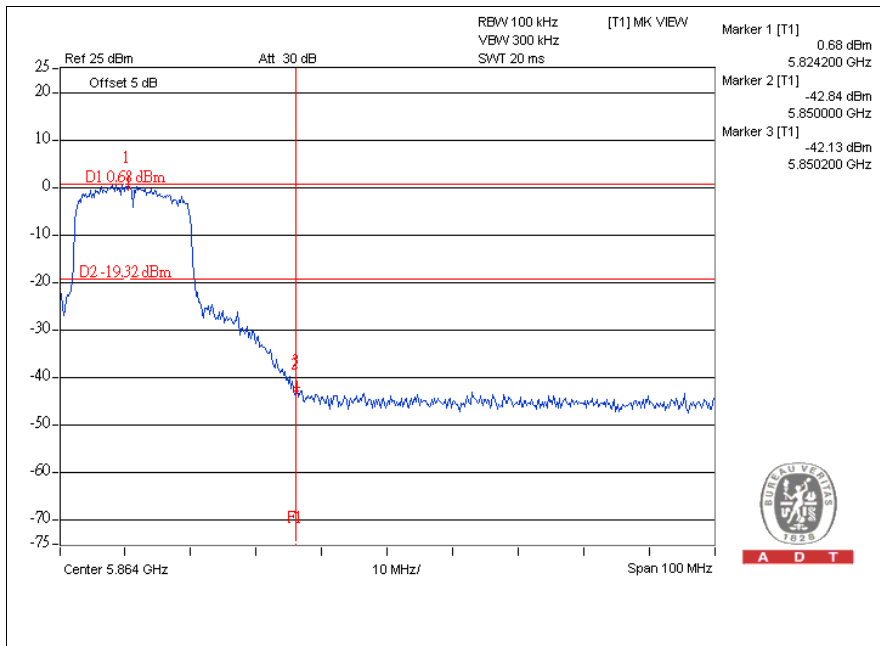



A D T

CH149

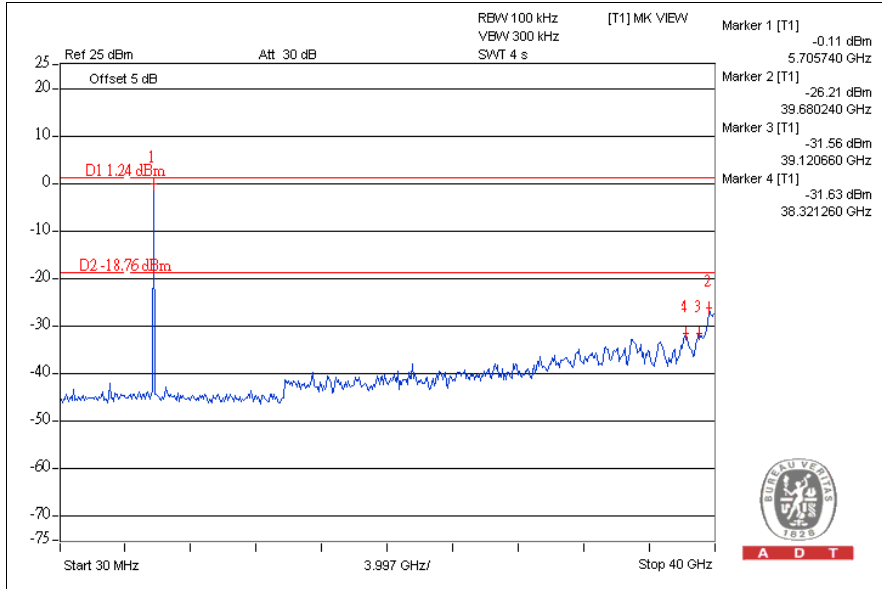

CH165

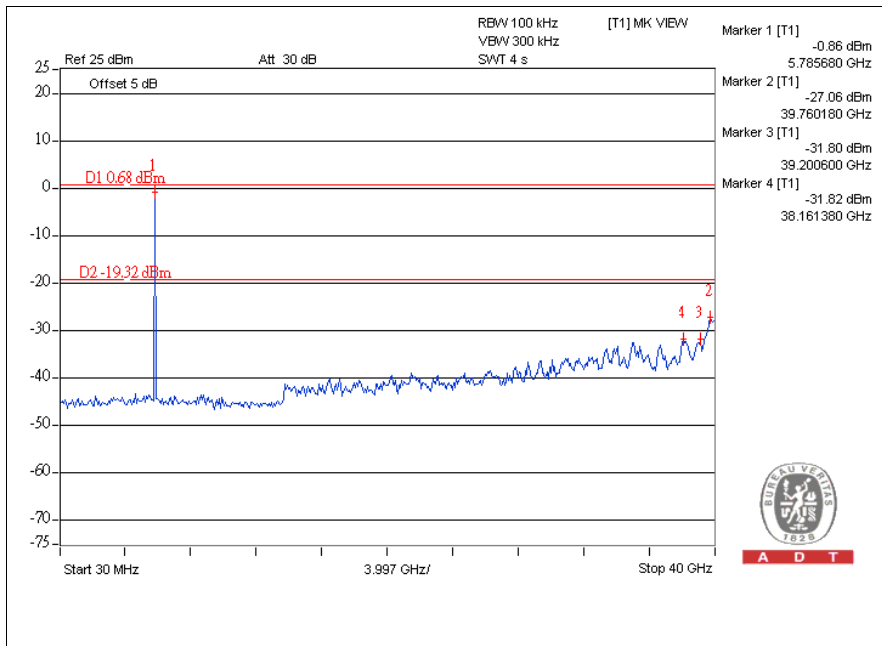



A D T

802.11n (40MHz) OFDM MODULATION:

CH151

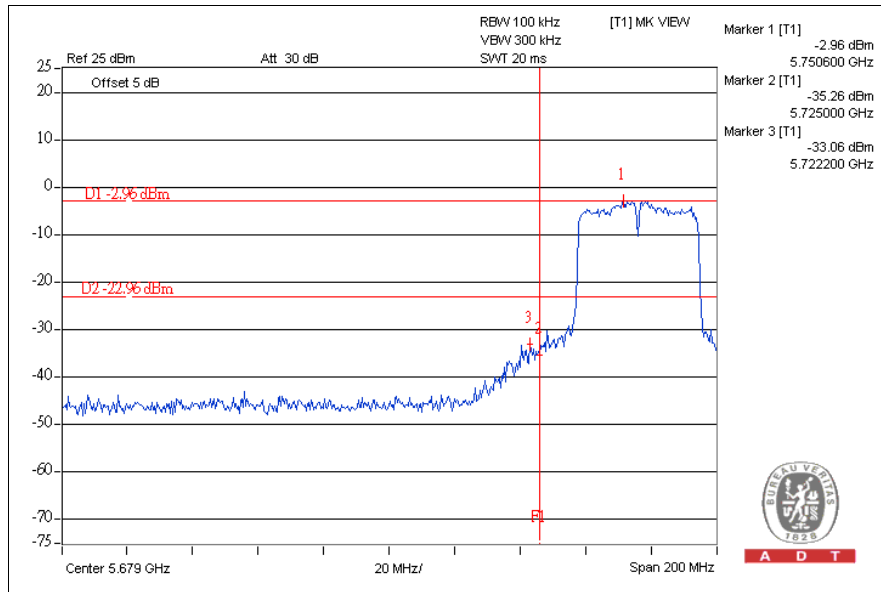

CH159

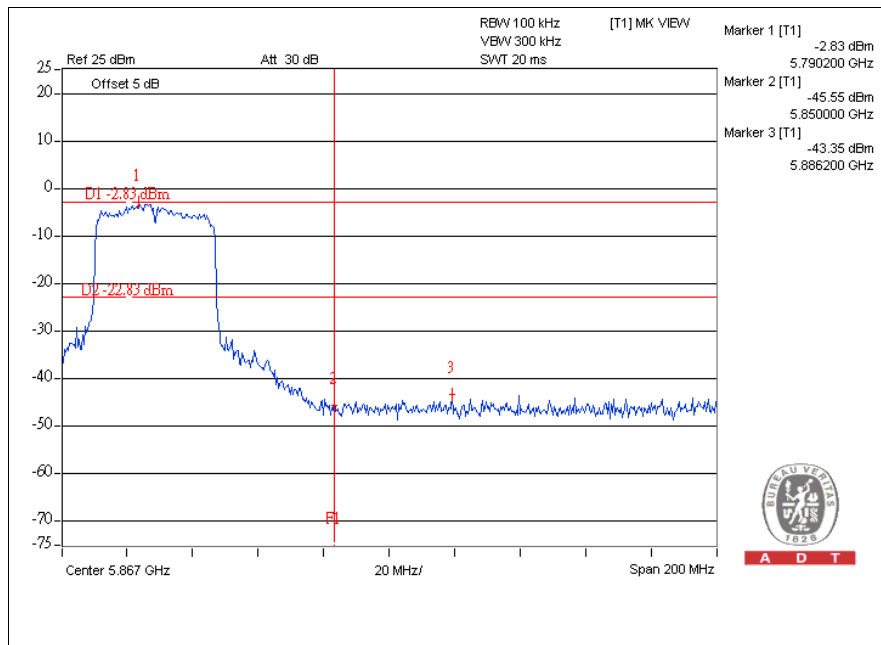



A D T

CH151

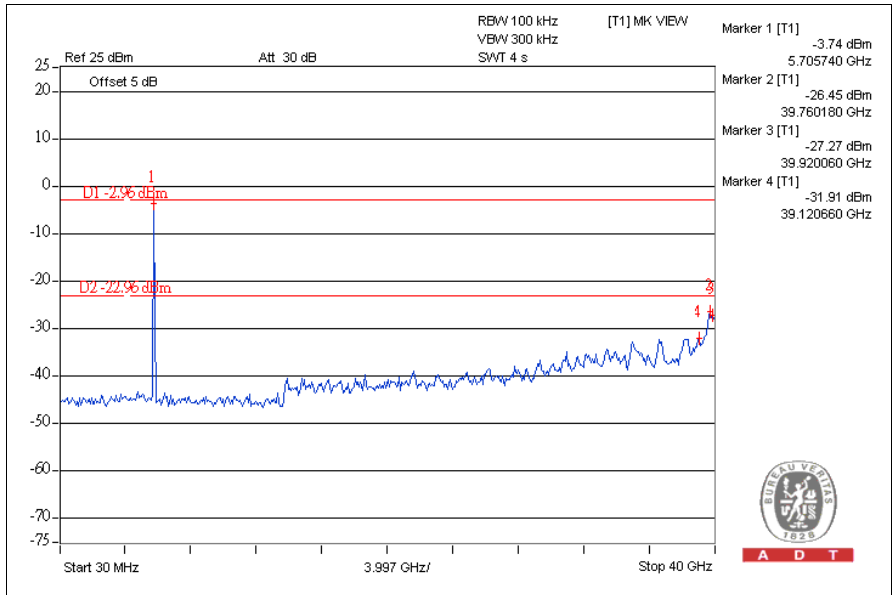

CH159

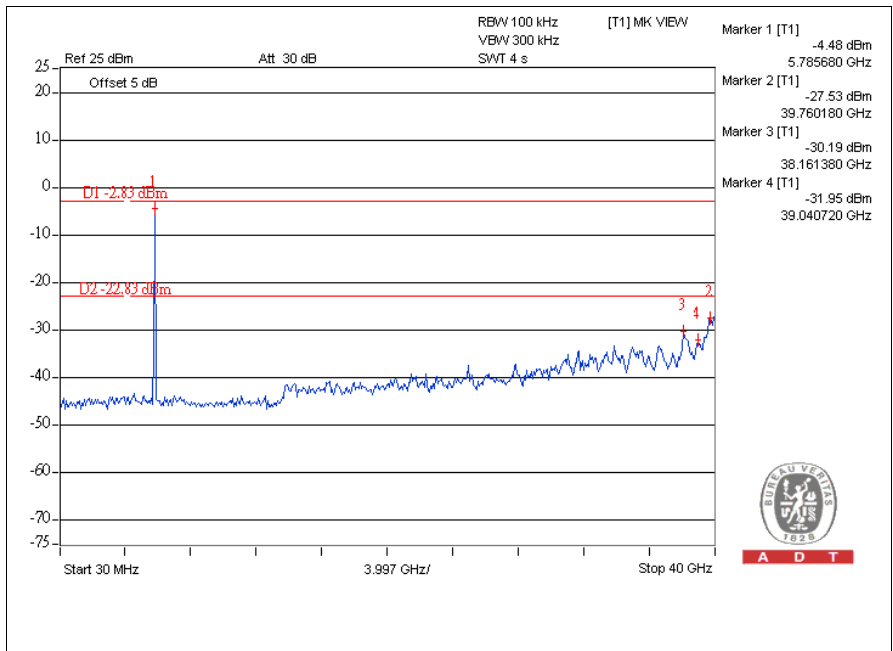



6. INFORMATION ON THE TESTING LABORATORIES

We, Bureau Veritas Consumer Products Services (H.K.) Ltd., Taoyuan Branch, were founded in 1988 to provide our best service in EMC, Radio, Telecom and Safety consultation. Our laboratories are accredited and approved according to ISO/IEC 17025:

Copies of accreditation certificates of our laboratories obtained from approval agencies can be downloaded from our web site:

www.adt.com.tw/index.5/phtml. If you have any comments, please feel free to contact us at the following:

Linko EMC/RF Lab:

Tel: 886-2-26052180

Fax: 886-2-26052943

Hsin Chu EMC/RF Lab:

Tel: 886-3-5935343

Fax: 886-3-5935342

Hwa Ya EMC/RF/Safety Telecom Lab:

Tel: 886-3-3183232

Fax: 886-3-3185050

Web Site: www.adt.com.tw

The address and road map of all our labs can be found in our web site also



A D T

7.APPENDIX-A- MODIFICATIONS RECORDERS FOR ENGINEERING CHANGES TO THE EUT BY THE LAB

No any modifications are made to the EUT by the lab during the test.

---END---