Internal DVD R/RW Drive

ND-2100

User's Manual

Laser Safety Information

This drive employs a laser. Do not remove the cover or attempt to service this device when connected due to the possibility of eye damage.

CAUTION

Use of control of adjustments or performance of procedures other than those specified herein may result in hazardous radiation exposure.

This label is located on top enclosure of this drive.

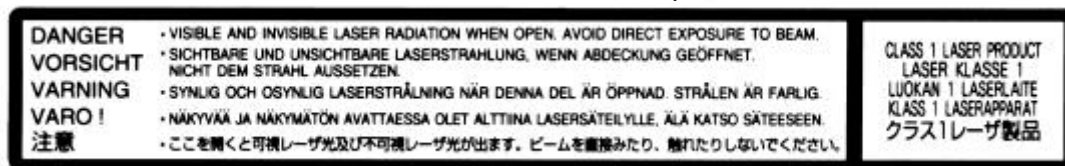
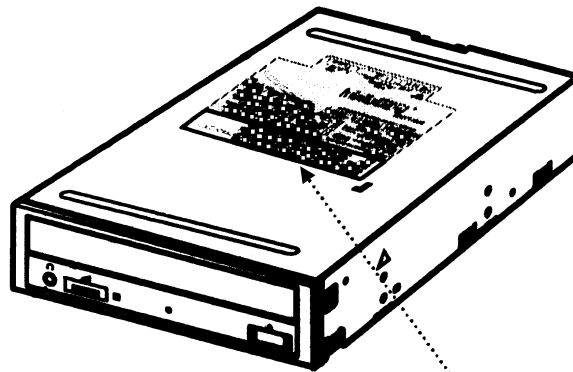

Laser Specification

(for CD)

Type : Semiconductor laser GaAlAs

Wave length : 783 nm (Typical at 25°C)

Output : Max.200 mW (Pulse width=70ns, Duty=50%)

(for DVD)

Type : Semiconductor laser AlGaInP

Wave length : 658 nm (Typical at 25°C)

Output : 140 mW (Pulse width=100ns, Duty=50%)

NOTICE

This equipment has been tested and found to comply with the limits for a Class B digital device, pursuant to Part 15 of the FCC Rules.

These limits are designed to provide reasonable protection against harmful interference in a residential installation. This equipment generates, uses and can radiate radio frequency energy and, if not installed and used in accordance with the instructions, may cause harmful interference to radio communications. However, there is no guarantee that interference will not occur in a particular installation. If this equipment does cause harmful interference to radio or television reception, which can be determined by turning the equipment off and on, the user is encouraged to try to correct the interference by one or more of the following measures:

- Reorient or relocate the receiving antenna.
- Increase the separation between the equipment and receiver.
- Connect the equipment into an outlet on a circuit different from that to which the receiver is connected.
- Consult the dealer or an experienced radio/TV technician for help.

This digital apparatus does not exceed the Class B limits for radio noise emissions from digital apparatus as set out in the Radio Interference Regulations of the Canadian Department of Communications.

LE PRÉSENT APPAREIL NUMÉRIQUE N'ÉMET PAS DE BRUITS RADIOÉLECTRIQUES DÉPASSANT LES LIMITES APPLICABLES AUX APPAREILS NUMÉRIQUES DE CLASSE B PRESCRITES DANS LE RÈGLEMENT SUR LE BROUILLAGE RADIOÉLECTRIQUE ÉDICTÉ PAR LE MINISTÈRE DES COMMUNICATIONS DU CANADA.

CAUTION

The user who makes changes or modifications to the unit without the express approval by the manufacturer will void user authority to operate the equipment.

ACHTUNG

Der arbeitsplatzbezogene Geräuschemissionswert dieses Gerätes beträgt 70dB (A) nach EN 27779/1991.

Notice

Only CD discs and DVD discs carrying the label below can be used with this DVD R/RW drive.

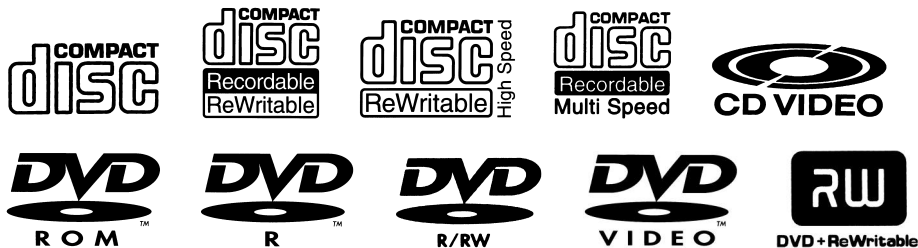

Table of Contents

Heed the following

Warning	5
Caution	6

Cautions

Cleaning.....	7
Handling the Disc	7

Part Names and Functions

Front View.....	8
Rear View	9

Preparation

Jumper Setting.....	10
Installing the DVD R/RW drive in a host PC	11

Inserting/Removing a Disc

Using the DVD R/RW Drive Installed Vertically	14
Inserting a Disc	15
Removing a Disc.....	15
Emergency Eject.....	15

Specifications

DVD Section.....	16
CD Section.....	17
IDE Interface Section	18
Audio Section	18
Environment.....	18
General	18

HEED THE FOLLOWING

Read the operating instructions carefully before using the unit and be sure to use it properly. After reading the instructions, store them in an easily accessible place so they can be consulted whenever necessary.

WARNING



- Continued use should there be an irregularity (smoke, abnormal smell or sound, etc.) will lead to fires or electric shocks. If there should be an irregularity, immediately turn off the power of the computer on which the unit is installed and request servicing.



- Do not disassemble or modify the unit in any way. Doing so will lead to fires or electric shocks.



- Make sure that no foreign objects get in the unit, as this will lead to fires or electric shocks. If a foreign object should get in the unit, immediately turn off the power of the computer on which the unit is installed and request servicing.



- Do not let fluids get in the unit or let the unit get wet, as this will lead to fires or electric shocks. If fluid should get in the unit, immediately turn off the power of the computer on which the unit is installed and request servicing.

- Do not use with any power voltage other than the indicated voltage. Doing so will lead to fires or electric shocks.

- Do not store or use the unit in places where it may be subject to shocks or strong vibrations. Doing so will lead to fires or electric shocks.

- Do not store or use the unit in places where it may be exposed to chemicals or chemical vapors. Doing so will lead to fires or electric shocks.

 **CAUTION**



- When connecting computer equipment, audio equipment, speakers, etc., be sure to read the respective manuals carefully, turn off the power and follow the connection instructions. Using cords other than the specified cords or extending cords could generate heat and result in burns, etc.



- Set the volume to the minimum before turning on the power. Sudden bursts of loud sound could result in hearing impairment.
- Do not store or use the unit in extremely hot places or places where the humidity fluctuates greatly. Doing so could lead to fires or electric shocks.

- Do not store or use the unit in places exposed to direct sunlight or near equipment that generates heat. Doing so could lead to fires.

- Do not place the unit on unsteady tables, slanted surfaces or other unstable surfaces. The unit could fall or tip over, resulting in injury.

- Do not store or use the unit in humid or dusty places. Doing so could lead to fires or electric shocks.

- Do not store or use the unit with heavy objects or objects that stick out past the frame on top of it. The object or unit may lose its balance and tip over or fall, resulting in injury.

- Do not let stick your hands into the disc insertion slot, as this could cause injury.

- Do not use cracked or misshapen discs or discs that have been repaired with adhesives, etc. Discs rotate at high speeds inside the unit. If such discs are used, they may break and fly out, resulting in injury.

- Do not look directly at the laser source. Exposing the eyes to the laser beam could result in vision impairment.

- When used near a radio or TV, the unit may generate noise in the radio or TV. Also, if there is equipment generating strong magnetic forces nearby, this may generate noise in the unit.



- Keep the disc tray closed except when inserting or removing discs in order to prevent injury from bumping into the disc tray.



- When disconnecting from computer equipment, wait to remove a couple of minutes until it gets cold. The enclosure may have some points over 60C degree.

Cautions

Cleaning

To clean the DVD R/RW drive, wipe it with a soft, damp cloth, using mild detergent if necessary. Please avoid using solvents such as benzine or paint thinner.

This can cause color changes or deformation of DVD R/RW drive.

Handling the Disc

- Do not touch the data side of the disc (the side of the disc with no label or printing).

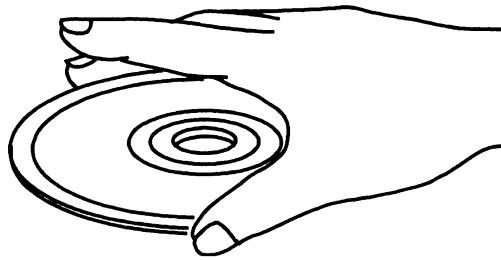

- Do not apply paper labels or write on any part of the disc, data side or label side. Do not use the disc leaved a mark strip paper labels.
- If dust or fingerprints get on the disc, wipe it with a soft cloth from the center to the edge.

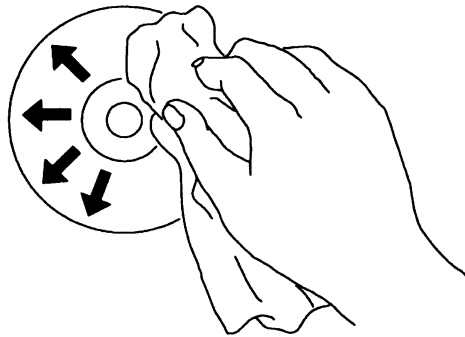

- Do not use benzine, paint thinner, record cleaner, or static repellent. This can damage the disc.
- Do not place the disc in any place where it will be subjected to direct sunlight or high temperatures.

Part Names and Functions

Front View

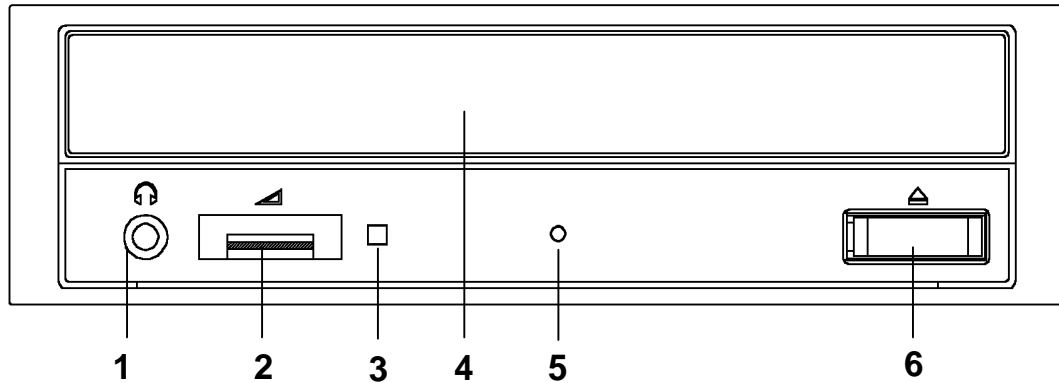

1 Phones Jack

This jack is used to connect a set of headphones. Please use headphones with a stereo mini-jack plug.

2 Volume Control

This control is used to adjust the headphone volume.

NOTE: This control has no effect on the audio output from the LINE OUT connector on the back of the DVD R/W drive.

3 BUSY Indicator

This indicator lights green while data is being read and written.

4 Tray Panel

This panel prevents dust from entering the DVD R/W drive.

The disc tray will be ejected when the Load/Eject button is pushed.

5 Emergency Eject Hole

Use to remove the disc from the DVD R/W drive if the electrical eject is disabled by software or if power failure occurs. (See page 14 "Emergency Eject" for details.)

6 Load/Eject

This button is pressed to eject or retract the disc tray when the power is on.

Rear View

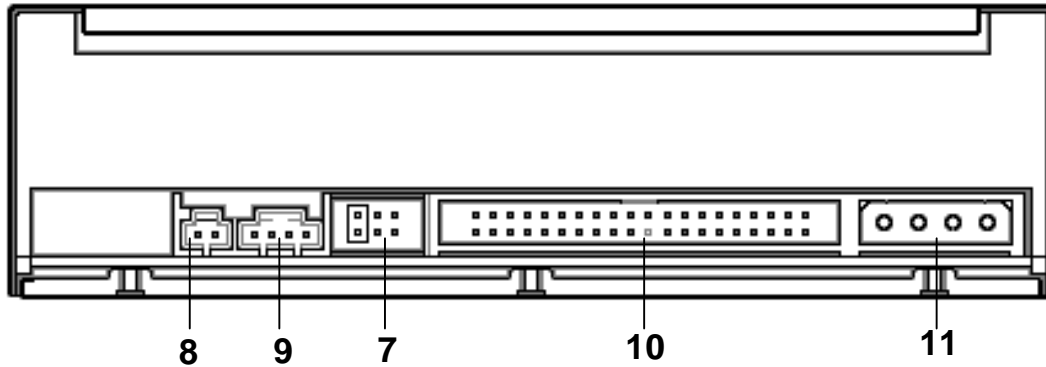

7 Jumper Blocks

These blocks of jumper locations set the configuration for the DVD R/W drive.

(See page 10, "Jumper Setting" for details.)

8 DIGITAL OUT Connector

This connector is used to connect CD Digital Audio to an audio board.

9 Line Out Connector

This connector is used to connect CD-Audio to an audio board.

10 I/O BUS Connector

This BUS connector is used to control the DVD R/W drive and sent data.

Use a flat ribbon cable to connect your computer to the DVD R/W drive.

Connect the colored side of the ribbon cable to the side marked with the arrow.

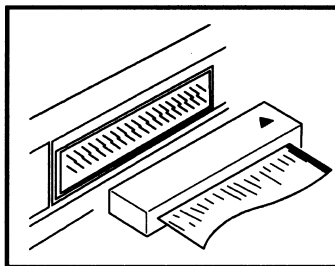

11 Power Connector

Use this to provide operating power from the host computer.

Preparation

Jumper Setting

A jumper consists of a pair of pins and a connector which fits over the pins. When the connector is in place it establishes an electronic link between the pins, which enables the function being controlled by the jumper. If the connector is removed, the electronic link is broken and the function is disabled.

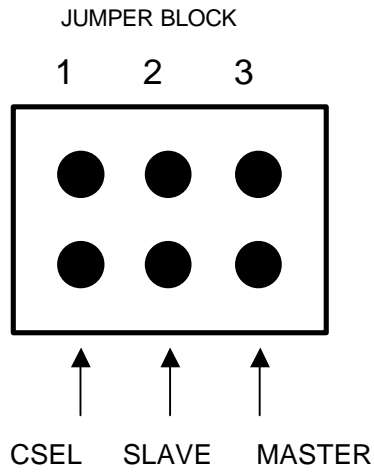

Jumpers are used to set the DVD R/RW drive mode on the IDE interface.

Installing the DVD R/RW drive in a host PC

Note

Refer to the guidebook included with your personal computer for instructions on installing the DVD R/RW drive. This chapter gives one example of installation.

And, when disconnecting the DVD R/RW drive from computer equipment, please wait to remove a couple of minutes until it gets cold.

The enclosure may have some points over 60 C degree.

1. Attach the mounting rails to both the left and right sides of the DVD R/RW drive.
2. Turn off the computer, other peripherals and unplug all the cords and cables. Then remove the computer cover, face plate, mounting clips, and keeper bracket. Refer to the Guide to Operations that came with your computer for help with this step.
3. Slide the disc drive out approximately 50 ~ 70mm (2 ~ 3 in.), but do not disconnect the cables.
4. Slide the DVD R/RW drive into the computer until it is even with the disc drive.

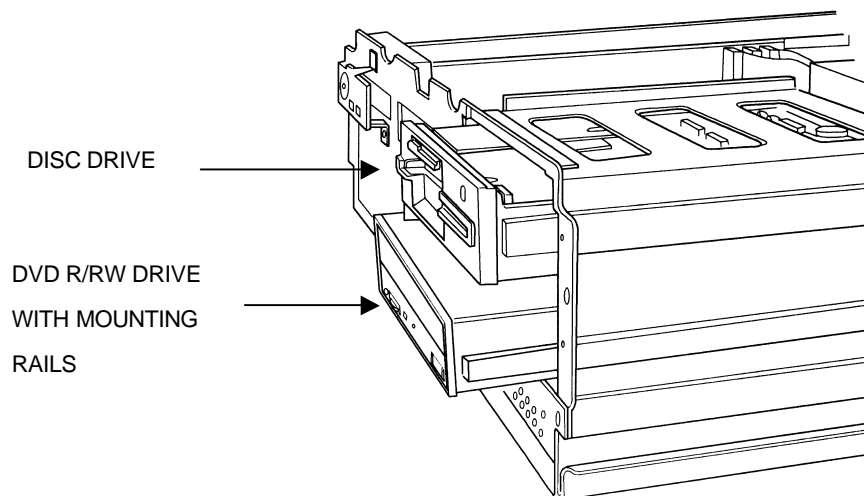

-
5. Locate a spare power cable in your computer.
 6. Connect that power cable to the power connector on the back of the DVD R/RW drive.

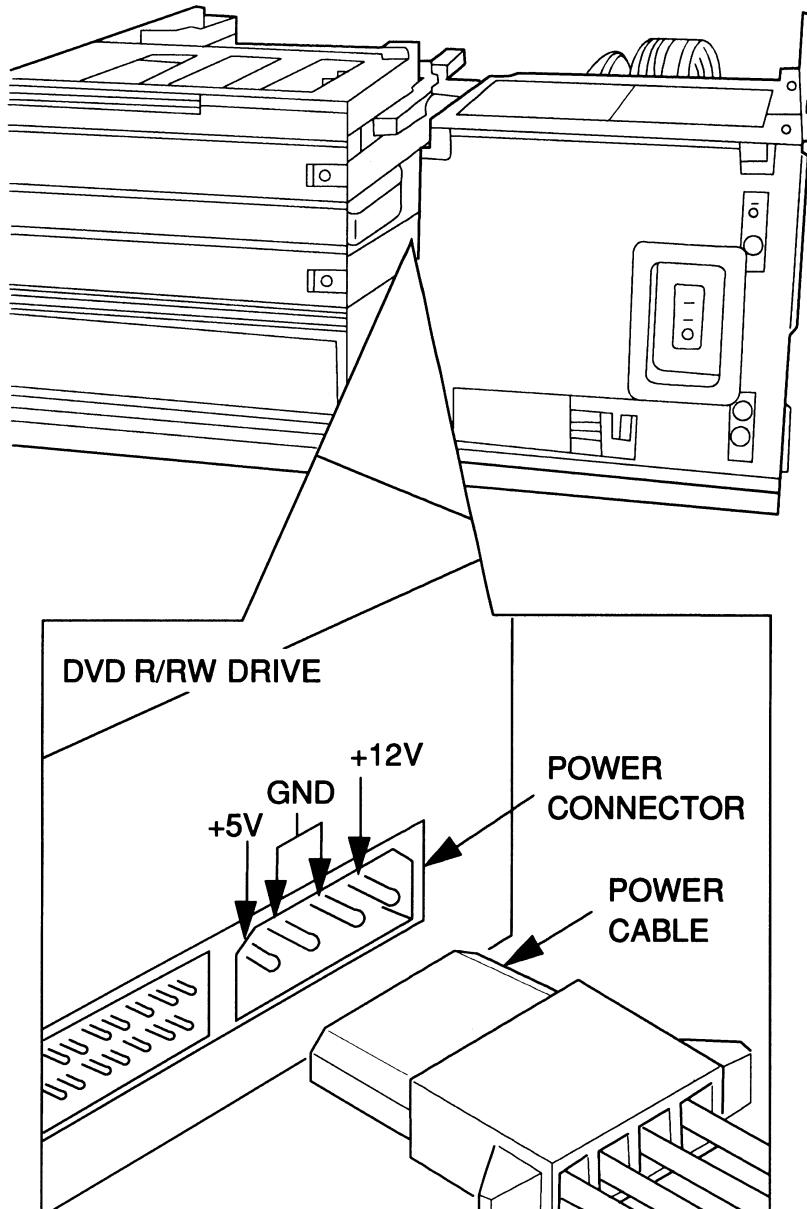

7. Connect the I/O BUS connector on the DVD R/RW drive and the IDE connector.

Connect the colored stripe side of the cable to the side marked with the arrow .

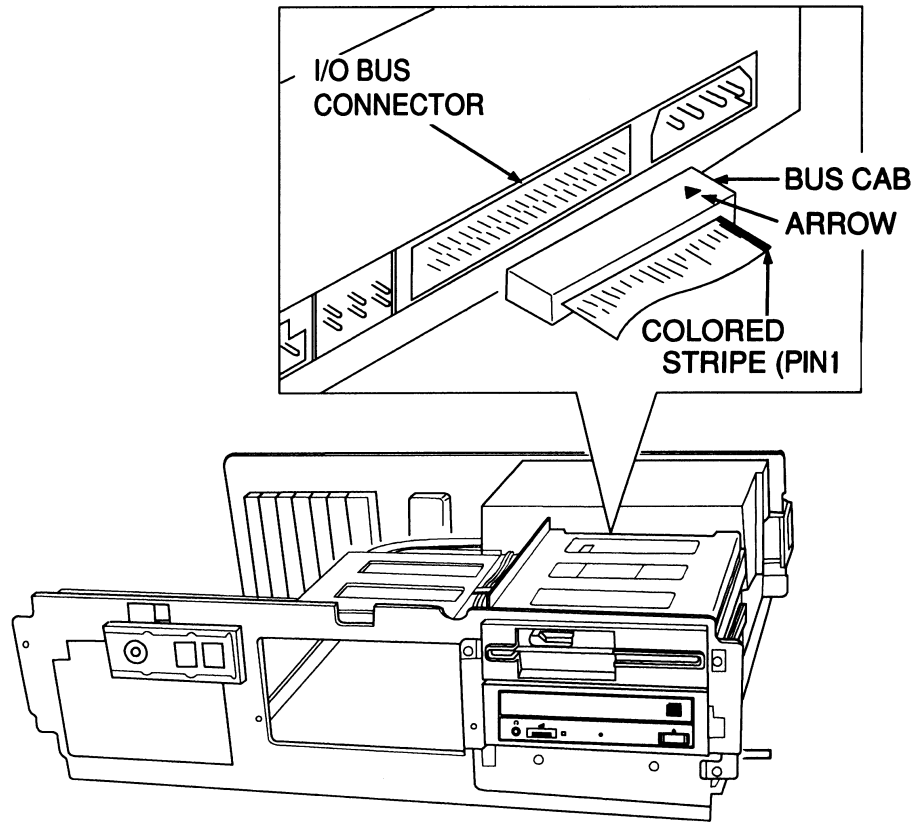

8. Slide the disc drive and DVD R/RW drive into the computer.

9. Replace the mounting clips, keeper bracket, and computer cover.

Inserting/Removing a Disc

Using the DVD R/RW Drive Installed Vertically

When using the DVD R/RW drive, in the vertical position, load and unload discs as shown on the diagram below.

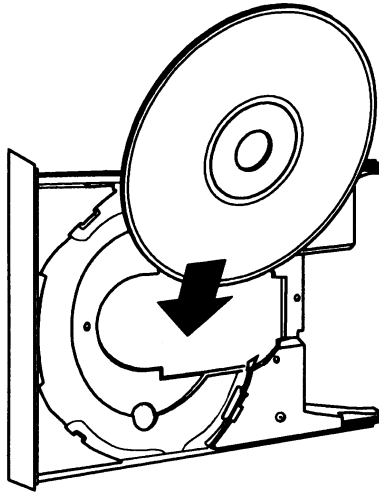

DVD R/RW drive installed vertically
(left side)

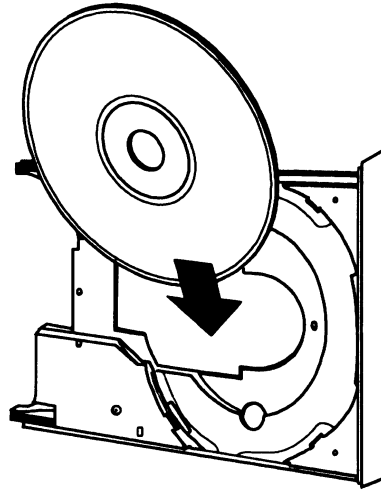

DVD R/RW drive installed vertically
(right side)

Caution

Only 12cm discs can be used when the DVD R/RW drive is installed vertically. Do not place 8cm discs in the tray when using the DVD R/RW drive installed in this way.

Inserting a Disc

1. Press the Load/Eject button. The disc tray will be ejected.
2. Place the disc in the center of the tray with the label side facing up.
3. Press the Load/Eject button. The disc tray will be retracted.

Removing a Disc

1. Press the Load/Eject button. The disc tray will be ejected.
2. Remove the disc.
3. Press the Load/Eject button. The disc tray will be retracted.

WARNING:

Do not forcibly push the disc tray in by hand. Doing so may result in damage.

Note:

If an eject prohibit command has been received from the computer, the disc tray will not be ejected even if the Load/Eject button is pressed.

Emergency Eject

The procedure described below can be used to remove a disc from the DVD R/RW drive if the Load/Eject button is disabled by software or a power failure occurs.

1. Turn off the power to the computer installed the DVD R/RW drive.
2. The disc that is inside may still be spinning. Please wait 1 minute until it stops to spin certainly.
3. Insert a steel rod as paper clip and so on that is straightend (about 1.3mm in diameter) into the emergency eject hole and push slowly.
The disc tray is ejected by about 1cm. Pull it all the way open by hand.

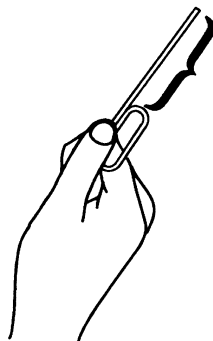
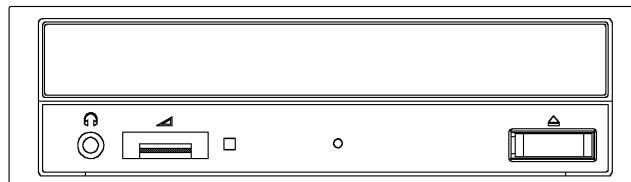

Specifications

DVD Section

User Data Capacity	4.7 GBytes (Single layer, 12cm), 1.46 GBytes (Single layer, 8cm),	8.54 GBytes (Dual layer, 12cm) 2.66 GBytes (Dual layer, 8cm)
User Data Blocks	2048 Bytes/block	
Data Transfer Rate	16.6 Mbytes/sec (Maximum)	
Access Time	140 msec (1/3 Stroke read, average)	
Hard Error Rate	Below 10 ⁻¹² Block/bit (After error correction)	
Data Transfer Rate		
DVD-ROM Single Layer	16.6 MBytes/sec (Maximum)	
Dual Layer	10 MBytes/sec (Maximum)	
DVD-R, -RW, +R, +RW.....	11 MBytes/sec (Maximum)	
DVD-Video with CSS Protection.....	6.9 MBytes/sec (Maximum)	
Readable Format, Modes		
DVD-Video (8cm/12cm, Single and Dual Layer), DVD-ROM (8cm/12cm, Single and Dual Layer), Multi-Boader, Multi-Session		
Writable Media		
a) DVD-R Media (8X/4X/2X, For General Ver.2.0)	Mitsubishi, Taiyo-Yuden, Mitsui, Pioneer, Panasonic, Hitachi Maxell, TDK, (T.B.D)	
b) DVD-RW Media (4X/2X/1X, Ver1.0, 1.1)	JVC, Pioneer, Mitsubishi, TDK, (T.B.D)	
c) DVD+R Media (8X/4X/2.4X)	RICOH, Mitsubishi, TDK, MAXELL, YUDEN, Verbatim, (T.B.D)	
d) DVD+RW Media (4X/2.4X)	RICOH, Mitsubishi, TDK, Philips, Verbatim, (T.B.D)	
e) DVD-RW Rewrite	1000 times	
f) DVD+RW Rewrite	1000 times	
Write Speed and Transfer Rate		
DVD+R Write 8X ZCLV	5.5 - 11 MBytes/sec	
4X CLV	5.5 MBytes/sec	
2.4X CLV	3.3 MBytes/sec	
DVD+RW Write 4X CLV	5.5 MBytes/sec	
2.4X CLV	3.3 MBytes/sec	
(DVD-R Write 8X ZCLV	5.5 - 11 MBytes/sec) T.B.D	
(4X CLV	5.5 MBytes/sec) T.B.D	
(2X CLV	2.7 MBytes/sec) T.B.D	
(DVD-RW Write 4X CLV	5.5 MBytes/sec) T.B.D	
(2X CLV	2.7 MBytes/sec) T.B.D	
DVD Writable Format, Modes and Block Length Supported		
a) Format and Modes Supported	DVD-Video, DVD-ROM, Multi session	
b) Block Length Supported	2048 Bytes/sector	
DVD Write Method Supported		
a) Uninterrupted Write	Disc at once	
b) Interrupted Write	Random Write (DVD+R/RW), Sequential Write (DVD+R/RW) Incremental (DVD-R/RW), Multi-Border (DVD-R/RW), Restricted Overwrite (DVD-RW)	

CD Section

User Data Capacity	656 Mbytes/disc (Mode 1)
(1MBytes = 1024 x 1024)	748 Mbytes/disc (Mode 2)
User Data Blocks	2048 Bytes, Mode 1 and Mode 2 Form 1
	2336 Bytes, Mode 2
	2328 Bytes, Mode 2 Form 2
Access Time	120 msec (1/3 Stroke Read, typical)
Hard Error Rate	Below 10 ⁻¹² Block/bit (After error correction)
Data Transfer Rate	
CD-ROM/CD-R	6000 Kbytes/sec (Mode 1 and Mode 2 Form 1, Maximum)
CD-RW	4800 KBytes/sec (Mode 1 and Mode 2 Form 1, Maximum)
Readable Format, Modes	
CD-Audio (8cm/12cm), CD-ROM (mode 1 and mode 2), CD-ROM XA(mode 1 and form 2),	
Photo CD™ (single or multiple sessions), CD-I (FMV), Video CD, CD Extra., CD-TEXT	
Write Speed and Transfer Rate	
CD-R Write	
32X ZCLV	2400 - 4800 KBytes/sec
24X ZCLV	2400 - 3600 KBytes/sec
16X CLV	2400 KBytes/sec
8X CLV	1200 KBytes/sec
4X CLV	600 KBytes/sec
CD-RW Write	
24X ZCLV (US-RW)	2400 - 3600KBytes/sec
16X ZCLV (US-RW)	1200 - 2400 KBytes/sec
10X CLV (HS-RW)	1500 KBytes/sec
4X CLV	600 KBytes/sec
Writable Format, Modes and Block Length Supported	
Format and Modes Supported	
CD-Audio(8cm/12cm), CD-ROM(mode 1 and mode 2), CD-ROM XA(mode2, form 1 and form 2),	
Photo CD™ (single or multiple sessions), CD-I(FMV), Video CD, CD Extra., CD-TEXT	
Block Length Supported	
CD-Audio	2352 Bytes
CD-ROM(mode 1)	2048 Bytes
CD-ROM XA/CD-I form 1	2048 and 2332 Bytes
form 2	2332 Bytes
Write Method Supported	
a) Uninterrupted Write	Disc at Once
b) Interrupted Write	Track at Once, Session at Once
	Packet Writing(Fixed size Packets, Variable size Packets)
Writable Media	
a) CD-R Media (32X/24X/16X/8X/4X/2X)	
Mitsubishi, Taiyo-Yuden, Mitsui, Ricoh, Fujifilm, Sony, Hitachi Maxell, Memorex, RITEK, CMC,	
P.V.C, JVC, SKC, ACER, Prime Disc, TDK	
b) CD-RW Media (24X/16X/10X/4X) (T.B.D)	
Ricoh, Mitsubishi, ACER, OPTROM, MEMOREX, P.V.C, RITEK, CMC, LEADDATA, GigaStorage,	
Prodisc, Fornex, Sumsung, Philips	
c) CD-RW Rewrite	
1000 times	

IDE Interface Section

Burst Transfer Rate PIO mode 4
DMA Single Word mode 2
DMA Multi Word mode 2
Ultra DMA 33 mode 2
Memory Buffer 2 MBytes

Audio Section

FREQUENCY RESPONDS 20 Hz - 20 kHz +3.0 dB, -3.0 dB
S/N RATIO > 80dB (1kHz) (T.B.D)
Total Harmonic Distortion < 0.10% (1KHz)
Output 0.75 V (rms) \pm 3.0 dB / 10 k Ω load at 1 kHz : 0 dB

Environment

Ambient conditions for use
Temperature +5 C degree to +50 C degree
Humidity Max 70% (no condensation)
Ambient conditions for storage
Temperature -40 C degree to +65 C degree
Humidity 20% to 90% (no condensation)

General

Power Supply 5V 1.6A / 12V 1.8A
Dimensions (W x H x D) 14.82 x 4.2 x 19.0cm (5 ¹³/₁₆ x 1 ⁵/₈ x 7 ⁴/₅ inch)
Weight 1.0 Kg (2.20 lbs) (T.B.D)

Note: Above specifications are subject to change.
Photo CD TM is a trademark of Kodak used under license.