

# SAR

*Dipole & Waveguide*

## Performance Measurement Report

ISSUED BY  
Shenzhen BALUN Technology Co., Ltd.



FOR  
Validation Dipoles & Waveguide

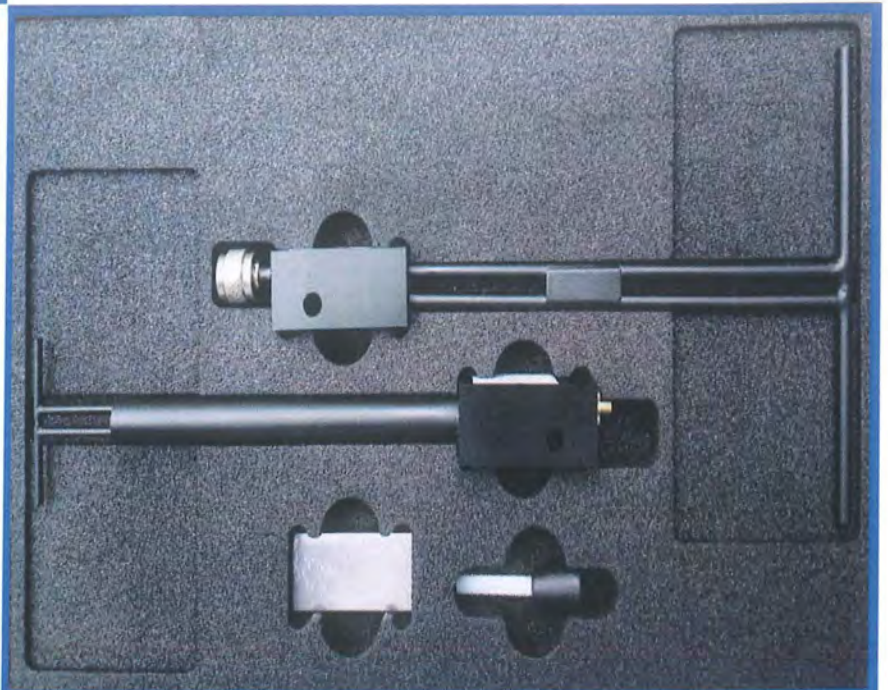

Tested by:

*Tu Lang*  
Tu Lang  
(Engineer)

Approved by:

*Liao Jianming*  
Liao Jianming  
(Technical Director)

Report No.: LW-SZ17C0366-701

EUT Type: SAR Validation Dipole and Waveguide

Model Name: DIP 0G750-253 DIP 0G835-246  
DIP 0G900-247 DIP 1G800-248  
DIP 1G900-249 DIP 2G000-250  
DIP 2G450-251 DIP 2G600-254  
SWG 5500-WGA24

Brand Name: SATIMO

Test Conclusion: Pass

Test Date: Mar. 1, 2017 ~ Mar. 4, 2017

Date of Issue: Mar. 18, 2017

*NOTE: This test report can be duplicated completely for the legal use with the approval of the applicant; it shall not be reproduced except in full, without the written approval of Shenzhen BALUN Technology Co., Ltd. BALUN Laboratory. Any objections should be raised within thirty days from the date of issue. To validate the report, please visit BALUN website.*



# 1 GENERAL INFORMATION

## 1.1 Introduction

This document contains a summary of the requirements set forth by the IEEE 1528, FCC KDB 865664 D01 for reference dipoles used for SAR measurement system validations. Instead of the typical annual calibration recommended by measurement standards, the reference dipoles were demonstrated that the SAR target, impedance and return loss have remain stable, so the longer calibration interval is acceptable.

## 1.2 General Description for Equipment under Test (EUT)

Model	Frequency	Serial Number	Product Condition (New/ Used)	Last Cal. Date	Last Meas. Date
<b>Dipole</b>					
DIP 0G750	750 MHz	SN 25/13 DIP 0G750-253	Used	2015/03/16	2017/03/01
DIP 0G835	835 MHz	SN 25/13 DIP 0G835-246	Used	2015/03/16	2017/03/01
DIP 0G900	900 MHz	SN 25/13 DIP 0G900-247	Used	2015/03/16	2017/03/01
DIP 1G800	1800 MHz	SN 25/13 DIP 1G900-248	Used	2015/03/16	2017/03/02
DIP 1G900	1900 MHz	SN 25/13 DIP 1G900-249	Used	2015/03/16	2017/03/02
DIP 2G000	2000 MHz	SN 25/13 DIP 2G000-250	Used	2015/03/16	2017/03/02
DIP 2G450	2450 MHz	SN 25/13 DIP 2G450-251	Used	2015/03/16	2017/03/02
DIP 2G600	2600 MHz	SN 25/13 DIP 2G600-254	Used	2015/03/16	2017/03/03
<b>Waveguide</b>					
SWG5500	5GHz-6GHz	SN 30/13 WGA24	Used	2015/03/16	2017/03/04



### 1.3 Test Equipment List

Description	Manufacturer	Model	Serial No.	Cal. Date	Cal. Due
PC	Dell	N/A	N/A	N/A	N/A
E-Field Probe	MVG	SSE2	S/N 34/15 EPGO 265	2016/09/15	2017/09/14
Phantom1	SATIMO	SAM	SN 30/13 SAM103	N/A	N/A
Phantom2	SATIMO	SAM	SN 30/13 SAM104	N/A	N/A
Dielectric Probe Kit	SATIMO	SCLMP	SN 25/13 OCPG56	2016/07/13	2017/07/12
MultiMeter	Keithley	MultiMeter 2000	4024022	2016/07/13	2017/07/12
Signal Generator	R&S	SMF100A	1167.0000k02/104260	2016/07/13	2017/07/12
Power Meter	Agilent	E4419B	GB40201833	2016/07/13	2017/07/12
Power Sensor	Agilent	E9300A	MY41498012	2016/07/13	2017/07/12
Power Sensor	Agilent	E9300A	MY41499891	2016/07/13	2017/07/12
Power Amplifier	SATIMO	6552B	22374	N/A	N/A
Network Analyzer	R&S	ZVL-6	101380	2016/07/13	2017/07/12
Attenuator	COM-MW	ZA-S1-31	1305003187	N/A	N/A
Directional coupler	AA-MCS	AAMCS-UDC	000272	N/A	N/A
Thermometer	Elitech	RC-4HC	N/A	2017/02/18	2018/02/17

### 1.4 EUT Photos

DIP 0G750-253



DIP 0G835-246



DIP 0G900-247



DIP 1G800-248



DIP 1G900-249



DIP 2G000-250



DIP 2G450-251

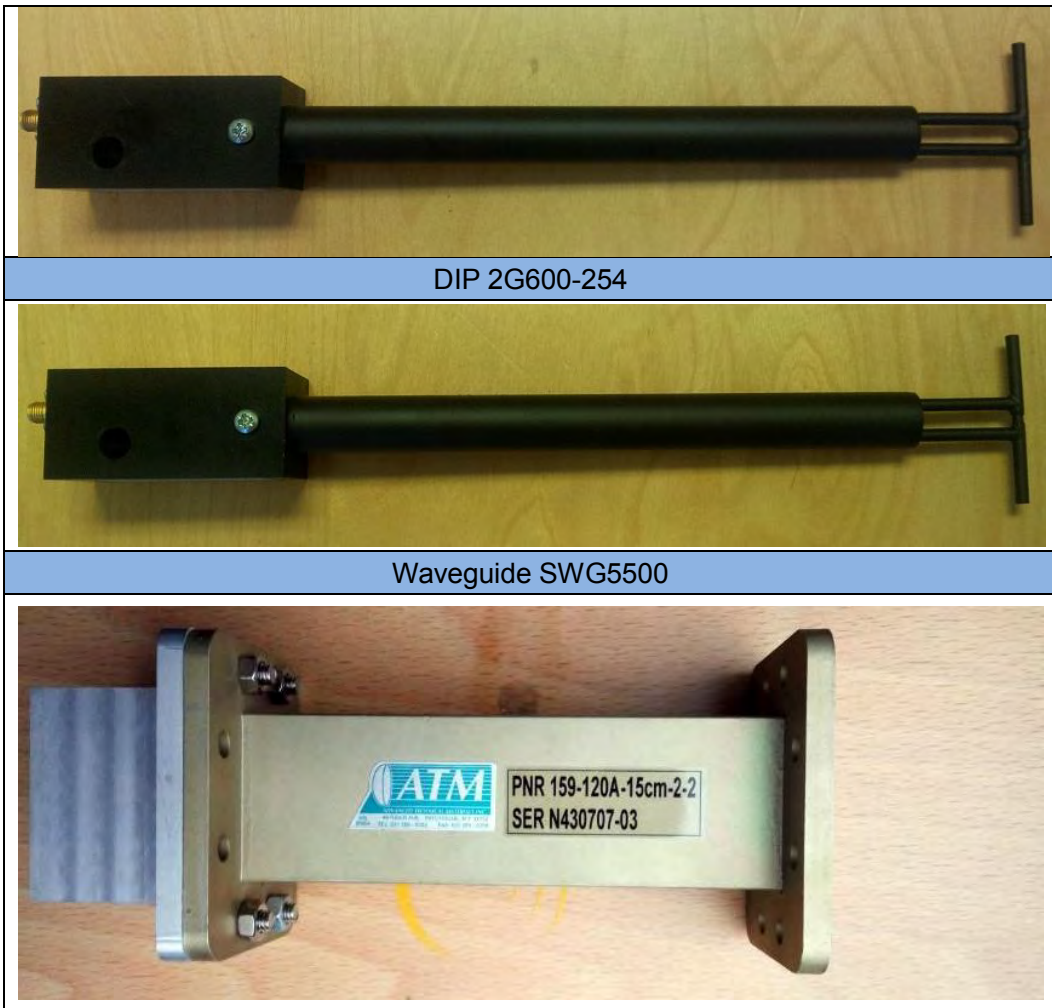

## 2 SIMULATING LIQUID VERIFICATION

Liquid Type	Fre. (MHz)	Meas. Conductivity ( $\sigma$ ) (S/m)	Meas. Permittivity ( $\epsilon$ )	Target Conductivity ( $\sigma$ ) (S/m)	Target Permittivity ( $\epsilon$ )	Conductivity Tolerance (%)	Permittivity Tolerance (%)
Head	750	0.90	41.88	0.89	41.94	1.12	-0.14
Body		0.93	56.89	0.96	55.53	-3.12	2.45
Head	835	0.88	42.96	0.90	41.50	-2.22	3.52
Body		0.98	54.27	0.97	55.20	1.03	-1.68
Head	900	0.98	41.01	0.97	41.50	1.03	-1.18
Body		1.08	53.62	1.05	55.00	2.86	-2.51
Head	1800	1.42	38.81	1.40	40.00	1.43	-2.97
Body		1.49	54.35	1.52	53.30	-1.97	1.97
Head	1900	1.43	39.83	1.40	40.00	2.14	-0.43
Body		1.54	54.02	1.52	53.30	1.32	1.35
Head	2000	1.43	38.79	1.40	40.00	2.14	-3.03
Body		1.55	51.51	1.52	53.30	1.97	-3.36
Head	2450	1.81	38.86	1.80	39.20	0.56	-0.87
Body		1.95	52.91	1.95	52.70	0.00	0.40
Head	2600	1.98	38.09	1.96	39.01	1.02	-2.36



Body		2.14	53.39	2.16	52.51	-0.93	1.68
Head	5200	4.62	36.73	4.66	35.99	-0.86	2.06
Body		5.21	50.08	5.30	49.01	-1.70	2.18
Head	5400	4.82	36.22	4.86	35.76	-0.82	1.29
Body		5.53	50.13	5.53	48.74	0.00	2.85
Head	5600	5.13	34.25	5.07	35.53	1.18	-3.60
Body		5.91	49.14	5.77	48.47	2.43	1.38
Head	5800	5.33	34.62	5.27	35.30	1.14	-1.93
Body		6.05	47.54	6.00	48.20	0.83	-1.37



### 3 DIPOLE IMPEDANCE AND RETURN LOSS

The dipoles are designed to have low return loss when presented against a flat phantom at the specified distance. A Vector Network Analyzer was used to perform a return loss measurement on the specific dipole when in the measurement location against the phantom and the distance was specified by the manufacturer with a special, low loss and low relative permittivity spacer.

The impedance was measured at the SMA-connector with the network analyzer.

The measurement of verification with return loss should not deviate by more than 20% and minimum of 20 dB of the return loss, and the impedance (real or imaginary parts) should not deviate by more than 5 Ohms from the previous measurement using network analyzer.

Note:

The "Previous Meas." in the following table refer to dipoles or other equivalent RF sources calibration reports.





### 3.1 DIP 0G750

#### RETURN LOSS AND IMPEDANCE IN HEAD LIQUID

Meas. Results	Current Meas.	Previous Meas.	Max. Deviation
Return Loss (dB)	-23.75	-24.73	3.96 %
Impedance	52.9 $\Omega$ - 1.5 j $\Omega$	56.1 $\Omega$ - 1.3 j $\Omega$	3.2 $\Omega$ (Real part)

#### Return Loss

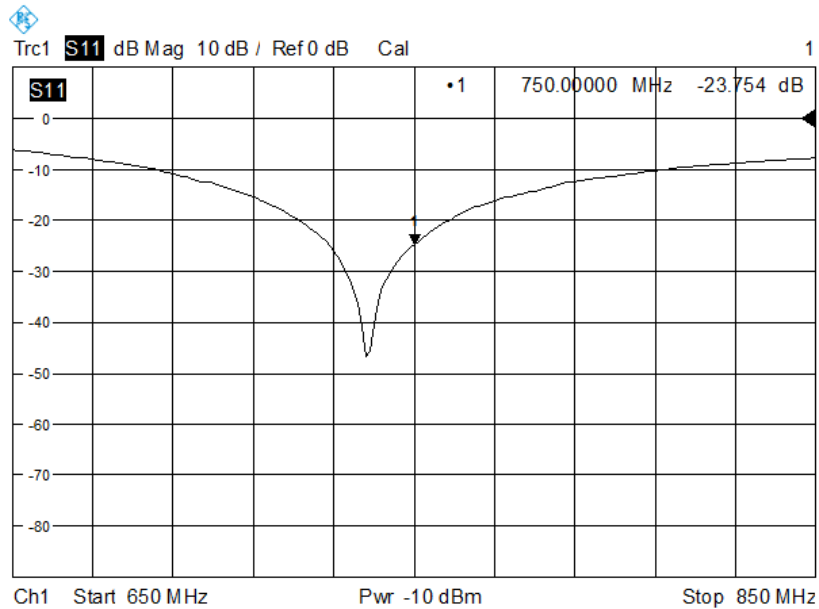

#### Impedance

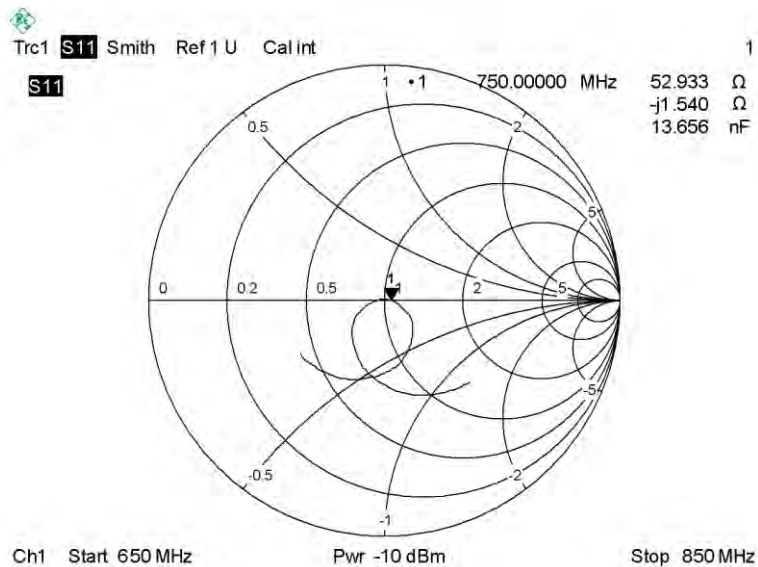



**RETURN LOSS AND IMPEDANCE IN BODY LIQUID**

Meas. Results	Current Meas.	Previous Meas.	Max. Deviation
Return Loss (dB)	-30.93	-27.47	12.6 %
Impedance	52.3 $\Omega$ + 0.9 j $\Omega$	55.8 $\Omega$ + 2.6 j $\Omega$	3.5 $\Omega$ (Real part)

**Return Loss**

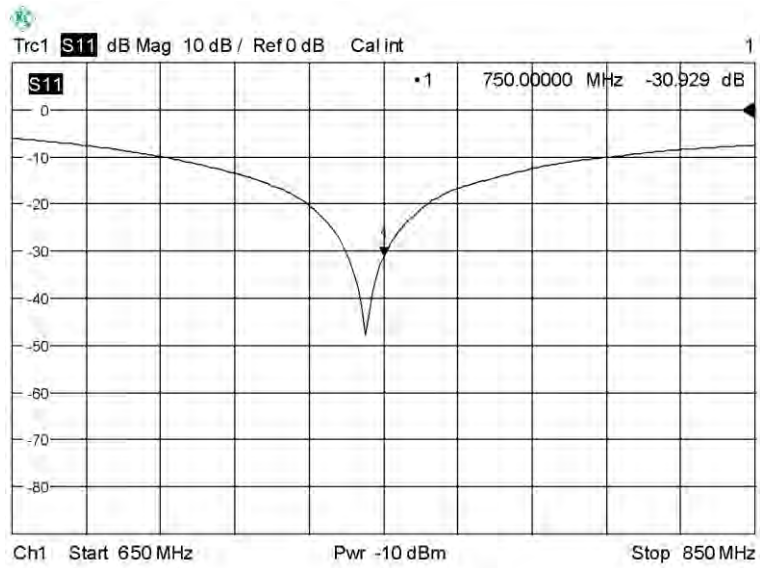

**Impedance**

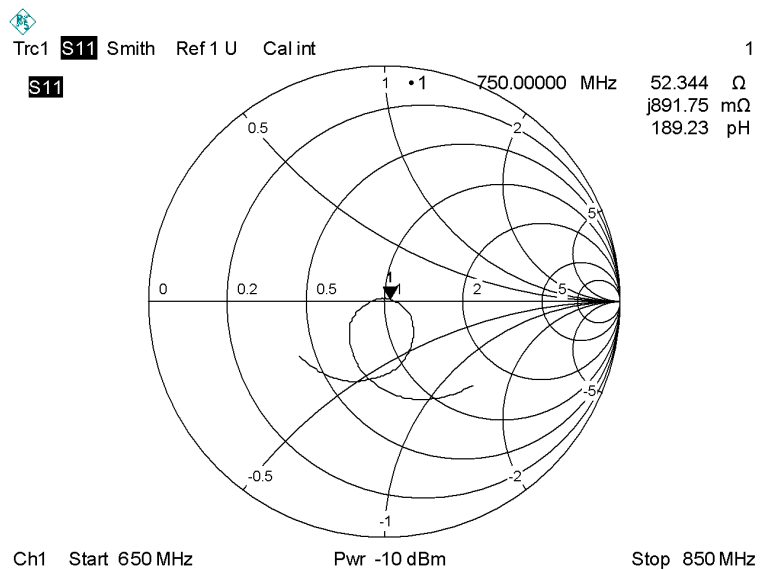



### 3.2 DIP 0G835

#### RETURN LOSS AND IMPEDANCE IN HEAD LIQUID

Meas. Results	Current Meas.	Previous Meas.	Max. Deviation
Return Loss (dB)	-27.10	-25.89	4.67 %
Impedance	53.0 $\Omega$ + 2.3 j $\Omega$	55.0 $\Omega$ + 0.7 j $\Omega$	2.0 $\Omega$ (Real part)

#### Return Loss

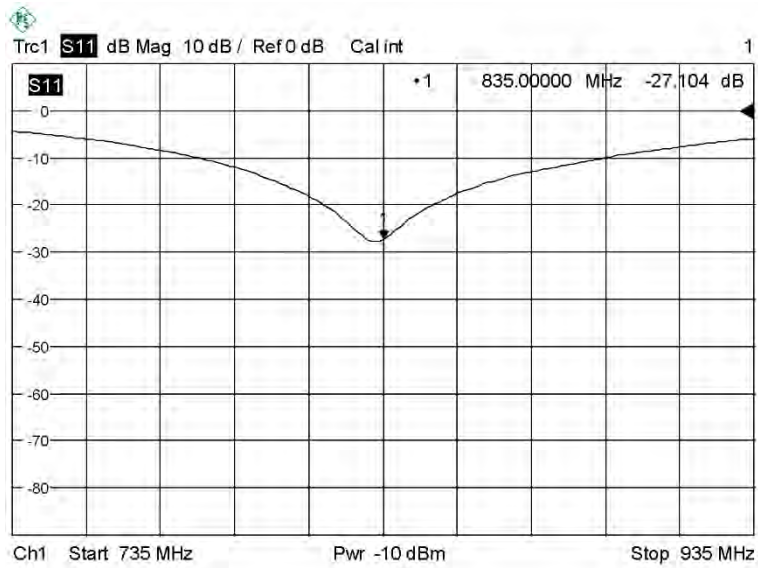

#### Impedance

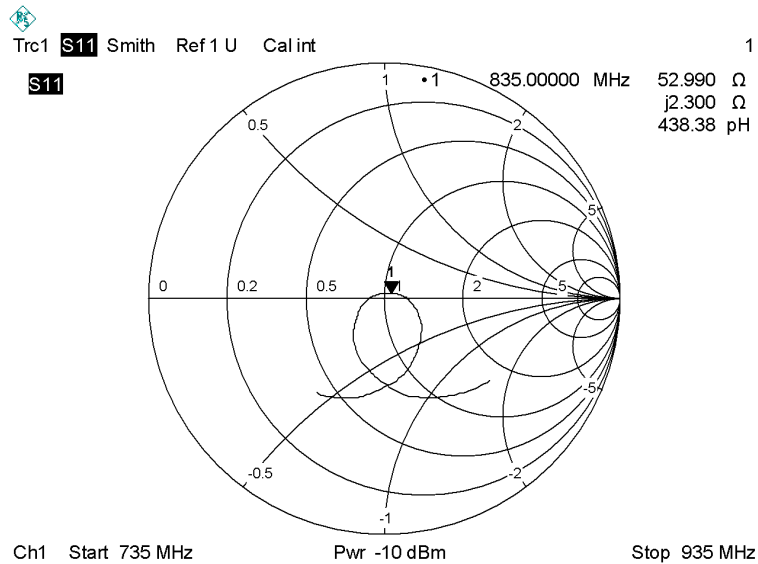



**RETURN LOSS AND IMPEDANCE IN BODY LIQUID**

Meas. Results	Current Meas.	Previous Meas.	Max. Deviation
Return Loss (dB)	-29.29	-27.60	6.12 %
Impedance	51.0 Ω + 4.3 jΩ	53.6 Ω + 2.5 jΩ	2.6 Ω (Real part)

**Return Loss**

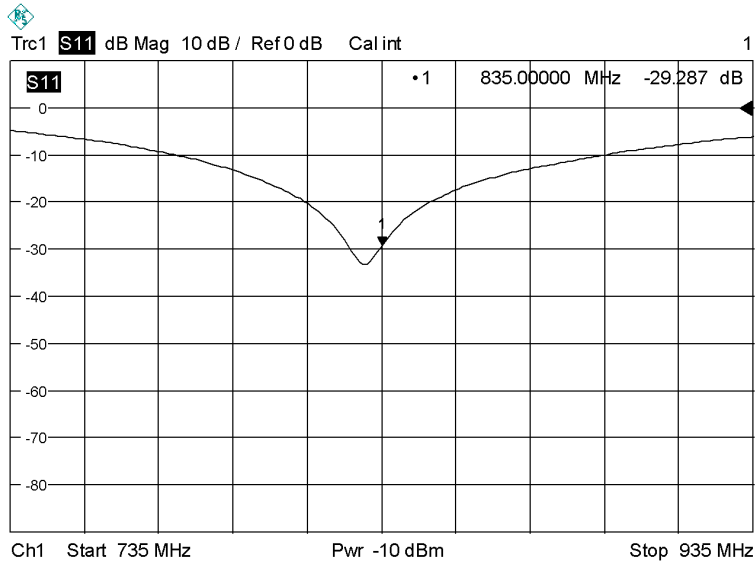

**Impedance**

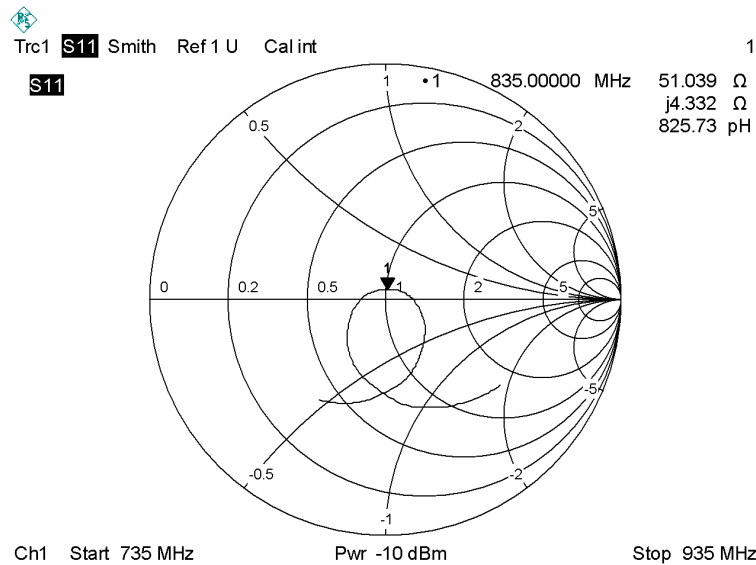

### 3.3 DIP 0G900

#### RETURN LOSS AND IMPEDANCE IN HEAD LIQUID

Meas. Results	Current Meas.	Previous Meas.	Max. Deviation
Return Loss (dB)	-31.8	-31.9	0.3 %
Impedance	$52.7 \Omega + 2.7 j\Omega$	$53.2 \Omega + 1.4 j\Omega$	$1.3 \Omega$ (Imaginary part)

#### Return Loss

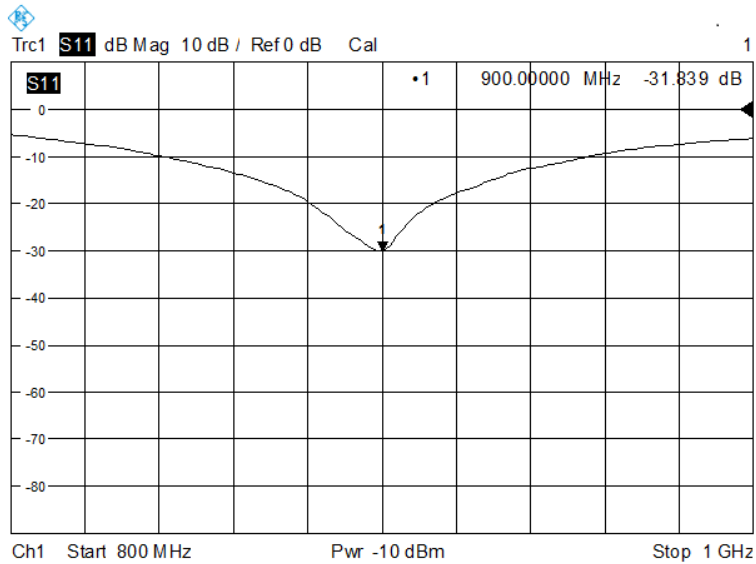

#### Impedance

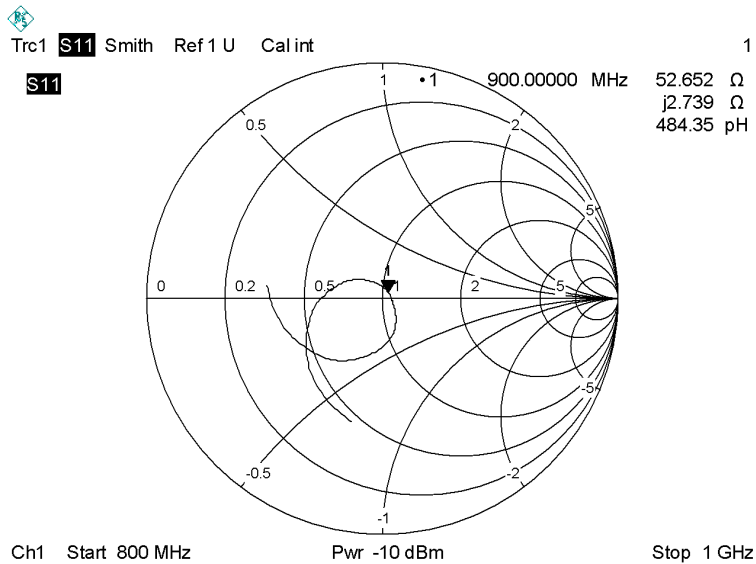



**RETURN LOSS AND IMPEDANCE IN BODY LIQUID**

Meas. Results	Current Meas.	Previous Meas.	Max. Deviation
Return Loss (dB)	-25.54	-27.20	6.1 %
Impedance	53.0 Ω + 4.2 jΩ	53.2 Ω + 3.2 jΩ	1.0 Ω (Imaginary part)

**Return Loss**

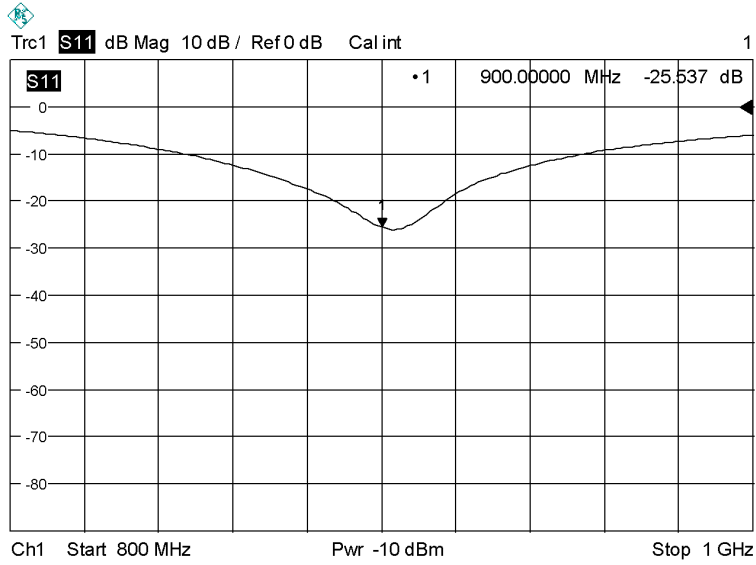

**Impedance**

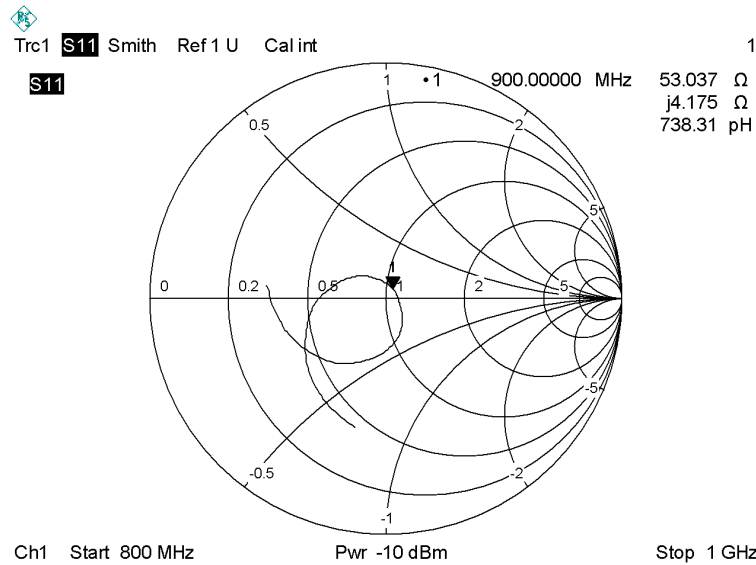



### 3.4 DIP 1G800

#### RETURN LOSS AND IMPEDANCE IN HEAD LIQUID

Meas. Results	Current Meas.	Previous Meas.	Max. Deviation
Return Loss (dB)	-20.80	-22.41	7.2 %
Impedance	41.5 $\Omega$ + 4.9 j $\Omega$	42.4 $\Omega$ + 3.9 j $\Omega$	1.0 $\Omega$ (Imaginary part)

#### Return Loss

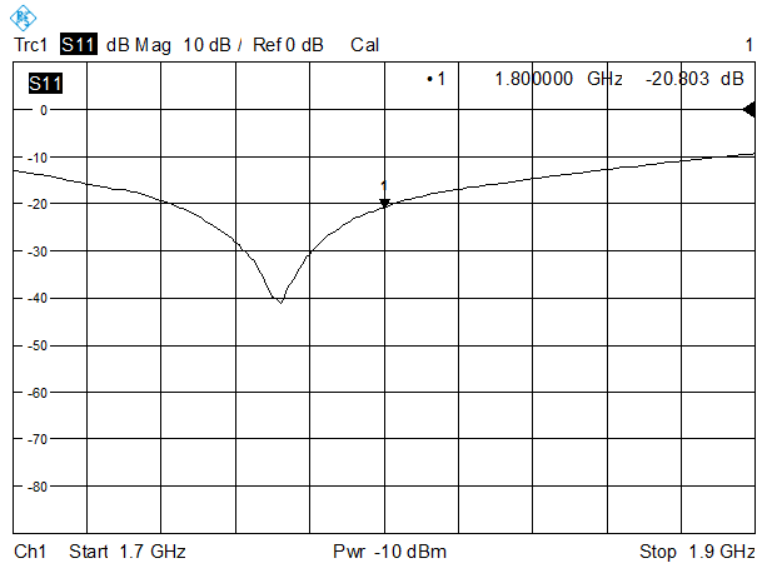

#### Impedance

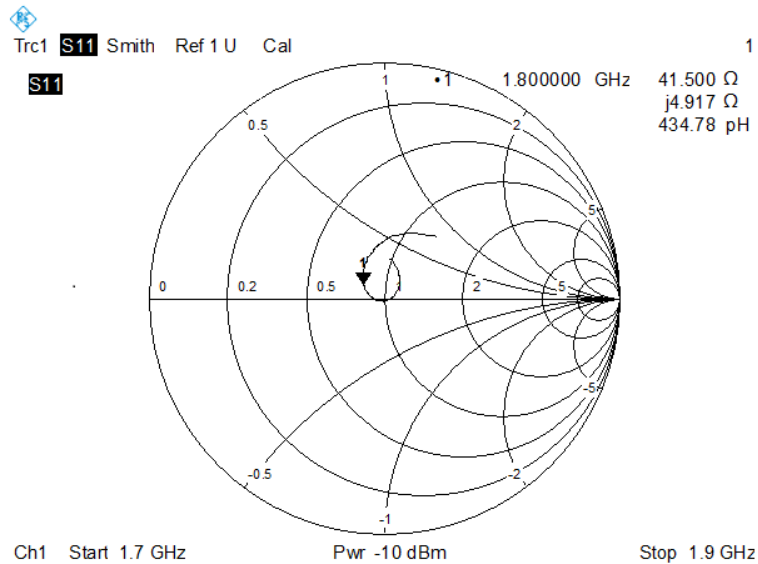



**RETURN LOSS AND IMPEDANCE IN BODY LIQUID**

Meas. Results	Current Meas.	Previous Meas.	Max. Deviation
Return Loss (dB)	-22.00	-22.09	0.4 %
Impedance	42.1 $\Omega$ + 0.3 j $\Omega$	42.9 $\Omega$ + 0.7 j $\Omega$	0.8 $\Omega$ (Real part)

**Return Loss**

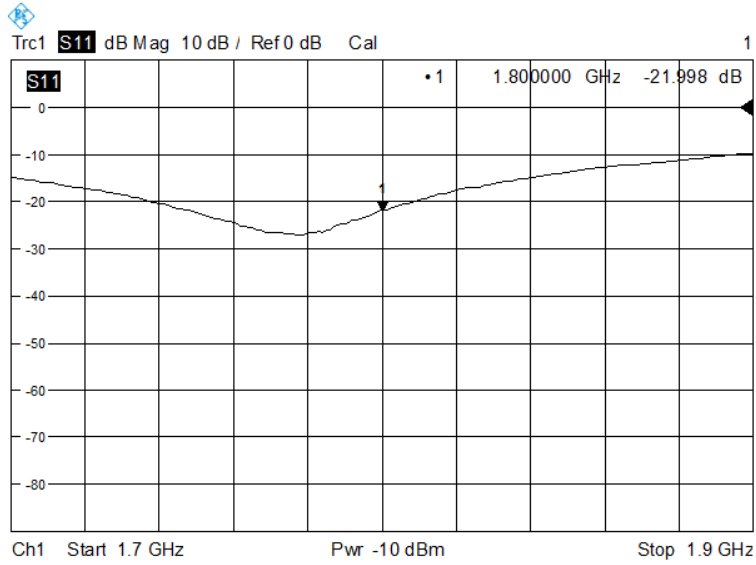

**Impedance**

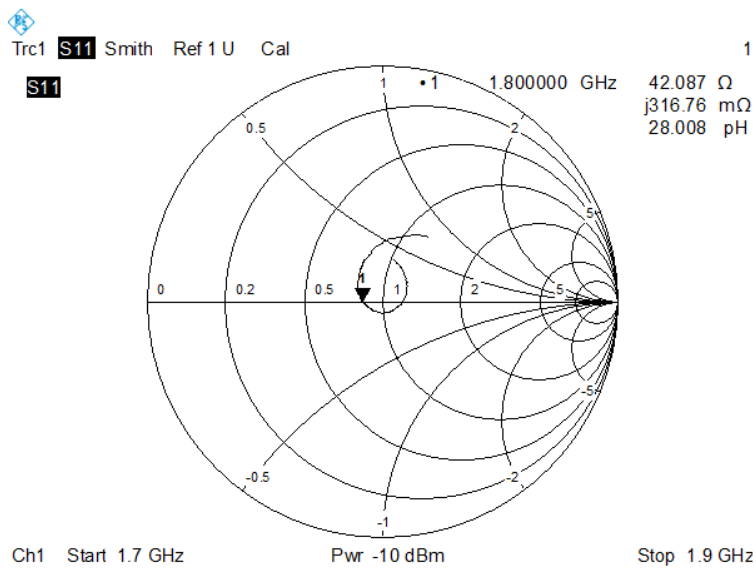





### 3.5 DIP 1G900

#### RETURN LOSS AND IMPEDANCE IN HEAD LIQUID

Meas. Results	Current Meas.	Previous Meas.	Max. Deviation
Return Loss (dB)	-21.08	-20.99	0.4 %
Impedance	53.9 $\Omega$ + 11.1 j $\Omega$	56.6 $\Omega$ + 12.2 j $\Omega$	2.7 $\Omega$ (Real part)

#### Return Loss

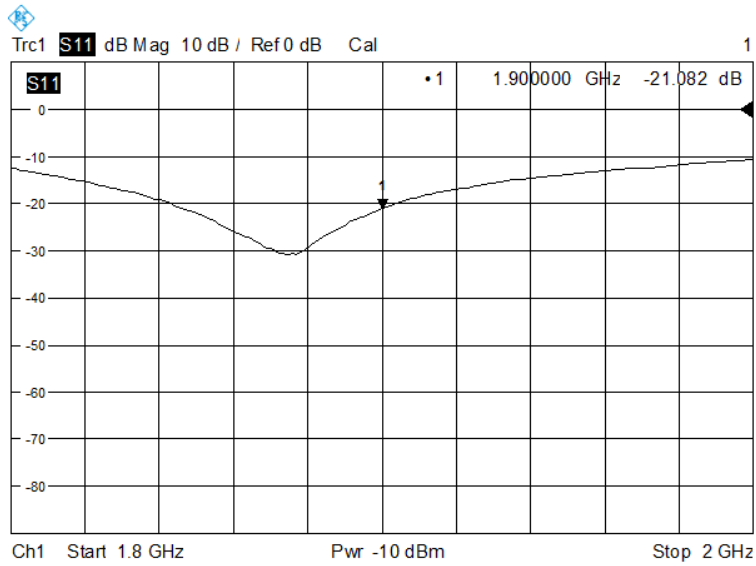

#### Impedance

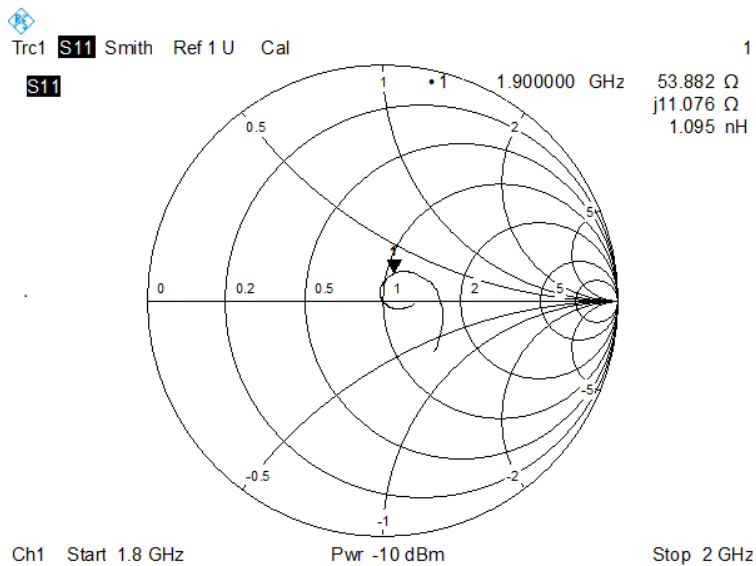

**RETURN LOSS AND IMPEDANCE IN BODY LIQUID**

Meas. Results	Current Meas.	Previous Meas.	Max. Deviation
Return Loss (dB)	-20.62	-21.79	5.4 %
Impedance	50.2 $\Omega$ + 12.6 j $\Omega$	51.0 $\Omega$ + 13.2 j $\Omega$	0.8 $\Omega$ (Real part)

**Return Loss**

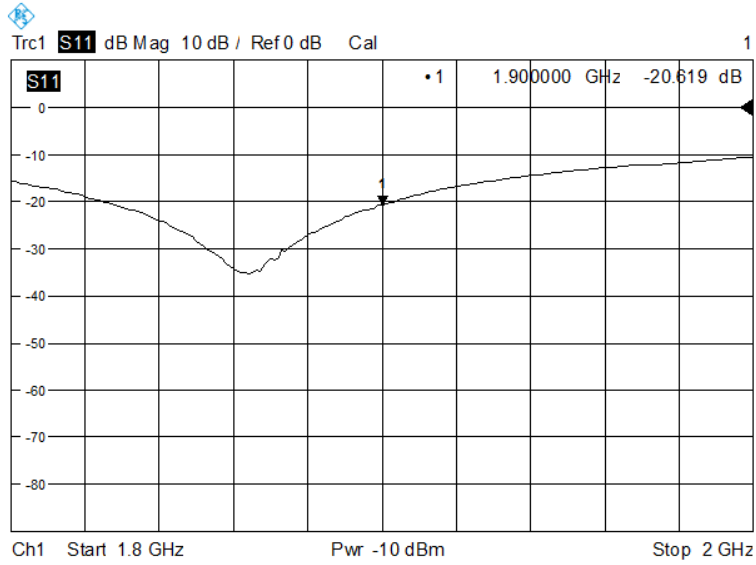

**Impedance**

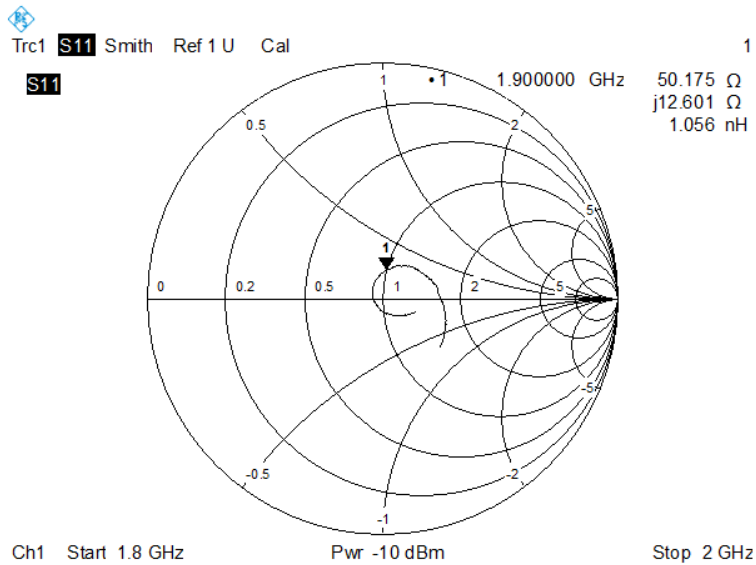

### 3.6 DIP 2G000

#### RETURN LOSS AND IMPEDANCE IN HEAD LIQUID

Meas. Results	Current Meas.	Previous Meas.	Max. Deviation
Return Loss (dB)	-23.91	-25.62	.7%
Impedance	56.6 $\Omega$ - 0.4 j $\Omega$	54.3 $\Omega$ - 4.1 j $\Omega$	3.7 $\Omega$ (Imaginary part)

#### Return Loss

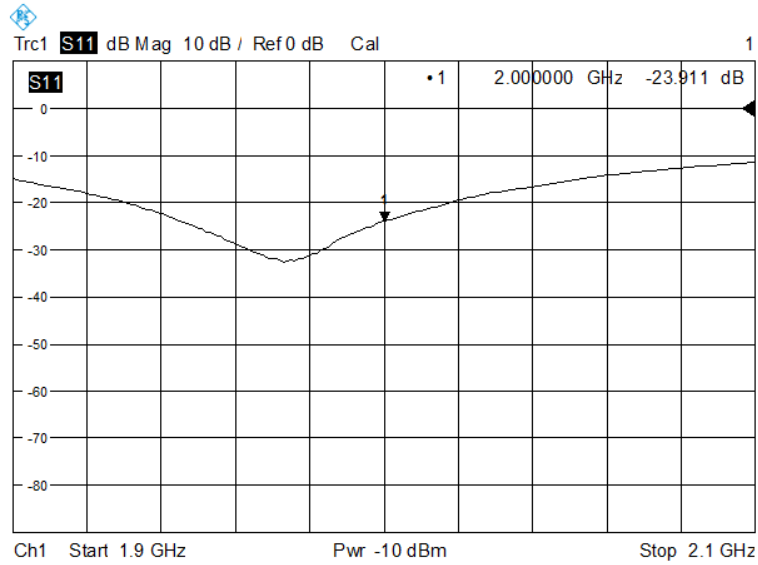

#### Impedance

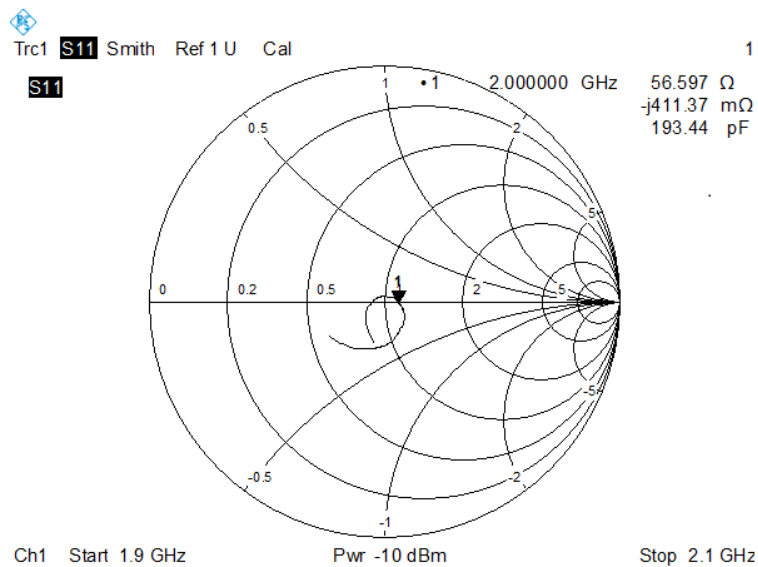



**RETURN LOSS AND IMPEDANCE IN BODY LIQUID**

Meas. Results	Current Meas.	Previous Meas.	Max. Deviation
Return Loss (dB)	-22.23	-22.40	0.8 %
Impedance	58.6 $\Omega$ + 2.20 j $\Omega$	55.7 $\Omega$ + 2.61 j $\Omega$	2.9 $\Omega$ (Real part)

**Return Loss**

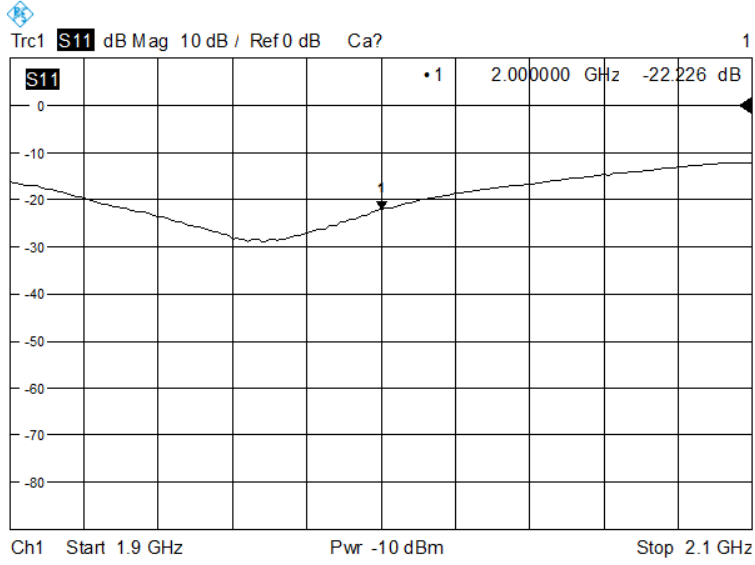

**Impedance**

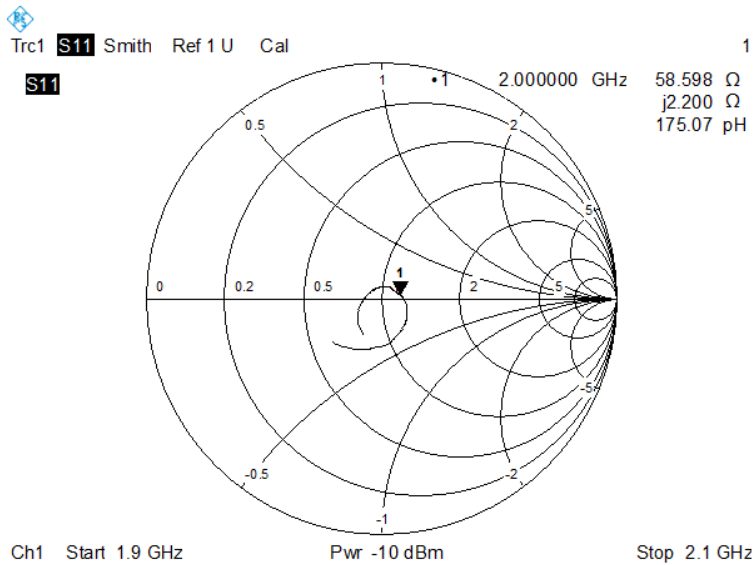

### 3.7 DIP 2G450

#### RETURN LOSS AND IMPEDANCE IN HEAD LIQUID

Meas. Results	Current Meas.	Previous Meas.	Max. Deviation
Return Loss (dB)	-23.17	-23.68	2.2 %
Impedance	48.3 $\Omega$ + 6.5 j $\Omega$	47.0 $\Omega$ + 5.8 j $\Omega$	1.3 $\Omega$ (Real part)

#### Return Loss

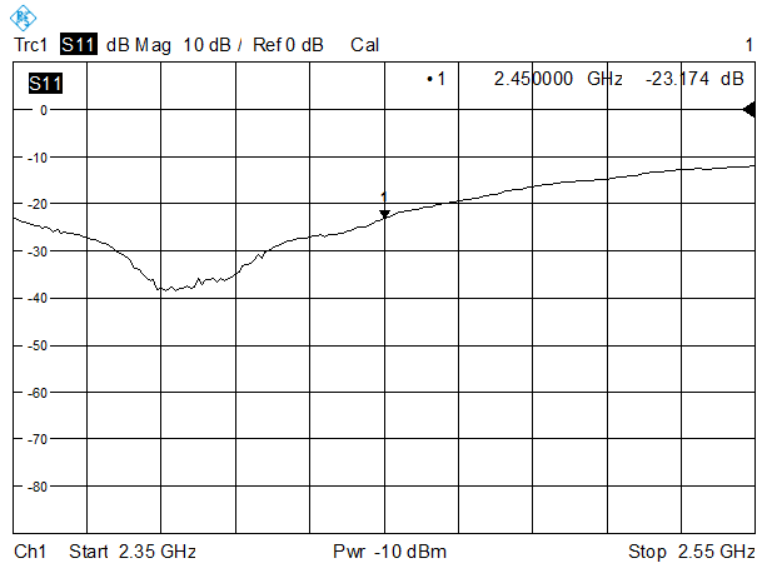

#### Impedance

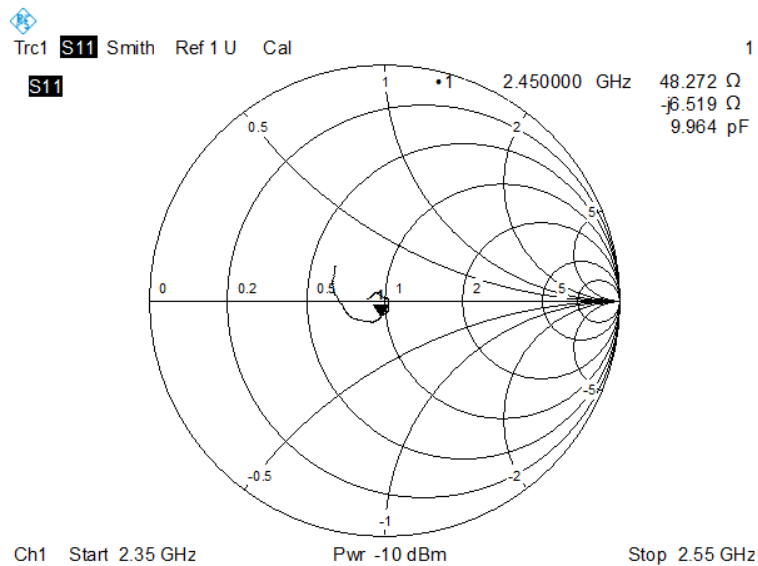

**RETURN LOSS AND IMPEDANCE IN BODY LIQUID**

Meas. Results	Current Meas.	Previous Meas.	Max. Deviation
Return Loss (dB)	-24.06	-24.48	3.5 %
Impedance	49.8 Ω – 9.4 jΩ	49.4 Ω – 5.9 jΩ	3.5 Ω (Imaginary part)

**Return Loss**

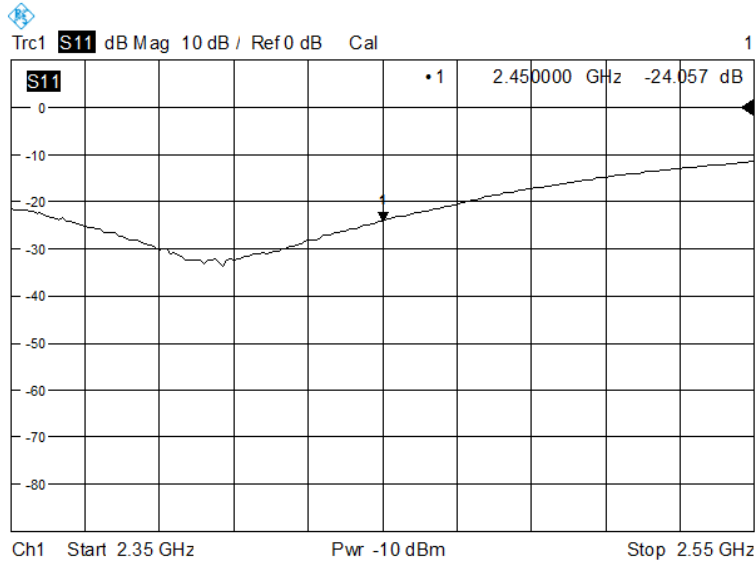

.0

**Impedance**

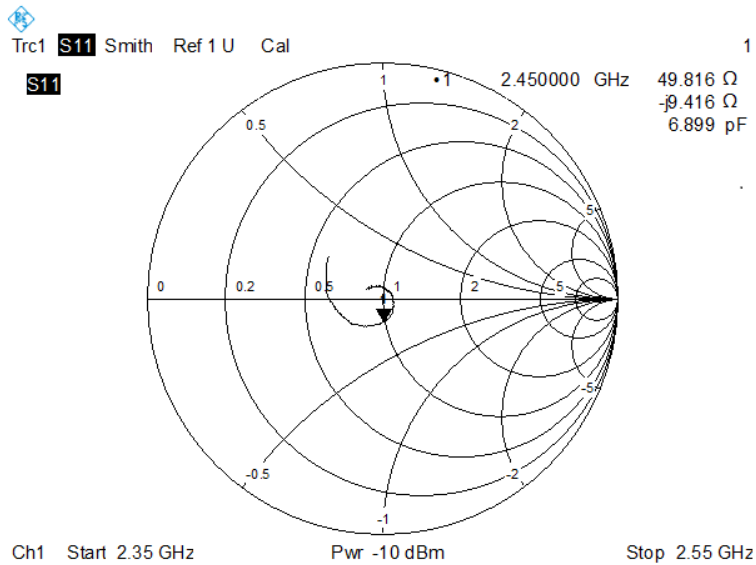



### 3.8 DIP 2G600

#### RETURN LOSS AND IMPEDANCE IN HEAD LIQUID

Meas. Results	Current Meas.	Previous Meas.	Max. Deviation
Return Loss (dB)	-21.11	-20.83	1.34 %
Impedance	50.2 $\Omega$ + 8.9 j $\Omega$	51.0 $\Omega$ + 11.4 j $\Omega$	2.5 $\Omega$ (Imaginary part)

#### Return Loss

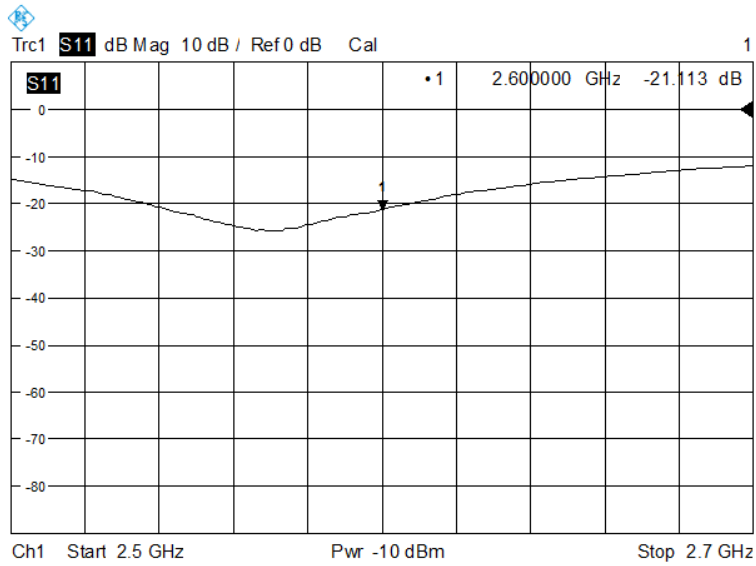

#### Impedance

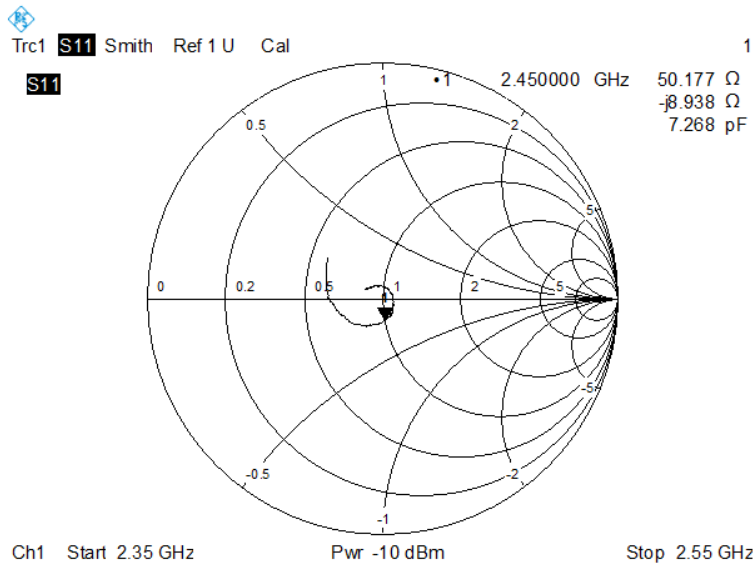

**RETURN LOSS AND IMPEDANCE IN BODY LIQUID**

Meas. Results	Current Meas.	Previous Meas.	Max. Deviation
Return Loss (dB)	-22.31	-21.11	5.7 %
Impedance	46.7 $\Omega$ + 12.4 j $\Omega$	47.6 $\Omega$ + 11.1 j $\Omega$	1.3 $\Omega$ (Imaginary part)

**Return Loss**

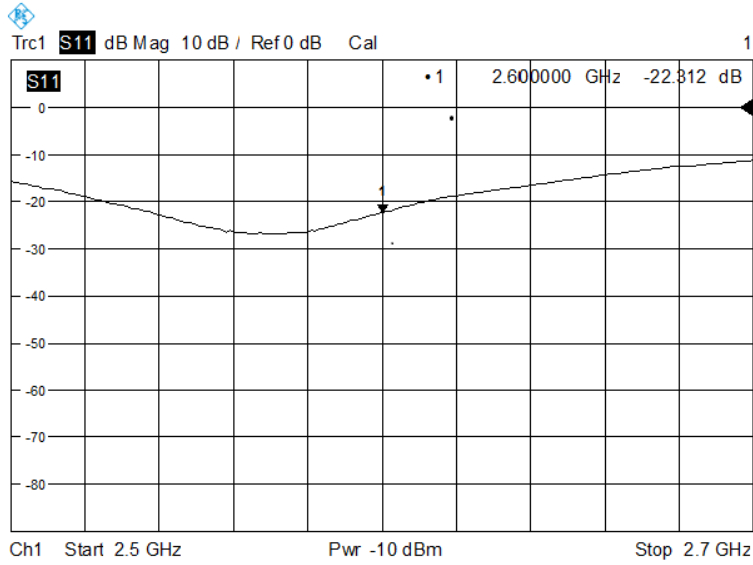

**Impedance**

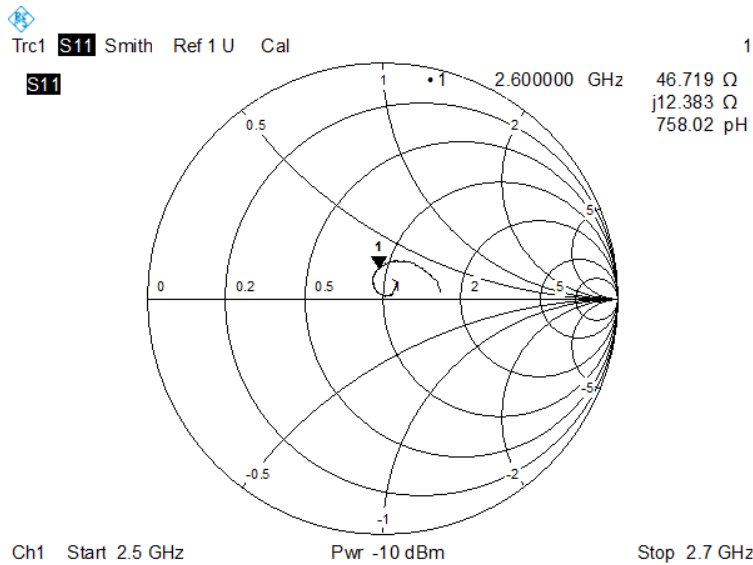



## 4 WAVEGUIDE IMPEDANCE AND RETURN LOSS

The waveguide are designed to have low return loss when presented against a flat phantom at the specified distance. A Vector Network Analyzer was used to perform a return loss measurement on the specific waveguide when in the measurement location against the phantom and the distance was specified by the manufacturer with a special, low loss and low relative permittivity spacer.

The impedance was measured at the SMA-connector with the network analyzer.

### 4.1 SWG5500

#### RETURN LOSS AND IMPEDANCE IN HEAD LIQUID

Frequency (MHz)	Return Loss (dB)	Requirement (dB)	Impedance
5200	-10.94	-8.0	27.8 $\Omega$ + 9.6 j $\Omega$
5400	-12.04	-8.0	83.7 $\Omega$ + 12.3 j $\Omega$
5600	-17.91	-8.0	42.6 $\Omega$ - 7.2 j $\Omega$
5800	-15.79	-8.0	56.4 $\Omega$ + 20.3 j $\Omega$

#### Return Loss

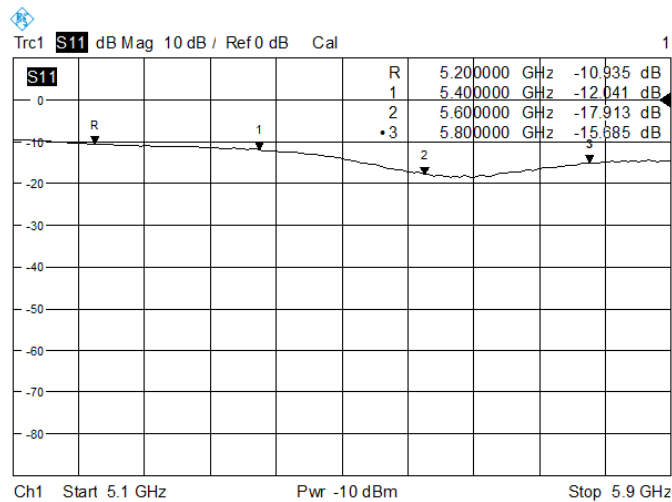

#### Impedance

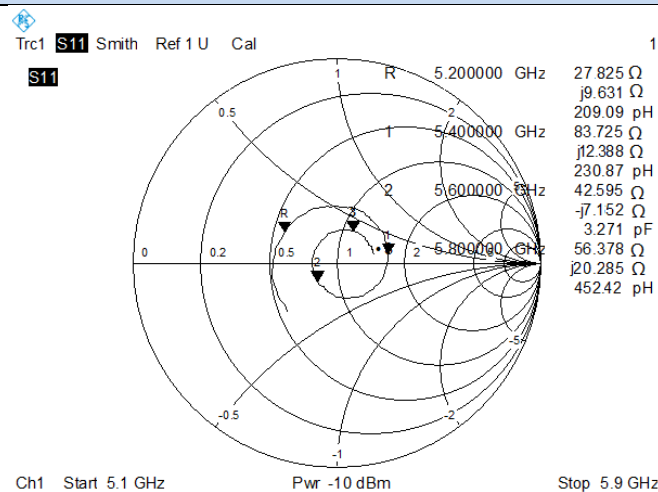



**RETURN LOSS AND IMPEDANCE IN BODY LIQUID**

Frequency (MHz)	Return Loss (dB)	Requirement (dB)	Impedance
5200	-9.84	-8.0	26.3 $\Omega$ + 9.5 j $\Omega$
5400	-10.04	-8.0	95.6 $\Omega$ + 7.5 j $\Omega$
5600	-15.91	-8.0	37.0 $\Omega$ - 7.8 j $\Omega$
5800	-13.93	-8.0	56.8 $\Omega$ + 27.7 j $\Omega$

**Return Loss**

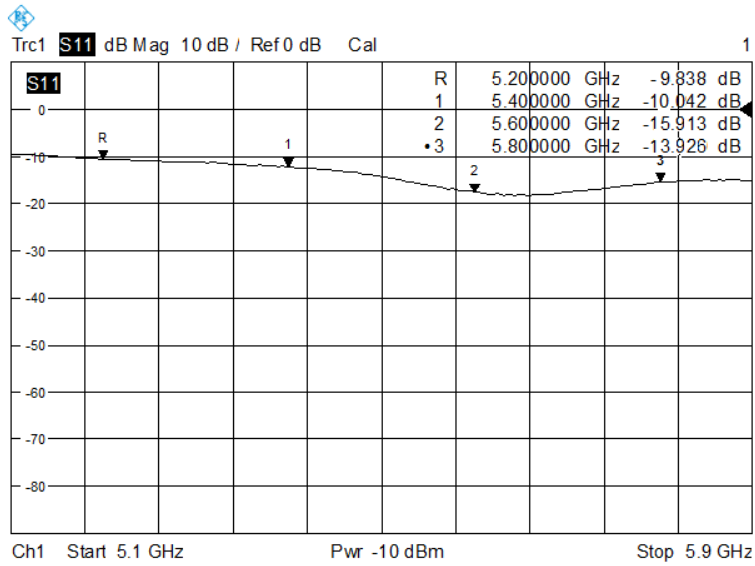

**Impedance**

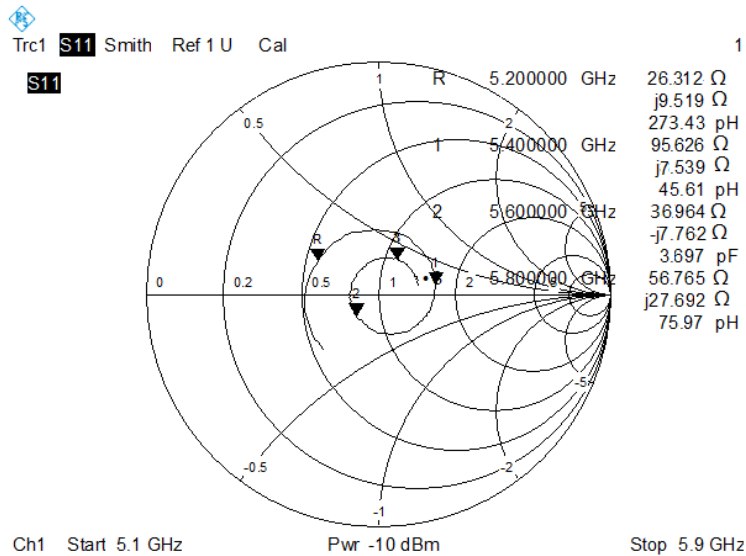





## 5.1 Dipole and Waveguide SAR Validation Measurement Result

Freq. (MHz)	Liquid Type	Power (mW)	1 g Measured SAR (W/kg)	Normalized SAR (W/kg)	10 g Measured SAR (W/kg)	Normalized SAR (W/kg)	1 g Targeted SAR (W/kg)	Tolerance (%)	10 g Targeted SAR (W/kg)	Tolerance (%)
750	Head	100	0.864	8.64	0.573	5.73	8.49	1.77	5.55	3.24
	Body	100	0.865	8.65	0.589	5.89	8.49	1.88	5.55	6.13
835	Head	100	0.977	9.77	0.603	6.03	9.56	2.20	6.22	-3.05
	Body	100	1.009	10.09	0.661	6.61	9.56	5.54	6.22	6.27
900	Head	100	1.086	10.86	0.723	7.23	10.9	-0.37	6.99	3.43
	Body	100	1.140	11.40	0.752	7.52	10.9	4.59	6.99	7.58
1800	Head	100	3.888	38.88	1.966	19.66	38.40	1.25	20.10	-2.19
	Body	100	3.923	39.23	1.992	19.92	38.40	2.16	20.10	-0.90
1900	Head	100	3.902	39.02	1.922	19.22	39.70	-1.71	20.50	-6.24
	Body	100	3.951	39.51	2.010	20.10	39.70	-0.48	20.50	-1.95
2000	Head	100	4.020	40.20	2.063	20.63	41.10	-2.19	21.10	-2.23
	Body	100	4.215	42.15	2.153	21.53	41.10	2.55	21.10	2.04
2450	Head	100	5.303	53.03	2.479	24.79	52.40	1.20	24.00	3.29
	Body	100	5.103	51.03	2.448	24.48	52.40	-2.61	24.00	2.00
2600	Head	100	5.337	53.37	2.507	25.07	55.30	-3.49	24.60	1.91
	Body	100	5.168	51.68	2.375	23.75	55.30	-6.55	24.60	-3.46
5200	Head	100	15.372	153.72	5.458	54.58	159.00	-3.32	56.90	-4.08
	Body	100	15.227	152.27	5.328	53.28	159.00	-4.23	56.90	-6.36
5400	Head	100	15.893	158.93	5.522	55.22	166.40	-4.49	58.43	-5.49
	Body	100	15.760	157.60	5.602	56.02	166.40	-5.29	58.43	-4.12
5600	Head	100	16.458	164.58	5.788	57.88	173.80	-5.30	59.97	-3.49
	Body	100	15.892	158.92	5.643	56.43	173.80	-8.56	59.97	-5.90
5800	Head	100	17.698	176.98	5.986	59.86	181.20	-2.33	61.50	-2.67
	Body	100	16.971	169.71	5.843	58.43	181.20	-6.34	61.50	-4.99

## 5.2 DIP 0G750

### 5.2.1 Dipole 750 MHz Validation Measurement for Head Tissue

## System Performance Check Data(750 MHz Head)

Type: Phone measurement (Complete)  
 E-Field Probe: SN 34/15 SSE2 EPGO265  
 Area scan resolution: dx=8mm,dy=8mm  
 Zoom scan resolution: dx=8mm, dy=8mm, dz=5mm  
 Date of measurement: 2017.03.01  
 Measurement duration: 13 minutes 33 seconds

### Experimental conditions.

<b>Phantom File</b>	surf_sam_plan.txt
<b>Phantom</b>	Validation plane
<b>Band</b>	750MHz
<b>Signal</b>	CW
<b>Frequency (MHz)</b>	750MHz
<b>Relative permittivity (real part)</b>	41.882519
<b>Conductivity (S/m)</b>	0.898232
<b>Power drift (%)</b>	-2.200000
<b>Ambient Temperature:</b>	21.9°C
<b>Liquid Temperature:</b>	20.8°C
<b>ConvF:</b>	1.81
<b>Crest factor:</b>	1:1

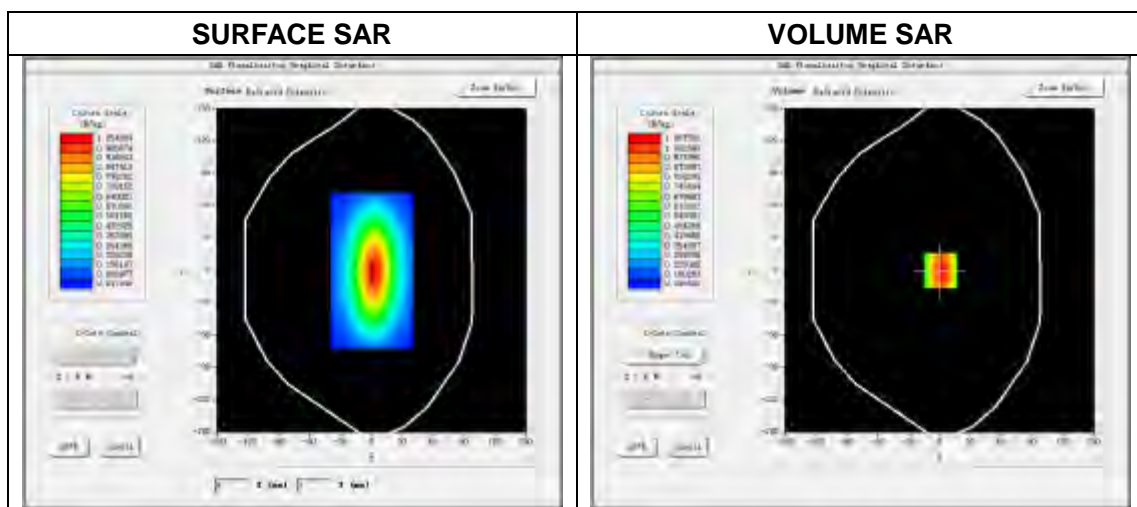

Maximum location: X=1.00, Y=0.00

SAR Peak: 1.19 W/kg

SAR 10g (W/Kg)	0.572936
SAR 1g (W/Kg)	0.863754

### Z Axis Scan

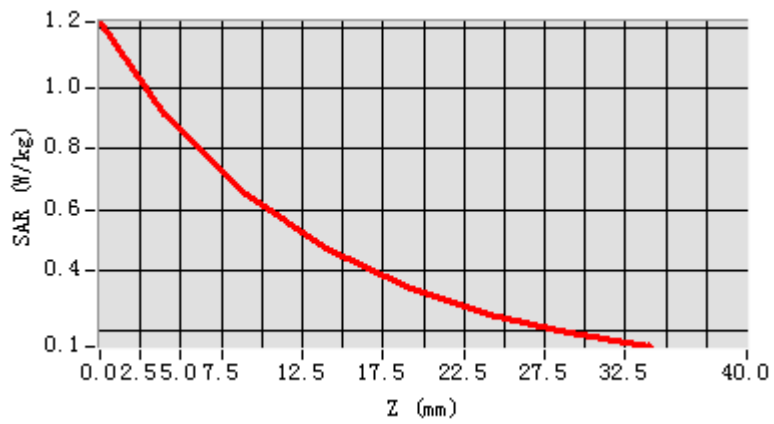

3D screen shot

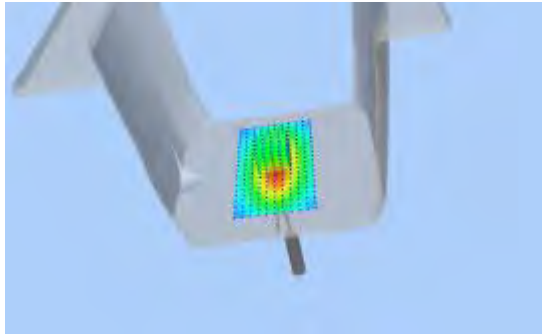

Hot spot position

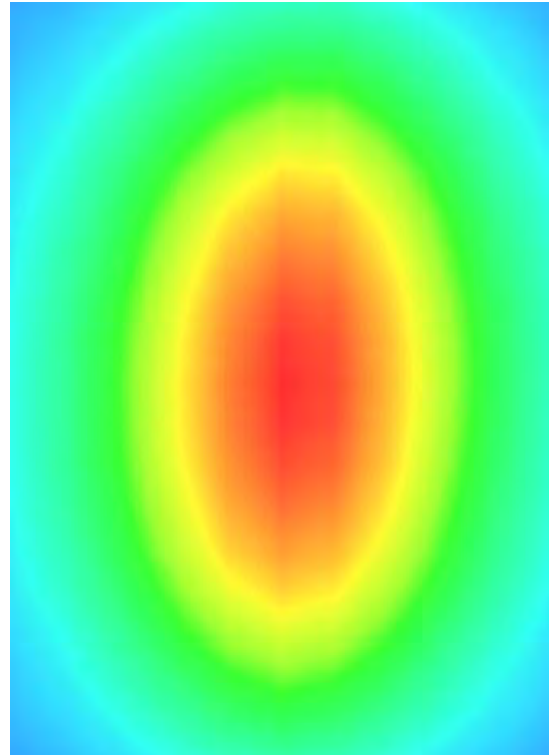

## 5.2.2 Dipole 750 MHz Validation Measurement for Body Tissue

# System Performance Check Data(750 MHz Body)

Type: Phone measurement (Complete)  
 E-Field Probe: SN 34/15 SSE2 EPGO265  
 Area scan resolution: dx=8mm,dy=8mm  
 Zoom scan resolution: dx=8mm, dy=8mm, dz=5mm  
 Date of measurement: 2017.03.01  
 Measurement duration: 13 minutes 32 seconds

### Experimental conditions.

Phantom File	surf_sam_plan.txt
Phantom	Validation plane
Band	750MHz
Signal	CW
Frequency (MHz)	750MHz
Relative permittivity (real part)	56.892521
Conductivity (S/m)	0.931288
Power drift (%)	-0.600000
Ambient Temperature:	21.9°C
Liquid Temperature:	20.8°C
ConvF:	1.88
Crest factor:	1:1

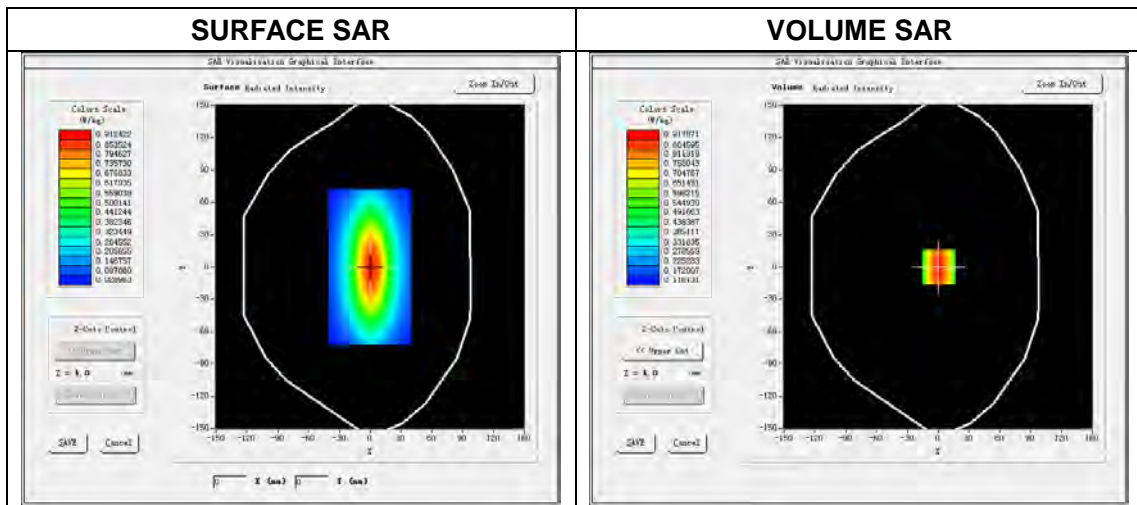

Maximum location: X=1.00, Y=0.00

SAR Peak: 1.29 W/kg

SAR 10g (W/Kg)	0.589147
SAR 1g (W/Kg)	0.865284

### Z Axis Scan

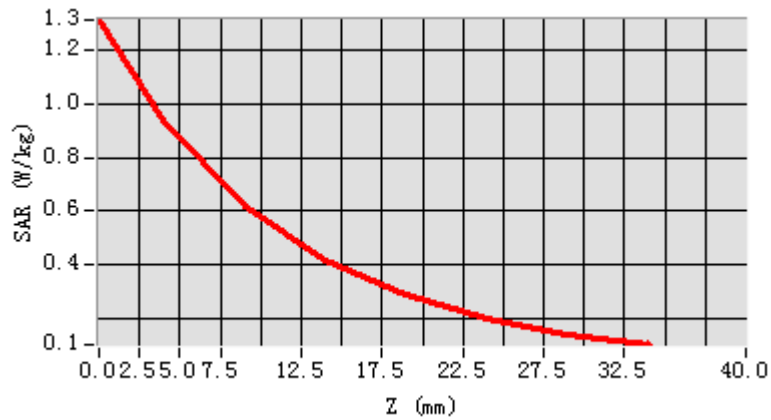

3D screen shot

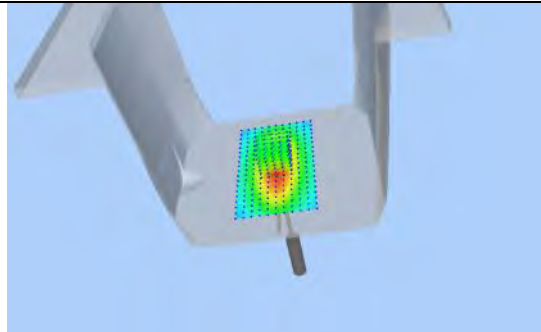

Hot spot position

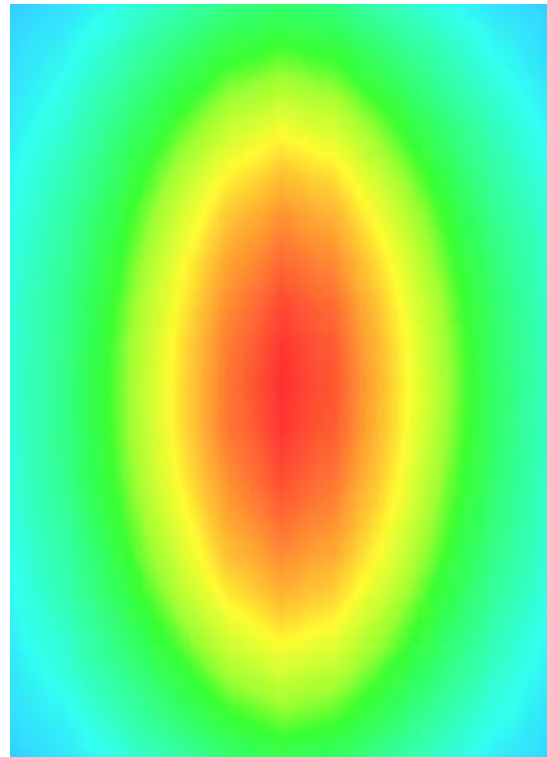



### 5.3 DIP 0G835

#### 5.3.1 Dipole 835 MHz Validation Measurement for Head Tissue

## System Performance Check Data(835 MHz Head)

Type: Phone measurement (Complete)  
 E-Field Probe: SN 34/15 SSE2 EPGO265  
 Area scan resolution: dx=8 mm,dy=8 mm  
 Zoom scan resolution: dx=8 mm, dy=8 mm, dz=5 mm  
 Date of measurement: 2017.03.01  
 Measurement duration: 14 minutes 12 seconds

### Experimental conditions.

<b>Phantom File</b>	surf_sam_plan.txt
<b>Phantom</b>	Validation plane
<b>Band</b>	835 MHz
<b>Signal</b>	CW
<b>Frequency (MHz)</b>	835.000000
<b>Relative permittivity (real part)</b>	42.956251
<b>Conductivity (S/m)</b>	0.883985
<b>Power drift (%)</b>	-0.350000
<b>Ambient Temperature:</b>	21.6°C
<b>Liquid Temperature:</b>	21.1°C
<b>ConvF:</b>	2.04
<b>Crest factor:</b>	1:1

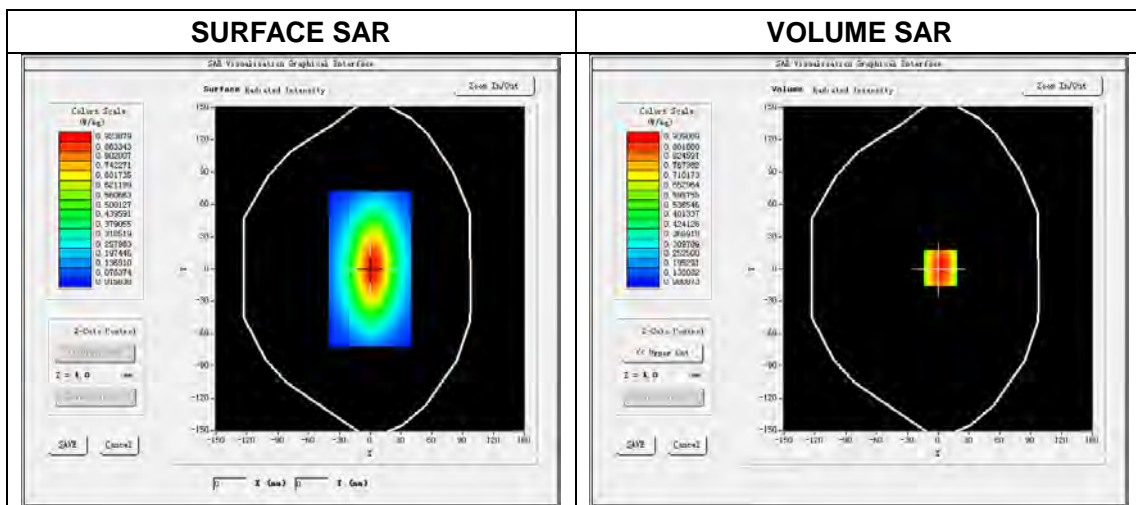

Maximum location: X=0.00, Y=0.00

SAR Peak: 1.40 W/kg

SAR 10 g (W/Kg)	0.602548
SAR 1 g (W/Kg)	0.976925

### Z Axis Scan

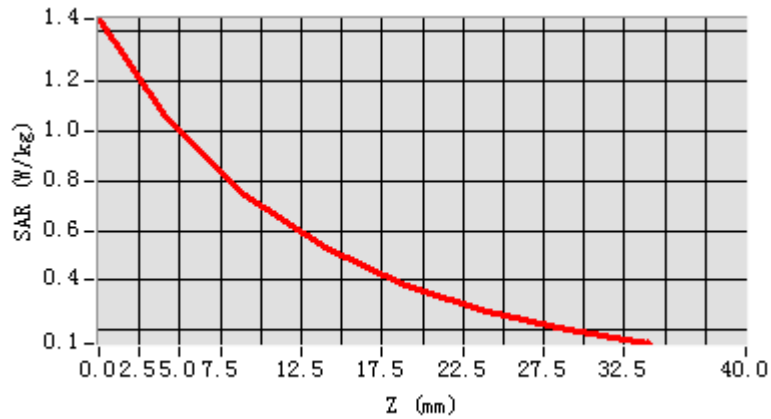

3D screen shot

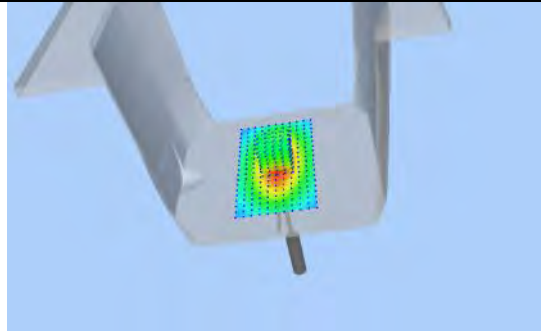

Hot spot position

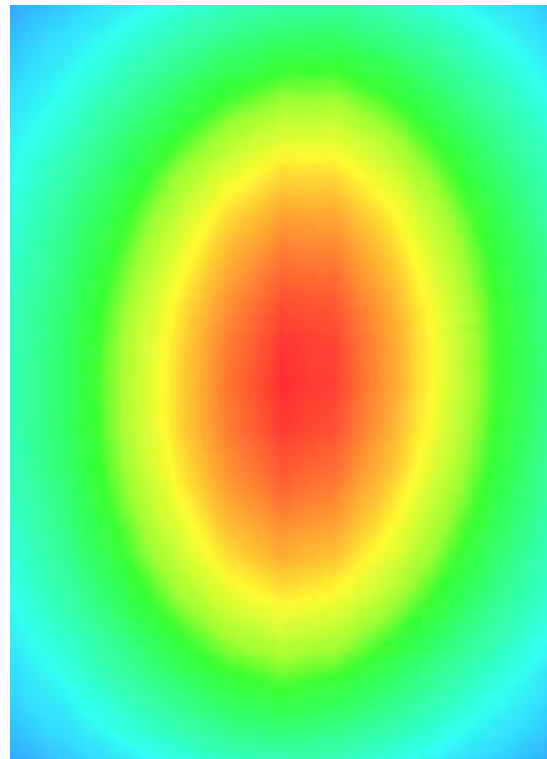

### 5.3.2 Dipole 835 MHz Validation Measurement for Body Tissue

## System Performance Check Data(835 MHz Body)

Type: Phone measurement (Complete)  
 E-Field Probe: SN 34/15 SSE2 EPGO265  
 Area scan resolution: dx=8 mm,dy=8 mm  
 Zoom scan resolution: dx=8 mm, dy=8 mm, dz=5 mm  
 Date of measurement: 2017.03.01  
 Measurement duration: 14 minutes 8 seconds

### Experimental conditions.

Phantom File	surf_sam_plan.txt
Phantom	Validation plane
Band	835 MHz
Signal	CW
Frequency (MHz)	835.000000
Relative permittivity (real part)	54.269521
Conductivity (S/m)	0.980688
Power drift (%)	0.390000
Ambient Temperature:	21.6°C
Liquid Temperature:	21.1°C
ConvF:	2.12
Crest factor:	1:1

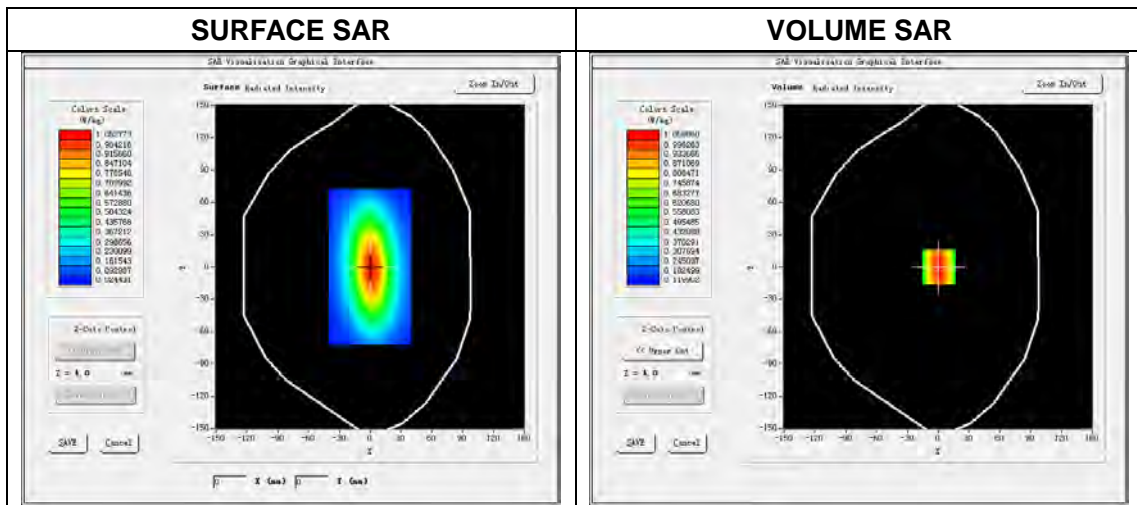

Maximum location: X=0.00, Y=0.00

SAR Peak: 1.46 W/kg

SAR 10 g (W/Kg)	0.661254
SAR 1 g (W/Kg)	1.009362

### Z Axis Scan

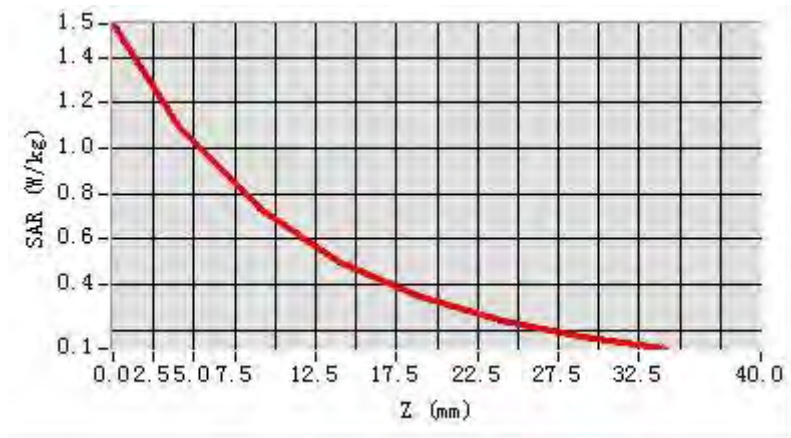

### 3D screen shot

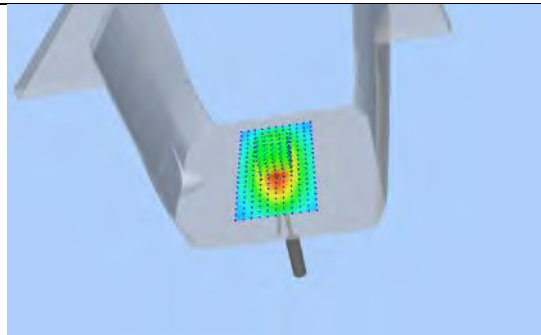

### Hot spot position

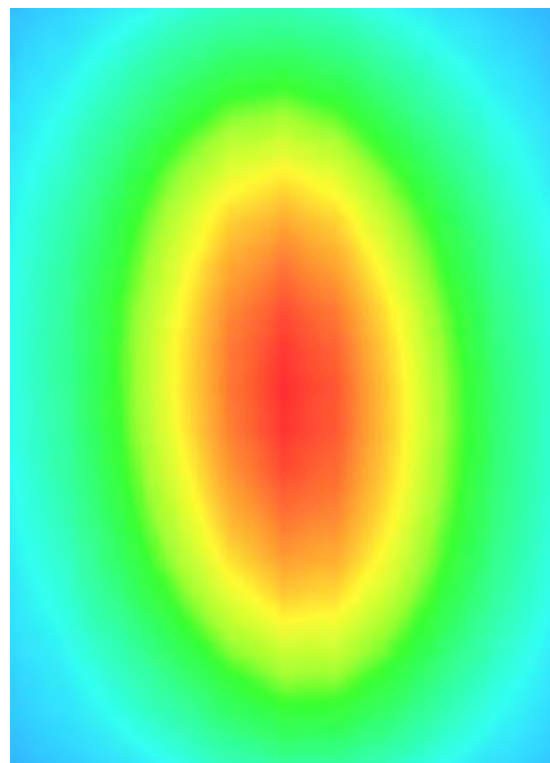

## 5.4 DIP 0G900

### 5.4.1 Dipole 900 MHz Validation Measurement for Head Tissue

# System Performance Check Data(900 MHz Head)

Type: Phone measurement (Complete)

E-Field Probe: SN 34/15 SSE2 EPGO265

Area scan resolution: dx=8 mm,dy=8 mm

Zoom scan resolution: dx=8 mm, dy=8 mm, dz=5 mm

Date of measurement: 2017.03.01

Measurement duration: 13 minutes 59 seconds

### Experimental conditions.

<b>Phantom File</b>	surf_sam_plan.txt
<b>Phantom</b>	Validation plane
<b>Band</b>	900 MHz
<b>Signal</b>	CW
<b>Frequency (MHz)</b>	900.000000
<b>Relative permittivity (real part)</b>	41.012785
<b>Conductivity (S/m)</b>	0.982695
<b>Power drift (%)</b>	0.240000
<b>Ambient Temperature:</b>	21.9°C
<b>Liquid Temperature:</b>	20.8°C
<b>ConvF:</b>	1.86
<b>Crest factor:</b>	1:1

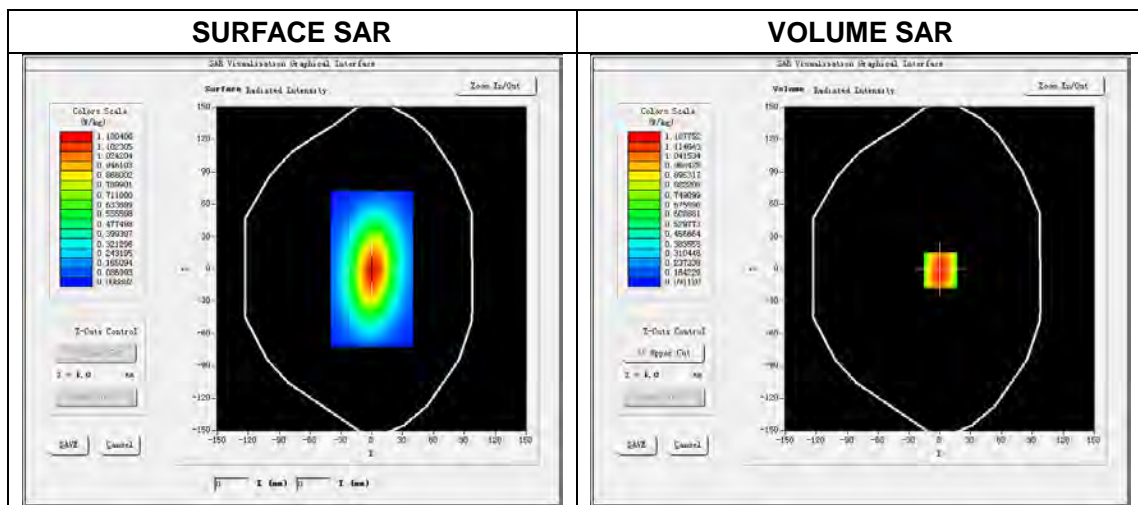

Maximum location: X=0.00, Y=0.00

SAR Peak: 1.59 W/kg

SAR 10 g (W/Kg)	0.722569
SAR 1 g (W/Kg)	1.086216

### Z Axis Scan

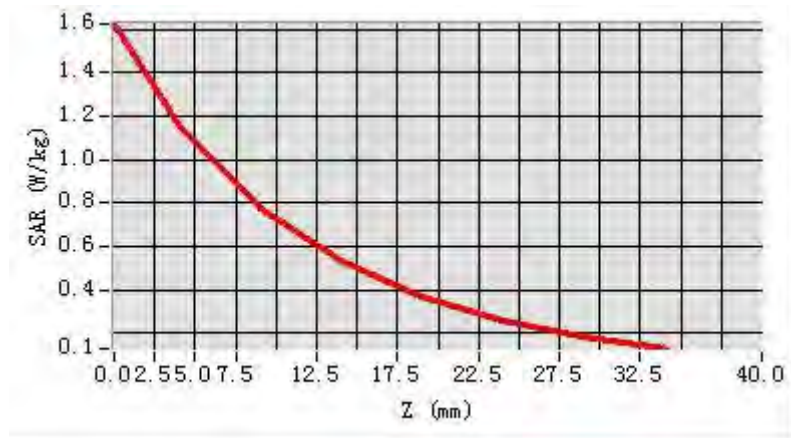

### 3D screen shot

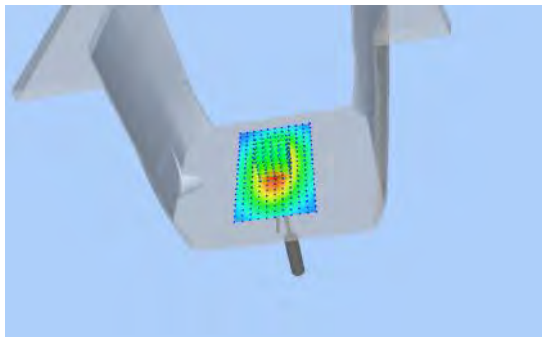

### Hot spot position

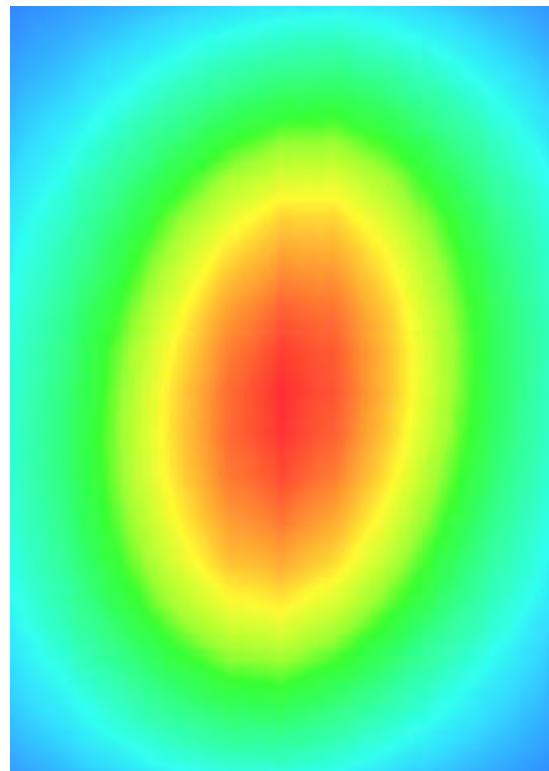

## 5.4.2 Dipole 900 MHz Validation Measurement for Body Tissue

# System Performance Check Data(900 MHz Body)

Type: Phone measurement (Complete)  
 E-Field Probe: SN 34/15 SSE2 EPGO265  
 Area scan resolution: dx=8 mm,dy=8 mm  
 Zoom scan resolution: dx=8 mm, dy=8 mm, dz=5 mm  
 Date of measurement: 2017.03.01  
 Measurement duration: 13 minutes 49 seconds

### Experimental conditions.

<b>Phantom File</b>	surf_sam_plan.txt
<b>Phantom</b>	Validation plane
<b>Band</b>	900 MHz
<b>Signal</b>	CW
<b>Frequency (MHz)</b>	900.000000
<b>Relative permittivity (real part)</b>	53.623571
<b>Conductivity (S/m)</b>	1.07252
<b>Power drift (%)</b>	-0.370000
<b>Ambient Temperature:</b>	21.9°C
<b>Liquid Temperature:</b>	20.8°C
<b>ConvF:</b>	1.92
<b>Crest factor:</b>	1:1

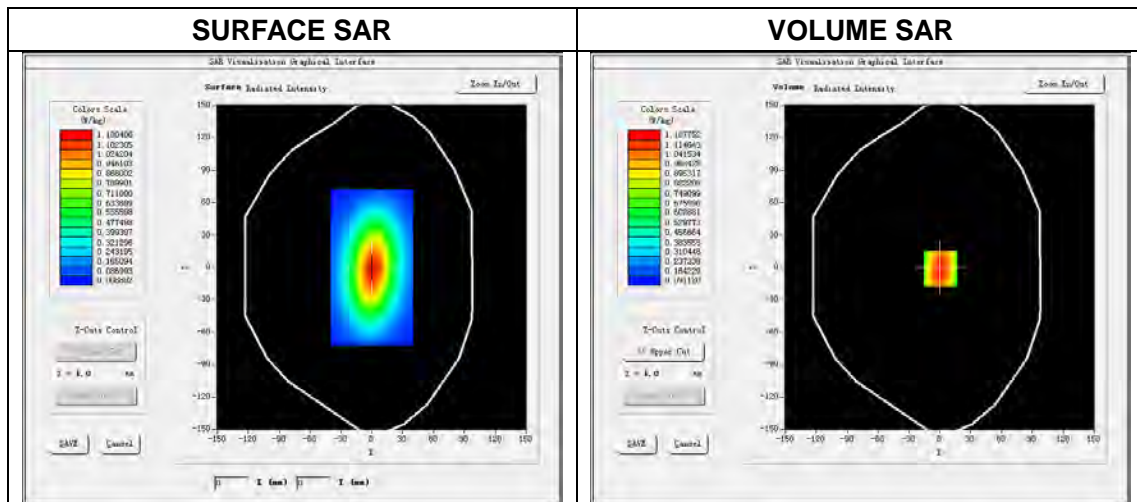

Maximum location: X=0.00, Y=0.00

SAR Peak: 1.69 W/kg

SAR 10 g (W/Kg)	0.752336
SAR 1 g (W/Kg)	1.140385

### Z Axis Scan

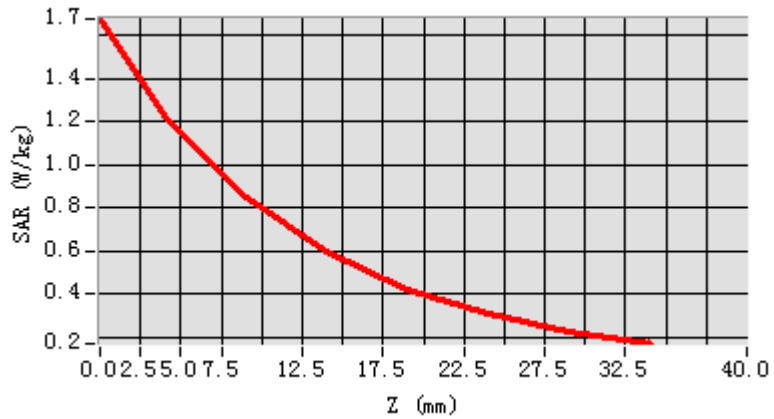

3D screen shot

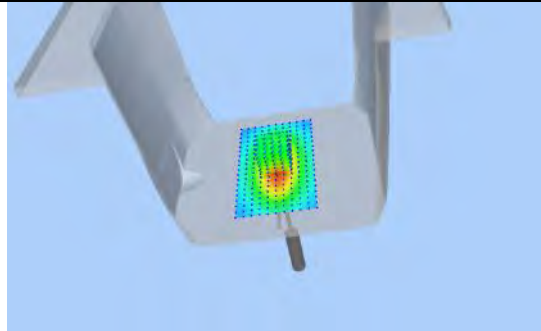

Hot spot position

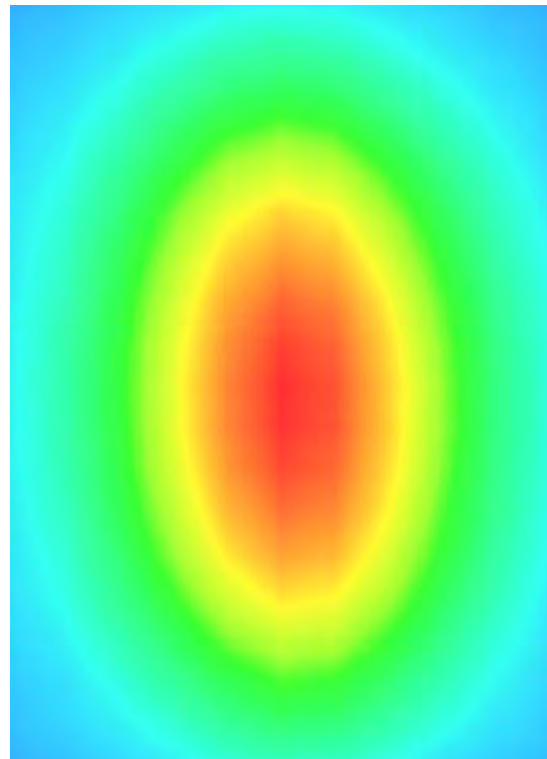



## 5.5 DIP 1G800

### 5.5.1 Dipole 1800 MHz Validation Measurement for Head Tissue

## System Performance Check Data(1800 MHz Head)

Type: Phone measurement (Complete)  
 E-Field Probe: SN 34/15 SSE2 EPGO265  
 Area scan resolution: dx=8mm,dy=8mm  
 Zoom scan resolution: dx=8mm, dy=8mm, dz=5mm  
 Date of measurement: 2017.03.02  
 Measurement duration: 13 minutes 39 seconds

### Experimental conditions.

<b>Phantom File</b>	surf_sam_plan.txt
<b>Phantom</b>	Validation plane
<b>Band</b>	1800MHz
<b>Signal</b>	CW
<b>Frequency (MHz)</b>	1800.000000
<b>Relative permittivity (real part)</b>	38.812571
<b>Conductivity (S/m)</b>	1.422596
<b>Power drift (%)</b>	0.330000
<b>Ambient Temperature:</b>	22.4°C
<b>Liquid Temperature:</b>	21.3°C
<b>ConvF:</b>	2.04
<b>Crest factor:</b>	1:1

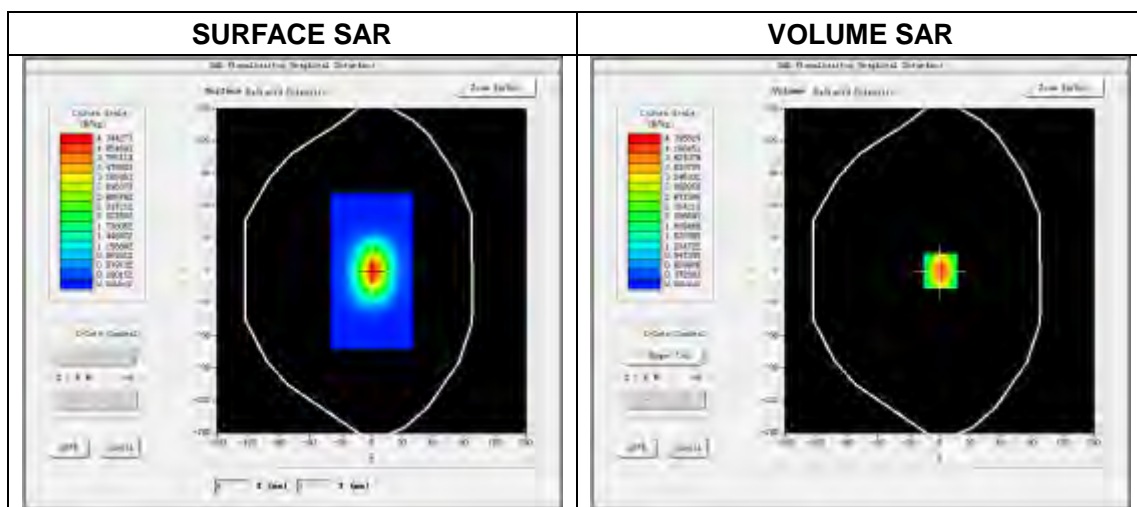

Maximum location: X=0.00, Y=0.00

SAR Peak: 6.48 W/kg

SAR 10 g (W/Kg)	1.965521
SAR 1g (W/Kg)	3.887922

### Z Axis Scan

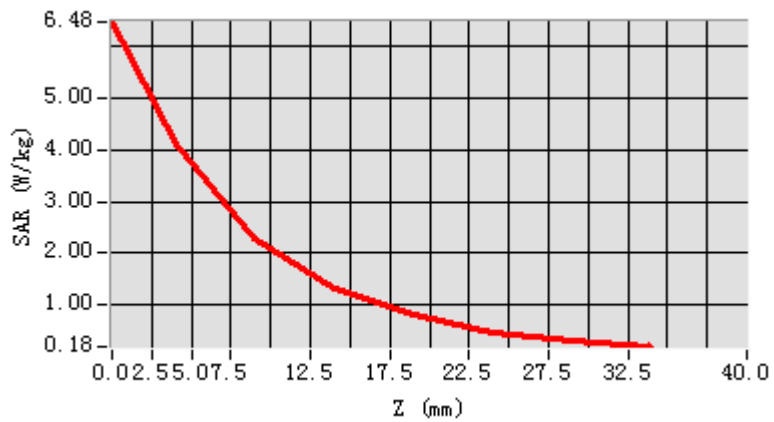

3D screen shot

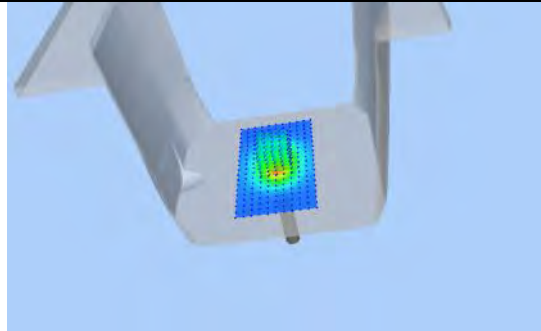

Hot spot position

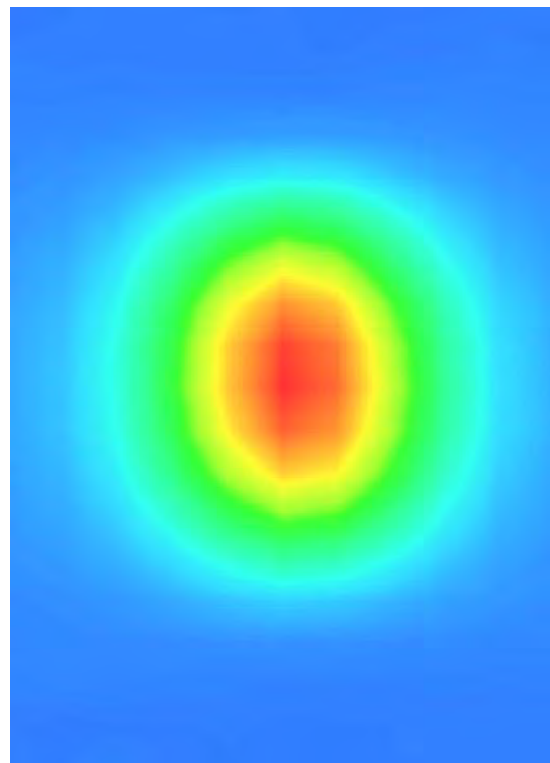

## 5.5.2 Dipole 1800 MHz Validation Measurement for Body Tissue

### System Performance Check Data(1800 MHz Body)

Type: Phone measurement (Complete)  
 E-Field Probe: SN 34/15 SSE2 EPGO265  
 Area scan resolution: dx=8mm,dy=8mm  
 Zoom scan resolution: dx=8mm, dy=8mm, dz=5mm  
 Date of measurement: 2017.03.02  
 Measurement duration: 13 minutes 52 seconds

#### Experimental conditions.

Phantom File	surf_sam_plan.txt
Phantom	Validation plane
Band	1800MHz
Signal	CW
Frequency (MHz)	1800.000000
Relative permittivity (real part)	54.352581
Conductivity (S/m)	1.492574
Power drift (%)	0.680000
Ambient Temperature:	22.4°C
Liquid Temperature:	21.3°C
ConvF:	2.08
Crest factor:	1:1

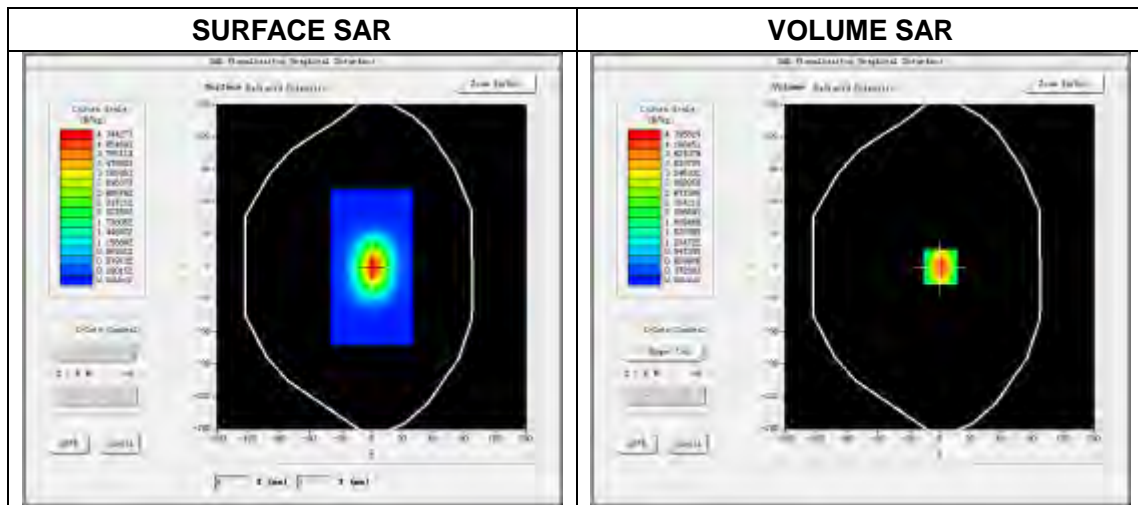

Maximum location: X=0.00, Y=0.00

SAR Peak: 6.55 W/kg

SAR 10 g (W/Kg)	1.992361
SAR 1g (W/Kg)	3.923758

### Z Axis Scan

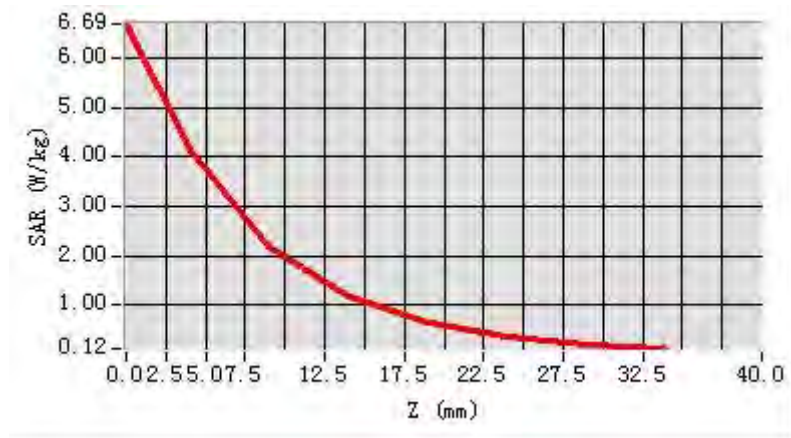

3D screen shot

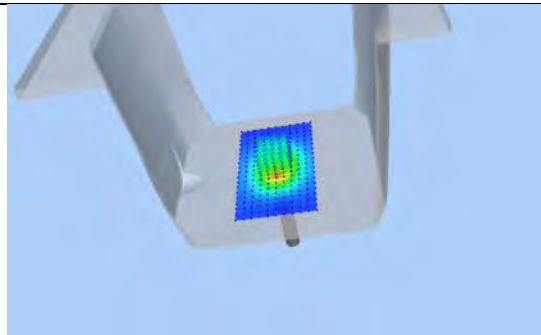

Hot spot position

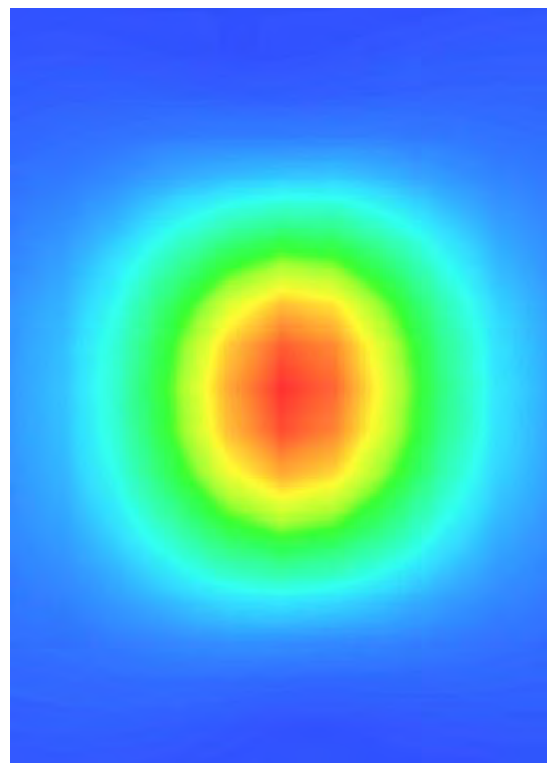



## 5.6 DIP 1G900

### 5.6.1 Dipole 1900 MHz Validation Measurement for Head Tissue

## System Performance Check Data(1900 MHz Head)

Type: Phone measurement (Complete)  
 E-Field Probe: SN 34/15 SSE2 EPGO265  
 Area scan resolution: dx=8mm,dy=8mm  
 Zoom scan resolution: dx=8mm, dy=8mm, dz=5mm  
 Date of measurement: 2017.03.02  
 Measurement duration: 13 minutes 42 seconds

### Experimental conditions.

<b>Phantom File</b>	surf_sam_plan.txt
<b>Phantom</b>	Validation plane
<b>Band</b>	1900MHz
<b>Signal</b>	CW
<b>Frequency (MHz)</b>	1900.000000
<b>Relative permittivity (real part)</b>	39.826257
<b>Conductivity (S/m)</b>	1.426126
<b>Power drift (%)</b>	1.190000
<b>Ambient Temperature:</b>	22.4°C
<b>Liquid Temperature:</b>	21.3°C
<b>ConvF:</b>	2.35
<b>Crest factor:</b>	1:1

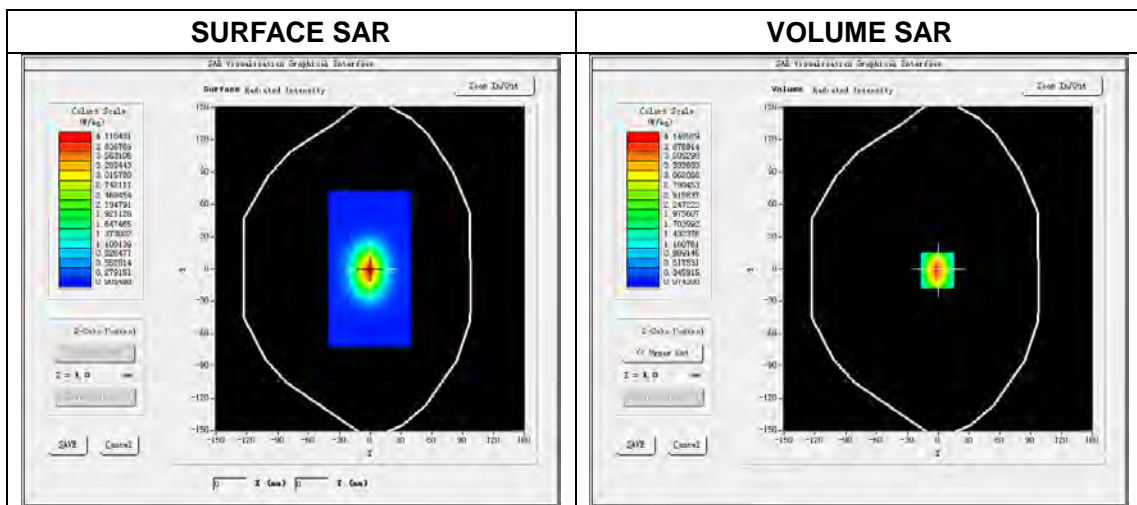

Maximum location: X=0.00, Y=0.00

SAR Peak: 6.49W/kg

SAR 10g (W/Kg)	1.921565
SAR 1g (W/Kg)	3.902425

### Z Axis Scan

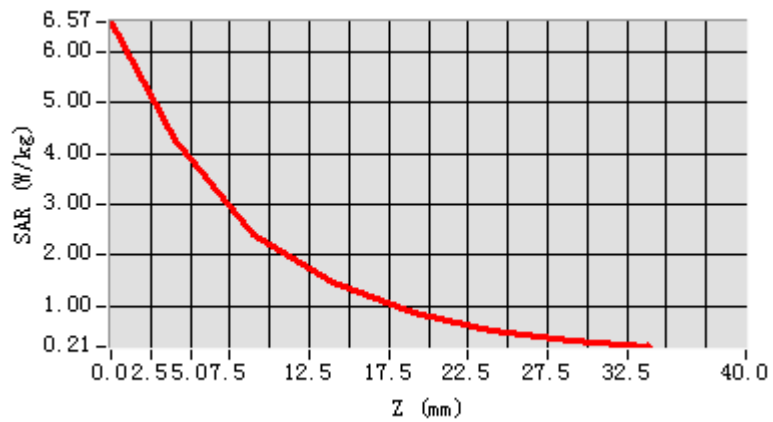

3D screen shot

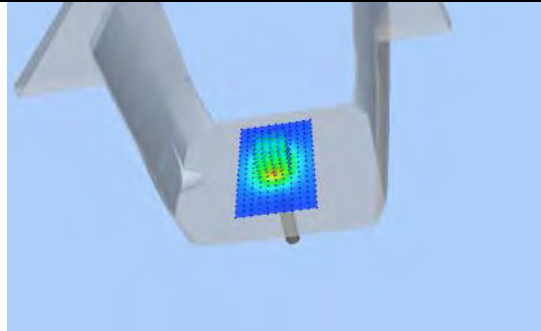

Hot spot position

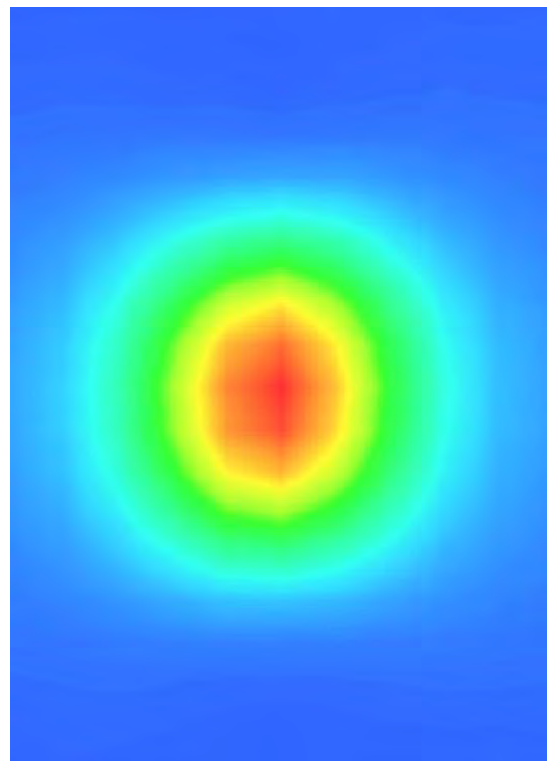

## 5.6.2 Dipole 1900 MHz Validation Measurement for Body Tissue

# System Performance Check Data(1900 MHz Body)

Type: Phone measurement (Complete)

E-Field Probe: SN 34/15 SSE2 EPGO265

Area scan resolution: dx=8mm,dy=8mm

Zoom scan resolution: dx=8mm, dy=8mm, dz=5mm

Date of measurement: 2017.03.02

Measurement duration: 13 minutes 38 seconds

### Experimental conditions.

Phantom File	surf_sam_plan.txt
Phantom	Validation plane
Band	1900 MHz
Signal	CW
Frequency (MHz)	1900.000000
Relative permittivity (real part)	54.023651
Conductivity (S/m)	1.540215
Power drift (%)	0.230000
Ambient Temperature:	22.4°C
Liquid Temperature:	21.3°C
ConvF:	2.42
Crest factor:	1:1

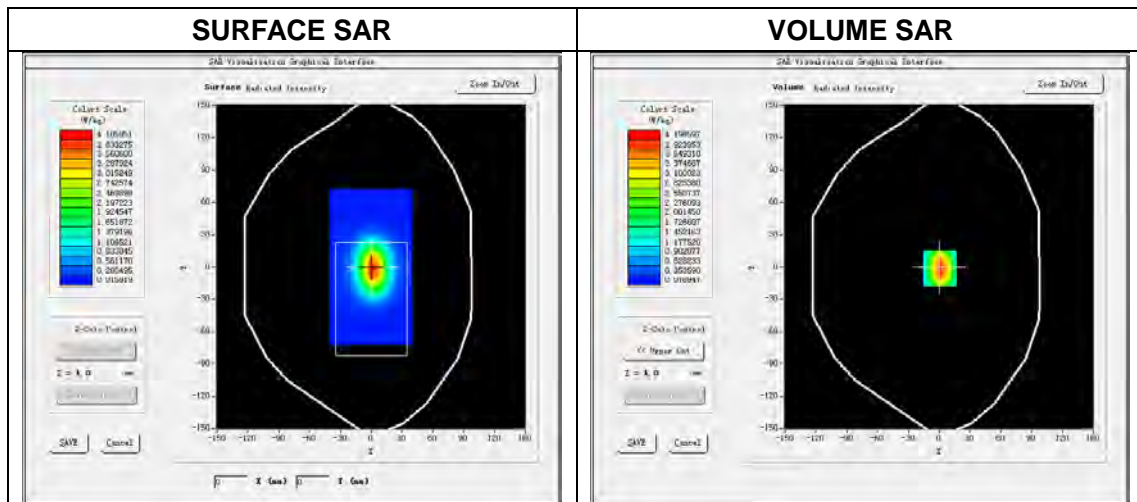

Maximum location: X=0.00, Y=0.00

SAR Peak: 6.66W/kg

SAR 10g (W/Kg)	2.010256
SAR 1g (W/Kg)	3.951364

### Z Axis Scan

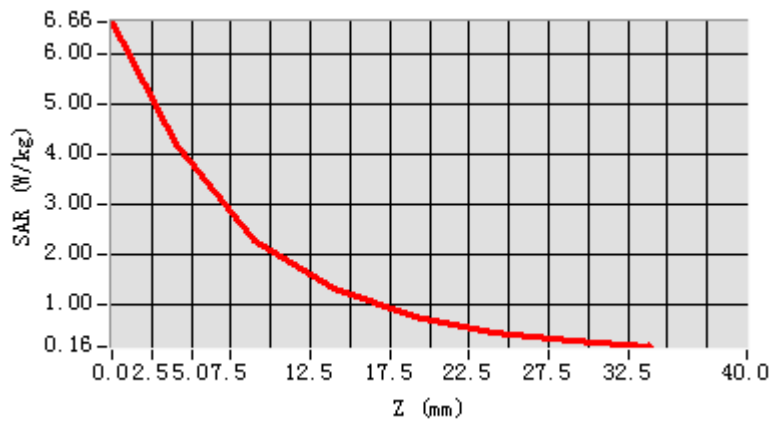

3D screen shot

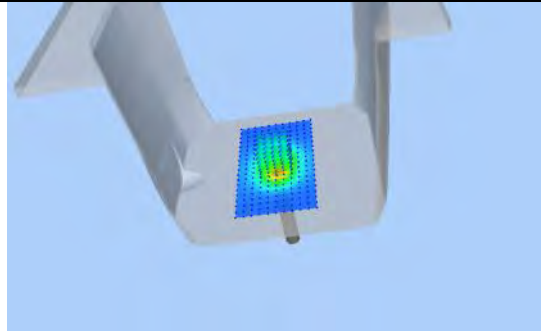

Hot spot position

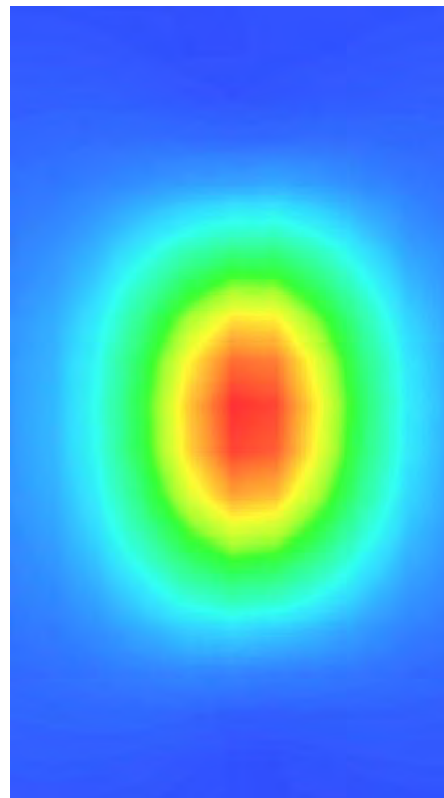



## 5.7 DIP 2G000

### 5.7.1 Dipole 2000 MHz Validation Measurement for Head Tissue

## System Performance Check Data(2000 MHz Head)

Type: Phone measurement (Complete)  
 E-Field Probe: SN 34/15 SSE2 EPGO265  
 Area scan resolution: dx=8 mm,dy=8 mm  
 Zoom scan resolution: dx=8 mm, dy=8 mm, dz=5 mm  
 Date of measurement: 2017.03.02  
 Measurement duration: 14 minutes 17 seconds

### Experimental conditions.

<b>Phantom File</b>	surf_sam_plan.txt
<b>Phantom</b>	Validation plane
<b>Band</b>	2000 MHz
<b>Signal</b>	CW
<b>Frequency (MHz)</b>	2000.000000
<b>Relative permittivity (real part)</b>	38.789355
<b>Conductivity (S/m)</b>	1.4251543
<b>Power drift (%)</b>	0.660000
<b>Ambient Temperature:</b>	22.4°C
<b>Liquid Temperature:</b>	21.3°C
<b>ConvF:</b>	2.23
<b>Crest factor:</b>	1:1

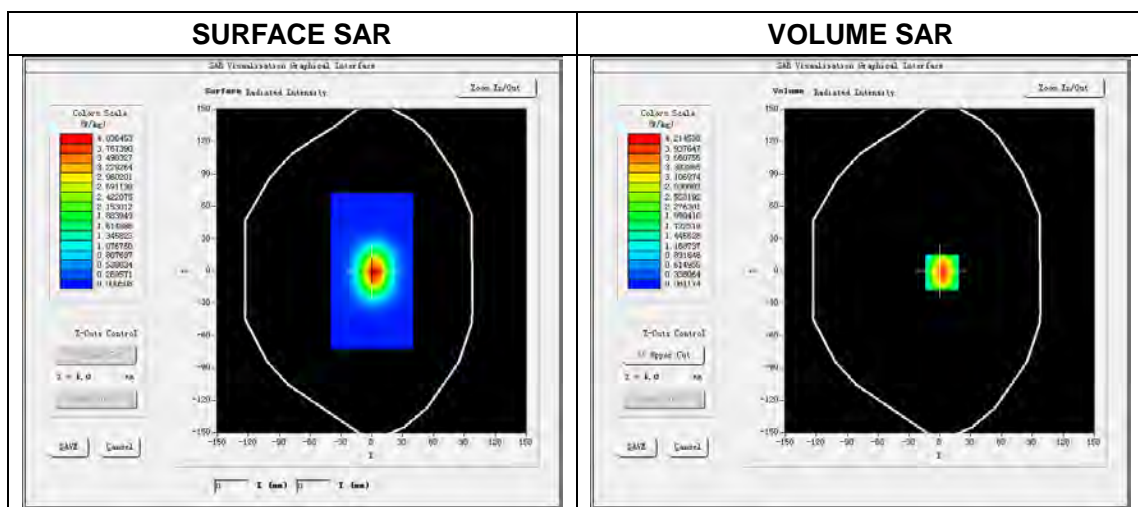

Maximum location: X=0.00, Y=0.00

SAR Peak: 6.69 W/kg

SAR 10 g (W/Kg)	2.062551
SAR 1 g (W/Kg)	4.020365

### Z Axis Scan

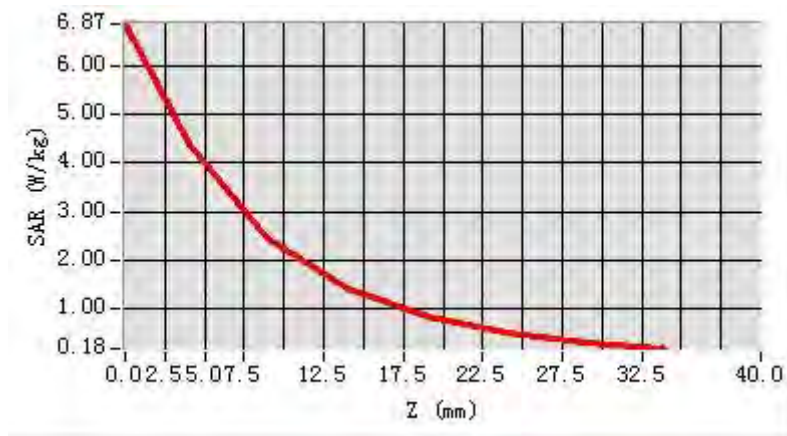

### 3D screen shot

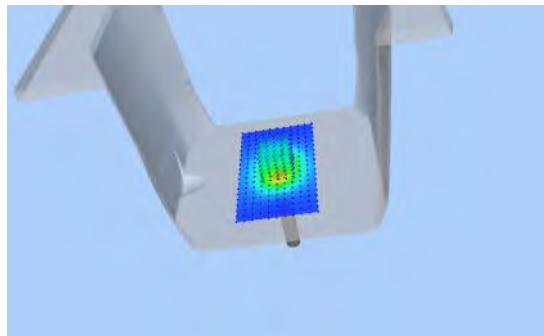

### Hot spot position

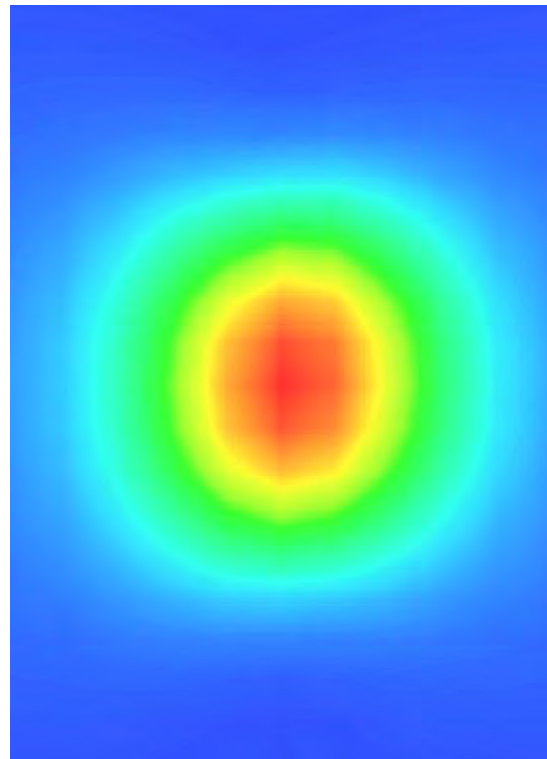

## 5.7.2 Dipole 2000 MHz Validation Measurement for Body Tissue

# System Performance Check Data(2000 MHz Body)

Type: Phone measurement (Complete)

E-Field Probe: SN 34/15 SSE2 EPGO265

Area scan resolution: dx=8 mm,dy=8 mm

Zoom scan resolution: dx=8 mm, dy=8 mm, dz=5 mm

Date of measurement: 2017.03.02

Measurement duration: 14 minutes 11 seconds

### Experimental conditions.

<b>Phantom File</b>	surf_sam_plan.txt
<b>Phantom</b>	Validation plane
<b>Band</b>	2000 MHz
<b>Signal</b>	CW
<b>Frequency (MHz)</b>	2000.000000
<b>Relative permittivity (real part)</b>	51.512549
<b>Conductivity (S/m)</b>	1.549334
<b>Power drift (%)</b>	0.510000
<b>Ambient Temperature:</b>	22.4°C
<b>Liquid Temperature:</b>	21.3°C
<b>ConvF:</b>	2.32
<b>Crest factor:</b>	1:1

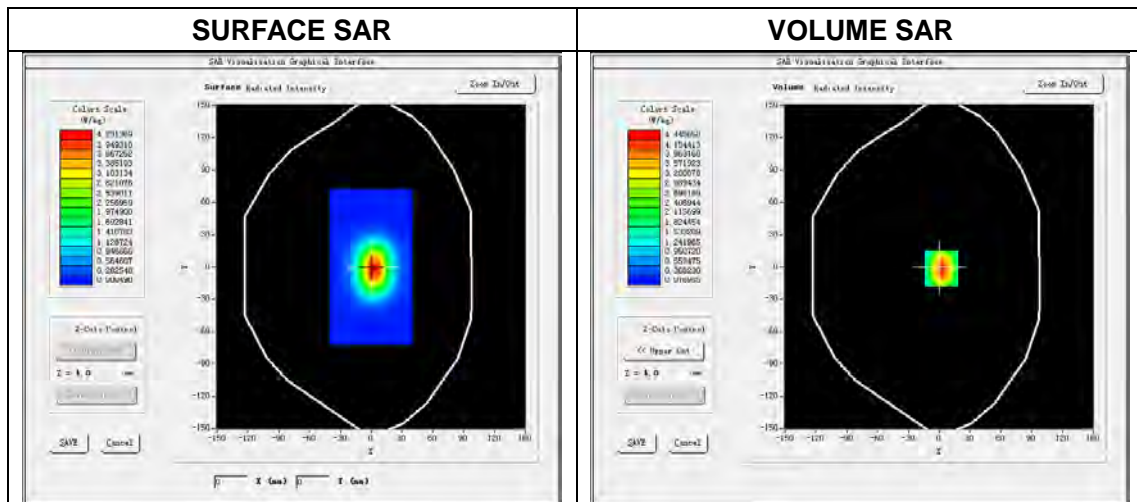

Maximum location: X=0.00, Y=0.00

SAR Peak: 6.98 W/kg

SAR 10 g (W/Kg)	2.189137
SAR 1 g (W/Kg)	4.215283

### Z Axis Scan

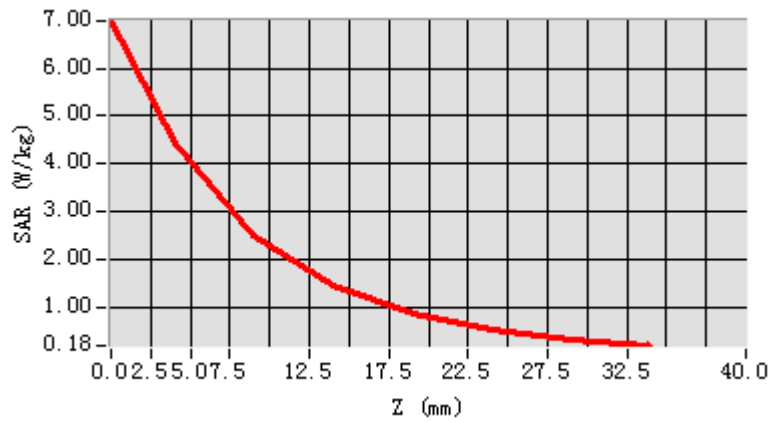

3D screen shot

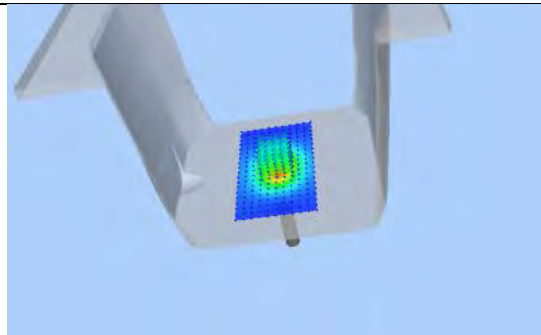

Hot spot position

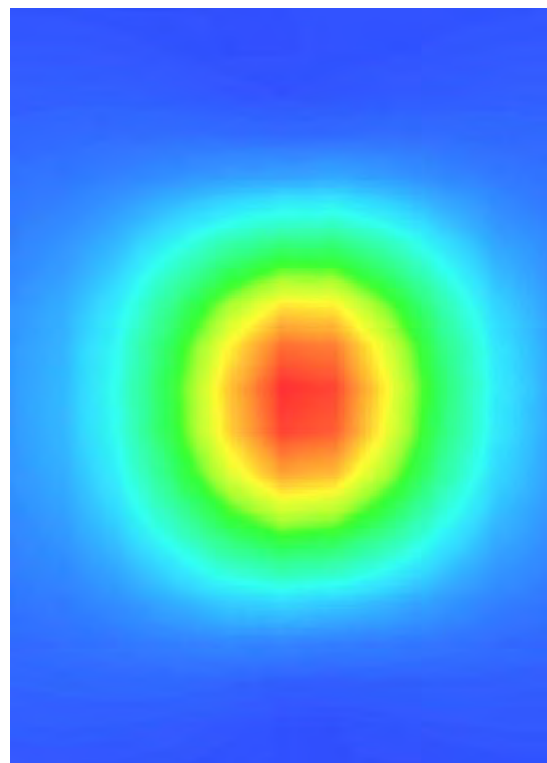

## 5.8 DIP 2G450

### 5.8.1 Dipole 2450 MHz Validation Measurement for Head Tissue

## System Performance Check Data(2450 MHz Head)

Type: Phone measurement (Complete)  
 E-Field Probe: SN 34/15 SSE2 EPGO265  
 Area scan resolution: dx=8mm,dy=8mm  
 Zoom scan resolution: dx=5mm, dy=5mm, dz=5mm  
 Date of measurement: 2017.03.02  
 Measurement duration: 18 minutes 37 seconds

### Experimental conditions.

<b>Phantom File</b>	surf_sam_plan.txt
<b>Phantom</b>	Validation plane
<b>Band</b>	2450MHz
<b>Signal</b>	CW
<b>Frequency (MHz)</b>	2450.000000
<b>Relative permittivity (real part)</b>	38.863623
<b>Conductivity (S/m)</b>	1.810263
<b>Power drift (%)</b>	1.240000
<b>Ambient Temperature:</b>	22.4°C
<b>Liquid Temperature:</b>	21.3°C
<b>ConvF:</b>	2.47
<b>Crest factor:</b>	1:1

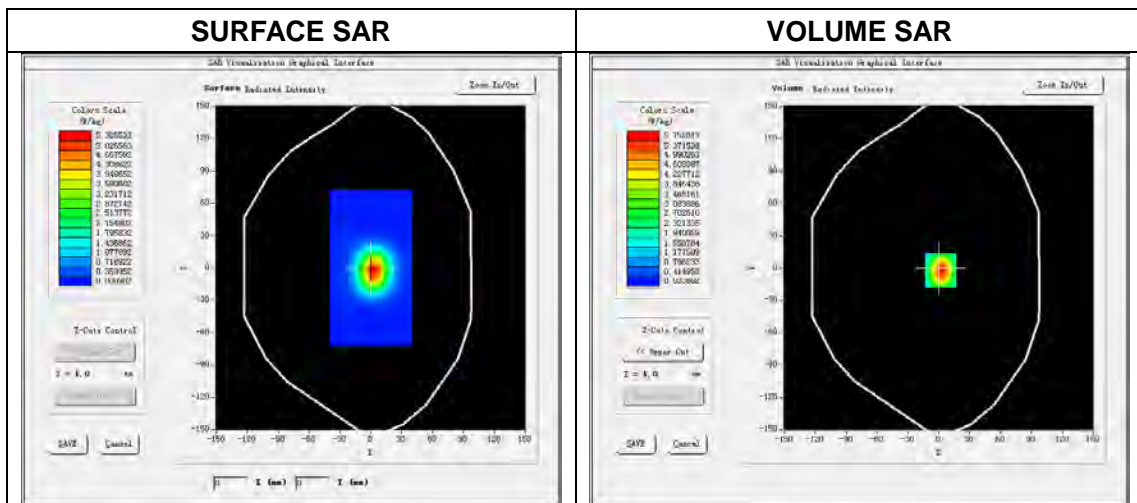

Maximum location: X=0.00, Y=0.00

SAR Peak: 9.79 W/kg

SAR 10g (W/Kg)	2.479365
SAR 1g (W/Kg)	5.302546

### Z Axis Scan

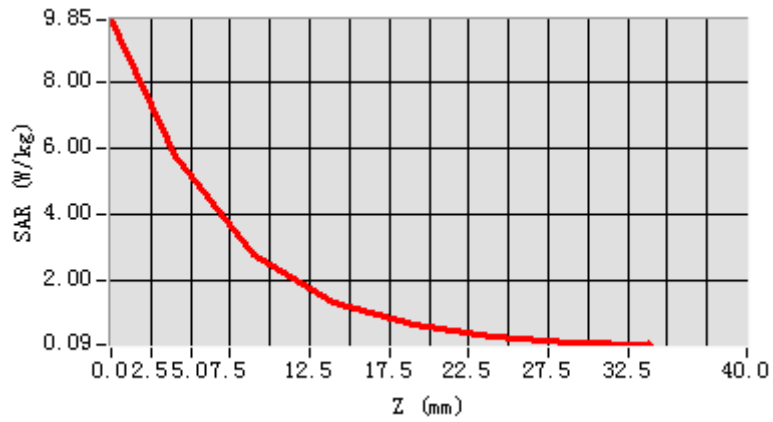

3D screen shot

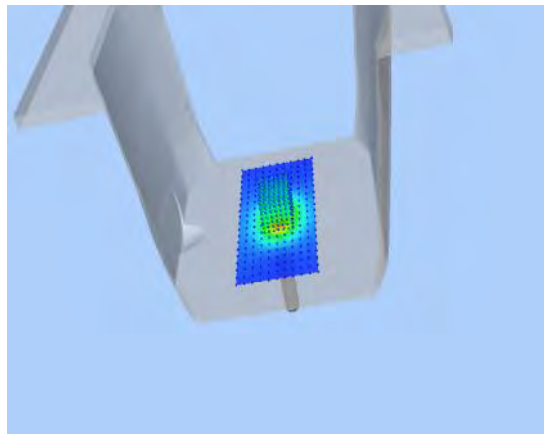

Hot spot position

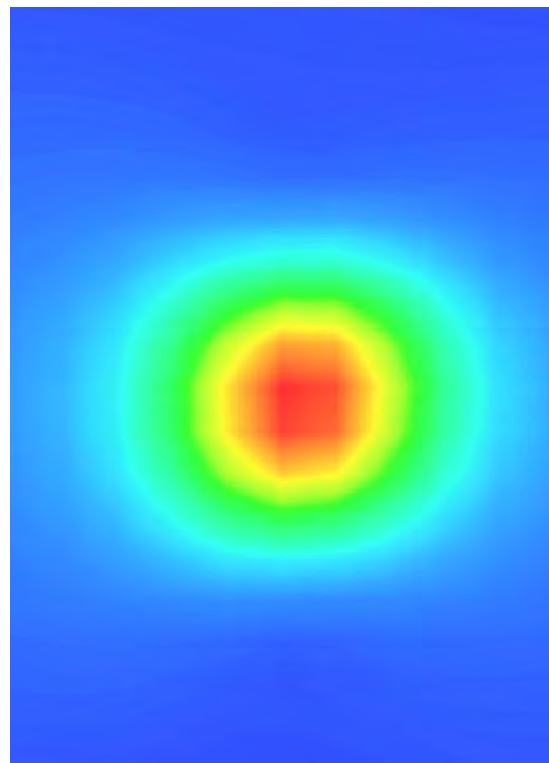

## 5.8.2 Dipole 2450 MHz Validation Measurement for Body Tissue

# System Performance Check Data(2450 MHz Body)

Type: Phone measurement (Complete)

E-Field Probe: SN 34/15 SSE2 EPGO265

Area scan resolution: dx=8 mm,dy=8 mm

Zoom scan resolution: dx=5 mm, dy=5 mm, dz=5 mm

Date of measurement: 2017.03.02

Measurement duration: 19 minutes 15 seconds

### Experimental conditions.

<b>Phantom File</b>	surf_sam_plan.txt
<b>Phantom</b>	Validation plane
<b>Band</b>	2450 MHz
<b>Signal</b>	CW
<b>Frequency (MHz)</b>	2450.000000
<b>Relative permittivity (real part)</b>	52.912582
<b>Conductivity (S/m)</b>	1.952326
<b>Power drift (%)</b>	-0.110000
<b>Ambient Temperature:</b>	22.4°C
<b>Liquid Temperature:</b>	21.3°C
<b>ConvF:</b>	2.55
<b>Crest factor:</b>	1:1

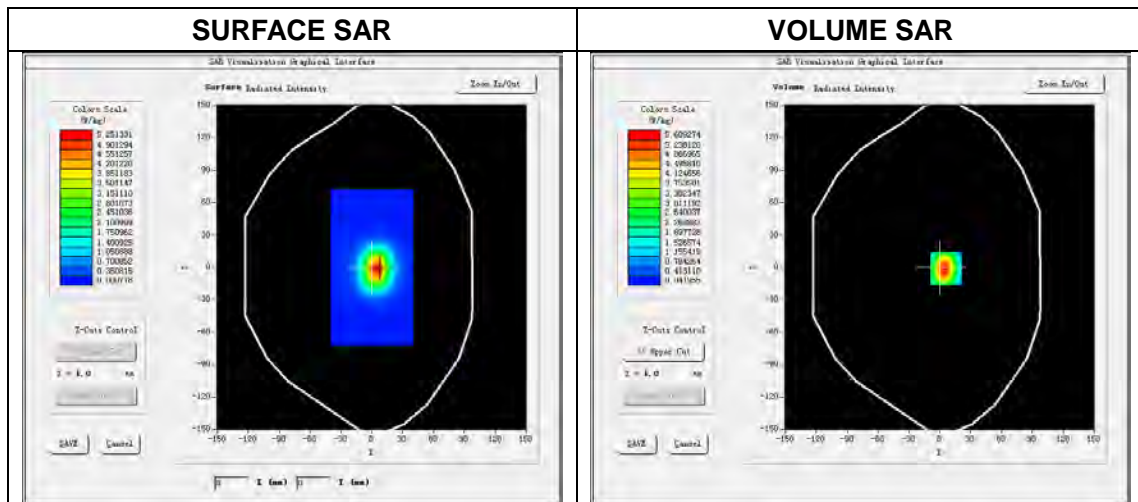

Maximum location: X=0.00, Y=0.00

SAR Peak: 9.01 W/kg

SAR 10 g (W/Kg)	2.448257
SAR 1 g (W/Kg)	5.102686

### Z Axis Scan

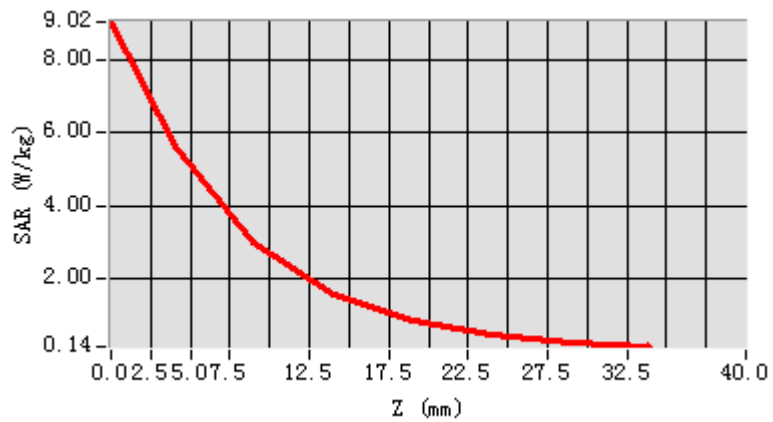

3D screen shot

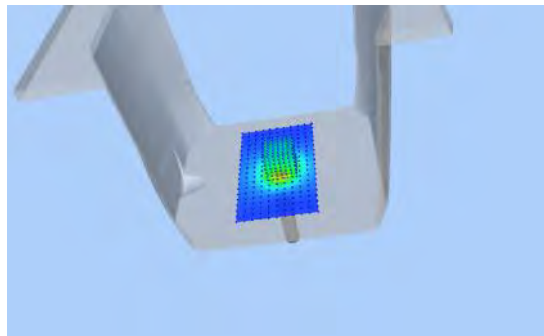

Hot spot position

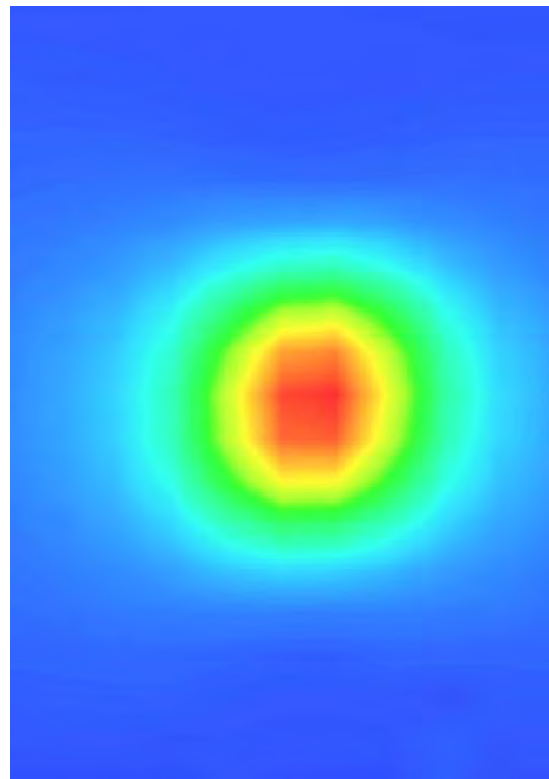



## 5.9 DIP 2G600

### 5.9.1 Dipole 2600 MHz Validation Measurement for Head Tissue

## System Performance Check Data(2600 MHz Head)

Type: Phone measurement (Complete)

E-Field Probe: SN 34/15 SSE2 EPGO265

Area scan resolution: dx=8 mm,dy=8 mm

Zoom scan resolution: dx=5 mm, dy=5 mm, dz=5 mm

Date of measurement: 2017.03.03

Measurement duration: 19 minutes 16 seconds

### Experimental conditions.

<b>Phantom File</b>	surf_sam_plan.txt
<b>Phantom</b>	Validation plane
<b>Band</b>	2600 MHz
<b>Signal</b>	CW
<b>Frequency (MHz)</b>	2600.000000
<b>Relative permittivity (real part)</b>	38.085257
<b>Conductivity (S/m)</b>	1.982546
<b>Power drift (%)</b>	-0.050000
<b>Ambient Temperature:</b>	22.2°C
<b>Liquid Temperature:</b>	21.2°C
<b>ConvF:</b>	2.36
<b>Crest factor:</b>	1:1

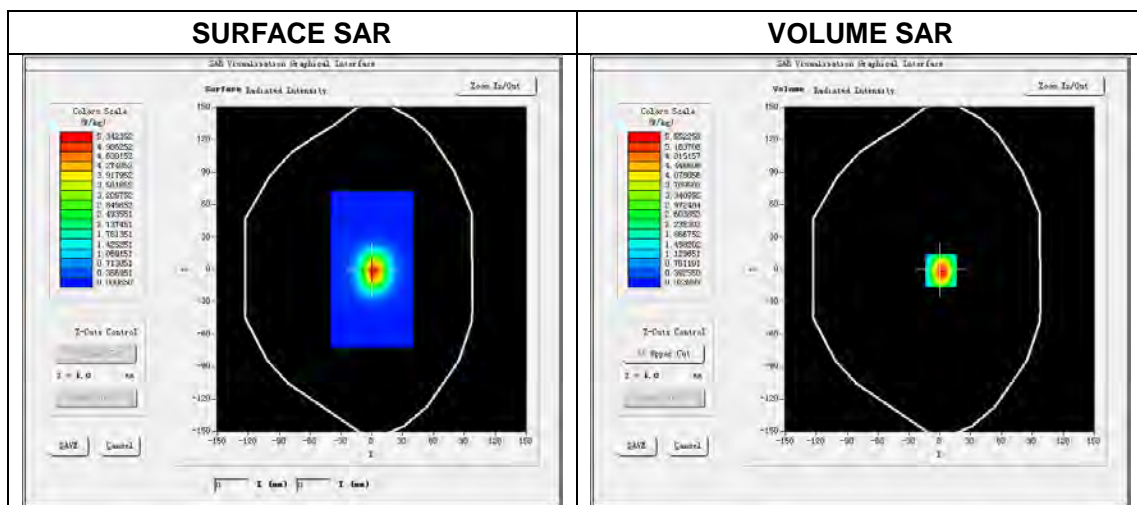

Maximum location: X=0.00, Y=0.00

SAR Peak: 9.66 W/kg

SAR 10 g (W/Kg)	2.506594
SAR 1 g (W/Kg)	5.336598

### Z Axis Scan

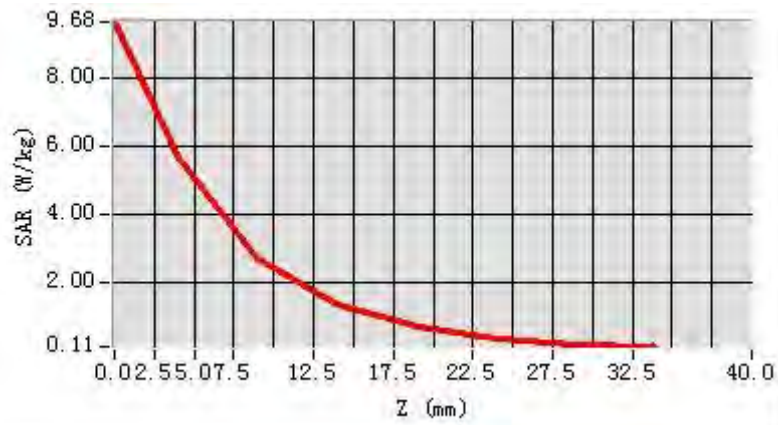

3D screen shot

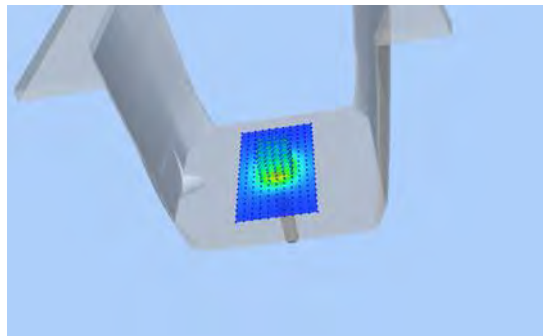

Hot spot position

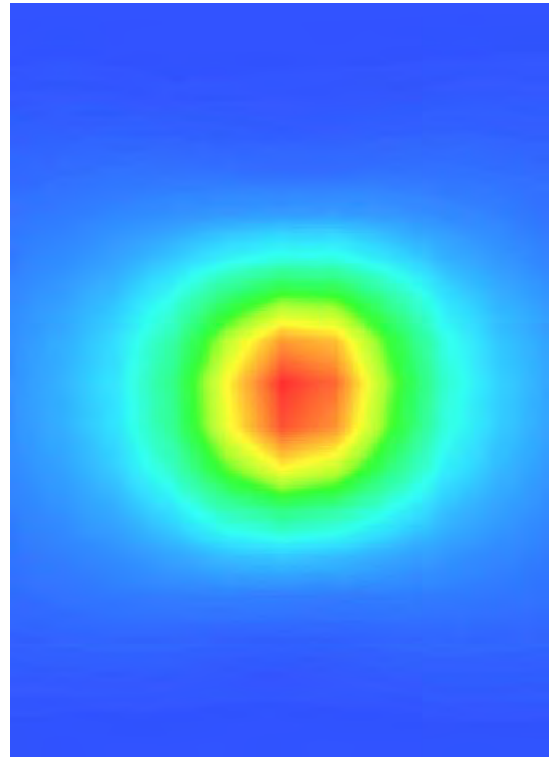

## 5.9.2 Dipole 2600 MHz Validation Measurement for Body Tissue

# System Performance Check Data(2600 MHz Body)

Type: Phone measurement (Complete)

E-Field Probe: SN 34/15 SSE2 EPGO265

Area scan resolution: dx=8 mm,dy=8 mm

Zoom scan resolution: dx=5 mm, dy=5 mm, dz=5 mm

Date of measurement: 2017.03.03

Measurement duration: 19 minutes 11 seconds

### Experimental conditions.

<b>Phantom File</b>	surf_sam_plan.txt
<b>Phantom</b>	Validation plane
<b>Band</b>	2600 MHz
<b>Signal</b>	CW
<b>Frequency (MHz)</b>	2600.000000
<b>Relative permittivity (real part)</b>	53.385272
<b>Conductivity (S/m)</b>	2.138941
<b>Power drift (%)</b>	0.550000
<b>Ambient Temperature:</b>	22.2°C
<b>Liquid Temperature:</b>	21.2°C
<b>ConvF:</b>	2.43
<b>Crest factor:</b>	1:1

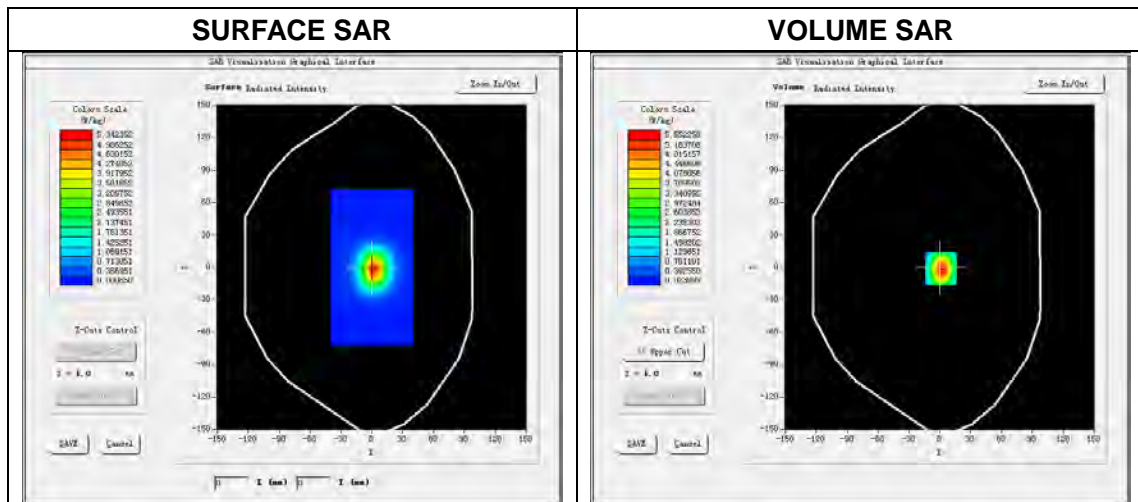

Maximum location: X=0.00, Y=0.00

SAR Peak: 9.33 W/kg

SAR 10 g (W/Kg)	2.375266
SAR 1 g (W/Kg)	5.167828

### Z Axis Scan

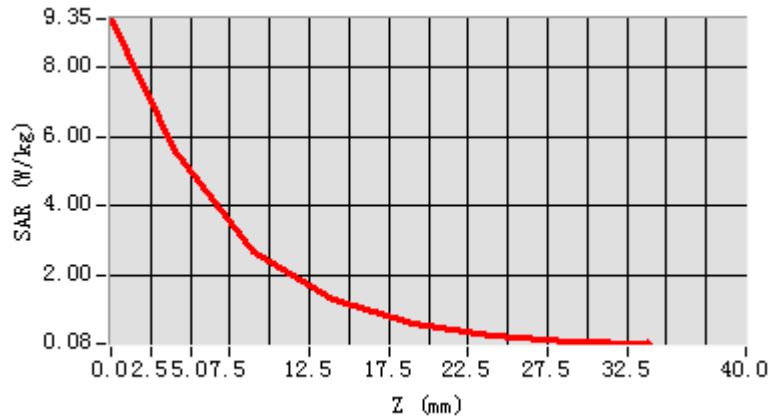

3D screen shot

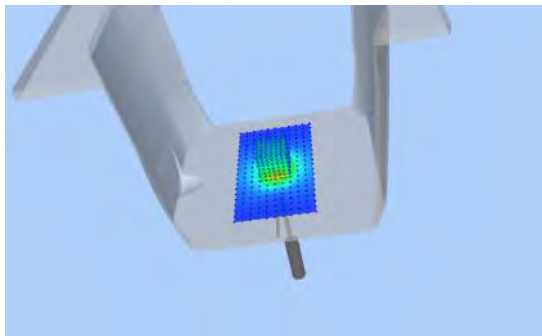

Hot spot position

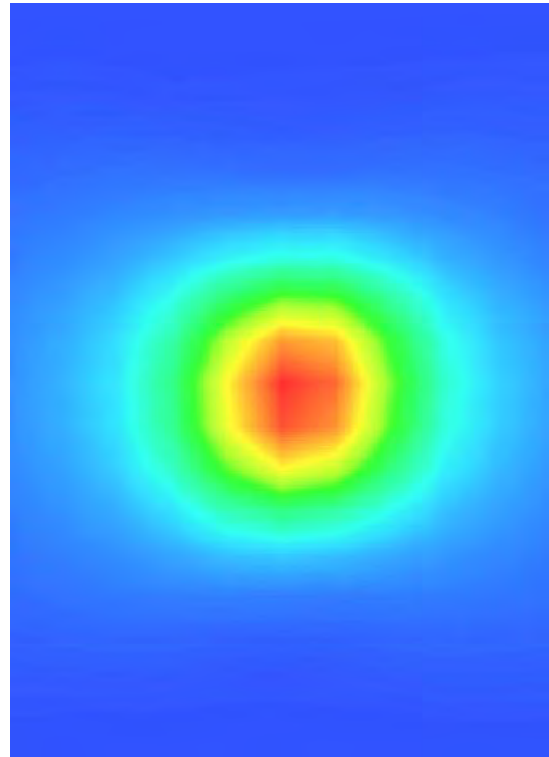

## 5.10 SWG5500

### 5.10.1 Waveguide 5 GHz Validation Measurement for Head Tissue

# System Performance Check Data(5200 MHz Head)

Type: Phone measurement (Complete)  
 E-Field Probe: SN 34/15 SSE2 EPGO265  
 Area scan resolution: dx=8mm,dy=8mm  
 Zoom scan resolution: dx=4mm, dy=4mm, dz=2mm  
 Date of measurement: 2017.03.04  
 Measurement duration: 29 minutes 20 seconds

### Experimental conditions.

<b>Phantom File</b>	surf_sam_plan.txt
<b>Phantom</b>	Validation plane
<b>Band</b>	5200 MHz
<b>Signal</b>	CW
<b>Frequency (MHz)</b>	5200.000000
<b>Relative permittivity (real part)</b>	36.726545
<b>Conductivity (S/m)</b>	4.619563
<b>Power drift (%)</b>	0.170000
<b>Ambient Temperature:</b>	22.3°C
<b>Liquid Temperature:</b>	21.2°C
<b>ConvF:</b>	1.81
<b>Crest factor:</b>	1:1

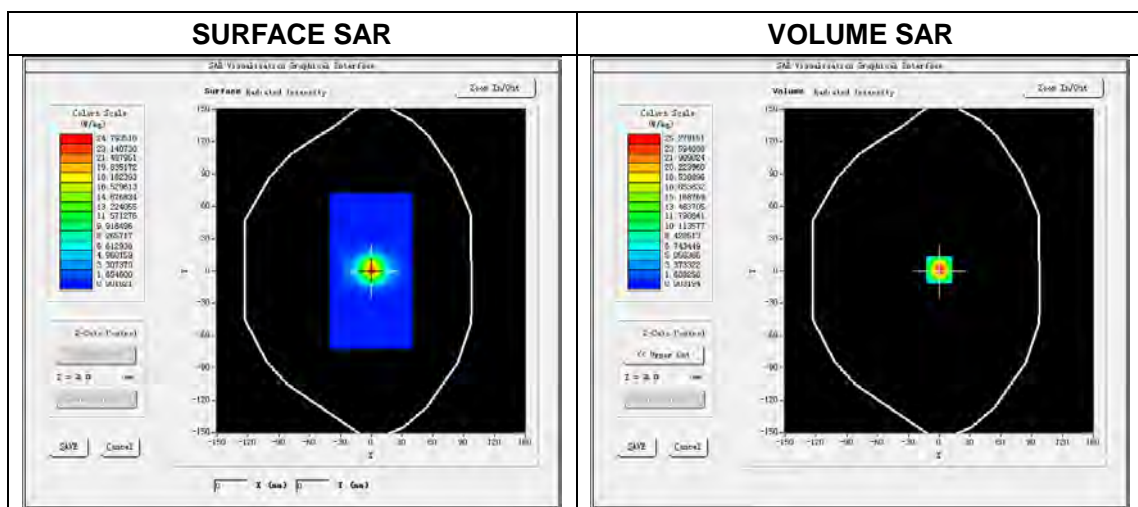

Maximum location: X=3.00, Y=1.00

SAR Peak: 42.16 W/kg

SAR 10g (W/Kg)	5.458332
SAR 1g (W/Kg)	15.372378

### Z Axis Scan

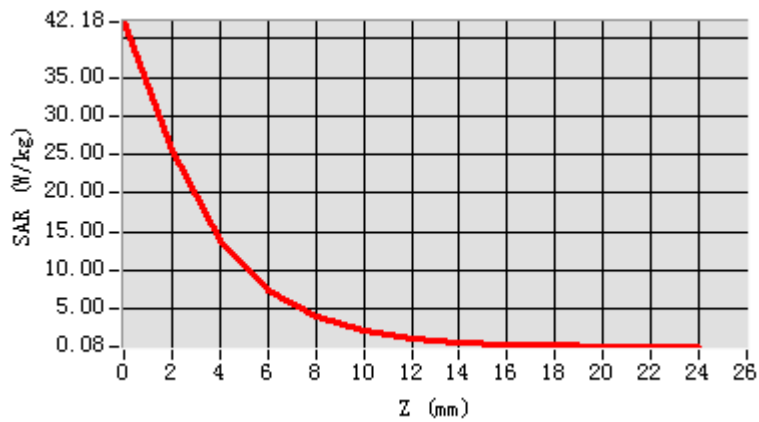

3D screen shot

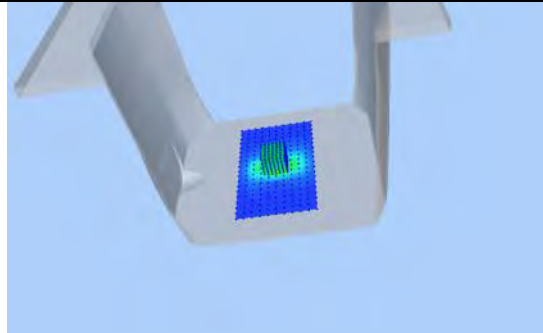

Hot spot position

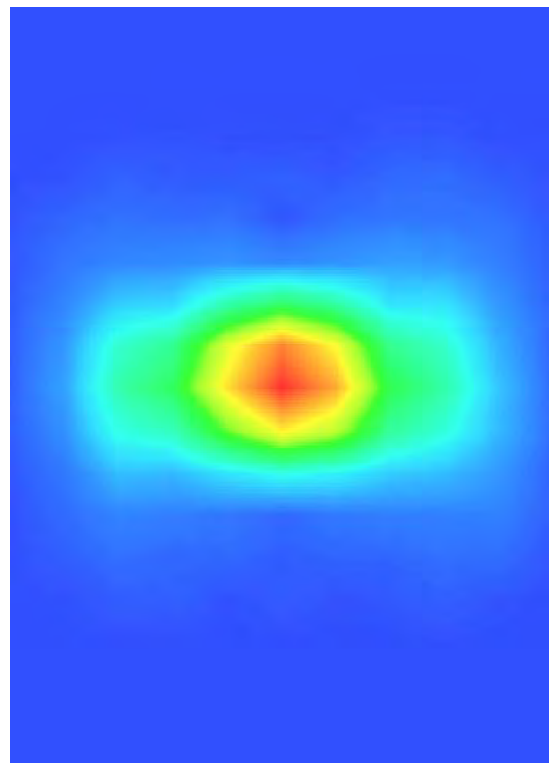

# System Performance Check Data(5400 MHz Head)

Type: Phone measurement (Complete)  
 E-Field Probe: SN 34/15 SSE2 EPGO265  
 Area scan resolution: dx=8mm,dy=8mm  
 Zoom scan resolution: dx=4mm, dy=4mm, dz=2mm  
 Date of measurement: 2017.03.04  
 Measurement duration: 29 minutes 19 seconds

## Experimental conditions.

Phantom File	surf_sam_plan.txt
Phantom	Validation plane
Band	5400 MHz
Signal	CW
Frequency (MHz)	5400.000000
Relative permittivity (real part)	36.215425
Conductivity (S/m)	4.818762
Power drift (%)	1.120000
Ambient Temperature:	22.3°C
Liquid Temperature:	21.2°C
ConvF:	2.04
Crest factor:	1:1

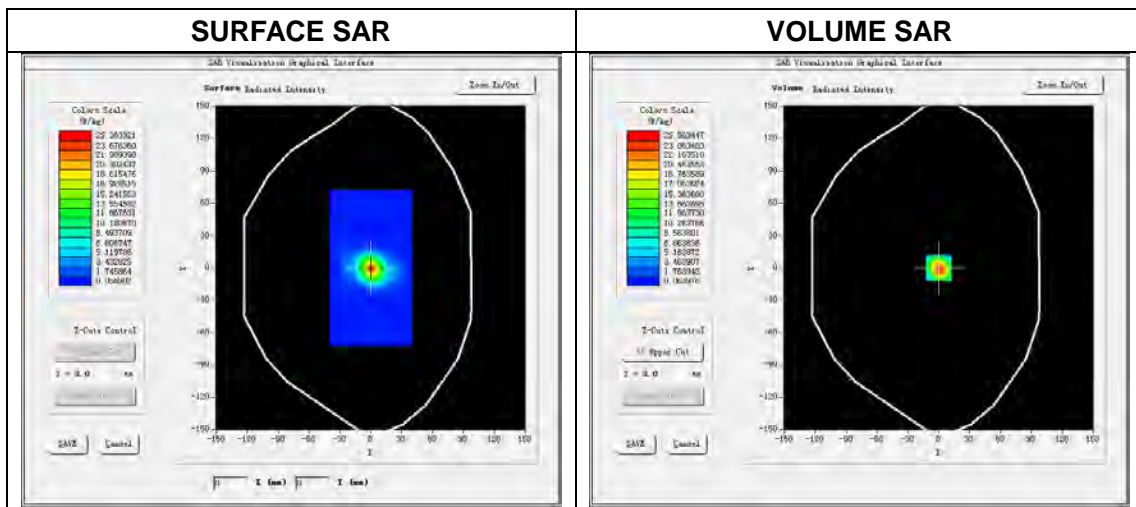

Maximum location: X=0.00, Y=0.00

SAR Peak: 44.75 W/kg

SAR 10g (W/Kg)	5.521578
SAR 1g (W/Kg)	15.893652

### Z Axis Scan

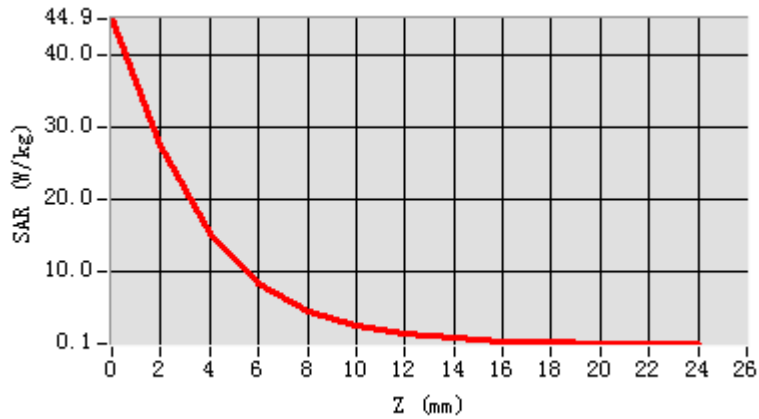

3D screen shot

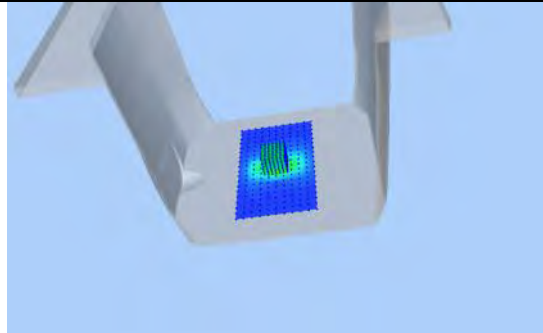

Hot spot position

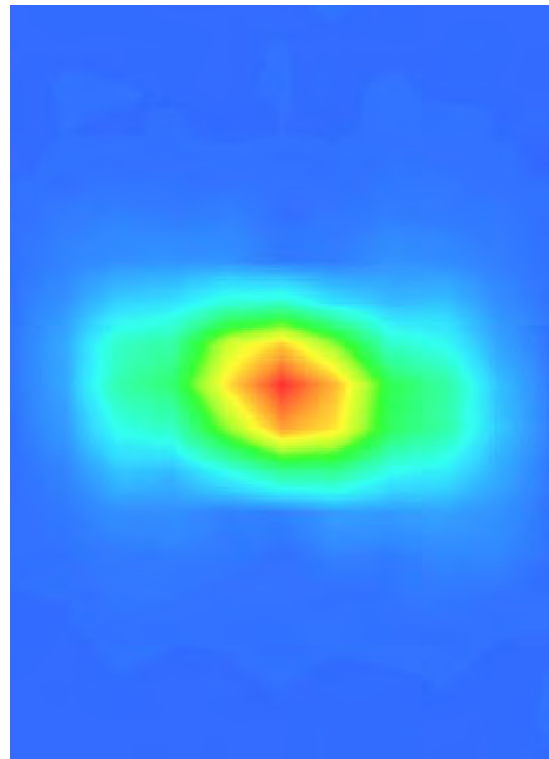



# System Performance Check Data(5600 MHz Head)

Type: Phone measurement (Complete)  
 E-Field Probe: SN 34/15 SSE2 EPGO265  
 Area scan resolution: dx=8mm,dy=8mm  
 Zoom scan resolution: dx=4mm, dy=4mm, dz=2mm  
 Date of measurement: 2017.03.04  
 Measurement duration: 29 minutes 28 seconds

## Experimental conditions.

Phantom File	surf_sam_plan.txt
Phantom	Validation plane
Band	5600 MHz
Signal	CW
Frequency (MHz)	5600.000000
Relative permittivity (real part)	34.254845
Conductivity (S/m)	5.132262
Power drift (%)	1.380000
Ambient Temperature:	22.3°C
Liquid Temperature:	21.2°C
ConvF:	2.08
Crest factor:	1:1

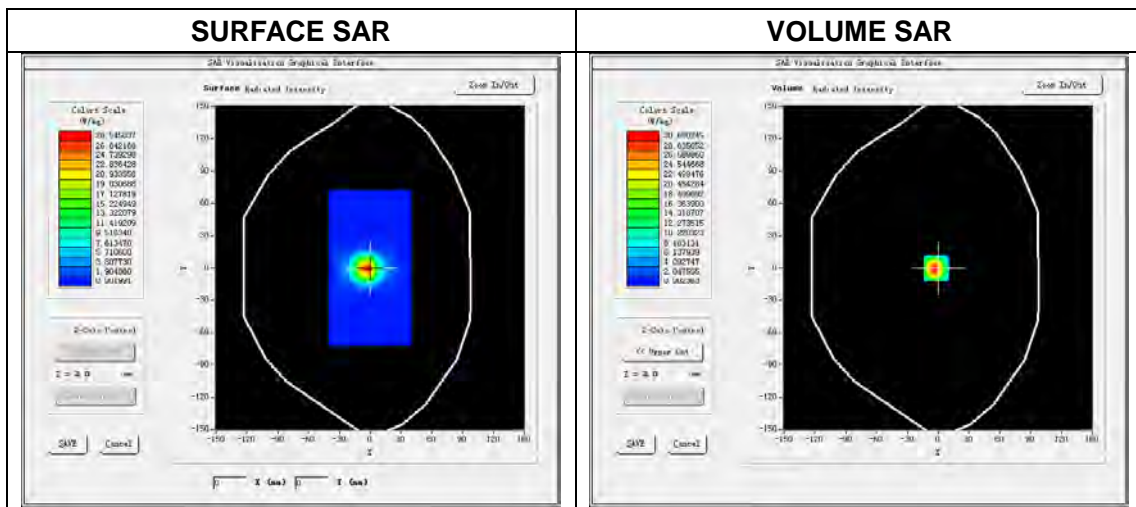

Maximum location: X=1.00, Y=1.00

SAR Peak: 49.55 W/kg

SAR 10g (W/Kg)	5.788135
SAR 1g (W/Kg)	16.458215

### Z Axis Scan

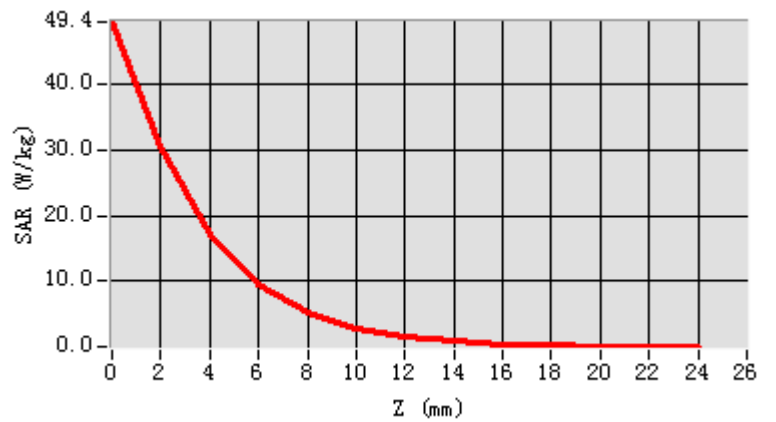

3D screen shot

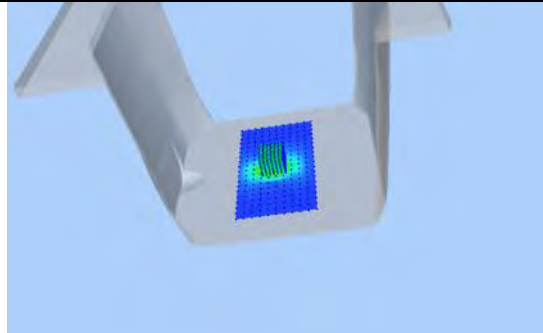

Hot spot position

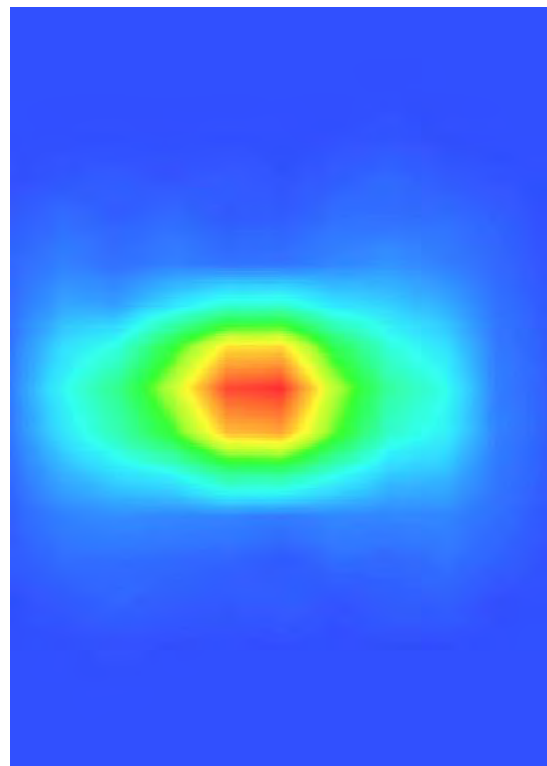

# System Performance Check Data(5800 MHz Head)

Type: Phone measurement (Complete)  
 E-Field Probe: SN 34/15 SSE2 EPGO265  
 Area scan resolution: dx=8mm,dy=8mm  
 Zoom scan resolution: dx=4mm, dy=4mm, dz=2mm  
 Date of measurement: 2017.03.04  
 Measurement duration: 29 minutes 38 seconds

## Experimental conditions.

Phantom File	surf_sam_plan.txt
Phantom	Validation plane
Band	5800 MHz
Signal	CW
Frequency (MHz)	5800.000000
Relative permittivity (real part)	34.623258
Conductivity (S/m)	5.332958
Power drift (%)	1.180000
Ambient Temperature:	22.3°C
Liquid Temperature:	21.2°C
ConvF:	1.88
Crest factor:	1:1

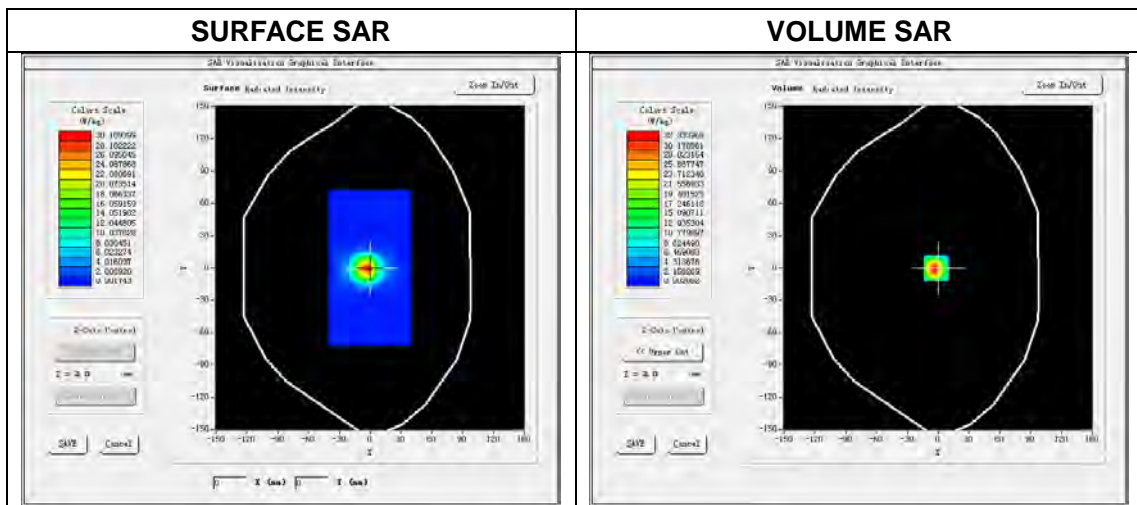

Maximum location: X=0.00, Y=0.00

SAR Peak: 51.75 W/kg

SAR 10g (W/Kg)	5.986358
SAR 1g (W/Kg)	17.698213

### Z Axis Scan

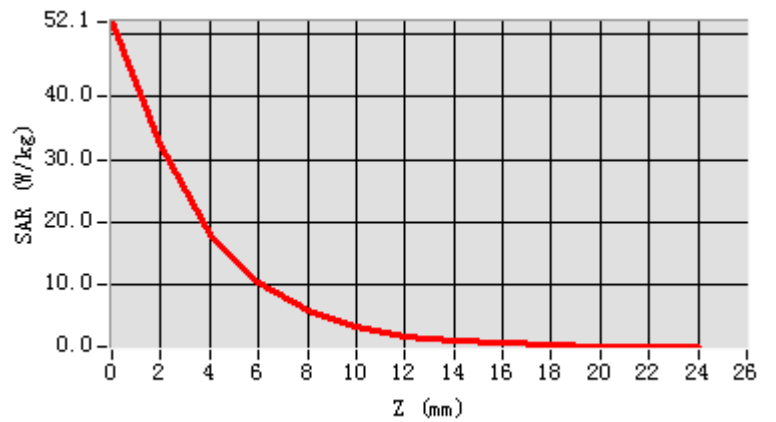

3D screen shot

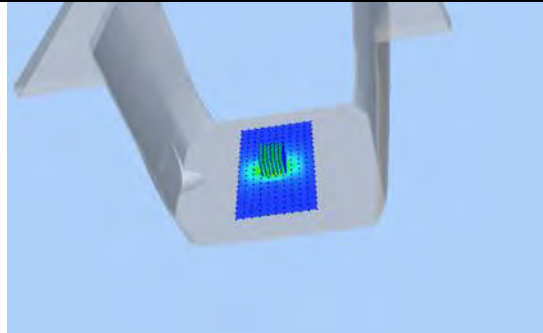

Hot spot position

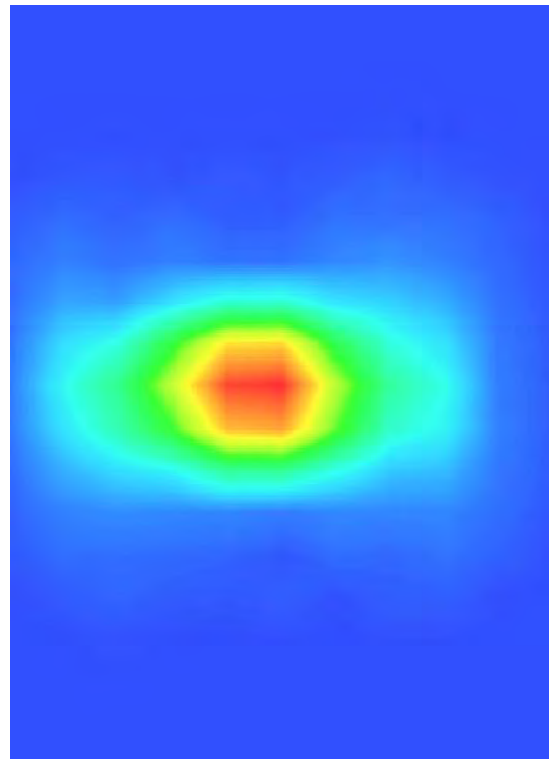

## 5.10.2 Waveguide 5 GHz Validation Measurement for Body Tissue

# System Performance Check Data(5200MHz Body)

Type: Phone measurement (Complete)

E-Field Probe: SN 34/15 SSE2 EPGO265

Area scan resolution: dx=8mm,dy=8mm

Zoom scan resolution: dx=4mm, dy=4mm, dz=2mm

Date of measurement: 2017.03.04

Measurement duration: 29 minutes 26 seconds

### Experimental conditions.

Phantom File	surf_sam_plan.txt
Phantom	Validation plane
Band	5200 MHz
Signal	CW
Frequency (MHz)	5200.000000
Relative permittivity (real part)	50.082542
Conductivity (S/m)	5.212548
Power drift (%)	0.680000
Ambient Temperature:	22.3C
Liquid Temperature:	21.2C
ConvF:	1.85
Crest factor:	1:1

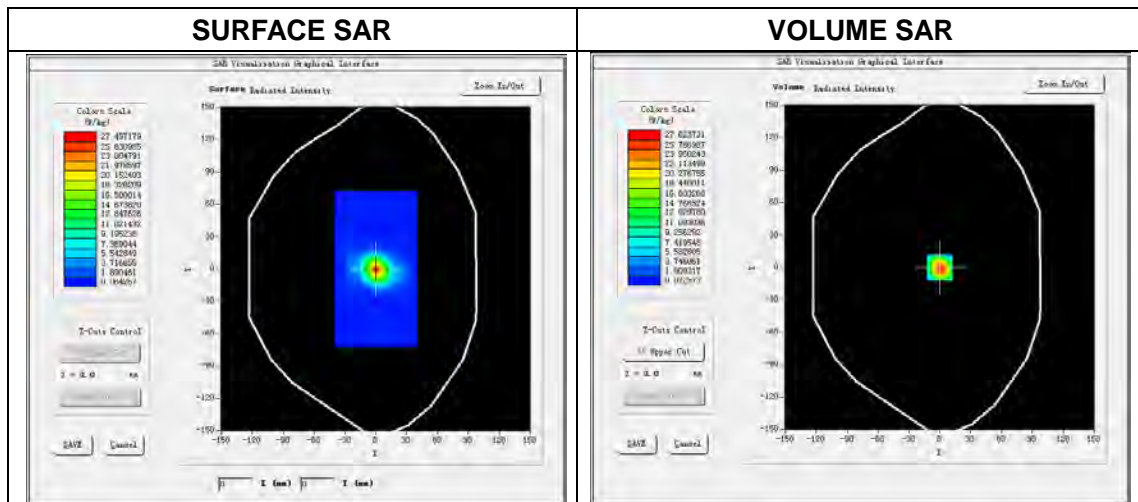

Maximum location: X=0.00, Y=0.00

SAR Peak: 40.52 W/kg

SAR 10g (W/Kg)	5.328147
SAR 1g (W/Kg)	15.226524

### Z Axis Scan

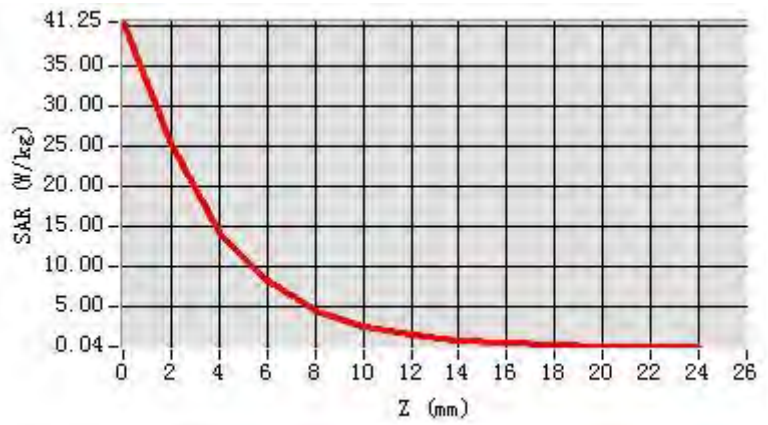

3D screen shot

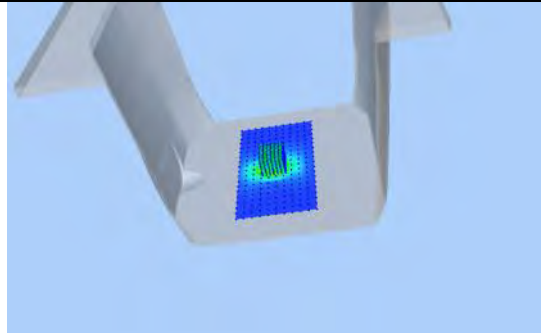

Hot spot position

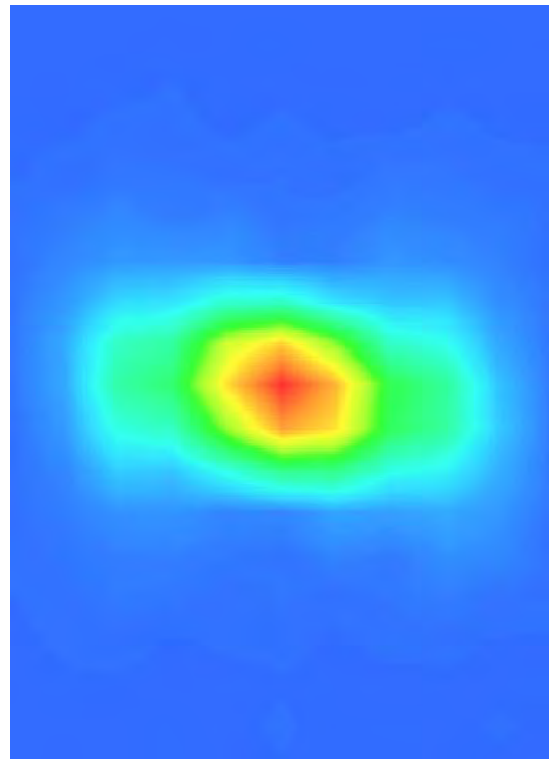

# System Performance Check Data (5400 MHz Body)

Type: Phone measurement (Complete)  
 E-Field Probe: SN 34/15 SSE2 EPGO265  
 Area scan resolution: dx=8mm,dy=8mm  
 Zoom scan resolution: dx=4mm, dy=4mm, dz=2mm  
 Date of measurement: 2017.03.04  
 Measurement duration: 29 minutes 32 seconds

## Experimental conditions.

Phantom File	surf_sam_plan.txt
Phantom	Validation plane
Band	5400 MHz
Signal	CW
Frequency (MHz)	5400.000000
Relative permittivity (real part)	50.132355
Conductivity (S/m)	5.525699
Power drift (%)	0.160000
Ambient Temperature:	22.3°C
Liquid Temperature:	21.2°C
ConvF:	2.11
Crest factor:	1:1

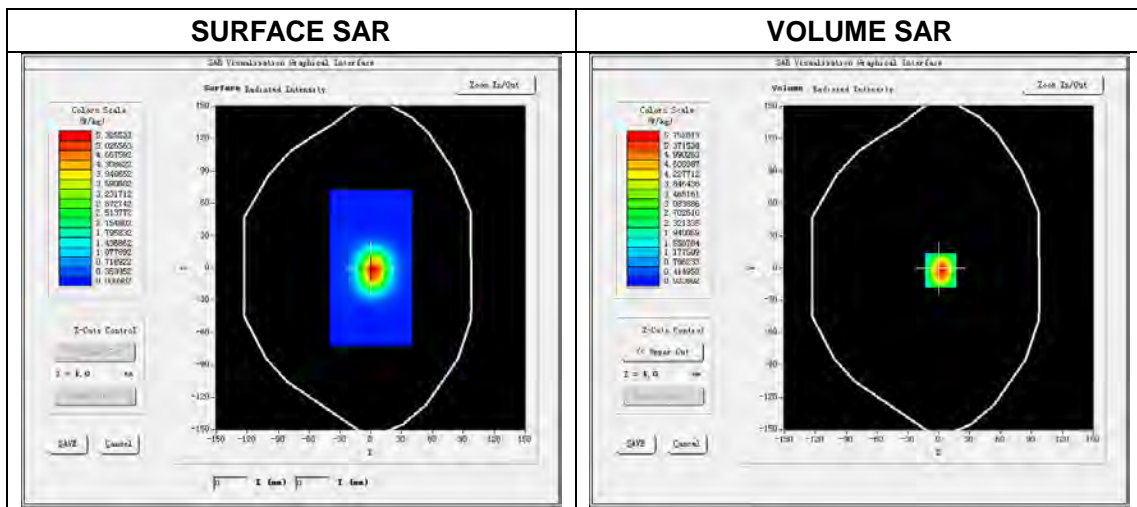

Maximum location: X=0.00, Y=0.00

SAR Peak: 43.88 W/kg

SAR 10g (W/Kg)	5.602659
SAR 1g (W/Kg)	15.759821

### Z Axis Scan

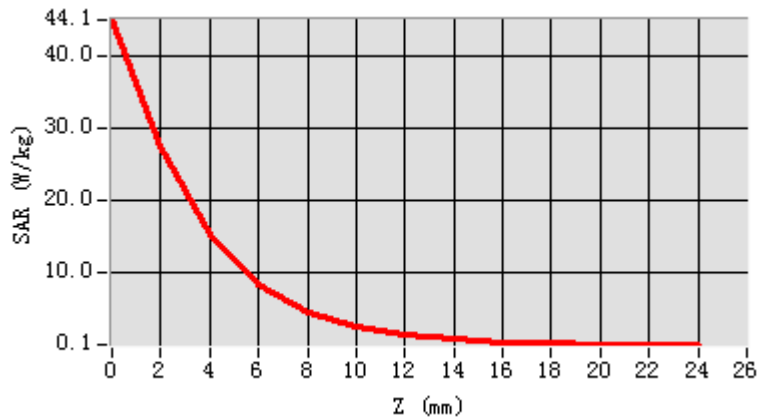

3D screen shot

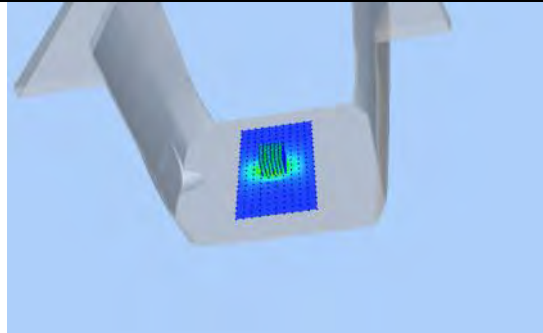

Hot spot position

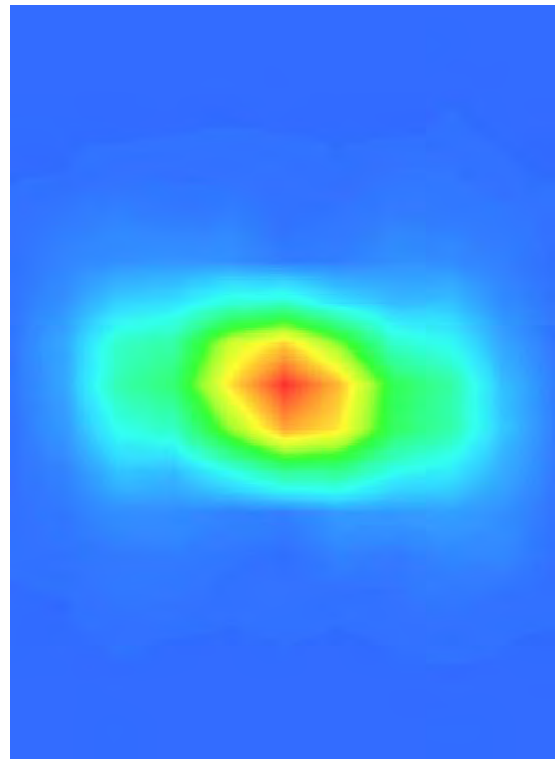



# System Performance Check Data (5600 MHz Body )

Type: Phone measurement (Complete)  
 E-Field Probe: SN 34/15 SSE2 EPGO265  
 Area scan resolution: dx=8mm,dy=8mm  
 Zoom scan resolution: dx=4mm, dy=4mm, dz=2mm  
 Date of measurement: 2017.03.04  
 Measurement duration: 29 minutes 32 seconds

## Experimental conditions.

<b>Phantom File</b>	surf_sam_plan.txt
<b>Phantom</b>	Validation plane
<b>Band</b>	5600 MHz
<b>Signal</b>	CW
<b>Frequency (MHz)</b>	5600.000000
<b>Relative permittivity (real part)</b>	49.136522
<b>Conductivity (S/m)</b>	5.906785
<b>Power drift (%)</b>	1.20000
<b>Ambient Temperature:</b>	22.3°C
<b>Liquid Temperature:</b>	21.2°C
<b>ConvF:</b>	2.15
<b>Crest factor:</b>	1:1

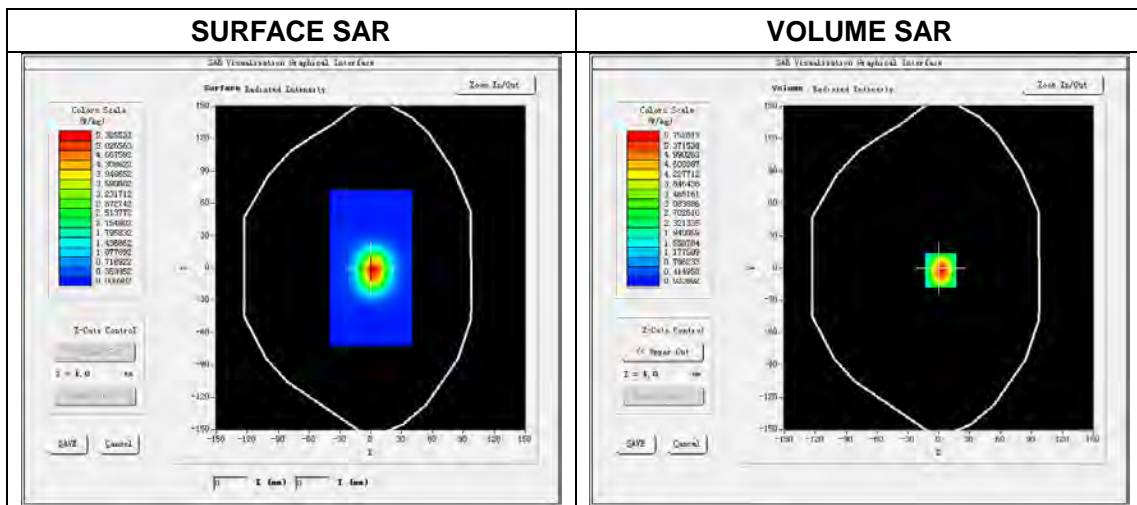

Maximum location: X=0.00, Y=0.00

SAR Peak: 46.38W/kg

SAR 10g (W/Kg)	5.643362
SAR 1g (W/Kg)	15.892147

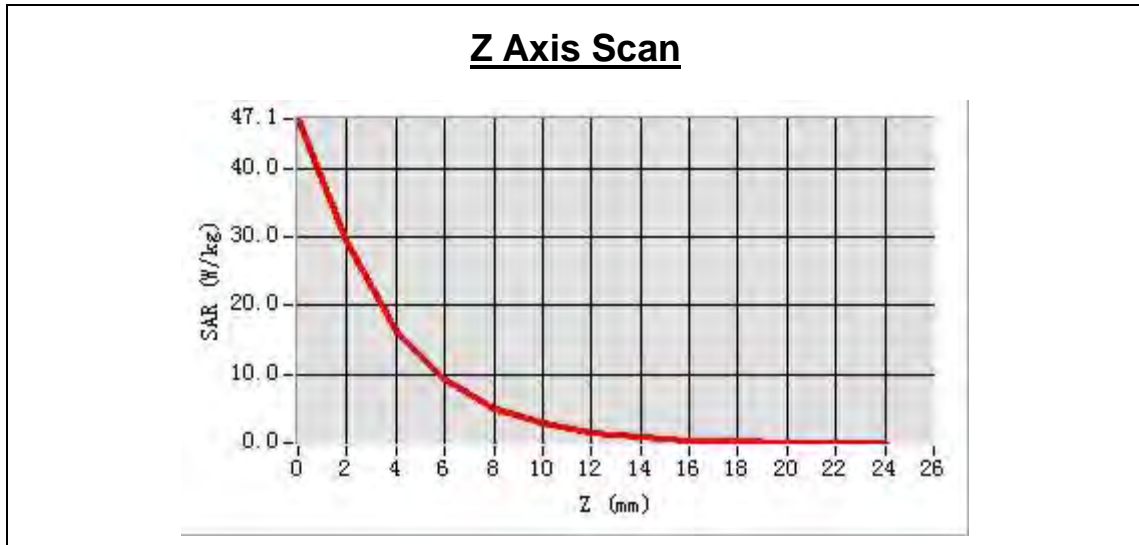

3D screen shot	Hot spot position

# System Performance Check Data (5800 MHz Body )

Type: Phone measurement (Complete)  
 E-Field Probe: SN 34/15 SSE2 EPGO265  
 Area scan resolution: dx=8mm,dy=8mm  
 Zoom scan resolution: dx=4mm, dy=4mm, dz=2mm  
 Date of measurement: 2017.03.04  
 Measurement duration: 29 minutes 36 seconds

## Experimental conditions.

<b>Phantom File</b>	surf_sam_plan.txt
<b>Phantom</b>	Validation plane
<b>Band</b>	5800 MHz
<b>Signal</b>	CW
<b>Frequency (MHz)</b>	5800.000000
<b>Relative permittivity (real part)</b>	47.536522
<b>Conductivity (S/m)</b>	6.052548
<b>Power drift (%)</b>	0.130000
<b>Ambient Temperature:</b>	22.3°C
<b>Liquid Temperature:</b>	21.2°C
<b>ConvF:</b>	1.93
<b>Crest factor:</b>	1:1

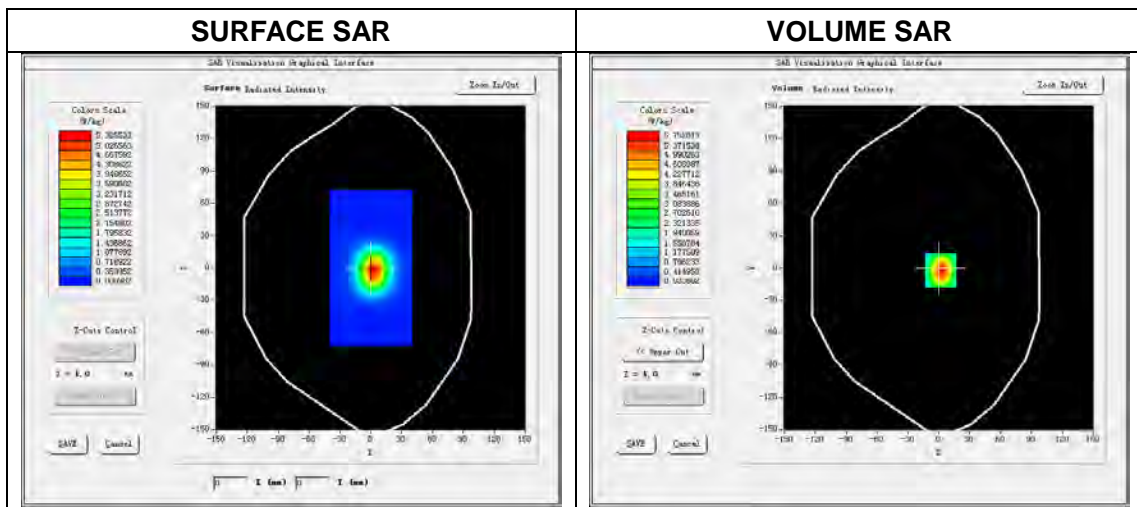

Maximum location: X=0.00, Y=0.00

SAR Peak: 50.15W/kg

SAR 10g (W/Kg)	5.842582
SAR 1g (W/Kg)	16.971256

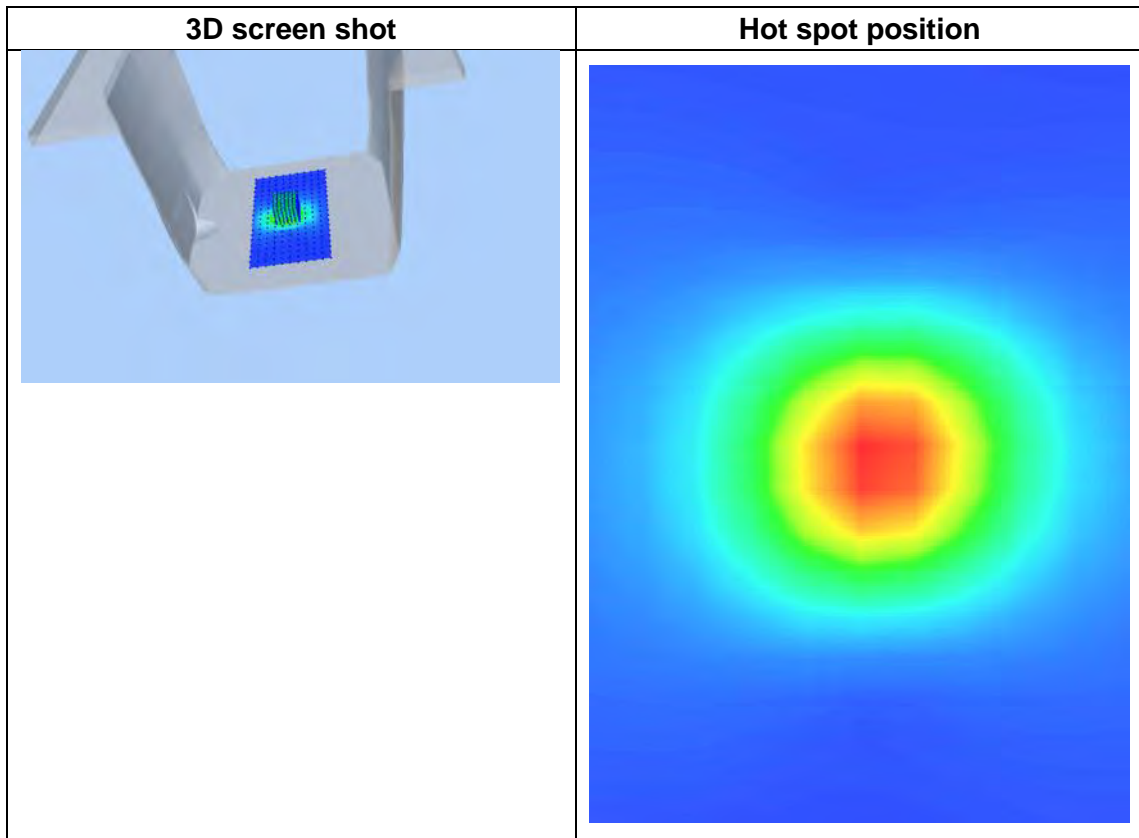
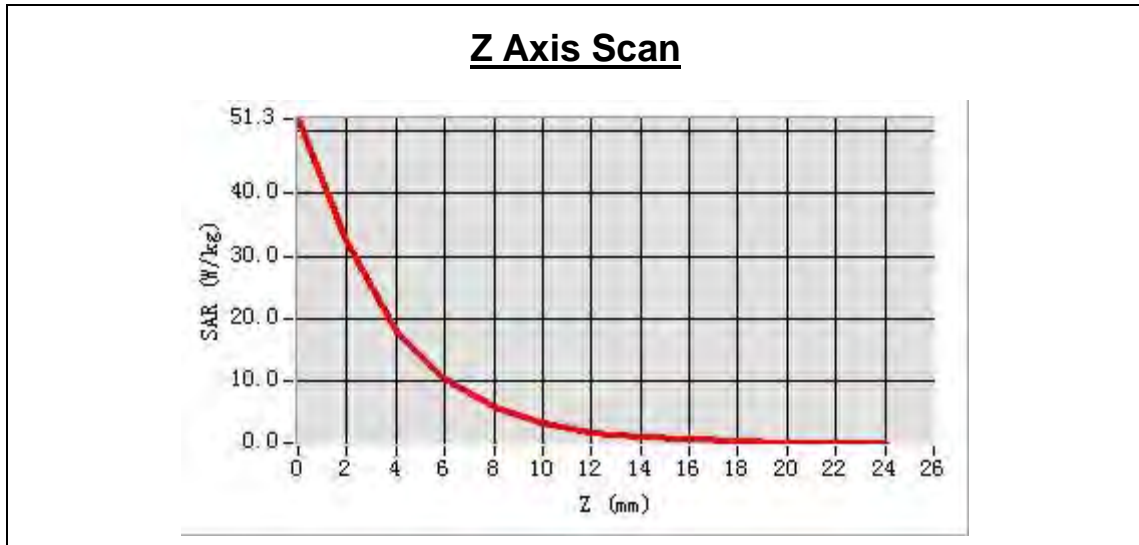

--END OF REPORT--