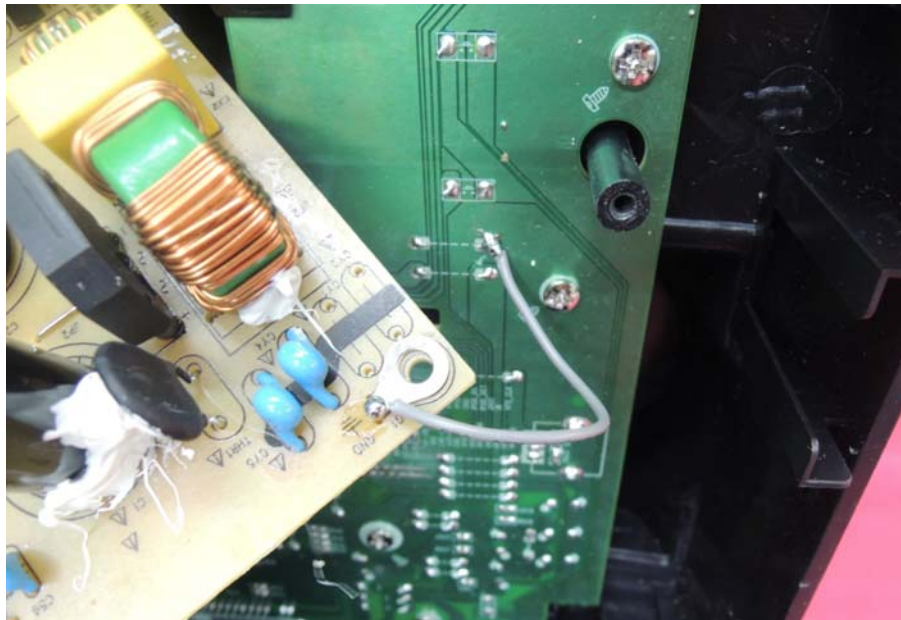
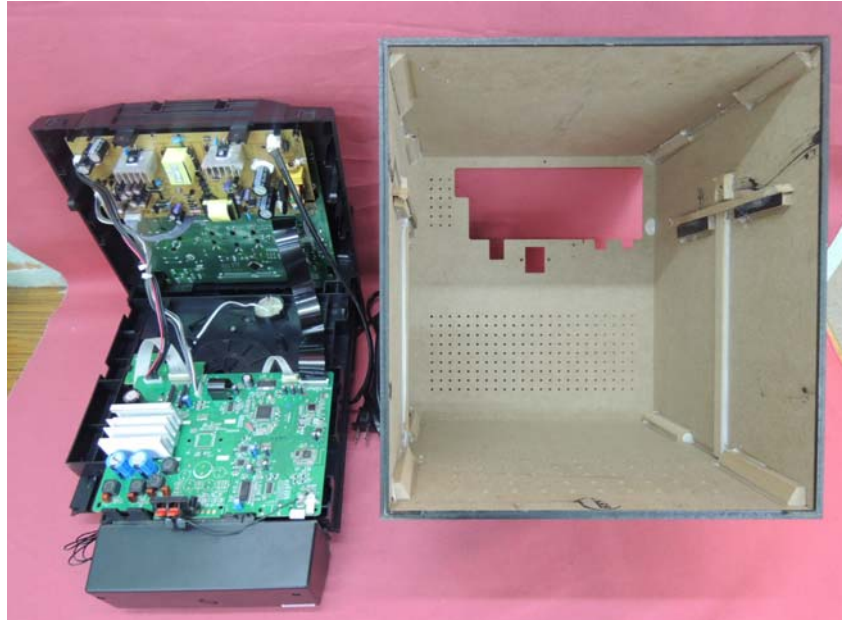

INTERTEK TESTING SERVICE

Report No.: 14010277HKG-002

Equipment Photographs

Model: CD2767BE

(Internal)



FCC ID: A2HRS2867B
IC: 9903A-RS2867B

INTERTEK TESTING SERVICE

Report No.: 14010277HKG-002

Equipment Photographs

Model: CD2767BE

(Internal)



INTERTEK TESTING SERVICE

Report No.: 14010277HKG-002

Equipment Photographs

Model: CD2767BE

(Internal)

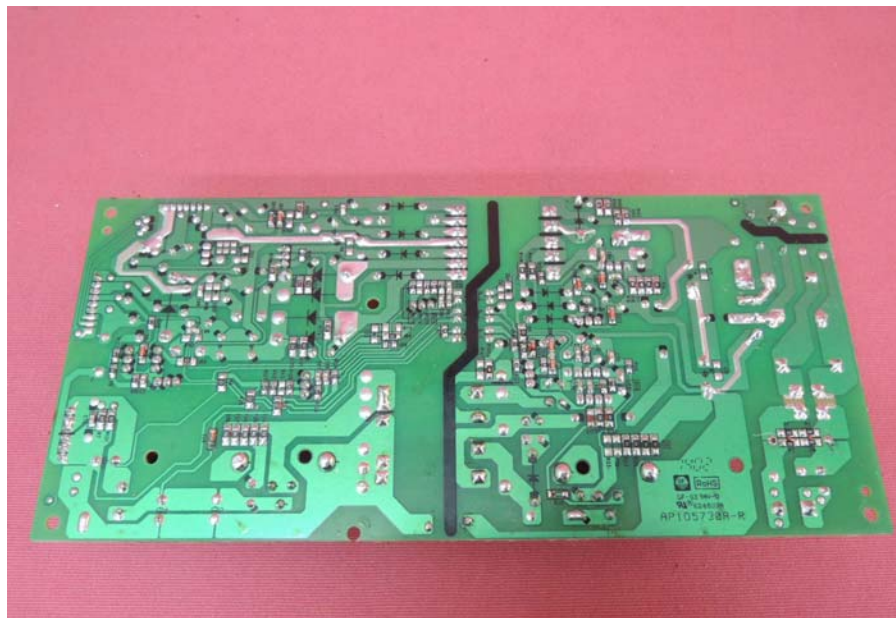
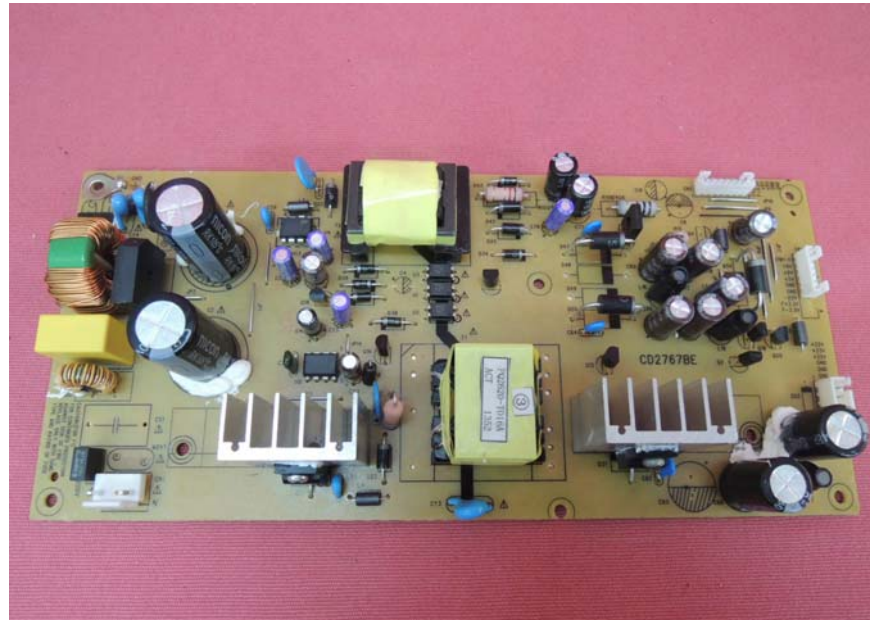

FCC ID: A2HRS2867B
IC: 9903A-RS2867B

INTERTEK TESTING SERVICE

Report No.: 14010277HKG-002

Equipment Photographs

Model: CD2767BE

(Internal)

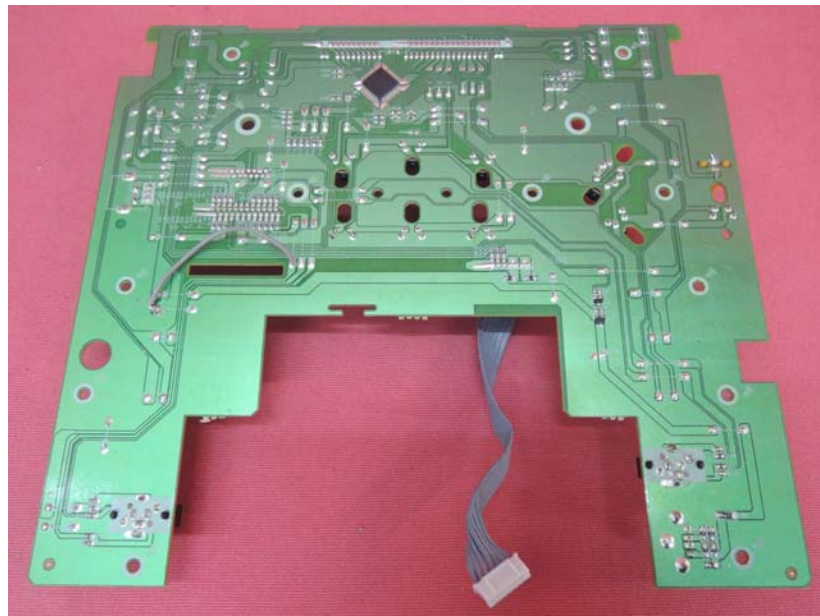
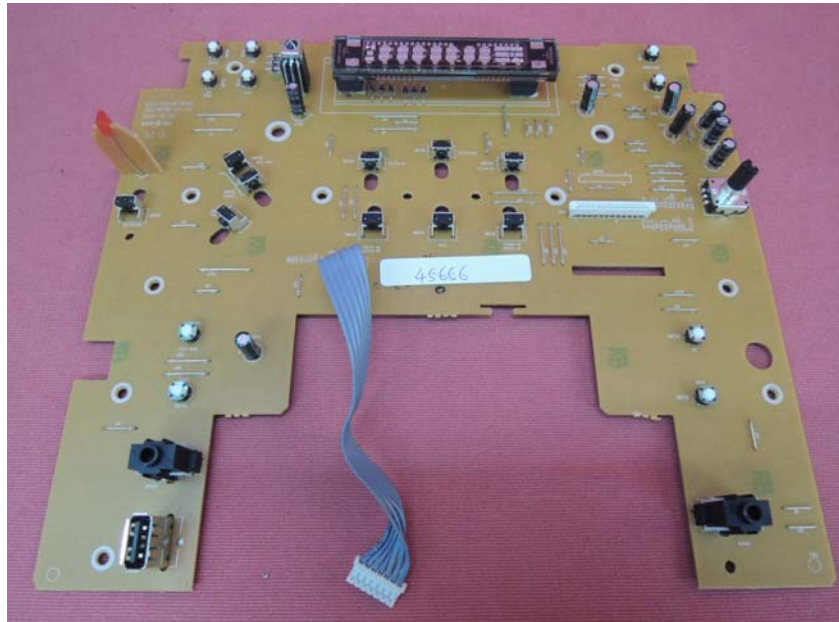

FCC ID: A2HRS2867B
IC: 9903A-RS2867B

INTERTEK TESTING SERVICE

Report No.: 14010277HKG-002

Equipment Photographs

Model: CD2767BE

(Internal)

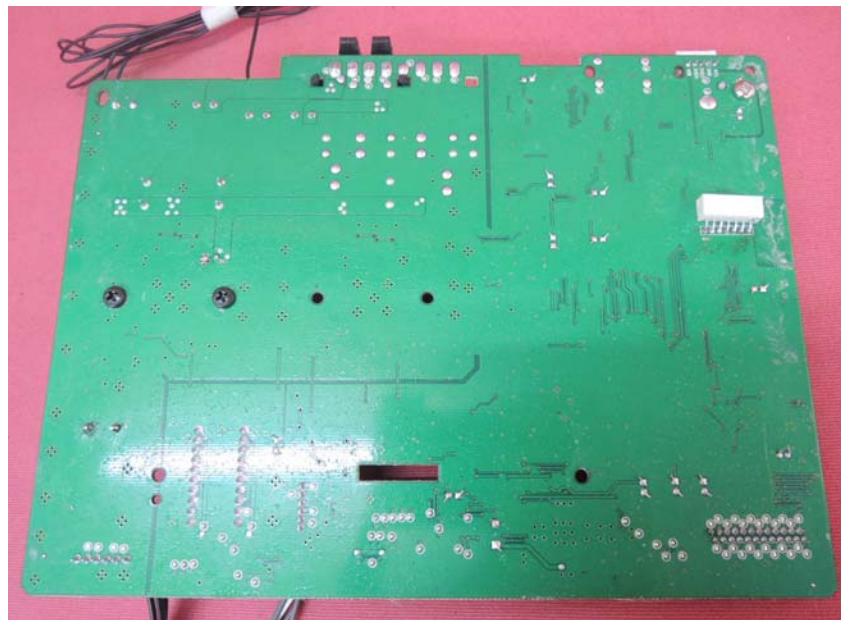
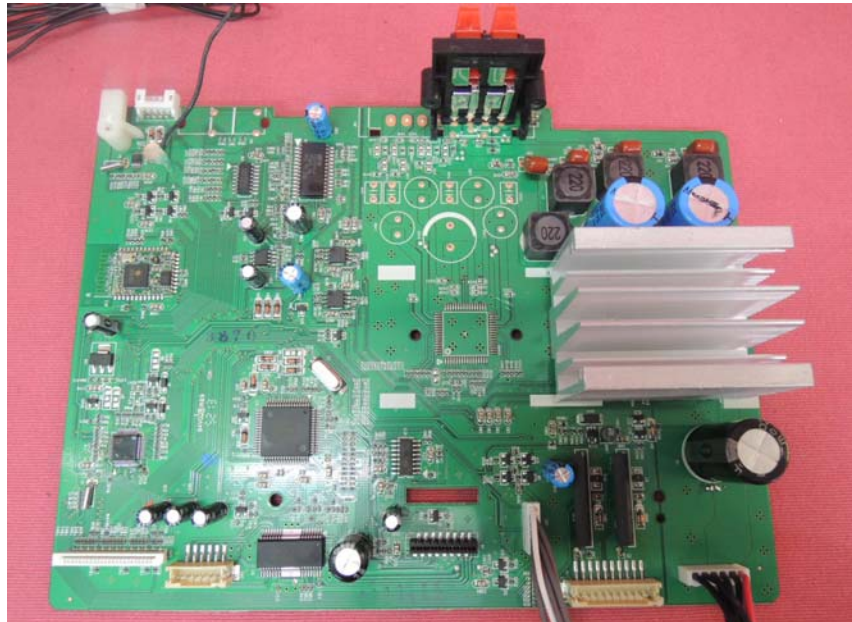

FCC ID: A2HRS2867B
IC: 9903A-RS2867B

INTERTEK TESTING SERVICE

Report No.: 14010277HKG-002

Equipment Photographs

Model: CD2767BE

(Internal)

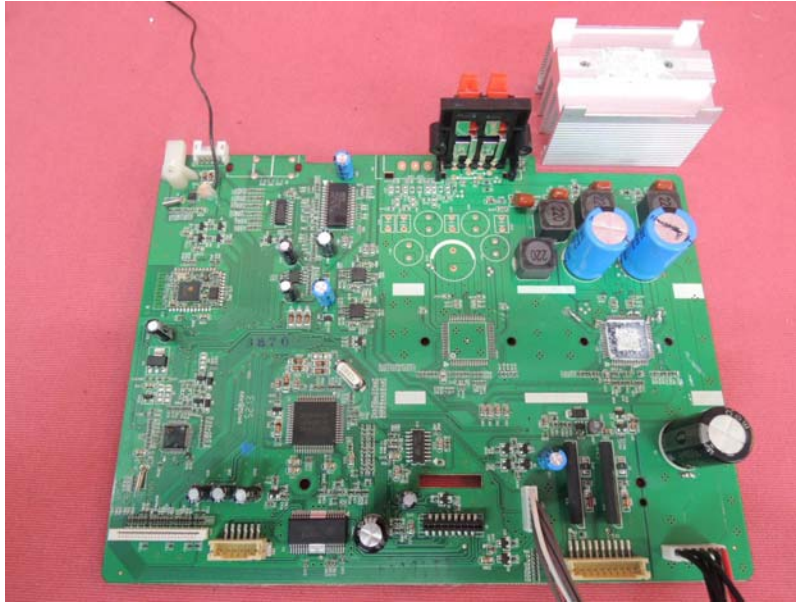

FCC ID: A2HRS2867B
IC: 9903A-RS2867B

INTERTEK TESTING SERVICE

Report No.: 14010277HKG-002

Equipment Photographs

Model: CD2767BE

(Internal)

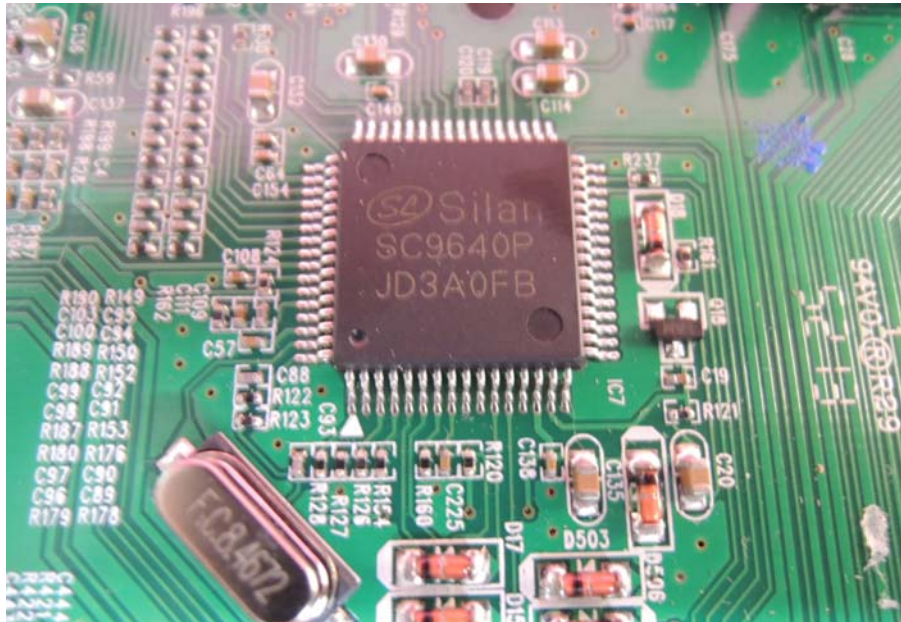

FCC ID: A2HRS2867B
IC: 9903A-RS2867B

INTERTEK TESTING SERVICE

Report No.: 14010277HKG-002

Equipment Photographs

Model: CD2767BE

(Internal)

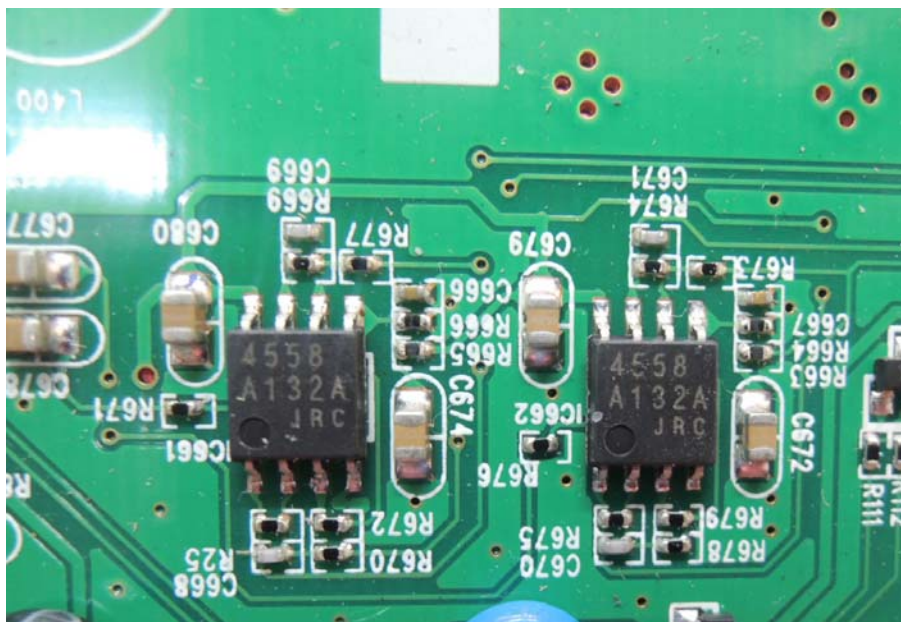
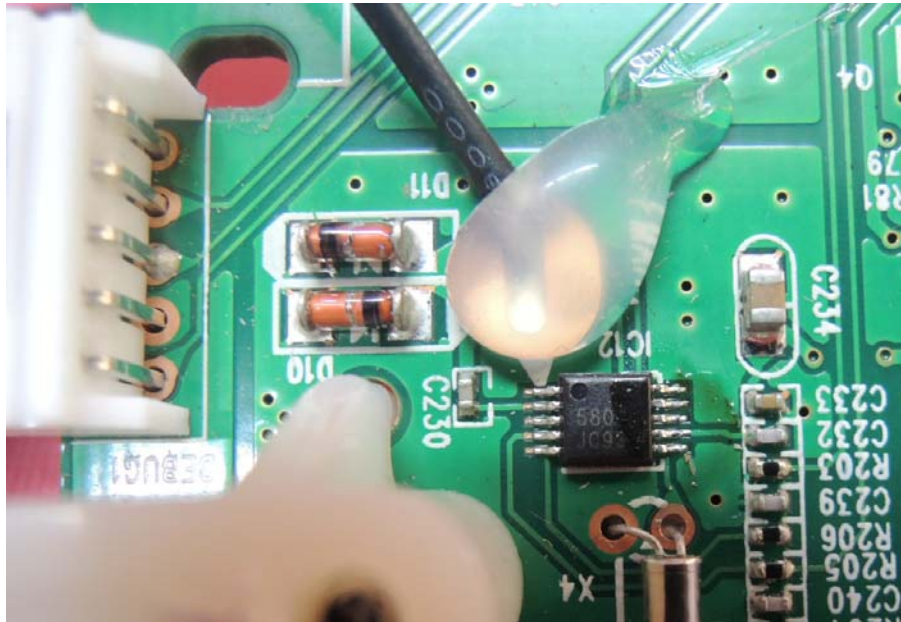

INTERTEK TESTING SERVICE

Report No.: 14010277HKG-002

Equipment Photographs

Model: CD2767BE

(Internal)

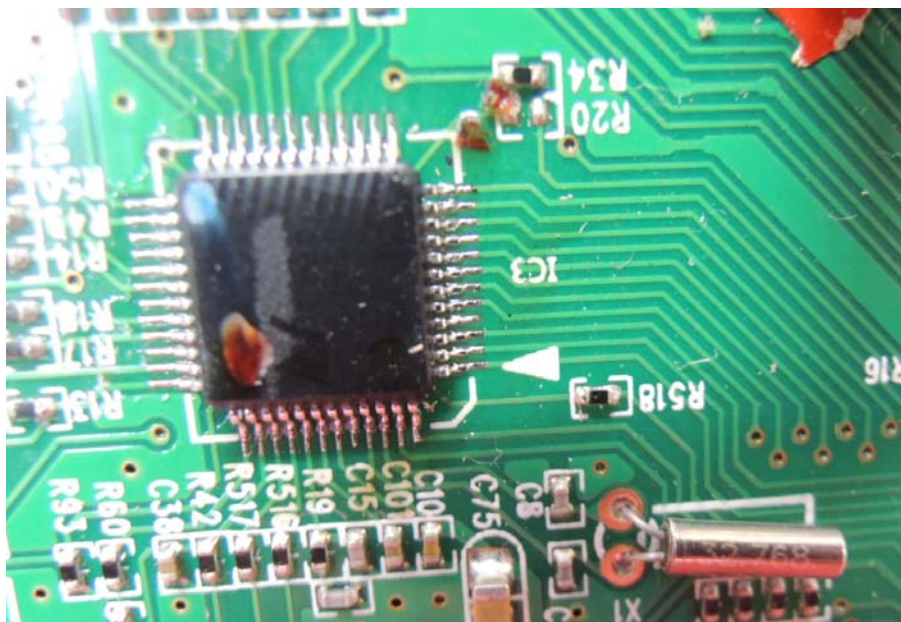

INTERTEK TESTING SERVICE

Report No.: 14010277HKG-002

Equipment Photographs

Model: CD2767BE

(Internal)

