

EntryEvo BT single model internal Photo

Without Top cover

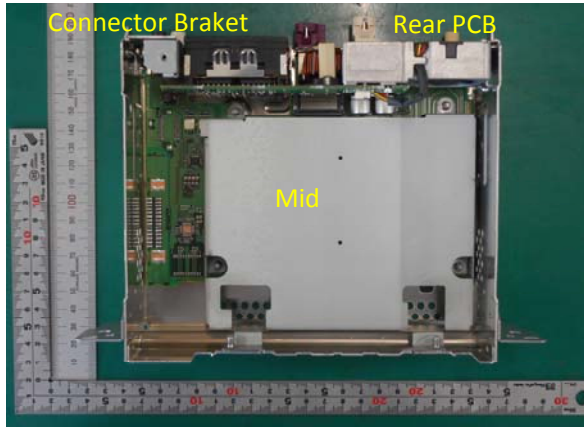

Without Mid Chassis

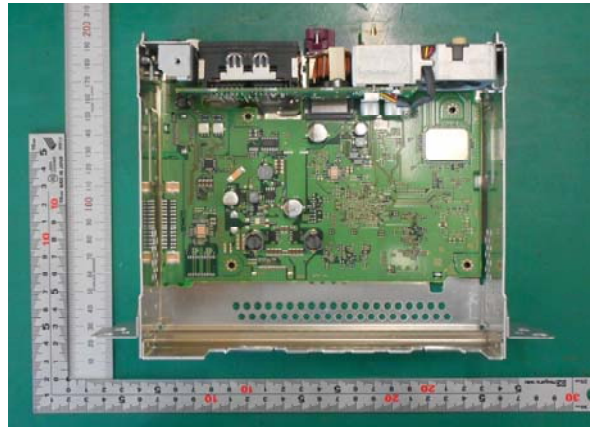

Without Rear PCB

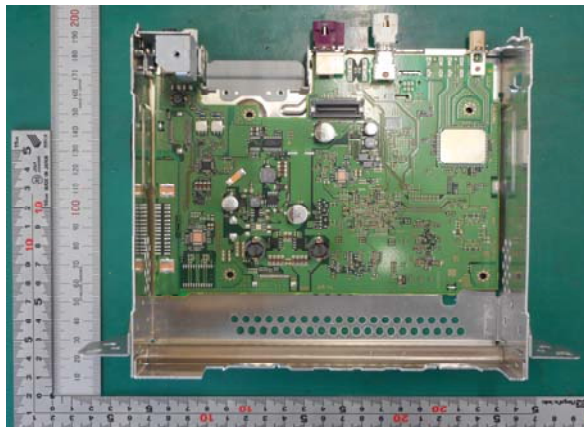

Without Connector Braket

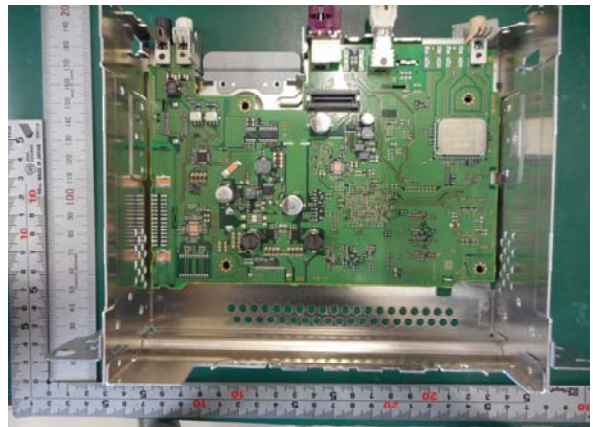

EntryEvo Bluetooth single model MAIN PCB Photo

Main PCB Top view

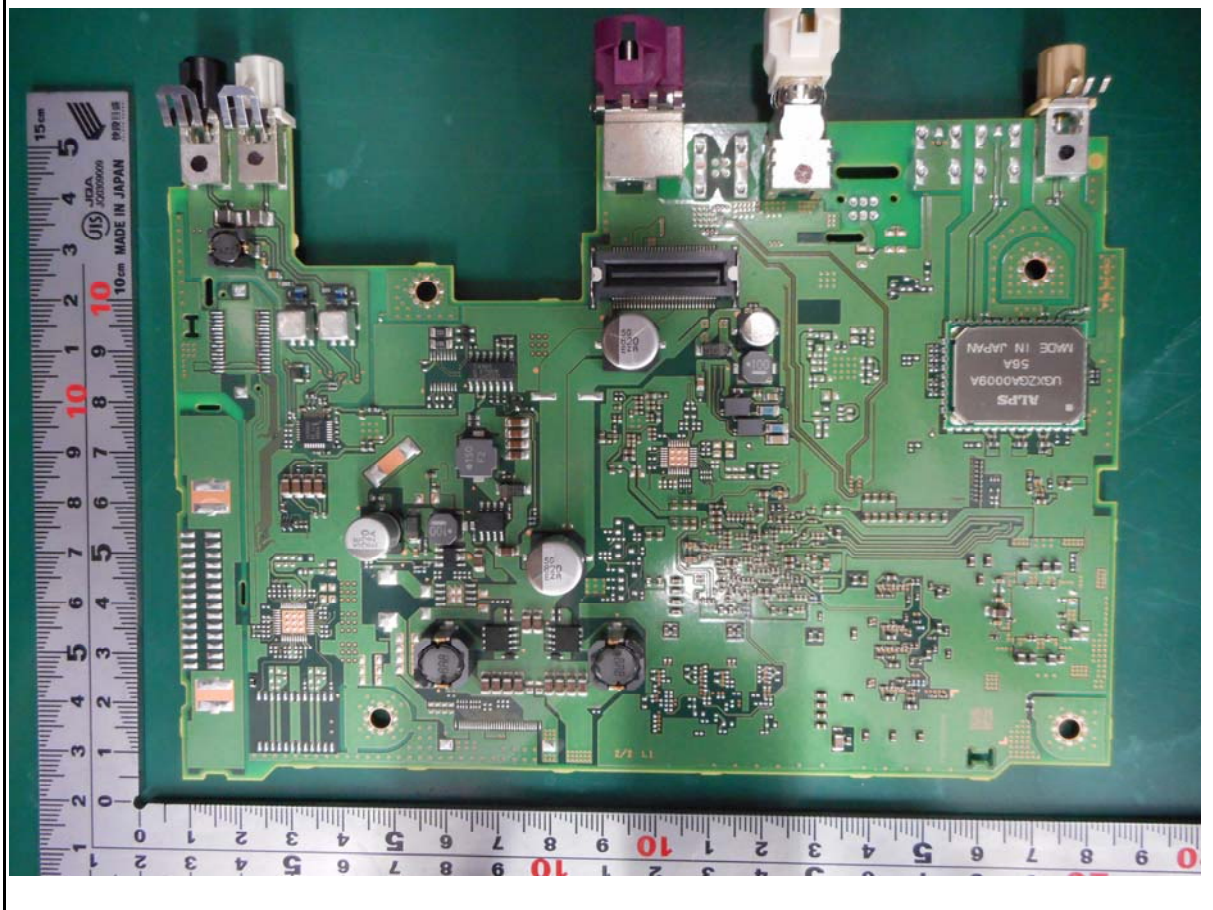

Main PCB Bottom view

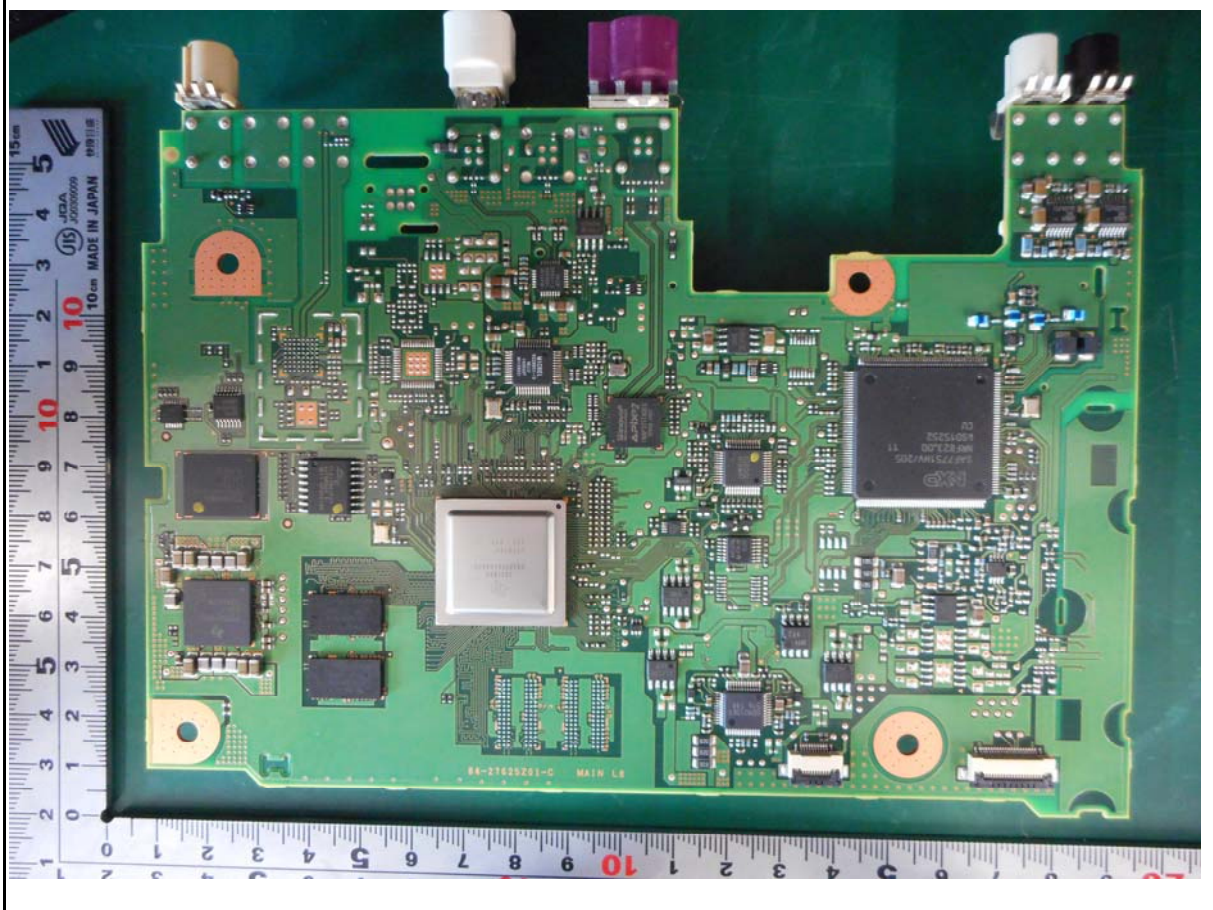

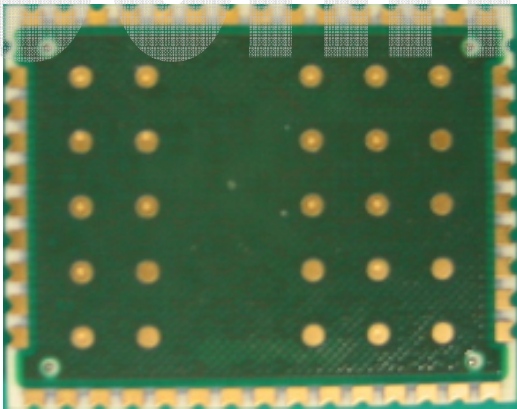
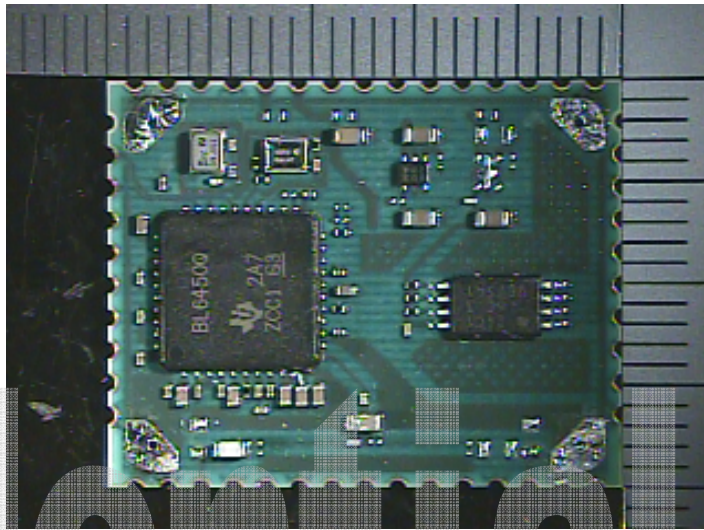
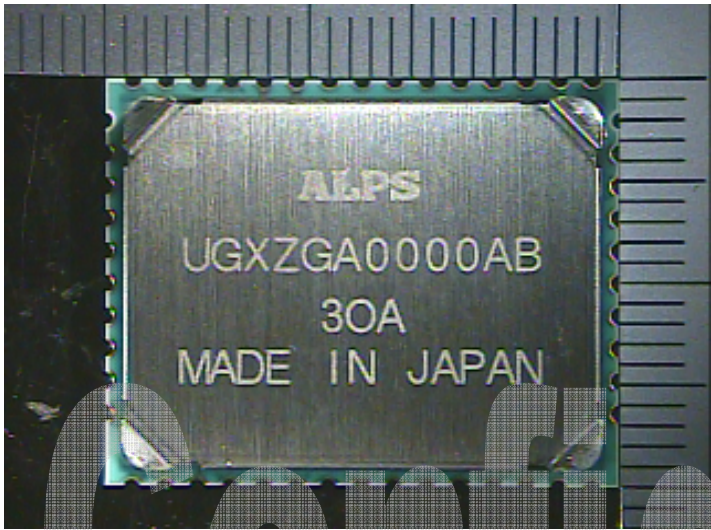

Confidential