

Contents

A-Z

Owner's Manual



The Ultimate
Driving Machine®



NAVIGATION AND INFOTAINMENT. OWNER'S MANUAL.

Owner's Manual for Navigation, Entertainment, Communication

Thank you for choosing a BMW.

The more familiar you are with the systems of your BMW, the more easily you will be able to take full advantage of them. We therefore strongly suggest:

Read this Owner's Manual before starting off in your new BMW. Also use the Integrated Owner's Manual in your vehicle. It contains important information on the operation of your navigation, entertainment and communication systems that will help you make full use of the technical features they offer.

Any updates made after the editorial deadline can be found in the appendix of the printed Owner's Manual for the vehicle.

You can find supplementary information in the additional brochures in the onboard literature.

We wish you a safe and enjoyable trip.



The Owner's Manual is available in many countries as an app. Additional information on the Internet:

www.bmw.com/bmw_drivers_guide

© 2016 Bayerische Motoren Werke
Aktiengesellschaft
Munich, Germany
Reprinting, including excerpts, only with the written
consent of BMW AG, Munich.
US English II/16, 03 16 490
Printed on environmentally friendly paper, bleached
without chlorine, suitable for recycling.

The application product is Model EE0001.

USA, Canada

USA (FCC) and Canada (IC)

Register model name: EE0001/EE0002

Product code: NB00003***

FCC CAUTION

Changes or modifications not expressly approved by the party responsible for compliance could void the user's authority to operate the equipment.

This transmitter must not be co-located or operated in conjunction with any other antenna or transmitter.

This device complies with part 15 of FCC Rules and Industry Canada's licence-exempt RSSs. Operation is subject to the following two conditions: (1) this device may not cause harmful interference, and (2) this device must accept any interference received, including interference that may cause undesired operation.

Le présent appareil est conforme à la partie 15 des règles de la FCC et aux normes des CNR d'Industrie Canada applicables aux appareils radio exempts de licence.

L'exploitation est autorisée aux deux conditions suivantes : (1) l'appareil ne doit pas produire de brouillage, et (2) l'appareil doit accepter tout brouillage subi, même si le brouillage est susceptible d'en compromettre le fonctionnement.

For WLAN combo model, EE0001:

This equipment complies with FCC/IC radiation exposure limits set forth for an uncontrolled environment and meets the FCC radio frequency (RF) Exposure Guidelines and RSS-102 of the IC radio frequency (RF) Exposure rules. This equipment should be installed and operated keeping the radiator at least 20cm or more away from person's body.

Cet équipement est conforme aux limites d'exposition aux rayonnements énoncées pour un environnement non contrôlé et

respecte les règles les radioélectriques (RF) de la FCC lignes directrices d'exposition et d'exposition aux fréquences radioélectriques (RF) CNR-102 de l'IC. Cet équipement doit être installé et utilisé en gardant une distance de 20 cm ou plus entre le radiateur et le corps humain.

For Bluetooth single model, EE0002:
This equipment complies with FCC/IC radiation exposure limits set forth for an uncontrolled environment and meets the FCC radio frequency (RF) Exposure Guidelines and RSS-102 of the IC radio frequency (RF) Exposure rules. This equipment has very low levels of RF energy that is deemed to comply without maximum permissive exposure evaluation (MPE).

Cet équipement est conforme aux limites d'exposition aux rayonnements énoncées pour un environnement non contrôlé et respecte les règles les radioélectriques (RF) de la FCC lignes directrices d'exposition et d'exposition aux fréquences radioélectriques (RF) CNR-102 de l'IC. Cet équipement émet une énergie RF très faible qui est considérée comme conforme sans évaluation de l'exposition maximale autorisée (MPE).

Contents

The fastest way to find information on a particular topic or item is by using the index, refer to page 94.

Navigation

- 8 Overview
- 9 Destination input
- 14 Trip
- 16 Map
- 23 Adjusting
- 26 Split screen
- 27 Traffic bulletins
- 30 Navigation data
- 31 Frequently asked questions

Entertainment

- 34 General information
- 36 Tone
- 38 Radio
- 45 Audio
- 55 Video
- 58 Rear audio remote control
- 59 Rear entertainment

Communication

- 70 Telephone
- 84 WiFi hotspot
- 85 ConnectedDrive

Reference

- 94 Everything from A to Z



Navigation

This chapter contains various examples of how the navigation system can guide you reliably to your destination.

Overview

Vehicle features and options

This chapter describes all standard, country-specific and optional features offered with the series. It also describes features that are not necessarily available in your vehicle, e. g., due to the selected options or country versions. This also applies to safety-related functions and systems. When using these functions and systems, the applicable country provisions must be observed.

General information

The navigation system can determine the precise position of the vehicle with the aid of satellites, and can reliably guide you to every entered destination.

Navigation data is stored in the vehicle and can be updated from a USB storage device.

Calling up the navigation system

1.  Press button on the controller.
2. "Navigation"

Information



WARNING

Operating the integrated information systems and communication devices while driving can distract from traffic. It is possible to lose control of the vehicle. There is risk of an accident. Only use the systems or devices when the traffic situation allows. If necessary, stop and use the systems and devices while the vehicle is stationary. ◀



WARNING

There can be deviations between the current traffic situation and details of the navigation instructions, e.g., changed streets or road construction. There is risk of an accident. The respectively valid traffic rules take precedence. ◀

Destination input

Vehicle features and options

This chapter describes all standard, country-specific and optional features offered with the series. It also describes features that are not necessarily available in your vehicle, e. g., due to the selected options or country versions. This also applies to safety-related functions and systems. When using these functions and systems, the applicable country provisions must be observed.

Entering a destination via address

General information

Destination guidance is started to the town/city center if no street is entered.

Selecting the state/province

1. "Navigation"
2. "Enter address"
3. "State/Province?"
4. Move the controller to the right to select the state from the list.

Entering the address

Concept

The address can be entered in any order.

Example: entering the address via the town/city

1. "City/Postal code?"
2. Enter the town/city.
The list is narrowed down further with each entry.
3. **OK** Select the symbol.

4. Move the controller to the right to select the town/city from the list.
5. If necessary, enter the street.
6. Select the street as you would the city.
7. If necessary, enter a house number.
8. **OK** Select the symbol.
9. Select a house number or range of house numbers from the list.

Starting destination guidance

"Start guidance" or Adding an intermediate destination, refer to page 14.

Recent destinations

General information

The previous destinations driven to are saved automatically.

Calling up destination from recent destinations

1. "Navigation"
2. "Recent destinations"
3. Select the destination.

Deleting the recent destinations

1. "Navigation"
2. "Recent destinations"
3. Highlight the destination.
4.  Press button.
5. "Delete destination" or "Delete all recent destinations"

Quick search

General information

Depending on the equipment, Points of Interest and addresses can be searched for by entering a sequence of letters or by searching in the navigation data stored in the vehicle.

All entries are displayed that include this text string.

It is possible to search simultaneously by town/city and street. To do this, enter a text string for the town/city, then a space and a text string for the street name.

Calling up quick search

1. "Navigation"
2. "Enter new destination"
3.  "Quick search"
4. Enter at least three letters or characters.
5. **OK** Select the symbol, if needed.
Results are displayed in a list.
6. Move the controller to the right.
7. Select desired destination.

Destination entry by voice

General information

- ▷ Instructions for the voice activation system, see vehicle Owner's Manual.
- ▷ When making a destination entry by voice, you can change between voice operation and iDrive.
- ▷ To have the available voice commands read out loud: ›Voice commands‹ or ›Help‹.

Saying the entries

- ▷ To enter an address by voice, the system language must be set to the respective country language.

- ▷ Complete addresses can be entered in a single command.
- ▷ Countries, towns and cities, streets, and intersections can be said as whole words or spelled in the language of the system.
- ▷ Spell the entry if the spoken language and the language of the system differ.
- ▷ Say the letters smoothly, and avoid exaggerating the pronunciation and inserting lengthy pauses between the letters.
- ▷ The options available for entering data depend on the navigation data and the country and language settings.

Entering an address in a command

1.  Press button on the steering wheel.
2. ›Enter destination‹
3. Wait for a request from the voice activation system.
4. Say the address in the suggested order.
5. Continue making the entry as prompted by the voice activation system.

If necessary, individually name the separate parts of the address, e.g., the town/city.

Home address

Using the home address as the destination

The home address must be stored.

1. "Navigation"
2. "Enter new destination"
3.  "Home address"

Defining the home address

1. "Navigation"
2. "Enter new destination"

3.  "Set home address"
4. Enter the address and possibly a name and further details.

Changing the home address

The home address is stored in the contacts and can be changed there. Edit contacts, refer to page 77.

Points of Interest

General information

Points of Interest are destinations that can be helpful while driving. Points of Interest, such as restaurants, hotels, or gas stations, can be added as destinations. Even with the most current navigation data, information regarding particular Points of Interest may have changed. E.g., certain gas stations may not be operating.

Find Points of Interest

Calling up Points of Interest

1. "Navigation"
2. "Enter new destination"
3.  "Points of Interest"
4. Select the desired setting.
 - ▷ "Online search": search for Points of Interest on the Internet.
 - ▷ "Keyword search" or "Category search": search for Points of Interest in the navigation data stored in the vehicle.
 - ▷ Search via preferred Points of Interest categories.

Online Search

1. "Online search"
2. Enter the keyword.
Suggestions are displayed.
3. Select a suggestion.

A list of the Points of Interest is displayed.

4. "Search area"
The search location can be modified as needed.
5. Select a Points of Interest.
Details are displayed.
6. Select the address.
7. If necessary, "Start guidance"

Keyword search

1. "Keyword search"
2. Enter a search term.
3. **OK** Select the symbol.
Points of Interest at the current location are searched for.
A list of the Points of Interest is displayed.
The Points of Interest are sorted by distance.
4. "Change location and sorting": the search can be adjusted, if needed.
 - ▷ "Location": Change search location.
 - ▷ "Sort by": Change sorting.
5. Select a Points of Interest.
Details are displayed.
6. Select the address.
7. If necessary, "Start guidance"

Category search

1. "Category search"
2. "All categories" or select the desired Points of Interest category.
Points of Interest at the current location are searched for.
3. A list of the Points of Interest is displayed.
The Points of Interest are sorted by distance.
4. "Change location and filter": adjust the search criteria if needed:
 - ▷ "Location": Change search location.

- ▶ "Sort by:": Change sorting.
 - ▶ If necessary, select category details.
 - ▶ "Keyword": narrow down the list via a keyword search.
5. "Show results"
 6. Select a Points of Interest.
Details are displayed.
 7. Select the address.
 8. If necessary, "Start guidance"

Preferred Points of Interest categories

The Points of Interest categories that have been search for the most are displayed.

Select a preferred Points of Interest category to seary for Points of Interest in the desired category at you current location.

Displaying Points of Interest on the map

The Points of Interest categories can be displayed on the map as symbols.

Select categories:

1. "Navigation"
2. "Settings"
3. "Map settings"
4. "Map elements"
5. "Points of Interest"
6. Select the desired setting.

The display in the function bar of the map view can be switched on and off, refer to page 20.

Selecting a destination from the contacts

1. "Navigation"
2. "Enter new destination"
3.  "Contacts"
Contacts with addresses are displayed if these have been checked as destinations

from among the Contacts. Check the address as a destination, refer to page 76.

4. Select a contact.
5. Select the address.
6. "Start guidance"

Destination entry using GPS coordinates

Concept

Destinations can also be entered directly using GPS coordinates.

Enter the coordinates in degrees, minutes and seconds or as decimal values.

Open

1. "Navigation"
2. "Enter new destination"
3.  "GPS coordinates"
4. "Format"
 - ▶ "Degrees Minutes Seconds"
 - ▶ "Decimal"
5. "Longitude" or "Latitude"
6. Turn the controller until the desired degree indication or point of the compass is displayed.
7. Press the controller.
8. Enter the values for minutes and seconds and point of compass, if needed.
9. "Accept destination"

Destination entry via Concierge service

Concierge service provides information, e.g., about hotels and restaurants. Addresses can be transmitted directly to the navigation system.

1. "Navigation"

2. "Enter new destination"

3.  "Concierge"

A voice connection to the Concierge service is established.

Trip

Vehicle features and options

This chapter describes all standard, country-specific and optional features offered with the series. It also describes features that are not necessarily available in your vehicle, e. g., due to the selected options or country versions. This also applies to safety-related functions and systems. When using these functions and systems, the applicable country provisions must be observed.

General information

When planning a trip, several intermediate destinations can be entered.

New trip

1. "Navigation"
2. "Map"
3. Move the controller to the left, if needed.
4.  "Guidance"
5. "Enter new destination"
6. Select a single destination.
7. Enter the intermediate destination.

Entering intermediate destinations

Before entering an intermediate destination, an individual destination must be set.

A maximum of 20 intermediate destinations can be entered for one trip.

1. "Navigation"
2. "Add intermediate destination"
3. Select the type of destination entry.
4. Enter the intermediate destination.

Alternatively, the intermediate destination can also be entered using the map.

1. "Navigation"
2. "Map"
3.  "Guidance"
4. "Add intermediate destination"
5. Select the type of destination entry.
6. Enter the intermediate destination.

The intermediate destination is entered in the destination list and is highlighted.

Starting the trip

1. Enter desired intermediate destination.
2.  "Start guidance"

Editing intermediate destinations

1. "Navigation"
2. "Map"
3.  "Guidance"
4. Select an intermediate destination.
5. Select the desired setting.
 - ▷ "Skip destination": skip current intermediate destination.
 - ▷ "Start guidance": start destination guidance to intermediate destination.
 - ▷ "Change order": move an intermediate destination to another position in the list.
 - ▷ "Delete destination": Delete intermediate destination.

Storing a trip

Up to 30 trips can be stored in the trip list. If necessary, delete existing trips to be able to store new trips.



1. "Navigation"
2. "Map"
3.  "Guidance"
4. "Save trip"
5. Enter the name.
6. **OK** Select the symbol.

4. Select another intermediate destination, if needed.
5. "Edit trip" or "Start guidance"

Selecting a stored trip

1. "Navigation"
2. "Trips"
3.  "My trips"
4. Select a stored trip.
5. "Edit trip" or "Start guidance"

Deleting a stored trip

1. "Navigation"
2. "Trips"
3.  "My trips"
4. If necessary, highlight the desired trip.
5.  Press button.
6. "Delete all trips" or "Delete trip"

Calling up the last trip

The last trip is automatically stored and can be called up again.

1. "Navigation"
2. "Trips"
3. "Last trip created"

Map

Vehicle features and options

This chapter describes all standard, country-specific and optional features offered with the series. It also describes features that are not necessarily available in your vehicle, e. g., due to the selected options or country versions. This also applies to safety-related functions and systems. When using these functions and systems, the applicable country provisions must be observed.

Opening the map

1. "Navigation"
2. "Map"

 The map can also be accessed directly with the button on the controller.

Overview

General information







The map can be used via iDrive.
For a basic explanation about operating via iDrive, refer to the Owner's Manual for the vehicle.



Map view



- 1 Function bar
- 2 Route section with traffic obstruction
- 3 Traffic sign for traffic obstruction
- 4 Planned route
- 5 Current location
- 6 Status field
- 7 If equipped with touchscreen: display current location

Function bar

Symbol	Function
	Start/end destination guidance.
	Switch spoken instructions on and off.
	Change current route.
	Traffic information. Status of the traffic information.
	Detour available.
	Display additional information on map.

Symbol	Function
	Select the map view.
	Interactive map.

To change to the function bar, move the controller to the left.

Status field

The following information is displayed:

- ▶ Symbol for active destination guidance.
- ▶ Time of arrival and distance to destination.
- ▶ If necessary, time delay due to traffic obstructions.

Lines in the map

Streets and routes are displayed in different colors and line styles depending on their classification.

- ▶ Dashed lines: railways and ferry connections.
- ▶ Thin lines: country borders.

Traffic obstructions

If traffic information of a radio station or a traffic information service is received, traffic instructions can be displayed on the map.

Destination guidance

Starting

1. "Navigation"
2. Enter the destination, refer to page 9.
3.  "Start guidance"



After the route has been started, a message is displayed with the most important set route criteria.

Exit

1. "Navigation"
2. "Map"
3. Move the controller to the left.
4.  Select the symbol.
5. "Stop guidance"

Storing the current destination as contact



After entering the destination, store the destination in the contacts.

1. "Navigation"
2. "Map"
3.  "Guidance"
4.  Press button.
5. "Save as contact" or "Add to contact"
6. Select an existing contact, if available.
7. Enter name and, if necessary, additional details.
8. "Save contact in the vehicle"

Spoken instructions

Switching on/off

The setting is stored for the driver profile currently used.

1. "Navigation"
2. "Map"
3.   "Voice instructions"

Repeat

Via iDrive:

1. "Navigation"
2. "Map"
3. Press the controller.
4. "Repeat voice instruction"

Using the button:



Press button twice.

Volume

Turn the volume button during the spoken instructions until the desired volume is set.

Store on Favorites buttons

The function for switching the spoken instructions on/off can be stored on a programmable memory button for quick access.

Changing the route details

Route criteria

General information

The route calculated can be influenced by selecting certain criteria.

Information

The recommended route may differ from the route you would take based on personal experience.

The setting is stored for the driver profile currently used.

Standard settings for route criteria

The route criteria can be individually adjusted. The settings are stored as standard and automatically applied to new destination guidances.

Default settings for route, refer to page 23.

With destination guidance active: changing route criteria in the map view

If destination guidance is active, the route criteria for the current destination can be changed in the map view:

1. "Navigation"
2. "Map"

3. "Route"
4. Select the desired setting.
5. If necessary, select general routine criteria: "General route settings"

Alternative routes

If possible, alternative routes are suggested during active route guidance.

1. "Route"

An overview showing the current route and the suggested alternative routes is displayed. In addition, details such as travel time and route length, and information about fuel consumption for the alternative routes compared to the current route may be displayed, if required.

The routes are shown in color on the split screen.

2. Select an alternative route in order to apply it to the destination guidance.

Online alternative routes

General information

Online alternative routes are transmitted online to the vehicle.

Information about traffic disruptions and forecasts are taken into account for this.

Symbol indicates online alternative routes.

Activate/deactivate online alternative routes

If the dynamic destination guidance has been activated along with the online alternative routes, available online alternative routes are automatically adopted in the destination guidance.

1. "Navigation"
2. "Settings"
3. "Route settings"
4. "Online routes"

Route details

General information

During destination guidance, more detailed information about the current route can be displayed and/or the route can be adjusted.

Depending on the equipment, different views of the route are available during destination guidance:

- ▶ List of route sections, refer to page 19.
- ▶ Map view, refer to page 16.
- ▶ Destination guidance notes on the map, refer to page 21.
- ▶ Arrow view in the split screen, refer to page 26.
- ▶ Arrow view in the instrument cluster.
- ▶ Arrow view in the Head-up Display.

Displaying list of route sections

When destination guidance is activated, a list of route sections can be displayed. The distance to be driven per route section is displayed.

If needed, gas station recommendations are displayed as well.

1. "Navigation"
2. "Map"
3. "Route"
4. "Route details"
5. Highlight route section.

The route section is displayed on the split screen.

Bypassing a section of the route

Calculate a new route for a route section.

1. "Navigation"
2. "Map"
3. "Route"
4. ↑↑ "Change route"
5. "Detour:"

6. Turn Controller until the desired distance before returning to the original route is displayed.
7. Press the controller.

Resuming the original route

If the route section should no longer be bypassed:

1. "Navigation"
2. "Map"
3. "Route"
4. ↑↑ "Change route"
5. "Delete detour"

Changing the route details

Concept

With active destination guidance, the route displayed on the map can be adjusted manually. To do this, drag the route using a marking point on the route, the so-called route magnet, in the desired direction.

Setting a route magnet

1. "Navigation"
2. "Map"
3. "Route"
4. ↑↑ "Change route"
5. "Add route magnet"
6. As with the interactive map, drag route magnet to the desired location using the controller:
 - ▶ To change the scale: turn the controller.
 - ▶ To shift the map: move the controller in the required direction.
 - ▶ To shift the map diagonally: move the controller in the required direction and turn it.
7. Press the controller.
8. "Accept magnet"

Editing a route magnet

1. "Navigation"
2. "Map"
3. "Route"
4.  "Change route"
5. Select the desired setting.
 - ▶ "Modify route magnet": modify changed route once more.
 - ▶ "Remove route magnet": the original route is restored.

Simulating destination guidance

Concept

While the vehicle is stopped and destination guidance is active, driving on the route can be simulated.









Open

1. "Navigation"
2. "Map"
3. "Route"
4. "Route flyover"

The route is displayed on the map.

Functions and settings

Move the controller to the left to call up additional functions and settings.

Symbol	Function
	"Start route flyover"
	"Stop"
	"Speed:"
	"Next route section"
	"Previous route section"
	"Jump to destination"
	"Jump to position"
	"Points of Interest"

Gas station recommendation



Concept

The remaining range is calculated, and if needed, gas stations along the route are displayed.





Even with the most current navigation data, information regarding individual gas stations may have changed. For instance, certain gas stations may not be operating.

Gas station recommendations are displayed in the Route list, refer to page 19.

Open

1.  "Refuel"
 - A list of gas stations is displayed.
2. Highlight a gas station.
 - The location of the gas station is displayed on the split screen.
3. Select the gas station.
4.  Select the symbol.
5. "Start guidance"

Displaying additional information on the map

1. "Navigation"
2. "Map"
3.  "Map content"
4. Select the desired setting.
 - ▶  "Points of Interest": symbols for Points of Interest are displayed.
 - ▶  "Traffic flow": lines for traffic flow are displayed. Information about traffic flow in the map view, refer to page 27.
 - ▶  "Traffic icons": symbols for traffic information is displayed.
 - ▶  "Weather": display weather symbols on the map via ConnectedDrive.

- ▶  "Satellite images": depending on availability and resolution, in some scales satellite images are displayed as the background.

Selecting a map view











Concept

The map view can be displayed in different perspectives, such as north-oriented or facing the direction of travel.

The scale of the map can be enlarged or reduced.

Additional settings for map, refer to page 24.

Selecting a map view

1. "Navigation"
2. "Map"
3.    "Map views"
4. Select the desired setting.
 - ▶  "Facing north"
 - ▶  "Perspective"
 - ▶  "Direction of travel"
 - ▶  "Auto zoom": with active destination guidance, the map is enlarged automatically when approaching a maneuver.
 - ▶  "Auto zoom with info": with active destination guidance, the map is enlarged automatically when approaching a maneuver. In addition, destination guidance hints are displayed on the map.
 - ▶  "Manual zoom": enlarge or reduce map scale manually.
 - ▶  "Route overview": display route between current location and destination.

Destination guidance hints

General information

If destination guidance is active, destination guidance hints can be displayed in the map view for the respective maneuvering points of the current route.

In the case of multi-lane roads, lane information may indicate the recommended lanes.

Destination guidance hints can also be displayed as arrow view in the split screen, refer to page 26.

Display

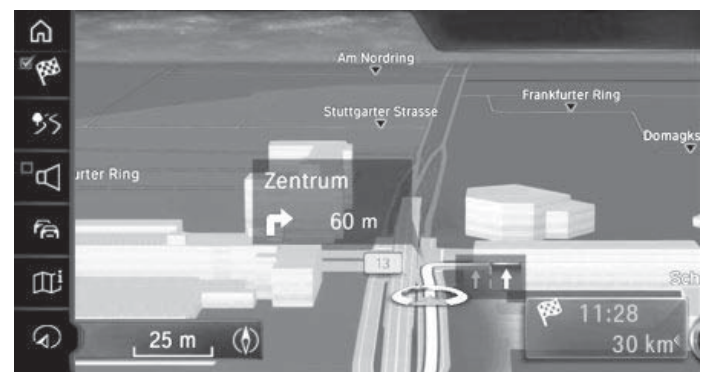

Functions in the map view

General information

Different information can be called up for any point on the map and settings can be adjusted. Here, the map can be used via iDrive.

Operating with the controller

1. "Navigation"
2. "Map"
3.  "Interactive map"
4. Select the destination with crosshairs.
 - ▶ To change the scale: turn the controller.
 - ▶ To shift the map: move the controller in the required direction.







- ▶ To shift the map diagonally: move the controller in the required direction and turn it.

5. Press the controller.

6. Select the desired setting.

Functions

Different functions are available depending on the point selected on the map:

- ▶  "Repeat voice instruction"
With destination guidance active.
- ▶  "Start guidance": start destination guidance.
- ▶  "Add as intermediate dest.": add destination.
- ▶ "Show details": details about the destination can be displayed as necessary.
- ▶ "Show details": if the crosshairs are positioned over a place with multiple Points of Interest, these destinations will be displayed in a list.
- ▶  "Leave interactive map": with operation via the controller: end interactive map.
- ▶  "Back to current location": if equipped with touchscreen: switch to normal map view.
- ▶  "Show destination": the map section around the destination is displayed.
- ▶  "Save position": store current position as contact.

Adjusting

Vehicle features and options

This chapter describes all standard, country-specific and optional features offered with the series. It also describes features that are not necessarily available in your vehicle, e. g., due to the selected options or country versions. This also applies to safety-related functions and systems. When using these functions and systems, the applicable country provisions must be observed.

General information

Navigation settings can be individually configured. Settings are stored for the driver profile currently used.

Route details

Concept

The route criteria can be individually adjusted. The settings are stored as standard and automatically applied to new destination guidances.

Default preference

1. "Navigation"
2. "Settings"
3. "Route settings"
4. "Default preference"
5. Select the desired setting.
 - ▷ "Fast": time-optimized route, being a combination of the shortest possible route and the fastest roads.
 - ▷ "ECO PRO" or "Efficient": fuel consumption-optimized route, being a combination of the route requiring low consumption and fast roads. Time of

arrival and consumption are based on driving in ECO PRO.

- ▷ "Short": distance-optimized route, being a combination of the shortest possible route and the fastest roads.

Further criteria

Settings

1. "Navigation"
2. "Settings"
3. "Route settings"
4. Select the desired setting.
 - ▷ Settings for dynamic destination guidance:
 - ▷ "Automatic": traffic information is considered in destination guidance. The current route is automatically changed as needed. Depending on the equipment version, online alternative routes are automatically applied as well.
 - ▷ "With confirmation": if suitable detours are available, a message is displayed first.
 - ▷ "Off": switch dynamic destination guidance off.
 - ▷ "Toll roads"
 - ▷ "Avoid"
 - ▷ "Use cash"
 - ▷ "Toll tag"
 - ▷ "Online routes": accept online alternative routes.
 - ▷ "Avoid highways": highways are avoided wherever possible.
 - ▷ "Avoid ferries": ferries are avoided where possible.

- ▶ "Avoid carpool roads": carpool lanes are avoided where possible.

Areas to be avoided

Concept

Areas that should be driven around can be specified as areas to be avoided.

Setting areas to be avoided

1. "Navigation"
2. "Settings"
3. "Route settings"
4. "Areas to avoid"
5. "Set new area to avoid"
6. Follow the instructions on the Control Display.
7. "OK"

Deleting areas to be avoided

1. "Navigation"
2. "Settings"
3. "Route settings"
4. "Areas to avoid"
5. If necessary, mark desired area to be avoided.
6.  Press button.
7. Delete desired area to be avoided or all areas to be avoided.

Learning the route

Concept

If multiple identical departures from the proposed route are made, this deviation is taken into account in future route planning.

Activate learning the route

1. "Navigation"
2. "Settings"

3. "Route settings"
4. "Learn route"

Reset the learned route

1. "Navigation"
2. "Settings"
3. "Route settings"
4.  Press button.
5. "###_Delete learned routes"

Map

Concept

The map view can be individually set. E.g., the map color and mode can be set. It can also be defined, which Points of interest are shown on the map.

Setting the map

1. "Navigation"
2. "Settings"
3. Select the desired setting.

Home address

Concept

The home address can be specified or changed.

Setting the home address

1. "Settings"
2. "Set home address" or "Change home address"

Navigation data

Concept

Information regarding position determination and navigation data version can be called up.

Settings

1. "Settings"
2. "Position and software version"
3. Select the desired setting.
 - ▷ "Enter position": the vehicle position can be manually set on the map in situations without GPS reception or, e.g., immediately after transport on a ferry.
 - ▷ "Software version": information about the current map version.
 - ▷ "Help to improve the navigation map": data such as speed or position is anonymized in the vehicle and transmitted to BMW in order to improve the digital map.

Reset the settings

1. "Navigation"
2. "Settings"
3.  Press button.
4. "Reset all settings"

Split screen

Vehicle features and options

This chapter describes all standard, country-specific and optional features offered with the series. It also describes features that are not necessarily available in your vehicle, e. g., due to the selected options or country versions. This also applies to safety-related functions and systems. When using these functions and systems, the applicable country provisions must be observed.

Concept

Different views can be set for the split screen separately from the main screen.

Settings

1. Move the controller to the right until the split screen is selected.
2. Press the controller.
3. Select the desired setting.
 - ▶ "Map view:": adjust map view and possibly select additional information, such as traffic events.
 - ▶ "Arrow display": with destination guidance active, the arrow view is displayed. If no destination guidance is active, a compass is displayed.
 - ▶ "Position": display current position.
 - ▶ "Exit ramp view": selected route sections, e.g., major road intersections, are shown in perspective view.

Arrow view

Concept

If destination guidance is active, the destination guidance hints can be displayed as list in the split screen.

Settings

It can be adjusted, which additional information should be displayed in the arrow view.

- ▶ "Arrow display"
 - ▶ "Traffic Info": display traffic flow and traffic events.
 - ▶ "Additional information": Display additional information such as tunnels.

Display

The following information is displayed during destination guidance:



- 1 Turn information
- 2 Traffic flow and traffic events
- 3 Status information
- 4 Upcoming street
- 5 Distance to next maneuver
- 6 Lane information
- 7 Current road

Depending on the country-specific version, the display may deviate from what is depicted.

Traffic bulletins

Vehicle features and options

This chapter describes all standard, country-specific and optional features offered with the series. It also describes features that are not necessarily available in your vehicle, e. g., due to the selected options or country versions. This also applies to safety-related functions and systems. When using these functions and systems, the applicable country provisions must be observed.

General information

Traffic information from traffic warning services or radio stations that broadcast Traffic Information, TI, can be displayed in the map view and taken into account when calculating routes. Information on traffic obstructions and hazards is updated continuously in this system.

The traffic information is indicated on the map by symbols.

In the event of special hazards, e.g., objects on the road, a message is displayed.

Several hazard messages are also displayed in the instrument cluster as a Check Control message.

Certain BMW models equipped with navigation have the capability to display traffic information. If your system has this capability, the following additional terms and conditions apply:

An End-User shall no longer have the right to use the traffic information in the event that the End-User is in material breach of the terms and conditions contained herein.

BMW or its third party providers hold the rights to the traffic data. You may not modify, copy, scan or use any other method to reproduce, duplicate, republish, transmit or distribute in any way any portion of traffic data.





The traffic data is for informational purpose only. Users assume all risk of use. BMW NA and its service providers make no representations about content, traffic and road conditions, route usability, or speed.

THE TRAFFIC DATA IS PROVIDED TO YOU "AS IS," AND "WHERE IS". BMW NA AND ALL THIRD PARTY PROVIDERS OF ANY OF THE TRAFFIC DATA, EXPRESSLY DISCLAIMS, TO THE FULLEST EXTENT PERMITTED BY LAW, ALL EXPRESS, IMPLIED OR STATUTORY WARRANTIES OR REPRESENTATIONS WITH RESPECT TO THE TRAFFIC DATA (INCLUDING, WITHOUT LIMITATION, THAT THE TRAFFIC DATA WILL BE ERROR-FREE, WILL OPERATE WITHOUT INTERRUPTION OR THAT THE TRAFFIC DATA WILL BE ACCURATE), INCLUDING, WITHOUT LIMITATION, THE IMPLIED WARRANTIES OF MERCHANTABILITY, NON-INFRINGEMENT FITNESS FOR A PARTICULAR PURPOSE, OR THOSE ARISING FROM A COURSE OF DEALING OR USAGE OF TRADE

NEITHER BMW NA NOR ITS THIRD PARTY PROVIDERS WILL BE LIABLE TO YOU FOR ANY INDIRECT, SPECIAL, CONSEQUENTIAL, EXEMPLARY, OR INCIDENTAL DAMAGES (INCLUDING, WITHOUT LIMITATION, LOST REVENUES, ANTICIPATED REVENUES, OR PROFITS RELATING TO THE SAME) ARISING FROM ANY CLAIM RELATING DIRECTLY OR INDIRECTLY TO USE OF THE TRAFFIC DATA, AND EVEN IF BMW NA OR ITS THIRD PARTY PROVIDERS ARE AWARE OF THE POSSIBILITY OF SUCH DAMAGES. THESE LIMITATIONS APPLY TO ALL CLAIMS, INCLUDING, WITHOUT LIMITATION, CLAIMS IN CONTRACT AND TORT (SUCH AS NEGLIGENCE, PRODUCT LIABILITY AND STRICT LIABILITY). SOME STATES DO NOT ALLOW THE EXCLUSION OR LIMITATION OF INCIDENTAL OR CONSEQUENTIAL DAMAGES,

SO THOSE PARTICULAR LIMITATIONS MAY NOT APPLY TO YOU.

Display in the function bar of the map view

Symbol	Function
	<p>Yellow symbol:</p> <p>The traffic information relates to the calculated route and the anticipated delay is less than 20 minutes.</p>
	<p>Symbol red:</p> <p>The anticipated delay is more than 20 minutes, or there is a road block or hazard warning for the route.</p>
	<p>Gray symbol:</p> <p>No traffic information is available or the anticipated delay is less than 5 minutes.</p>
	<p>A suitable detour is available for the traffic information.</p>

Realtime traffic information, RTTI

In some countries, realtime traffic information, RTTI, is transmitted by services that can be booked additionally, and which can then be used and displayed instead of the traffic information from the radio stations.

With the realtime traffic information, the locations of traffic obstructions are provided in greater, more precise detail. Traffic conditions on roads other than the highways, e.g., secondary roads and urban streets are also recorded and displayed for a wide area. Recommended detours can be calculated more accurately on the basis of this information. The risk of becoming caught in a further traffic obstruction on detour routes is reduced. If applicable, several detour recommendations or additional information may be offered.

When traveling in countries where realtime traffic information is not available, the traffic in-

formation from the radio stations are still used whenever possible.

The function bar in the map, refer to page 16, view shows whether TMC or RTTI traffic information is being used.

Switching on/off

1. "Navigation"
2. "Settings"
3. "Receive Traffic Info"

Displaying list of traffic information

1. "Navigation"
2. "Map"
3.  "Traffic Info"

With active destination guidance, first the traffic information for the calculated route are displayed with red symbols. Then, the traffic information that do not affect the route are shown with gray symbols. The traffic information is sorted by their distance from the current position of the vehicle.

4. Select a traffic bulletin.
 - ▷ "Previous message": scroll to the previous traffic information.
 - ▷ "Next message": scroll to the next traffic information.

Displaying detour recommendation



1. "Navigation"
2. "Map"
3.  "Traffic Info"
4. "Detour": a detour recommendation is displayed.

The following functions are available:

- ▷ "Current route": stay on current route.
- ▷ "New route in": accept detour.

Traffic information on the map

Map view settings

1. "Navigation"
2. "Map"
3.  "Map content"
 - ▷  "Traffic icons": symbols for traffic events are displayed.
 - ▷  "Traffic flow": lines for traffic flow are displayed.

Symbols in the map view

Depending on the scale of the map and the location of the traffic obstruction, the symbols for traffic events are displayed.

Information about traffic flow in the map view

Depending on the scale of the map, length and impact of a traffic obstruction are displayed on the map using colored lines.

- ▷ Black: road blocked.
- ▷ Red: congestion.
- ▷ Orange: stop-and-go traffic.
- ▷ Yellow: heavy traffic.
- ▷ Green: clear roads.
- ▷ Gray: general traffic information, e.g., construction site.

The displayed information depends on the particular traffic information service.

Dynamic destination guidance

Concept

With dynamic destination guidance, traffic information is considered when calculating routes.

Settings

1. "Navigation"
2. "Settings"
3. "Route settings"
4. "Dynamic guidance"
5. Select the desired setting.
 - ▷ "With confirmation": a message is displayed, whether the route should be guided around a traffic obstruction.
 - ▷ "Automatic": the route is automatically changed in the event of traffic obstructions.

Navigation data

Vehicle features and options

This chapter describes all standard, country-specific and optional features offered with the series. It also describes features that are not necessarily available in your vehicle, e. g., due to the selected options or country versions. This also applies to safety-related functions and systems. When using these functions and systems, the applicable country provisions must be observed.

Concept

Information regarding position determination and navigation data version can be called up.

Settings

1. "Settings"
2. "Position and software version"
3. Select the desired setting.
 - ▶ "Enter position": the vehicle position can be manually set on the map in situations without GPS reception or, e.g., immediately after transport on a ferry.
 - ▶ "Software version": information about the current map version.
 - ▶ "Help to improve the navigation map": data such as speed or position is anonymized in the vehicle and transmitted to BMW in order to improve the digital map.

Map update

General information

Navigation data is stored in the vehicle and can be updated from a USB storage device.

Current navigation data is available from a dealer's service center or another qualified service center or repair shop or in the ConnectedDrive Store.

Information

Depending on the data volume, the data update may take several hours.

Update during the trip to preserve the battery. The status of the update can be queried.

Update

1. Connect the USB storage device with the new navigation data to a USB interface in the front.
2. Follow the instructions on the Control Display.
3. Remove the USB storage device after the update.

Viewing the status

1.  Press button.
2. "Saving navigation data in the vehicle... (USB)"

Automatic map update

General information

Depending on the equipment and country version, the navigation data for the home region is transmitted online to the vehicle four times a year and automatically installed and updated.

Frequently asked questions

Vehicle features and options

This chapter describes all standard, country-specific and optional features offered with the series. It also describes features that are not necessarily available in your vehicle, e. g., due to the selected options or country versions. This also applies to safety-related functions and systems. When using these functions and systems, the applicable country provisions must be observed.

- ▶ The area has not yet been fully recorded, or you have left the recommended route and the system requires a few seconds to calculate a new route suggestion.

Frequently asked questions

Why can the current position not be displayed?

- ▶ The vehicle is located in an unrecognized region, is in a poor reception area, or the system is currently determining the position. Reception is usually best when you have an unobstructed view of the sky.

Why does destination guidance not accept a destination without the street?

- ▶ When city has been input, no downtown can be determined.
Input any street in the selected city and start destination guidance.

Why does destination guidance not accept a destination?

- ▶ The destination data is not contained in the navigation data. Select a destination that is as close as possible to the original.

Why can letters not be selected for destination input?

- ▶ The destination data is not contained in the navigation data. Select a destination that is as close as possible to the original.

Why are spoken instructions no longer be output during route guidance in front of intersections?



Entertainment







The chapter helps assure your enjoyment when receiving radio stations or playing CDs, DVDs and tracks from the music collection.

General information

Vehicle features and options

This chapter describes all standard, country-specific and optional features offered with the series. It also describes features that are not necessarily available in your vehicle, e. g., due to the selected options or country versions. This also applies to safety-related functions and systems. When using these functions and systems, the applicable country provisions must be observed.

Operation

Button	Function
	Press: switches sound output on/off. Turn: adjusts the volume.
	Change the entertainment source.
	Change station/track.
	Programmable memory buttons.
	Connected Drive. Depending on the equipment, button 8 is replaced with this button.
	Change waveband/satellite radio.
	Eject CD/DVD.

Sound output



WARNING

A high sound output volume can damage your hearing. There is a risk of injury. Do not adjust the volume too high. ◀



Turn the button to adjust the volume.

Press the button to mute the sound output. Pressing the button again restores the previous

volume setting.

Audio recording playback is stopped during muting.

Change the entertainment source

On the radio:



Press the button to switch between radio and the last-used entertainment source.

Via iDrive:

1. "Media/Radio"

A list of all available entertainment sources is displayed.

2. Select the desired setting.

- ▷ Radio, refer to page 38.
- ▷ Audio CD, refer to page 46.
- ▷ Video DVD, refer to page 55.
- ▷ Music collection, refer to page 48.
- ▷ USB audio, refer to page 51.
- ▷ USB video, refer to page 55.
- ▷ Screen Mirroring, refer to page 57.

Adjusting list of the entertainment sources

It is possible to select which entertainment sources are displayed in the selection list.

1. "Media/Radio"
A list of all available entertainment sources is displayed.
2. "Personalize menu"
3. Select the desired setting.

Tone

Vehicle features and options

This chapter describes all standard, country-specific and optional features offered with the series. It also describes features that are not necessarily available in your vehicle, e. g., due to the selected options or country versions. This also applies to safety-related functions and systems. When using these functions and systems, the applicable country provisions must be observed.

General information

The settings are stored in the currently used driver profile.

Treble, bass, balance, and fader

1. "Media/Radio"
2. "Tone" or "Bowers & Wilkins tone"
3. Select the desired setting.
 - ▷ "Treble": treble adjustment.
 - ▷ "Bass": depth adjustment.
 - ▷ "Balance": left/right volume distribution.
 - ▷ "Fader": front/rear volume distribution.
4. To adjust: turn the controller.
5. To store: press the controller.

The following settings can be directly adjusted on the Control Display by moving the circle in the vehicle graphic:

- ▷ "Balance"
- ▷ "Fader"

Multi-channel playback, surround

When surround is activated, multi-channel playback is simulated when a stereo audio track is played.

1. "Media/Radio"
2. "Tone"
3. "Surround" or "Logic 7 Surround"

LOGIC7 and the LOGIC7 logo are registered trademarks of Lexicon, Inc., a Harman International Group company.

Equalizer

Settings for individual audio frequency ranges.

1. "Media/Radio"
2. "Tone" or "Bowers & Wilkins tone"
3. "Equalizer"

The current treble and bass settings, refer to page 36, are displayed on the left and right edge of the equalizer screen. These values can also be adjusted in the equalizer. The treble and bass sound settings affect the settings for the audio frequency ranges of the equalizer.

Select and adjust trebles, basses, or a frequency range.

Via iDrive:

1. Turn the controller to select the value to be adjusted.
2. Press the controller.
3. Turn the controller to adjust the value.
4. Press the controller to store the setting.

On the screen:

Adjust desired value by sliding the column up or down using a finger.

Bowers & Wilkins Diamond Surround Sound System

One of several sound profiles can be selected.

1. "Media/Radio"
2. "Bowers & Wilkins tone"
3. "Tone profiles"
4. Select the desired setting.

Bang & Olufsen High End Surround Sound System

One of several sound profiles can be selected.

1. "Media/Radio"
2. "Tone"
3. "Bang & Olufsen"
4. Select the desired setting.

An additional speaker is present on the dashboard. When the entertainment system is switched on this moves out automatically and is illuminated according to the lighting setting.

If Entertainment is switched off or muting is activated, the speaker moves back in.

Volume equalization

An automatic increase of the volume can be set to compensate for the increasing driving noises at higher speeds.

1. "Media/Radio"
2. "Tone" or "Bowers & Wilkins tone"
3. "Volume settings"
4. Select desired setting:
 - ▶ "Speed volume": ratio of entertainment volume to speed.

With Harmann/Kardon Surround Sound System: better audibility is achieved by adjusting the sound settings.

With Bowers & Wilkins Diamond Surround Sound System or with Bang & Olufsen High End Surround System: automatic adjustment of the volume occurs depending on the audible driving noises in the vehicle's interior.

"Speed volume": omitted in this case.

- ▶ "PDC": ratio of the volume of the PDC signal tone to the entertainment volume.

The basic setting ensures that the signal tone is audible at any volume.

- ▶ "Gong": ratio of the volume of the signal tone, e.g., for safety belt reminder, to the entertainment volume.

The basic setting ensures that the signal tone is audible at any volume.

- ▶ "Telephone": sensitivity of the microphone during a phone call.

The setting is adjusted while calling and is stored for the mobile phone used.

- ▶ "Speakers": volume of the loudspeakers during a phone call.

Audio recording playback is stopped during muting.

The setting is adjusted while calling and is stored for the mobile phone used.

5. To adjust: turn the controller.

6. To store: press the controller.

Reset

The tone settings are reset to the factory settings.

1. "Media/Radio"
2. "Tone"
3. "Reset"

Radio

Vehicle features and options

This chapter describes all standard, country-specific and optional features offered with the series. It also describes features that are not necessarily available in your vehicle, e. g., due to the selected options or country versions. This also applies to safety-related functions and systems. When using these functions and systems, the applicable country provisions must be observed.

General information

The settings are stored in the currently used driver profile.

AM/FM station

Selecting a station

1. "Media/Radio"
2. "FM" or "AM"

The last station listened to will be played and the station list displayed.

3. Select the desired station.

Changing the station



Press button on the radio.

The next and/or previous station from the list of stations is played.

Storing a station

1. "Media/Radio"
2. "FM" or "AM"

A symbol on the highlighted channel indicates whether the channel has already been saved.

Symbol	Meaning
☆+	Station is not saved.
☆✓	Station is already saved.

To save the station played:

1. Move the controller to the left.
2. ☆+ "Save station"
The storage list is displayed.
3. Select the desired memory location.

Or:

1. Mark the station played.
2. Press the controller.
The storage list is displayed.
3. Select the desired memory location.

To save a station other than the one played:

1. Highlight the desired station.
2. Press the controller and hold until the storage list is displayed.
3. Select the desired memory location.

Or:

1. Highlight the desired station.
2.  Press button.
3. "Save station"
The storage list is displayed.
4. Select the desired memory location.

The stations can also be stored on the programmable memory buttons.

Selecting a station manually

Station selection via the frequency.

1. "Media/Radio"
2. "FM" or "AM"

3. Move the controller to the left.
 "Manual search"
4. To select the frequency: turn the controller.
5. To store the frequency: press the controller.

Renaming a station

When storing a station with RDS signal, the RDS information transferred during storing is accepted as the station name. This name can be changed.

1. "Media/Radio"
2. "FM"
3. Select the desired station.
4.  Press button.
5. "Rename to:"
 If necessary, wait until the desired name appears.
6. Press the controller to store this name.

Displaying additional information

If a radio station broadcasts radio text or radio text plus, this information can be displayed, e.g., the track or performer of the music. Availability, content and sequence are set by the radio station.

1. "Media/Radio"
2. "FM"
3. Select the desired station.
4.  Press button.
5. "Station info"

RDS

Concept

RDS broadcasts additional information, such as the station name, in the FM waveband.

It is recommended to switch on RDS.

Switching on/off

1. "Media/Radio"
2. "FM"
3.  Press button.
4. "RDS"

HD Radio™ reception

General information

Many stations broadcast both analog and digital signals.

License conditions

 HD Radio Technology manufactured under license from iBiquity Digital Corporation. U. S. and Foreign Patents. HD Radio™ and the HD, HD Radio, and "Arc" logos are proprietary trademarks of iBiquity Digital Corp.

Information

When setting a station with a digital signal, it may take a few seconds before the station plays in digital quality.

Information about HD Radio stations whose station name ends with ...HD or with ...HD1:



In areas in which the station is not continuously received in digital mode, the playback switches between analog and digital reception. In this case, switch off digital radio reception.

Information about HD Radio multicast stations whose station name ends with ...HD2, ...HD3, ...:

In areas in which the station is not continuously received in digital mode, there may be interruptions of the audible signal lasting several seconds. This depends on the reception.

Activating/deactivating digital radio reception

1. "Media/Radio"
2. "FM" or "AM"

3.  Press button.
 4. "HD Radio reception"
-  This symbol is displayed in the status line when the audio signal is digital.

Displaying additional information

Some stations broadcast additional information on the current track, such as the name of the artist.

1. "Media/Radio"
2. "FM" or "AM"
3. Select a station.
4.  Press button.
5. "Station info"

Satellite radio

General information

Before a channel can be played, you must subscribe to it via telephone. Several channels can be combined into specified packages.

Managing a subscription

General information

In order to enable or unsubscribe from channels, you must have reception. It is usually at its best when you have an unobstructed view of the sky. The channel name is displayed in the status line.

Enabling channels

1. "Media/Radio"
2. "Satellite radio"
3. Move the controller to the left.
4.  "Category"
5. Select the Unsubscribed category.
6. Select the desired channel.

The phone number and identification number of the radio are displayed.

7. Call the phone number to have the channel enabled.

You can unsubscribe from the channels again via this phone number.

Unsubscribing from channels

1. "Media/Radio"
2. "Satellite radio"
3.  Press button.
4. "Show subscription info"

The phone number and identification number of the radio are displayed.

5. Call the phone number to cancel your subscription to the channel.

Selecting channels

You can only listen to enabled channels.

1. "Media/Radio"
2. "Satellite radio"

The last channel played will be played back and the channel list displayed.

3. Select the desired channel from the channel list.

To display information about the selected channel:

1. Highlight a channel.
2.  Press button.
3. "Current information details"

Adjusting display of the channel list

The display of the playback list can be adjusted.

1. "Media/Radio"
2. "Satellite radio"
3. Move the controller to the left.

4.  "Change view"
5. Select the desired display:
 - ▷ "Channel"
The name of the channel will be displayed.
 - ▷ "Artist"
The name of the artist playing will be displayed.
 - ▷ "Titles"
The name of the track playing will be displayed.

Changing the channel





Press button on the radio.

The next and/or previous channel from the channel list is played.

Storing a channel

1. "Media/Radio"
2. "Satellite radio"

A symbol on the highlighted channel indicates whether the channel has already been saved.

Symbol	Meaning
	Channel is not saved.
	Channel is already saved.

To save the channel played:

1. Move the controller to the left.
 2.  "Save station"
The storage list is displayed.
 3. Select the desired memory location.
- Or:
1. Highlight the played channel.
 2. Press the controller.
The storage list is displayed.
 3. Select the desired memory location.

To save a channel other than the one played:

1. Highlight the desired channel.
2. Press the controller and hold until the storage list is displayed.
3. Select the desired memory location.

Or:

1. Highlight the desired channel.
2.  Press button.
3. "Save in presets"
The storage list is displayed.
4. Select the desired memory location.

The stations can also be stored on the programmable memory buttons.

Selecting a category

1. "Media/Radio"
2. "Satellite radio"
3. Move the controller to the left.
4.  "Category"
5. Select the desired category.

The subscribed channels from this category are displayed.

6. Select the desired channel.

Timeshift

General information

The channel you are currently listening to can be stored in a buffer for up to an hour.

Prerequisite: the signal must be available.

The stored audio track can be played with a delay following the live broadcast. When the memory is full, the older tracks are overwritten. The memory is cleared when a new channel is selected or when the vehicle is switched off.

In addition, channels that are stored on the first six programmable memory buttons are buffered. If one of these channels is selected, the current track will be played from the beginning.

Opening the timeshift function

1. "Media/Radio"
2. "Satellite radio"
3. Move the controller to the left.
4.  "Time shift"

Time shift forward/reverse

Within the stored recording, it is possible to jump to any point in time.



Press button on the radio.



You can jump to the next or the previous track.



Press button on the radio and hold or turn the controller.

The recording is spooled forward or back.

Timeshift menu



Symbol	Function
	Go to the live broadcast.
	Automatic timeshift deactivated/activated.
	Playback/pause.

Automatic timeshift

With automatic timeshift, audio playback is paused for the following events.

- ▶ Incoming and outgoing telephone calls.
- ▶ Activation of the voice activation system.
- ▶ Muting.

After that, audio playback is continued from the time of the interruption.

1. Move the controller to the left.
2. To activate:
 -  "Automatic time shift"
- To deactivate:  "Automatic time shift".

Favorites

General information



A performer, a track, a league or a team can be stored as a favorite. If the stored favorite is played on a channel, a message appears on the Control Display. Up to 30 Favorites can be stored.

Storing the artist or track

It is only possible to store Favorites that are currently being broadcast. The channel information must be available.

1. "Media/Radio"
2. "Satellite radio"
3. Move the controller to the left.
4.  "Add to favorites"
5. Highlight the performer or track, and press the controller.

A symbol indicates whether the artist and track were already saved.

Symbol	Meaning
	Artist/track is not saved.
	Artist/track was already saved.

Storing the league or team

1. "Media/Radio"
2. "Satellite radio"
3.  Press button.
The Favorites list is displayed.
4. "Manage favorites"
5. "Add sports information"
6. Select the type of sport desired.
7. Select the desired team.

Activating/deactivating a notification

A notification can be displayed when a selected favorite is being played.

1. "Media/Radio"
2. "Satellite radio"
3.  Press button.
4. "Manage favorites"
The stored Favorites are displayed.
5. "Activate alert"
Set a check mark to activate notification for the selected Favorites.
Remove the check mark to deactivate notification for the selected Favorites.
6. Select the desired Favorites.

Opening the Favorites

If an activated favorite is played back, the following message is displayed for approx. 20 seconds: "Favorite on air!".

To change to the played Favorites:

Tap on the message on the Control Display.

Or:



1. Move the controller to the left.
2.  "Favorite alert"
Select the symbol while the message is shown.

The displayed favorite is played.

When the message disappears, the list of channels that is currently playing one of the stored Favorites can be displayed.

1. Move the controller to the left.
2.  "Category"
3. Select the Favorites list.
The channels that are currently playing a favorite are displayed.
4. Select the channel that you would like to change to.

Deleting Favorites

1. "Media/Radio"
2. "Satellite radio"
3.  Press button.
4. "Manage favorites"
The stored Favorites are displayed.
5. Highlight the desired favorite.
6.  Press button.
7. "Delete entry"

Traffic Jump

General information

Traffic and weather information for a selected region is broadcast every few minutes.

Selecting a region

1. "Media/Radio"
2. "Satellite radio"
3.  Press button.
4. "Configure jump"
5. Select the desired region.

Activating/deactivating Traffic Jump

You must have reception in order to activate or deactivate.

1. "Media/Radio"
2. "Satellite radio"
3.  Press button.
4. "Configure jump"
5. "Jump to:"

Place a check mark to activate Traffic Jump.

Information for the selected region is broadcast as soon as it is available.

Remove the check mark to deactivate Traffic Jump.

Channel magazine

In the channel magazine, the current and subsequent program for each channel booked is displayed.

1. "Media/Radio"
2. "Satellite radio"
3. Move the controller to the left.
4.  "SiriusXM program guide"

Automatic update

About twice a year, Sirius performs an update of the channel names and positions. The update takes place automatically and may take several minutes.

Information

- ▷ Reception may not be available in some situations, such as under certain environmental or topographical conditions. The satellite radio has no influence on this.
- ▷ Graphical contents can be received under certain circumstances.
- ▷ The signal may not be available in tunnels or underground garages next to tall buildings or near trees, mountains or other powerful sources of radio interference.

Stored stations

General information

Up to 40 stations can be stored.

Calling up a station

1. "Media/Radio"
2. "Presets"
3. Select the desired station.

Deleting a station

1. "Media/Radio"
2. "Presets"

3. Highlight the station you want to delete.

4.  Press button.
5. "Delete entry"

Audio

Vehicle features and options







This chapter describes all standard, country-specific and optional features offered with the series. It also describes features that are not necessarily available in your vehicle, e. g., due to the selected options or country versions. This also applies to safety-related functions and systems. When using these functions and systems, the applicable country provisions must be observed.

General information

Music tracks, audio books, and podcasts can be played back. Sound is played back through the vehicle loudspeakers.

Settings are stored for the driver profile currently used.

Depending on the vehicle equipment, the following audio sources can be used:

Symbol	Meaning
	AUX-IN port.
	Audio CDs.
	Music collection.
	USB storage device.
	Music interface for smartphones.
	Bluetooth device.
	Online Entertainment.

AUX-IN

Concept

- ▶ For connecting audio devices, e.g., MP3 players. Sound is played back through the vehicle loudspeakers.
- ▶ Recommendation: use medium tone and volume settings on the audio device. The sound depends on the quality of the audio files.

Connecting



Connect the headphones or line-out connector of the device to the AUX-IN port.

Ensure that the plug is inserted in the AUX-IN port as far as it will

go.

Playback

1. Connect the audio device, switch it on and select a track on the audio device.
2. "Media/Radio"
3. "AUX"

Volume

The volume of the sound output depends on the audio device. If this volume differs markedly from the volume of the other audio sources, we recommend adjusting the volume.

1. "Media/Radio"
2. "AUX (front)"
3. Move the controller to the left.
4.  "Volume"
5. Turn the controller until the desired volume is set and press the controller.

Audio CD

Information

CD/DVD player and changer



WARNING

CD/DVD players and changers are officially designated Class 1 laser products. Lasers can damage the retina of the eye. There is a risk of injury. Do not use the CD/DVD player or changer, if the cover is damaged. ◀

CDs and DVDs



ATTENTION

With use of non-compatible CD sizes, the CD can get jammed and it may not be possible to pull it out again. Labels applied after the fact can loosen during playback. There is a risk of damage to property.

- ▶ Do not use any CDs with labels applied after the fact.
- ▶ Only use round CDs with a standard diameter of 4.7 in/12 cm and do not play back any CDs with adapters, e.g., single CDs.
- ▶ Do not use any combined CD/DVDs, e.g., DVD Plus. ◀

General malfunctions

- ▶ CD/DVD changers and players have been optimized for performance in vehicles. In some instances they may be more sensitive to faulty CDs/DVDs than stationary devices would be.
- ▶ If a CD/DVD cannot be played, first check whether it has been inserted correctly.

Humidity

High levels of humidity can lead to condensation on the CD/DVD or the laser's scan lens, and temporarily prevent playback.

Malfunctions involving individual CDs/DVDs

If malfunctions occur only with particular CDs/DVDs, this can be due to one of the following causes:

Home-recorded CDs/DVDs

- ▶ Possible reasons for malfunctions with home-recorded CDs/DVDs are inconsistent data creation or recording processes, or poor quality or old age of the blank CD/DVD.
- ▶ Only label CDs/DVDs on the upper side with a pen intended for this purpose.

Damage

- ▶ Avoid fingerprints, dust, scratches and moisture.
- ▶ Store CDs/DVDs in a sleeve.
- ▶ Do not subject CDs/DVDs to temperatures over 122 °F/50 °C, high humidity or direct sunlight.

CDs/DVDs with copy protection

CDs/DVDs are often provided with a copy protection feature by the manufacturer. This can mean that some CDs/DVDs cannot be played or can only be played to a limited extent.

MACROVISION

This product contains copyrighted technology that is based on multiple registered US patents and the intellectual property of the Macrovision Corporation and other manufacturers. The use of this copy protection must be approved by Macrovision. Media protected by this product unless otherwise agreed with Macrovision may only be used for private purposes. Copying of this technology is prohibited.

DTS Digital Surround™



Manufactured under license under U.S. Patent Numbers: 5,451,942; 5,956,674; 5,974,380; 5,978,762; 6,487,535 & and other

patents granted and registered in the USA and worldwide. DTS and the logo are registered trademarks & DTS Digital Surround and the DTS logos are trademarks of DTS Inc. © DTS, Inc. All rights reserved.

Playable formats

CD-R, CD-RW, CD-DA.

Inserting CD

Insert the CD into the CD slot with the printed side up.

Playback begins automatically.

Removing the CD

1.  Press button.
The CD is partially ejected.
2. Remove the CD.

Selecting Audio CD

1. "Media/Radio"
2. "CD"

Further playback descriptions, refer to page 52.

Album information

General information

A database with album information is saved in the vehicle. Depending on the information entered in this database for the played back audio CD, album name, artist, track names, and the album cover are displayed.

To update the database, contact a dealer's service center or another qualified service center or repair shop.

Gracenote® technology

 Music recognition technology and related data is provided by Gracenote®. Gracenote is the industry standard in music recognition technology and related content delivery.

For more information, please visit www.gracenote.com.

CD and music-related data from Gracenote, Inc., copyright © 2000 to present Gracenote. Gracenote software, copyright 2000 to present Gracenote. This product and service may practice one or more of the following U.S. Patents: #5,987,525; #6,061,680; #6,154,773, #6,161,132, #6,230,192, #6,230,207, #6,240,459, #6,330,593, and other patents issued or pending. Some services supplied under license from Open Globe, Inc. for U.S. Patent: #6,304,523.

Display album information

1. "Media/Radio"
2. "CD"
3.  Press button.
4. "Album information"

The information stored about the album is displayed. If it is not possible to recognize an audio CD clearly, all appropriate entries are displayed.

5. If necessary, select a matching entry.

Hide album information

If information is displayed that does not match the played back album, the information can be hidden. In this case, a database update can help.

1. "Media/Radio"
2. "CD"
3.  Press button.
4. "Album information"
5. "Reset album information"

The album information is not displayed anymore.

Music collection

General information

Music tracks from audio CDs and USB media can be stored in the music collection in the vehicle and played from there.

- ▶ Audio CD: the titles are converted into a compressed audio format and stored in a directory that contains the name of the album. If there is no information about the album, refer to page 47, stored, the directory and all titles receive an automated name.
- ▶ USB storage device with compressed audio files: all playable audio files from the USB storage device are stored in a directory that receives the name of the USB storage device. Tracks and directories can be subsequently renamed and deleted. Managing the music collection, refer to page 49.

Tracks with DRM copy protection can be stored but cannot be played back.

Regularly back up your music collection, refer to page 50, otherwise the stored music might be lost if there is a fault on the hard disc.

Storing from audio CD

1. Insert the audio CD, refer to page 46, into the CD player.
2. "Media/Radio"
3. "CD"
4. Move the controller to the left.
5.  "Save CD"

The audio CD is stored in the music collection.

Observe the following during the storage process:

- ▶ Do not remove the audio CD during storing.
- ▶ The music collection is switched to. Tracks that have already been transferred can be played back immediately.

- ▶ Tracks from the audio CD cannot be played back.
- ▶ Switching to other audio sources is also possible.

Canceling storing from CD

1. "Media/Radio"
2. "CD"
3. Move the controller to the left.
4.  "Cancel saving"

The storage process is interrupted and can be continued at any time.

Resuming storing from CD

1. "Media/Radio"
2. "CD"
3. Move the controller to the left.
4.  "Continue saving"

Storing from a USB storage device

1. Connect the USB storage device, refer to page 51, to the USB interface.
2. "Media/Radio"
3. "USB"

Or:

Select the name of the USB storage device.

4. Move the controller to the left.
5.  "Import music"

The audio data is stored in the music collection.

Observe the following during the storage process:

- ▶ Do not remove the USB storage device during storing.
- ▶ The tracks on the USB storage device can still be played back.
- ▶ Switching to other audio sources is also possible.

Canceling storing from a USB storage device

1. "Media/Radio"
2. "USB"
Or:
Select the name of the USB storage device.
3. Move the controller to the left.
4.  "Cancel saving"
The storing process is canceled.

Continuing storing from a USB storage device

1. "Media/Radio"
2. "USB"
Or:
Select the name of the USB storage device.
3. Move the controller to the left.
4.  "Import music"

Selecting the music collection

1. "Media/Radio"
 2. "Music collection"
- Further playback descriptions, refer to page 52.

Managing the music collection

Renaming folders or tracks

Changing a folder name to the name of an album does not change the album designation in the track information of the individual tracks.

Changing a track name changes its file name, however it does not change the track name saved in the track information.



1. "Media/Radio"
2. "Music collection"
3. Move the controller to the left.
4.  "Media search"

5. "Browse folder"
Folders and tracks of the top directory level are displayed.
6. Highlight the desired folder or track, search in subdirectories as needed.
7.  Press button.
8. "Rename folder" or "Rename title"
The current name will be displayed.
9. Change the names as you wish.
10. **OK** Select the symbol.

Deleting folders or tracks

A folder cannot be deleted while a track from that folder is being played.

A track cannot be deleted while it is being played.

1. "Media/Radio"
2. "Music collection"
3. Move the controller to the left.
4.  "Media search"
5. "Browse folder"
Folders and tracks of the top directory level are displayed.
6. Highlight the desired folder or track, search in subdirectories as needed.
7.  Press button.
8. "Delete folder" or "Delete title"

Album information

The description for the album information, refer to page 47, for audio CDs also applies to the audio CDs stored in the music collection.

- ▶  Symbol for stored audio CDs.
- ▶ The information is updated separately for each album.

- ▶ Album information can also be updated if the album was imported from another vehicle.

1. "Media/Radio"
2. "Music collection"
3. Move the controller to the left.
4.  "Media search"
5. "Browse folder"

Folders and tracks of the top directory level are displayed.

6. Highlight the desired folder, search in sub-directories as needed.

7.  Press button.

8. ▶ Display album information, refer to page 47.
- ▶ Hide album information, refer to page 47.

Free disk space

Display free disk space in the music collection.

1. "Media/Radio"
2. "Music collection"
3.  Press button.
4. "Manage music collection"
5. "Available memory"

Deleting a selected track

Selected tracks can be deleted.

1. "Media/Radio"
2. "Music collection"
3.  Press button.
4. "Manage music collection"
5. "Delete selected titles"

Music search is displayed. Proceed according to the track search, refer to page 52, description.

A list of tracks to be deleted is prepared according to the search criteria.

6. Select track.

Deleting the music collection

1. "Media/Radio"
2. "Music collection"
3.  Press button.
4. "Manage music collection"
5. "Delete music collection"
6. "OK"

Backing up the music collection

Regularly back up your music collection, otherwise the stored music might be lost if there is a fault on the hard disc.

When making a backup, make sure there is enough free disk space on the USB storage device.

Depending on the number of tracks, backing up the music collection can take an extended period of time. Therefore, it is best to perform the backup during a long trip. If the backup cannot be finished, do not remove the USB storage device, the backup will be resumed on the next trip.

1. Connect the USB storage device, refer to page 51, to the USB interface.
2. "Media/Radio"
3. "Music collection"
4.  Press button.
5. "Manage music collection"
6. "Save music collection to USB"

Restoring the music collection

When restoring from the USB storage device, the existing music collection in the vehicle is overwritten. It is best to perform the storage operation during a relatively long trip. If storing cannot be finished, do not remove the USB

storage device, the operation will be resumed on the next trip.

1. Connect the USB storage device, refer to page 51, to the USB interface.
2. "Media/Radio"
3. "Music collection"
4.  Press button.
5. "Manage music collection"
6. "Restore music collection from USB device"

USB media

Playable formats

MP3, MP4, M4A, M4B, AAC, WMA.

Apple iPod/iPhone

The music search and playback of Apple iPod/iPhone is supported.

Audio player and storage media with USB port

Information on all music tracks, e.g., artist, genre or track, as well as playback lists, are transmitted into the vehicle. This may take some time, depending on the USB storage device and the number of tracks.

During the transfer, the tracks can be called up via the file directory.

Information from up to four USB media or for approx. 40,000 tracks can be stored in the vehicle. If a fifth device is connected or if more than 40,000 tracks are stored, information on existing tracks will be deleted.

Music tracks with integrated Digital Rights Management, DRM, cannot be played.

Selecting the USB storage device

Connect the device to the USB interface, preferably using the adapter cable enclosed with the USB storage device.

For information about the USB interface, see Owner's Manual for the vehicle.

1. "Media/Radio"
 2. "USB"
- or
- Select the name of the USB storage device.

Further playback descriptions, refer to page 52.

Bluetooth audio

General information

- ▷ Playback of music files on external devices such as audio devices or mobile phones via Bluetooth.
- ▷ Sound is played back through the vehicle loudspeakers.
- ▷ The volume of the sound output depends on the device. If necessary, adjust the volume on the device.
- ▷ Up to four external devices can be paired with the vehicle.

Requirements

- ▷ Bluetooth device is connected to the vehicle. Bluetooth connections, see Owner's Manual for the vehicle.
- ▷ Bluetooth audio playback was activated.

Selecting the Bluetooth device

1. "Media/Radio"
2. Select the desired Bluetooth device from the list.

Further playback descriptions, refer to page 52.

If the Bluetooth device is not listed in the device list, audio playback may have not been ac-

tivated. To activate audio playback, proceed as follows:

1. "Media/Radio"
2. "Manage mobile devices"
3. Select the desired Bluetooth device.
4. "Bluetooth® audio"

Online Entertainment

Concept

Online music services can be accessed via the Internet. A valid membership is required for using the selected music service.

The music provided there can be played and stored in the vehicle. Stored tracks can also be played when there is no Internet connection.

The owner's manual for Online Entertainment is available on the Internet under www.bmw.com, ConnectedDrive Services.

Selecting Online Entertainment

1. "Media/Radio"
2. "Online Entertainment"

Playback

General information

After an audio source is selected, the playback screen will be displayed.

Information available for the current track followed by the playback list is shown on this screen. Content and scope of the playback list depend on the type of the selected playback source and the search criteria applied.

- ▶ All tracks of the CD are displayed for an audio CD.
- ▶ For USB and Bluetooth devices, as well as for the music collection, the selected playback list is displayed. This can be the result

of a search or of a previously stored playback list.

Further functions are displayed by moving the controller to the left. The scope of these functions depends on the selected audio source.

Depending on the supported Bluetooth version, some Bluetooth device functions may not be available when using iDrive. If necessary, the missing functions can be accessed directly on the device itself.

Selecting a track

1. Turn the controller to highlight a track from the playback list.
2. Press the controller.

Starting with the selected track, all tracks of the playback list are played.

Changing the track



Press button on the radio.

The next or previous track from the playback list is played.

Fast forward/reverse



Press and hold this button.

Track search

General information

The possible search criteria depend on the selected audio source.

Searching for track information

The following search criteria refer to the data saved in the track information.

1. Move the controller to the left.
2. 🔍 "Media search"
3. Select desired setting:
 - ▶ "Search"

All the tracks containing the search string are displayed. Entering more characters will continue to narrow down the search results.

The result list can be accessed by moving the controller to the right.

▷ "Genres"

A list of all available genres is displayed.

Select a genre to display all respective artists.

▷ "Artists"

A list of all available artists is displayed.

Select an artist to display all respective albums and tracks.

▷ "Albums"

A list of all available albums is displayed.

Select an album to display all respective tracks.

▷ "Titles"

A list of all available tracks is displayed.

4. Select album, if needed.

5. Select the track at which playback should begin

The playback screen is switched to. A playback list is created from the search results.

The search for artists and titles can also be selected directly.

1. Move the controller to the left.

2.  "Artists" or  "Titles"

Tracks where the selected search criterion is not saved are summarized under "unknown".

Searching for playback lists

1. Move the controller to the left.

2.  "Media search"

3. "Playlists"

A list of all available playback lists is displayed.

4. Select the playback list.

5. Select the track at which playback should begin.

The playback screen is switched to. A playback list is created from the search results.

Searching for further media

1. Move the controller to the left.

2.  "Media search"

3. Select desired setting:

▷ "Podcasts"

A list of all available podcasts is displayed.

▷ "Audio books"

A list of all available audio books is displayed.

4. Select the track at which playback should begin.

The playback screen is switched to. A playback list is created from the search results.

Searching in the directory structure

The directory structure of the data carrier is mapped for this search. This search is only available in music collections and for USB media.

The names of folders and tracks correspond to folder and file names. These can deviate from the names in the track information.

1. Move the controller to the left.

2.  "Media search"

3. "Browse folder"

4. Change into a sub folder, if needed.

Select the track at which playback should begin.

The playback screen is switched to. A playback list is created from the search results.

Scrolling through albums



1. Move the controller to the left.
2.  "Browse albums"
Available albums are graphically presented.
3. Turn the controller to scroll through the albums.
4. Select the desired album.
All tracks of the selected album are displayed.
5. Select the track at which playback should begin.
6. Move the controller to the left to return to the playback screen. The playback list corresponds to the track list of the album.

Searching for similar tracks

1. Move the controller to the left.
2.  "Similar titles (local)"
A list with similar tracks is displayed.
3. Select the track at which playback should begin.
The playback screen is switched to. A playback list is created from the search results.

Random playback



Random playback is possible for the current playback list and for all tracks of the selected audio source.

1. Move the controller to the left.
2. Select desired setting:
 - ▶  "Shuffle"
The playback list is played in random order.
 - ▶  "Media search"
"Shuffle (music)"

All tracks of the selected audio source are played back in random order.

Creating the Favorites list

The current track can be assigned to a special playback list, the Favorites list. If the current track already belongs to the Favorites list, it can be deleted from this list. The Favorites list is displayed first when searching for playback lists, refer to page 53.

1. Move the controller to the left.
2.  "Add to favorites" or  "Delete from favorites"

Video

Vehicle features and options

This chapter describes all standard, country-specific and optional features offered with the series. It also describes features that are not necessarily available in your vehicle, e. g., due to the selected options or country versions. This also applies to safety-related functions and systems. When using these functions and systems, the applicable country provisions must be observed.



General information

Video files and video DVDs can be played. Sound is played back through the vehicle loudspeakers.

Settings are stored for the driver profile currently used.

The video image on the front Control Display is switched off when a country-dependent speed is exceeded.

Depending on the vehicle equipment, the following video sources are possible.

Symbol	Meaning
	Video DVD.
	USB storage device.
	Screen Mirroring.

USB media

Information

Depending on the USB storage device, video playback may not be possible via the USB port.

Playable formats

MP4, M4V, AVI, WMV, XVID, H.264.

Selecting the USB storage device

Connect the device to the USB interface, preferably using the adapter cable enclosed with the USB storage device.

For information about the USB interface, see Owner's Manual for the vehicle.

1. "Media/Radio"
2. "USB"

Or:

Select the name of the USB storage device.

Searching for videos

1. Move the controller to the left.
2.  "Media search"
3. "Videos"
A list of all available videos is displayed.
4. Select the track at which playback should begin.
The playback screen is switched to. The playback list corresponds to the list of films resulting from the search.

Video DVD

Country codes

Only DVDs with the country code selected during vehicle ordering can be played. Refer to the information on the CD as well.

Code	Region
1	USA, Canada.
2	Japan, Europe, Middle East, South Africa.
3	Southeast Asia.

Code	Region
4	Australia, Central and South America, New Zealand.
5	Northwest Asia, North Africa.
6	China.
0	All regions.

Inserting the DVD

Insert the DVD into the DVD slot with the printed side up.

Playback begins automatically.

Removing the DVD

-  Press button.
The DVD is partially ejected.
- Remove DVD.



Selecting the video DVD











- "Media/Radio"
- "CD/DVD"
- Playback begins automatically.

Video menu

To open the video menu:

 Press button during playback.

Symbol	Function
	Open the DVD menu. Many DVDs have their own menus. The display depends on the contents of the DVD.
	Press button to leave the DVD menu.
	Start playback.

Symbol	Function
	Pause. Playback is paused.
	Previous chapter.
	Fast reverse. The speed is increased with each press of the controller. To stop, start playback.
	Next chapter.
	Fast forward. The speed is increased with each press of the controller. To stop, start playback.
	Stop. Playback is ended.
	Set the language. The languages that are available depend on the DVD.
	Set subtitles. The subtitles that are available depend on the DVD.
	Back. Jump back to the previous menu. This function is not supported by all media.
	Additional functions.



The video menu fades out automatically after a short period of time.

Settings for DVD



For some DVDs, settings can only be made via the DVD menu, refer also to the information on the DVD.

Selecting the camera angle

The availability of a different camera angle depends on the DVD and the current DVD track.



1.  Press button during playback.
2.  "More functions"
3. "Viewing angle"
4. Select the desired setting.

Setting the brightness, contrast and color



1.  Press button during playback.
2.  "More functions"
3. Select the desired setting.
4. Turn the controller until the desired setting is reached, then press the controller.

Setting the zoom



Display a larger view of the TV image.

1.  Press button during playback.
2.  "More functions"
3. "Zoom mode".
4. Place a check mark in order to enlarge the video image.
Remove the check mark in order to display the video image in its actual size.

Selecting a track

1.  Press button during playback.
2.  "More functions"
3. "Select title"
4. Select the desired track.

Selecting the chapter

1.  Press button during playback.
2.  "More functions"

3. "Select chapter"

4. Select the desired chapter.

Screen Mirroring

With a WiFi connection, the screen of a smartphone is displayed on the vehicle's screen. The sound playback is via the vehicle's loudspeakers.

This function must be supported by the smartphone.

Operation is via the smartphone.

Pair smartphone with the vehicle, see Owner's Manual for the vehicle.

Rear audio remote control



Vehicle features and options

This chapter describes all standard, country-specific and optional features offered with the series. It also describes features that are not necessarily available in your vehicle, e. g., due to the selected options or country versions. This also applies to safety-related functions and systems. When using these functions and systems, the applicable country provisions must be observed.

Concept

Operation is analog to the respective buttons on the radio.

Menu navigation

Button	Function
	Turn the wheel: adjusts the volume. Press the center button: switches the sound on/off.
	Change the entertainment source.
	Changes the station, track or chapter. Press and hold this button: fast forward/reverse.

The transmission time of the remote control is limited by law. To execute a function again, press or turn the respective button again.

Replacing the batteries



ATTENTION

There is a risk of material damage if rechargeable batteries are used in the remote control due to their contents. There is a risk of damage to property. Do not use rechargeable batteries. ◀

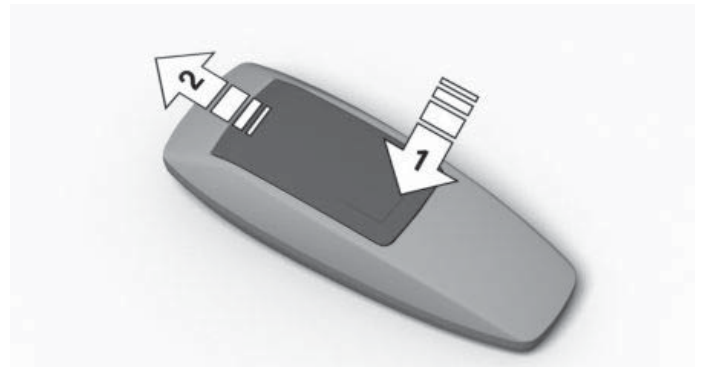

1. Remove the cover. Press on the cover, arrow 1, and push forward, arrow 2.
2. Insert batteries of the same type.
3. Close the cover.



Have old batteries disposed of by a dealer's service center or another qualified service center or repair shop or take them to a collection point.

Rear entertainment

Vehicle features and options

This chapter describes all standard, country-specific and optional features offered with the series. It also describes features that are not necessarily available in your vehicle, e. g., due to the selected options or country versions. This also applies to safety-related functions and systems. When using these functions and systems, the applicable country provisions must be observed.

Concept

Rear entertainment allows passengers in the rear to access entertainment sources regardless of the driver's selection. Two screens, different media connections, and a Blu-ray drive are available in the rear for this purpose. The sound can be output via headphones or the vehicle's loudspeakers.

Different entertainment sources can be selected on the screens.

Rear entertainment also provides access to many iDrive functions.

Some entertainment sources can be operated at the same time in the front and rear seat. For these situations, respective settings can be adjusted when enabling the rear seat, refer to page 64.

Entertainment sources selectable from the front and rear seat:

- ▷ Radio stations.
One radio station can be played in the vehicle only.
- ▷ Music collection.
Different titles can be played from the music selection.

Entertainment sources selectable from the front seat only:

- ▷ USB input, front.
- ▷ CD/DVD drive, front.
DVD during vehicle standstill only.

Entertainment sources selectable from the rear seat only:

- ▷ AV-IN input, rear.
- ▷ USB input, rear.
- ▷ HDMI input, rear.
- ▷ CD/DVD/Blu-ray drive rear.

Rear CD/DVD/Blu-ray player

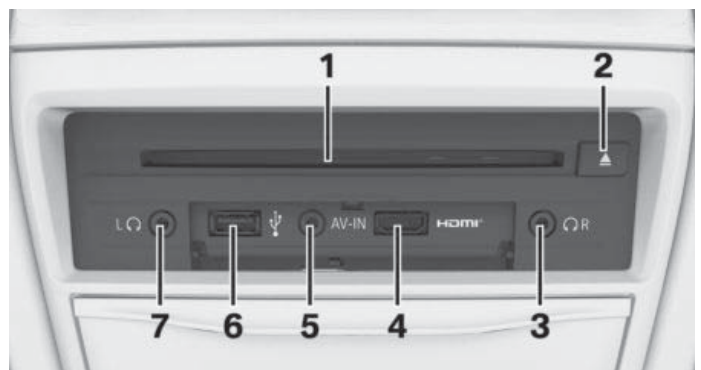

- 1 CD/DVD/Blu-ray slot
- 2 Eject CD/DVD/Blu-ray
- 3 Headphone connection, right
- 4 HDMI/MHL connection
- 5 AUX-IN port
- 6 USB port
- 7 Headphone connection, left

Screens

Settings



WARNING

The back of the screen can become very hot during operation. There is a risk of injury. Do not touch the back of the screen. ◀

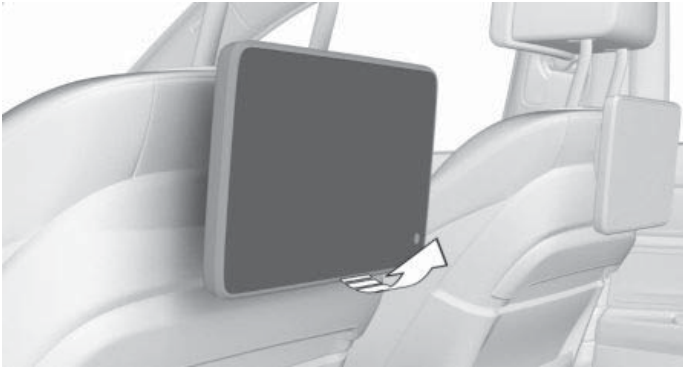

Pull on the bottom edge or press the lower edge in order to adjust the tilt.

Information

- ▶ When loading the rear seats and adjusting the backrest of the front seat, fold in the screens.
- ▶ When using the through-loading system, fold in the screens.
- ▶ When cleaning the screens, follow the care instructions, see Owner's Manual for the vehicle.

Switching the system on/off







 Press button on the bottom edge of the screen.

Rear entertainment and the respective screen are switched on/off.

If rear entertainment was switched off during enabling the rear seat, refer to page 64, the system cannot be switched on from the rear seat.

Remote control

Operation

Button	Function
	<p>Operating concept is the same as for the front controller.</p> <p>Turn the wheel: highlight a menu item.</p> <p>Press the center knob: confirm the selection.</p> <p>Pressing arrow keys corresponds to moving the controller: switching between panels, operating the DVD/Blu-ray menu.</p>
	Opens the main menu.
	Displays the previous menu.
	Open the options.
	<p>Changes the station, track or chapter.</p> <p>Press and hold this button: fast forward/reverse.</p>
	Adjusts the volume.
	Switch over between the display screens.

The transmission time of the remote control is limited by law. To execute a function again, press or turn the respective button again.

Connecting the remote control

Two wireless remote controls can be connected.

1. "My Vehicle"
2. "iDrive settings"

3. "Headphones/Remote control"



A list of linked devices is displayed.

4. Press the  button and confirmation button on the remote control for 5 seconds.

2 LEDs on the remote control flash for 10 seconds. Perform the next step while the LEDs are flashing.

5. "Connect new device"

The remote control will appear in the list of connected devices.

Symbol	Meaning
	Remote control.
	Battery charge status.

Renaming the remote control

The displayed name of the remote control can be changed.

1. "My Vehicle"
2. "iDrive settings"
3. "Headphones/Remote control"
A list of linked devices is displayed.
4. Select the remote control you would like to rename.
5. "Rename"
6. Enter the desired name.

Deleting the remote control

The connection with the vehicle can be deleted.

1. "My Vehicle"
2. "iDrive settings"
3. "Headphones/Remote control"
A list of linked devices is displayed.
4. Select the remote control you would like to delete.
5. "Remove device"

Selecting a side

A remote control can be connected to the left or right side of the rear entertainment system. The side can be changed at any time.

 Push the switch to the left or right.

The corresponding side is operated.

Replacing the batteries



ATTENTION

There is a risk of material damage if rechargeable batteries are used in the remote control due to their contents. There is a risk of damage to property. Do not use rechargeable batteries. ◀

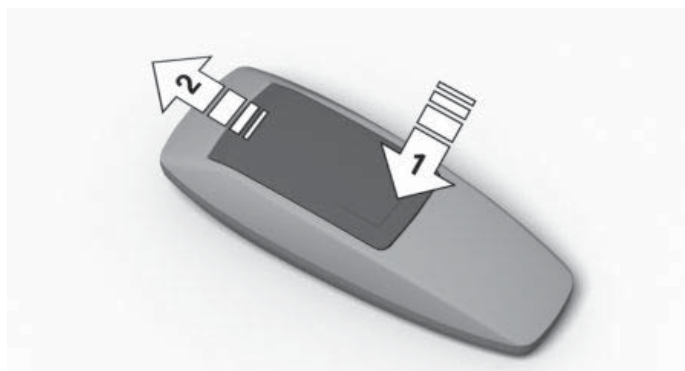

1. Remove the cover. Press on the cover, arrow 1, and push forward, arrow 2.
2. Insert batteries of the same type.
3. Close the cover.



Have old batteries disposed of by a dealer's service center or another qualified service center or repair shop or take them to a collection point.

BMW Touch Command

Concept

As an alternative to the remote control, the operation of the rear entertainment can also be done with BMW Touch Command.

To do this, you can either call up the Entertainment menu or use a remote control.

Operation via menu

1. "Media/Radio"
2. Tap the left or right screen.
3.  Tap on symbol.
The available entertainment sources are displayed.
4. Select the desired entertainment source.

Further operation is as described in the Entertainment chapter.

Operation via remote control



Touch graphic with a finger and swipe downward.

The remote control is opened.

Touch graphic with a finger and swipe upward.

The remote control is closed.

BMW Touch Command in comparison to the remote control:

Remote control	BMW Touch Command
----------------	-------------------



Use a finger to swipe upward and downward.

Turn the wheel.



Swipe with a finger left and right.

Tap arrow symbol on the left or right side.

Press the arrow keys on the left and right.

Remote control	BMW Touch Command
----------------	-------------------



Tap the screen with a finger.

Press button in the middle.



MENU Tap on symbol.



BACK Tap on symbol.



OPTION Tap on symbol.



 Tap on symbol.

Additional setting possibilities are displayed.



 Tap on symbol.

Additional setting possibilities are displayed.



Tap L for the left screen or R for the right screen.

 If the symbol was tapped, the following settings are possible:



Drag switch under the headphones in order to play back entertainment source via the headphones.



Drag switch under the loudspeakers in order to play back entertainment source via the loudspeakers.

Symbol	Function
--------	----------

- Reduce the volume.

+ Increase the volume.

 Switch sound off/on.

Symbol	Function
	Change to the previous station, track or chapter. Press and hold button: fast reverse.
	Change to the next station, track or chapter. Press and hold button: fast forward.
	Close settings.

Headphones and vehicle loudspeakers

Concept

To select an entertainment source in the rear independently from the selection in the front, sound must be output via headphones.

If sound output via loudspeakers is set on the screens, the audio source can be selected from the front as well as the rear seat. For these situations, a corresponding setting can be selected in the rear enable, refer to page 64.

Switching

-  Press button.
- Select the desired sound output:
"Speakers" or "Headphones"

Behavior when switching from vehicle loudspeakers to headphones

If the sound output is switched to the headphones on only one screen, the sound output via the vehicle loudspeakers does not change. If the sound output is switched to headphones on both screens in the rear, the following must be noted:

- ▶ If the entertainment source of the vehicle loudspeakers can be operated via the con-

troller in the front, the sound output of the vehicle loudspeakers does not change.

- ▶ If the entertainment source of the vehicle loudspeakers cannot be operated via the controller in the front, sound output via the vehicle loudspeakers is stopped.

A different entertainment source must be selected.

Actions on switching from headphones to vehicle loudspeakers

The entertainment source heard via the headphones will be played back via the vehicle loudspeakers.

Headphones

Corded headphones

Connect via the 1/8"/3.5 mm, refer to page 59, jack plug on the rear Blu-ray player.

Cordless headphones



Connecting headphones

Suitable cordless headphones are available from a dealer's service center or another qualified service center or repair shop.

Three cordless headphones can be connected.

- Switch on the headphones.
- "My Vehicle"
- "iDrive settings"
- "Headphones/Remote control"
A list of linked devices is displayed.
- "Connect new device"
- Press and hold the activation switch on the headphones until the following text is displayed:
"Connecting..."
- Select the side you would like to connect the headphones to.

The headphones will appear in the list of connected devices.

Symbol	Meaning
	Headphones. Connection with the left side.
	Headphones. Connection with the right side.
	Battery charge status.

Renaming headphones

The displayed name of the headphones can be changed.

1. "My Vehicle"
2. "iDrive settings"
3. "Headphones/Remote control"
A list of linked devices is displayed.
4. Select the headphones you would like to rename.
5. "Rename"
6. Enter the desired name.

Deleting the headphones connection

The connection with the vehicle can be deleted.

1. "My Vehicle"
2. "iDrive settings"
3. "Headphones/Remote control"
A list of linked devices is displayed.
4. Select the headphones you would like to delete.
5. "Remove device"

Selecting a side

A pair of headphones can be connected to the left or right side of the rear entertainment system. The side is selected on the headphones, see the headphones owner's manual.

Enabling the rear seat

Settings

This setting is only possible via iDrive.

1. "My Vehicle"
2. "Vehicle settings"
3. "Rear-seat entertainment"
4. Select the desired setting.
 - ▷ "Limited (only Media/Radio)"

If the same entertainment source is selected in the front and in the rear, no settings can be adjusted in the rear for this source. If, e.g., radio is listened to in the front and in the rear, the station can only be changed in the front.

The entertainment source selected in the front is output via the vehicle loudspeakers.

The entertainment source selected in the rear can only be played back via headphones.

Only the following functions can be accessed in the rear in this setting:
"Media/Radio"

- ▷ "Enable rear-seat operation"
If the same entertainment source is selected in the front and in the rear, settings can be adjusted in the front and in the rear for this source.

Switching off rear entertainment

1. "My Vehicle"
2. "Vehicle settings"
3. "Rear-seat entertainment"
4. "Disable rear-seat operation"

The rear entertainment is switched off and cannot be switched on again in the rear.

Select one of the two priorities to enable rear entertainment again.

Volume limit for headphones

A volume limit can be activated in the front for the headphones in the rear.

1. "My Vehicle"
2. "Vehicle settings"
3. "Rear-seat entertainment"
4. "Volume limit"

Selecting the entertainment source for the rear

An entertainment source can be selected for the screens in the rear via iDrive in the front. The selection can be changed via the operating points in the rear.

1. "Media/Radio"
2. "Rear"
3. Select the desired screen or both screens.
4. Select the desired entertainment source.

Only entertainment sources that can be operated in the rear, can be selected.

Settings

Brightness

1. "My Vehicle"
2. "iDrive settings"
3. "Control display"
4. Adjust the brightness of the screen.

Language

1. "My Vehicle"
2. "iDrive settings"
3. "Language"
4. Select a language for all screens.

Headphones/remote control

Connect cordless headphones, refer to page 63.

Connect remote control, refer to page 60.

Tone

If the vehicle loudspeakers are selected for sound output, the settings are adjusted as in the front.

If headphones are selected for sound output, only treble, base, and surround can be adjusted. The settings are made separately for the left and right headphones.

1. "My Vehicle"
2. "iDrive settings"
3. "Tone"

Operation

Almost all functions can be operated in the same manner as they are in the front. Special features of operating the system in the rear are described here.

Music collection

- ▷ Storing music via the CD/DVD player in the front and the USB interface in the front only.
- ▷ Importing and exporting data via the USB interface in the front only.

Blu-ray video

No autoplay





When inserting a CD, DVD or Blu-ray disc, the playback does not start automatically.

To start the playback:

1. "Media/Radio"
2. "CD/DVD/Blu-ray"

Video menu

The following changes have been made to the video menu:

Sym- bol	Function
	<p>Call up Blu-ray menu. The film is stopped.</p> <p></p> <p>Press button to leave the Blu-ray menu.</p>
	<p>Call up Blu-ray pop-up menu. The film continues to run in the background.</p> <p></p> <p>Press button to leave the Blu-ray menu.</p>
	<p>Additional functions. It is also possible to mark film scenes. This function depends on the Blu-ray disc.</p>

Blu-ray memory

There is a Blu-ray memory in the vehicle, which must be deleted from time to time. If a corresponding message appears on the Control Display, proceed as follows:

1. "Media/Radio"
2.  Press button.
3. "Clear Blu-ray memory"

Picture in picture function

Some Blu-ray discs offer the opportunity to integrate an image into a running video in which other contents of the Blu-ray disc are displayed.

If this option is used on a screen, no video source other than the Blu-ray disc can be played back on the second screen.

To enable the simultaneous playback of Blu-ray discs and other video sources, proceed as follows:

1. "Media/Radio"
2.  Press button.
3. "Permit simultaneous playback of Blu-ray and other video sources"

Cinavia Notice

This product uses Cinavia technology to limit the use of unauthorized copies of some commercially-produced film and videos and their soundtracks. When a prohibited use of an unauthorized copy is detected, a message will be displayed and playback or copying will be interrupted. If playback or copying is interrupted and one of the messages shown below is displayed, the content is an unauthorized copy protected by Cinavia technology.

Message Code 1: Playback stopped. The content being played is protected by Cinavia® and is not authorized for playback on this device. For more information, see <http://www.cinavia.com>. Message Code 1.

Message Code 3: Audio outputs temporarily muted. Do not adjust the playback volume. The content being played is protected by Cinavia® and is not authorized for playback on this device. For more information, see <http://www.cinavia.com>. Message Code 3.

More information about Cinavia technology is provided at the Cinavia Online Consumer Information Center at <http://www.cinavia.com>. To request additional information about Cinavia by mail, send a postcard with your mailing address to: Cinavia Consumer Information Center, P.O. Box 86851, San Diego, CA, 92138, USA.

Intellectual property

Copyright 2004-2012 Verance Corporation. Cinavia® is a trademark of Verance Corporation. Protected by U.S. Patent 7,369,677 and

worldwide patents issued and pending under license from Verance Corporation. All rights reserved.

Navigation

Route planning can be performed separately on the left and right sides in the rear. Destination guidance can only be started from the front.

Suggesting a destination

A destination or trip can be sent to the front as a suggestion. The suggestion can be adopted or declined in the front. This function is not available with the following setting: "Limited (only Media/Radio)".

1. Enter the destination.
2. "Suggest destination to driver"

Options

No split screen possible.

External devices

General information

- ▶ Connection of external audio and video devices or digital cameras via the AUX-IN port or HDMI port in the rear. Operation takes place on the external device.
- ▶ Connection of external devices via the USB audio interface in the rear. Operation is the same as in the front.

Due to the large number of different audio and video devices available on the market, it cannot be ensured that every audio and video device will be displayed correctly on the screen.

Starting playback

1. "Media/Radio"
2. Select device.
 - ▶ "HDMI (rear)"

- ▶ "AUX (rear)"
- ▶ "USB"

Or:

Select the name of the USB storage device.

Volume

The volume of the sound output depends on the audio device. If this volume differs markedly from the volume of the other audio sources, we recommend adjusting the volume.

1. "Media/Radio"
2. "AUX (rear)"
3. Move the controller to the left.
4.  "Volume:"
5. Turn the controller until the desired volume is reached.
6. Press the controller.

Frequently asked questions

Why is only a black screen visible?

- ▶ Switch on the system.

Why are there no options available on the screen?

- ▶ Switch the remote control to these screens.

Why are radio stations grayed out and cannot be selected?

- ▶ Function is limited due to the selected priority. Change setting.

Why does the CD/DVD/Blu-ray not play back?

- ▶ Playback does not begin automatically. Start CD/DVD/Blu-ray manually.

Why can the volume of the rear vehicle speakers not be adjusted?

- ▶ Sound in the rear is output via the headphones. Change priority, if needed, and output sound via vehicle speakers.



Communication

All of the options available to you for mobile communication with family, friends, business partners, and service providers are described in this chapter.

Telephone

Vehicle features and options

This chapter describes all standard, country-specific and optional features offered with the series. It also describes features that are not necessarily available in your vehicle, e. g., due to the selected options or country versions. This also applies to safety-related functions and systems. When using these functions and systems, the applicable country provisions must be observed.

Concept

General information

Mobile phones can be connected to the vehicle via Bluetooth, see Owner's Manual for the vehicle.

Depending on the mobile phone, the following contents of the mobile phone are transferred to the vehicle:

- ▷ Contacts, refer to page 75.
- ▷ Short messages, refer to page 77.
- ▷ E-mails, refer to page 78.
- ▷ Calendar entries, appointments, refer to page 80.
- ▷ Tasks, refer to page 80.
- ▷ Notes, refer to page 81.

Data transfer can take several minutes.

Information



WARNING

Operating the integrated information systems and communication devices while driving can distract from traffic. It is possible to lose control of the vehicle. There is risk of an accident. Only use the systems or devices when the traffic situation allows. If necessary,

stop and use the systems and devices while the vehicle is stationary. ◀

Certain functions may need to be enabled by the mobile phone provider or service provider.

At high temperatures, the charge function of the mobile phone can be limited where appropriate and functions are no longer executed.

Do not operate a mobile phone that is connected to the vehicle on the mobile phone keypad, as this may lead to a malfunction.

When the mobile phone is used via the vehicle, refer to the owner's manual of the mobile phone.



Operation

Incoming call

If the number of the caller is stored in the phone book and is transmitted by the network, the name of the contact is displayed. Otherwise, only the phone number is displayed.

Accepting a call

Incoming calls can be answered in several ways.



- ▷ Via iDrive:
 -  "Accept"
- ▷  Press button on the steering wheel.
- ▷ Via the selection list in the instrument cluster:
 - Use the thumbwheel on the steering wheel to select: "Accept"

Rejecting a call

- ▷ Via iDrive:
 -  "Reject"

- ▶ Via the selection list in the instrument cluster:
Use the thumbwheel on the steering wheel to select: "Reject"
- ▶ Via gestures: swipe with the hand in the direction of the front passenger seat.

Ending a call

- ▶ Via iDrive:
 "End call"
- ▶  Press button on the steering wheel.

Last calls

The 20 last outgoing, missed, and incoming calls of both mobile phones are transferred to the vehicle.

Displays

1. "Communication"
2. "Recent calls"
3. The 20 last calls are displayed.

Filtering call list

1. "Calls:"
2. Select the desired setting.

Selecting number from list

Select from list. Call is established via the mobile phone, from where the entry originates.

Via options: start call via the second mobile phone.

To cancel: "End call"

Storing as contact or adding to contact

1. Highlight the contact.
2.  Press button.
3. "Save as contact" or "Add to contact"

Active calls

Adjusting the volume

Turn the volume button on the radio during the call, until the desired volume is reached. The setting is stored for the driver profile currently used.

Automatic volume adjustment

1. "My Vehicle"
2. "iDrive settings"
3. "Tone"
4. "Volume settings"
5. "Microphone" or "Speakers"
6. To adjust: turn the controller
7. To store: press the controller.

Dialing a number

1. "Communication"
2. "Dial number"
3. Enter the numbers.
4.  Select the symbol.



The connection is established via the mobile phone to which this function has been assigned.

If connection is to be set up via the additional phone:

1.  Press button.
2. "Call via"

Holding, resuming

An active call can be put on hold and resumed later on.

- ▶  "Hold/Resume"
Call is put on hold.
- ▶  "Hold/Resume"
Call is resumed.

Muting the microphone

When a call is active, the microphone can be muted.

 "Microphone"

The muted microphone is automatically activated:

- ▷ When a new connection is established.
- ▷ When switching between call parties.

DTMF suffix dialing

DTMF suffix dialing can be used for gaining access to network services or for controlling devices, e.g., to make a remote inquiry of an answering machine. The DTMF code is needed for this purpose.

1.  "Keypad dialing"
2. Enter DTMF code.

Calls with multiple parties

General information

You can switch between calls or connect two calls to a single conference call. These functions must be supported by the mobile phone and service provider.

Accepting a call while speaking to another party

If a second call comes in during an ongoing call, a call waiting signal sounds where appropriate.

 "Accept"

The call is accepted and the existing call is put on hold.

Establishing a second call

An additional call can be established while a call is active.

1.  "Contacts"
2. Select new number.

The call is started and the first call is put on hold.

Switching between two calls, toggling

You can switch between two calls.

1. Establish two calls.
2. "Resume"
The call on hold is resumed.

Establishing a conference call

Two calls can be connected to a single telephone conference call. The calls must be made from the same mobile phone.

1. Establish two calls.
2.  "Conference call"

Hands-free system

General information

Calls that are being made on the hands-free system can be continued on the mobile phone and vice versa.

From the mobile phone to the hands-free system

Calls that were begun outside of the Bluetooth range of the vehicle can be continued on the hands-free system with the ignition or standby state switched on, as long as the remote control is in the vehicle.

Depending on the mobile phone, the system automatically switches to the hands-free system.

If the system does not switch over automatically, follow the instructions on the display of the mobile phone. Refer also to the owner's manual of the mobile phone.

From the hands-free system to the mobile phone

Calls that are made on the hands-free system can in some cases be continued on the mobile phone; this depends on the mobile phone.

Follow the instructions on the display of the mobile phone. Refer also to the owner's manual of the mobile phone.

Snap-in adapter

Concept

The snap-in adapter is used to:

- ▶ Hold the mobile phone.
- ▶ Recharging the battery.
- ▶ Connect to the outside antenna of the vehicle.

This provides for better network reception and consistent sound quality.

General information

For more information about snap-in adapters that support the functions of the mobile phone, contact a dealer's service center or another qualified service center or repair shop.

Information

At high temperatures, the charge functions of the mobile phone can be limited where appropriate and the functions are no longer executed.

Installation position

The snap-in adapter is located in the front of the center armrest. The direction of installation in the center armrest varies according to the vehicle.

Inserting the snap-in adapter

1. Press button and remove the cover.



2. Insert the snap-in adapter at the front, arrow 1, and press down, arrow 2, until it engages.



Inserting the mobile phone

1. Depending on the mobile phone, remove the protective cover from the antenna connector and from the USB connection of the mobile phone.
2. Slide the mobile phone with the buttons facing up in the direction of the electrical connections, arrow 1, and push downward, arrow 2, until it engages.

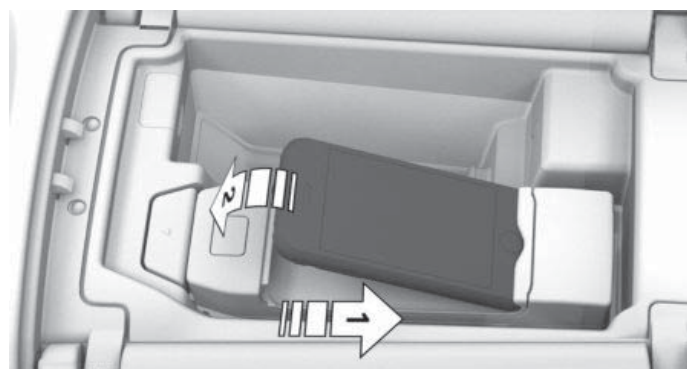

Removing the mobile phone

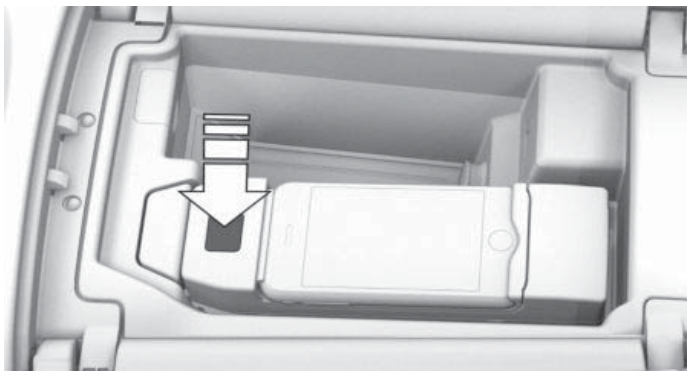

Depending on the mobile phone, press or slide the button and remove the mobile phone. Depending on the mobile phone, reinstall the protective cover on the mobile phone's antenna plug and USB connector.

Removing the snap-in adapter

Press button in front of the snap-in adapter. Remove the adapter and, if needed, reattach the cover.

Wireless charging tray

Concept

The wireless charging tray enables the following functions:

- ▶ Hold the mobile phone.
- ▶ Recharge the battery of a compatible mobile phone.
- ▶ Charge the BMW Display key, see Owner's Manual for the vehicle.
- ▶ Connect the mobile phone to the external antenna.

Depending on the country, this provides for better network reception and consistent sound quality.

Information



ATTENTION

The tray is intended for mobile phones up to a particular size. Forceful inserting of the mobile phone into the tray can damage the tray or the mobile phone. There is a risk of damage to property. Observe the maximum dimensions for mobile phones. Do not force the mobile phone into the tray. ◀

Overview

The wireless charging tray is located in the front center armrest.

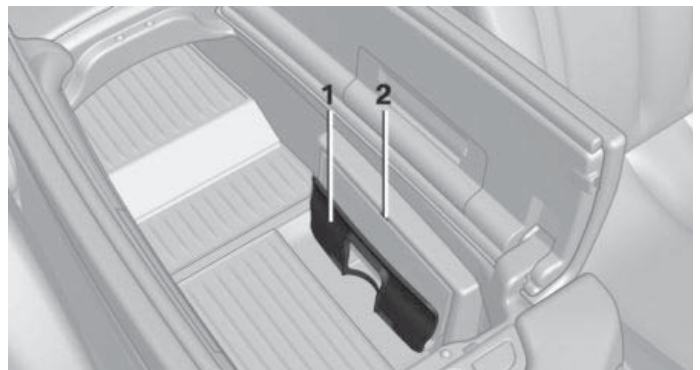

- 1 Bracket
- 2 LED

Functional requirements

- ▶ The mobile phone must compatibly support the required Qi standard. For compatible mobile phones, see Owner's Manual for the vehicle.

If the mobile phone does not support the Qi standard, the mobile phone can be charged using a special Qi-compatible charging case.

- ▶ The mobile phone must not exceed the maximum size of approx. 5.9 x 2.9 x 0.6 in/151 x 74 x 16 mm.
- ▶ Only use protective cases and covers up to a maximum thickness of 0.07 in/2 mm. Otherwise, the charging function may be impaired.
- ▶ Ignition or standby state is switched on.

Activating the forgotten warning

If the vehicle is equipped with the forgotten warning function, a warning can be output if a device was forgotten in the wireless charging tray when leaving the vehicle.

Via iDrive:

1. "My Vehicle"
2. "iDrive settings"
3. "Wireless charging tray"
4. "Forgotten cell phone alert"

Inserting the mobile phone

1. Open center armrest, refer to vehicle Owner's Manual.
2. Slide the mobile phone into the holder with the display facing to the outside.

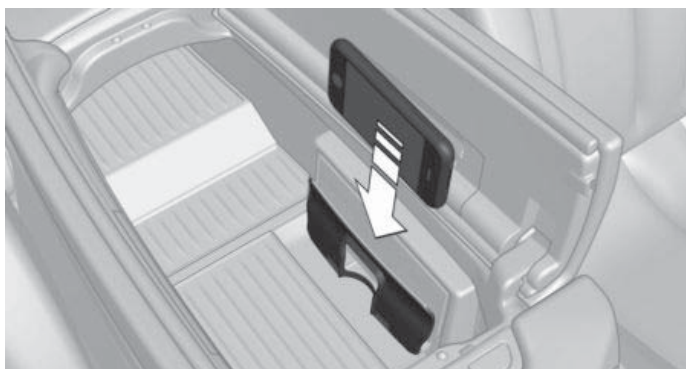

LED displays

Color.	Meaning
Blue	Device is charging.
Orange:	Device will not be charged. Temperature on the mobile phone possibly too high or foreign object in charging tray.
Red	Device will not be charged. Contact a dealer's service center or another qualified service center or repair shop.

System limits

At high temperatures on the mobile phone, the charging functions of the mobile phone may be limited and some functions may no longer work.

Do not force the mobile phone into the tray.

Contacts

General information

Contacts can be created and edited. The contacts from the mobile phone are additionally transferred and displayed. Contact pictures can be displayed, if the mobile phone supports this function.

Displaying all contacts

Via iDrive:

1. "Communication"
2. "Contacts"

The contacts are listed in alphabetical order. Depending on the number of contacts, contact search and quick search are offered.

Searching contacts

Contact search is available with more than 30 contacts.

1. 🔍 "Search"
2. Enter the letters.
The hits are displayed on the right side.
3. Move the controller to the right.
4. Select the contact to display it.

Searching contacts in lists

Quick search is available with more than 30 contacts per contact list. All letters for which

there are entries are displayed in alphabetical order on the left edge of the Control Display.

1. Turn the controller to the left or right quickly.

All letters, for which contacts are stored, are displayed on the left edge.

2. Select the first letter of the desired contact.

The first entry of the selected letter is displayed.

Storing a home contact

It is possible to store a home contact. This will be the first entry in the contact list.

1. "Home contact (empty)"
2. Fill in the desired fields.
3. "Save contact in the vehicle"

Storing a contact in the vehicle





1.  Press button.

2. "Save contact in the vehicle"

A copy of the contract from the mobile phone is stored in the vehicle.

Additional functions

The following functions are available in an selected contact:

- ▶  Start destination guidance.
- ▶  Call contact.
- ▶  Open the Internet address.
- ▶  New e-mail.

Deleting contact

A contact stored in the vehicle can be deleted. Contacts transferred from the mobile phone cannot be deleted.

1. Highlight the desired contact.

2.  Press button.

3. "Delete contact"

Deleting all contacts in vehicle

All contacts stored in the vehicle are deleted. Contacts transferred from the mobile phone are not deleted.

1.  Press button.
2. "Delete all contacts in the vehicle"
3. "OK"

New contact

If necessary, "Clear input fields"

1.  Press button.
2. "New contact"
3. Fill in the desired fields.
4. "Save contact in the vehicle"

Selecting sources

You can choose, whether and from which mobile phone the contacts should be transferred.

1.  Press button.
2. "Select sources for contacts"
3. Select the desired mobile phone.

Sorting contacts

Contact names can be displayed in a different order. Depending on how the contacts were stored on the mobile phone, the sorting order of the contacts may differ from the selected sorting order.

1.  Press button.
2. "Sort contacts"
3. "Last name" or "First name"

Checking the address as a destination

1. Select the desired contact.
2. Select the address.

3. "Check address" or "Search for address online"
4. Correct entries, if necessary.
5. "Start guidance"

The address can be used for the destination guidance.

Editing a contact

If a contact transferred from the mobile phone is changed, a copy of the entry is created in the vehicle during storing.

Contact entries having identical names are combined into one contact.

Via iDrive:

1. Select the desired contact.
2. "Edit contact"
3. Change the desired entry or add entries.
4. "Save contact in the vehicle"

Show contact pictures

Pictures stored with the contacts are stored in the vehicle when the mobile phone is connected to the vehicle.

Via iDrive:

1. "My Vehicle"
2. "iDrive settings"
3. "Mobile devices"
4. "Settings"
5. "Contact images"
6. Move the controller to the left.

Short messages

Displaying all short messages

Via iDrive:



1. "Communication"
2. "Messaging"

All short messages are displayed.

Information about the BMW messages, refer to page 85.

Status

A symbol identifies the short message status.

Symbol	Meaning
	Read short message.
	Unread short message.

Filtering the message list

1.  Press button.
2. "Filter messages"
3. Select the desired setting.

Selecting sources

You can choose, whether and from which mobile phone the short messages should be transferred.

1.  Press button.
2. "Select sources for messages"
3. Select the desired mobile phone.

Delete SMS text message history

Delete the entire conversation with a messaging party.







1. Highlight the desired short message.
2.  Press button.
3. "Delete text message thread"
4. "Yes"

Displaying a short message

Select the desired short message or conversation. The conversation with this messaging partner is displayed.

Additional functions

The following functions are available when a short message or conversation is selected.

- ▷  "Call sender"
- ▷  "Add to contacts" or "Show sender"
- ▷  "Forward", refer to page 78.
- ▷  "Reply", refer to page 78.
- ▷  "Delete"
- ▷  Read contents, refer to page 82.
- ▷ "Use contact data", refer to page 82.

Answering or forwarding a short message

Via iDrive:

1. Select the desired short message.
2. ▷  "Reply"

The recipient of the short message is automatically entered.

 - ▷  "Forward"

"To:"

Enter phone number or contact. Turn the controller to the right as needed to select the contact from the list of results.
3. "From:"

Select mobile phone as needed, from which the short message should be sent.
4. "Text:"

Text recognition, refer to page 81.
5. "Send"

New short message

Via iDrive:

1. "Messaging"
2.  "Compose text message"
3. "To:"

Enter phone number or contact. Turn the controller to the right as needed to select the contact from the list of results.

4. "From:"

Select mobile phone as needed, from which the short message should be sent.
5. "Text:"

Text recognition, refer to page 81.
6. "Send"

To cancel: "Delete all content"

E-mail

Displaying all e-mails

Via iDrive:

1. "Communication"
2. "Email"

All e-mails are displayed.



Selecting account

You can choose, whether and from which mobile phone and possibly from which user account the e-mails should be transferred.

1.  Press button.
2. "Select account"
3. Select the desired account.

Status

A symbol identifies the e-mail status.

Symbol	Meaning
	Read e-mail.
	Unread e-mail.

Filtering e-mails

1.  Press button.
2. "Filter emails"
3. Select the desired setting.

Deleting e-mail

1. Highlight the desired e-mail.

2.  Press button.

3. "Delete email"

4. "OK"

Displaying all recipients

If an e-mail has several recipients, they can be displayed and their data used for further functions.

1. Select the desired e-mail.

2.  Press button.

3. "Show all recipients"

New e-mail

Via iDrive:

1. "Communication"

2. "Email"

3.  "Compose email"

4. "To:"

Enter e-mail address or contact. Turn the controller to the right as needed to select the contact from the list of results.

5. "From:"

Select account as needed, from which the e-mail should be sent.

6. "Subject:"

Text recognition, refer to page 81.

7. "Text:"

Text recognition, refer to page 81.

8. "Send"

To cancel: "Delete all content"

Additional functions

The following functions are available for a selected e-mail.

▷  "Text-to-speech", refer to page 82.

▷  "Reply", refer to page 79.

▷  "Add to contacts" or "Show sender"

▷  "Mark as unread"

▷  "Delete email"

Answering and forwarding e-mails

Via iDrive:

1. Select the desired e-mail.

2.  "Reply"

▷  "Reply"

The e-mail recipient is automatically entered.

▷  "Reply to all"

All e-mail recipients are automatically entered.

▷  "Forward"

Enter e-mail address or contact. Turn the controller to the right as needed to select the contact from the list of results.

3. "To:"

Enter e-mail address or contact. Turn the controller to the right as needed to select the contact from the list of results.

4. "From:"

Select mobile phone and user account as needed, from which the e-mail should be sent.

5. If necessary, "Subject:"

Text recognition, refer to page 81.

6. "Text:"

Text recognition, refer to page 81.

7. "Send"

Calendar

Displaying the calendar

Via iDrive:

1. "Communication"
2. "Calendar"

The appointments of the current week are displayed.

To display different days in the calendar:

- ▷ "Show previous week"
- ▷ "Show next week"

Displaying the calendar month

Select the calendar day. The monthly overview is displayed. Calendar days with appointments are marked.

Switching to today

1.  Press button.
2. "Change to today"



Selecting sources

You can choose, whether and from which mobile phone the appointments should be transferred.

1.  Press button.
2. "Select source"
3. Select the desired mobile phone.

Additional functions

The following functions are available in a selected appointment.

- ▷  Read contents, refer to page 82.
- ▷  Start destination guidance.
- ▷ "Use details", refer to page 82.

Activating reminders

Via iDrive:

1.  Press button.
2. "Activate reminders"

Reminders are displayed in the Messages and in the Status field, see Owner's Manual for the vehicle.

Deactivating reminders

Via iDrive:

1. Select the desired calendar entry.
2.  "Deactivate reminders"

Updating data

Update data, refer to page 82.

Tasks

Display tasks

Via iDrive:

1. "Communication"
 2. "Tasks"
- All tasks are displayed.

Sorting tasks

1. "Sorted by"
2. Select the desired setting.

Activating reminders

1.  Press button.
2. "Activate reminders"

Reminders are displayed in the Messages and in the Status field, see Owner's Manual for the vehicle.

Updating data

Update data, refer to page 82.

Selecting sources

You can choose, whether and from which mobile phone the tasks should be transferred.

1.  Press button.
2. "Select source"
3. Select the desired mobile phone.

Additional functions

The following functions are available in a selected task.

- ▶  Read contents, refer to page 82.
- ▶ "Use contact data", refer to page 82.

Notes

Displaying all notes

Via iDrive:

1. "Communication"
2. "Memos"

All voice notes and text notes are displayed.

Exporting all voice notes

In order to export voice notes via the USB port, a compatible device must be connected to the USB interface.

- ▶ Compatible devices: USB mass storage devices, such as USB flash drives or MP3 players with a USB interface.
- ▶ Non-compatible devices: USB hard drives, USB hubs, USB memory card readers with multiple inserts, Apple iPod/iPhone.
- ▶ File systems: popular file systems for USB media are supported. FAT 32 is the recommended format.



1.  Press button.
2. "Export all memos (USB)"

Voice notes already existing on the USB storage device are overwritten during exporting.

Deleting all voice notes

1.  Press button.
2. "Delete all voice memos"
3. "OK"

New voice note

1.  "New voice memo"
2.  "Start recording"/"Resume recording"
3.  "Pause recording"
4. "Save"

The voice note is displayed in the list of voice notes.





To cancel: "Cancel"

Displaying a note

Select the desired note.

Additional functions

The following functions are available when a voice note is selected.

- ▶  "Email with voice memo", refer to page 79.
- ▶  "Export (USB)", refer to page 81.
- ▶  "Delete"
- ▶  "Play", refer to page 82.

Updating data

Update data, refer to page 82.







Text recognition

Concept

Spoken words are detected by voice recognition and converted into text. This text can be corrected and supplemented as required. The text can be used as subject or content of e-mails or short messages.

Recording texts

Via iDrive:

1.  Select the desired language.
2.  Select the symbol to start the recording.
3.  Select the symbol to end the recording.
4. **OK** "Confirm text"
5.  "Delete last dictation"
 -  "Delete all"
 -  "Read out full text"
 -  "Read out last dictation"

Improving voice recognition for contact names

The contact names of a connected mobile phone are transmitted to voice recognition. This improves the recognition of contact names during text conversion.

Activating/deactivating the function

The function can be activated or deactivated for the respective mobile phone.

Via iDrive:

1. "My Vehicle"
2. "iDrive settings"
3. "Mobile devices"
4. Select the desired device.
5. "Server speech recognition"

Activating/deactivating the function globally





The function can be activated or deactivated jointly for all mobile phones.

Via iDrive:

1. "My Vehicle"
2. "iDrive settings"
3. "Language"
4. "Offboard voice processing"





Reading out loud

SMS, e-mail, tasks, text notes, and calendar entries can be read out loud.

-  "Play"
-  "Pause"
-  "Next section"/"Next element"
-  "Previous section"/"Previous element"
-  Move the controller to the left to end.

Playback





Voice notes can be played.

-  "Play"
-  "Pause"
-  "Fast forward"
-  "Fast rewind"

Updating data

Notes, tasks, and appointments of the calendar can be updated.

Via iDrive:

1. "Communication"
2. Select desired setting:
 -  "Calendar"
 -  "Tasks"
 -  "Memos"
3.  Press button.
4. "Update data"

Using data

Phone numbers, mail addresses in calendars, short messages, etc. can be used in other functions..

While driving:

1. Select the desired element, e.g., a short message.
2. "Use contact data"
3. All usable data is displayed.
4. Highlight the desired element, e.g., a phone number.
5. Move the controller to the right.
All available options are displayed.
 - ▷ "Compose email"
 - ▷ "Compose text message"
 - ▷ "Add to contact"
 - ▷ "Save as contact"
 - ▷ "Call number in message"
 - ▷ "Go to website"
6. Select the desired setting.

The elements can be individually selected when the vehicle is stationary. The available options are displayed.

Adapting the menu

The menu can be adapted, e.g., to remove entries from the menu for functions not being used.

Via iDrive:

1. "Communication"
2. "Personalize menu"
3. Select the desired setting.
4. Move the controller to the left.

WiFi hotspot

Vehicle features and options

This chapter describes all standard, country-specific and optional features offered with the series. It also describes features that are not necessarily available in your vehicle, e. g., due to the selected options or country versions. This also applies to safety-related functions and systems. When using these functions and systems, the applicable country provisions must be observed.

Concept

A WiFi hotspot is integrated in the vehicle. This hotspot can be activated, e.g., to connect a mobile phone or a laptop.

General information

Up to 8 devices can be connected with the WiFi hotspot.

Connect device with WiFi hotspot, see Owner's Manual for the vehicle.

Settings

The network name and hotspot code can be changed. In addition, the network name can be hidden so that it cannot be found by other devices.

Via iDrive:

1. "My Vehicle"
2. "iDrive settings"
3. "Mobile devices"
4.  Press button.
5.
 - ▷ "Change hotspot key"
Enter the desired hotspot code.

- ▷ "Change hotspot name"
Enter the desired network name.
 - ▷ "Hide hotspot"
Activate or deactivate the function.
6. **OK** Select the symbol.

ConnectedDrive

Vehicle features and options

This chapter describes all standard, country-specific and optional features offered with the series. It also describes features that are not necessarily available in your vehicle, e. g., due to the selected options or country versions. This also applies to safety-related functions and systems. When using these functions and systems, the applicable country provisions must be observed.

ConnectedDrive Store

Concept

In vehicles with specific technical requirements, various services in the vehicle can be ordered later.

General information

The range of services offered depends on the country.

Ordering services

Via iDrive:

1. "ConnectedDrive"
An overview of the services present in the vehicle and those to be ordered later is displayed.
2. To purchase a service, select it and follow the instructions on the Control Display.

Concierge service

Concept

The Concierge service offers information on events, gas stations or hotels, and provides phone numbers and addresses. A voice connection to the Concierge service is established

for this purpose. Many hotels can be booked directly by the BMW Concierge service. The Concierge service is part of the optional BMW Response Center Plan.

Starting Concierge service

Via iDrive:

1. "ConnectedDrive"
2. "Concierge"

A voice connection to the Concierge service is established.

My Info

General information

Messages from My Info can originate from the ConnectedDrive customer portal or be sent from selected partners.

BMW messages

General information

Message from the Concierge service and My Info are displayed.

Information about the short messages from the mobile phone, refer to page 77.

Displaying BMW messages



Via iDrive:

1. "ConnectedDrive"
or
"Communication"
2. "BMW messages"

The most recent BMW messages are displayed.

Status

A symbol identifies the message status.

Symbol	Meaning
	Read BMW message.
	Unread BMW message.

Filtering message list by status

-  Press button.
- "Filter BMW messages"
- Select the desired setting.

Filtering message list by message type

- "Filter"
- Select the desired setting.

Additional functions

The following functions are available in a selected message, from Concierge service, or from My Info.

- ▶  Select the location to start destination guidance.
- ▶ Select phone number to make a call.
- ▶ Select Internet address to open it.

Deleting a message

-  Press button.
- Delete highlighted message: "Delete message"
Delete all messages: "Delete all messages"

BMW TeleService

Concept

Teleservices are services that help to maintain vehicle mobility.

Depending on the equipment version, Teleservices comprise the following services:

- ▶ Roadside Assistance, refer to page 86.
- ▶ Service Request, refer to page 87.
- ▶ Automatic Service Request, refer to page 87.
- ▶ Teleservice Report, refer to page 88.
- ▶ Teleservice Battery Guard, refer to page 88.
- ▶ Your dealer's service center, refer to page 89.

General information

Teleservices are typically activated in the vehicle. For further use of the services, the vehicle manufacturer recommends contacting a dealer's service center or another qualified service center or repair shop or the hotline.

The service varies by country.

Services may be restricted abroad.

Requirements

- ▶ Active ConnectedDrive contract, equipment version with Intelligent emergency call or BMW ConnectedDrive services.
- ▶ Cellular network reception must be available.

Roadside Assistance

Concept

BMW Roadside Assistance can be contacted if assistance is needed in the event of a breakdown.

General information

In the event of a breakdown, data on the vehicle's condition is sent by BMW to Roadside Assistance.

Roadside Assistance can also be contacted via a Check Control message, refer to the Owner's Manual for the vehicle.

Starting Roadside Assistance

Starting the service

If the vehicle is equipped with Teleservices, support is offered through TeleService Diagnosis.

Via iDrive:

1. "ConnectedDrive"
2. "BMW Assist"
3. "BMW Roadside Assistance"

A voice connection is established with Roadside Assistance.

TeleService Diagnosis

Teleservice Diagnosis enables the wireless transmission of detailed vehicle data that is important for vehicle diagnosis. This data is transmitted automatically.

After the data is transmitted, the voice connection to Roadside Assistance is reestablished.

Starting TeleService Help

TeleService Help enables an in-depth diagnosis of the vehicle by Roadside Assistance via wireless transmission.

The driving ability of the vehicle can be restored for specific functions.

TeleService Help can be started after a prompt by Roadside Assistance and the termination of the voice connection.

1. Park the vehicle in a safe place.
2. Set the parking brake.
3. Control Display is switched on.
4. "TeleService Help"

After completion of TeleService Help, a voice connection is established to Roadside Assistance.

Service Request

Concept

Using a manually initiated Service Request, Teleservice data on the vehicle's service requirements is directly sent by BMW to the dealer's service center. If possible, the dealer's service center will contact you and a service appointment can be arranged.

General information

A Service Request can also be started via a Check Control message, see Owner's Manual for the vehicle.

Starting a Service Request

Via iDrive:

1. "ConnectedDrive"
2. "BMW Assist"
3. "TeleService Call"

Automatic Service Request

Concept

The Teleservice data necessary for servicing the vehicle is sent automatically by BMW to the dealer's service center prior to the service deadline. If possible, the dealer's service center will contact you and a service appointment can be arranged.

This way, the dealer's service center can plan the necessary work in advance. This shortens the duration of the service appointment.

Last Service Request

Check when your dealer's service center was notified, refer to page 88.

Teleservice Report

Concept

Transmits technical data that is evaluated for the ongoing development of BMW products from your vehicle to BMW in regular intervals, if needed.

General information

Teleservice Report is activated and free of charge in vehicles that meet certain technical requirements if they have an active BMW ConnectedDrive contract and are equipped with Intelligent emergency call or BMW ConnectedDrive services.

Neither personal data nor position data is transmitted.

Displays

Indicate when the last Teleservice Report was transmitted, refer to page 88.

Teleservice Battery Guard

Concept

If the battery charging state falls below certain values, BMW will inform you or your dealer's service center directly in defined cases or the next time the vehicle is started.

General information

If necessary, the dealer's service center will contact you to arrange a service appointment.

Information

Battery Guard Teleservice is activated and free of charge only in vehicles that meet certain technical requirements, have an active BMW ConnectedDrive contract, and are equipped with Intelligent emergency call or BMW ConnectedDrive services. To be informed by Battery Guard Teleservice, your contact data must

be stored in the ConnectedDrive customer portal.

Displays

Indicate when the last Teleservice Battery Guard Call was transmitted, refer to page 88.

Last Service Request

Concept

The last Service Requests, e.g., the last report to the dealer's service center, can be displayed on the Control Display.

Displaying the last Service Request

Check to see when the last Service Request was transmitted.

Via iDrive:

1. "My Vehicle"
2. "Vehicle status"
3.  "TeleService Call"

Customer Relations

Concept

Contact the BMW hotline for information on all aspects of your vehicle.

Calling Customer relations

Via iDrive:

1. "ConnectedDrive"
2. "BMW Assist"
3. "Customer Relations"

A voice connection is established to Customer Relations.

Your dealer's service center

Concept

Available contact to the dealer's service center.

General information

In special cases, e.g., following a change of owner or a move, an adaptation of the entered dealer's service center may be necessary. This can be done via the hotline, by a dealer's service center or another qualified service center or repair shop or possibly even independently on the Control Display.

Calling a dealer's service center

Via iDrive:

1. "ConnectedDrive"
2. "BMW Assist"
3. "Your service center"

A voice connection is established with the dealer's service center.

4. Select number.

Changing dealer's service centers

Via iDrive:

1. "ConnectedDrive"
2. "BMW Assist"
3. "Your service center"
4. Follow the instructions on the Control Display.

Update BMW Assist

Concept

Manual update of all services available in the vehicle.

Update BMW Assist

Via iDrive:

1. "ConnectedDrive"
2.  Press button.
3. "Update BMW Assist"

Data transfer

Concept

The data transfer status can be displayed during a service update.

Displaying the data transfer

Via iDrive:

1. "ConnectedDrive"
2.  Press button.
3. "Data transfer"

BMW ConnectedDrive Services

Concept

BMW ConnectedDrive Services offer the option to display information, e.g., regarding the weather or sports, in the vehicle using apps and other functions.

Displaying BMW ConnectedDrive Service apps

Via iDrive:

1. "ConnectedDrive"
2. Select desired app.

Messages

- ▷ My Info Messages, refer to page 85.

Driver profile

- ▷ Export/import driver profile, see Owner's Manual for the vehicle.

Remote Services

Concept

With remote services, a connection can be established between a compatible smartphone and the vehicle. This can be used to lock and unlock the vehicle, e.g.

General information

Other functions may be available, depending on the vehicle.

The BMW ConnectedDrive app must be downloaded to execute these functions. Operation can be performed via the app.

Functions must first be activated in the ConnectedDrive customer portal before they can be used. An active BMW ConnectedDrive contract is required.

Alternatively, certain function can also be selected via the ConnectedDrive Call Center.

The Owner's Manual for the BMW ConnectedDrive app can be found on the ConnectedDrive customer portal or at bmw.com.

Apps

General information

Certain apps of a compatible smartphone can be integrated in the vehicle. These apps are shown on the Control Display.

Information about compatible smartphones can be found at www.bmw.com/bluetooth, information about available software applications and their installation can be found at www.bmw.com/connectivity, or contact a dealer's service center or another qualified service center or repair shop.

Information

For reasons of safety, some apps are usable only while the vehicle is stationary.



WARNING

Operating the integrated information systems and communication devices while driving can distract from traffic. It is possible to lose control of the vehicle. There is risk of an accident. Only use the systems or devices when the traffic situation allows. If necessary, stop and use the systems and devices while the vehicle is stationary. ◀

The manufacturer of your vehicle recommends the use of apps that BMW has determined to be compatible with your vehicle; otherwise there may be malfunctions in system operations.

- ▷ The functional scope shown on the Control Display depends on the scope of the app installed on the smartphone.
- ▷ The data transfer of the apps from the smartphone to the vehicle can take some time. Some apps depend on the speed of the available Internet connection of the smartphone.
- ▷ Some smartphones cannot simultaneously use apps and the Bluetooth hands-free system. If necessary, restart the app on the smartphone after a phone conversation.
- ▷ Using apps on a smartphone can incur mobile telephony costs. These costs are not a part of the apps.

Requirements

- ▷ Corresponding mobile wireless contract.
- ▷ Compatible smartphone.
- ▷ Apps are installed on the smartphone and ready for operation.
- ▷ Smartphone is connected to the vehicle via snap-in adapter, USB port or Bluetooth, refer to the Owner's Manual of the vehicle.

Using Apps

1. "ConnectedDrive"
2. Select desired app on the smartphone.

Displaying the status

Information about the currently available apps can be displayed.

1. "ConnectedDrive"
2. "Personalize menu"

Frequently asked questions

Why are the apps installed on my smartphone not displayed on the Control Display, although the smartphone is connected to the vehicle?

- ▶ The smartphone is not selected anymore for using apps.

A different smartphone connected to the vehicle was selected for using apps.

- ▶ The smartphone is not selected anymore for using Bluetooth audio.

The smartphone is connected to the vehicle via Bluetooth. A different smartphone connected to the vehicle was selected for using Bluetooth audio. Without Bluetooth audio, apps cannot be used via a Bluetooth connection.

If two different smartphones should be used for audio playback and using apps, one of the smartphones must be connected to the vehicle via USB interface.

- ▶ The smartphone is connected to the vehicle via Bluetooth and USB interface at the same time.

If the connection is established via USB interface and Bluetooth at the same time, the Bluetooth connection is prioritized.

Adapting the menu

The menu can be adapted, e.g., to remove entries from the menu for functions not being used.

Via iDrive:

1. "ConnectedDrive"
2. "Personalize menu"
3. Select the desired setting.
4. Move the controller to the left.



Reference

This chapter contains an index that will quickly take you to the information you need.

Everything from A to Z

Index

A

Address entry, navigation 9
Alternative routes 18
AM/FM station 38
Announcement, navigation,
see Spoken instructions 17
Applications 90
Apps 90
Areas to be avoided 24
Arrow view, Split screen 26
Assistance, Roadside Assis-
tance 86
Audio CD 46
Audio, external devices 45
Audio playback, Bluetooth 51
Audio playback, pause,
pause, audio playback 34
Audio player 45
Audio remote control 58
Automatic Service Re-
quest 87

B

Balance 36
Bang & Olufsen 37
Bass 36
Battery Guard 88
Battery replacement, audio
remote control 58
Battery replacement, remote
control, rear entertain-
ment 61
Bluetooth audio 51
BMW ConnectedDrive
Store 85
BMW messages 85
BMW TeleService 86
BMW Touch Command, with
rear entertainment 61

Bowers & Wilkins 37
Breakdown assistance 86

C

CD/DVD, notes 46
Changing the route de-
tails 18
Charging tray 74
Concierge service 85
Concierge service mes-
sages 85
ConnectedDrive Services 89
Customer relations 88

D

Default settings, Naviga-
tion 23
Destination entry by voice 10
Destination entry, GPS coor-
dinate 12
Destination guidance 17
Destination guidance hints,
route 21
Destination guidance with in-
termediate destinations, see
Trip 14
Destination input 9, 10
Digital radio 39
DVD 55
DVD settings 56
Dynamic destination guid-
ance 29

E

Emergency service, see
Roadside Assistance 86
Entertainment, changing the
entertainment source 34

Entertainment, control ele-
ments 34
Entertainment in the rear 59
Entertainment, Overview 34
Equalizer 36

F

Fader 36
FM/AM station 38

G

Gas station recommenda-
tion 20
Gong, volume equaliza-
tion 37
GPS coordinates, destination
entry 12
GPS navigation, see Naviga-
tion system 8
Gray display of the map 29

H

HD Radio 39
Headphones, rear entertain-
ment 63
Help for rear entertainment,
see frequently asked ques-
tions 67
Help regarding navigation,
see frequently asked ques-
tions 31
Home address, navigation 10
Hotspot 84

I

Inductive charging 74
Interactive map 21

Intermediate destination, navigation 14

Internet hotspot 84

iPod/iPhone 51

L

List of destination guidance hints, Split screen 26

M

Maneuvering hints, route 21

Map, navigation 16

Map view, functions 21

Message list, traffic information 27

Messages from BMW 85

Messages from Concierge service 85

Messages from My Info 85

Mobile phone, operation 70

MP3 player 45

Multi-channel playback surround 36

Music collection 48

My Info messages 85

N

Navigation, Split screen 26

O

Online alternative routes 18

P

Points of Interest, navigation 11

Q

Quick search 10

R

Radio 38

Radio, adjusting the volume 34

Radio, changing the entertainment source 34

Radio, control elements 34

Radio, muting 34

Radio, Overview 34

Radio, tone settings 36

RDS 39

Realtime traffic information, RTTI 28

Rear entertainment 59

Recent destinations 9

Remote App 90

Remote control, audio 58

Remote control, rear entertainment 60

Remote Services 90

Renaming a station 39

Roadside Assistance 86

Route 19

Route criteria, route 18

Route, displaying 19

Route magnet 19

Route section, bypassing 19

RTTI realtime traffic information 28

S

Satellite radio 40

Save destination as contact 17

Select a destination from contacts, Navigation 12

Service messages 85

Service Request 87

Service, Roadside Assistance 86

Services, ConnectedDrive 89

Services, remote 90

Settings, Navigation 23

Short messages 77

Smartphone, operation 70

SMS 77

Snap-in adapter, mobile phone 73

Software applications, smartphone 90

Sound, Bowers & Wilkins 37

Speed Volume, volume equalization 37

Split screen, Navigation 26

Spoken instructions, navigation 17

State/province, selecting for navigation 9

Stations, stored 44

Station, storing 38

Store, see BMW ConnectedDrive Store 85

T

Tablet, with rear entertainment 61

Telephone, operation 70

Teleservice Battery Guard 88

Teleservice Report 88

Tone 36

Tone, Bang & Olufsen 37

Tone, equalizer 36

Tone, multi-channel playback surround 36

Touch Command, with rear entertainment 61

Traffic information, navigation 27

Treble 36

Trip, destination guidance with intermediate destinations 14

U

USB audio interface 51

V

Video-DVD [55](#)

Video playback [55](#)

W

WiFi hotspot [84](#)

WiFi Hotspot [84](#)

Wireless charging [74](#)

Y

Your dealer's service center [89](#)

More about BMW



The Ultimate
Driving Machine®

bmwusa.com

01 40 2 970 605 ue

