

TEST REPORT



Report No.: TW2308006E
Applicant: DawnSun Electronic Technology Co., Ltd. Zhongshan
Product: Remote Control – Transmitter
Model No.: TX015
Trademark: N/A
Test Standards: FCC Part 15 Subpart C, Paragraph 15.231

Test result: It is herewith confirmed and found to comply with the requirements set up by ANSI C63.4&FCC Part 15 Subpart C, Paragraph 15.231 for the evaluation of electromagnetic compatibility

Approved By

A handwritten signature in black ink that reads 'Terry Tang'.

Terry Tang

Manager

Dated: August 11, 2023

Results appearing herein relate only to the sample tested
The technical reports is issued errors and omissions exempt and is subject to withdrawal at

SHENZHEN TIMEWAY TESTING LABORATORIES

Zone C, 1st Floor, Block B, Jun Xiang Da Building, Zhongshan Park Road West, Tong Le Village, Nanshan District, Shenzhen, China

Tel (755) 83448688, Fax (755) 83442996, E-Mail:info@timeway-lab.com



Special Statement:

The testing quality ability of our laboratory meet with "Quality Law of People's Republic of China" Clause 19.

The testing quality system of our laboratory meet with ISO/IEC-17025 requirements, which is approved by CNAS. This approval result is accepted by MRA of APLAC.

Our test facility is recognized, certified, or accredited by the following organizations:

CNAS-LAB Code: L2292

The EMC Laboratory has been assessed and in compliance with CNAS-CL01 accreditation criteria for testing Laboratories (identical to ISO/IEC 17025:2017 General Requirements) for the Competence of testing Laboratories.

FCC-Registration No.: 744189

The EMC Laboratory has been registered and fully described in a report filed with the (FCC) Federal Communications commission. The acceptance letter from the FCC is maintained in our files. Registration No.: 744189.

Industry Canada (IC) —Registration No.:5205A

The EMC Laboratory has been registered by Certification and Engineering Bureau of Industry Canada for radio equipment testing with Registration No.: 5205A.

A2LA (Certification Number:5013.01)

The EMC Laboratory has been accredited by the American Association for Laboratory Accreditation (A2LA). Certification Number:5013.01

CAB identifier: CN0033

The report refers only to the sample tested and does not apply to the bulk.

This report is issued in confidence to the client and it will be strictly treated as such by the SHENZHEN TIMEWAY TESTING LABORATORIES. It may not be reproduced rather in its entirety or in part and it may not be used for adverting. The client to whom the report is issued may, however, show or send it . or a certified copy there of prepared by the SHENZHEN TIMEWAY TESTING LABORATORIES. to his customer. Supplier or others persons directly concerned. SHENZHEN TIMEWAY TESTING LABORATORIES. will not, without the consent of the client enter into any discussion of correspondence with any third party concerning the contents of the report. In the event of the improper use of the report. The SHENZHEN TIMEWAY TESTING LABORATORIES. reserves the rights to withdraw it and to adopt any other remedies which may be appropriate.



Test Report Conclusion

Content

1.0	General Details	4
1.1	Test Lab Details.....	4
1.2	Applicant Details.....	4
1.3	Description of EUT	4
1.4	Submitted Sample.....	4
1.5	Test Duration.....	4
1.6	Test Uncertainty.....	5
1.7	Test By.....	5
2.0	List of Measurement Equipment	5
3.0	Technical Details	6
3.1	Summary of Test Results.....	6
3.2	Test Standards.....	6
4.0	EUT Modification	6
5.0	Power Line Conducted Emission Test	7
5.1	Schematics of the Test.....	7
5.2	Test Method and Test Procedure.....	7
5.3	Configuration of the EUT.....	7
5.4	EUT Operating Condition.....	8
5.5	Conducted Emission Limit.....	8
5.6	Test Result.....	8
6.0	Radiated Emission test	9
6.1	Test Method and Test Procedure.....	9
6.2	Configuration of the EUT.....	10
6.3	EUT Operation Condition.....	10
6.4	Radiated Emission Limit.....	11
6.5	Test Result.....	12
7.0	20dB Bandwidth Test	17
8.0	Deactivate Test	19
9.0	Duty Cycle	21
10.0	Antenna Requirement	26
11.0	FCC Label	27
12.0	Photo of Testing	28

The report refers only to the sample tested and does not apply to the bulk.

This report is issued in confidence to the client and it will be strictly treated as such by the SHENZHEN TIMEWAY TESTING LABORATORIES. It may not be reproduced rather in its entirety or in part and it may not be used for advertising. The client to whom the report is issued may, however, show or send it, or a certified copy thereof prepared by the SHENZHEN TIMEWAY TESTING LABORATORIES, to his customer. Supplier or others persons directly concerned. SHENZHEN TIMEWAY TESTING LABORATORIES, will not, without the consent of the client enter into any discussion of correspondence with any third party concerning the contents of the report.

In the event of the improper use of the report. The SHENZHEN TIMEWAY TESTING LABORATORIES, reserves the rights to withdraw it and to adopt any other remedies which may be appropriate.



1.0 General Details

1.1 Test Lab Details

Name: SHENZHEN TIMEWAY TESTING LABORATORIES.
Address: Zone C, 1st Floor, Block B, Jun Xiang Da Building, Zhongshan Park Road West, Tong Le Village, Nanshan District, Shenzhen, China
Telephone: +86 755 83448688
Fax: +86 755 83442996
Site on File with the Federal Communications Commission – United States
Registration Number: 744189
For 3m Anechoic Chamber

1.2 Applicant Details

Applicant: DawnSun Electronic Technology Co., Ltd. Zhongshan
Address: 8# Nanyi Street, Xinggong Road, Longxing Industrial District, Shaxi Town, Zhongshan, Guangdong, China 528471
Telephone: (86)0760-87336328
Fax: 0760-87332108

1.3 Description of EUT

Product: Remote Control – Transmitter
Manufacturer: DawnSun Electronic Technology Co., Ltd. Zhongshan
Address: 8# Nanyi Street, Xinggong Road, Longxing Industrial District, Shaxi Town, Zhongshan, Guangdong, China 528471
Trademark: N/A
Model Number: TX015
Additional Model Name: N/A
Additional Trademark: N/A
Rating: DC12V, (1pc 23A battery)
Operation Frequency: 433.92MHz
Modulation Type: OOK
Hardware Version: 015-V1
Software Version: TX015-0154
Serial No.: TX015202308010001
Antenna Designation: PCB Antenna with Gain 0dBi (Get from the antenna specification)

1.4 Submitted Sample: 2 Samples

1.5 Test Duration

The report refers only to the sample tested and does not apply to the bulk.

This report is issued in confidence to the client and it will be strictly treated as such by the SHENZHEN TIMEWAY TESTING LABORATORIES. It may not be reproduced rather in its entirety or in part and it may not be used for advertising. The client to whom the report is issued may, however, show or send it, or a certified copy thereof prepared by the SHENZHEN TIMEWAY TESTING LABORATORIES, to his customer. Supplier or others persons directly concerned. SHENZHEN TIMEWAY TESTING LABORATORIES, will not, without the consent of the client enter into any discussion of correspondence with any third party concerning the contents of the report.

In the event of the improper use of the report. The SHENZHEN TIMEWAY TESTING LABORATORIES, reserves the rights to withdraw it and to adopt any other remedies which may be appropriate.



2.2 Automation Test Software

For Conducted Emission Test

Name	Version
EZ-EMC	Ver.EMC-CON 3A1.1

For Radiated Emissions

Name	Version
EMI Test Software BL410-EV18.91	V18.905
EMI Test Software BL410-EV18.806 High Frequency	V18.06

3.0 Technical Details

3.1 Summary of test results

The EUT has been tested according to the following specifications:			
Standard	Test Type	Result	Notes
FCC Part 15, Paragraph 15.203	Antenna requirements	Pass	Compliant
FCC Part 15, Paragraph 15.207	Conducted Emission Test	N/A	N/A
FCC Part 15, Paragraph 15.209	General Requirement	Pass	Compliant
FCC Part 15, Paragraph 15.231 (b)	Radiated Emission Test	Pass	Compliant
FCC Part 15, Paragraph 15.231 (c)	20dB Bandwidth Testing	Pass	Compliant
FCC Part 15, Paragraph 15.231 (a1)	Deactivate Testing	Pass	Compliant

3.2 Test Standards

FCC Part 15 Subpart C, Paragraph 15.231 , ANSI C63.4 :2014 and ANSI C63.10 :2013

4.0 EUT Modification

No modification by SHENZHEN TIMEWAY TESTING LABORATORIES

The report refers only to the sample tested and does not apply to the bulk.

This report is issued in confidence to the client and it will be strictly treated as such by the SHENZHEN TIMEWAY TESTING LABORATORIES. It may not be reproduced rather in its entirety or in part and it may not be used for advertising. The client to whom the report is issued may, however, show or send it . or a certified copy there of prepared by the SHENZHEN TIMEWAY TESTING LABORATORIES. to his customer. Supplier or others persons directly concerned. SHENZHEN TIMEWAY TESTING LABORATORIES. will not, without the consent of the client enter into any discussion of correspondence with any third party concerning the contents of the report. In the event of the improper use of the report. The SHENZHEN TIMEWAY TESTING LABORATORIES. reserves the rights to withdraw it and to adopt any other remedies which may be appropriate.



5.0 Power Line Conducted Emission Test

5.1 Schematics of the test

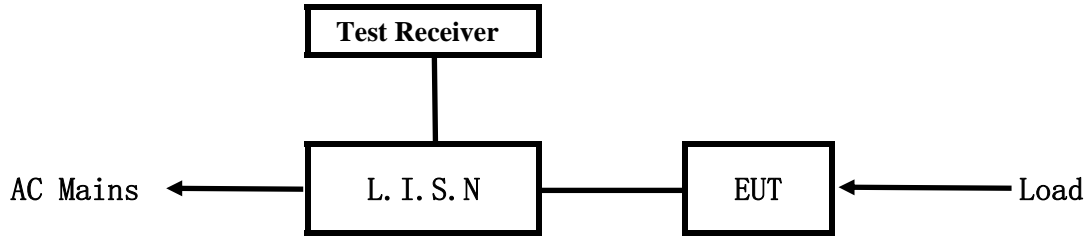

EUT: Equipment Under Test

5.2 Test Method and test Procedure

The EUT was tested according to ANSI C63.10-2013. The Frequency spectrum from 0.15MHz to 30MHz was investigated. The LISN used was 50ohm/50uH as specified by section 5.1 of ANSI C63.10-2013.

Test Voltage: N/A

Block diagram of Test setup

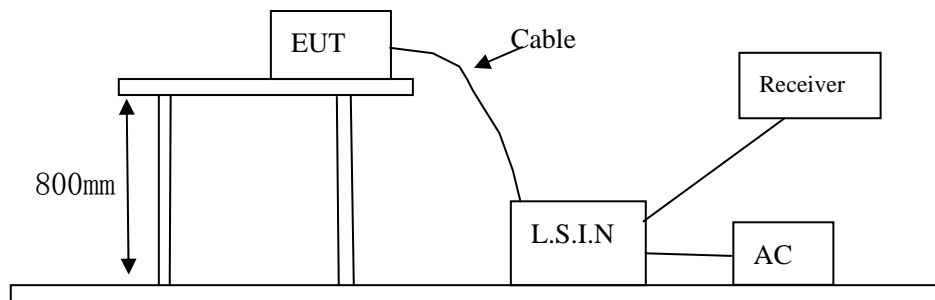

5.3 Configuration of the EUT

The EUT was configured according to ANSI C63.10-2013. All interface ports were connected to the appropriate peripherals. All peripherals and cables are listed below.

A. EUT

Device	Manufacturer	Model	FCC ID
Remote Control – Transmitter	DawnSun Electronic Technology Co., Ltd. Zhongshan	TX015	A25-TX015A

B. Internal Device

Device	Manufacturer	Model	FCC ID/DOC
N/A			

C. Peripherals

Device	Manufacturer	Model	FCC ID/DOC	Cable
N/A				

The report refers only to the sample tested and does not apply to the bulk.

This report is issued in confidence to the client and it will be strictly treated as such by the SHENZHEN TIMEWAY TESTING LABORATORIES. It may not be reproduced rather in its entirety or in part and it may not be used for advertising. The client to whom the report is issued may, however, show or send it, or a certified copy thereof prepared by the SHENZHEN TIMEWAY TESTING LABORATORIES, to his customer. Supplier or others persons directly concerned. SHENZHEN TIMEWAY TESTING LABORATORIES, will not, without the consent of the client enter into any discussion of correspondence with any third party concerning the contents of the report.

In the event of the improper use of the report. The SHENZHEN TIMEWAY TESTING LABORATORIES, reserves the rights to withdraw it and to adopt any other remedies which may be appropriate.



5.4 EUT Operating Condition

Operating condition is according to ANSI C63.10-2013.

A Setup the EUT and simulators as shown on follow

B Enable AF signal and confirm EUT active to normal condition

5.5 Power line conducted Emission Limit according to Paragraph 15.207

Frequency (MHz)	Limits (dB μ V)	
	Quasi-peak Level	Average Level
0.15 ~ 0.50	66.0~56.0*	56.0~46.0*
0.50 ~ 5.00	56.	46.0
5.00 ~ 30.00	60.0	50.0

- Notes:
1. *Decreasing linearly with logarithm of frequency.
 2. The tighter limit shall apply at the transition frequencies

5.6 Test Results

N/A

The frequency spectrum from 0.15MHz to 30MHz was investigated. All reading are quasi-peak values with a resolution bandwidth of 9kHz. (The average detector is necessary when the Quasi-peak emission level beyond the average Limit.)

Note: Due to A23 Battery operation, this test item not applicable.

The report refers only to the sample tested and does not apply to the bulk.

This report is issued in confidence to the client and it will be strictly treated as such by the SHENZHEN TIMEWAY TESTING LABORATORIES. It may not be reproduced rather in its entirety or in part and it may not be used for advertising. The client to whom the report is issued may, however, show or send it, or a certified copy thereof prepared by the SHENZHEN TIMEWAY TESTING LABORATORIES, to his customer. Supplier or others persons directly concerned. SHENZHEN TIMEWAY TESTING LABORATORIES, will not, without the consent of the client enter into any discussion of correspondence with any third party concerning the contents of the report.

In the event of the improper use of the report. The SHENZHEN TIMEWAY TESTING LABORATORIES, reserves the rights to withdraw it and to adopt any other remedies which may be appropriate.



6 Radiated Emission Test

6.1 Test Method and test Procedure:

- (1) The EUT was tested according to ANSI C63.10-2013. The radiated test was performed at TIMEWAY EMC Laboratory. This site is on file with the FCC laboratory division, Registration No.744189
- (2) The EUT, peripherals were put on the turntable which table size is 1m x 1.5 m, table high 0.8 m. All set up is according to ANSI C63.10-2013.
- (3) The frequency spectrum from 30 MHz to 5 GHz was investigated. All readings from 30 MHz to 1 GHz are quasi-peak values with a resolution bandwidth of 120 kHz. All readings are above 1 GHz, peak values with a resolution bandwidth of 1 MHz. Measurements were made at 3 meters.
- (4) The antenna high is varied from 1 m to 4 m high to find the maximum emission for each frequency.
- (5) Maximizing procedure was performed on the six (6) highest emissions to ensure EUT compliance is with all installation combinations. All data was recorded in the peak detection mode. Quasi-peak readings was performed only when an emission was found to be marginal (within -4 dB of specification limit), and are distinguished with a "QP" in the data table.
- (6) The antenna polarization: Vertical polarization and Horizontal polarization.

Block diagram of Test setup

For radiated emissions from 9kHz to 30MHz

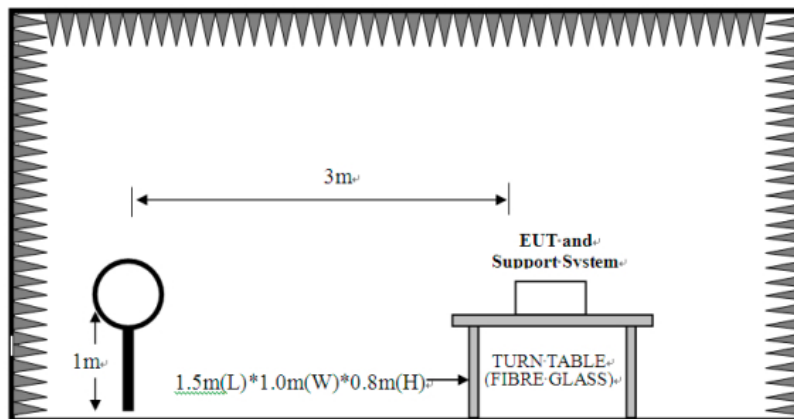

The report refers only to the sample tested and does not apply to the bulk.

This report is issued in confidence to the client and it will be strictly treated as such by the SHENZHEN TIMEWAY TESTING LABORATORIES. It may not be reproduced in its entirety or in part and it may not be used for advertising. The client to whom the report is issued may, however, show or send it, or a certified copy thereof prepared by the SHENZHEN TIMEWAY TESTING LABORATORIES, to his customer. Supplier or others persons directly concerned. SHENZHEN TIMEWAY TESTING LABORATORIES, will not, without the consent of the client enter into any discussion of correspondence with any third party concerning the contents of the report.

In the event of the improper use of the report, the SHENZHEN TIMEWAY TESTING LABORATORIES, reserves the rights to withdraw it and to adopt any other remedies which may be appropriate.



For radiated emissions from 30MHz to 1GHz

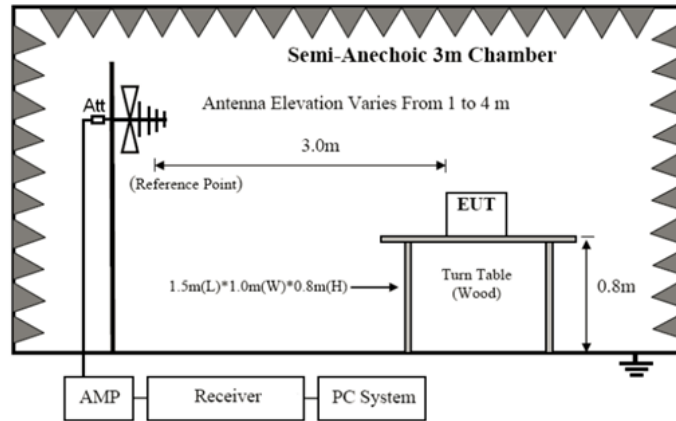

For radiated emissions above 1GHz

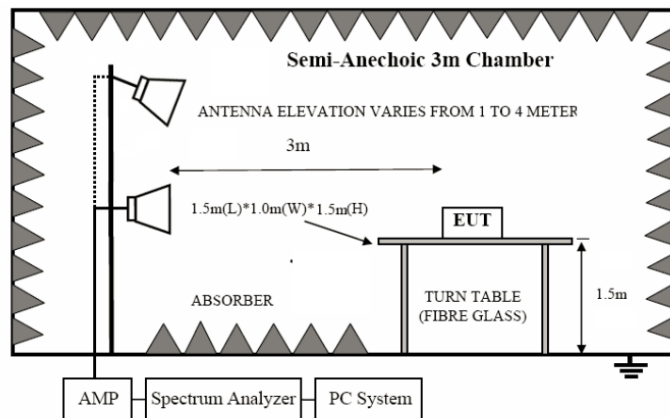

6.2 Configuration of the EUT
Same as section 5.3 of this report

6.3 EUT Operating Condition
Same as section 5.4 of this report.

The report refers only to the sample tested and does not apply to the bulk.
This report is issued in confidence to the client and it will be strictly treated as such by the SHENZHEN TIMEWAY TESTING LABORATORIES. It may not be reproduced rather in its entirety or in part and it may not be used for advertising. The client to whom the report is issued may, however, show or send it . or a certified copy there of prepared by the SHENZHEN TIMEWAY TESTING LABORATORIES. to his customer. Supplier or others persons directly concerned. SHENZHEN TIMEWAY TESTING LABORATORIES. will not, without the consent of the client enter into any discussion of correspondence with any third party concerning the contents of the report.
In the event of the improper use of the report. The SHENZHEN TIMEWAY TESTING LABORATORIES. reserves the rights to withdraw it and to adopt any other remedies which may be appropriate.



6.4 Radiated Emission Limit

All emission from a digital device, including any network of conductors and apparatus connected thereto, shall not exceed the level of field strength specified below:

A FCC Part 15 Subpart C Paragraph 15.231(a) Limit

Fundamental Frequency (MHz)	Field Strength of Fundamental		Field Strength of Spurious Emission	
	uV/m	dBuV/m	uV/m	dBuV/m
40.66-40.70	2250	67.04	225	47.04
70-130	1250	61.94	125	41.94
130-174	1250-3750	61.94-71.48	125-375	41.94-51.48
174-260	3750	71.48	375	51.48
260-470	3750-12500	71.48-81.94	375-1250	51.48-61.94
Above 470	12500	81.94	1250	61.94

- Note:
1. RF Field Strength (dBuV) = 20 log RF Voltage (uV)
 - 2.Distance refers to the distance in meters between the measuring instrument antenna and the closed point of any part of the device or system.
 3. The emission limit in this paragraph is based on measurement instrumentation employing an average detector.
 - 4.Linear interpolations for frequency ranges 130-174MHz and 260-470MHz
 - 5.the above field strength limits are specified at a distance of 3-meters and the tighter limits apply at the band edges
 6. New batteries were installed in the equipment under test for radiated emission testing.
 7. This is a handheld device. The radiated emissions should be tested under 3-axes position (Lying, Side, and Stand), After pre-test. It was found that the worse radiated emission was get at the lying position.

The report refers only to the sample tested and does not apply to the bulk.
 This report is issued in confidence to the client and it will be strictly treated as such by the SHENZHEN TIMEWAY TESTING LABORATORIES. It may not be reproduced rather in its entirety or in part and it may not be used for adverting. The client to whom the report is issued may, however, show or send it . or a certified copy there of prepared by the SHENZHEN TIMEWAY TESTING LABORATORIES. to his customer. Supplier or others persons directly concerned. SHENZHEN TIMEWAY TESTING LABORATORIES. will not, without the consent of the client enter into any discussion of correspondence with any third party concerning the contents of the report.
 In the event of the improper use of the report. The SHENZHEN TIMEWAY TESTING LABORATORIES. reserves the rights to withdraw it and to adopt any other remedies which may be appropriate.



B. Frequencies in restricted band are compiled to limit on Paragraph 15.209.

Frequency Range (MHz)	Distance (m)	Field strength (dB μ V/m)
30-88	3	40.0
88-216	3	43.5
216-960	3	46.0
Above 960	3	54.0

- Note:
1. RF Voltage (dBuV) = 20 log RF Voltage (uV)
 2. In the Above Table, the tighter limit applies at the band edges.
 3. Distance refers to the distance in meters between the measuring instrument antenna and the EUT
 4. All scanning using PK detector. And the final emission level was get using QP detector for frequency range from 30-1000MHz.As to 1G-5G, the final emission level got using PK detector. And Average = peak(dBuV/m) – duty cycle(dB)

6.5 Test result

A Fundamental and Harmonics Radiated emission data

Product:	Remote Control – Transmitter	Test Mode:	Keep Transmitting
Test Item:	Fundamental Radiated Emission and Spurious Emission Data	Temperature:	25°C
Test Voltage:	DC12V	Humidity:	56%
Test Result:	Pass		
Frequency (MHz)	Emission PK/AV (dBuV/m)	Horizontal / Vertical	Limits PK/AV (dBuV/m)
433.92	69.21 (PK)/ 60.05 (AV)	H	100.8/80.6
433.92	62.35 (PK)/ 53.19 (AV)	V	100.8/80.6
867.84	56.40 (PK)/ 47.24 (AV)	H	80.8/60.6
867.84	46.01 (PK)/ 36.85 (AV)	V	80.8/60.6
1301.76	47.21 (PK)/ 38.05 (AV)	H	74/54
1301.76	47.24 (PK)/ 38.08 (AV)	V	74/54
1735.68	52.87 (PK)/ 43.71 (AV)	H	80.8/60.6
1735.68	46.99 (PK)/ 37.83 (AV)	V	80.8/60.6
2169.6	53.84 (PK)/ 44.68 (AV)	H	80.8/60.6
2169.6	51.26 (PK)/ 42.10 (AV)	V	80.8/60.6
2603.52	53.82 (PK)/ 44.66 (AV)	H	80.8/60.6
2603.52	53.35 (PK)/ 44.19 (AV)	V	80.8/60.6
3037.44	--	H	80.8/60.6
3037.44	47.38 (PK)/ 38.22 (AV)	V	80.8/60.6
3471.36	54.22 (PK)/ 45.06 (AV)	H	80.8/60.6

The report refers only to the sample tested and does not apply to the bulk.

This report is issued in confidence to the client and it will be strictly treated as such by the SHENZHEN TIMEWAY TESTING LABORATORIES. It may not be reproduced rather in its entirety or in part and it may not be used for advertising. The client to whom the report is issued may, however, show or send it . or a certified copy there of prepared by the SHENZHEN TIMEWAY TESTING LABORATORIES. to his customer. Supplier or others persons directly concerned. SHENZHEN TIMEWAY TESTING LABORATORIES. will not, without the consent of the client enter into any discussion of correspondence with any third party concerning the contents of the report.

In the event of the improper use of the report. The SHENZHEN TIMEWAY TESTING LABORATORIES. reserves the rights to withdraw it and to adopt any other remedies which may be appropriate.



3471.36	51.76 (PK)/ 42.60 (AV)	V	80.8/60.6
3905.28	--	H/V	74/54
4339.2	52.97 (PK)/ 43.81 (AV)	H	74/54
4339.2	--	V	74/54

Note: H=Horizontal, V=Vertical, AV=PK- | duty cycle factor | =PK -9.16

B. General Radiated Emission Data
Radiated Emission In Horizontal (30MHz----1000MHz)

EUT set Condition: Keep Transmitting

Results: Pass

Please refer to following diagram for individual

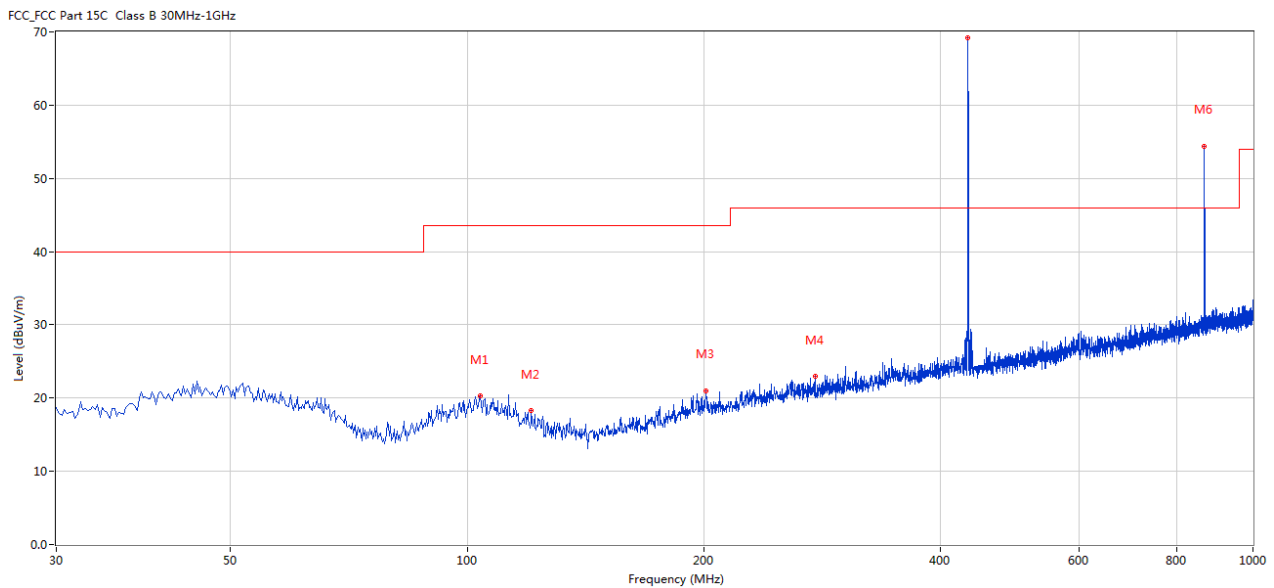

No.	Frequency (MHz)	Results (dBuV/m)	Factor (dB)	Limit (dBuV/m)	Over Limit (dB)	Detector	Table (o)	Height (cm)	ANT	Verdict
1	103.944	20.31	-13.33	43.5	23.19	Peak	199.00	100	Horizontal	Pass
2	120.672	18.27	-15.49	43.5	25.23	Peak	298.00	100	Horizontal	Pass
3	201.162	21.02	-13.43	43.5	22.48	Peak	127.00	100	Horizontal	Pass
4	277.046	22.93	-11.54	46.0	23.07	Peak	127.00	100	Horizontal	Pass
5	433.904	69.21	-8.03	46.0	-23.21	Peak	162.00	100	Horizontal	N/A
6	867.871	56.40	-2.31	46.0	-10.40	Peak	1.00	100	Horizontal	N/A

The report refers only to the sample tested and does not apply to the bulk.
 This report is issued in confidence to the client and it will be strictly treated as such by the SHENZHEN TIMEWAY TESTING LABORATORIES. It may not be reproduced rather in its entirety or in part and it may not be used for advertising. The client to whom the report is issued may, however, show or send it, or a certified copy thereof prepared by the SHENZHEN TIMEWAY TESTING LABORATORIES, to his customer. Supplier or others persons directly concerned. SHENZHEN TIMEWAY TESTING LABORATORIES, will not, without the consent of the client enter into any discussion of correspondence with any third party concerning the contents of the report.
 In the event of the improper use of the report. The SHENZHEN TIMEWAY TESTING LABORATORIES, reserves the rights to withdraw it and to adopt any other remedies which may be appropriate.



B. General Radiated Emission Data

Radiated Emission In Vertical (30MHz----1000MHz)

EUT set Condition: Keep Transmitting

Results: Pass

Please refer to following diagram for individual

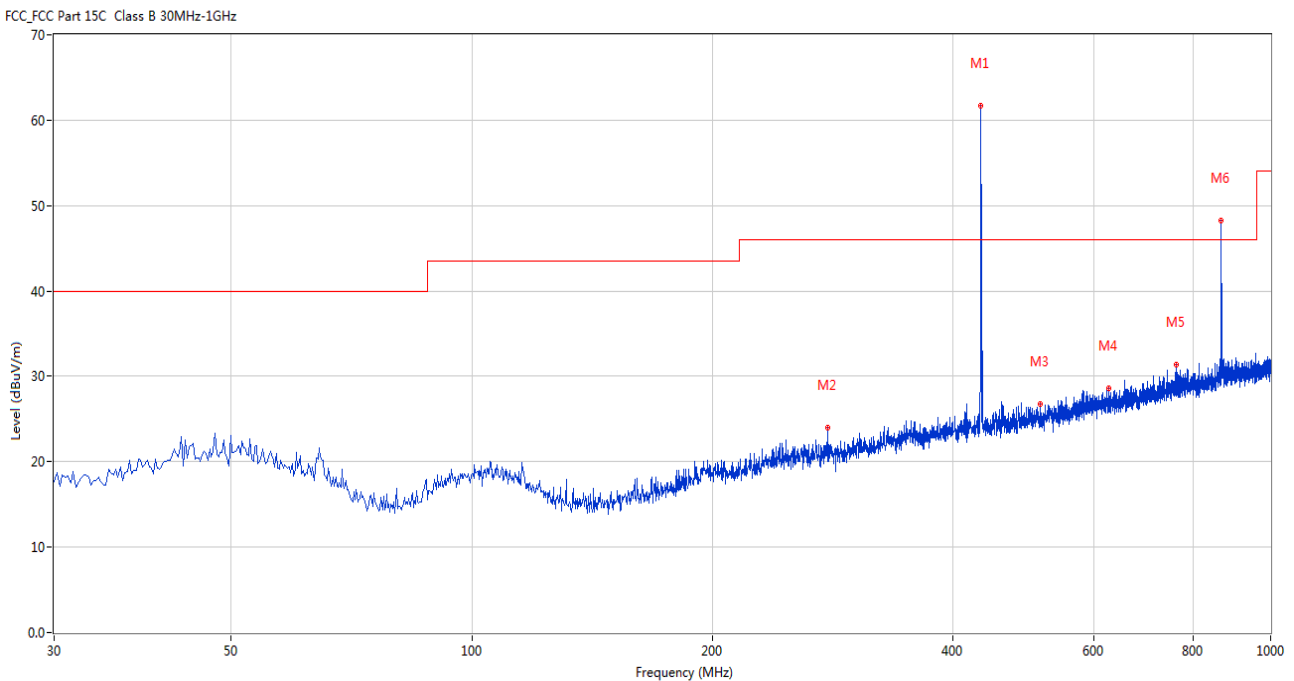

No.	Frequency (MHz)	Results (dBuV/m)	Factor (dB)	Limit (dBuV/m)	Over Limit (dB)	Detector	Table (o)	Height (cm)	ANT	Verdict
1	433.904	62.35	-8.03	46.0	-16.35	Peak	151.00	100	Vertical	N/A
2	278.743	23.95	-11.56	46.0	22.05	Peak	332.00	100	Vertical	Pass
3	514.636	26.71	-6.93	46.0	19.29	Peak	303.00	100	Vertical	Pass
4	627.371	28.62	-5.00	46.0	17.38	Peak	151.00	100	Vertical	Pass
5	762.409	31.31	-3.26	46.0	14.69	Peak	73.00	100	Vertical	Pass
6	867.871	48.23	-2.31	46.0	-2.23	Peak	360.00	100	Vertical	N/A

The report refers only to the sample tested and does not apply to the bulk.

This report is issued in confidence to the client and it will be strictly treated as such by the SHENZHEN TIMEWAY TESTING LABORATORIES. It may not be reproduced in its entirety or in part and it may not be used for advertising. The client to whom the report is issued may, however, show or send it, or a certified copy thereof prepared by the SHENZHEN TIMEWAY TESTING LABORATORIES, to his customer. Supplier or others persons directly concerned. SHENZHEN TIMEWAY TESTING LABORATORIES, will not, without the consent of the client enter into any discussion of correspondence with any third party concerning the contents of the report.

In the event of the improper use of the report. The SHENZHEN TIMEWAY TESTING LABORATORIES, reserves the rights to withdraw it and to adopt any other remedies which may be appropriate.



Test Plot above 1G

Horizontal

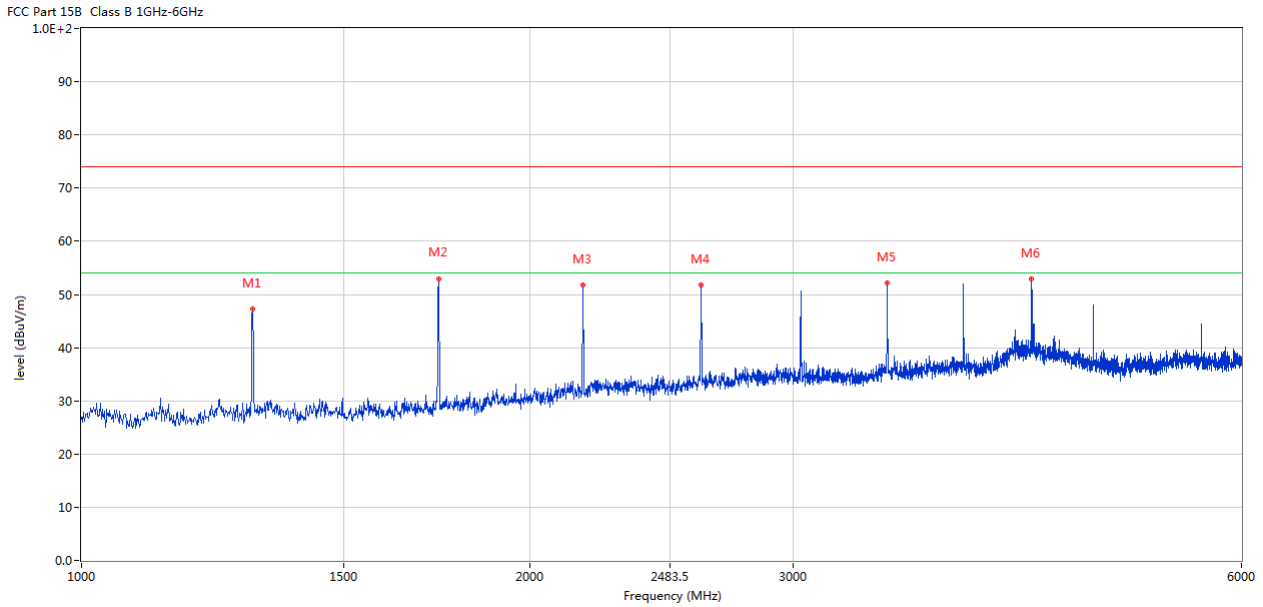

No.	Frequency (MHz)	Results (dBuV/m)	Factor (dB)	Limit (dBuV/m)	Over Limit (dB)	Detector	Table (o)	Height (cm)	ANT	Verdict
1	1302.424	47.21	-8.24	74.0	-26.79	Peak	6.00	100	Horizontal	Pass
2	1736.066	52.87	-7.28	74.0	-21.13	Peak	0.00	100	Horizontal	Pass
3	2169.708	53.84	-3.55	74.0	-20.16	Peak	6.00	100	Horizontal	Pass
4	2603.349	53.82	-3.31	74.0	-20.18	Peak	18.00	100	Horizontal	Pass
5	3471.882	54.22	-1.28	74.0	-19.78	Peak	29.00	100	Horizontal	Pass
6	4339.165	52.97	1.90	74.0	-21.03	Peak	6.00	100	Horizontal	Pass

The report refers only to the sample tested and does not apply to the bulk.

This report is issued in confidence to the client and it will be strictly treated as such by the SHENZHEN TIMEWAY TESTING LABORATORIES. It may not be reproduced rather in its entirety or in part and it may not be used for advertising. The client to whom the report is issued may, however, show or send it, or a certified copy thereof prepared by the SHENZHEN TIMEWAY TESTING LABORATORIES, to his customer. Supplier or others persons directly concerned. SHENZHEN TIMEWAY TESTING LABORATORIES, will not, without the consent of the client enter into any discussion of correspondence with any third party concerning the contents of the report.

In the event of the improper use of the report. The SHENZHEN TIMEWAY TESTING LABORATORIES, reserves the rights to withdraw it and to adopt any other remedies which may be appropriate.



Vertical

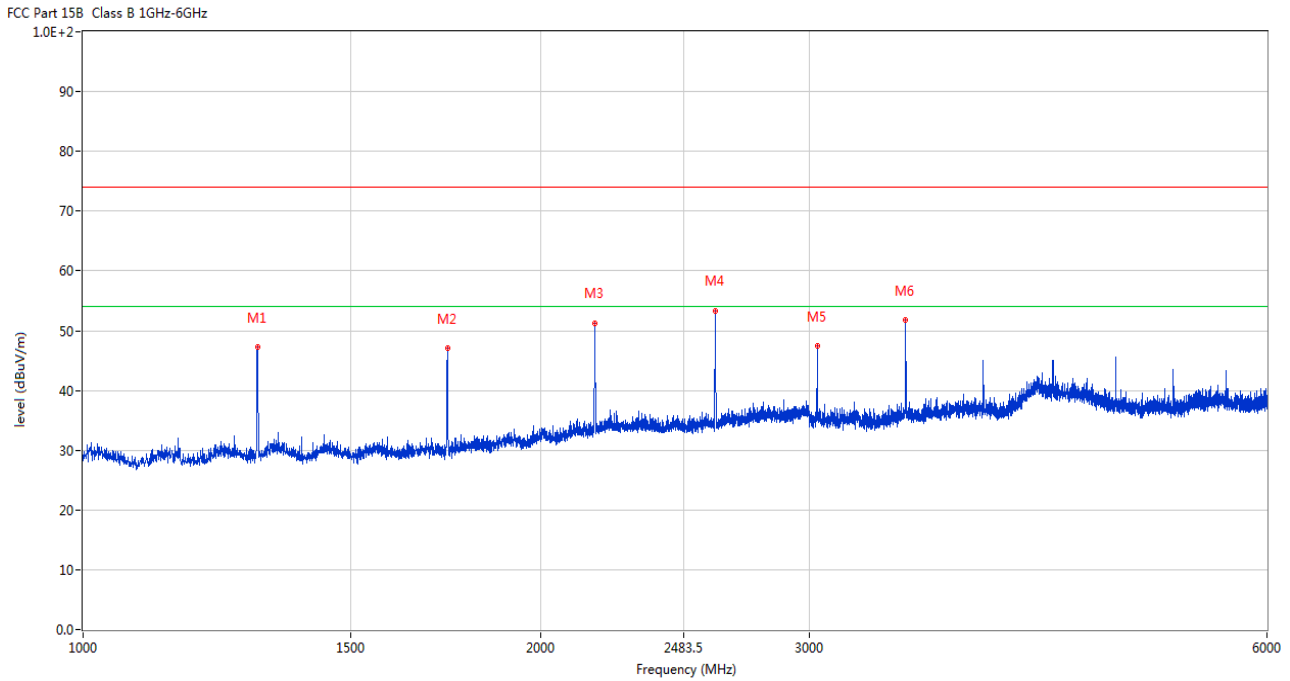

No.	Frequency (MHz)	Results (dBuV/m)	Factor (dB)	Limit (dBuV/m)	Over Limit (dB)	Detector	Table (o)	Height (cm)	ANT	Verdict
1	1301.925	47.24	-8.24	74.0	-26.76	Peak	126.00	100	Vertical	Pass
2	1735.816	46.99	-7.28	74.0	-27.01	Peak	57.00	100	Vertical	Pass
3	2169.708	51.26	-3.55	74.0	-22.74	Peak	337.00	100	Vertical	Pass
4	2603.599	53.35	-3.31	74.0	-20.65	Peak	352.00	100	Vertical	Pass
5	3037.491	47.38	-2.47	74.0	-26.62	Peak	326.00	100	Vertical	Pass
6	3471.632	51.76	-1.28	74.0	-22.24	Peak	360.00	100	Vertical	Pass

The report refers only to the sample tested and does not apply to the bulk.

This report is issued in confidence to the client and it will be strictly treated as such by the SHENZHEN TIMEWAY TESTING LABORATORIES. It may not be reproduced in its entirety or in part and it may not be used for advertising. The client to whom the report is issued may, however, show or send it, or a certified copy thereof prepared by the SHENZHEN TIMEWAY TESTING LABORATORIES, to his customer. Supplier or others persons directly concerned. SHENZHEN TIMEWAY TESTING LABORATORIES, will not, without the consent of the client enter into any discussion of correspondence with any third party concerning the contents of the report.

In the event of the improper use of the report. The SHENZHEN TIMEWAY TESTING LABORATORIES, reserves the rights to withdraw it and to adopt any other remedies which may be appropriate.



7.0 20dB Bandwidth Testing

7.1 Requirement

Per 15.231(c), the bandwidth of the emission shall be no wider than 0.25% of the center frequency for devices operating above 70 MHz and below 900 MHz. Bandwidth is determined at the points 20 dB down from the modulated carrier.

7.2 Test Procedure

With the EUT's antenna attached, the EUT's 20dB Bandwidth power was received by the test antenna which was connected to the spectrum analyzer with the START and STOP frequencies set to the EUT's operation band.

7.3 Test Data

Frequency (MHz)	20dB Bandwidth Emission (kHz)	Limit (kHz)	Result
433.92	178.36	1084.8	Pass

$$\text{Limit} = \text{Frequency} \times 0.25\% = 433.92 \times 0.25\% = 1084.8 \text{ kHz}$$

Refer to attached plots:

The report refers only to the sample tested and does not apply to the bulk.

This report is issued in confidence to the client and it will be strictly treated as such by the SHENZHEN TIMEWAY TESTING LABORATORIES. It may not be reproduced rather in its entirety or in part and it may not be used for advertising. The client to whom the report is issued may, however, show or send it, or a certified copy thereof prepared by the SHENZHEN TIMEWAY TESTING LABORATORIES, to his customer. Supplier or others persons directly concerned. SHENZHEN TIMEWAY TESTING LABORATORIES, will not, without the consent of the client enter into any discussion of correspondence with any third party concerning the contents of the report.

In the event of the improper use of the report. The SHENZHEN TIMEWAY TESTING LABORATORIES, reserves the rights to withdraw it and to adopt any other remedies which may be appropriate.



20dB Bandwidth



Ref Lvl	Marker 1 [T1 ndB]	RBW	30 kHz	RF Att	20 dB
10 dBm	ndB 20.00 dB	VBW	100 kHz		
	BW 178.35671343 kHz	SWT	5 ms	Unit	dBm

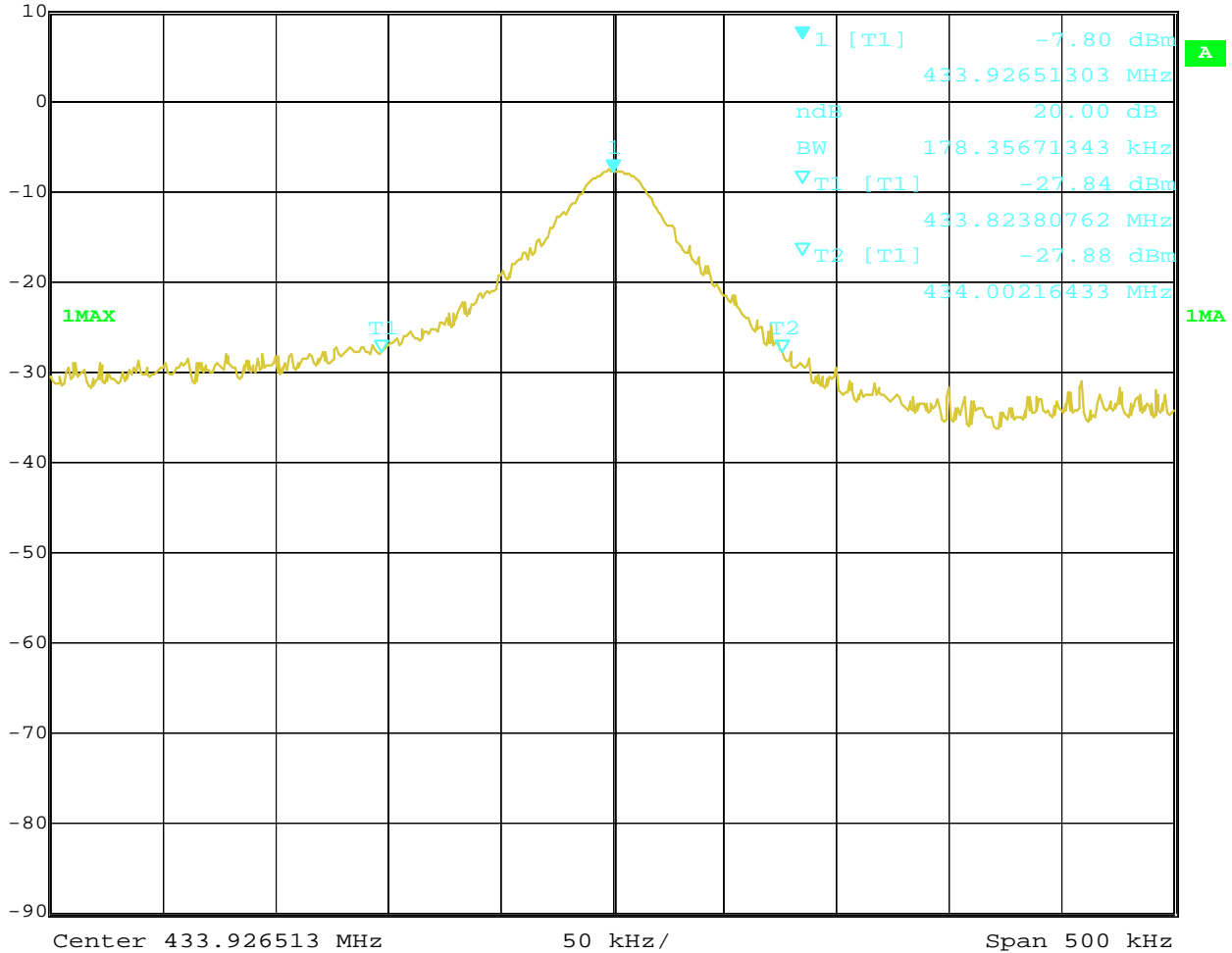

Date: 10.AUG.2023 17:54:41

The report refers only to the sample tested and does not apply to the bulk.
 This report is issued in confidence to the client and it will be strictly treated as such by the SHENZHEN TIMEWAY TESTING LABORATORIES. It may not be reproduced rather in its entirety or in part and it may not be used for advertising. The client to whom the report is issued may, however, show or send it . or a certified copy there of prepared by the SHENZHEN TIMEWAY TESTING LABORATORIES. to his customer. Supplier or others persons directly concerned. SHENZHEN TIMEWAY TESTING LABORATORIES. will not, without the consent of the client enter into any discussion of correspondence with any third party concerning the contents of the report.
 In the event of the improper use of the report. The SHENZHEN TIMEWAY TESTING LABORATORIES. reserves the rights to withdraw it and to adopt any other remedies which may be appropriate.



8.0 Deactivate Test

8.1 Requirement

Per 15.231(a) (1)

A manually operated transmitter shall employ a switch that will automatically deactivate the transmitter within not more than 5 seconds of being released.

8.2 Radiated Test Setup

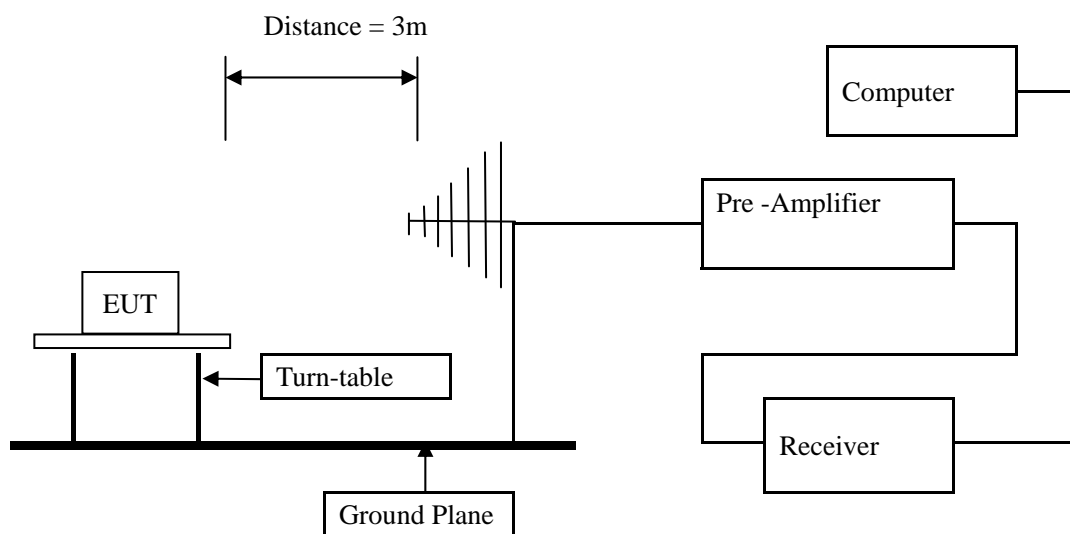

For the actual test configuration, please refer to the related items – Photos of Testing

The deactivation test was performed in the 3 meters chamber B test site, using the setup accordance with the ANSI C63.10-2013. The specification used was the FCC 15.231(e) limits.

8.3 Test Procedure

Maximizing procedure was performed on the highest emissions to ensure that the EUT complied with all installation combinations.

The report refers only to the sample tested and does not apply to the bulk.

This report is issued in confidence to the client and it will be strictly treated as such by the SHENZHEN TIMEWAY TESTING LABORATORIES. It may not be reproduced in its entirety or in part and it may not be used for advertising. The client to whom the report is issued may, however, show or send it, or a certified copy thereof prepared by the SHENZHEN TIMEWAY TESTING LABORATORIES, to his customer, supplier or other persons directly concerned. SHENZHEN TIMEWAY TESTING LABORATORIES will not, without the consent of the client, enter into any discussion of correspondence with any third party concerning the contents of the report.

In the event of the improper use of the report, the SHENZHEN TIMEWAY TESTING LABORATORIES reserves the rights to withdraw it and to adopt any other remedies which may be appropriate.



8.4 Test Data

Refer to attached plots:

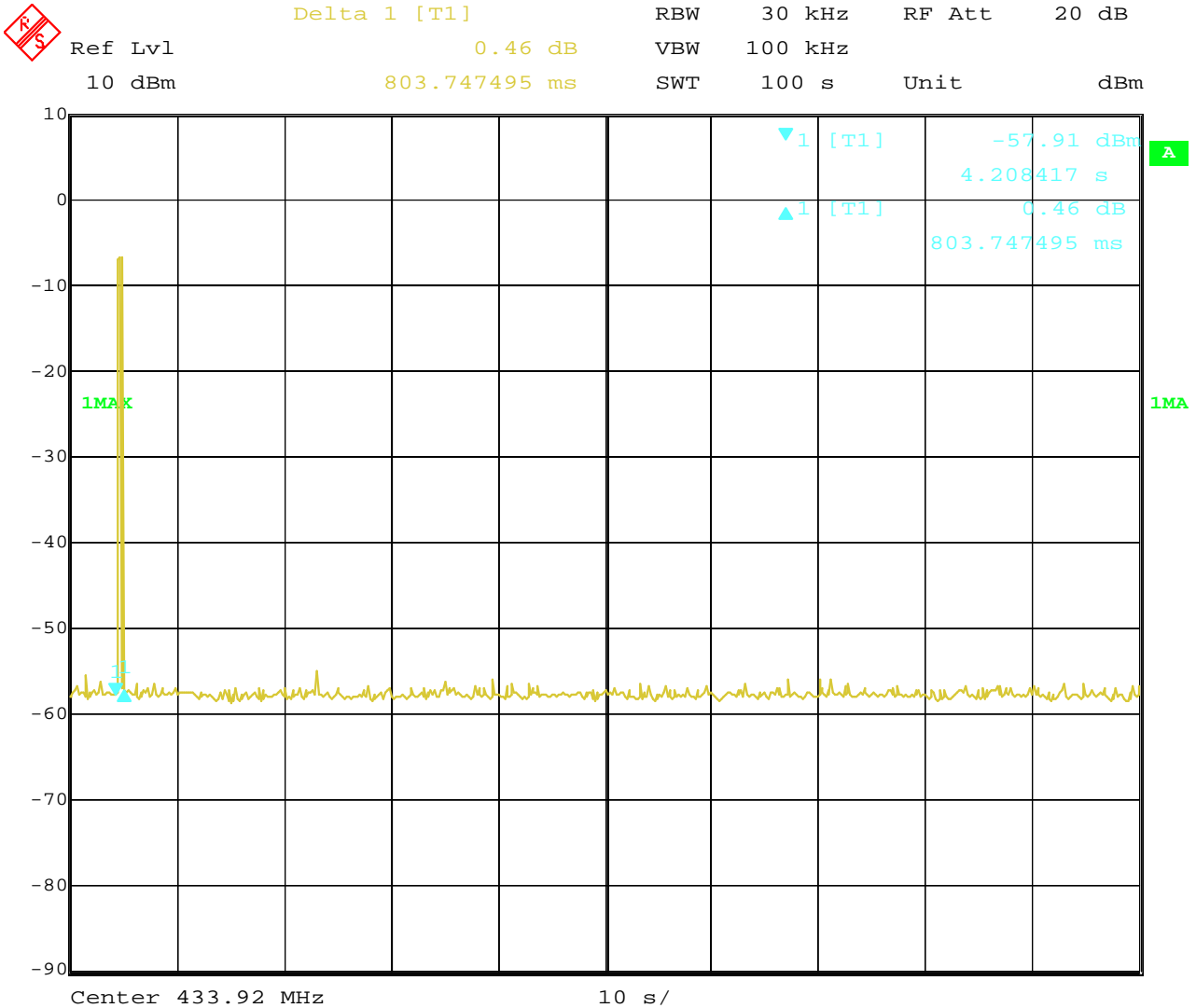

Date: 10.AUG.2023 17:53:27

8.5 Test result

Pass

The report refers only to the sample tested and does not apply to the bulk.
 This report is issued in confidence to the client and it will be strictly treated as such by the SHENZHEN TIMEWAY TESTING LABORATORIES. It may not be reproduced rather in its entirety or in part and it may not be used for advertising. The client to whom the report is issued may, however, show or send it, or a certified copy thereof prepared by the SHENZHEN TIMEWAY TESTING LABORATORIES, to his customer. Supplier or others persons directly concerned. SHENZHEN TIMEWAY TESTING LABORATORIES, will not, without the consent of the client enter into any discussion of correspondence with any third party concerning the contents of the report.
 In the event of the improper use of the report. The SHENZHEN TIMEWAY TESTING LABORATORIES, reserves the rights to withdraw it and to adopt any other remedies which may be appropriate.



9.0 Duty Cycle

9.1 Limit

No dedicated limit specified in the Rules

9.2 Test Procedure

1. Place the EUT on the table and set it in transmitting mode.
2. Remove the antenna from the EUT and then connect a low loss RF cable from the antenna port to the spectrum analyzer.
3. Set center frequency of spectrum analyzer=operating frequency.
4. Set the spectrum analyzer as RBW = VBW=1000kHz, Span=0Hz, Adjust Sweep=100ms.
5. Repeat above procedures until all frequency measured were complete.

9.3 Test Data

Base on the worst case

$$T_p = 50.321\text{ms}$$

$$T_{on1} = 0.661 * 12 = 7.932 \text{ (ms)}$$

$$T_{on2} = 0.331 * 29 = 9.599 \text{ (ms)}$$

$$\text{Duty cycle} = T_{on} / T_p = 17.531 / 50.321 = 0.3484 = 34.84\%$$

$$\text{Duty cycle factor} = 20 * \log(\text{duty cycle}) = 20 * \log(0.3484) = -9.16\text{dB}$$

The report refers only to the sample tested and does not apply to the bulk.

This report is issued in confidence to the client and it will be strictly treated as such by the SHENZHEN TIMEWAY TESTING LABORATORIES. It may not be reproduced rather in its entirety or in part and it may not be used for advertising. The client to whom the report is issued may, however, show or send it, or a certified copy thereof prepared by the SHENZHEN TIMEWAY TESTING LABORATORIES, to his customer. Supplier or others persons directly concerned. SHENZHEN TIMEWAY TESTING LABORATORIES, will not, without the consent of the client enter into any discussion of correspondence with any third party concerning the contents of the report.

In the event of the improper use of the report. The SHENZHEN TIMEWAY TESTING LABORATORIES, reserves the rights to withdraw it and to adopt any other remedies which may be appropriate.



Testing Plots:

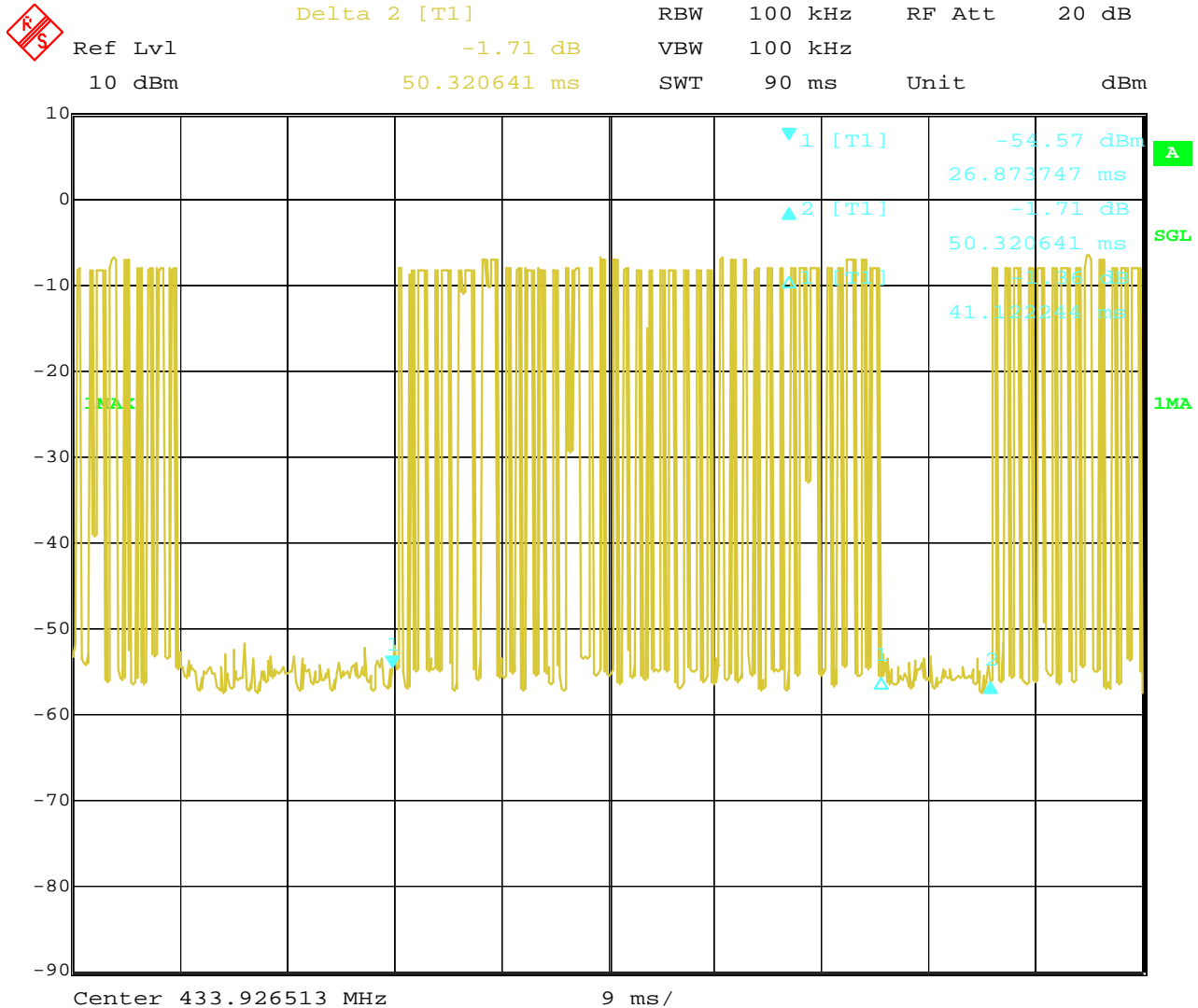

Date: 10.AUG.2023 18:01:12

The report refers only to the sample tested and does not apply to the bulk.
 This report is issued in confidence to the client and it will be strictly treated as such by the SHENZHEN TIMEWAY TESTING LABORATORIES. It may not be reproduced rather in its entirety or in part and it may not be used for advertising. The client to whom the report is issued may, however, show or send it, or a certified copy thereof prepared by the SHENZHEN TIMEWAY TESTING LABORATORIES, to his customer. Supplier or others persons directly concerned. SHENZHEN TIMEWAY TESTING LABORATORIES, will not, without the consent of the client enter into any discussion of correspondence with any third party concerning the contents of the report.
 In the event of the improper use of the report. The SHENZHEN TIMEWAY TESTING LABORATORIES, reserves the rights to withdraw it and to adopt any other remedies which may be appropriate.



	Marker 2 [T1]	RBW	100 kHz	RF Att	20 dB
Ref Lvl	-7.39 dBm	VBW	100 kHz		
10 dBm	43.987976 ms	SWT	50 ms	Unit	dBm

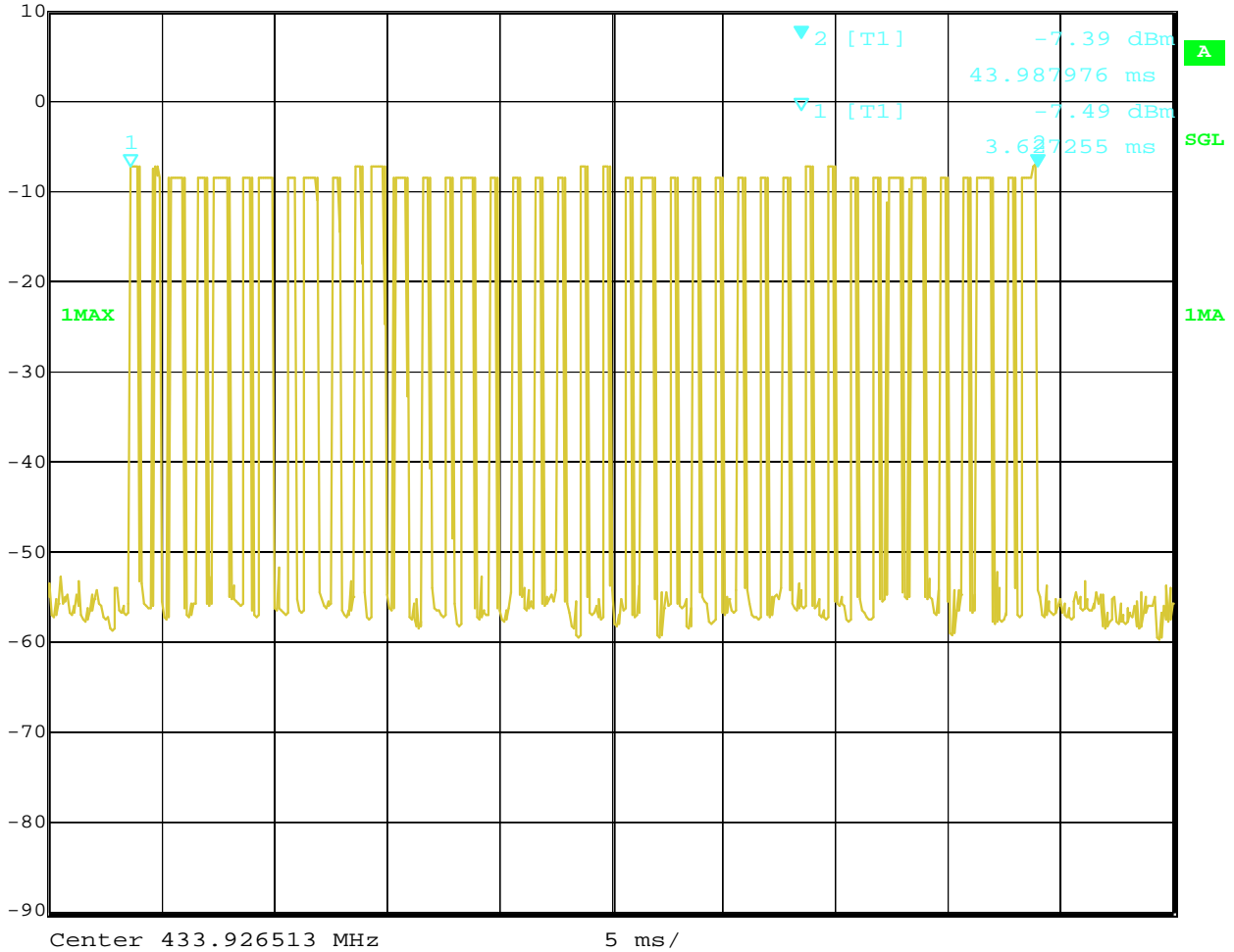

Date: 10.AUG.2023 18:01:49

The report refers only to the sample tested and does not apply to the bulk.
 This report is issued in confidence to the client and it will be strictly treated as such by the SHENZHEN TIMEWAY TESTING LABORATORIES. It may not be reproduced in its entirety or in part and it may not be used for advertising. The client to whom the report is issued may, however, show or send it, or a certified copy thereof prepared by the SHENZHEN TIMEWAY TESTING LABORATORIES, to his customer. Supplier or others persons directly concerned. SHENZHEN TIMEWAY TESTING LABORATORIES, will not, without the consent of the client enter into any discussion of correspondence with any third party concerning the contents of the report.
 In the event of the improper use of the report. The SHENZHEN TIMEWAY TESTING LABORATORIES, reserves the rights to withdraw it and to adopt any other remedies which may be appropriate.



T_{on1}



	Delta 1 [T1]	RBW	100 kHz	RF Att	20 dB
Ref Lvl	0.60 dB	VBW	100 kHz		
10 dBm	661.322645 μ s	SWT	5 ms	Unit	dBm

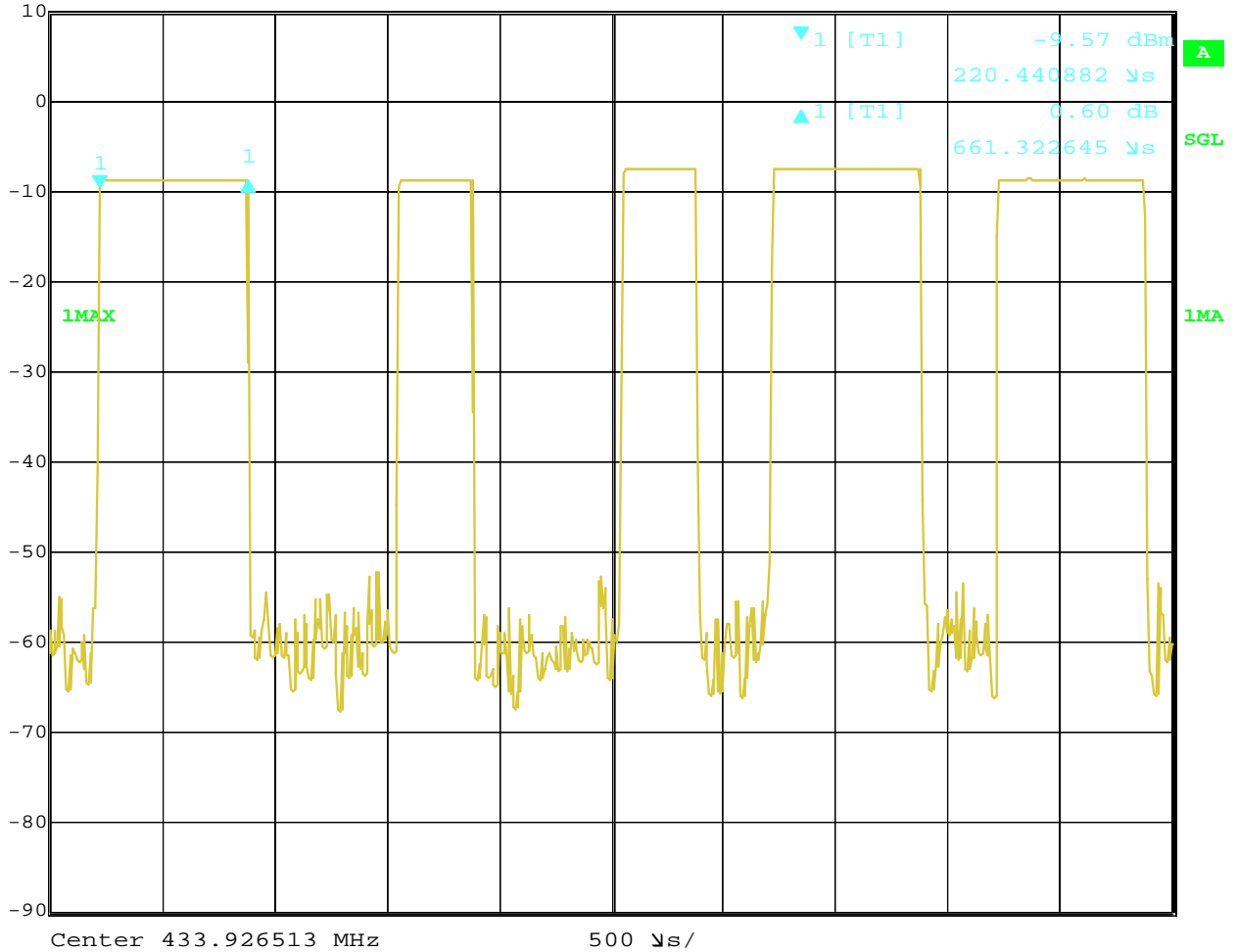

Date: 10.AUG.2023 18:02:37

The report refers only to the sample tested and does not apply to the bulk.
 This report is issued in confidence to the client and it will be strictly treated as such by the SHENZHEN TIMEWAY TESTING LABORATORIES. It may not be reproduced in its entirety or in part and it may not be used for advertising. The client to whom the report is issued may, however, show or send it, or a certified copy thereof prepared by the SHENZHEN TIMEWAY TESTING LABORATORIES, to his customer. Supplier or others persons directly concerned. SHENZHEN TIMEWAY TESTING LABORATORIES, will not, without the consent of the client enter into any discussion of correspondence with any third party concerning the contents of the report.
 In the event of the improper use of the report. The SHENZHEN TIMEWAY TESTING LABORATORIES, reserves the rights to withdraw it and to adopt any other remedies which may be appropriate.



T_{on2}



	Delta 1 [T1]	RBW	100 kHz	RF Att	20 dB
Ref Lvl	0.73 dB	VBW	100 kHz		
10 dBm	330.661323 μ s	SWT	5 ms	Unit	dBm

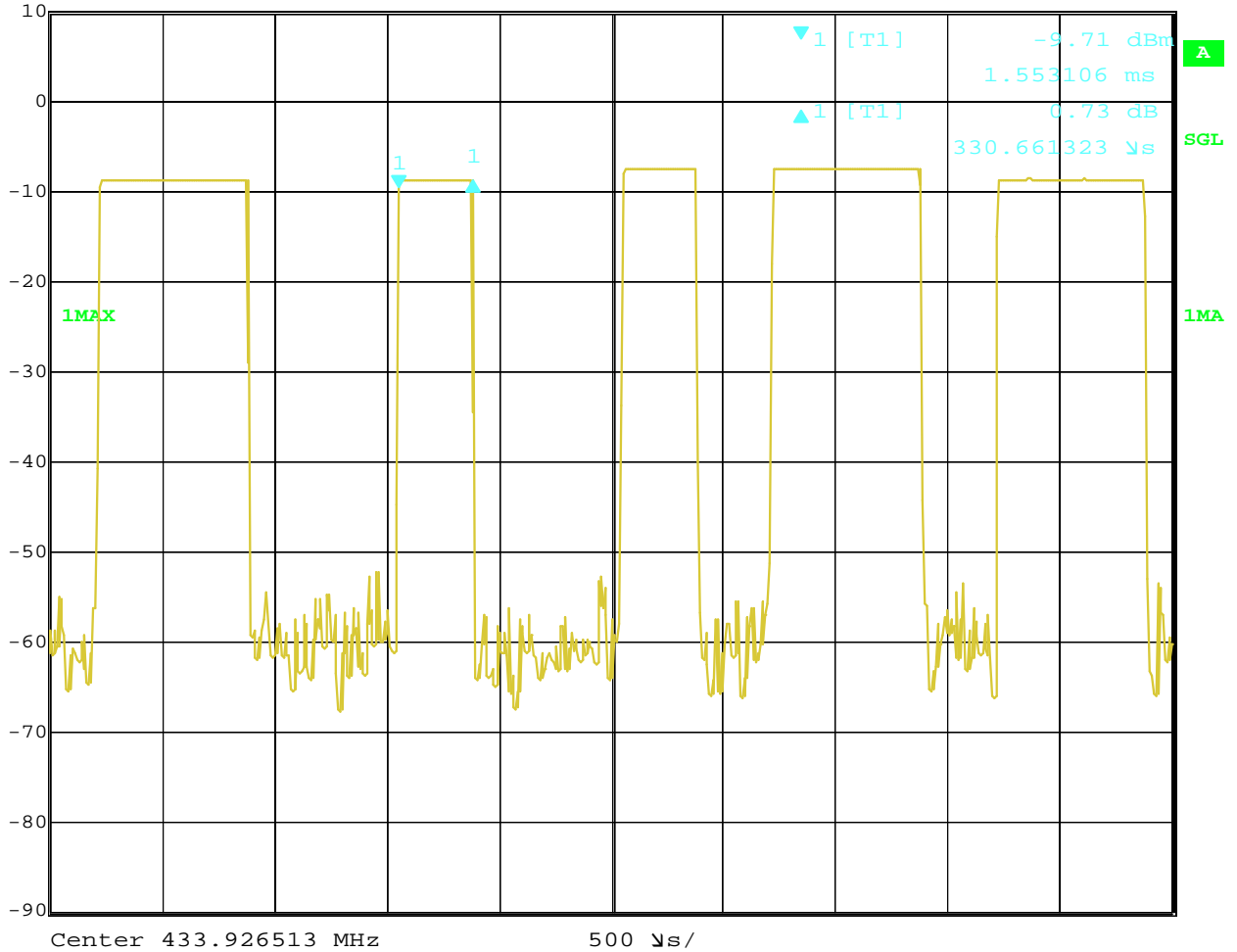

Date: 10.AUG.2023 18:03:16

The report refers only to the sample tested and does not apply to the bulk.
 This report is issued in confidence to the client and it will be strictly treated as such by the SHENZHEN TIMEWAY TESTING LABORATORIES. It may not be reproduced in its entirety or in part and it may not be used for advertising. The client to whom the report is issued may, however, show or send it, or a certified copy thereof prepared by the SHENZHEN TIMEWAY TESTING LABORATORIES, to his customer. Supplier or others persons directly concerned. SHENZHEN TIMEWAY TESTING LABORATORIES, will not, without the consent of the client enter into any discussion of correspondence with any third party concerning the contents of the report.
 In the event of the improper use of the report. The SHENZHEN TIMEWAY TESTING LABORATORIES, reserves the rights to withdraw it and to adopt any other remedies which may be appropriate.



10.0 Antenna Requirement

10.1 Standard Applicable

An intentional radiator shall be designed to ensure that no antenna other than that furnished by the responsible party shall be used with the device. The use of a permanently attached antenna or of an antenna that uses a unique coupling to the intentional radiator shall be considered sufficient to comply with the provisions of this Section. The manufacturer may design the unit so that a broken antenna can be replaced by the user, but the use of a standard antenna jack or electrical connector is prohibited. This requirement does not apply to carrier current devices or to devices operated under the provisions of Sections 15.211, 15.213, 15.217, 15.219, or 15.221. Further, this requirement does not apply to intentional radiators that must be professionally installed, such as perimeter protection systems and some field disturbance sensors, or to other intentional radiators which, in accordance with Section 15.31(d), must be measured at the installation site. However, the installer shall be responsible for ensuring that the proper antenna is employed so that the limits in this Part are not exceeded.

10.2 Antenna Connected constructions

The antenna is PCB Antenna which is built-in. The antenna gain is 0dBi. So it meets the requirement of 15.203

The report refers only to the sample tested and does not apply to the bulk.

This report is issued in confidence to the client and it will be strictly treated as such by the SHENZHEN TIMEWAY TESTING LABORATORIES. It may not be reproduced rather in its entirety or in part and it may not be used for advertising. The client to whom the report is issued may, however, show or send it . or a certified copy there of prepared by the SHENZHEN TIMEWAY TESTING LABORATORIES. to his customer. Supplier or others persons directly concerned. SHENZHEN TIMEWAY TESTING LABORATORIES. will not, without the consent of the client enter into any discussion of correspondence with any third party concerning the contents of the report.

In the event of the improper use of the report. The SHENZHEN TIMEWAY TESTING LABORATORIES. reserves the rights to withdraw it and to adopt any other remedies which may be appropriate.



11.0 FCC ID Label

FCC ID: A25-TX015A

The label must not be a stick-on paper label. The label on these products must be permanently affixed to the product and readily visible at the time of purchase and must last the expected lifetime of the equipment not be readily detachable.

Mark Location:

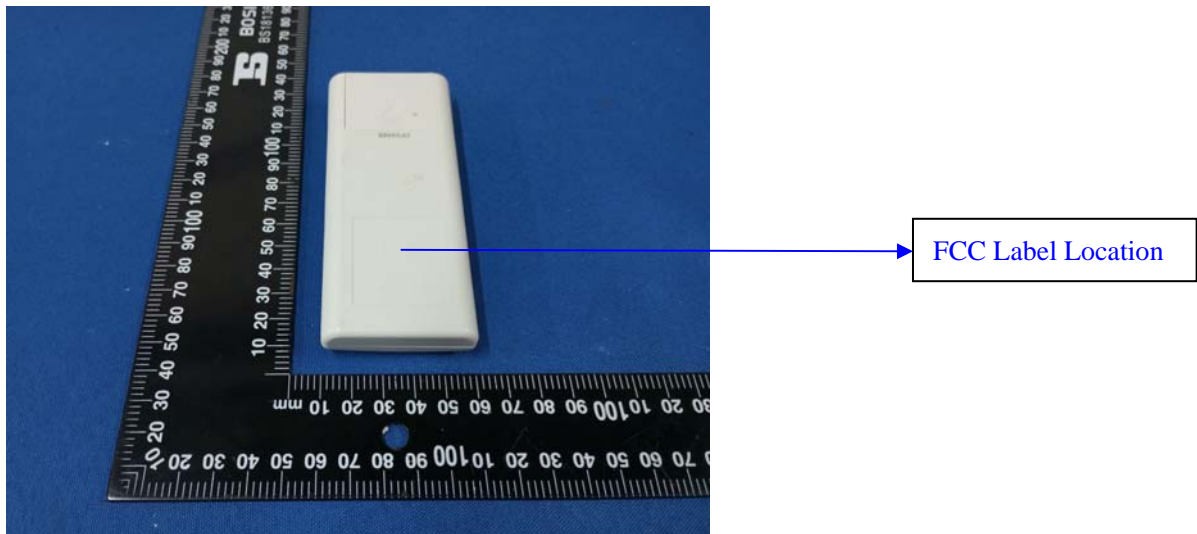

The report refers only to the sample tested and does not apply to the bulk.

This report is issued in confidence to the client and it will be strictly treated as such by the SHENZHEN TIMEWAY TESTING LABORATORIES. It may not be reproduced rather in its entirety or in part and it may not be used for advertising. The client to whom the report is issued may, however, show or send it . or a certified copy there of prepared by the SHENZHEN TIMEWAY TESTING LABORATORIES. to his customer. Supplier or others persons directly concerned. SHENZHEN TIMEWAY TESTING LABORATORIES. will not, without the consent of the client enter into any discussion of correspondence with any third party concerning the contents of the report.

In the event of the improper use of the report. The SHENZHEN TIMEWAY TESTING LABORATORIES. reserves the rights to withdraw it and to adopt any other remedies which may be appropriate.



12.0. Photo of testing

12.1 Conducted test View—N/A

12.2 Radiated emission test view



The report refers only to the sample tested and does not apply to the bulk.

This report is issued in confidence to the client and it will be strictly treated as such by the SHENZHEN TIMEWAY TESTING LABORATORIES. It may not be reproduced rather in its entirety or in part and it may not be used for advertising. The client to whom the report is issued may, however, show or send it . or a certified copy there of prepared by the SHENZHEN TIMEWAY TESTING LABORATORIES. to his customer. Supplier or others persons directly concerned. SHENZHEN TIMEWAY TESTING LABORATORIES. will not, without the consent of the client enter into any discussion of correspondence with any third party concerning the contents of the report.

In the event of the improper use of the report. The SHENZHEN TIMEWAY TESTING LABORATORIES. reserves the rights to withdraw it and to adopt any other remedies which may be appropriate.



Outside View



The report refers only to the sample tested and does not apply to the bulk.

This report is issued in confidence to the client and it will be strictly treated as such by the SHENZHEN TIMEWAY TESTING LABORATORIES. It may not be reproduced in its entirety or in part and it may not be used for advertising. The client to whom the report is issued may, however, show or send it, or a certified copy thereof prepared by the SHENZHEN TIMEWAY TESTING LABORATORIES, to his customer, supplier or other persons directly concerned. SHENZHEN TIMEWAY TESTING LABORATORIES will not, without the consent of the client, enter into any discussion of correspondence with any third party concerning the contents of the report.

In the event of the improper use of the report, the SHENZHEN TIMEWAY TESTING LABORATORIES reserves the rights to withdraw it and to adopt any other remedies which may be appropriate.



Outside View



The report refers only to the sample tested and does not apply to the bulk.

This report is issued in confidence to the client and it will be strictly treated as such by the SHENZHEN TIMEWAY TESTING LABORATORIES. It may not be reproduced in its entirety or in part and it may not be used for advertising. The client to whom the report is issued may, however, show or send it, or a certified copy thereof prepared by the SHENZHEN TIMEWAY TESTING LABORATORIES, to his customer. Supplier or other persons directly concerned. SHENZHEN TIMEWAY TESTING LABORATORIES, will not, without the consent of the client enter into any discussion of correspondence with any third party concerning the contents of the report.

In the event of the improper use of the report, the SHENZHEN TIMEWAY TESTING LABORATORIES, reserves the rights to withdraw it and to adopt any other remedies which may be appropriate.



Outside View



The report refers only to the sample tested and does not apply to the bulk.
This report is issued in confidence to the client and it will be strictly treated as such by the SHENZHEN TIMEWAY TESTING LABORATORIES. It may not be reproduced rather in its entirety or in part and it may not be used for advertising. The client to whom the report is issued may, however, show or send it . or a certified copy there of prepared by the SHENZHEN TIMEWAY TESTING LABORATORIES. to his customer. Supplier or others persons directly concerned. SHENZHEN TIMEWAY TESTING LABORATORIES. will not, without the consent of the client enter into any discussion of correspondence with any third party concerning the contents of the report.
In the event of the improper use of the report. The SHENZHEN TIMEWAY TESTING LABORATORIES. reserves the rights to withdraw it and to adopt any other remedies which may be appropriate.



Inside View



The report refers only to the sample tested and does not apply to the bulk.
This report is issued in confidence to the client and it will be strictly treated as such by the SHENZHEN TIMEWAY TESTING LABORATORIES. It may not be reproduced rather in its entirety or in part and it may not be used for advertising. The client to whom the report is issued may, however, show or send it . or a certified copy there of prepared by the SHENZHEN TIMEWAY TESTING LABORATORIES. to his customer. Supplier or others persons directly concerned. SHENZHEN TIMEWAY TESTING LABORATORIES. will not, without the consent of the client enter into any discussion of correspondence with any third party concerning the contents of the report.
In the event of the improper use of the report. The SHENZHEN TIMEWAY TESTING LABORATORIES. reserves the rights to withdraw it and to adopt any other remedies which may be appropriate.

Inside View

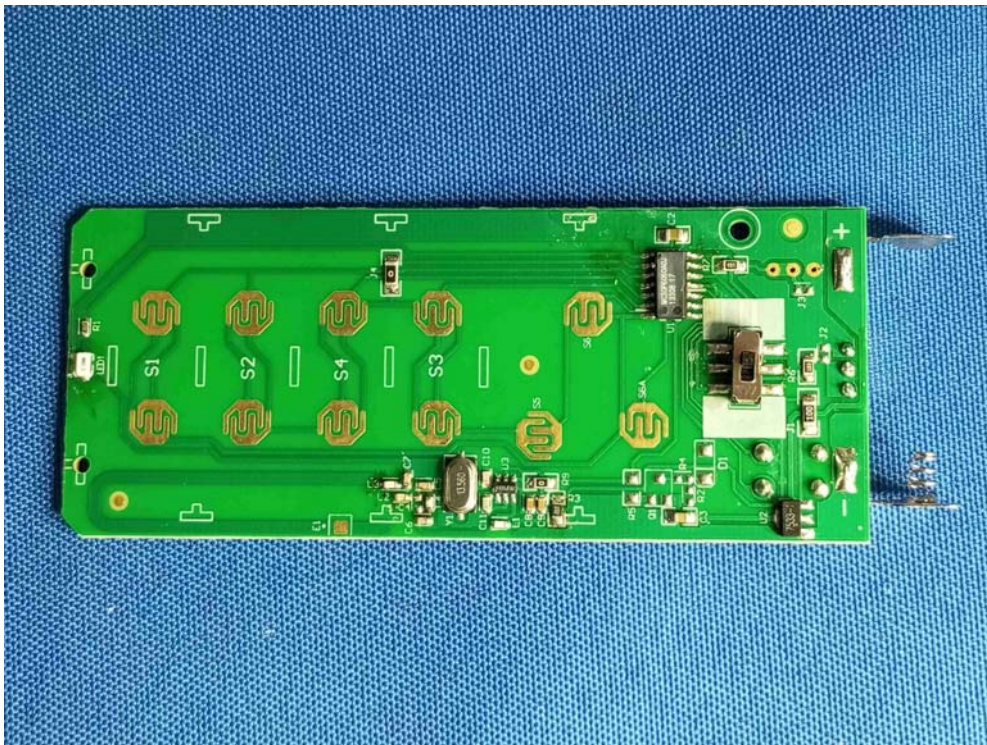

The report refers only to the sample tested and does not apply to the bulk.
This report is issued in confidence to the client and it will be strictly treated as such by the SHENZHEN TIMEWAY TESTING LABORATORIES. It may not be reproduced rather in its entirety or in part and it may not be used for advertising. The client to whom the report is issued may, however, show or send it, or a certified copy thereof prepared by the SHENZHEN TIMEWAY TESTING LABORATORIES, to his customer, supplier or others persons directly concerned. SHENZHEN TIMEWAY TESTING LABORATORIES, will not, without the consent of the client enter into any discussion of correspondence with any third party concerning the contents of the report.
In the event of the improper use of the report. The SHENZHEN TIMEWAY TESTING LABORATORIES, reserves the rights to withdraw it and to adopt any other remedies which may be appropriate.



Inside View



-End of the report-

The report refers only to the sample tested and does not apply to the bulk.

This report is issued in confidence to the client and it will be strictly treated as such by the SHENZHEN TIMEWAY TESTING LABORATORIES. It may not be reproduced rather in its entirety or in part and it may not be used for advertising. The client to whom the report is issued may, however, show or send it . or a certified copy there of prepared by the SHENZHEN TIMEWAY TESTING LABORATORIES. to his customer. Supplier or others persons directly concerned. SHENZHEN TIMEWAY TESTING LABORATORIES. will not, without the consent of the client enter into any discussion of correspondence with any third party concerning the contents of the report. In the event of the improper use of the report. The SHENZHEN TIMEWAY TESTING LABORATORIES. reserves the rights to withdraw it and to adopt any other remedies which may be appropriate.