



Shenzhen CTA Testing Technology Co., Ltd.

Room 106, Building 1, Yibaolai Industrial Park, Qiaotou Community, Fuhai Street, Bao'an District, Shenzhen, China

TEST REPORT

Report Reference No.....: **CTA24052101818**

FCC ID: **2BE8S-U100**

Compiled by
(position+printed name+signature)..: File administrators Zoey Cao

Zoey Cao

Supervised by
(position+printed name+signature)..: Project Engineer Amy Wen



Approved by
(position+printed name+signature)..: RF Manager Eric Wang

Eric Wang

Date of issue.....: June 03, 2024

Testing Laboratory Name: **Shenzhen CTA Testing Technology Co., Ltd.**
Address: Room 106, Building 1, Yibaolai Industrial Park, Qiaotou Community, Fuhai Street, Bao'an District, Shenzhen, China

Applicant's name: **Shenzhen kehuitong Technology Co., Ltd.**
Address: F3.830306G, 3rd Floor, Tianan Code City Tianjing Building, No.6 Tianan Road, Shatou Street, Futian District, Shenzhen, China

Test specification: **IEC 62209-2:2010; IEEE 1528:2013; FCC 47 CFR Part 2.1093;**
Standard: **ANSI/IEEE C95.1:2005; Reference FCC KDB 447498; KDB 248227; KDB 616217; KDB 941225; KDB 865664**

Shenzhen CTA Testing Technology Co., Ltd. All rights reserved.
This publication may be reproduced in whole or in part for non-commercial purposes as long as the Shenzhen CTA Testing Technology Co., Ltd. is acknowledged as copyright owner and source of the material. Shenzhen CTA Testing Technology Co., Ltd. takes no responsibility for and will not assume liability for damages resulting from the reader's interpretation of the reproduced material due to its placement and context.

Test item description.....: **Mobile phone**
Trade Mark: Aidekunlin
Manufacturer: Shenzhen kehuitong Technology Co., Ltd.
Model/Type reference.....: U100
Listed Models: U24, U25, U26, U27, U28, U29, U30, U31, U32, U33, U34, U35, U70, U70U, U80, U80U, U90, U90U, U60, U12pro, U13pro, U14pro, U27pro, U200, U300, U400, U500, U600, U700
Rating: DC 3.8V From battery and DC 5.0V From external circuit
Result: **PASS**

TEST REPORT

Equipment under Test : mobile phone

Model /Type : U100

Listed Models : U24, U25, U26, U27, U28, U29, U30, U31, U32, U33, U34, U35, U70, U70U, U80, U80U, U90, U90U, U60, U12pro, U13pro, U14pro, U27pro, U200, U300, U400, U500, U600, U700

Applicant : **Shenzhen kehuitong Technology Co., Ltd.**

Address : F3.830306G, 3rd Floor, Tianan Code City Tianjing Building, No.6 Tianan Road, Shatou Street, Futian District, Shenzhen, China

Manufacturer : **Shenzhen kehuitong Technology Co., Ltd.**

Address : F3.830306G, 3rd Floor, Tianan Code City Tianjing Building, No.6 Tianan Road, Shatou Street, Futian District, Shenzhen, China

Test Result:	PASS
---------------------	-------------

The test report merely corresponds to the test sample.

It is not permitted to copy extracts of these test result without the written permission of the test laboratory.

Contents

1	Statement of Compliance	6
2	General Information	7
2.1	General Remarks	7
2.2	Description of Equipment Under Test (EUT).....	7
2.3	Device Category and SAR Limits	8
2.4	Applied Standard	8
2.5	Test Facility.....	9
2.6	Environment of Test Site.....	9
2.7	Test Configuration.....	9
3	Specific Absorption Rate (SAR).....	10
3.1	Introduction.....	10
3.2	SAR Definition	10
4	SAR Measurement System.....	11
4.1	E-Field Probe.....	11
4.2	Data Acquisition Electronics (DAE).....	12
4.3	Robot.....	13
4.4	Measurement Server	13
4.5	Phantom	14
4.6	Device Holder.....	14
4.7	Data Storage and Evaluation.....	15
5	Test Equipment List	18
6	Tissue Simulating Liquids	19
7	System Verification Procedures.....	21
8	EUT Testing Position	23
8.1	Handset Reference Points.....	23
8.2	Positioning for Cheek / Touch	24
8.3	Positioning for Ear / 15° Tilt	24
8.4	Body Worn Accessory Configurations.....	25
8.5	Wireless Router (Hotspot) Configurations	25
9	Measurement Procedures.....	26
9.1	Spatial Peak SAR Evaluation	26
9.2	Power Reference Measurement.....	26
9.3	Area Scan Procedures	27
9.4	Zoom Scan Procedures.....	27
9.5	Volume Scan Procedures	29
9.6	Power Drift Monitoring.....	29
10	TEST CONDITIONS AND RESULTS	30
10.1	Conducted Power.....	30
10.2	Transmit Antennas and SAR Measurement Position	63
10.3	SAR Test Exclusion and Estimated SAR.....	64
10.4	SAR Test Results Summary	65

10.5 SAR Measurement Variability 74

10.6 Simultaneous Transmission Analysis..... 75

11 Measurement Uncertainty 77

Appendix A. EUT Photos and Test Setup Photos 79

Appendix B. Plots of SAR System Check..... 81

Appendix C. Plots of SAR Test Data 87

Appendix D. DASY System Calibration Certificate 113

Version

Version No.	Date	Description
R00	June 03, 2024	Original

1 Statement of Compliance

<Highest SAR Summary>

This device is in compliance with Specific Absorption Rate (SAR) for general population/uncontrolled exposure limits (1.6 W/kg) specified in FCC 47 CFR part 2 (2.1093) and ANSI/IEEE C95.1-2005, and had been tested in accordance with the measurement methods and procedures specified in IEEE 1528-2013. The maximum results of Specific Absorption Rate (SAR) found during testing are as follows.

Frequency Band	Highest Reported 1g-SAR(W/Kg)			Simultaneous Reported SAR (W/Kg)
	Head	Body-Worn (10mm)	Host pot (10mm)	
GSM 850	0.366	0.433	0.433	Head: 1.090 Body: 0.945
PCS1900	0.542	0.664	0.664	
WCDMA Band II	0.667	0.426	0.426	
WCDMA Band VI	0.533	0.481	0.481	
WCDMA Band V	0.665	0.338	0.338	
LTE Band 7	0.569	0.455	0.455	
LTE Band 12/ LTE Band 17	0.569	0.432	0.432	
LTE Band 25/ LTE Band 2	0.643	0.625	0.625	
LTE Band 26 Lower Band	0.547	0.532	0.675	
LTE Band 26 Higher Band/ LTE Band 5	0.517	0.537	0.537	
LTE Band 66/LTE Band 4	0.597	0.664	0.664	
LTE Band 41/ LTE Band 38	0.586	0.739	0.739	
WLAN2.4G	0.413	0.214	0.214	
SAR Test Limit (W/Kg)	1.60			
Test Result	PASS			

Note: LTE band 2, LTE band 4, LTE band 5, LTE Band 17, LTE Band 38 SAR was covered by LTE band 25, LTE Band 66, LTE Band 26 Higher Band, LTE Band 12, LTE Band 41 ; according to April 2015 TCB workshop, SAR test for overlapping LTE bands can be reduced if a. the maximum output power, including tolerance, for the smaller band is \leq the larger band to qualify for the SAR test exclusion. b. the channel bandwidth and other operating parameters for the smaller band are fully supported by the larger band.

2 General Information

2.1 General Remarks

Date of receipt of test sample	:	May 20, 2024
Testing commenced on	:	May 20, 2024
Testing concluded on	:	May 31, 2024

2.2 Description of Equipment Under Test (EUT)

Product Name:	mobile phone
Model/Type reference:	U24
Power supply:	DC 3.8V From battery and DC 5.0V From external circuit
Testing sample ID:	CTA240521018-1# (Engineer sample) CTA240521018-2# (Normal sample)
Hardware version:	V707IK_MB_V6.0_202311 22
Software version:	V707IK_HDPLUS1600_Q0_V6.0_3_32_20240412_0857_V1.0.3_ HUAX_L300D14_WO_X100
Tx Frequency:	<p>SRD:</p> <p>BT:2402~2480MHz</p> <p>2.4G WIFI: 2412~2462MHz</p> <p>GSM:</p> <p>GSM850 TX: 824.2~848.8MHz</p> <p>PCS1900 TX: 1850.2~1909.8MHz</p> <p>WCDMA:</p> <p>Band 2: TX: 1852.4~1907.6MHz</p> <p>Band 4: TX: 1712.4~1752.6MHz</p> <p>Band 5: TX: 826.40~846.60MHz</p> <p>LTE:</p> <p>FDD Band 2: TX: 1850~1910MHz</p> <p>FDD Band 4: TX: 1710~1755MHz</p> <p>FDD Band 5: TX: 824~849MHz</p> <p>FDD Band 7: TX: 2500~2570MHz</p> <p>FDD Band 12: TX: 699~716MHz</p> <p>FDD Band 17: TX: 704~716MHz</p> <p>FDD Band 25: TX: 1850~1915MHz</p> <p>FDD Band 26: TX: 814~824MHz, 824~849MHz</p> <p>FDD Band 66: TX: 1710~1780MHz</p> <p>TDD Band 38: TX: 2570~2620 MHz</p> <p>TDD Band 41: TX: 2535~2655 MHz</p>
Type of Modulation:	<p>BT: GFSK, $\pi/4$DQPSK, 8DPSK</p> <p>2.4G WIFI: BPSK, QPSK, 16QAM, 64QAM</p>

	GSM: GMSK WCDMA: QPSK,16QAM LTE: QPSK,16QAM
Category of device:	Portable device
Remark:	The above DUT's information was declared by manufacturer. Please refer to the specifications or user's manual for more detailed description.

2.3 Device Category and SAR Limits

This device belongs to portable device category because its radiating structure is allowed to be used within 20 centimeters of the body of the user. Limit for General Population/Uncontrolled exposure should be applied for this device, it is 1.6 W/kg as averaged over any 1 gram of tissue.

2.4 Applied Standard

The Specific Absorption Rate (SAR) testing specification, method, and procedure for this device is in accordance with the following standards:

- FCC 47 CFR Part 2 (2.1093:2013)
- ANSI/IEEE C95.1:2005
- IEEE Std 1528:2013
- KDB 865664 D01 SAR Measurement 100 MHz to 6 GHz v01r04
- KDB 865664 D02 RF Exposure Reporting v01r02
- KDB 447498 D01 General RF Exposure Guidance v06
- KDB 248227 D01 802 11 Wi-Fi SAR v02r02
- KDB 941225 D01 3G SAR Procedures v03r01
- KDB 941225 D06 Hotspot SARv02r01
- KDB 648474 D04 Handset SAR v01r03

2.5 Test Facility

FCC-Registration No.: 517856 Designation Number: CN1318

Shenzhen CTA Testing Technology Co., Ltd. has been listed on the US Federal Communications Commission list of test facilities recognized to perform electromagnetic emissions measurements.

A2LA-Lab Cert. No.: 6534.01

Shenzhen CTA Testing Technology Co., Ltd. has been listed by American Association for Laboratory Accreditation to perform electromagnetic emission measurement.

ISED#: 27890 CAB identifier: CN0127

Shenzhen CTA Testing Technology Co., Ltd. has been listed by Innovation, Science and Economic Development Canada to perform electromagnetic emission measurement.

The 3m-Semi anechoic test site fulfils CISPR 16-1-4 according to ANSI C63.10 and CISPR 16-1-4:2010.

2.6 Environment of Test Site

Items	Required	Actual
Temperature (°C)	18-25	22~23
Humidity (%RH)	30-70	55~65

2.7 Test Configuration

The device was controlled by using a base station emulator. Communication between the device and the emulator was established by air link. The distance between the EUT and the antenna of the emulator is larger than 50 cm and the output power radiated from the emulator antenna is at least 30 dB smaller than the output power of EUT. The EUT was set from the emulator to radiate maximum output power during all tests. For WLAN SAR testing, WLAN engineering testing software installed on the EUT can provide continuous transmitting RF signal.

3 Specific Absorption Rate (SAR)

3.1 Introduction

SAR is related to the rate at which energy is absorbed per unit mass in an object exposed to a radio field. The SAR distribution in a biological body is complicated and is usually carried out by experimental techniques or numerical modeling. The standard recommends limits for two tiers of groups, occupational/controlled and general population/uncontrolled, based on a person's awareness and ability to exercise control over his or her exposure. In general, occupational/controlled exposure limits are higher than the limits for general population/uncontrolled.

3.2 SAR Definition

The SAR definition is the time derivative (rate) of the incremental energy (dW) absorbed by (dissipated in) an incremental mass (dm) contained in a volume element (dv) of a given density (ρ). The equation description is as below:

$$\text{SAR} = \frac{d}{dt} \left(\frac{dW}{dm} \right) = \frac{d}{dt} \left(\frac{dW}{\rho dv} \right)$$

SAR is expressed in units of Watts per kilogram (W/kg)

SAR measurement can be either related to the temperature elevation in tissue by

$$\text{SAR} = c \left(\frac{\delta T}{\delta t} \right)$$

Where: C is the specific heat capacity, δT is the temperature rise and δt is the exposure duration, or related to the electrical field in the tissue by

$$\text{SAR} = \frac{\sigma |E|^2}{\rho}$$

Where: σ is the conductivity of the tissue, ρ is the mass density of the tissue and E is the RMS electrical field strength.

However, for evaluating SAR of low power transmitter, electrical field measurement is typically applied.

4 SAR Measurement System

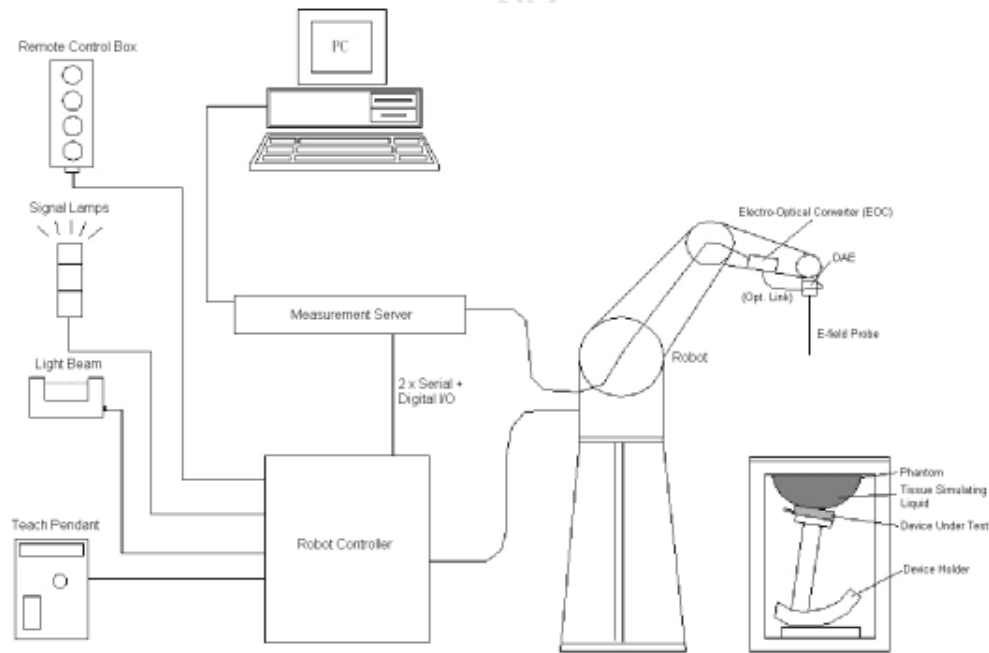

DASY System Configurations

The DASY system for performance compliance tests is illustrated above graphically. This system consists of the following items:

- A standard high precision 6-axis robot with controller, a teach pendant and software
- A data acquisition electronic (DAE) attached to the robot arm extension
- A dosimetric probe equipped with an optical surface detector system
- The electro-optical converter (EOC) performs the conversion between optical and electrical signals
- A measurement server performs the time critical tasks such as signal filtering, control of the robot operation and fast movement interrupts.
- A probe alignment unit which improves the accuracy of the probe positioning
- A computer operating Windows XP
- DASY software
- Remote control with teach pendant and additional circuitry for robot safety such as warning lamps, etc.
- The SAM twin phantom
- A device holder
- Tissue simulating liquid
- Dipole for evaluating the proper functioning of the system

components are described in details in the following sub-sections.

4.1 E-Field Probe

The SAR measurement is conducted with the dosimetric probe (manufactured by SPEAG). The probe is specially designed and calibrated for use in liquid with high permittivity. The dosimetric probe has special calibration in liquid at different frequency. This probe has a built in optical surface

detection system to prevent from collision with phantom.

➤ E-Field Probe Specification

<EX3DV4 Probe>

Construction	Symmetrical design with triangular core Built-in shielding against static charges PEEK enclosure material (resistant to organic solvents, e.g., DGBE)
Frequency	10 MHz to 6 GHz; Linearity: ± 0.2 dB
Directivity	± 0.3 dB in HSL (rotation around probe axis) ± 0.5 dB in tissue material (rotation normal to probe axis)
Dynamic Range	10 μ W/g to 100 W/kg; Linearity: ± 0.2 dB (noise: typically < 1 μ W/g)
Dimensions	Overall length: 330 mm (Tip: 20 mm) Tip diameter: 2.5 mm (Body: 12 mm) Typical distance from probe tip to dipole centers: 1 mm



Photo of EX3DV4

➤ E-Field Probe Calibration

Each probe needs to be calibrated according to a dosimetric assessment procedure with accuracy better than $\pm 10\%$. The spherical isotropy shall be evaluated and within ± 0.25 dB. The sensitivity parameters (NormX, NormY, and NormZ), the diode compression parameter (DCP) and the conversion factor (ConvF) of the probe are tested. The calibration data can be referred to appendix C of this report.

4.2 Data Acquisition Electronics (DAE)

The data acquisition electronics (DAE) consists of a highly sensitive electrometer-grade preamplifier with auto-zeroing, a channel and gain-switching multiplexer, a fast 16 bit AD-converter and a command decoder and control logic unit. Transmission to the measurement server is accomplished through an optical downlink for data and status information as well as an optical uplink for commands and the clock.

The input impedance of the DAE is 200M Ω ; the inputs are symmetrical and floating. Common mode rejection is above 80dB.



Photo of DAE

4.3 Robot

The SPEAG DASY system uses the high precision robots (DASY5: TX60XL) type from Stäubli SA (France). For the 6-axis controllersystem, the robot controller version (DASY5: CS8c) from Stäubli is used. The Stäublirobot series have many features that are important for our application:

- High precision (repeatability ± 0.035 mm)
- High reliability (industrial design)
- Jerk-free straight movements
- Low ELF interference (the closed metallic construction shields against motor control fields)



Photo of DASY5

4.4 Measurement Server

The measurement server is based on a PC/104 CPU board with CPU (DASY5: 400 MHz, Intel Celeron), chipdisk (DASY5: 128 MB), RAM (DASY5: 128 MB). The necessary circuits for communication with the DAE electronic box, as well as the 16 bit AD converter system for optical detection and digital I/O interface are contained on the DASY I/O board, which is directly connected to the PC/104 bus of the CPU board.

The measurement server performs all the real-time data evaluation for field measurements and surface detection, controls robot movements and handles safety operations.



Photo of Server for DASY5

4.5 Phantom

<SAM Twin Phantom>

Shell Thickness	2 ± 0.2 mm; Center ear point: 6 ± 0.2 mm	 <p>Photo of SAM Phantom</p>
Filling Volume	Approx. 25 liters	
Dimensions	Length: 1000 mm; Width: 500 mm; Height: adjustable feet	
Measurement Areas	Left Hand, Right Hand, Flat Phantom	

The bottom plate contains three pair of bolts for locking the device holder. The device holder positions are adjusted to the standard measurement positions in the three sections. A white cover is provided to tap the phantom during off-periods to prevent water evaporation and changes in the liquid parameters. On the phantom top, three reference markers are provided to identify the phantom position with respect to the robot.

<ELI4 Phantom>

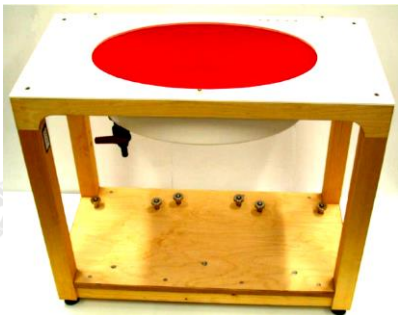
Shell Thickness	2 ± 0.2 mm (sagging: <1%)	 <p>Photo of ELI4 Phantom</p>
Filling Volume	Approx. 30 liters	
Dimensions	Major ellipse axis: 600 mm Minor axis: 400 mm	

The ELI4 phantom is intended for compliance testing of handheld and body-mounted wireless devices in the frequency range of 30 MHz to 6 GHz. ELI4 is fully compatible with standard and all known tissue simulating liquids.

4.6 Device Holder

The SAR in the phantom is approximately inversely proportional to the square of the distance between the source and the liquid surface. For a source at 5 mm distance, a positioning uncertainty of ±0.5mm would produce a SAR uncertainty of ± 20%. Accurate device positioning is therefore crucial for accurate and repeatable measurements. The positions in which the devices must be measured are defined by the standards.

The DASY device holder is designed to cope with different positions given in the standard. It has two scales for the device rotation (with respect to the body axis) and the device inclination (with respect to the line between the ear reference points). The rotation center for both scales is the ear reference point

(ERP). Thus the device needs no repositioning when changing the angles.

The DASY device holder is constructed of low-loss POM material having the following dielectric parameters: relative permittivity $\epsilon = 3$ and loss tangent $\delta = 0.02$. The amount of dielectric material has been reduced in the closest vicinity of the device, since measurements have suggested that the influence of the clamp on the test results could thus be lowered.



Device Holder

4.7 Data Storage and Evaluation

➤ Data Storage

The DASY software stores the assessed data from the data acquisition electronics as raw data (in microvolt readings from the probe sensors), together with all the necessary software parameters for the data evaluation (probe calibration data, liquid parameters and device frequency and modulation data) in measurement files. The post-processing software evaluates the desired unit and format for output each time the data is visualized or exported. This allows verification of the complete software setup even after the measurement and allows correction of erroneous parameter settings. For example, if a measurement has been performed with an incorrect crest factor parameter in the device setup, the parameter can be corrected afterwards and the data can be reevaluated.

The measured data can be visualized or exported in different units or formats, depending on the selected probe type (e.g., [V/m], [A/m], [W/kg]). Some of these units are not available in certain situations or give meaningless results, e.g., a SAR-output in a non-lose media, will always be zero. Raw data can also be exported to perform the evaluation with other software packages.

➤ Data Evaluation

The DASY post-processing software (SEMCAD) automatically executes the following procedures to calculate the field units from the microvolt readings at the probe connector. The parameters used in the evaluation are stored in the configuration modules of the software:

Probe parameters:	- Sensitivity	Norm _i , a _{i0} , a _{i1} , a _{i2}
	- Conversion factor	ConvF _i
	- Diode compression point	dcp _i
Device parameters:	- Frequency	f
	- Crest factor	cf
Media parameters:	- Conductivity	σ
	- Density	ρ

These parameters must be set correctly in the software. They can be found in the component documents or they can be imported into the software from the configuration files issued for the DASY components. In the direct measuring mode of the multi-meter option, the parameters of the actual system setup are used. In the scan visualization and export modes, the parameters stored in the corresponding document files are used.

The first step of the evaluation is a linearization of the filtered input signal to account for the compression characteristics of the detector diode. The compensation depends on the input signal, the diode type and the DC-transmission factor from the diode to the evaluation electronics. If the exciting field is pulsed, the crest factor of the signal must be known to correctly compensate for peak power.

The formula for each channel can be given as:

$$V_i = U_i + U_i^2 \cdot \frac{cf}{dcp_i}$$

with V_i = compensated signal of channel i , ($i = x, y, z$)

U_i = input signal of channel i , ($i = x, y, z$)

cf = crest factor of exciting field (DASY parameter)

dcp _{i} = diode compression point (DASY parameter)

From the compensated input signals, the primary field data for each channel can be evaluated:

$$\text{E-field Probes: } E_i = \sqrt{\frac{V_i}{\text{Norm}_i \cdot \text{ConvF}}}$$

$$\text{H-field Probes: } H_i = \sqrt{V_i} \cdot \frac{a_{i0} + a_{i1}f + a_{i2}f^2}{f}$$

with V_i = compensated signal of channel i , ($i = x, y, z$)

Norm _{i} = sensor sensitivity of channel i , ($i = x, y, z$), $\mu\text{V}/(\text{V/m})^2$ for E-field Probes

ConvF = sensitivity enhancement in solution

a_{ij} = sensor sensitivity factors for H-field probes

f = carrier frequency [GHz]

E_i = electric field strength of channel i in V/m

H_i = magnetic field strength of channel i in A/m

The RSS value of the field components gives the total field strength (Hermitian magnitude):

$$E_{\text{tot}} = \sqrt{E_x^2 + E_y^2 + E_z^2}$$

The primary field data are used to calculate the derived field units.

$$\text{SAR} = E_{\text{tot}}^2 \cdot \frac{\sigma}{\rho \cdot 1000}$$

with SAR = local specific absorption rate in W/kg

E_{tot} = total field strength in V/m

σ = conductivity in [mho/m] or [Siemens/m]

ρ = equivalent tissue density in g/cm³

Note that the density is set to 1, to account for actual head tissue density rather than the density of the tissue simulating liquid.

5 Test Equipment List

Manufacturer	Name of Equipment	Type/Model	Serial Number	Calibration	
				Last Cal.	Due Date
SPEAG	750MHz System Validation Kit	D750V3	1194	Feb. 17,2023	Feb. 16,2026
SPEAG	835MHz System Validation Kit	D835V2	484	Aug. 25,2023	Aug. 24,2026
SPEAG	1800MHz System Validation Kit	D1800V2	2d158	Dec. 17,2021	Dec. 16,2024
SPEAG	1900MHz System Validation Kit	D1900V2	5d002	Aug. 25,2023	Aug. 24,2026
SPEAG	2450MHz System Validation Kit	D2450V2	745	Aug. 28,2023	Aug. 27,2026
SPEAG	2600MHz System Validation Kit	D2600V2	1073	Feb. 17,2023	Feb. 16,2026
SPEAG	5GHz System Validation Kit	D5GHzV2	1031	Feb.16, 2023	Feb.15, 2026
Rohde & Schwarz	UNIVERSAL RADIO COMMUNICATION TESTER	CMW500	1201.0002K50-104209-JC	Nov.05, 2023	Nov.04, 2024
SPEAG	Data Acquisition Electronics	DAE3	428	Aug.30,2023	Aug.29,2024
SPEAG	Dosimetric E-Field Probe	EX3DV4	7380	June 21,2023	June 20,2024
Agilent	ENA Series Network Analyzer	E5071C	MY46317418	Oct.25, 2023	Oct.24, 2024
SPEAG	DAK	DAK-3.5	1226	NCR	NCR
SPEAG	SAM Twin Phantom	QD000P40CD	1802	NCR	NCR
SPEAG	ELI Phantom	QDOVA004AA	2058	NCR	NCR
AR	Amplifier	ZHL-42W	QA1118004	NCR	NCR
Agilent	Power Meter	N1914A	MY50001102	Oct.25, 2023	Oct.24, 2024
Agilent	Power Sensor	N8481H	MY51240001	Oct.25, 2023	Oct.24, 2024
R&S	Spectrum Analyzer	N9020A	MY51170037	Oct.25, 2023	Oct.24, 2024
Agilent	Signal Generation	N5182A	MY48180656	Oct.25, 2023	Oct.24, 2024
Worken	Directional Coupler	0110A05601O-10	COM5BNW1A2	Oct.25, 2023	Oct.24, 2024

Note:

1. The calibration certificate of DASY can be referred to appendix D of this report.
2. The dipole calibration interval can be extended to 3 years with justification. The dipoles are also not physically damaged, or repaired during the interval.
3. The Insertion Loss calibration of Dual Directional Coupler and Attenuator were characterized via the network analyzer and compensated during system check.
4. The dielectric probe kit was calibrated via the network analyzer, with the specified procedure (calibrated in pure water) and calibration kit (standard) short circuit, before the dielectric measurement. The specific procedure and calibration kit are provided by Agilent.
5. In system check we need to monitor the level on the power meter, and adjust the power amplifier level to have precise power level to the dipole; the measured SAR will be normalized to 1W input power according to the ratio of 1W to the input power to the dipole. For system check, the calibration of the power amplifier is deemed not critically required for correct measurement; the power meter is critical and we do have calibration for it

6 Tissue Simulating Liquids

For the measurement of the field distribution inside the SAM phantom with DASY, the phantom must be filled with around 25 liters of homogeneous body tissue simulating liquid. For head SAR testing, the liquid height from the ear reference point (ERP) of the phantom to the liquid top surface is larger than 15 cm, which is shown in Fig. 6.1. For body SAR testing, the liquid height from the center of the flat phantom to the liquid top surface is larger than 15 cm, which is shown as followed:



Photo of Liquid Height for Head SAR

Photo of Liquid Height for Body SAR

The following table gives the recipes for tissue simulating liquid.

Frequency (MHz)	Water (%)	Sugar (%)	Cellulose (%)	Salt (%)	Preventol (%)	DGBE (%)	Conductivity (σ)	Permittivity (ϵ_r)
For Head								
835	40.3	57.9	0.2	1.4	0.2	0	0.90	41.5
1800,1900,2000	55.2	0	0	0.3	0	44.5	1.40	40.0
2450	55.0	0	0	0	0	45.0	1.80	39.2
2600	54.8	0	0	0.1	0	45.1	1.96	39.0
For Body								
835	50.8	48.2	0	0.9	0.1	0	0.97	55.2
1800,1900,2000	70.2	0	0	0.4	0	29.4	1.52	53.3
2450	68.6	0	0	0	0	31.4	1.95	52.7
2600	65.5	0	0	0	0	31.5	2.16	52.5

The following table shows the measuring results for simulating liquid.

Measured Frequency (MHz)	Target Tissue		Measured Tissue				Liquid Temp.	Test Data
	ϵ_r	σ	ϵ_r	Dev. (%)	σ	Dev. (%)		
750	41.9	0.89	41.699	-0.48%	0.855	-3.94%	22.5	05/22/2024
835	41.5	0.90	42.098	1.44%	0.927	2.97%	22.6	05/23/2024
1750	40.1	1.37	40.228	0.32%	1.351	-1.39%	22.7	05/24/2024
1900	40.0	1.40	38.440	-3.90%	1.389	-0.76%	22.7	05/28/2024
2450	39.2	1.80	39.282	0.21%	1.803	0.15%	22.6	05/30/2024
2600	39.0	1.96	38.836	-0.42%	2.014	2.74%	22.5	05/29/2024

7 System Verification Procedures

Each DASY system is equipped with one or more system validation kits. These units, together with the predefined measurement procedures within the DASY software, enable the user to conduct the system performance check and system validation. System validation kit includes a dipole, tripod holder to fix it underneath the flat phantom and a corresponding distance holder.

➤ Purpose of System Performance check

The system performance check verifies that the system operates within its specifications. System and operator errors can be detected and corrected. It is recommended that the system performance check be performed prior to any usage of the system in order to guarantee reproducible results. The system performance check uses normal SAR measurements in a simplified setup with a well characterized source. This setup was selected to give a high sensitivity to all parameters that might fail or vary over time. The system check does not intend to replace the calibration of the components, but indicates situations where the system uncertainty is exceeded due to drift or failure.

➤ System Setup

In the simplified setup for system evaluation, the EUT is replaced by a calibrated dipole and the power source is replaced by a continuous wave that comes from a signal generator. The calibrated dipole must be placed beneath the flat phantom section of the SAM twin phantom with the correct distance holder. The distance holder should touch the phantom surface with a light pressure at the reference marking and be oriented parallel to the long side of the phantom. The equipment setup is shown below:

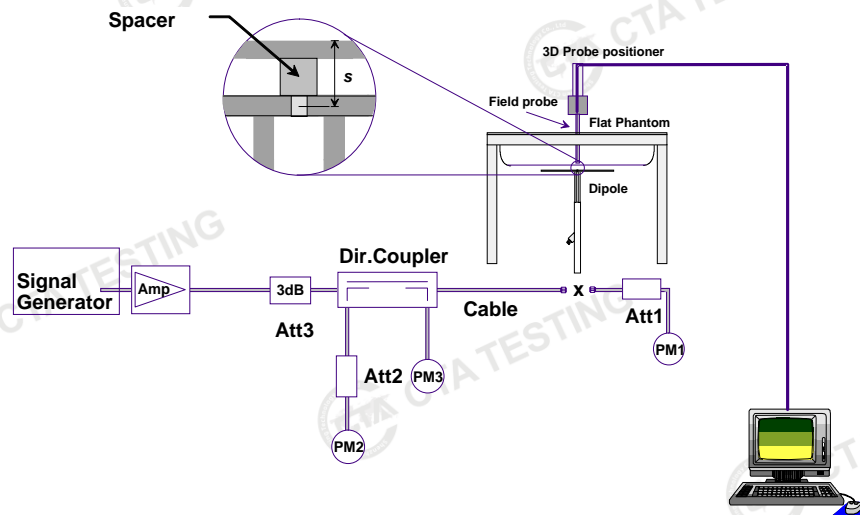

System Setup for System Evaluation

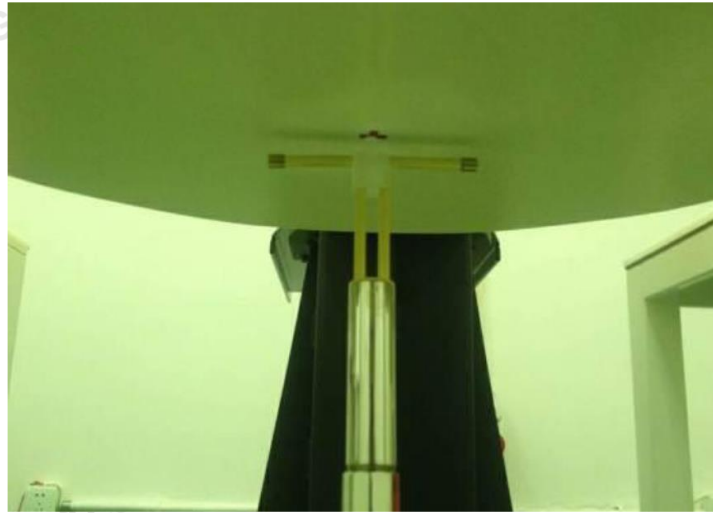

Photo of Dipole Setup

➤ **Validation Results**

Comparing to the original SAR value provided by SPEAG, the verification data should be within its specification of 10%. The table below shows the target SAR and measured SAR after normalized to 1W input power. It indicates that the system performance check can meet the variation criterion and the plots can be referred to Appendix B of this report.

Date	Frequency (MHz)	Power fed onto reference dipole (mW)	Targeted SAR 1g (W/kg)	Measured SAR1g (W/kg)	Normalized SAR (W/kg)	Deviation (%)
05/22/2024	750	250	8.57	2.20	8.80	2.58%
05/23/2024	835	250	9.68	2.48	9.92	2.34%
05/24/2024	1750	250	39.2	9.36	37.44	-4.51%
05/28/2024	1900	250	40.1	9.62	38.48	-4.03%
05/30/2024	2450	250	52.7	12.55	50.20	-4.75%
05/29/2024	2600	250	56.8	14.51	58.04	2.17%

8 EUT Testing Position

8.1 Handset Reference Points

- The vertical centreline passes through two points on the front side of the handset – the midpoint of the width w_t of the handset at the level of the acoustic output, and the midpoint of the width w_b of the bottom of the handset.
- The horizontal line is perpendicular to the vertical centreline and passes the center of the acoustic output.
- The horizontal line is also tangential to the handset at point A.
- The two lines intersect at point A. Note that for many handsets, point A coincides with the center of the acoustic output; however, the acoustic output may be located elsewhere on the horizontal line. Also note that the vertical centreline is not necessarily parallel to the front face of the handset, especially for clamshell handsets, handsets with flip covers, and other irregularly shaped handsets.



Fig.8-1 Illustration for Front, Back and Side of SAM Phantom

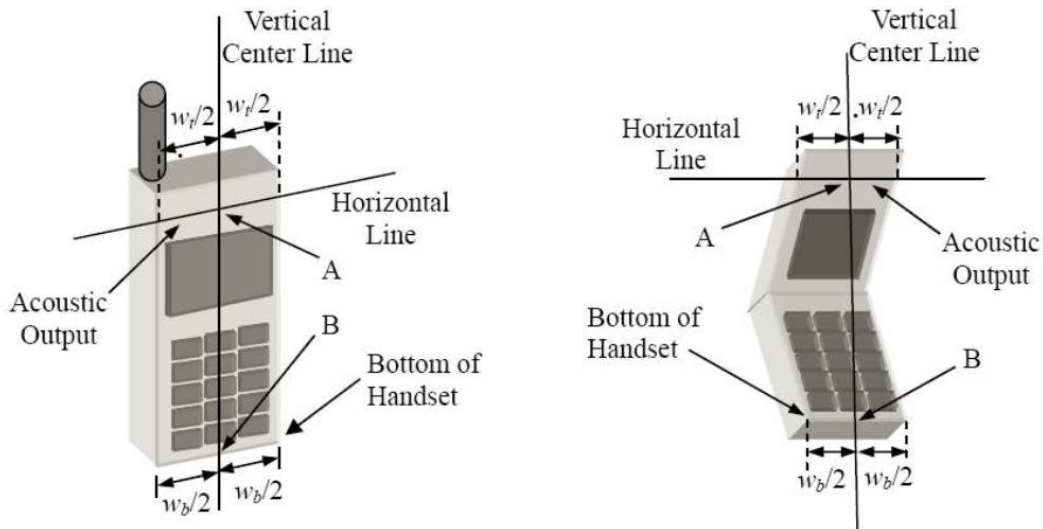

Fig.8-2 Illustration for Handset Vertical and Horizontal Reference Lines

8.2 Positioning for Cheek / Touch

- To position the device with the vertical center line of the body of the device and the horizontal line crossing the center piece in a plane parallel to the sagittal plane of the phantom. While maintaining the device in this plane, align the vertical center line with the reference plane containing the three ear and mouth reference point (M: Mouth, RE: Right Ear and LE: Left Ear) and align the center of the ear piece with the line RE-LE.
- To move the device towards the phantom with the ear piece aligned with the line LE-RE until the phone touched the ear. While maintaining the device in the reference plane and maintaining the phone contact with the ear, move the bottom of the phone until any point on the front side is in contact with the cheek of the phantom or until contact with the ear is lost (see below figure)



Fig.8-3 Illustration for Cheek Position

8.3 Positioning for Ear / 15° Tilt

- To position the device in the “cheek” position described above.
- While maintaining the device the reference plane described above and pivoting against the ear, moves it outward away from the mouth by an angle of 15 degrees or until contact with the ear is lost (see figure below).



Fig.8-4 Illustration for Tilted Position

8.4 Body Worn Accessory Configurations

- To position the device parallel to the phantom surface with either keypad up or down.
- To adjust the device parallel to the flat phantom
- To adjust the distance between the device surface and the flat phantom to 10 mm or holster surface and the flat phantom to 0 mm.

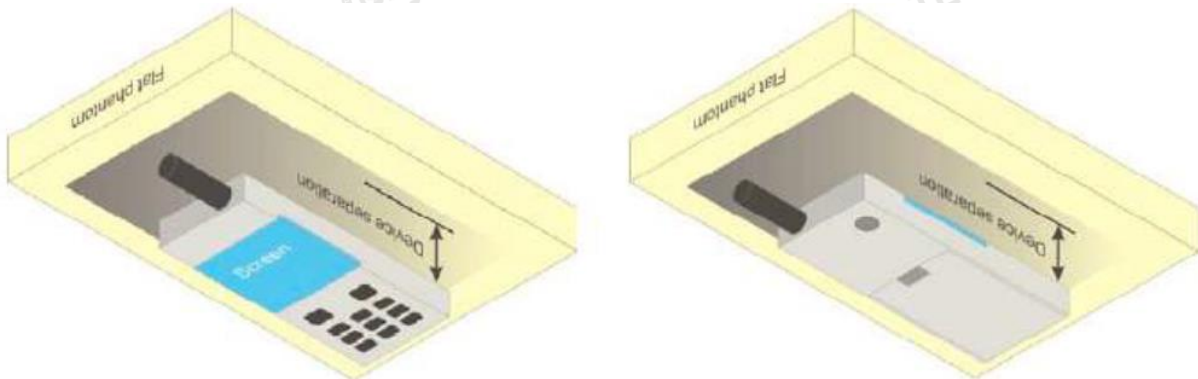

Fig.8-5 Illustration for Body Worn Position

8.5 Wireless Router (Hotspot) Configurations

Wireless Router (Hotspot) Configurations Some battery-operated handsets have the capability to transmit and receive internet connectivity through simultaneous transmission of WIFI in conjunction with a separate licensed transmitter. The FCC has provided guidance in KDB Publication 941225 D06 where SAR test considerations for handsets ($L \times W \geq 9 \text{ cm} \times 5 \text{ cm}$) are based on a composite test separation distance of 10 mm from the front, back and edges of the device with antennas 2.5 cm or closer to the edge of the device, determined from general mixed use conditions for this type of devices. Since the hotspot SAR results may overlap with the body-worn accessory SAR requirements, the more conservative configurations can be considered, thus excluding some body-worn accessory SAR tests.

When the user enables the personal wireless router functions for the handset, actual operations include simultaneous transmission of both the WIFI transmitter and another licensed transmitter. Both transmitters often do not transmit at the same transmitting frequency and thus cannot be evaluated for SAR under actual use conditions. Therefore, SAR must be evaluated for each frequency transmission and mode separately and summed with the WIFI transmitter according to KDB 648474 publication procedures. The “Portable Hotspot” feature on the handset was NOT activated, to ensure the SAR measurements were evaluated for a single transmission frequency RF signal.

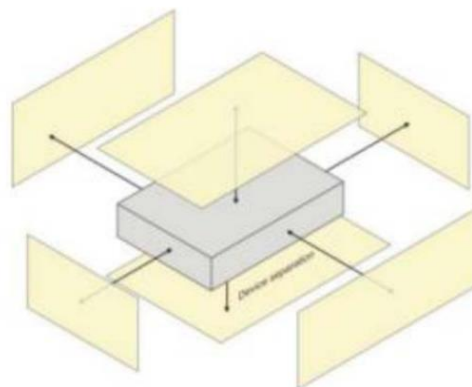

Fig.8-6 Illustration for Hotspot Position

9 Measurement Procedures

The measurement procedures are as follows:

- (a) Use base station simulator (if applicable) or engineering software to transmit RF power continuously (continuous Tx) in the middle channel.
- (b) Keep EUT to radiate maximum output power or 100% duty factor (if applicable)
- (c) Measure output power through RF cable and power meter.
- (d) Place the EUT in the positions as setup photos demonstrates.
- (e) Set scan area, grid size and other setting on the DASY software.
- (f) Measure SAR transmitting at the middle channel for all applicable exposure positions.
- (g) Identify the exposure position and device configuration resulting the highest SAR
- (h) Measure SAR at the lowest and highest channels at the worst exposure position and device configuration if applicable.

According to the test standard, the recommended procedure for assessing the peak spatial-average SAR value consists of the following steps:

- (a) Power reference measurement
- (b) Area scan
- (c) Zoom scan
- (d) Power drift measurement

9.1 Spatial Peak SAR Evaluation

The procedure for spatial peak SAR evaluation has been implemented according to the test standard. It can be conducted for 1g and 10g, as well as for user-specific masses. The DASY software includes all numerical procedures necessary to evaluate the spatial peak SAR value.

The base for the evaluation is a "cube" measurement. The measured volume must include the 1g and 10g cubes with the highest averaged SAR values. For that purpose, the center of the measured volume is aligned to the interpolated peak SAR value of a previously performed area scan.

The entire evaluation of the spatial peak values is performed within the post-processing engine (SEMCAD). The system always gives the maximum values for the 1g and 10g cubes. The algorithm to find the cube with highest averaged SAR is divided into the following stages:

- (a) Extraction of the measured data (grid and values) from the Zoom Scan
- (b) Calculation of the SAR value at every measurement point based on all stored data (A/D values and measurement parameters)
- (c) Generation of a high-resolution mesh within the measured volume
- (d) Interpolation of all measured values from the measurement grid to the high-resolution grid
- (e) Extrapolation of the entire 3-D field distribution to the phantom surface over the distance from sensor to surface
- (f) Calculation of the averaged SAR within masses of 1g and 10g

9.2 Power Reference Measurement

The Power Reference Measurement and Power Drift Measurements are for monitoring the power drift of the device under test in the batch process. The minimum distance of probe sensors to surface determines the closest measurement point to phantom surface. This distance cannot be smaller

than the distance of sensor calibration points to probe tip as defined in the probe properties.

9.3 Area Scan Procedures

The area scan is used as a fast scan in two dimensions to find the area of high field values, before doing a fine measurement around the hot spot. The sophisticated interpolation routines implemented in DASY software can find the maximum found in the scanned area, within a range of the global maximum. The range (in dB) is specified in the standards for compliance testing. For example, a 2 dB range is required in IEEE standard 1528 and IEC 62209 standards, whereby 3 dB is a requirement when compliance is assessed in accordance with the ARIB standard (Japan), if only one zoom scan follows the area scan, then only the absolute maximum will be taken as reference. For cases where multiple maximums are detected, the number of zoom scans has to be increased accordingly.

Area scan parameters extracted from FCC KDB 865664 D01 SAR measurement 100 MHz to 6 GHz.

	≤ 3 GHz	> 3 GHz
Maximum distance from closest measurement point (geometric center of probe sensors) to phantom surface	5 ± 1 mm	$\frac{1}{2} \cdot \delta \cdot \ln(2) \pm 0.5$ mm
Maximum probe angle from probe axis to phantom surface normal at the measurement location	30° ± 1°	20° ± 1°
Maximum area scan spatial resolution: Δx_{Area} , Δy_{Area}	≤ 2 GHz: ≤ 15 mm 2 – 3 GHz: ≤ 12 mm	3 – 4 GHz: ≤ 12 mm 4 – 6 GHz: ≤ 10 mm
	When the x or y dimension of the test device, in the measurement plane orientation, is smaller than the above, the measurement resolution must be ≤ the corresponding x or y dimension of the test device with at least one measurement point on the test device.	

9.4 Zoom Scan Procedures

Zoom scans are used to assess the peak spatial SAR values within a cubic averaging volume containing 1 gram and 10gram of simulated tissue. The zoom scan measures points (refer to table below) within a cube whose base faces are centered on the maxima found in a preceding area scan job within the same procedure. When the measurement is done, the zoom scan evaluates the averaged SAR for 1 gram and 10 gram and displays these values next to the job's label.

Zoom scan parameters extracted from FCC KDB 865664 D01 SAR measurement 100 MHz to 6 GHz.

		≤ 3 GHz	> 3 GHz
Maximum distance from closest measurement point (geometric center of probe sensors) to phantom surface		$5 \text{ mm} \pm 1 \text{ mm}$	$\frac{1}{2} \cdot \delta \cdot \ln(2) \text{ mm} \pm 0.5 \text{ mm}$
Maximum probe angle from probe axis to phantom surface normal at the measurement location		$30^\circ \pm 1^\circ$	$20^\circ \pm 1^\circ$
Maximum area scan spatial resolution: $\Delta x_{\text{Area}}, \Delta y_{\text{Area}}$		≤ 2 GHz: $\leq 15 \text{ mm}$ 2 – 3 GHz: $\leq 12 \text{ mm}$	3 – 4 GHz: $\leq 12 \text{ mm}$ 4 – 6 GHz: $\leq 10 \text{ mm}$
		When the x or y dimension of the test device, in the measurement plane orientation, is smaller than the above, the measurement resolution must be \leq the corresponding x or y dimension of the test device with at least one measurement point on the test device.	
Maximum zoom scan spatial resolution: $\Delta x_{\text{Zoom}}, \Delta y_{\text{Zoom}}$		≤ 2 GHz: $\leq 8 \text{ mm}$ 2 – 3 GHz: $\leq 5 \text{ mm}^*$	3 – 4 GHz: $\leq 5 \text{ mm}^*$ 4 – 6 GHz: $\leq 4 \text{ mm}^*$
Maximum zoom scan spatial resolution, normal to phantom surface	uniform grid: $\Delta z_{\text{Zoom}}(n)$	$\leq 5 \text{ mm}$	3 – 4 GHz: $\leq 4 \text{ mm}$ 4 – 5 GHz: $\leq 3 \text{ mm}$ 5 – 6 GHz: $\leq 2 \text{ mm}$
	graded grid	$\Delta z_{\text{Zoom}}(1)$: between 1 st two points closest to phantom surface	$\leq 4 \text{ mm}$
		$\Delta z_{\text{Zoom}}(n>1)$: between subsequent points	$\leq 1.5 \cdot \Delta z_{\text{Zoom}}(n-1) \text{ mm}$
Minimum zoom scan volume	x, y, z	$\geq 30 \text{ mm}$	3 – 4 GHz: $\geq 28 \text{ mm}$ 4 – 5 GHz: $\geq 25 \text{ mm}$ 5 – 6 GHz: $\geq 22 \text{ mm}$
<p>Note: δ is the penetration depth of a plane-wave at normal incidence to the tissue medium; see IEEE Std 1528-2013 for details.</p> <p>* When zoom scan is required and the <i>reported</i> SAR from the <i>area scan based 1-g SAR estimation</i> procedures of KDB Publication 447498 is $\leq 1.4 \text{ W/kg}$, $\leq 8 \text{ mm}$, $\leq 7 \text{ mm}$ and $\leq 5 \text{ mm}$ zoom scan resolution may be applied, respectively, for 2 GHz to 3 GHz, 3 GHz to 4 GHz and 4 GHz to 6 GHz.</p>			

9.5 Volume Scan Procedures

The volume scan is used for assess overlapping SAR distributions for antennas transmitting in different frequency bands. It is equivalent to an oversized zoom scan used in standalone measurements. The measurement volume will be used to enclose all the simultaneous transmitting antennas. For antennas transmitting simultaneously in different frequency bands, the volume scan is measured separately in each frequency band. In order to sum correctly to compute the 1g aggregate SAR, the EUT remain in the same test position for all measurements and all volume scan use the same spatial resolution and grid spacing. When all volume scan were completed, the software, SEMCAD postprocessor can combine and subsequently superpose these measurement data to calculating the multiband SAR.

9.6 Power Drift Monitoring

All SAR testing is under the EUT install full charged battery and transmit maximum output power. In DASY measurement software, the power reference measurement and power drift measurement procedures are used for monitoring the power drift of EUT during SAR test. Both these procedures measure the field at a specified reference position before and after the SAR testing. The software will calculate the field difference in dB. If the power drift more than 5%, the SAR will be retested.

10 TEST CONDITIONS AND RESULTS

10.1 Conducted Power

<GSM Conducted power>

Band GSM850	Burst Average Power (dBm)				Frame-Average Power (dBm)		
TX Channel	Tune-up limit (dBm)	128	190	251	128	190	251
Frequency (MHz)		824.2	836.6	848.8	824.2	836.6	848.6
GSM	33.0	32.38	32.62	31.84	23.35	23.59	22.81
GPRS (GMSK, 1 Tx slot)	33.0	32.69	32.73	32.77	23.66	23.70	23.74
GPRS (GMSK, 2 Tx slots)	30.0	28.96	29.01	29.46	22.94	22.99	23.44
GPRS (GMSK, 3 Tx slots)	28.0	27.59	27.72	27.71	23.33	23.46	23.45
GPRS (GMSK, 4 Tx slots)	27.0	26.37	26.49	26.23	23.36	23.48	23.22
Band PCS1900	Burst Average Power (dBm)				Frame-Average Power (dBm)		
TX Channel	Tune-up limit (dBm)	512	661	810	512	661	810
Frequency (MHz)		1850.2	1880.0	1909.8	1850.2	1880.0	1909.8
GSM	31.0	29.76	30.24	30.51	20.73	21.21	21.48
GPRS (GMSK, 1 Tx slot)	31.0	30.85	30.27	30.28	21.82	21.24	21.25
GPRS (GMSK, 2 Tx slots)	28.0	27.32	27.67	27.12	21.30	21.65	21.10
GPRS (GMSK, 3 Tx slots)	26.0	25.17	25.27	25.60	20.91	21.01	21.34
GPRS (GMSK, 4 Tx slots)	25.0	24.06	24.67	24.80	21.05	21.66	21.79

Remark: The frame-averaged power is linearly scaled the maximum burst averaged power over 8 time slots.
The calculated method are shown as below:
Frame-averaged power = Maximum burst averaged power (1 Tx Slot) – 9.03 dB
Frame-averaged power = Maximum burst averaged power (2 Tx Slots) – 6.02 dB
Frame-averaged power = Maximum burst averaged power (3 Tx Slots) - 4.26 dB
Frame-averaged power = Maximum burst averaged power (4 Tx Slots) – 3.01 dB

Note:

- Per KDB 447498 D01, the maximum output power channel is used for SAR testing and for further SAR test reduction
- For Data mode SAR testing, GPRS and EDGE should be evaluated, therefore the EUT was set in corresponding TX slots due to its highest frame-average power.

<WCDMA Conducted Power>

The following tests were conducted according to the test requirements outlines in 3GPP TS 34.121 specification.

A summary of these settings is illustrated below:

HSDPA Setup Configuration:

- The EUT was connected to Base Station Agilent E5515C referred to the Setup Configuration.
- The RF path losses were compensated into the measurements.
- A call was established between EUT and Base Station with following setting:

- i. Set Gain Factors (β_c and β_d) and parameters were set according to each
 - ii. Specific sub-test in the following table, C10.1.4, quoted from the TS 34.121
 - iii. Set RMC 12.2Kbps + HSDPA mode.
 - iv. Set Cell Power = -86 dBm
 - v. Set HS-DSCH Configuration Type to FRC (H-set 1, QPSK)
 - vi. Select HSDPA Uplink Parameters
 - vii. Set Delta ACK, Delta NACK and Delta CQI = 8
 - viii. Set Ack-Nack Repetition Factor to 3
 - ix. Set CQI Feedback Cycle (k) to 4 ms
 - x. Set CQI Repetition Factor to 2
 - xi. Power Ctrl Mode = All Up bits
- d. The transmitted maximum output power was recorded.

Table C.10.1.4: β values for transmitter characteristics tests with HS-DPCCH

Sub-test	β_c	β_d	β_d (SF)	β_c/β_d	β_{hs} (Note 1, Note 2)	CM (dB) (Note 3)	MPR (dB) (Note 3)
1	2/15	15/15	64	2/15	4/15	0.0	0.0
2	12/15 (Note 4)	15/15 (Note 4)	64	12/15 (Note 4)	24/15	1.0	0.0
3	15/15	8/15	64	15/8	30/15	1.5	0.5
4	15/15	4/15	64	15/4	30/15	1.5	0.5

Note 1: Δ_{ACK} , Δ_{NACK} and $\Delta_{CQI} = 30/15$ with $\beta_{hs} = 30/15 * \beta_c$.

Note 2: For the HS-DPCCH power mask requirement test in clause 5.2C, 5.7A, and the Error Vector Magnitude (EVM) with HS-DPCCH test in clause 5.13.1A, and HSDPA EVM with phase discontinuity in clause 5.13.1AA, Δ_{ACK} and $\Delta_{NACK} = 30/15$ with $\beta_{hs} = 30/15 * \beta_c$, and $\Delta_{CQI} = 24/15$ with $\beta_{hs} = 24/15 * \beta_c$.

Note 3: CM = 1 for $\beta_c/\beta_d = 12/15$, $\beta_{hs}/\beta_c = 24/15$. For all other combinations of DPDCH, DPCCH and HS-DPCCH the MPR is based on the relative CM difference. This is applicable for only UEs that support HSDPA in release 6 and later releases.

Note 4: For subtest 2 the β_c/β_d ratio of 12/15 for the TFC during the measurement period (TF1, TF0) is achieved by setting the signalled gain factors for the reference TFC (TF1, TF1) to $\beta_c = 11/15$ and $\beta_d = 15/15$.

Setup Configuration

HSUPA Setup Configuration:

- a. The EUT was connected to Base Station Agilent E5515C referred to the Setup Configuration.
- b. The RF path losses were compensated into the measurements.
- c. A call was established between EUT and Base Station with following setting * :
 - i. Call Configs = 5.2B, 5.9B, 5.10B, and 5.13.2B with QPSK
 - ii. Set the Gain Factors (β_c and β_d) and parameters (AG Index) were set according to each specific sub-test in the following table, C11.1.3, quoted from the TS 34.121
 - iii. Set Cell Power = -86 dBm
 - iv. Set Channel Type = 12.2k + HSPA
 - v. Set UE Target Power
 - vi. Power Ctrl Mode= Alternating bits
 - vii. Set and observe the E-TFCI
 - viii. Confirm that E-TFCI is equal to the target E-TFCI of 75 for sub-test 1, and other subtest's E-TFCI
- d. The transmitted maximum output power was recorded.

Table C.11.1.3: β values for transmitter characteristics tests with HS-DPCCH and E-DCH

Sub-test	β_c	β_d	β_d (SF)	β_c/β_d	β_{HS} (Note 1)	β_{ec}	β_{ed} (Note 5) (Note 6)	β_{ed} (SF)	β_{ed} (Codes)	CM (dB) (Note 2)	MPR (dB) (Note 2)	AG Index (Note 6)	E-TFCI
1	11/15 (Note 3)	15/15 (Note 3)	64	11/15 (Note 3)	22/15	209/225	1309/225	4	1	1.0	0.0	20	75
2	6/15	15/15	64	6/15	12/15	12/15	94/75	4	1	3.0	2.0	12	67
3	15/15	9/15	64	15/9	30/15	30/15	$\beta_{ed1}: 47/15$ $\beta_{ed2}: 47/15$	4	2	2.0	1.0	15	92
4	2/15	15/15	64	2/15	4/15	2/15	56/75	4	1	3.0	2.0	17	71
5	15/15 (Note 4)	15/15 (Note 4)	64	15/15 (Note 4)	30/15	24/15	134/15	4	1	1.0	0.0	21	81

Note 1: $\Delta_{ACK}, \Delta_{NACK}$ and $\Delta_{CQI} = 30/15$ with $\beta_{hs} = 30/15 * \beta_c$.

Note 2: CM = 1 for $\beta_c/\beta_d = 12/15$, $\beta_{hs}/\beta_c = 24/15$. For all other combinations of DPDCH, DPCCH, HS-DPCCH, E-DPDCH and E-DPCCH the MPR is based on the relative CM difference.

Note 3: For subtest 1 the β_c/β_d ratio of 11/15 for the TFC during the measurement period (TF1, TF0) is achieved by setting the signalled gain factors for the reference TFC (TF1, TF1) to $\beta_c = 10/15$ and $\beta_d = 15/15$.

Note 4: For subtest 5 the β_c/β_d ratio of 15/15 for the TFC during the measurement period (TF1, TF0) is achieved by setting the signalled gain factors for the reference TFC (TF1, TF1) to $\beta_c = 14/15$ and $\beta_d = 15/15$.

Note 5: In case of testing by UE using E-DPDCH Physical Layer category 1, Sub-test 3 is omitted according to TS25.306 Table 5.1g.

Note 6: β_{ed} can not be set directly, it is set by Absolute Grant Value.

Setup Configuration

<WCDMA Conducted Power>

WCDMA	Band II (dBm)			Band IV (dBm)			Band V (dBm)					
TX Channel	Tune-up	9262	9400	9538	Tune-up	1312	1412	1513	Tune-up	4132	4183	4233
Frequency (MHz)	limit (dBm)	1852.4	1880.0	1907.6	limit (dBm)	1712.4	1732.6	1752.6	limit (dBm)	826.4	836.6	846.6
RMC 12.2Kbps	24.0	23.61	22.95	22.99	24.0	23.44	23.46	23.43	24.0	23.45	22.80	23.56
RMC AMR	24.0	23.64	23.73	23.16	24.0	23.82	23.59	22.79	24.0	23.04	22.99	22.77
HSDPA Subtest-1	23.0	22.10	21.71	22.06	23.0	22.38	22.64	22.34	23.0	22.47	22.31	21.77
HSDPA Subtest-2	22.0	21.24	21.07	21.79	22.0	21.50	21.02	21.31	22.0	21.50	20.98	21.80
HSDPA Subtest-3	22.0	21.27	21.10	20.97	22.0	20.88	21.11	21.42	22.0	21.79	21.59	21.13
HSDPA Subtest-4	21.0	20.19	20.64	20.26	21.0	20.63	20.09	20.36	21.0	20.78	20.65	20.48
HSUPA Subtest-1	23.0	22.38	21.74	22.09	23.0	22.70	22.25	22.25	23.0	22.80	21.92	22.69
HSUPA Subtest-2	22.0	21.05	20.82	20.92	22.0	20.92	21.85	20.76	22.0	21.66	21.82	21.13
HSUPA Subtest-3	22.0	21.21	21.79	20.99	22.0	21.78	21.67	21.52	22.0	21.43	20.81	21.04
HSUPA Subtest-4	21.0	19.82	20.66	20.78	21.0	19.84	20.13	20.78	21.0	20.62	20.72	20.61
HSUPA Subtest-5	21.0	20.65	20.63	20.49	21.0	20.25	19.75	20.85	21.0	20.71	20.55	19.96

General Note

- Per KDB 941225 D01 v02, RMC 12.2kbps setting is used to evaluate SAR as primary mode. When the maximum output power and tune-up tolerance specified for production units in a secondary mode is $\leq \frac{1}{4}$ dB higher than the primary mode or when the highest reported SAR of the primary mode is scaled by the ratio of specified maximum output power and tune-up tolerance of secondary to primary mode and the adjusted SAR is ≤ 1.2 W/kg, SAR measurement is not required for the secondary mode.
- It is expected by the manufacturer that MPR for some HSDPA/HSUPA subtests may differ from the specification of 3GPP, according to the chipset implementation in this model. The implementation and expected deviation are detailed in tune-up procedure exhibit.

<LTE Conducted Power>

LTE Band 2							
BW (MHz)	Modulation	RB Size	RB Offset	Channel/Frequency(MHz)			Tune-up limit (dBm)
				18700	18900	19100	
				1860	1880	1900	
20	QPSK	1	0	23.92	23.07	23.52	24.00
20	QPSK	1	49	23.07	23.89	23.52	
20	QPSK	1	99	23.27	23.33	23.89	
20	QPSK	50	0	22.37	22.42	22.40	23.00
20	QPSK	50	24	22.23	22.24	22.34	
20	QPSK	50	50	22.33	22.07	22.24	
20	QPSK	100	0	22.35	22.18	22.16	23.00
20	16QAM	1	0	22.40	22.38	22.06	23.00
20	16QAM	1	49	22.36	22.22	22.44	
20	16QAM	1	99	22.08	22.06	22.32	
20	16QAM	50	0	21.25	21.41	21.34	22.00
20	16QAM	50	24	21.26	21.53	21.38	
20	16QAM	50	50	21.18	21.35	21.39	
20	16QAM	100	0	21.43	21.19	21.34	22.00
BW (MHz)	Modulation	RB Size	RB Offset	Channel/Frequency(MHz)			Tune-up limit (dBm)
				18675	18900	19125	
				1857.5	1880	1902.5	
15	QPSK	1	0	23.75	23.39	23.24	24.00
15	QPSK	1	37	23.87	23.61	23.78	
15	QPSK	1	74	23.06	23.62	23.43	
15	QPSK	36	0	22.19	22.03	22.23	23.00
15	QPSK	36	20	22.27	22.43	22.31	
15	QPSK	36	39	22.08	22.21	22.06	
15	QPSK	75	0	22.13	22.18	22.10	23.00
15	16QAM	1	0	22.12	22.33	22.06	23.00
15	16QAM	1	37	22.11	22.28	22.03	
15	16QAM	1	74	22.30	22.24	22.38	
15	16QAM	36	0	21.27	21.34	21.15	22.00
15	16QAM	36	20	21.26	21.30	21.36	
15	16QAM	36	39	21.21	21.30	21.15	
15	16QAM	75	0	21.50	21.17	21.29	22.00

BW (MHz)	Modulation	RB Size	RB Offset	Channel/Frequency(MHz)			Tune-up limit (dBm)
				18650	18900	19150	
				1855	1880	1905	
10	QPSK	1	0	23.45	23.61	23.27	24.00
10	QPSK	1	25	23.00	23.39	23.69	
10	QPSK	1	49	23.79	23.22	23.69	
10	QPSK	25	0	22.40	22.23	22.05	23.00
10	QPSK	25	12	22.42	22.44	22.11	
10	QPSK	25	25	22.33	22.11	22.33	
10	QPSK	50	0	22.32	22.26	22.42	23.00
10	16QAM	1	0	22.27	22.03	22.18	23.00
10	16QAM	1	25	22.15	22.22	22.32	
10	16QAM	1	49	22.31	22.39	22.02	
10	16QAM	25	0	21.41	21.27	21.32	22.00
10	16QAM	25	12	21.55	21.16	21.25	
10	16QAM	25	25	21.44	21.30	21.24	
10	16QAM	50	0	21.48	21.26	21.38	22.00
BW (MHz)	Modulation	RB Size	RB Offset	Channel/Frequency(MHz)			Tune-up limit (dBm)
				18625	18900	19175	
				1852.5	1880	1907.5	
5	QPSK	1	0	23.79	23.62	23.49	24.00
5	QPSK	1	12	23.84	23.55	23.46	
5	QPSK	1	24	23.00	23.59	23.43	
5	QPSK	12	0	22.35	22.38	22.44	23.00
5	QPSK	12	7	22.22	22.20	22.21	
5	QPSK	12	13	22.06	22.20	22.31	
5	QPSK	25	0	22.16	22.23	22.10	23.00
5	16QAM	1	0	22.14	22.11	22.24	23.00
5	16QAM	1	12	22.23	22.37	22.25	
5	16QAM	1	24	22.22	22.38	22.13	
5	16QAM	12	0	21.34	21.38	21.48	22.00
5	16QAM	12	7	21.32	21.45	21.44	
5	16QAM	12	13	21.22	21.41	21.54	
5	16QAM	25	0	21.49	21.37	21.20	22.00

BW (MHz)	Modulation	RB Size	RB Offset	Channel/Frequency(MHz)			Tune-up limit (dBm)
				18615	18900	19185	
				1851.5	1880	1908.5	
3	QPSK	1	0	23.23	23.15	23.46	24.00
3	QPSK	1	8	23.95	23.10	23.55	
3	QPSK	1	14	23.87	23.63	23.36	
3	QPSK	8	0	22.20	22.45	22.03	23.00
3	QPSK	8	4	22.02	22.08	22.03	23.00
3	QPSK	8	7	22.09	22.19	22.31	
3	QPSK	15	0	22.18	22.30	22.36	
3	16QAM	1	0	22.40	22.20	22.21	23.00
3	16QAM	1	8	22.29	22.43	22.16	
3	16QAM	1	14	22.05	22.03	22.01	
3	16QAM	8	0	21.25	21.55	21.48	22.00
3	16QAM	8	4	21.22	21.54	21.25	
3	16QAM	8	7	21.54	21.40	21.29	
3	16QAM	15	0	21.39	21.17	21.30	22.00
BW (MHz)	Modulation	RB Size	RB Offset	Channel/Frequency(MHz)			Tune-up limit (dBm)
				18607	18900	19193	
				1850.7	1880	1909.3	
1.4	QPSK	1	0	23.16	23.50	23.52	24.00
1.4	QPSK	1	3	23.58	23.74	23.34	
1.4	QPSK	1	5	23.72	23.45	23.58	
1.4	QPSK	3	0	22.45	22.03	22.30	23.00
1.4	QPSK	3	1	22.29	22.34	22.13	
1.4	QPSK	3	3	22.40	22.40	22.35	
1.4	QPSK	6	0	22.42	22.23	22.02	23.00
1.4	16QAM	1	0	22.44	22.34	22.33	23.00
1.4	16QAM	1	3	22.03	22.12	22.20	
1.4	16QAM	1	5	22.31	22.22	22.03	
1.4	16QAM	3	0	21.47	21.44	21.32	22.00
1.4	16QAM	3	1	21.32	21.19	21.18	
1.4	16QAM	3	3	21.29	21.42	21.37	
1.4	16QAM	6	0	21.41	21.27	21.15	22.00

LTE Band 4							
BW (MHz)	Modulation	RB Size	RB Offset	Channel/Frequency(MHz)			Tune-up limit (dBm)
				20050	20175	20300	
				1720	1747.5	1775	
20	QPSK	1	0	23.40	23.50	23.86	24.00
20	QPSK	1	49	23.10	23.61	23.83	
20	QPSK	1	99	23.60	23.29	23.62	
20	QPSK	50	0	22.18	22.13	22.02	23.00
20	QPSK	50	24	22.41	22.07	22.07	
20	QPSK	50	50	22.01	22.39	22.12	
20	QPSK	100	0	22.11	22.19	22.22	23.00
20	16QAM	1	0	22.43	22.25	22.17	23.00
20	16QAM	1	49	22.32	22.28	22.09	
20	16QAM	1	99	22.32	22.25	22.24	
20	16QAM	50	0	21.46	21.27	21.50	22.00
20	16QAM	50	24	21.52	21.34	21.24	
20	16QAM	50	50	21.22	21.46	21.50	
20	16QAM	100	0	21.54	21.54	21.19	22.00
BW (MHz)	Modulation	RB Size	RB Offset	Channel/Frequency(MHz)			Tune-up limit (dBm)
				20025	20175	20325	
				1717.5	1747.5	1777.5	
15	QPSK	1	0	23.00	23.26	23.23	24.00
15	QPSK	1	37	23.88	23.91	23.53	
15	QPSK	1	74	23.36	23.83	23.10	
15	QPSK	36	0	22.33	22.30	22.39	23.00
15	QPSK	36	20	22.30	22.29	22.39	
15	QPSK	36	39	22.07	22.29	22.17	
15	QPSK	75	0	22.13	22.26	22.25	23.00
15	16QAM	1	0	22.27	22.31	22.37	23.00
15	16QAM	1	37	22.18	22.38	22.24	
15	16QAM	1	74	22.45	22.39	22.07	
15	16QAM	36	0	21.20	21.18	21.29	22.00
15	16QAM	36	20	21.19	21.28	21.20	
15	16QAM	36	39	21.16	21.42	21.30	
15	16QAM	75	0	21.38	21.30	21.18	22.00

BW (MHz)	Modulation	RB Size	RB Offset	Channel/Frequency(MHz)			Tune-up limit (dBm)
				20000	20175	20350	
				1715	1747.5	1780	
10	QPSK	1	0	23.94	23.36	23.90	24.00
10	QPSK	1	25	23.23	23.15	23.80	
10	QPSK	1	49	23.81	23.61	23.32	
10	QPSK	25	0	22.09	22.32	22.22	23.00
10	QPSK	25	12	22.41	22.40	22.19	
10	QPSK	25	25	22.30	22.07	22.28	
10	QPSK	50	0	22.28	22.24	22.40	23.00
10	16QAM	1	0	22.01	22.15	22.31	23.00
10	16QAM	1	25	22.04	22.24	22.42	
10	16QAM	1	49	22.02	22.16	22.01	
10	16QAM	25	0	21.52	21.27	21.32	22.00
10	16QAM	25	12	21.32	21.36	21.27	
10	16QAM	25	25	21.54	21.55	21.26	
10	16QAM	50	0	21.20	21.34	21.49	22.00
BW (MHz)	Modulation	RB Size	RB Offset	Channel/Frequency(MHz)			Tune-up limit (dBm)
				19975	20175	20375	
				1712.5	1747.5	1782.5	
5	QPSK	1	0	23.17	23.93	23.53	24.00
5	QPSK	1	12	23.29	23.45	23.12	
5	QPSK	1	24	23.89	23.70	23.89	
5	QPSK	12	0	22.22	22.11	22.31	23.00
5	QPSK	12	7	22.44	22.19	22.23	
5	QPSK	12	13	22.43	22.03	22.10	
5	QPSK	25	0	22.34	22.36	22.44	23.00
5	16QAM	1	0	22.36	22.45	22.27	23.00
5	16QAM	1	12	22.03	22.45	22.07	
5	16QAM	1	24	22.15	22.42	22.23	
5	16QAM	12	0	21.15	21.54	21.32	22.00
5	16QAM	12	7	21.47	21.23	21.26	
5	16QAM	12	13	21.30	21.35	21.20	
5	16QAM	25	0	21.28	21.50	21.36	22.00

BW (MHz)	Modulation	RB Size	RB Offset	Channel/Frequency(MHz)			Tune-up limit (dBm)
				19665	20175	20385	
				1711.5	1747.5	1783.5	
3	QPSK	1	0	23.89	23.72	23.73	24.00
3	QPSK	1	8	23.54	23.32	23.75	
3	QPSK	1	14	23.36	23.44	23.47	
3	QPSK	8	0	22.15	22.09	22.17	23.00
3	QPSK	8	4	22.12	22.06	22.36	
3	QPSK	8	7	22.08	22.06	22.37	
3	QPSK	15	0	22.30	22.36	22.13	23.00
3	16QAM	1	0	22.04	22.35	22.02	23.00
3	16QAM	1	8	22.33	22.09	22.09	
3	16QAM	1	14	22.01	22.37	22.43	
3	16QAM	8	0	21.47	21.19	21.20	22.00
3	16QAM	8	4	21.45	21.24	21.54	
3	16QAM	8	7	21.33	21.43	21.33	
3	16QAM	15	0	21.20	21.42	21.44	22.00
BW (MHz)	Modulation	RB Size	RB Offset	Channel/Frequency(MHz)			Tune-up limit (dBm)
				19957	20175	20393	
				1710.7	1747.5	1784.3	
1.4	QPSK	1	0	23.91	23.78	23.42	24.00
1.4	QPSK	1	3	23.89	23.00	23.46	
1.4	QPSK	1	5	23.24	23.66	23.73	
1.4	QPSK	3	0	22.16	22.14	22.19	23.00
1.4	QPSK	3	1	22.16	22.26	22.15	
1.4	QPSK	3	3	22.30	22.14	22.45	
1.4	QPSK	6	0	22.29	22.42	22.27	23.00
1.4	16QAM	1	0	22.35	22.19	22.30	23.00
1.4	16QAM	1	3	22.28	22.34	22.40	
1.4	16QAM	1	5	22.25	22.12	22.18	
1.4	16QAM	3	0	21.43	21.42	21.39	22.00
1.4	16QAM	3	1	21.31	21.40	21.51	
1.4	16QAM	3	3	21.36	21.26	21.36	
1.4	16QAM	6	0	21.20	21.53	21.27	22.00

LTE Band 5							
BW (MHz)	Modulation	RB Size	RB Offset	Channel/Frequency(MHz)			Tune-up limit (dBm)
				20450	20525	20600	
				829	836.5	844	
10	QPSK	1	0	23.11	23.91	23.31	24.00
10	QPSK	1	25	23.41	23.58	23.47	
10	QPSK	1	49	23.10	23.78	23.88	
10	QPSK	25	0	22.13	22.02	22.42	23.00
10	QPSK	25	12	22.03	22.30	22.07	
10	QPSK	25	25	22.35	22.06	22.07	
10	QPSK	50	0	22.17	22.11	22.31	23.00
10	16QAM	1	0	22.35	22.19	22.27	23.00
10	16QAM	1	25	22.39	22.16	22.21	
10	16QAM	1	49	22.13	22.05	22.14	
10	16QAM	25	0	21.49	21.50	21.37	22.00
10	16QAM	25	12	21.55	21.30	21.33	
10	16QAM	25	25	21.22	21.15	21.30	
10	16QAM	50	0	21.18	21.34	21.36	22.00
BW (MHz)	Modulation	RB Size	RB Offset	Channel/Frequency(MHz)			Tune-up limit (dBm)
				20425	20525	20625	
				826.5	836.5	846.5	
5	QPSK	1	0	23.40	23.40	23.81	24.00
5	QPSK	1	12	23.86	23.59	23.26	
5	QPSK	1	24	23.05	23.80	23.12	
5	QPSK	12	0	22.35	22.15	22.19	23.00
5	QPSK	12	7	22.16	22.22	22.20	
5	QPSK	12	13	22.02	22.41	22.17	
5	QPSK	25	0	22.35	22.02	22.25	23.00
5	16QAM	1	0	22.20	22.26	22.11	23.00
5	16QAM	1	12	22.15	22.06	22.44	
5	16QAM	1	24	22.13	22.06	22.24	
5	16QAM	12	0	21.20	21.20	21.47	22.00
5	16QAM	12	7	21.29	21.35	21.44	
5	16QAM	12	13	21.53	21.47	21.47	
5	16QAM	25	0	21.19	21.42	21.26	22.00

BW (MHz)	Modulation	RB Size	RB Offset	Channel/Frequency(MHz)			Tune-up limit (dBm)
				20415	20525	20635	
				825.5	836.5	844	
3	QPSK	1	0	23.85	23.42	23.36	24.00
3	QPSK	1	8	23.55	23.04	23.80	
3	QPSK	1	14	23.02	23.91	23.82	
3	QPSK	8	0	22.22	22.40	22.43	23.00
3	QPSK	8	4	22.01	22.35	22.16	
3	QPSK	8	7	22.37	22.17	22.14	
3	QPSK	15	0	22.24	22.40	22.22	23.00
3	16QAM	1	0	22.16	22.10	22.32	23.00
3	16QAM	1	8	22.06	22.20	22.40	
3	16QAM	1	14	22.31	22.22	22.02	
3	16QAM	8	0	21.18	21.49	21.46	22.00
3	16QAM	8	4	21.25	21.45	21.25	
3	16QAM	8	7	21.42	21.21	21.54	
3	16QAM	15	0	21.37	21.41	21.38	22.00
BW (MHz)	Modulation	RB Size	RB Offset	Channel/Frequency(MHz)			Tune-up limit (dBm)
				20407	20525	20643	
				824.7	836.5	848.3	
1.4	QPSK	1	0	23.82	23.94	23.08	24.00
1.4	QPSK	1	3	23.31	23.85	23.70	
1.4	QPSK	1	5	23.49	23.59	23.96	
1.4	QPSK	3	0	22.09	22.45	22.06	23.00
1.4	QPSK	3	1	22.11	22.15	22.42	
1.4	QPSK	3	3	22.16	22.15	22.03	
1.4	QPSK	6	0	22.34	22.04	22.10	23.00
1.4	16QAM	1	0	22.11	22.37	22.04	23.00
1.4	16QAM	1	3	22.24	22.17	22.44	
1.4	16QAM	1	5	22.38	22.28	22.33	
1.4	16QAM	3	0	21.33	21.40	21.34	22.00
1.4	16QAM	3	1	21.40	21.42	21.50	
1.4	16QAM	3	3	21.23	21.36	21.38	
1.4	16QAM	6	0	21.25	21.44	21.42	22.00

LTE Band 7							
BW (MHz)	Modulation	RB Size	RB Offset	Channel/Frequency(MHz)			Tune-up limit (dBm)
				20850	21100	21350	
				2510	2535	2560	
20	QPSK	1	0	23.66	23.19	23.56	24.00
20	QPSK	1	49	23.35	23.23	23.58	
20	QPSK	1	99	23.70	23.86	23.03	
20	QPSK	50	0	22.01	22.36	22.15	23.00
20	QPSK	50	24	22.34	22.40	22.14	
20	QPSK	50	50	22.21	22.37	22.11	
20	QPSK	100	0	22.38	22.45	22.21	23.00
20	16QAM	1	0	22.26	22.09	22.26	23.00
20	16QAM	1	49	22.44	22.38	22.19	
20	16QAM	1	99	22.19	22.40	22.19	
20	16QAM	50	0	21.18	21.20	21.26	22.00
20	16QAM	50	24	21.54	21.28	21.49	
20	16QAM	50	50	21.31	21.27	21.32	
20	16QAM	100	0	21.33	21.50	21.37	22.00
BW (MHz)	Modulation	RB Size	RB Offset	Channel/Frequency(MHz)			Tune-up limit (dBm)
				20825	21100	21375	
				2507.5	2535	2562.5	
15	QPSK	1	0	23.62	23.48	23.78	24.00
15	QPSK	1	37	23.28	23.29	23.41	
15	QPSK	1	74	23.05	23.53	23.08	
15	QPSK	36	0	22.20	22.02	22.02	23.00
15	QPSK	36	20	22.37	22.33	22.09	
15	QPSK	36	39	22.36	22.05	22.13	
15	QPSK	75	0	22.03	22.23	22.44	23.00
15	16QAM	1	0	22.33	22.26	22.36	23.00
15	16QAM	1	37	22.08	22.03	22.34	
15	16QAM	1	74	22.37	22.32	22.35	
15	16QAM	36	0	21.22	21.55	21.53	22.00
15	16QAM	36	20	21.23	21.20	21.40	
15	16QAM	36	39	21.16	21.37	21.27	
15	16QAM	75	0	21.25	21.33	21.28	22.00

BW (MHz)	Modulation	RB Size	RB Offset	Channel/Frequency(MHz)			Tune-up limit (dBm)
				20800	21100	21400	
				2505	2535	2565	
10	QPSK	1	0	23.33	23.64	23.12	24.00
10	QPSK	1	25	23.32	23.89	23.26	
10	QPSK	1	49	23.14	23.20	23.70	
10	QPSK	25	0	22.45	22.24	22.29	23.00
10	QPSK	25	12	22.16	22.27	22.15	
10	QPSK	25	25	22.30	22.17	22.33	
10	QPSK	50	0	22.44	22.38	22.16	23.00
10	16QAM	1	0	22.30	22.34	22.41	23.00
10	16QAM	1	25	22.13	22.20	22.27	
10	16QAM	1	49	22.16	22.10	22.09	
10	16QAM	25	0	21.44	21.26	21.17	22.00
10	16QAM	25	12	21.35	21.45	21.31	
10	16QAM	25	25	21.32	21.21	21.30	
10	16QAM	50	0	21.49	21.54	21.28	22.00
BW (MHz)	Modulation	RB Size	RB Offset	Channel/Frequency(MHz)			Tune-up limit (dBm)
				20775	21100	21425	
				2502.5	2535	2567.5	
5	QPSK	1	0	23.38	23.35	23.06	24.00
5	QPSK	1	12	23.61	23.48	23.50	
5	QPSK	1	24	23.27	23.87	23.31	
5	QPSK	12	0	22.18	22.02	22.19	23.00
5	QPSK	12	7	22.36	22.44	22.13	
5	QPSK	12	13	22.09	22.44	22.16	
5	QPSK	25	0	22.31	22.03	22.38	23.00
5	16QAM	1	0	22.10	22.45	22.34	23.00
5	16QAM	1	12	22.34	22.39	22.20	
5	16QAM	1	24	22.40	22.08	22.21	
5	16QAM	12	0	21.35	21.41	21.46	22.00
5	16QAM	12	7	21.52	21.24	21.55	
5	16QAM	12	13	21.37	21.54	21.26	
5	16QAM	25	0	21.54	21.40	21.42	22.00

LTE Band 12							
BW (MHz)	Modulation	RB Size	RB Offset	Channel/Frequency(MHz)			Tune-up limit (dBm)
				23060	23095	23130	
				704	707.5	711	
10	QPSK	1	0	23.62	23.14	23.48	24.00
10	QPSK	1	25	23.18	23.65	23.90	
10	QPSK	1	49	23.67	23.14	23.54	
10	QPSK	25	0	22.03	22.31	22.36	23.00
10	QPSK	25	12	22.28	22.20	22.43	
10	QPSK	25	25	22.17	22.45	22.22	
10	QPSK	50	0	22.09	22.35	22.21	23.00
10	16QAM	1	0	22.40	22.35	22.36	23.00
10	16QAM	1	25	22.43	22.35	22.16	
10	16QAM	1	49	22.26	22.02	22.34	
10	16QAM	25	0	21.39	21.51	21.31	22.00
10	16QAM	25	12	21.24	21.32	21.54	
10	16QAM	25	25	21.22	21.48	21.26	
10	16QAM	50	0	21.31	21.26	21.23	22.00
BW (MHz)	Modulation	RB Size	RB Offset	Channel/Frequency(MHz)			Tune-up limit (dBm)
				23035	23095	23155	
				701.5	707.5	713.5	
5	QPSK	1	0	23.95	23.75	23.62	24.00
5	QPSK	1	12	23.57	23.69	23.76	
5	QPSK	1	24	23.73	23.73	23.95	
5	QPSK	12	0	22.43	22.04	22.39	23.00
5	QPSK	12	7	22.35	22.13	22.24	
5	QPSK	12	13	22.27	22.32	22.15	
5	QPSK	25	0	22.39	22.15	22.16	23.00
5	16QAM	1	0	22.20	22.01	22.16	23.00
5	16QAM	1	12	22.05	22.18	22.38	
5	16QAM	1	24	22.17	22.06	22.24	
5	16QAM	12	0	21.39	21.23	21.24	22.00
5	16QAM	12	7	21.15	21.36	21.42	
5	16QAM	12	13	21.37	21.21	21.41	
5	16QAM	25	0	21.54	21.26	21.53	22.00

BW (MHz)	Modulation	RB Size	RB Offset	Channel/Frequency(MHz)			Tune-up limit (dBm)
				23025	23095	23165	
				700.5	707.5	714.5	
3	QPSK	1	0	23.10	23.26	23.94	24.00
3	QPSK	1	8	23.87	23.24	23.08	
3	QPSK	1	14	23.93	23.71	23.57	
3	QPSK	8	0	22.27	22.10	22.04	23.00
3	QPSK	8	4	22.45	22.19	22.34	
3	QPSK	8	7	22.18	22.03	22.01	
3	QPSK	15	0	22.11	22.17	22.02	23.00
3	16QAM	1	0	22.24	22.32	22.05	23.00
3	16QAM	1	8	22.25	22.41	22.41	
3	16QAM	1	14	22.01	22.38	22.03	
3	16QAM	8	0	21.19	21.43	21.26	22.00
3	16QAM	8	4	21.40	21.55	21.46	
3	16QAM	8	7	21.16	21.37	21.50	
3	16QAM	15	0	21.25	21.17	21.33	22.00
BW (MHz)	Modulation	RB Size	RB Offset	Channel/Frequency(MHz)			Tune-up limit (dBm)
				23017	23095	23173	
				699.7	707.5	715.3	
1.4	QPSK	1	0	23.09	23.84	23.14	24.00
1.4	QPSK	1	3	23.84	23.82	23.00	
1.4	QPSK	1	5	23.57	23.30	23.62	
1.4	QPSK	3	0	22.33	22.19	22.45	23.00
1.4	QPSK	3	1	22.08	22.23	22.40	
1.4	QPSK	3	3	22.43	22.23	22.16	
1.4	QPSK	6	0	22.05	22.24	22.10	23.00
1.4	16QAM	1	0	22.35	22.28	22.45	23.00
1.4	16QAM	1	3	22.17	22.19	22.19	
1.4	16QAM	1	5	22.34	22.04	22.23	
1.4	16QAM	3	0	21.48	21.35	21.33	22.00
1.4	16QAM	3	1	21.17	21.37	21.42	
1.4	16QAM	3	3	21.19	21.23	21.19	
1.4	16QAM	6	0	21.17	21.20	21.19	22.00

LTE Band 17							
BW (MHz)	Modulation	RB Size	RB Offset	Channel/Frequency(MHz)			Tune-up limit (dBm)
				23780	23790	23800	
				709	710	711	
10	QPSK	1	0	23.24	23.32	23.60	24.00
10	QPSK	1	25	23.58	23.03	23.81	
10	QPSK	1	49	23.70	23.24	23.35	
10	QPSK	25	0	22.20	22.14	22.41	23.00
10	QPSK	25	12	22.15	22.25	22.45	
10	QPSK	25	25	22.07	22.15	22.26	
10	QPSK	50	0	22.19	22.12	22.02	23.00
10	16QAM	1	0	22.41	22.42	22.11	23.00
10	16QAM	1	25	22.41	22.33	22.40	
10	16QAM	1	49	22.01	22.36	22.12	
10	16QAM	25	0	21.51	21.45	21.42	22.00
10	16QAM	25	12	21.43	21.44	21.44	
10	16QAM	25	25	21.53	21.24	21.36	
10	16QAM	50	0	21.30	21.31	21.19	22.00
BW (MHz)	Modulation	RB Size	RB Offset	Channel/Frequency(MHz)			Tune-up limit (dBm)
				23755	23790	23825	
				706.5	710	713.5	
5	QPSK	1	0	23.52	23.76	23.68	24.00
5	QPSK	1	12	23.75	23.43	23.85	
5	QPSK	1	24	23.07	23.19	23.70	
5	QPSK	12	0	22.33	22.43	22.11	23.00
5	QPSK	12	7	22.40	22.41	22.13	
5	QPSK	12	13	22.44	22.21	22.19	
5	QPSK	25	0	22.13	22.34	22.38	23.00
5	16QAM	1	0	22.08	22.16	22.20	23.00
5	16QAM	1	12	22.26	22.12	22.23	
5	16QAM	1	24	22.15	22.27	22.11	
5	16QAM	12	0	21.28	21.23	21.22	22.00
5	16QAM	12	7	21.52	21.54	21.51	
5	16QAM	12	13	21.17	21.43	21.39	
5	16QAM	25	0	21.30	21.37	21.44	22.00

LTE Band 25							
BW (MHz)	Modulation	RB Size	RB Offset	Channel/Frequency(MHz)			Tune-up limit (dBm)
				26140	26365	26590	
				1860	1882.5	1905	
20	QPSK	1	0	23.44	23.27	23.19	24.00
20	QPSK	1	49	23.14	23.29	23.11	
20	QPSK	1	99	23.78	23.03	23.51	
20	QPSK	50	0	22.39	22.38	22.27	23.00
20	QPSK	50	24	22.19	22.36	22.04	
20	QPSK	50	50	22.26	22.17	22.01	
20	QPSK	100	0	22.07	22.42	22.36	23.00
20	16QAM	1	0	22.16	22.16	22.04	23.00
20	16QAM	1	49	22.12	22.10	22.06	
20	16QAM	1	99	22.13	22.28	22.26	
20	16QAM	50	0	21.29	21.51	21.53	22.00
20	16QAM	50	24	21.47	21.26	21.51	
20	16QAM	50	50	21.46	21.49	21.48	
20	16QAM	100	0	21.35	21.27	21.33	22.00
BW (MHz)	Modulation	RB Size	RB Offset	Channel/Frequency(MHz)			Tune-up limit (dBm)
				26115	26365	26615	
				1857.5	1882.5	1907.5	
15	QPSK	1	0	23.33	23.14	23.41	24.00
15	QPSK	1	37	23.56	23.86	23.02	
15	QPSK	1	74	23.78	23.82	23.28	
15	QPSK	36	0	22.28	22.32	22.12	23.00
15	QPSK	36	20	22.23	22.16	22.19	
15	QPSK	36	39	22.18	22.05	22.14	
15	QPSK	75	0	22.38	22.08	22.27	23.00
15	16QAM	1	0	22.25	22.12	22.11	23.00
15	16QAM	1	37	22.35	22.41	22.45	
15	16QAM	1	74	22.14	22.37	22.06	
15	16QAM	36	0	21.33	21.45	21.53	22.00
15	16QAM	36	20	21.42	21.19	21.19	
15	16QAM	36	39	21.50	21.22	21.34	
15	16QAM	75	0	21.50	21.37	21.37	22.00

BW (MHz)	Modulation	RB Size	RB Offset	Channel/Frequency(MHz)			Tune-up limit (dBm)
				26090	26365	26640	
				1855	1882.5	1910	
10	QPSK	1	0	23.84	23.56	23.93	24.00
10	QPSK	1	25	23.62	23.95	23.05	
10	QPSK	1	49	23.84	23.15	23.70	
10	QPSK	25	0	22.04	22.08	22.21	23.00
10	QPSK	25	12	22.29	22.38	22.19	
10	QPSK	25	25	22.36	22.07	22.16	
10	QPSK	50	0	22.04	22.42	22.07	23.00
10	16QAM	1	0	22.24	22.01	22.45	23.00
10	16QAM	1	25	22.37	22.31	22.21	
10	16QAM	1	49	22.35	22.18	22.44	
10	16QAM	25	0	21.53	21.34	21.53	22.00
10	16QAM	25	12	21.43	21.55	21.25	
10	16QAM	25	25	21.47	21.47	21.24	
10	16QAM	50	0	21.25	21.37	21.28	22.00
BW (MHz)	Modulation	RB Size	RB Offset	Channel/Frequency(MHz)			Tune-up limit (dBm)
				26065	26365	26665	
				1852.5	1882.5	1912.5	
5	QPSK	1	0	23.82	23.55	23.78	24.00
5	QPSK	1	12	23.36	23.88	23.83	
5	QPSK	1	24	23.60	23.64	23.48	
5	QPSK	12	0	22.10	22.12	22.12	23.00
5	QPSK	12	7	22.13	22.10	22.27	
5	QPSK	12	13	22.27	22.33	22.16	
5	QPSK	25	0	22.03	22.20	22.29	23.00
5	16QAM	1	0	22.26	22.14	22.23	23.00
5	16QAM	1	12	22.27	22.39	22.41	
5	16QAM	1	24	22.18	22.20	22.38	
5	16QAM	12	0	21.39	21.33	21.29	22.00
5	16QAM	12	7	21.40	21.50	21.52	
5	16QAM	12	13	21.19	21.34	21.28	
5	16QAM	25	0	21.46	21.49	21.27	22.00

BW (MHz)	Modulation	RB Size	RB Offset	Channel/Frequency(MHz)			Tune-up limit (dBm)
				26055	26365	26675	
				1851.5	1882.5	1913.5	
3	QPSK	1	0	23.42	23.02	23.14	24.00
3	QPSK	1	8	23.90	23.96	23.50	
3	QPSK	1	14	23.72	23.08	23.81	
3	QPSK	8	0	22.19	22.11	22.15	23.00
3	QPSK	8	4	22.08	22.01	22.18	
3	QPSK	8	7	22.34	22.08	22.45	
3	QPSK	15	0	22.07	22.16	22.16	23.00
3	16QAM	1	0	22.04	22.26	22.08	23.00
3	16QAM	1	8	22.28	22.37	22.39	
3	16QAM	1	14	22.22	22.43	22.16	
3	16QAM	8	0	21.19	21.46	21.45	22.00
3	16QAM	8	4	21.26	21.31	21.36	
3	16QAM	8	7	21.31	21.37	21.46	
3	16QAM	15	0	21.16	21.21	21.28	22.00
BW (MHz)	Modulation	RB Size	RB Offset	Channel/Frequency(MHz)			Tune-up limit (dBm)
				26047	26365	26683	
				1850.7	1882.5	1914.3	
1.4	QPSK	1	0	23.25	23.77	23.14	24.00
1.4	QPSK	1	3	23.81	23.90	23.31	
1.4	QPSK	1	5	23.50	23.97	23.88	
1.4	QPSK	3	0	22.31	22.42	22.08	23.00
1.4	QPSK	3	1	22.15	22.30	22.26	
1.4	QPSK	3	3	22.31	22.41	22.01	
1.4	QPSK	6	0	22.26	22.36	22.08	23.00
1.4	16QAM	1	0	22.31	22.14	22.44	23.00
1.4	16QAM	1	3	22.30	22.17	22.24	
1.4	16QAM	1	5	22.41	22.01	22.28	
1.4	16QAM	3	0	21.43	21.39	21.18	22.00
1.4	16QAM	3	1	21.53	21.24	21.44	
1.4	16QAM	3	3	21.20	21.15	21.24	
1.4	16QAM	6	0	21.51	21.22	21.36	22.00

LTE Band 26(814MHz-824MHz)							
BW (MHz)	Modulation	RB Size	RB Offset	Channel/Frequency(MHz)			Tune-up limit (dBm)
					26740		
					819		
10	QPSK	1	0		23.62		24.00
10	QPSK	1	25		23.23		
10	QPSK	1	49		23.30		
10	QPSK	25	0		22.45		23.00
10	QPSK	25	12		22.36		
10	QPSK	25	25		22.20		
10	QPSK	50	0		22.11		23.00
10	16QAM	1	0		22.18		23.00
10	16QAM	1	25		22.26		
10	16QAM	1	49		22.12		
10	16QAM	25	0		21.50		22.00
10	16QAM	25	12		21.41		
10	16QAM	25	25		21.41		
10	16QAM	50	0		21.17		22.00
BW (MHz)	Modulation	RB Size	RB Offset	Channel/Frequency(MHz)			Tune-up limit (dBm)
				26715	26740	26765	
				816.5	819	821.5	
5	QPSK	1	0	23.23	23.25	23.13	24.00
5	QPSK	1	12	23.72	23.89	23.13	
5	QPSK	1	24	23.82	23.39	23.05	
5	QPSK	12	0	22.28	22.29	22.15	23.00
5	QPSK	12	7	22.22	22.14	22.06	
5	QPSK	12	13	22.24	22.42	22.29	
5	QPSK	25	0	22.30	22.37	22.14	23.00
5	16QAM	1	0	22.14	22.01	22.14	23.00
5	16QAM	1	12	22.45	22.08	22.10	
5	16QAM	1	24	22.43	22.23	22.28	
5	16QAM	12	0	21.34	21.53	21.43	22.00
5	16QAM	12	7	21.42	21.41	21.16	
5	16QAM	12	13	21.18	21.53	21.46	
5	16QAM	25	0	21.54	21.33	21.23	22.00

BW (MHz)	Modulation	RB Size	RB Offset	Channel/Frequency(MHz)			Tune-up limit (dBm)
				26705	26740	26775	
				815.5	819	822.5	
3	QPSK	1	0	23.91	23.73	23.65	24.00
3	QPSK	1	8	23.50	23.38	23.14	
3	QPSK	1	14	23.46	23.60	23.79	
3	QPSK	8	0	22.23	22.34	22.42	23.00
3	QPSK	8	4	22.32	22.28	22.19	
3	QPSK	8	7	22.30	22.24	22.39	
3	QPSK	15	0	22.30	22.27	22.16	23.00
3	16QAM	1	0	22.02	22.19	22.24	23.00
3	16QAM	1	8	22.33	22.30	22.41	
3	16QAM	1	14	22.43	22.28	22.22	
3	16QAM	8	0	21.17	21.35	21.45	22.00
3	16QAM	8	4	21.31	21.24	21.36	
3	16QAM	8	7	21.52	21.39	21.40	
3	16QAM	15	0	21.54	21.31	21.33	22.00
BW (MHz)	Modulation	RB Size	RB Offset	Channel/Frequency(MHz)			Tune-up limit (dBm)
				26697	26740	26783	
				814.7	819	823.3	
1.4	QPSK	1	0	23.63	23.43	23.36	24.00
1.4	QPSK	1	3	23.55	23.62	23.20	
1.4	QPSK	1	5	23.67	23.29	23.58	
1.4	QPSK	3	0	22.43	22.29	22.39	23.00
1.4	QPSK	3	1	22.41	22.06	22.27	
1.4	QPSK	3	3	22.40	22.32	22.01	
1.4	QPSK	6	0	22.02	22.01	22.16	23.00
1.4	16QAM	1	0	22.01	22.06	22.10	23.00
1.4	16QAM	1	3	22.12	22.01	22.28	
1.4	16QAM	1	5	22.12	22.20	22.35	
1.4	16QAM	3	0	21.22	21.46	21.42	22.00
1.4	16QAM	3	1	21.24	21.42	21.55	
1.4	16QAM	3	3	21.39	21.18	21.39	
1.4	16QAM	6	0	21.49	21.27	21.33	22.00

LTE Band 26(824MHz-849MHz)							
BW (MHz)	Modulation	RB Size	RB Offset	Channel/Frequency(MHz)			Tune-up limit (dBm)
				26865	26915	26965	
				831.5	836.5	841.5	
15	QPSK	1	0	23.44	23.12	23.27	24.00
15	QPSK	1	37	23.55	23.32	23.27	
15	QPSK	1	74	23.35	23.44	23.27	
15	QPSK	36	0	22.04	22.38	22.25	23.00
15	QPSK	36	20	22.39	22.14	22.04	
15	QPSK	36	39	22.26	22.13	22.02	
15	QPSK	75	0	22.30	22.39	22.38	23.00
15	16QAM	1	0	22.01	22.34	22.45	23.00
15	16QAM	1	37	22.39	22.36	22.39	
15	16QAM	1	74	22.12	22.42	22.31	
15	16QAM	36	0	21.16	21.33	21.50	22.00
15	16QAM	36	20	21.37	21.37	21.46	
15	16QAM	36	39	21.18	21.19	21.21	
15	16QAM	75	0	21.31	21.34	21.31	22.00
BW (MHz)	Modulation	RB Size	RB Offset	Channel/Frequency(MHz)			Tune-up limit (dBm)
				26840	26915	26990	
				829	836.5	844	
10	QPSK	1	0	23.76	23.79	23.90	24.00
10	QPSK	1	25	23.57	23.55	23.57	
10	QPSK	1	49	23.02	23.62	23.19	
10	QPSK	25	0	22.40	22.32	22.35	23.00
10	QPSK	25	12	22.24	22.06	22.08	
10	QPSK	25	25	22.22	22.35	22.20	
10	QPSK	50	0	22.28	22.18	22.04	23.00
10	16QAM	1	0	22.24	22.05	22.39	23.00
10	16QAM	1	25	22.30	22.19	22.30	
10	16QAM	1	49	22.36	22.45	22.20	
10	16QAM	25	0	21.24	21.38	21.32	22.00
10	16QAM	25	12	21.30	21.27	21.40	
10	16QAM	25	25	21.50	21.33	21.38	
10	16QAM	50	0	21.46	21.26	21.53	22.00

BW (MHz)	Modulation	RB Size	RB Offset	Channel/Frequency(MHz)			Tune-up limit (dBm)
				26815	26915	27015	
				826.5	836.5	846.5	
5	QPSK	1	0	23.46	23.82	23.60	24.00
5	QPSK	1	12	23.07	23.82	23.09	
5	QPSK	1	24	23.81	23.52	23.23	
5	QPSK	12	0	22.28	22.42	22.05	23.00
5	QPSK	12	7	22.45	22.40	22.40	
5	QPSK	12	13	22.43	22.05	22.27	
5	QPSK	25	0	22.17	22.39	22.30	23.00
5	16QAM	1	0	22.01	22.38	22.01	23.00
5	16QAM	1	12	22.43	22.09	22.32	
5	16QAM	1	24	22.44	22.40	22.28	
5	16QAM	12	0	21.40	21.53	21.51	22.00
5	16QAM	12	7	21.22	21.37	21.19	
5	16QAM	12	13	21.15	21.38	21.33	
5	16QAM	25	0	21.30	21.24	21.49	22.00
BW (MHz)	Modulation	RB Size	RB Offset	Channel/Frequency(MHz)			Tune-up limit (dBm)
				26805	26915	27025	
				825.5	836.5	847.5	
3	QPSK	1	0	23.55	23.75	23.53	24.00
3	QPSK	1	8	23.58	23.09	23.72	
3	QPSK	1	14	23.62	23.86	23.21	
3	QPSK	8	0	22.41	22.38	22.24	23.00
3	QPSK	8	4	22.05	22.03	22.16	
3	QPSK	8	7	22.13	22.01	22.43	
3	QPSK	15	0	22.35	22.18	22.42	23.00
3	16QAM	1	0	22.42	22.13	22.06	23.00
3	16QAM	1	8	22.25	22.06	22.45	
3	16QAM	1	14	22.14	22.11	22.14	
3	16QAM	8	0	21.37	21.38	21.20	22.00
3	16QAM	8	4	21.17	21.17	21.28	
3	16QAM	8	7	21.54	21.42	21.40	
3	16QAM	15	0	21.44	21.33	21.23	22.00

BW (MHz)	Modulation	RB Size	RB Offset	Channel/Frequency(MHz)			Tune-up limit (dBm)
				26797	26915	27033	
				824.7	836.5	848.3	
1.4	QPSK	1	0	23.73	23.71	23.37	24.00
1.4	QPSK	1	3	23.55	23.26	23.26	
1.4	QPSK	1	5	23.95	23.65	23.97	
1.4	QPSK	3	0	22.41	22.26	22.26	23.00
1.4	QPSK	3	1	22.27	22.29	22.24	
1.4	QPSK	3	3	22.02	22.28	22.19	
1.4	QPSK	6	0	22.40	22.24	22.20	23.00
1.4	16QAM	1	0	22.05	22.10	22.19	23.00
1.4	16QAM	1	3	22.01	22.13	22.07	
1.4	16QAM	1	5	22.11	22.11	22.04	
1.4	16QAM	3	0	21.34	21.19	21.15	22.00
1.4	16QAM	3	1	21.51	21.27	21.32	
1.4	16QAM	3	3	21.45	21.30	21.36	
1.4	16QAM	6	0	21.16	21.45	21.41	22.00

LTE Band 66							
BW (MHz)	Modulation	RB Size	RB Offset	Channel/Frequency(MHz)			Tune-up limit (dBm)
				132072	132322	132572	
				1720	1745	1770	
20	QPSK	1	0	23.21	23.77	23.77	24.00
20	QPSK	1	49	23.72	23.04	23.03	
20	QPSK	1	99	23.49	23.01	23.42	
20	QPSK	50	0	22.05	22.11	22.25	23.00
20	QPSK	50	24	22.25	22.13	22.35	
20	QPSK	50	50	22.32	22.08	22.18	
20	QPSK	100	0	22.43	22.39	22.45	23.00
20	16QAM	1	0	22.29	22.07	22.18	23.00
20	16QAM	1	49	22.31	22.27	22.33	
20	16QAM	1	99	22.35	22.36	22.25	
20	16QAM	50	0	21.29	21.52	21.16	22.00
20	16QAM	50	24	21.31	21.39	21.27	
20	16QAM	50	50	21.39	21.33	21.38	
20	16QAM	100	0	21.49	21.22	21.17	22.00
BW (MHz)	Modulation	RB Size	RB Offset	Channel/Frequency(MHz)			Tune-up limit (dBm)
				132047	132322	132597	
				1717.5	1745	1772.5	
15	QPSK	1	0	23.82	23.24	23.79	24.00
15	QPSK	1	37	23.06	23.24	23.44	
15	QPSK	1	74	23.72	23.74	23.72	
15	QPSK	36	0	22.16	22.04	22.27	23.00
15	QPSK	36	20	22.31	22.28	22.43	
15	QPSK	36	39	22.37	22.26	22.07	
15	QPSK	75	0	22.45	22.13	22.44	23.00
15	16QAM	1	0	22.16	22.36	22.39	23.00
15	16QAM	1	37	22.23	22.05	22.15	
15	16QAM	1	74	22.15	22.14	22.22	
15	16QAM	36	0	21.38	21.19	21.45	22.00
15	16QAM	36	20	21.33	21.51	21.42	
15	16QAM	36	39	21.28	21.55	21.49	
15	16QAM	75	0	21.28	21.43	21.46	22.00

BW (MHz)	Modulation	RB Size	RB Offset	Channel/Frequency(MHz)			Tune-up limit (dBm)
				132022	132322	132622	
				1715	1745	1775	
10	QPSK	1	0	23.49	23.58	23.94	24.00
10	QPSK	1	25	23.04	23.18	23.27	
10	QPSK	1	49	23.74	23.13	23.13	
10	QPSK	25	0	22.40	22.21	22.41	23.00
10	QPSK	25	12	22.17	22.33	22.40	
10	QPSK	25	25	22.40	22.26	22.10	
10	QPSK	50	0	22.33	22.37	22.05	23.00
10	16QAM	1	0	22.44	22.13	22.25	23.00
10	16QAM	1	25	22.19	22.10	22.28	
10	16QAM	1	49	22.31	22.11	22.05	
10	16QAM	25	0	21.16	21.48	21.46	22.00
10	16QAM	25	12	21.51	21.39	21.28	
10	16QAM	25	25	21.51	21.36	21.52	
10	16QAM	50	0	21.41	21.41	21.27	22.00
BW (MHz)	Modulation	RB Size	RB Offset	Channel/Frequency(MHz)			Tune-up limit (dBm)
				131997	132322	132647	
				1712.5	1745	1777.5	
5	QPSK	1	0	23.08	23.48	23.15	24.00
5	QPSK	1	12	23.58	23.50	23.12	
5	QPSK	1	24	23.41	23.13	23.30	
5	QPSK	12	0	22.37	22.36	22.12	23.00
5	QPSK	12	7	22.29	22.30	22.31	
5	QPSK	12	13	22.20	22.39	22.41	
5	QPSK	25	0	22.36	22.21	22.29	23.00
5	16QAM	1	0	22.42	22.22	22.35	23.00
5	16QAM	1	12	22.28	22.12	22.15	
5	16QAM	1	24	22.14	22.09	22.27	
5	16QAM	12	0	21.20	21.31	21.51	22.00
5	16QAM	12	7	21.31	21.40	21.46	
5	16QAM	12	13	21.44	21.29	21.54	
5	16QAM	25	0	21.40	21.42	21.55	22.00

BW (MHz)	Modulation	RB Size	RB Offset	Channel/Frequency(MHz)			Tune-up limit (dBm)
				131987	132322	132657	
				1711.5	1745	1778.5	
3	QPSK	1	0	23.63	23.89	23.06	24.00
3	QPSK	1	8	23.73	23.97	23.27	
3	QPSK	1	14	23.81	23.29	23.10	
3	QPSK	8	0	22.20	22.23	22.15	23.00
3	QPSK	8	4	22.22	22.17	22.09	
3	QPSK	8	7	22.44	22.42	22.24	
3	QPSK	15	0	22.06	22.32	22.13	23.00
3	16QAM	1	0	22.43	22.39	22.36	23.00
3	16QAM	1	8	22.21	22.17	22.37	
3	16QAM	1	14	22.23	22.37	22.37	
3	16QAM	8	0	21.42	21.34	21.23	22.00
3	16QAM	8	4	21.33	21.34	21.36	
3	16QAM	8	7	21.27	21.45	21.22	
3	16QAM	15	0	21.41	21.52	21.51	22.00
BW (MHz)	Modulation	RB Size	RB Offset	Channel/Frequency(MHz)			Tune-up limit (dBm)
				131979	132322	132665	
				1710.7	1745	1779.3	
1.4	QPSK	1	0	23.93	23.50	23.50	24.00
1.4	QPSK	1	3	23.75	23.93	23.21	
1.4	QPSK	1	5	23.36	23.63	23.54	
1.4	QPSK	3	0	22.37	22.40	22.33	23.00
1.4	QPSK	3	1	22.25	22.22	22.27	
1.4	QPSK	3	3	22.33	22.01	22.37	
1.4	QPSK	6	0	22.17	22.39	22.26	23.00
1.4	16QAM	1	0	22.43	22.14	22.13	23.00
1.4	16QAM	1	3	22.06	22.27	22.04	
1.4	16QAM	1	5	22.28	22.24	22.02	
1.4	16QAM	3	0	21.53	21.26	21.28	22.00
1.4	16QAM	3	1	21.16	21.32	21.45	
1.4	16QAM	3	3	21.21	21.47	21.53	
1.4	16QAM	6	0	21.47	21.44	21.27	22.00

LTE Band 38							
BW (MHz)	Modulation	RB Size	RB Offset	Channel/Frequency(MHz)			Tune-up limit (dBm)
				37850	38000	38150	
				2580	2595	2610	
20	QPSK	1	0	23.23	23.32	23.25	24.00
20	QPSK	1	49	23.43	23.74	23.04	
20	QPSK	1	99	23.38	23.19	23.11	
20	QPSK	50	0	22.42	22.26	22.05	23.00
20	QPSK	50	24	22.20	22.22	22.21	
20	QPSK	50	50	22.02	22.44	22.05	
20	QPSK	100	0	22.40	22.31	22.42	23.00
20	16QAM	1	0	22.33	22.18	22.27	23.00
20	16QAM	1	49	22.10	22.04	22.11	
20	16QAM	1	99	22.44	22.03	22.03	
20	16QAM	50	0	21.39	21.18	21.55	22.00
20	16QAM	50	24	21.38	21.44	21.23	
20	16QAM	50	50	21.42	21.17	21.43	
20	16QAM	100	0	21.25	21.16	21.47	22.00
BW (MHz)	Modulation	RB Size	RB Offset	Channel/Frequency(MHz)			Tune-up limit (dBm)
				37825	38000	38175	
				2577.5	2595	2612.5	
15	QPSK	1	0	23.36	23.63	23.49	24.00
15	QPSK	1	37	23.76	23.04	23.28	
15	QPSK	1	74	23.11	23.04	23.51	
15	QPSK	36	0	22.32	22.08	22.37	23.00
15	QPSK	36	20	22.12	22.26	22.10	
15	QPSK	36	39	22.44	22.23	22.03	
15	QPSK	75	0	22.34	22.01	22.31	23.00
15	16QAM	1	0	22.33	22.42	22.40	23.00
15	16QAM	1	37	22.17	22.05	22.12	
15	16QAM	1	74	22.16	22.29	22.05	
15	16QAM	36	0	21.37	21.39	21.44	22.00
15	16QAM	36	20	21.45	21.29	21.15	
15	16QAM	36	39	21.29	21.48	21.21	
15	16QAM	75	0	21.31	21.25	21.38	22.00

BW (MHz)	Modulation	RB Size	RB Offset	Channel/Frequency(MHz)			Tune-up limit (dBm)
				37800	38000	38200	
				2575	2595	2615	
10	QPSK	1	0	23.96	23.83	23.83	24.00
10	QPSK	1	25	23.55	23.40	23.23	
10	QPSK	1	49	23.04	23.85	23.01	
10	QPSK	25	0	22.36	22.08	22.37	23.00
10	QPSK	25	12	22.42	22.25	22.36	
10	QPSK	25	25	22.17	22.33	22.35	
10	QPSK	50	0	22.37	22.16	22.08	23.00
10	16QAM	1	0	22.42	22.43	22.27	23.00
10	16QAM	1	25	22.23	22.34	22.27	
10	16QAM	1	49	22.21	22.05	22.39	
10	16QAM	25	0	21.37	21.41	21.42	22.00
10	16QAM	25	12	21.22	21.34	21.17	
10	16QAM	25	25	21.43	21.43	21.20	
10	16QAM	50	0	21.51	21.18	21.31	22.00
BW (MHz)	Modulation	RB Size	RB Offset	Channel/Frequency(MHz)			Tune-up limit (dBm)
				37775	38000	38225	
				2572.5	2595	2617.5	
5	QPSK	1	0	23.58	23.35	23.34	24.00
5	QPSK	1	12	23.16	23.47	23.07	
5	QPSK	1	24	23.34	23.94	23.09	
5	QPSK	12	0	22.41	22.45	22.21	23.00
5	QPSK	12	7	22.09	22.02	22.28	
5	QPSK	12	13	22.43	22.20	22.41	
5	QPSK	25	0	22.33	22.42	22.06	23.00
5	16QAM	1	0	22.26	22.05	22.16	23.00
5	16QAM	1	12	22.13	22.28	22.08	
5	16QAM	1	24	22.02	22.27	22.03	
5	16QAM	12	0	21.29	21.45	21.50	22.00
5	16QAM	12	7	21.28	21.19	21.33	
5	16QAM	12	13	21.26	21.19	21.55	
5	16QAM	25	0	21.31	21.30	21.36	22.00

LTE Band 41									
BW (MHz)	Modulation	RB Size	RB Offset	Channel/Frequency(MHz)					Tune-up limit (dBm)
				40140	40365	40590	40865	41140	
				2545	2567.5	2590	2617.5	2645	
20	QPSK	1	0	23.33	23.56	23.80	23.41	23.15	24.00
20	QPSK	1	49	23.11	23.05	23.12	23.39	23.82	
20	QPSK	1	99	23.33	23.25	23.33	23.33	23.38	
20	QPSK	50	0	22.01	21.96	22.01	21.95	22.06	23.00
20	QPSK	50	24	22.02	21.98	22.01	22.07	22.25	
20	QPSK	50	50	22.25	22.11	22.17	22.09	22.13	
20	QPSK	100	0	22.43	22.22	22.08	22.01	22.03	23.00
20	16QAM	1	0	22.32	22.35	22.45	22.30	22.20	23.00
20	16QAM	1	49	22.08	22.12	22.25	22.27	22.38	
20	16QAM	1	99	22.10	22.12	22.24	22.18	22.26	
20	16QAM	50	0	21.21	21.27	21.39	21.33	21.33	22.00
20	16QAM	50	24	21.18	21.22	21.46	21.34	21.31	
20	16QAM	50	50	21.42	21.47	21.54	21.46	21.41	
20	16QAM	100	0	21.43	21.36	21.32	21.28	21.27	22.00
BW (MHz)	Modulation	RB Size	RB Offset	Channel/Frequency(MHz)					Tune-up limit (dBm)
				40115	40350	40590	40875	41165	
				2542.5	2566	2590	2618.5	2647.5	
15	QPSK	1	0	23.00	23.41	23.97	23.61	23.32	24.00
15	QPSK	1	37	23.58	23.53	23.61	23.49	23.55	
15	QPSK	1	74	23.82	23.60	23.58	23.29	23.04	
15	QPSK	36	0	22.11	22.04	22.04	22.12	22.35	23.00
15	QPSK	36	20	22.42	22.36	22.33	22.21	22.24	
15	QPSK	36	39	22.23	22.27	22.35	22.19	22.06	
15	QPSK	75	0	22.30	22.28	22.45	22.30	22.17	23.00
15	16QAM	1	0	22.04	22.17	22.33	22.23	22.26	23.00
15	16QAM	1	37	22.42	22.33	22.42	22.15	22.03	
15	16QAM	1	74	22.18	22.07	22.10	22.19	22.43	
15	16QAM	36	0	21.16	21.16	21.23	21.24	21.44	22.00
15	16QAM	36	20	21.31	21.27	21.30	21.36	21.48	
15	16QAM	36	39	21.50	21.40	21.37	21.28	21.23	
15	16QAM	75	0	21.40	21.38	21.46	21.46	21.46	22.00

BW (MHz)	Modulation	RB Size	RB Offset	Channel/Frequency(MHz)					Tune-up limit (dBm)
				40090	40340	40590	40890	41190	
				2540	2565	2590	2620	2650	
10	QPSK	1	0	23.48	23.37	23.45	23.39	23.37	24.00
10	QPSK	1	25	23.41	23.42	23.54	23.42	23.30	
10	QPSK	1	49	23.77	23.71	23.68	23.56	23.50	
10	QPSK	25	0	22.27	22.24	22.38	22.33	22.44	23.00
10	QPSK	25	12	22.35	22.17	22.18	22.08	22.06	
10	QPSK	25	25	22.34	22.26	22.22	22.14	22.09	
10	QPSK	50	0	22.17	22.18	22.33	22.29	22.29	23.00
10	16QAM	1	0	22.26	22.23	22.40	22.26	22.31	23.00
10	16QAM	1	25	22.07	22.01	22.07	22.18	22.41	
10	16QAM	1	49	22.04	22.13	22.31	22.28	22.28	
10	16QAM	25	0	21.39	21.22	21.15	21.18	21.22	22.00
10	16QAM	25	12	21.32	21.36	21.46	21.48	21.54	
10	16QAM	25	25	21.21	21.31	21.49	21.35	21.33	
10	16QAM	50	0	21.32	21.32	21.39	21.34	21.35	22.00
BW (MHz)	Modulation	RB Size	RB Offset	Channel/Frequency(MHz)					Tune-up limit (dBm)
				40065	40325	40590	40900	41215	
				2537.5	2563.5	2590	2621	2652.5	
5	QPSK	1	0	23.28	23.31	23.49	23.66	23.87	24.00
5	QPSK	1	12	23.24	23.05	23.04	23.29	23.56	
5	QPSK	1	24	23.88	23.68	23.64	23.34	23.06	
5	QPSK	12	0	22.17	22.06	22.10	22.21	22.37	23.00
5	QPSK	12	7	22.12	22.12	22.24	22.21	22.23	
5	QPSK	12	13	22.44	22.30	22.30	22.19	22.26	
5	QPSK	25	0	22.40	22.19	22.15	22.09	22.07	23.00
5	16QAM	1	0	22.01	22.15	22.42	22.34	22.27	23.00
5	16QAM	1	12	22.34	22.10	22.05	22.02	22.01	
5	16QAM	1	24	22.39	22.31	22.41	22.20	22.16	
5	16QAM	12	0	21.43	21.44	21.53	21.34	21.20	22.00
5	16QAM	12	7	21.33	21.26	21.22	21.18	21.33	
5	16QAM	12	13	21.46	21.28	21.25	21.36	21.52	
5	16QAM	25	0	21.28	21.17	21.15	21.30	21.54	22.00

<WLAN 2.4GHz Conducted Power>

Mode	Channel	Frequency (MHz)	Conducted Peak Output Power(dBm)	Conducted Average Output Power(dBm)	Tune-up limit (dBm)
802.11b	1	2412	13.51	11.91	13.0
	6	2437	14.03	12.44	13.0
	11	2462	14.06	12.51	13.0
802.11g	1	2412	13.38	9.97	10.5
	6	2437	13.31	9.79	10.5
	11	2462	13.29	9.83	10.5
802.11n(HT20)	1	2412	13.24	9.42	10.5
	6	2437	13.68	10.02	10.5
	11	2462	13.72	10.09	10.5
802.11n(HT40)	3	2422	12.29	8.67	10.5
	6	2437	12.81	8.87	10.5
	9	2452	12.93	9.04	10.5

<Bluetooth Conducted Power>

BR/EDR

Mode	Channel	Frequency (MHz)	Conducted Peak Output Power(dBm)	Tune-up limit (dBm)
GFSK	0	2402	-1.18	0.0
	39	2441	-0.96	0.0
	78	2480	-0.13	0.0
$\pi/4$ DQPSK	0	2402	-2.70	-1.0
	39	2441	-2.27	-1.0
	78	2480	-1.47	-1.0
8DPSK	0	2402	-2.66	-1.0
	39	2441	-2.24	-1.0
	78	2480	-1.43	-1.0

BLE

Mode	Channel	Frequency (MHz)	Conducted Peak Output Power(dBm)	Tune-up limit (dBm)
GFSK	00	2402	-3.94	-4.00
	19	2440	-5.19	-4.00
	39	2480	-6.39	-5.00

10.2 Transmit Antennas and SAR Measurement Position

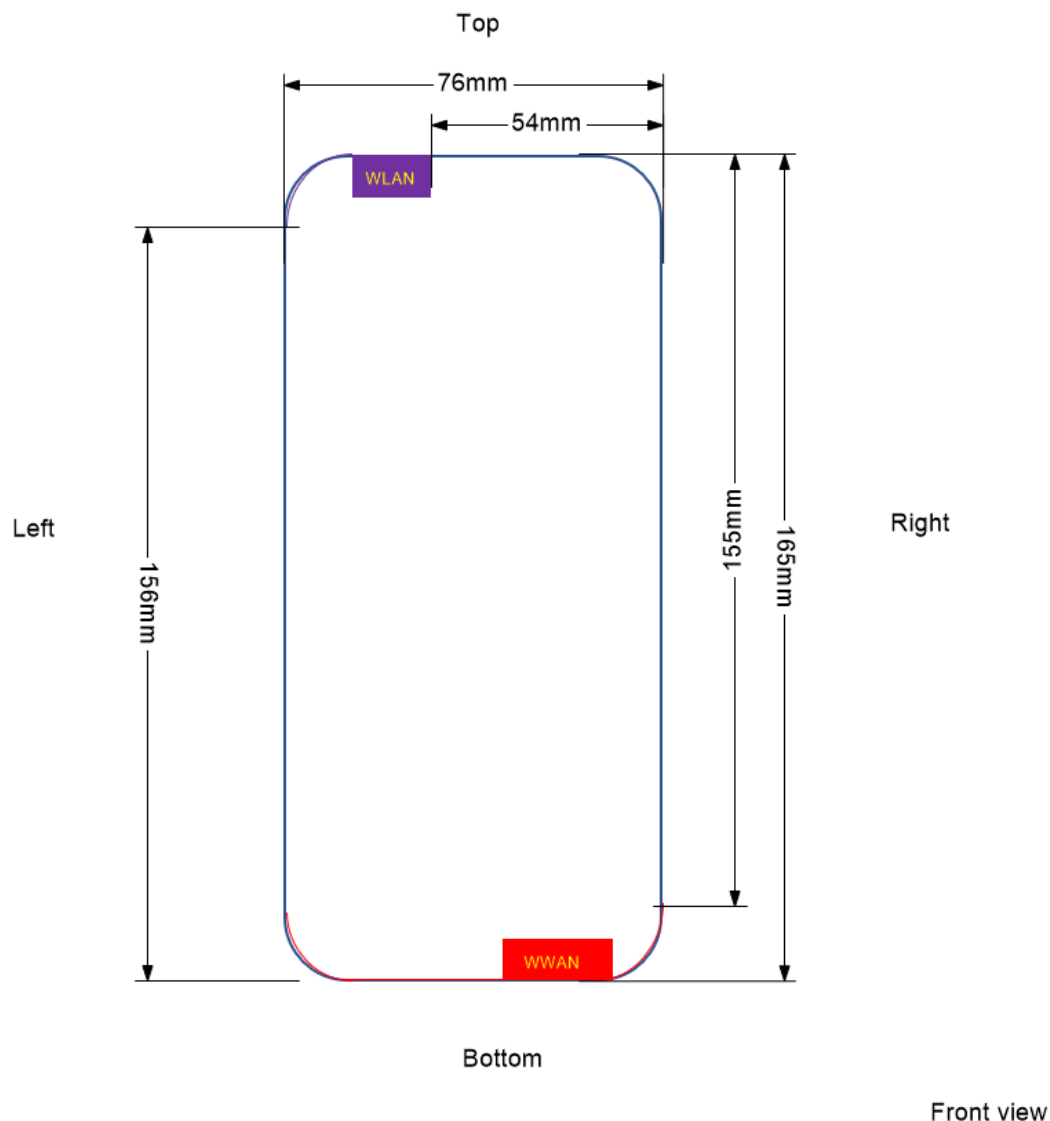

Distance of The Antenna to the EUT surface and edge						
Antennas	Front	Back	Top Side	Bottom Side	Left Side	Right Side
WWAN	<25mm	<25mm	155mm	0 mm	0 mm	0 mm
WLAN	<25mm	<25mm	0mm	156mm	0mm	54mm

Positions for SAR tests; Hotspot mode						
Antennas	Front	Back	Top Side	Bottom Side	Left Side	Right Side
WWAN	Yes	Yes	No	Yes	Yes	Yes
WLAN	Yes	Yes	Yes	No	Yes	No

Note:

1). According to the KDB941225 D06 Hot Spot SAR v02, the edges with less than 2.5 cm distance to the antennas need to be tested for SAR.

10.3 SAR Test Exclusion and Estimated SAR

SAR Test Exclusion Considerations

Per KDB 447498 D01v06, the 1-g and 10-g SAR test exclusion thresholds for 100 MHz to 6 GHz at test separation distances ≤ 50 mm are determined by:

$[(\text{max. power of channel, including tune-up tolerance, mW}) / (\text{min. test separation distance, mm})] \cdot [\sqrt{f(\text{GHz})}] \leq 3.0$ for 1-g SAR and ≤ 7.5 for 10-g extremity SAR

- f(GHz) is the RF channel transmit frequency in GHz.
- Power and distance are rounded to the nearest mW and mm before calculation.
- The result is rounded to one decimal place for comparison.

Per KDB 447498 D01v06, at 100 MHz to 6 GHz and for test separation distances > 50 mm, the SAR test exclusion threshold is determined according to the following:

- $[\text{Threshold at 50mm} + (\text{test separation distance} - 50\text{mm}) \cdot (f(\text{MHz}) / 150)] \text{mW}$, at 100MHz to 1500MHz
- $[\text{Threshold at 50mm} + (\text{test separation distance} - 50\text{mm}) \cdot 10] \text{mW}$ at $> 1500\text{MHz}$ and $\leq 6\text{GHz}$

Estimated SAR

Per KDB447498 requires when the standalone SAR test exclusion of section 4.3.1 is applied to an antenna that transmits simultaneously with other antennas, the standalone SAR must be estimated according to the following to determine simultaneous transmission SAR test exclusion;

- $(\text{max. power of channel, including tune-up tolerance, mW}) / (\text{min. test separation distance, mm}) \cdot [\sqrt{f(\text{GHz})} / x]$ W/kg for test separation distances ≤ 50 mm; where $x = 7.5$ for 1-g SAR, and $x = 18.75$ for 10-g SAR.
- 0.4 W/kg for 1-g SAR and 1.0 W/kg for 10-g SAR, when the test separation distances is > 50 mm

The below table, exemption limits for routine evaluation based on frequency and separation distance was according to SAR-based Exemption – §1.1307(b)(3)(i)(B).

Standalone SAR Test Exclusion and Estimated SAR									
Wireless Interface	Frequency (MHz)	Configuration	Max. Power With tune-up		Distance (mm)	Calculation Result	SAR Exclusion Thresholds	Standalone SAR Exclusion	Estimated SAR (W/Kg)
			dBm	mW					
Bluetooth	2450	Head	0	1.000	5	0.3	3	Yes	0.042
Bluetooth	2450	Body & Hotspot	0	1.000	10	0.2	3	Yes	0.021

Remark:

1. Maximum average power including tune-up tolerance;
2. When the minimum test separation distance is < 5 mm, a distance of 5 mm is applied to determine SAR test exclusion
3. when the distance is < 50 mm exclusion threshold is "Ratio", when the distance is > 50 mm exclusion threshold is "mW".

10.4 SAR Test Results Summary

General Note:

- 1 Per KDB 447498 D01v06, the reported SAR is the measured SAR value adjusted for maximum tune-up tolerance.
 - c) Tune-up scaling Factor = tune-up limit power (mW) / EUT RF power (mW), where tune-up limit is the maximum rated power among all production units.
 - d) For SAR testing of WLAN signal with non-100% duty cycle, the measured SAR is scaled-up by the duty cycle scaling factor which is equal to "1/(duty cycle)"
 - e) For WLAN/Bluetooth: Reported SAR(W/kg)= Measured SAR(W/kg)* Duty Cycle scaling factor * Tune-up scaling factor
- 2 Per KDB 447498 D01v06, for each exposure position, testing of other required channels within the operating mode of a frequency band is not required when the reported 1-g or 10-g SAR for the mid-band or highest output power channel is:
 - ≤ 0.8 W/kg or 2.0 W/kg, for 1-g or 10-g respectively, when the transmission band is ≤ 100 MHz
 - ≤ 0.6 W/kg or 1.5 W/kg, for 1-g or 10-g respectively, when the transmission band is between 100 MHz and 200 MHz
 - ≤ 0.4 W/kg or 1.0 W/kg, for 1-g or 10-g respectively, when the transmission band is ≥ 200 MHz
- 3 Per KDB 865664 D01v01r04, for each frequency band, repeated SAR measurement is required only when the measured SAR is ≥ 0.8 W/kg.

SAR Results

<Head SAR>

SAR Values GSM

Plot No.	Mode	Test Position	Ch.	Freq. (MHz)	Average Power (dBm)	Tune-Up Limit (dBm)	Scaling Factor	Power Drift (dB)	Measured SAR _{1g} (W/kg)	Reported SAR _{1g} (W/kg)
GSM 850										
	GSM Voice	Left Cheek	190	836.6	32.62	33.00	1.091	0.05	0.331	0.361
	GSM Voice	Left Tilt	190	836.6	32.62	33.00	1.091	-0.07	0.228	0.249
#1	GSM Voice	Right Cheek	190	836.6	32.62	33.00	1.091	-0.07	0.335	0.366
	GSM Voice	Right Tilt	190	836.6	32.62	33.00	1.091	0.03	0.241	0.263
GSM 1900										
	GSM Voice	Left Cheek	810	1909.8	30.51	31.0	1.119	0.11	0.478	0.535
	GSM Voice	Left Tilt	810	1909.8	30.51	31.0	1.119	0.07	0.381	0.427
#2	GSM Voice	Right Cheek	810	1909.8	30.51	31.0	1.119	-0.09	0.484	0.542
	GSM Voice	Right Tilt	810	1909.8	30.51	31.0	1.119	0.06	0.387	0.433

SAR Values for WCDMA

Plot No.	Mode	Test Position	Ch.	Freq. (MHz)	Average Power (dBm)	Tune-Up Limit (dBm)	Scaling Factor	Power Drift (dB)	Measured SAR _{1g} (W/kg)	Reported SAR _{1g} (W/kg)
WCDMA Band II										
	RMC 12.2Kbps	Left Cheek	9262	1852.4	23.61	24.0	1.094	-0.04	0.601	0.657
	RMC 12.2Kbps	Left Tilt	9262	1852.4	23.61	24.0	1.094	0.03	0.508	0.556
#3	RMC 12.2Kbps	Right Cheek	9262	1852.4	23.61	24.0	1.094	-0.03	0.610	0.667
	RMC 12.2Kbps	Right Tilt	9262	1852.4	23.61	24.0	1.094	-0.09	0.511	0.559
	RMC 12.2Kbps	Left Cheek	1412	1732.6	23.46	24.0	1.132	0.13	0.465	0.527
	RMC 12.2Kbps	Left Tilt	1412	1732.6	23.46	24.0	1.132	-0.05	0.359	0.407
#4	RMC 12.2Kbps	Right Cheek	1412	1732.6	23.46	24.0	1.132	-0.05	0.471	0.533
	RMC 12.2Kbps	Right Tilt	1412	1732.6	23.46	24.0	1.132	0.09	0.373	0.422
	RMC 12.2Kbps	Left Cheek	4233	846.6	23.56	24.00	1.107	0.09	0.595	0.658
	RMC 12.2Kbps	Left Tilt	4233	846.6	23.56	24.00	1.107	-0.05	0.492	0.544
#5	RMC 12.2Kbps	Right Cheek	4233	846.6	23.56	24.00	1.107	-0.06	0.601	0.665
	RMC 12.2Kbps	Right Tilt	4233	846.6	23.56	24.00	1.107	0.07	0.508	0.562

SAR Values for LTE

Plot No.	Mode	Test Position	Ch.	Freq. (MHz)	Average Power (dBm)	Tune-Up Limit (dBm)	Scaling Factor	Power Drift (dB)	Measured SAR _{1g} (W/kg)	Reported SAR _{1g} (W/kg)
LTE Band 7										
#6	20MHz/1RB#99	Left Cheek	21100	2535	23.86	24.00	1.033	-0.11	0.551	0.569
	20MHz/1RB#99	Left Tilt	21100	2535	23.86	24.00	1.033	0.06	0.456	0.471
	20MHz/1RB#99	Right Cheek	21100	2535	23.86	24.00	1.033	-0.08	0.545	0.563
	20MHz/1RB#99	Right Tilt	21100	2535	23.86	24.00	1.033	0.10	0.440	0.454
	20MHz/50RB#24	Left Cheek	21100	2535	22.40	23.00	1.148	-0.03	0.481	0.552
	20MHz/50RB#24	Left Tilt	21100	2535	22.40	23.00	1.148	0.06	0.377	0.433
	20MHz/50RB#24	Right Cheek	21100	2535	22.40	23.00	1.148	0.04	0.483	0.555
	20MHz/50RB#24	Right Tilt	21100	2535	22.40	23.00	1.148	0.10	0.388	0.445
LTE Band 12										
#7	10MHz/1RB#25	Left Cheek	23130	711	23.90	24.00	1.023	-0.03	0.537	0.550
	10MHz/1RB#25	Left Tilt	23130	711	23.90	24.00	1.023	-0.11	0.446	0.456
	10MHz/1RB#25	Right Cheek	23130	711	23.90	24.00	1.023	0.13	0.528	0.540
	10MHz/1RB#25	Right Tilt	23130	711	23.90	24.00	1.023	-0.05	0.432	0.442
	10MHz/25RB#25	Left Cheek	23095	707.5	22.45	23.00	1.135	-0.04	0.496	0.563
	10MHz/25RB#25	Left Tilt	23095	707.5	22.45	23.00	1.135	-0.11	0.392	0.445
	10MHz/25RB#25	Right Cheek	23095	707.5	22.45	23.00	1.135	-0.07	0.501	0.569
	10MHz/25RB#25	Right Tilt	23095	707.5	22.45	23.00	1.135	0.08	0.412	0.468
LTE Band 25										
	20MHz/1RB#99	Left Cheek	26140	1860	23.78	24.00	1.052	-0.04	0.602	0.633
	20MHz/1RB#99	Left Tilt	26140	1860	23.78	24.00	1.052	-0.15	0.509	0.535
#8	20MHz/1RB#99	Right Cheek	26140	1860	23.78	24.00	1.052	-0.03	0.611	0.643
	20MHz/1RB#99	Right Tilt	26140	1860	23.78	24.00	1.052	0.07	0.520	0.547
	20MHz/50RB#0	Left Cheek	26140	1860	22.39	23.00	1.151	-0.11	0.526	0.605
	20MHz/50RB#0	Left Tilt	26140	1860	22.39	23.00	1.151	-0.08	0.429	0.494
	20MHz/50RB#0	Right Cheek	26140	1860	22.39	23.00	1.151	-0.07	0.535	0.616
	20MHz/50RB#0	Right Tilt	26140	1860	22.39	23.00	1.151	0.11	0.445	0.512
LTE Band 26 Lower Band										
	10MHz/1RB#0	Left Cheek	26740	819	23.62	24.00	1.091	0.08	0.495	0.540
	10MHz/1RB#0	Left Tilt	26740	819	23.62	24.00	1.091	-0.10	0.396	0.432
#9	10MHz/1RB#0	Right Cheek	26740	819	23.62	24.00	1.091	-0.11	0.501	0.547
	10MHz/1RB#0	Right Tilt	26740	819	23.62	24.00	1.091	-0.03	0.409	0.446
	10MHz/25RB#0	Left Cheek	26740	819	22.45	23.00	1.135	-0.05	0.404	0.459
	10MHz/25RB#0	Left Tilt	26740	819	22.45	23.00	1.135	-0.03	0.308	0.350
	10MHz/25RB#0	Right Cheek	26740	819	22.45	23.00	1.135	0.05	0.411	0.466
	10MHz/25RB#0	Right Tilt	26740	819	22.45	23.00	1.135	-0.03	0.314	0.356

LTE Band 26 Higher Band										
	15MHz/1RB#37	Left Cheek	26865	831.5	23.55	24.00	1.109	-0.01	0.464	0.515
	15MHz/1RB#37	Left Tilt	26865	831.5	23.55	24.00	1.109	0.03	0.360	0.399
#10	15MHz/1RB#37	Right Cheek	26865	831.5	23.55	24.00	1.109	-0.14	0.466	0.517
	15MHz/1RB#37	Right Tilt	26865	831.5	23.55	24.00	1.109	-0.11	0.372	0.413
	15MHz/36RB#20	Left Cheek	26865	831.5	22.39	23.00	1.151	-0.05	0.378	0.435
	15MHz/36RB#20	Left Tilt	26865	831.5	22.39	23.00	1.151	-0.07	0.278	0.320
	15MHz/36RB#20	Right Cheek	26865	831.5	22.39	23.00	1.151	0.04	0.386	0.444
	15MHz/36RB#20	Right Tilt	26865	831.5	22.39	23.00	1.151	-0.06	0.291	0.335
LTE Band 66										
	20MHz/1RB#0	Left Cheek	132322	1745	23.77	24.00	1.054	-0.04	0.558	0.588
	20MHz/1RB#0	Left Tilt	132322	1745	23.77	24.00	1.054	-0.06	0.454	0.479
#11	20MHz/1RB#0	Right Cheek	132322	1745	23.77	24.00	1.054	-0.05	0.566	0.597
	20MHz/1RB#0	Right Tilt	132322	1745	23.77	24.00	1.054	0.04	0.474	0.500
	20MHz/50RB#24	Left Cheek	132572	1770	22.35	23.00	1.161	0.08	0.482	0.560
	20MHz/50RB#24	Left Tilt	132572	1770	22.35	23.00	1.161	-0.06	0.373	0.433
	20MHz/50RB#24	Right Cheek	132572	1770	22.35	23.00	1.161	0.07	0.484	0.562
	20MHz/50RB#24	Right Tilt	132572	1770	22.35	23.00	1.161	-0.03	0.385	0.447
LTE Band 41										
#12	20MHz/1RB#49	Left Cheek	41140	2645	23.82	24.00	1.042	-0.06	0.533	0.556
	20MHz/1RB#49	Left Tilt	41140	2645	23.82	24.00	1.042	-0.04	0.443	0.462
	20MHz/1RB#49	Right Cheek	41140	2645	23.82	24.00	1.042	-0.03	0.532	0.555
	20MHz/1RB#49	Right Tilt	41140	2645	23.82	24.00	1.042	0.13	0.425	0.443
	20MHz/50RB#24	Left Cheek	41140	2645	22.25	23.00	1.189	0.05	0.486	0.578
	20MHz/50RB#24	Left Tilt	41140	2645	22.25	23.00	1.189	-0.11	0.382	0.454
	20MHz/50RB#24	Right Cheek	41140	2645	22.25	23.00	1.189	0.03	0.493	0.586
	20MHz/50RB#24	Right Tilt	41140	2645	22.25	23.00	1.189	-0.07	0.399	0.474

SAR Values for WIFI 2.4G

Plot No.	Mode	Test Position	Ch.	Freq. (MHz)	Average Power (dBm)	Tune-Up Limit (dBm)	Scaling Factor	Power Drift (dB)	Measured SAR _{1g} (W/kg)	Reported SAR _{1g} (W/kg)
#13	802.11b	Left Cheek	11	2462	12.51	13.0	1.119	-0.10	0.378	0.423
	802.11b	Left Tilt	11	2462	12.51	13.0	1.119	0.04	0.286	0.320
	802.11b	Right Cheek	11	2462	12.51	13.0	1.119	-0.06	0.369	0.413
	802.11b	Right Tilt	11	2462	12.51	13.0	1.119	0.13	0.271	0.303

Note: Per KDB 248227 D01v02r02, for 2.4GHz 802.11g/n SAR testing is not required when the highest reported SAR for DSSS is adjusted by the ratio of OFDM to DSSS specified maximum output power and the adjusted SAR is ≤ 1.2 W/kg.

<Body & Hotspot SAR>

SAR Values [GSM 850]

Plot No.	Mode	Test Position	Ch.	Freq. (MHz)	Average Power (dBm)	Tune-Up Limit (dBm)	Scaling Factor	Power Drift (dB)	Measured SAR _{1g} (W/kg)	Reported SAR _{1g} (W/kg)
Measured / Reported SAR numbers-Body& hotspot open distance 10mm										
	GPRS 1Tx slots	Front	251	848.8	32.77	33.00	1.054	0.09	0.354	0.373
#14	GPRS 1Tx slots	Back	251	848.8	32.77	33.00	1.054	-0.04	0.411	0.433
	GPRS 1Tx slots	Left Edge	251	848.8	32.77	33.00	1.054	0.06	0.375	0.395
	GPRS 1Tx slots	Right Edge	251	848.8	32.77	33.00	1.054	0.03	0.383	0.404
	GPRS 1Tx slots	Bottom Edge	251	848.8	32.77	33.00	1.054	0.07	0.405	0.427
	EGPRS 2Tx slots	Back	251	848.8	25.67	26.00	1.079	0.09	0.391	0.422

SAR Values [PCS 1900]

Plot No.	Mode	Test Position	Ch.	Freq. (MHz)	Average Power (dBm)	Tune-Up Limit (dBm)	Scaling Factor	Power Drift (dB)	Measured SAR _{1g} (W/kg)	Reported SAR _{1g} (W/kg)
Measured / Reported SAR numbers-Body& hotspot open distance 10mm										
	GPRS 1Tx slots	Front	512	1850.2	30.85	31.00	1.035	-0.11	0.586	0.607
#15	GPRS 1Tx slots	Back	512	1850.2	30.85	31.00	1.035	0.10	0.641	0.664
	GPRS 1Tx slots	Left Edge	512	1850.2	30.85	31.00	1.035	0.06	0.604	0.625
	GPRS 1Tx slots	Right Edge	512	1850.2	30.85	31.00	1.035	0.09	0.615	0.637
	GPRS 1Tx slots	Bottom Edge	512	1850.2	30.85	31.00	1.035	0.13	0.638	0.660
	EGPRS 3Tx slots	Back	512	1850.2	22.76	23.00	1.057	-0.10	0.577	0.610

SAR Values [WCDMA II]

Plot No.	Mode	Test Position	Ch.	Freq. (MHz)	Average Power (dBm)	Tune-Up Limit (dBm)	Scaling Factor	Power Drift (dB)	Measured SAR _{1g} (W/kg)	Reported SAR _{1g} (W/kg)
Measured / Reported SAR numbers-Body& hotspot open distance 10mm										
	RMC 12.2Kbps	Front	9262	1852.4	23.61	24.0	1.094	0.03	0.333	0.364
#16	RMC 12.2Kbps	Back	9262	1852.4	23.61	24.0	1.094	0.11	0.389	0.426
	RMC 12.2Kbps	Left Edge	9262	1852.4	23.61	24.0	1.094	-0.05	0.354	0.387
	RMC 12.2Kbps	Right Edge	9262	1852.4	23.61	24.0	1.094	0.04	0.363	0.397
	RMC 12.2Kbps	Bottom Edge	9262	1852.4	23.61	24.0	1.094	-0.05	0.384	0.420

SAR Values [WCDMA IV]

Plot No.	Mode	Test Position	Ch.	Freq. (MHz)	Average Power (dBm)	Tune-Up Limit (dBm)	Scaling Factor	Power Drift (dB)	Measured SAR _{1g} (W/kg)	Reported SAR _{1g} (W/kg)
Measured / Reported SAR numbers-Body& hotspot open distance 10mm										
	RMC 12.2Kbps	Front	1412	1732.6	23.46	24.0	1.132	0.09	0.372	0.421
#17	RMC 12.2Kbps	Back	1412	1732.6	23.46	24.0	1.132	-0.03	0.425	0.481
	RMC 12.2Kbps	Left Edge	1412	1732.6	23.46	24.0	1.132	-0.10	0.391	0.443
	RMC 12.2Kbps	Right Edge	1412	1732.6	23.46	24.0	1.132	0.05	0.398	0.451
	RMC 12.2Kbps	Bottom Edge	1412	1732.6	23.46	24.0	1.132	-0.07	0.420	0.476

SAR Values [WCDMA V]

Plot No.	Mode	Test Position	Ch.	Freq. (MHz)	Average Power (dBm)	Tune-Up Limit (dBm)	Scaling Factor	Power Drift (dB)	Measured SAR _{1g} (W/kg)	Reported SAR _{1g} (W/kg)
Measured / Reported SAR numbers-Body& hotspot open distance 10mm										
	RMC 12.2Kbps	Front	4233	846.6	23.56	24.00	1.107	-0.11	0.248	0.274
#18	RMC 12.2Kbps	Back	4233	846.6	23.56	24.00	1.107	-0.06	0.305	0.338
	RMC 12.2Kbps	Left Edge	4233	846.6	23.56	24.00	1.107	-0.08	0.268	0.297
	RMC 12.2Kbps	Right Edge	4233	846.6	23.56	24.00	1.107	-0.10	0.282	0.312
	RMC 12.2Kbps	Bottom Edge	4233	846.6	23.56	24.00	1.107	0.05	0.294	0.325

SAR Values [LTE Band 7]

Plot No.	Mode	Test Position	Ch.	Freq. (MHz)	Average Power (dBm)	Tune-Up Limit (dBm)	Scaling Factor	Power Drift (dB)	Measured SAR _{1g} (W/kg)	Reported SAR _{1g} (W/kg)
Measured / Reported SAR numbers-Body& hotspot open distance 10mm										
	20MHz/1RB#99	Front	21100	2535	23.86	24.00	1.033	0.05	0.382	0.395
#19	20MHz/1RB#99	Back	21100	2535	23.86	24.00	1.033	-0.07	0.441	0.455
	20MHz/1RB#99	Left Edge	21100	2535	23.86	24.00	1.033	-0.11	0.407	0.420
	20MHz/1RB#99	Right Edge	21100	2535	23.86	24.00	1.033	-0.09	0.417	0.431
	20MHz/1RB#99	Bottom Edge	21100	2535	23.86	24.00	1.033	0.05	0.440	0.454
	20MHz/50RB#24	Front	21100	2535	22.40	23.00	1.148	0.03	0.337	0.387
	20MHz/50RB#24	Back	21100	2535	22.40	23.00	1.148	-0.07	0.395	0.454
	20MHz/50RB#24	Left Edge	21100	2535	22.40	23.00	1.148	-0.05	0.362	0.416
	20MHz/50RB#24	Right Edge	21100	2535	22.40	23.00	1.148	0.13	0.365	0.419
	20MHz/50RB#24	Bottom Edge	21100	2535	22.40	23.00	1.148	-0.05	0.390	0.448

SAR Values [LTE Band 12]

Plot No.	Mode	Test Position	Ch.	Freq. (MHz)	Average Power (dBm)	Tune-Up Limit (dBm)	Scaling Factor	Power Drift (dB)	Measured SAR _{1g} (W/kg)	Reported SAR _{1g} (W/kg)
Measured / Reported SAR numbers-Body& hotspot open distance 10mm										
	10MHz/1RB#25	Front	23130	711	23.90	24.00	1.023	0.05	0.349	0.357
#20	10MHz/1RB#25	Back	23130	711	23.90	24.00	1.023	-0.08	0.405	0.414
	10MHz/1RB#25	Left Edge	23130	711	23.90	24.00	1.023	-0.11	0.371	0.380
	10MHz/1RB#25	Right Edge	23130	711	23.90	24.00	1.023	-0.09	0.377	0.386
	10MHz/1RB#25	Bottom Edge	23130	711	23.90	24.00	1.023	0.05	0.400	0.409
	10MHz/25RB#25	Front	23095	707.5	22.45	23.00	1.135	0.03	0.328	0.372
	10MHz/25RB#25	Back	23095	707.5	22.45	23.00	1.135	-0.07	0.381	0.432
	10MHz/25RB#25	Left Edge	23095	707.5	22.45	23.00	1.135	-0.05	0.347	0.394
	10MHz/25RB#25	Right Edge	23095	707.5	22.45	23.00	1.135	0.13	0.353	0.401
	10MHz/25RB#25	Bottom Edge	23095	707.5	22.45	23.00	1.135	-0.05	0.374	0.424

SAR Values [LTE Band 25]

Plot No.	Mode	Test Position	Ch.	Freq. (MHz)	Average Power (dBm)	Tune-Up Limit (dBm)	Scaling Factor	Power Drift (dB)	Measured SAR _{1g} (W/kg)	Reported SAR _{1g} (W/kg)
Measured / Reported SAR numbers-Body& hotspot open distance 10mm										
	20MHz/1RB#99	Front	26140	1860	23.78	24.00	1.052	0.11	0.537	0.565
#21	20MHz/1RB#99	Back	26140	1860	23.78	24.00	1.052	0.05	0.592	0.623
	20MHz/1RB#99	Left Edge	26140	1860	23.78	24.00	1.052	-0.09	0.553	0.582
	20MHz/1RB#99	Right Edge	26140	1860	23.78	24.00	1.052	-0.05	0.569	0.599
	20MHz/1RB#99	Bottom Edge	26140	1860	23.78	24.00	1.052	0.03	0.589	0.620
	20MHz/50RB#0	Front	26140	1860	22.39	23.00	1.151	0.04	0.487	0.560
	20MHz/50RB#0	Back	26140	1860	22.39	23.00	1.151	-0.06	0.543	0.625
	20MHz/50RB#0	Left Edge	26140	1860	22.39	23.00	1.151	0.09	0.506	0.582
	20MHz/50RB#0	Right Edge	26140	1860	22.39	23.00	1.151	0.11	0.520	0.598
	20MHz/50RB#0	Bottom Edge	26140	1860	22.39	23.00	1.151	-0.05	0.541	0.623

SAR Values [LTE Band 26 Lower Band]

Plot No.	Mode	Test Position	Ch.	Freq. (MHz)	Average Power (dBm)	Tune-Up Limit (dBm)	Scaling Factor	Power Drift (dB)	Measured SAR _{1g} (W/kg)	Reported SAR _{1g} (W/kg)
Measured / Reported SAR numbers-Body& hotspot open distance 10mm										
	10MHz/1RB#0	Front	26740	819	23.62	24.00	1.091	-0.03	0.428	0.467
#22	10MHz/1RB#0	Back	26740	819	23.62	24.00	1.091	0.11	0.487	0.532
	10MHz/1RB#0	Left Edge	26740	819	23.62	24.00	1.091	-0.09	0.451	0.492
	10MHz/1RB#0	Right Edge	26740	819	23.62	24.00	1.091	-0.11	0.463	0.505
	10MHz/1RB#0	Bottom Edge	26740	819	23.62	24.00	1.091	0.10	0.481	0.525
	10MHz/25RB#0	Front	26740	819	22.45	23.00	1.135	0.04	0.374	0.424
	10MHz/25RB#0	Back	26740	819	22.45	23.00	1.135	-0.05	0.432	0.490
	10MHz/25RB#0	Left Edge	26740	819	22.45	23.00	1.135	-0.11	0.400	0.454
	10MHz/25RB#0	Right Edge	26740	819	22.45	23.00	1.135	0.03	0.403	0.457
	10MHz/25RB#0	Bottom Edge	26740	819	22.45	23.00	1.135	-0.09	0.425	0.482

SAR Values [LTE Band 26 Higher Band]

Plot No.	Mode	Test Position	Ch.	Freq. (MHz)	Average Power (dBm)	Tune-Up Limit (dBm)	Scaling Factor	Power Drift (dB)	Measured SAR _{1g} (W/kg)	Reported SAR _{1g} (W/kg)
Measured / Reported SAR numbers-Body& hotspot open distance 10mm										
	15MHz/1RB#37	Front	26865	831.5	23.55	24.00	1.109	-0.13	0.425	0.471
#23	15MHz/1RB#37	Back	26865	831.5	23.55	24.00	1.109	0.11	0.484	0.537
	15MHz/1RB#37	Left Edge	26865	831.5	23.55	24.00	1.109	-0.05	0.453	0.502
	15MHz/1RB#37	Right Edge	26865	831.5	23.55	24.00	1.109	-0.04	0.452	0.501
	15MHz/1RB#37	Bottom Edge	26865	831.5	23.55	24.00	1.109	0.03	0.481	0.534
	15MHz/36RB#20	Front	26865	831.5	22.39	23.00	1.151	0.09	0.380	0.437
	15MHz/36RB#20	Back	26865	831.5	22.39	23.00	1.151	-0.07	0.433	0.498
	15MHz/36RB#20	Left Edge	26865	831.5	22.39	23.00	1.151	-0.03	0.402	0.463
	15MHz/36RB#20	Right Edge	26865	831.5	22.39	23.00	1.151	-0.05	0.409	0.471
	15MHz/36RB#20	Bottom Edge	26865	831.5	22.39	23.00	1.151	0.05	0.423	0.487

SAR Values [LTE Band 66]

Plot No.	Mode	Test Position	Ch.	Freq. (MHz)	Average Power (dBm)	Tune-Up Limit (dBm)	Scaling Factor	Power Drift (dB)	Measured SAR _{1g} (W/kg)	Reported SAR _{1g} (W/kg)
Measured / Reported SAR numbers-Body& hotspot open distance 10mm										
	20MHz/1RB#0	Front	132322	1745	23.77	24.00	1.054	0.08	0.545	0.575
#24	20MHz/1RB#0	Back	132322	1745	23.77	24.00	1.054	-0.09	0.605	0.638
	20MHz/1RB#0	Left Edge	132322	1745	23.77	24.00	1.054	-0.05	0.568	0.599
	20MHz/1RB#0	Right Edge	132322	1745	23.77	24.00	1.054	0.11	0.572	0.603
	20MHz/1RB#0	Bottom Edge	132322	1745	23.77	24.00	1.054	-0.08	0.601	0.634
	20MHz/50RB#24	Front	132572	1770	22.35	23.00	1.161	0.06	0.518	0.602
	20MHz/50RB#24	Back	132572	1770	22.35	23.00	1.161	-0.13	0.572	0.664
	20MHz/50RB#24	Left Edge	132572	1770	22.35	23.00	1.161	-0.10	0.540	0.627
	20MHz/50RB#24	Right Edge	132572	1770	22.35	23.00	1.161	0.06	0.544	0.632
	20MHz/50RB#24	Bottom Edge	132572	1770	22.35	23.00	1.161	0.09	0.567	0.659

SAR Values [LTE Band 41]

Plot No.	Mode	Test Position	Ch.	Freq. (MHz)	Average Power (dBm)	Tune-Up Limit (dBm)	Scaling Factor	Power Drift (dB)	Measured SAR _{1g} (W/kg)	Reported SAR _{1g} (W/kg)
Measured / Reported SAR numbers-Body& hotspot open distance 10mm										
	20MHz/1RB#49	Front	41140	2645	23.82	24.00	1.042	-0.07	0.610	0.636
	20MHz/1RB#49	Back	41140	2645	23.82	24.00	1.042	0.05	0.663	0.691
	20MHz/1RB#49	Left Edge	41140	2645	23.82	24.00	1.042	0.13	0.637	0.664
	20MHz/1RB#49	Right Edge	41140	2645	23.82	24.00	1.042	0.09	0.644	0.671
#25	20MHz/1RB#49	Bottom Edge	41140	2645	23.82	24.00	1.042	0.05	0.671	0.699
	20MHz/50RB#24	Front	41140	2645	22.25	23.00	1.189	0.05	0.569	0.676
	20MHz/50RB#24	Back	41140	2645	22.25	23.00	1.189	-0.06	0.615	0.731
	20MHz/50RB#24	Left Edge	41140	2645	22.25	23.00	1.189	-0.04	0.588	0.699
	20MHz/50RB#24	Right Edge	41140	2645	22.25	23.00	1.189	0.03	0.594	0.706
	20MHz/50RB#24	Bottom Edge	41140	2645	22.25	23.00	1.189	-0.09	0.622	0.739

SAR Values [WIFI 2.4G]

Plot No.	Mode	Test Position	Ch.	Freq. (MHz)	Average Power (dBm)	Tune-Up Limit (dBm)	Scaling Factor	Power Drift (dB)	Measured SAR _{1g} (W/kg)	Reported SAR _{1g} (W/kg)
Measured / Reported SAR numbers-Body& hotspot open distance 10mm										
	802.11b	Front Side	11	2462	12.51	13.0	1.119	-0.06	0.105	0.118
#26	802.11b	Back Side	11	2462	12.51	13.0	1.119	-0.05	0.191	0.214
	802.11b	Left Edge	11	2462	12.51	13.0	1.119	0.07	0.178	0.199
	802.11b	Top Edge	11	2462	12.51	13.0	1.119	0.03	0.189	0.212

Note: Per KDB 248227 D01v02r02, for 2.4GHz 802.11g/n SAR testing is not required when the highest reported SAR for DSSS is adjusted by the ratio of OFDM to DSSS specified maximum output power and the adjusted SAR is ≤ 1.2 W/kg.

10.6 Simultaneous Transmission Analysis

Per FCC KD B447498 D01, simultaneous transmission SAR test exclusion may be applied when the sum of the 1-g SAR for all the transmitting antenna in a specific a physical test configuration is ≤ 1.6 W/Kg. When the sum is greater than the SAR limit, SAR test exclusion is determined by the SAR to peak location separation ratio.

$$\text{Ratio} = \frac{(\text{SAR}_1 + \text{SAR}_2)^{1.5}}{(\text{peak location separation, mm})} < 0.04$$

The following procedures adopted from “FCC SAR Considerations for Cell Phones with Multiple Transmitters” are applicable to handsets with built-in unlicensed transmitters such as 802.11 a/b/g/n and Bluetooth devices which may simultaneously transmit with the licensed transmitter.

Application Simultaneous Transmission information:

No.	Simultaneous Transmission Configurations	Portable Handset		
		Head	Body-worn	Hotspot
1	WWAN (2/3/4G) + WLAN 2.4GHz	Yes	Yes	Yes
3	WWAN (2/3/4G) + Bluetooth	Yes	Yes	Yes

Note: WLAN2.4G and BT share the same antenna and cannot transmitting at the same time.

10.8.2 Evaluation of Simultaneous SAR

Head Simultaneous transmission SAR for WLAN/BT and GSM/WCDMA/LTE

Exposure Position	1	2	3	1+2 Summed 1g SAR (W/kg)	1+3 Summed 1g SAR (W/kg)	SPLSR
	MAX. WWAN Reported SAR	MAX. WLAN2.4G Reported SAR	Bluetooth			
	1g SAR (W/kg)	1g SAR (W/kg)	1g SAR (W/kg)			
Left Cheek	0.658	0.413	0.042	1.071	0.700	N/A
Left Tilt	0.556	0.303	0.042	0.859	0.598	N/A
Right Cheek	0.667	0.423	0.042	1.090	0.709	N/A
Right Tilt	0.562	0.32	0.042	0.882	0.604	N/A

MAX. $\Sigma\text{SAR}_{1g} = 1.090$ W/kg < 1.6 W/kg, so the Simultaneous transmission SAR with volume scan are not required.

Body-worn and hotspot Simultaneous transmission SAR for WLAN/BT and GSM/WCDMA/LTE

Exposure Position	1	2	3	1+2 Summed 1g SAR (W/kg)	1+3 Summed 1g SAR (W/kg)	SPLSR
	MAX. WWAN Reported SAR	MAX. WLAN2.4G Reported SAR	Bluetooth			
	1g SAR (W/kg)	1g SAR (W/kg)	1g SAR (W/kg)			
Front Side	0.676	0.118	0.021	0.794	0.697	N/A
Rear Side	0.731	0.214	0.021	0.945	0.752	N/A
Left Edge	0.699	0.199	0.021	0.898	0.720	N/A
Right Edge	0.706	N/A	0.021	0.706	0.727	N/A
Top Side	N/A	0.212	0.021	0.212	0.021	N/A
Bottom Edge	0.739	N/A	0.021	0.739	0.760	N/A



MAX. $\Sigma SAR_{1g} = 0.945$ W/kg < 1.6 W/kg, so the Simultaneous transmission SAR with volume scan are not required.

11 Measurement Uncertainty

NO	Source	Uncert. ai (%)	Prob. Dist.	Div. k	ci (1g)	ci (10g)	Stand.U ncert. ui (1g)	Stand.U ncert. ui (10g)	Veff
1	Repeat	0.4	N	1	1	1	0.4	0.4	9
Instrument									
2	Probe calibration	7	N	2	1	1	3.5	3.5	∞
3	Axial isotropy	4.7	R	$\sqrt{3}$	0.7	0.7	1.9	1.9	∞
4	Hemispherical isotropy	9.4	R	$\sqrt{3}$	0.7	0.7	3.9	3.9	∞
5	Boundary effect	1.0	R	$\sqrt{3}$	1	1	0.6	0.6	∞
6	Linearity	4.7	R	$\sqrt{3}$	1	1	2.7	2.7	∞
7	Detection limits	1.0	R	$\sqrt{3}$	1	1	0.6	0.6	∞
8	Readout electronics	0.3	N	1	1	1	0.3	0.3	∞
9	Response time	0.8	R	$\sqrt{3}$	1	1	0.5	0.5	∞
10	Integration time	2.6	R	$\sqrt{3}$	1	1	1.5	1.5	∞
11	Ambient noise	3.0	R	$\sqrt{3}$	1	1	1.7	1.7	∞
12	Ambient reflections	3.0	R	$\sqrt{3}$	1	1	1.7	1.7	∞
13	Probe positioner mech. restrictions	0.4	R	$\sqrt{3}$	1	1	0.2	0.2	∞
14	Probe positioning with respect to phantom shell	2.9	R	$\sqrt{3}$	1	1	1.7	1.7	∞
15	Max.SAR evaluation	1.0	R	$\sqrt{3}$	1	1	0.6	0.6	∞

Test sample related									
16	Device positioning	3.8	N	1	1	1	3.8	3.8	99
17	Device holder	5.1	N	1	1	1	5.1	5.1	5
18	Drift of output power	5.0	R	$\frac{1}{\sqrt{3}}$	1	1	2.9	2.9	∞
Phantom and set-up									
19	Phantom uncertainty	4.0	R	$\frac{1}{\sqrt{3}}$	1	1	2.3	2.3	∞
20	Liquid conductivity (target)	5.0	R	$\frac{1}{\sqrt{3}}$	0.64	0.43	1.8	1.2	∞
21	Liquid conductivity (meas)	2.5	N	1	0.64	0.43	1.6	1.2	∞
22	Liquid Permittivity (target)	5.0	R	$\frac{1}{\sqrt{3}}$	0.6	0.49	1.7	1.5	∞
23	Liquid Permittivity (meas)	2.5	N	1	0.6	0.49	1.5	1.2	∞
Combined standard			RSS	$u_c = \sqrt{\sum_{i=1}^n C_i^2 U_i^2}$			11.4%	11.3%	236
Expanded uncertainty(P=95%)		$U = k U_c$					22.8%	22.6%	

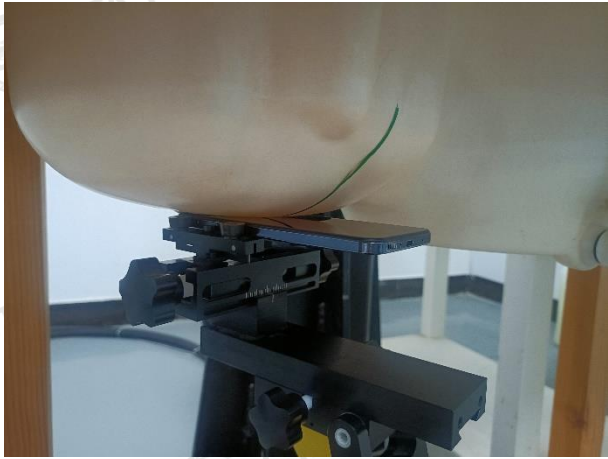
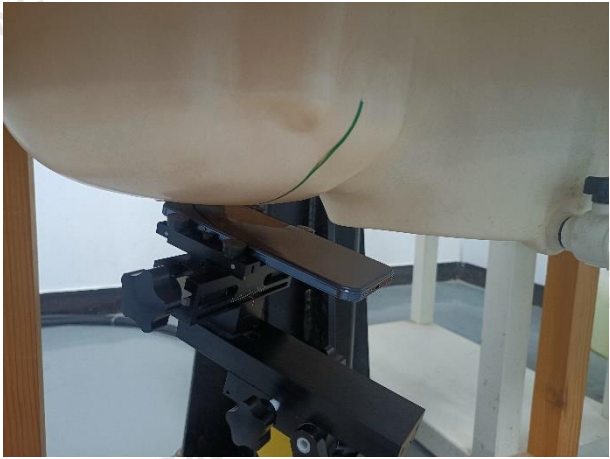
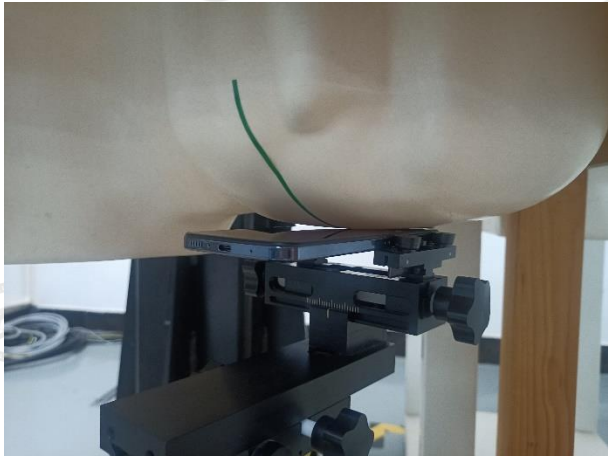
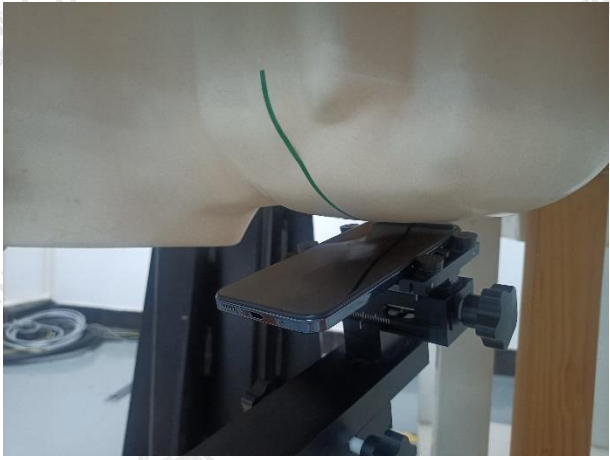
Appendix A. EUT Photos and Test Setup Photos

	
Right Head Cheek	Right Head Tilted
	
Left Head Cheek	Left Head Tilted
	
Front Side (10mm)	Rear Side (10mm)



Left Side (10mm)



Right Side (10mm)



Top Side (10mm)



Bottom Side (10mm)

Appendix B. Plots of SAR System Check

750MHz System Check

Date: 05/22/2024

DUT: Dipole 750 MHz; Type: D750V3; Serial: 1194

Communication System: CW; Frequency: 750 MHz; Duty Cycle: 1:1

Medium parameters used (interpolated): $f = 750 \text{ MHz}$; $\sigma = 0.855 \text{ S/m}$; $\epsilon_r = 41.699$; $\rho = 1000 \text{ kg/m}^3$

Phantom section: Flat Section

DASY5 Configuration:

- Probe: EX3DV4 – SN7380; ConvF(10.02, 10.02, 10.02); Calibrated: June 21, 2023;
- Sensor-Surface: 3mm (Mechanical Surface Detection)
- Electronics: DAE3 Sn428; Calibrated: Aug.30,2023;
- Phantom: Twin-SAM V8.0 ; Type: QD 000 P41 AA; Serial: 1974;
- DASY52 52.10.2(1495); SEMCAD X 14.6.12(7450)

Area Scan (61x61x1): Interpolated grid: $dx=1.500 \text{ mm}$, $dy=1.500 \text{ mm}$

Maximum value of SAR (interpolated) = 2.74 W/kg

Zoom Scan (5x5x7)/Cube 0: Measurement grid: $dx=8\text{mm}$, $dy=8\text{mm}$, $dz=5\text{mm}$

Reference Value = 61.44 V/m; Power Drift = -0.03 dB

Peak SAR (extrapolated) = 3.35 W/kg

SAR(1 g) = 2.20 W/kg; SAR(10 g) = 1.39 W/kg

Maximum value of SAR (measured) = 2.77 W/kg

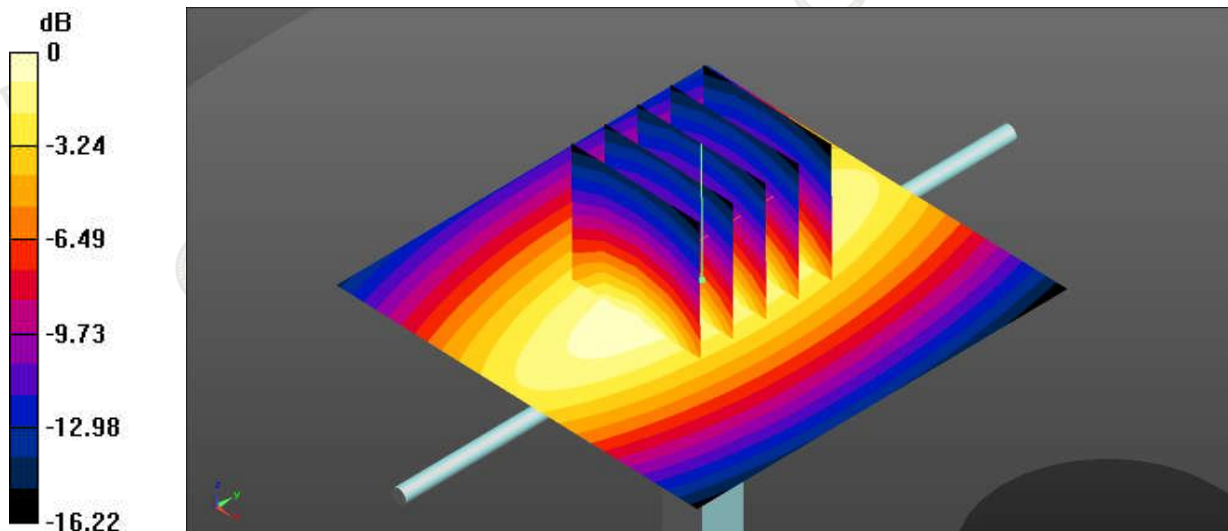

0 dB = 2.77 W/kg

System Performance Check 750MHz 250mW

835MHz System Check

Date: 05/23/2024

DUT: Dipole 835 MHz; Type: D835V2; Serial: 484

Communication System: CW; Frequency: 835 MHz; Duty Cycle: 1:1

Medium parameters used (interpolated): $f = 835 \text{ MHz}$; $\sigma = 0.927 \text{ S/m}$; $\epsilon_r = 42.098$; $\rho = 1000 \text{ kg/m}^3$

Phantom section: Flat Section

DASY5 Configuration:

- Probe: EX3DV4 – SN7380; ConvF(9.62, 9.62, 9.62); Calibrated: June 21, 2023;
- Sensor-Surface: 3mm (Mechanical Surface Detection)
- Electronics: DAE3 Sn428; Calibrated: Aug.30,2023;
- Phantom: Twin-SAM V8.0 ; Type: QD 000 P41 AA; Serial: 1974;
- DASY52 52.10.2(1495); SEMCAD X 14.6.12(7450)

Area Scan (61x61x1): Interpolated grid: $dx=1.500 \text{ mm}$, $dy=1.500 \text{ mm}$

Maximum value of SAR (interpolated) = 3.46 W/kg

Zoom Scan (5x5x7)/Cube 0: Measurement grid: $dx=8\text{mm}$, $dy=8\text{mm}$, $dz=5\text{mm}$

Reference Value = 63.25 V/m; Power Drift = 0.09 dB

Peak SAR (extrapolated) = 4.15 W/kg

SAR(1 g) = 2.48 W/kg; SAR(10 g) = 1.88 W/kg

Maximum value of SAR (measured) = 3.53 W/kg

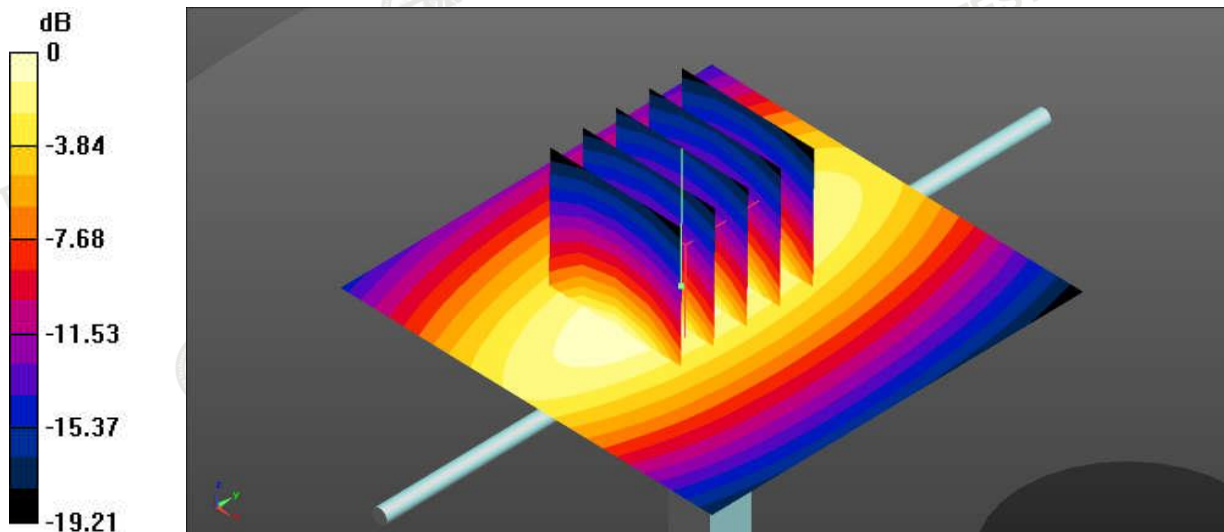

0 dB = 3.53 W/kg

System Performance Check 835MHz 250mW

1750 MHz System Check

Date: 05/24/2024

DUT: Dipole 1800 MHz; Type: D1800V2; Serial: 2d158

Communication System: CW; Frequency: 1750 MHz; Duty Cycle: 1:1

Medium parameters used (interpolated): $f = 1750$ MHz; $\sigma = 1.351$ S/m; $\epsilon_r = 40.228$; $\rho = 1000$ kg/m³

Phantom section: Flat Section

DASY5 Configuration:

- Probe: EX3DV4 – SN7380; ConvF(8.35, 8.35, 8.35); Calibrated: June 21, 2023;
- Sensor-Surface: 3mm (Mechanical Surface Detection)
- Electronics: DAE3 Sn428; Calibrated: Aug.30,2023;
- Phantom: Twin-SAM V8.0 ; Type: QD 000 P41 AA; Serial: 1974;
- DASY52 52.10.2(1495); SEMCAD X 14.6.12(7450)

Area Scan (61x61x1): Interpolated grid: dx=1.500 mm, dy=1.500 mm

Maximum value of SAR (interpolated) = 15.6 W/kg

Zoom Scan (5x5x7)/Cube 0: Measurement grid: dx=8mm, dy=8mm, dz=5mm

Reference Value = 90.25 V/m; Power Drift = -0.10 dB

Peak SAR (extrapolated) = 19.4 W/kg

SAR(1 g) = 9.36 W/kg; SAR(10 g) = 5.11 W/kg

Maximum value of SAR (measured) = 16.1 W/kg

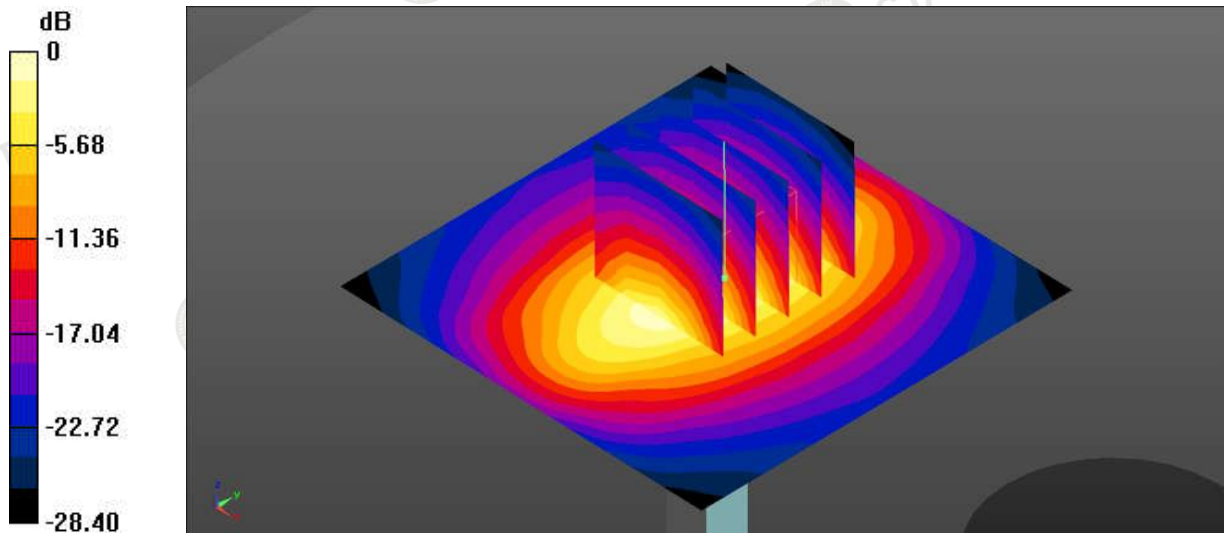

0 dB = 16.1 W/kg

System Performance Check 1750MHz 250mW

1900MHz System Check

Date: 05/28/2024

DUT: Dipole 1900 MHz; Type: D1900V2; Serial: 5d002

Communication System: CW; Frequency: 1900 MHz; Duty Cycle: 1:1

Medium parameters used (interpolated): $f = 1900$ MHz; $\sigma = 1.389$ S/m; $\epsilon_r = 38.440$; $\rho = 1000$ kg/m³

Phantom section: Flat Section

DASY5 Configuration:

- Probe: EX3DV4 – SN7380; ConvF(8.05, 8.05, 8.05); Calibrated: June 21, 2023;
- Sensor-Surface: 3mm (Mechanical Surface Detection)
- Electronics: DAE3 Sn428; Calibrated: Aug.30,2023;
- Phantom: Twin-SAM V8.0 ; Type: QD 000 P41 AA; Serial: 1974;
- DASY52 52.10.2(1495); SEMCAD X 14.6.12(7450)

Area Scan (61x61x1): Interpolated grid: dx=1.500 mm, dy=1.500 mm

Maximum value of SAR (interpolated) = 13.8 W/kg

Zoom Scan (5x5x7)/Cube 0: Measurement grid: dx=8mm, dy=8mm, dz=5mm

Reference Value = 83.65 V/m; Power Drift = -0.11 dB

Peak SAR (extrapolated) = 16.74 W/kg

SAR(1 g) = 9.62 W/kg; SAR(10 g) = 5.05 W/kg

Maximum value of SAR (measured) = 14.8 W/kg

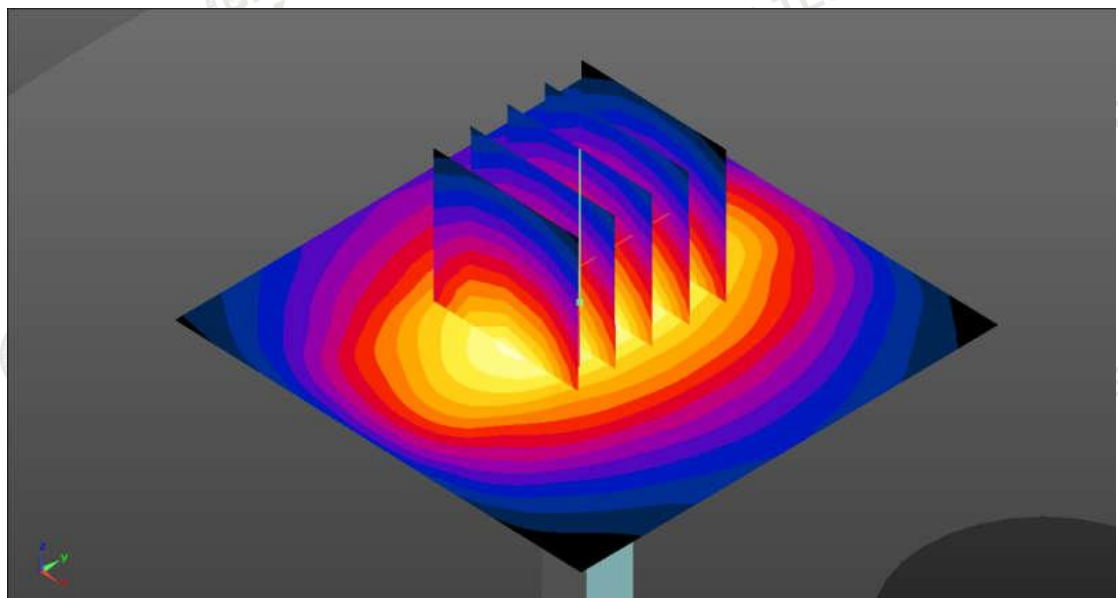
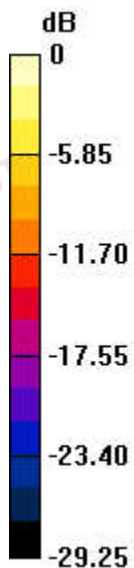

0 dB = 14.8 W/kg

System Performance Check 1900MHz 250mW

2450MHz System Check

Date: 05/29/2024

DUT: Dipole 2450 MHz; Type: D2450V2; Serial: 745

Communication System: CW; Frequency: 2450 MHz; Duty Cycle: 1:1

Medium parameters used (interpolated): $f = 2450$ MHz; $\sigma = 1.803$ S/m; $\epsilon_r = 39.282$; $\rho = 1000$ kg/m³

Phantom section: Flat Section

DASY5 Configuration:

- Probe: EX3DV4 – SN7380; ConvF(7.50, 7.50, 7.50); Calibrated: June 21, 2023;
- Sensor-Surface: 3mm (Mechanical Surface Detection)
- Electronics: DAE3 Sn428; Calibrated: Aug.30,2023;
- Phantom: Twin-SAM V8.0 ; Type: QD 000 P41 AA; Serial: 1974;
- DASY52 52.10.2(1495); SEMCAD X 14.6.12(7450)

Area Scan (71x71x1): Interpolated grid: dx=1.200 mm, dy=1.200 mm

Maximum value of SAR (interpolated) = 19.9 W/kg

Zoom Scan (7x7x7)/Cube 0: Measurement grid: dx=5mm, dy=5mm, dz=5mm

Reference Value = 100.89 V/m; Power Drift = 0.03 dB

Peak SAR (extrapolated) = 24.4 W/kg

SAR(1 g) = 12.55 W/kg; SAR(10 g) = 6.17 W/kg

Maximum value of SAR (measured) = 18.9 W/kg

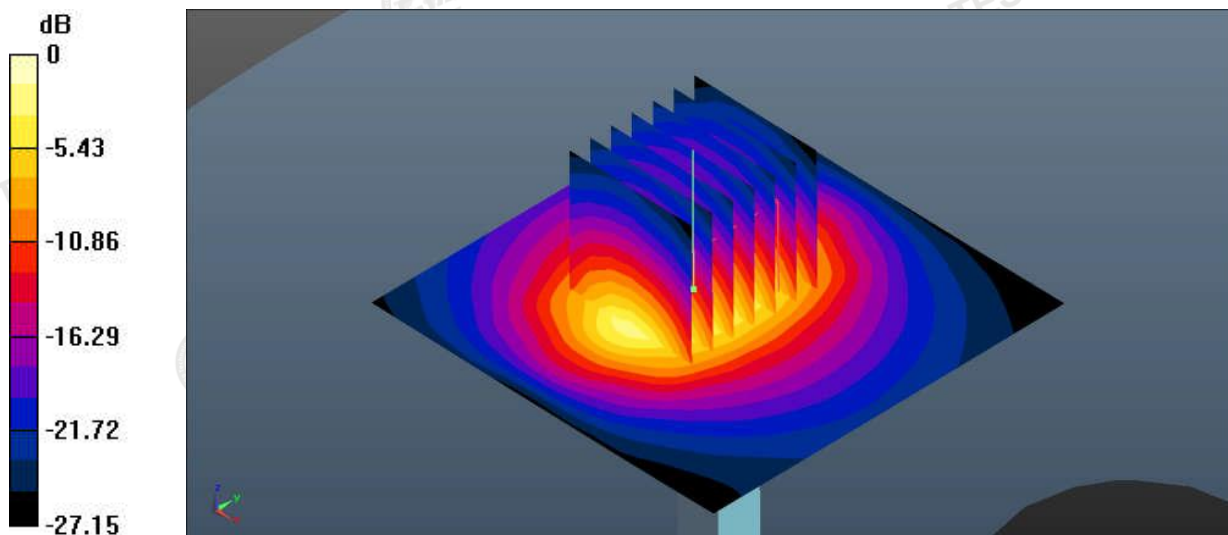

0 dB = 18.9 W/kg

System Performance Check 2450MHz 250mW

2600MHz System Check

Date: 05/30/2024

DUT: Dipole 2600 MHz; Type: D2600V2; Serial: 1073

Communication System: CW; Frequency: 2600 MHz; Duty Cycle: 1:1

Medium parameters used (interpolated): $f = 2600$ MHz; $\sigma = 2.014$ S/m; $\epsilon_r = 38.836$; $\rho = 1000$ kg/m³

Phantom section: Flat Section

DASY5 Configuration:

- Probe: EX3DV4 – SN7380; ConvF(7.35, 7.35, 7.35); Calibrated: June 21, 2023;
- Sensor-Surface: 3mm (Mechanical Surface Detection)
- Electronics: DAE3 Sn428; Calibrated: Aug.30,2023;
- Phantom: Twin-SAM V8.0 ; Type: QD 000 P41 AA; Serial: 1974;
- DASY52 52.10.2(1495); SEMCAD X 14.6.12(7450)

Area Scan (91x101x1): Interpolated grid: dx=1.200 mm, dy=1.200 mm

Maximum value of SAR (interpolated) = 21.1 W/kg

Zoom Scan (7x7x7)/Cube 0: Measurement grid: dx=5mm, dy=5mm, dz=5mm

Reference Value = 107.5V/m; Power Drift = 0.11 dB

Peak SAR (extrapolated) = 28.7 W/kg

SAR(1 g) = 14.51 W/kg; SAR(10 g) = 6.56 W/kg

Maximum value of SAR (measured) = 21.3 W/kg

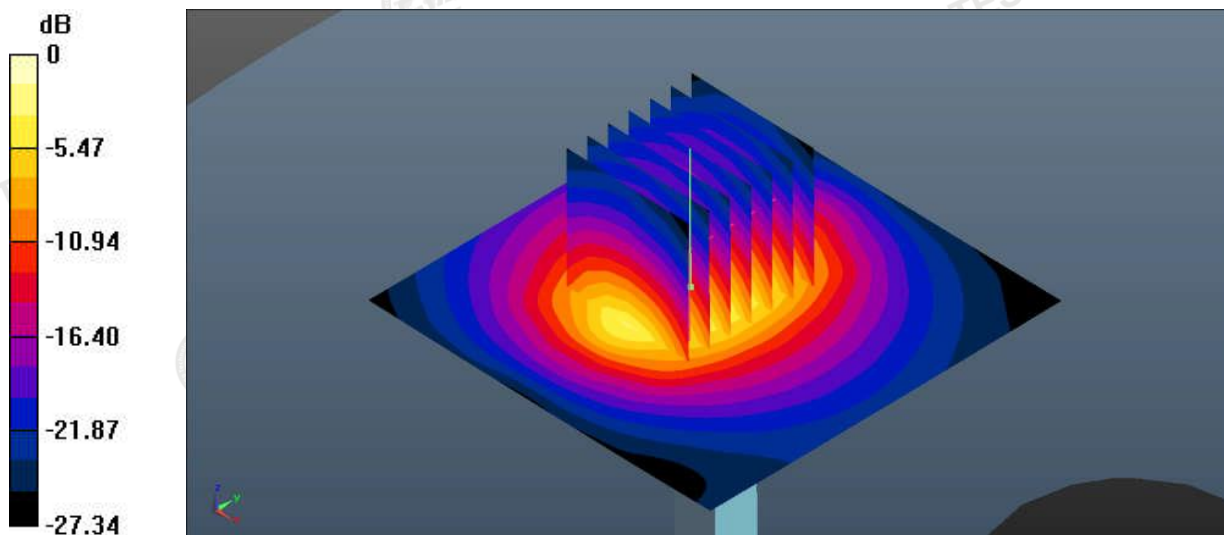

0 dB = 21.3 W/kg

System Performance Check 2600MHz 250mW

Appendix C. Plots of SAR Test Data

#1.

Date: 05/23/2024

GSM850_GSM Voice_Right Cheek_0mm_Ch190

Communication System: UID 0, GSM (0); Frequency: 836.6 MHz; Duty Cycle: 1:1

Medium parameters used (interpolated): $f = 836.6$ MHz; $\sigma = 0.891$ S/m; $\epsilon_r = 41.662$; $\rho = 1000$ kg/m³

Phantom section: Right Section

DASY5 Configuration:

- Probe: EX3DV4 - SN7380; ConvF(9.62, 9.62, 9.62); Calibrated: June 21, 2023;
- Sensor-Surface: 3mm (Mechanical Surface Detection)
- Electronics: DAE3 Sn428; Calibrated: Aug.30,2023;
- Phantom: Twin-SAM V8.0 ; Type: QD 000 P41 AA; Serial: 1974;
- DASY52 52.10.2(1495); SEMCAD X 14.6.12(7450)

Area Scan (71x91x1): Interpolated grid: dx=1.500 mm, dy=1.500 mm

Maximum value of SAR (interpolated) = 0.405 W/kg

Zoom Scan (5x5x7)/Cube 0: Measurement grid: dx=8mm, dy=8mm, dz=5mm

Reference Value = 17.56 V/m; Power Drift = -0.07 dB

Peak SAR (extrapolated) = 0.685 W/kg

SAR(1 g) = 0.335 W/kg; SAR(10 g) = 0.207 W/kg

Maximum value of SAR (measured) = 0.411 W/kg

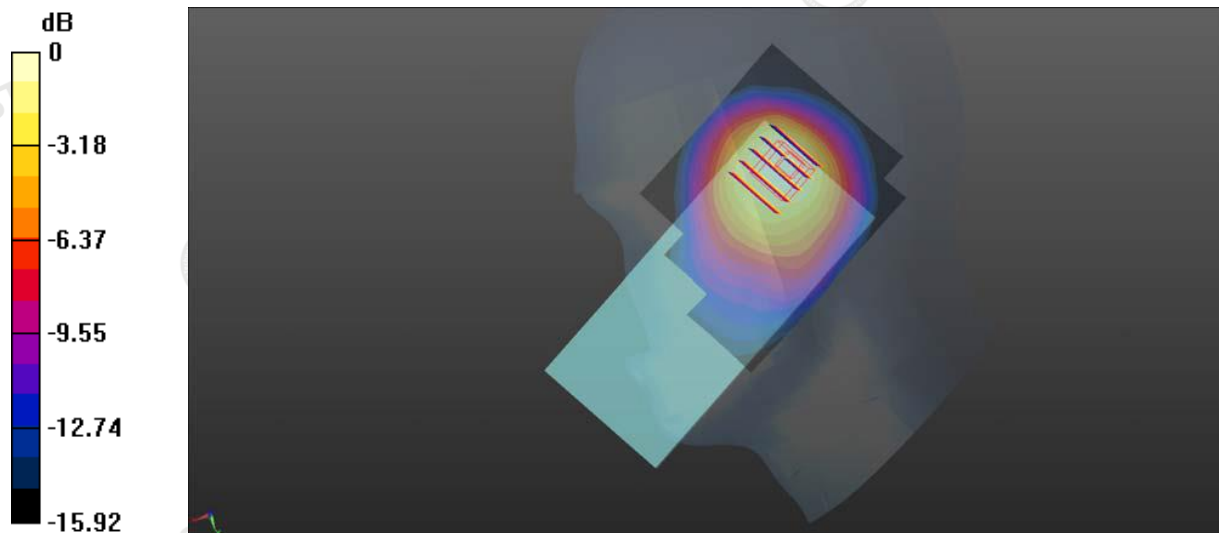

0 dB = 0.411 W/kg

#2.

Date: 05/28/2024

GSM1900_GSM Voice_Right Cheek_0mm_Ch810

Communication System: UID 0, GSM (0); Frequency: 1909.8 MHz; Duty Cycle: 1:1

Medium parameters used (interpolated): $f = 1909.8$ MHz; $\sigma = 1.407$ S/m; $\epsilon_r = 39.320$; $\rho = 1000$ kg/m³

Phantom section: Right Section

DASY5 Configuration:

- Probe: EX3DV4 - SN7380; ConvF(8.05, 8.05, 8.05); Calibrated: June 21, 2023;
- Sensor-Surface: 3mm (Mechanical Surface Detection)
- Electronics: DAE3 Sn428; Calibrated: Aug.30,2023;
- Phantom: Twin-SAM V8.0 ; Type: QD 000 P41 AA; Serial: 1974;
- DASY52 52.10.2(1495); SEMCAD X 14.6.12(7450)

Area Scan (71x91x1): Interpolated grid: dx=1.500 mm, dy=1.500 mm

Maximum value of SAR (interpolated) = 0.575 W/kg

Zoom Scan (5x5x7)/Cube 0: Measurement grid: dx=8mm, dy=8mm, dz=5mm

Reference Value = 14.21 V/m; Power Drift = -0.09 dB

Peak SAR (extrapolated) = 0.852 W/kg

SAR(1 g) = 0.484 W/kg; SAR(10 g) = 0.271 W/kg

Maximum value of SAR (measured) = 0.514 W/kg

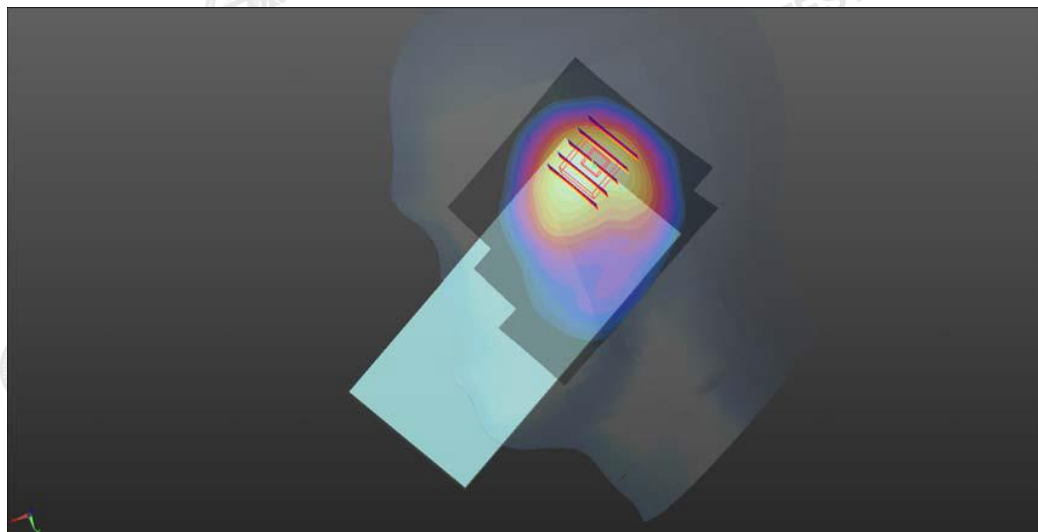
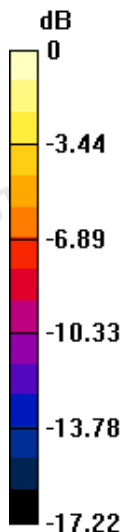

0 dB = 0.514 W/kg

#3.

Date: 05/28/2024

WCDMA II_RMC 12.2Kbps_Right Cheek_0mm_Ch9262

Communication System: UID 0, WCDMA (0); Frequency: 1852.4 MHz; Duty Cycle: 1:1

Medium parameters used (interpolated): $f = 1852.4$ MHz; $\sigma = 1.428$ S/m; $\epsilon_r = 40.700$; $\rho = 1000$ kg/m³

Phantom section: Right Section

DASY5 Configuration:

- Probe: EX3DV4 - SN7380; ConvF(8.05, 8.05, 8.05); Calibrated: June 21, 2023;
- Sensor-Surface: 3mm (Mechanical Surface Detection)
- Electronics: DAE3 Sn428; Calibrated: Aug.30,2023;
- Phantom: Twin-SAM V8.0 ; Type: QD 000 P41 AA; Serial: 1974;
- DASY52 52.10.2(1495); SEMCAD X 14.6.12(7450)

Area Scan (71x91x1): Interpolated grid: dx=1.500 mm, dy=1.500 mm

Maximum value of SAR (interpolated) = 0.895 W/kg

Zoom Scan (5x5x7)/Cube 0: Measurement grid: dx=8mm, dy=8mm, dz=5mm

Reference Value = 18.66 V/m; Power Drift = -0.03 dB

Peak SAR (extrapolated) = 1.06 W/kg

SAR(1 g) = 0.610 W/kg; SAR(10 g) = 0.341 W/kg

Maximum value of SAR (measured) = 0.870 W/kg

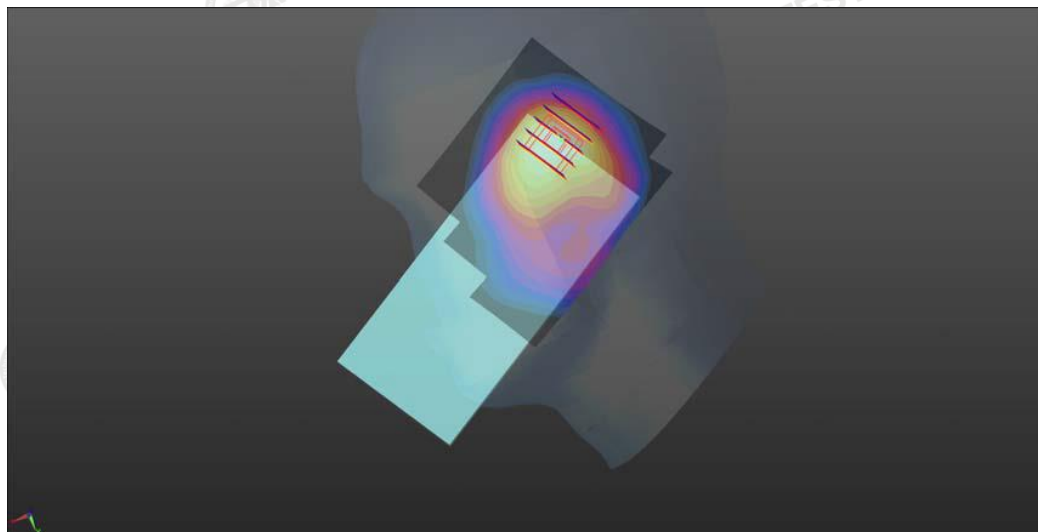
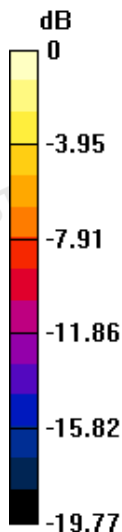

0 dB = 0.870 W/kg

#4.

Date: 05/24/2024

WCDMA IV_RMC 12.2Kbps_Right Cheek_0mm_Ch1412

Communication System: UID 0, WCDMA (0); Frequency: 1732.6 MHz; Duty Cycle: 1:1

Medium parameters used (interpolated): $f = 1732.6$ MHz; $\sigma = 1.334$ S/m; $\epsilon_r = 40.974$; $\rho = 1000$ kg/m³

Phantom section: Right Section

DASY5 Configuration:

- Probe: EX3DV4 - SN7380; ConvF(8.35, 8.35, 8.35); Calibrated: June 21, 2023;
- Sensor-Surface: 3mm (Mechanical Surface Detection)
- Electronics: DAE3 Sn428; Calibrated: Aug.30,2023;
- Phantom: Twin-SAM V8.0 ; Type: QD 000 P41 AA; Serial: 1974;
- DASY52 52.10.2(1495); SEMCAD X 14.6.12(7450)

Area Scan (71x91x1): Interpolated grid: dx=1.500 mm, dy=1.500 mm

Maximum value of SAR (interpolated) = 0.755 W/kg

Zoom Scan (5x5x7)/Cube 0: Measurement grid: dx=8mm, dy=8mm, dz=5mm

Reference Value = 15.04 V/m; Power Drift = -0.05 dB

Peak SAR (extrapolated) = 0.890 W/kg

SAR(1 g) = 0.471 W/kg; SAR(10 g) = 0.262 W/kg

Maximum value of SAR (measured) = 0.614 W/Kg

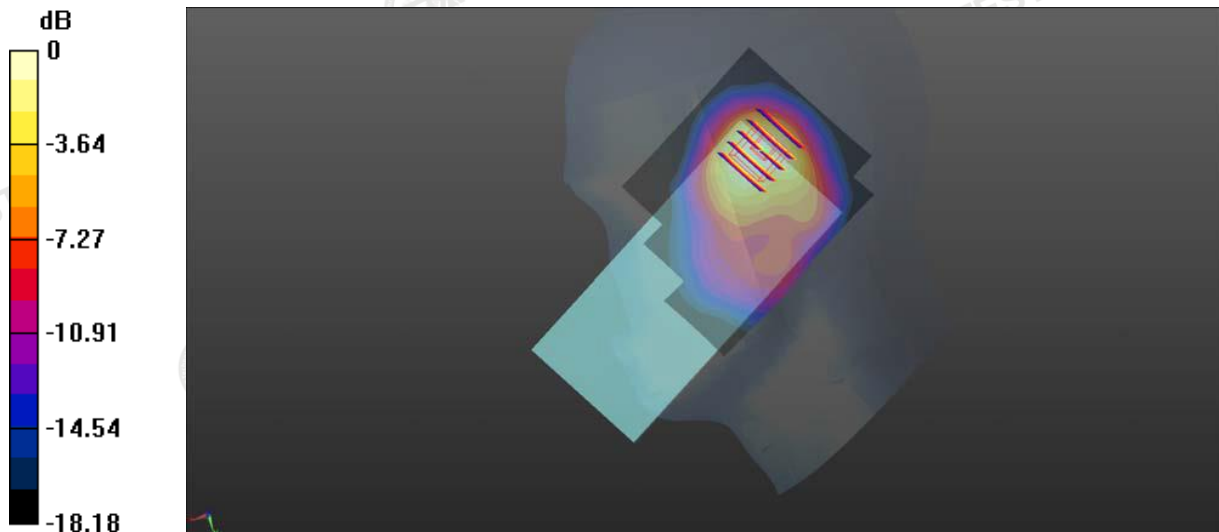

0 dB = 0.614 W/kg

#5.

Date: 05/23/2024

WCDMA V_RMC 12.2Kbps_Right Cheek_0mm_Ch4233

Communication System: UID 0, WCDMA (0); Frequency: 846.6 MHz; Duty Cycle: 1:1

Medium parameters used (interpolated): $f = 846.6$ MHz; $\sigma = 0.889$ S/m; $\epsilon_r = 41.542$; $\rho = 1000$ kg/m³

Phantom section: Right Section

DASY5 Configuration:

- Probe: EX3DV4 - SN7380; ConvF(9.62, 9.62, 9.62); Calibrated: June 21, 2023;
- Sensor-Surface: 3mm (Mechanical Surface Detection)
- Electronics: DAE3 Sn428; Calibrated: Aug.30,2023;
- Phantom: Twin-SAM V8.0 ; Type: QD 000 P41 AA; Serial: 1974;
- DASY52 52.10.2(1495); SEMCAD X 14.6.12(7450)

Area Scan (71x91x1): Interpolated grid: dx=1.500 mm, dy=1.500 mm

Maximum value of SAR (interpolated) = 0.618 W/kg

Zoom Scan (5x5x7)/Cube 0: Measurement grid: dx=8mm, dy=8mm, dz=5mm

Reference Value = 22.45 V/m; Power Drift = -0.06 dB

Peak SAR (extrapolated) = 1.07 W/kg

SAR(1 g) = 0.601 W/kg; SAR(10 g) = 0.332 W/kg

Maximum value of SAR (measured) = 0.654 W/Kg

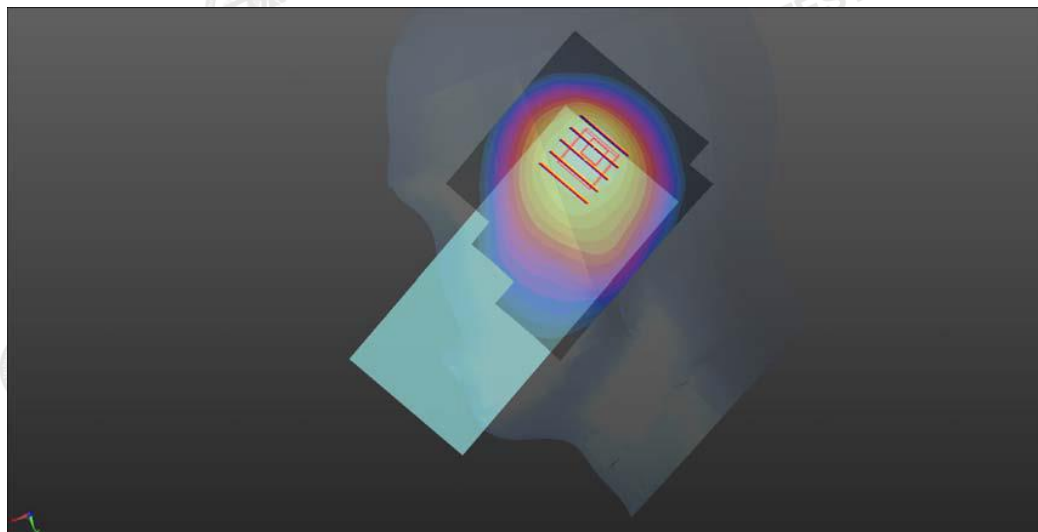
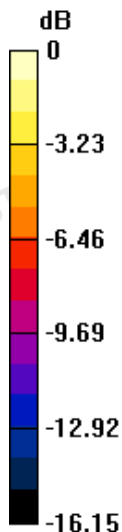

0 dB = 0.654 W/kg

#6.

Date: 05/29/2024

LTE Band 7_20M_QPSK_1RB#99_Left Cheek_0mm_Ch21100

Communication System: UID 0, LTE (0); Frequency: 2535.0 MHz; Duty Cycle: 1:1

Medium parameters used (interpolated): $f = 2535.0$ MHz; $\sigma = 1.962$ S/m; $\epsilon_r = 39.862$; $\rho = 1000$ kg/m³

Phantom section: Left Section

DASY5 Configuration:

- Probe: EX3DV4 - SN7380; ConvF(7.35, 7.35, 7.35); Calibrated: June 21, 2023;
- Sensor-Surface: 2mm (Mechanical Surface Detection)
- Electronics: DAE3 Sn428; Calibrated: Aug.30,2023;
- Phantom: Twin-SAM V8.0 ; Type: QD 000 P41 AA; Serial: 1974;
- DASY52 52.10.2(1495); SEMCAD X 14.6.12(7450)

Area Scan (81x91x1): Interpolated grid: dx=1.200 mm, dy=1.200 mm

Maximum value of SAR (interpolated) = 0.821 W/kg

Zoom Scan (7x7x7)/Cube 0: Measurement grid: dx=5mm, dy=5mm, dz=5mm

Reference Value = 9.645 V/m; Power Drift = -0.11 dB

Peak SAR (extrapolated) = 1.05 W/kg

SAR(1 g) = 0.551 W/kg; SAR(10 g) = 0.264 W/kg

Maximum value of SAR (measured) = 0.851 W/Kg

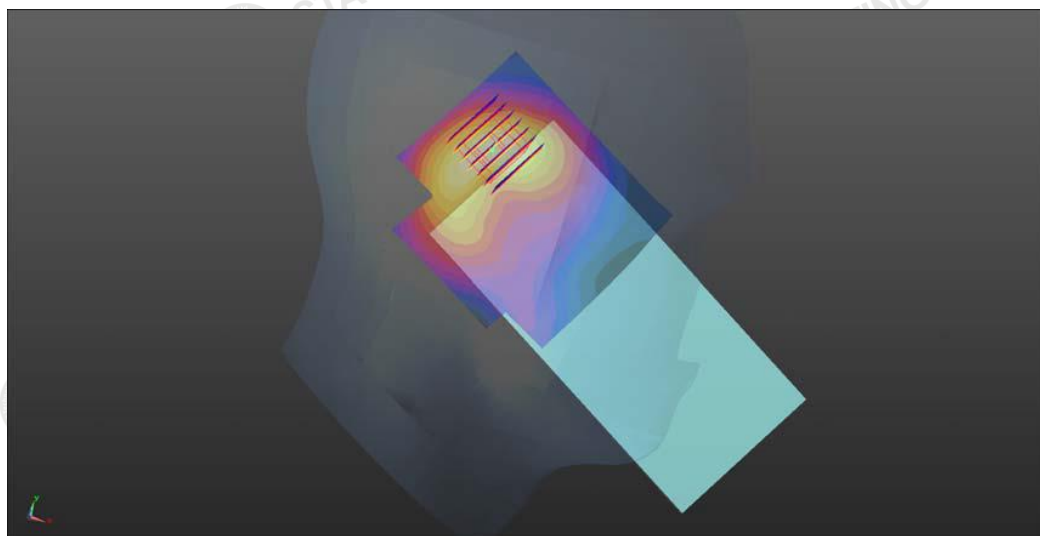
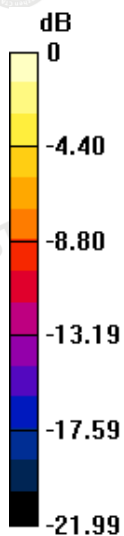

0 dB = 0.851 W/kg

#7.

Date: 05/22/2024

LTE Band 12_10M_QPSK_1RB#25_Left Cheek_0mm_Ch23130

Communication System: UID 0, LTE (0); Frequency: 711.0 MHz; Duty Cycle: 1:1

Medium parameters used (interpolated): $f = 711.0$ MHz; $\sigma = 0.876$ S/m; $\epsilon_r = 42.487$; $\rho = 1000$ kg/m³

Phantom section: Left Section

DASY5 Configuration:

- Probe: EX3DV4 - SN7380; ConvF(10.02, 10.02, 10.02); Calibrated: June 21, 2023
- Sensor-Surface: 2mm (Mechanical Surface Detection)
- Electronics: DAE3 Sn428; Calibrated: Aug.30,2023;
- Phantom: SAM 1; Type: SAM;
- Measurement SW: DASY52, Version 52.8 (2); SEMCAD X Version 14.6.10 (7164)

Area Scan (81x91x1): Interpolated grid: dx=1.500 mm, dy=1.500 mm

Maximum value of SAR (interpolated) = 0.869 W/kg

Zoom Scan (5x5x7)/Cube 0: Measurement grid: dx=8mm, dy=8mm, dz=5mm

Reference Value = 9.641 V/m; Power Drift = -0.03 dB

Peak SAR (extrapolated) = 1.05 W/kg

SAR(1 g) = 0.537 W/kg; SAR(10 g) = 0.246 W/kg

Maximum value of SAR (measured) = 0.855 W/Kg

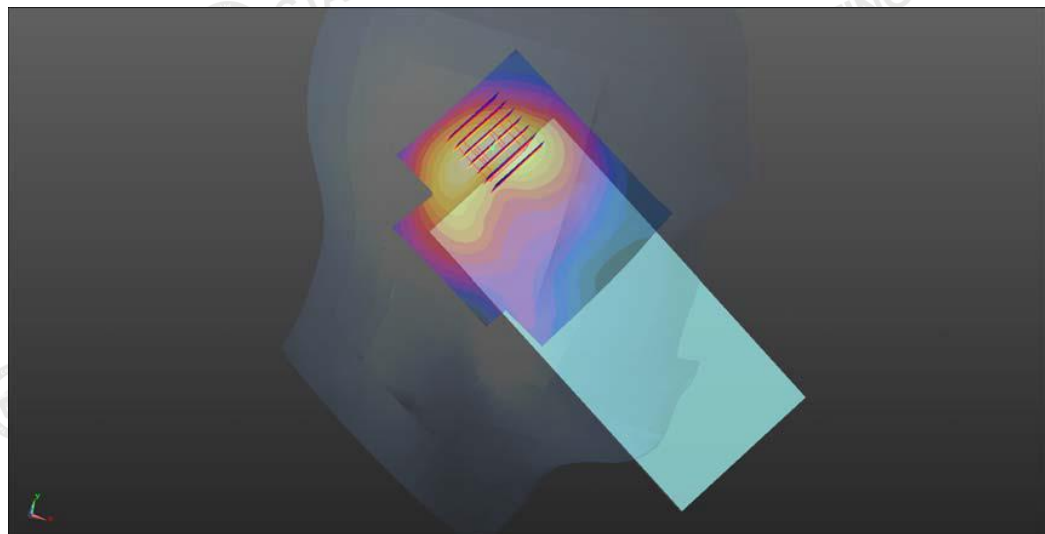
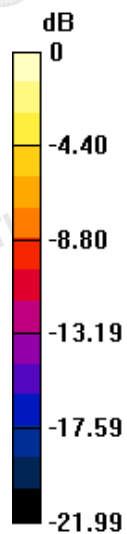

0 dB = 0.855 W/kg

#8.

Date: 05/28/2024

LTE Band 25_20M_QPSK_1RB#99_Right Cheek_0mm_Ch26140

Communication System: UID 0, Generic LTE (0); Frequency: 1860.0 MHz; Duty Cycle: 1:1

Medium parameters used (interpolated): $f = 1860.0$ MHz; $\sigma = 1.374$ S/m; $\epsilon_r = 38.880$; $\rho = 1000$ kg/m³

Phantom section: Right Section

DASY5 Configuration:

- Probe: EX3DV4 - SN7380; ConvF(8.05, 8.05, 8.05); Calibrated: June 21, 2023;
- Sensor-Surface: 3mm (Mechanical Surface Detection)
- Electronics: DAE3 Sn428; Calibrated: Aug.30,2023;
- Phantom: Twin-SAM V8.0 ; Type: QD 000 P41 AA; Serial: 1974;
- DASY52 52.10.2(1495); SEMCAD X 14.6.12(7450)

Area Scan (71x81x1): Interpolated grid: dx=1.500 mm, dy=1.500 mm

Maximum value of SAR (interpolated) = 0.744 W/kg

Zoom Scan (5x5x7)/Cube 0: Measurement grid: dx=8mm, dy=8mm, dz=5mm

Reference Value = 19.21 V/m; Power Drift = -0.03 dB

Peak SAR (extrapolated) = 1.04 W/kg

SAR(1 g) = 0.611 W/kg; SAR(10 g) = 0.304 W/kg

Maximum value of SAR (measured) = 0.675 W/kg

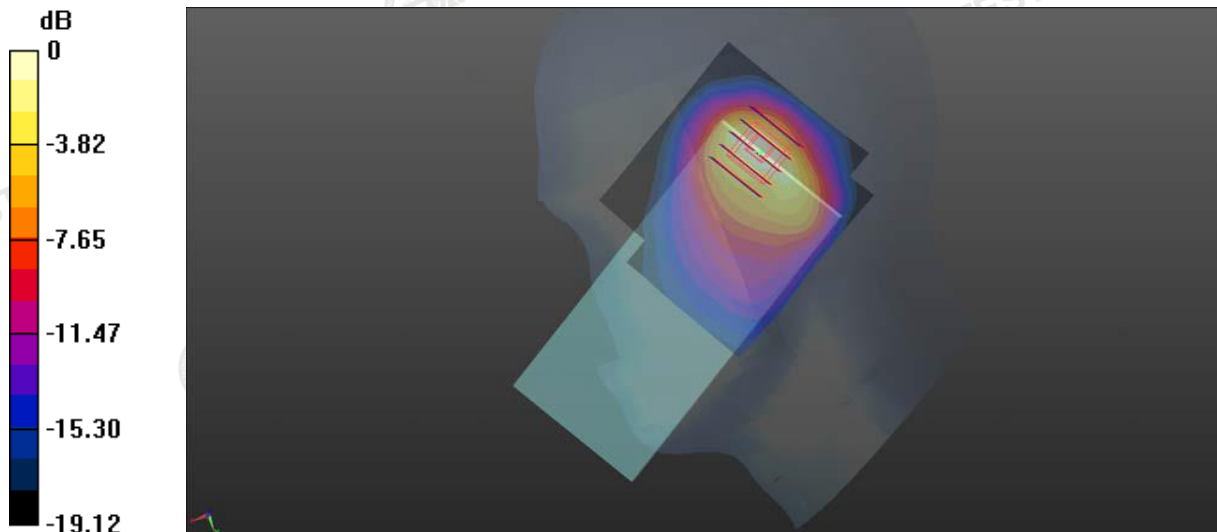

0 dB = 0.675 W/kg

#9.

Date: 05/23/2024

LTE Band 26 Lower band_10M_QPSK_1RB#0_Right Cheek_0mm_Ch26740

Communication System: UID 0, LTE (0); Frequency: 819.0 MHz; Duty Cycle: 1:1

Medium parameters used (interpolated): $f = 819.0$ MHz; $\sigma = 0.879$ S/m; $\epsilon_r = 41.537$; $\rho = 1000$ kg/m³

Phantom section: Right Section

DASY5 Configuration:

- Probe: EX3DV4 - SN7380; ConvF(9.62, 9.62, 9.62); Calibrated: June 21, 2023;
- Sensor-Surface: 3mm (Mechanical Surface Detection)
- Electronics: DAE3 Sn428; Calibrated: Aug.30,2023;
- Phantom: Twin-SAM V8.0 ; Type: QD 000 P41 AA; Serial: 1974;
- DASY52 52.10.2(1495); SEMCAD X 14.6.12(7450)

Area Scan (71x81x1): Interpolated grid: dx=1.500 mm, dy=1.500 mm

Maximum value of SAR (interpolated) = 0.712 W/kg

Zoom Scan (5x5x7)/Cube 0: Measurement grid: dx=8mm, dy=8mm, dz=5mm

Reference Value = 18.25 V/m; Power Drift = -0.11 dB

Peak SAR (extrapolated) = 0.906 W/kg

SAR(1 g) = 0.501 W/kg; SAR(10 g) = 0.289 W/kg

Maximum value of SAR (measured) = 0.688 W/Kg

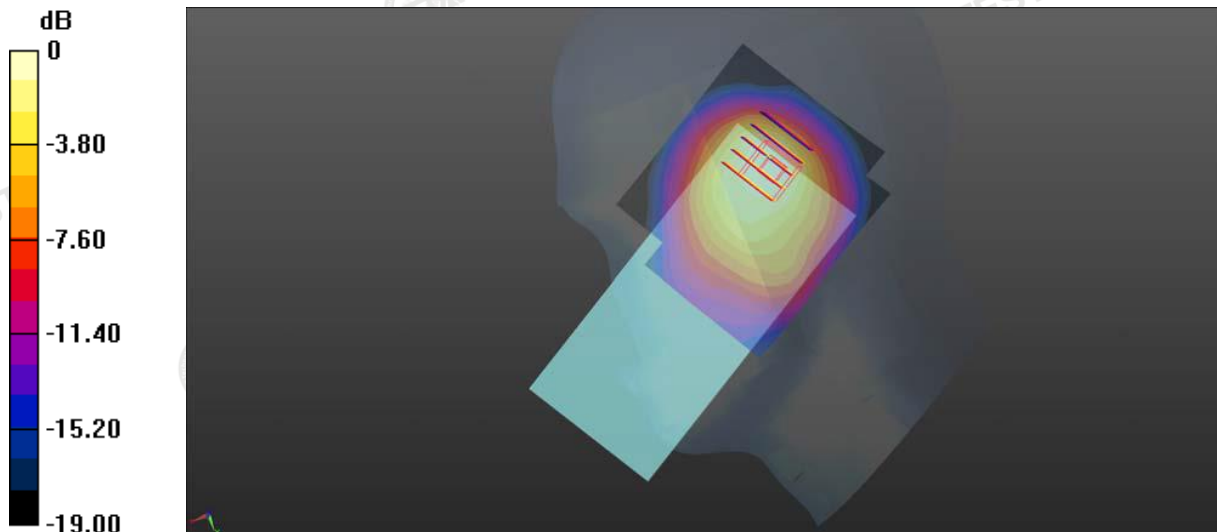

0 dB = 0.688 W/kg

#10.

Date: 05/23/2024

LTE Band 26 Higher band_15M_QPSK_1RB#37_Right Cheek_0mm_Ch26865

Communication System: UID 0, LTE (0); Frequency: 831.5 MHz; Duty Cycle: 1:1

Medium parameters used (interpolated): $f = 831.5$ MHz; $\sigma = 0.902$ S/m; $\epsilon_r = 41.837$; $\rho = 1000$ kg/m³

Phantom section: Right Section

DASY5 Configuration:

- Probe: EX3DV4 - SN7380; ConvF(9.62, 9.62, 9.62); Calibrated: June 21, 2023;
- Sensor-Surface: 3mm (Mechanical Surface Detection)
- Electronics: DAE3 Sn428; Calibrated: Aug.30,2023;
- Phantom: Twin-SAM V8.0 ; Type: QD 000 P41 AA; Serial: 1974;
- DASY52 52.10.2(1495); SEMCAD X 14.6.12(7450)

Area Scan (71x81x1): Interpolated grid: dx=1.500 mm, dy=1.500 mm

Maximum value of SAR (interpolated) = 0.688 W/kg

Zoom Scan (5x5x7)/Cube 0: Measurement grid: dx=8mm, dy=8mm, dz=5mm

Reference Value = 20.66 V/m; Power Drift = -0.14 dB

Peak SAR (extrapolated) = 0.875 W/kg

SAR(1 g) = 0.466 W/kg; SAR(10 g) = 0.271 W/kg

Maximum value of SAR (measured) = 0.626 W/Kg

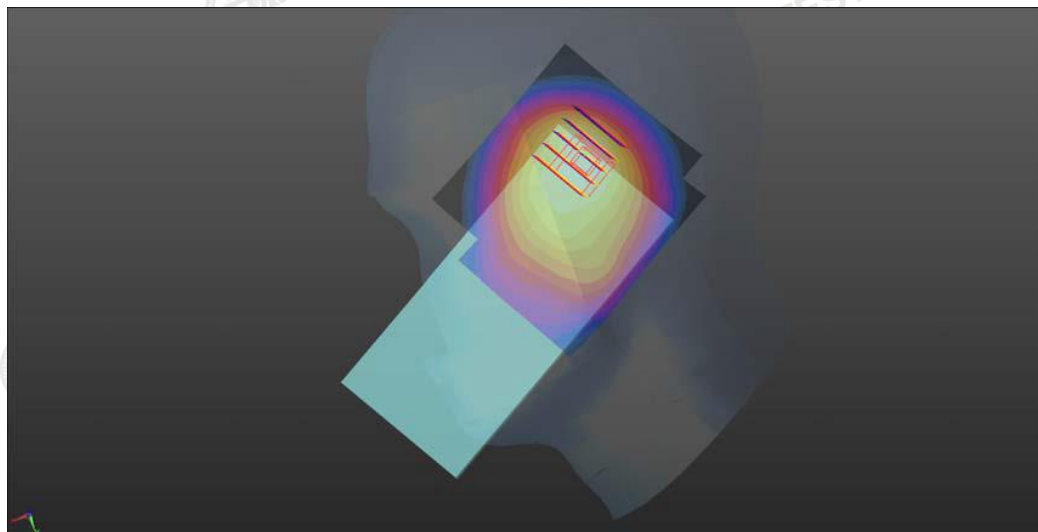
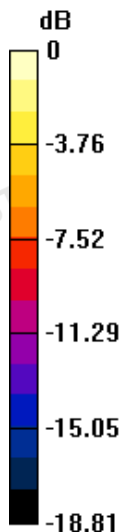

0 dB = 0.626 W/kg

#11.

Date: 05/24/2024

LTE Band 66_20M_QPSK_1RB#0_Right Cheek_0mm_Ch132322

Communication System: UID 0, LTE (0); Frequency: 1745.0 MHz; Duty Cycle: 1:1

Medium parameters used (interpolated): $f = 1745.0$ MHz; $\sigma = 1.348$ S/m; $\epsilon_r = 39.763$; $\rho = 1000$ kg/m³

Phantom section: Right Section

DASY5 Configuration:

- Probe: EX3DV4 - SN7380; ConvF(8.35, 8.35, 8.35); Calibrated: June 21, 2023
- Sensor-Surface: 2mm (Mechanical Surface Detection)
- Electronics: DAE3 Sn428; Calibrated: Aug.30,2023;
- Phantom: Twin-SAM V8.0 ; Type: QD 000 P41 AA; Serial: 1974;
- DASY52 52.10.2(1495); SEMCAD X 14.6.12(7450)

Area Scan (61x101x1): Interpolated grid: dx=1.500 mm, dy=1.500 mm

Maximum value of SAR (interpolated) = 0.735 W/kg

Zoom Scan (5x5x7)/Cube 0: Measurement grid: dx=8mm, dy=8mm, dz=5mm

Reference Value = 15.07 V/m; Power Drift = -0.05 dB

Peak SAR (extrapolated) = 1.05 W/kg

SAR(1 g) = 0.566 W/kg; SAR(10 g) = 0.311 W/kg

Maximum value of SAR (measured) = 0.616 W/kg

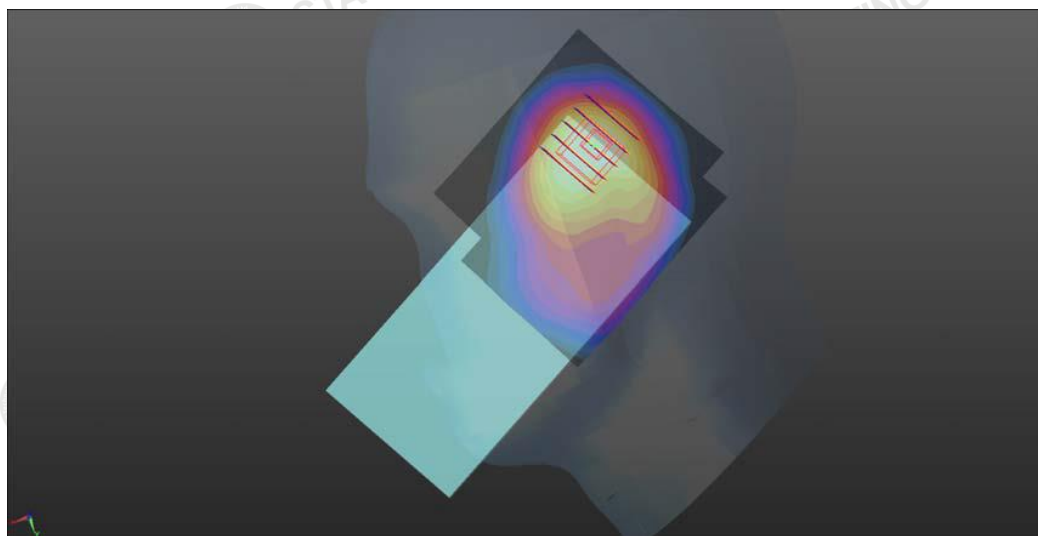
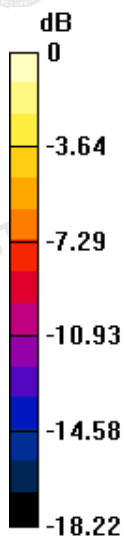

0 dB = 0.616W/kg

#12.

Date: 05/29/2024

LTE Band 41_20M_QPSK_1RB#49_Left Cheek_0mm_Ch41140

Communication System: UID 0, LTE (0); Frequency: 2645.0 MHz; Duty Cycle: 1:1

Medium parameters used (interpolated): $\omega = 2645.0$ MHz; $\sigma = 1.984$ S/m; $\epsilon_r = 38.676$; $\rho = 1000$ kg/m³

Phantom section: Left Section

DASY5 Configuration:

- Probe: EX3DV4 - SN7380; ConvF(10.02, 10.02, 10.02); Calibrated: June 21, 2023
- Sensor-Surface: 2mm (Mechanical Surface Detection)
- Electronics: DAE3 Sn428; Calibrated: Aug.30,2023;
- Phantom: Twin-SAM V8.0 ; Type: QD 000 P41 AA; Serial: 1974;
- DASY52 52.10.2(1495); SEMCAD X 14.6.12(7450)

Area Scan (81x101x1): Interpolated grid: dx=1.200 mm, dy=1.200 mm

Maximum value of SAR (interpolated) = 0.835 W/kg

Zoom Scan (7x7x7)/Cube 0: Measurement grid: dx=5mm, dy=5mm, dz=5mm

Reference Value = 9.541 V/m; Power Drift = -0.06 dB

Peak SAR (extrapolated) = 1.15 W/kg

SAR(1 g) = 0.533 W/kg; SAR(10 g) = 0.242 W/kg

Maximum value of SAR (measured) = 0.852 W/Kg

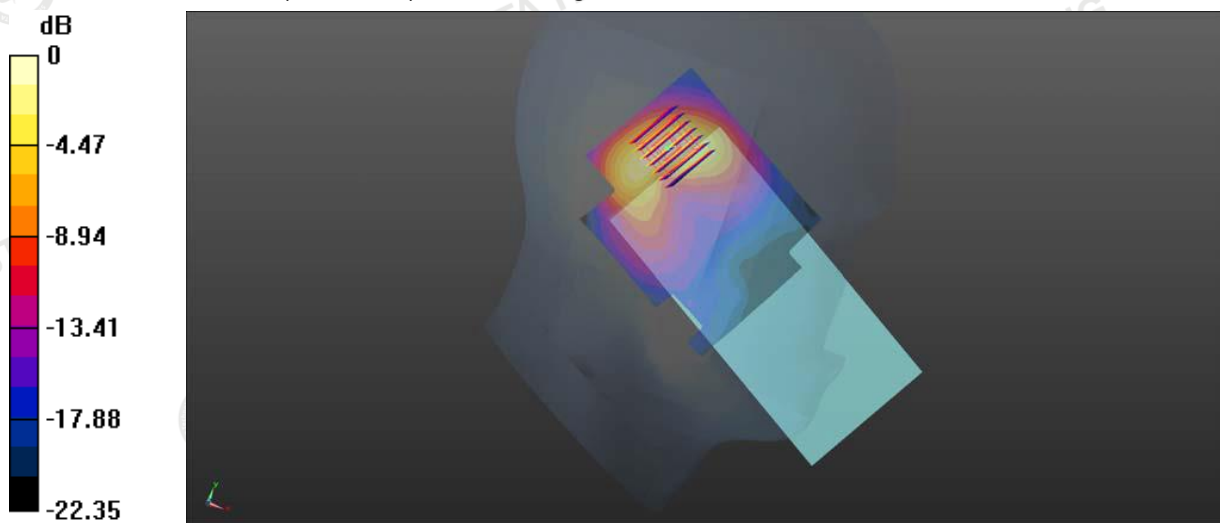

0 dB = 0.852 W/kg

#13.

Date: 05/30/2024

WLAN2.4GHz_802.11b 1Mbps_Left Cheek_0mm_Ch11

Communication System: UID 0, WIFI (0); Frequency: 2462.0 MHz; Duty Cycle: 1:1

Medium parameters used (interpolated): $f = 2462.0$ MHz; $\sigma = 1.829$ S/m; $\epsilon_r = 38.440$; $\rho = 1000$ kg/m³

Phantom section: Left Section

DASY5 Configuration:

- Probe: EX3DV4 - SN7380; ConvF(7.50, 7.50, 7.50); Calibrated: June 21, 2023
- Sensor-Surface: 2mm (Mechanical Surface Detection)
- Electronics: DAE3 Sn428; Calibrated: Aug.30,2023;
- Phantom: Twin-SAM V8.0 ; Type: QD 000 P41 AA; Serial: 1974;
- DASY52 52.10.2(1495); SEMCAD X 14.6.12(7450)

Area Scan (91x101x1): Interpolated grid: dx=1.200 mm, dy=1.200 mm

Maximum value of SAR (interpolated) = 0.562 W/kg

Zoom Scan (7x7x7)/Cube 0: Measurement grid: dx=5mm, dy=5mm, dz=5mm

Reference Value = 6.269 V/m; Power Drift = -0.10 dB

Peak SAR (extrapolated) = 0.796 W/kg

SAR(1 g) = 0.378 W/kg; SAR(10 g) = 0.192 W/kg

Maximum value of SAR (measured) = 0.565 W/kg

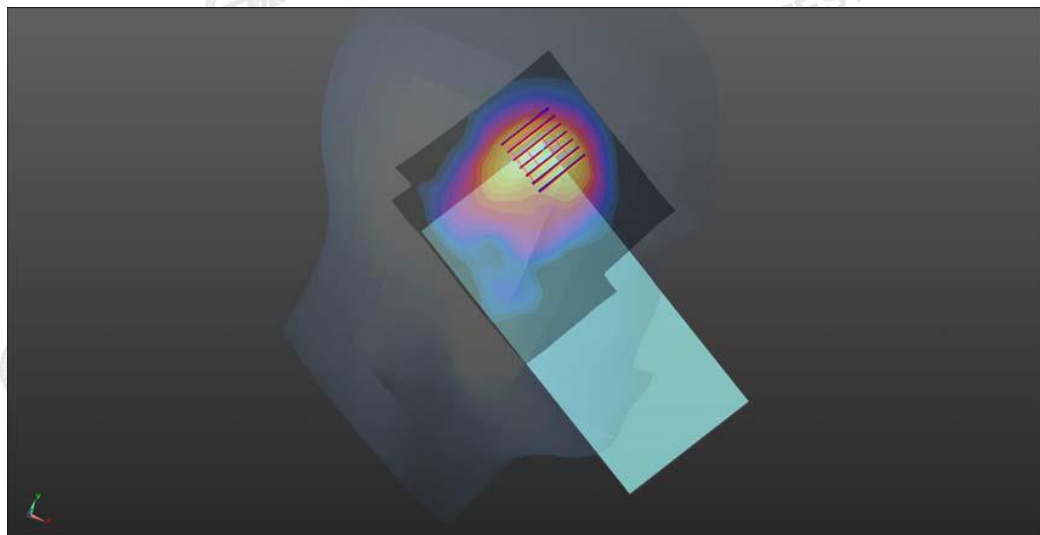
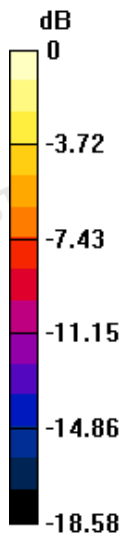

0 dB = 0.565 W/kg

#14.

Date: 05/23/2024

GPRS850_1Tx slots_Back_10mm_CH251

Communication System: UID 0, GSM (0); Frequency: 848.8 MHz; Duty Cycle: 1:1

Medium parameters used (interpolated): $f = 848.8$ MHz; $\sigma = 0.915$ S/m; $\epsilon_r = 42.264$; $\rho = 1000$ kg/m³

Phantom section: Flat Section

DASY5 Configuration:

- Probe: EX3DV4 - SN7380; ConvF(9.62, 9.62, 9.62); Calibrated: June 21, 2023
- Sensor-Surface: 2mm (Mechanical Surface Detection)
- Electronics: DAE3 Sn428; Calibrated: Aug.30,2023;
- Phantom: Twin-SAM V8.0 ; Type: QD 000 P41 AA; Serial: 1974;
- DASY52 52.10.2(1495); SEMCAD X 14.6.12(7450)

Area Scan (61x131x1): Interpolated grid: dx=1.500 mm, dy=1.500 mm

Maximum value of SAR (interpolated) = 0.513 W/Kg

Zoom Scan (5x5x7)/Cube 0: Measurement grid: dx=8mm, dy=8mm, dz=5mm

Reference Value = 16.37 V/m; Power Drift = -0.04 dB

Peak SAR (extrapolated) = 0.862 W/kg

SAR(1 g) = 0.411 W/Kg; SAR(10 g) = 0.238 W/Kg

Maximum value of SAR (measured) = 0.520 W/Kg

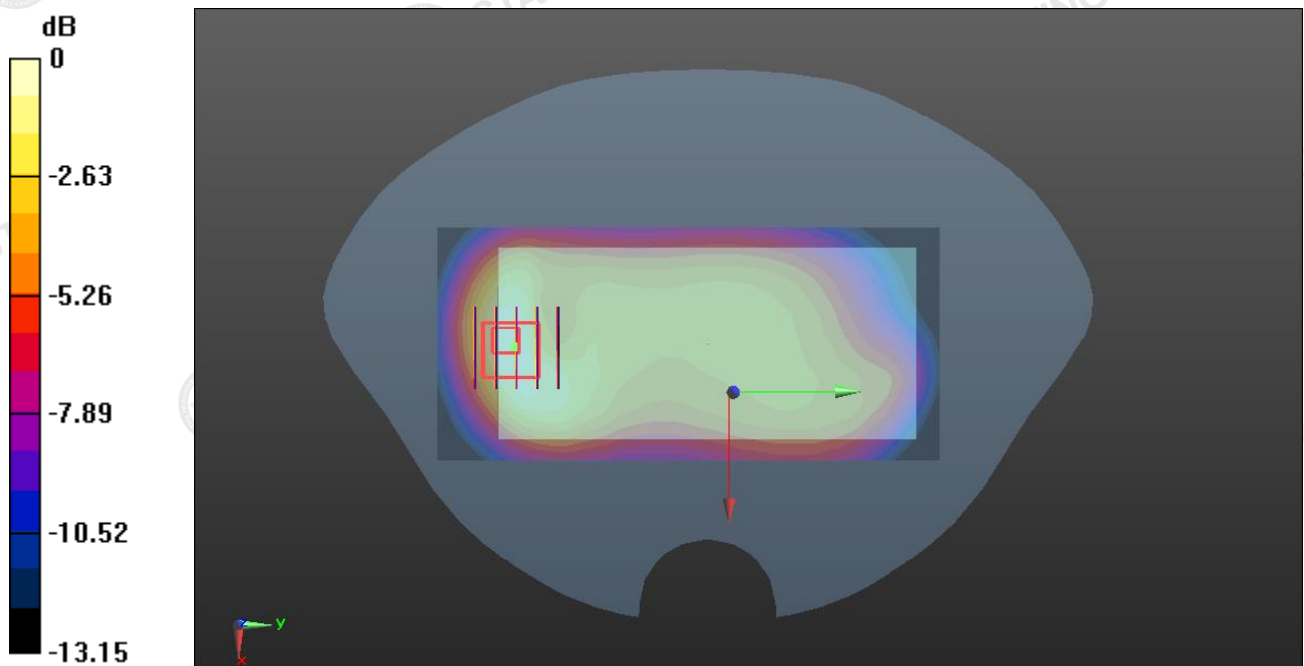

0 dB = 0.520 W/kg

#15.

Date: 05/28/2024

GPRS 1900_1Tx slots_Back_10mm_CH512

Communication System: UID 0, GSM (0); Frequency: 1850.2 MHz; Duty Cycle: 1:1

Medium parameters used: $f = 1850.2$ MHz; $\sigma = 1.429$ S/m; $\epsilon_r = 39.104$; $\rho = 1000$ kg/m³

Phantom section: Flat Section

DASY5 Configuration:

- Probe: EX3DV4 - SN7380; ConvF(8.05, 8.05, 8.05); Calibrated: June 21, 2023
- Sensor-Surface: 2mm (Mechanical Surface Detection)
- Electronics: DAE3 Sn428; Calibrated: Aug.30,2023;
- Phantom: Twin-SAM V8.0 ; Type: QD 000 P41 AA; Serial: 1974;
- DASY52 52.10.2(1495); SEMCAD X 14.6.12(7450)

Area Scan (71x121x1): Interpolated grid: dx=1.500 mm, dy=1.500 mm

Maximum value of SAR (interpolated) = 0.915 W/Kg

Zoom Scan (5x5x7)/Cube 0: Measurement grid: dx=8mm, dy=8mm, dz=5mm

Reference Value = 5.263 V/m; Power Drift = 0.10 dB

Peak SAR (extrapolated) = 1.32 W/kg

SAR(1 g) = 0.641 W/Kg; SAR(10 g) = 0.301 W/Kg

Maximum value of SAR (measured) = 0.975 W/Kg

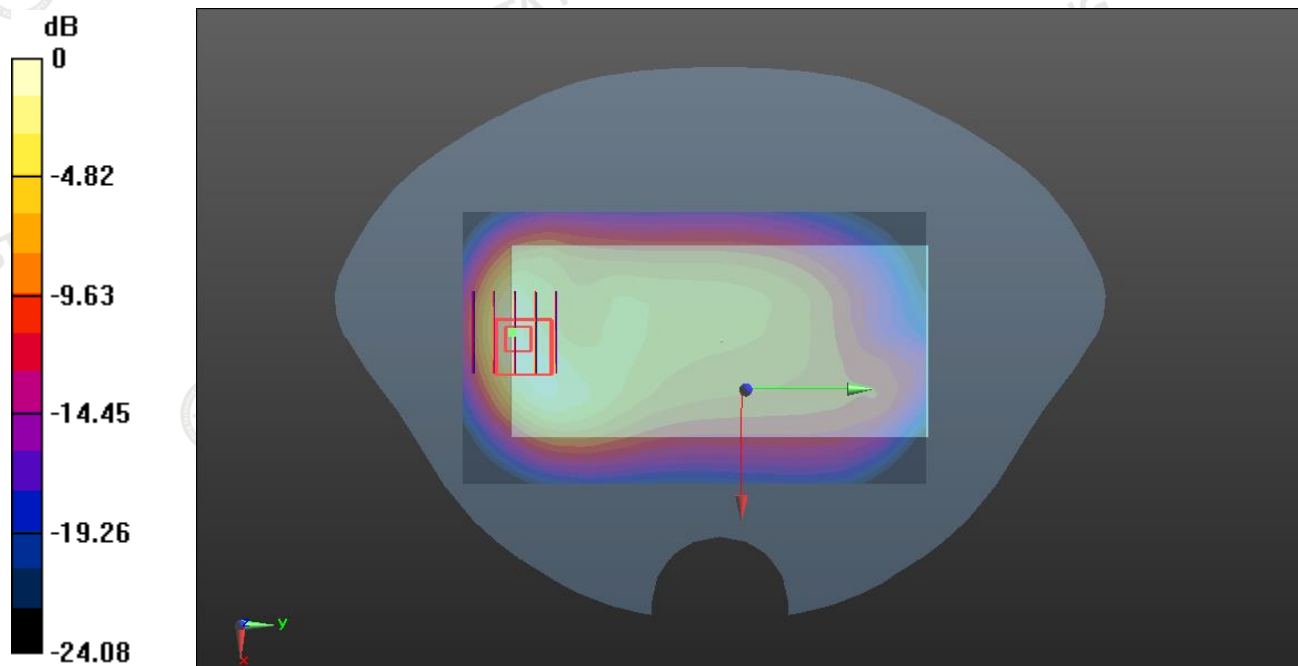

0 dB = 0.975 W/kg

#16.

Date: 05/28/2024

WCDMA II_RMC 12.2Kbps_ Back_10mm_Ch9262

Communication System: UID 0, Generic WCDMA (0); Frequency: 1852.4 MHz; Duty Cycle: 1:1

Medium parameters used (interpolated): $f = 1852.4$ MHz; $\sigma = 1.426$ S/m; $\epsilon_r = 39.504$; $\rho = 1000$ kg/m³

Phantom section: Flat Section

DASY5 Configuration:

- Probe: EX3DV4 - SN7380; ConvF(8.05, 8.05, 8.05); Calibrated: June 21, 2023
- Sensor-Surface: 2mm (Mechanical Surface Detection)
- Electronics: DAE3 Sn428; Calibrated: Aug.30,2023;
- Phantom: Twin-SAM V8.0 ; Type: QD 000 P41 AA; Serial: 1974;
- DASY52 52.10.2(1495); SEMCAD X 14.6.12(7450)

Area Scan (71x81x1): Interpolated grid: dx=1.500 mm, dy=1.500 mm

Maximum value of SAR (interpolated) = 0.533 W/Kg

Zoom Scan (5x5x7)/Cube 0: Measurement grid: dx=8mm, dy=8mm, dz=5mm

Reference Value = 9.623 V/m; Power Drift = 0.11 dB

Peak SAR (extrapolated) = 0.734 W/kg

SAR(1 g) = 0.389 W/Kg; SAR(10 g) = 0.192 W/Kg

Maximum value of SAR (measured) = 0.507 W/Kg

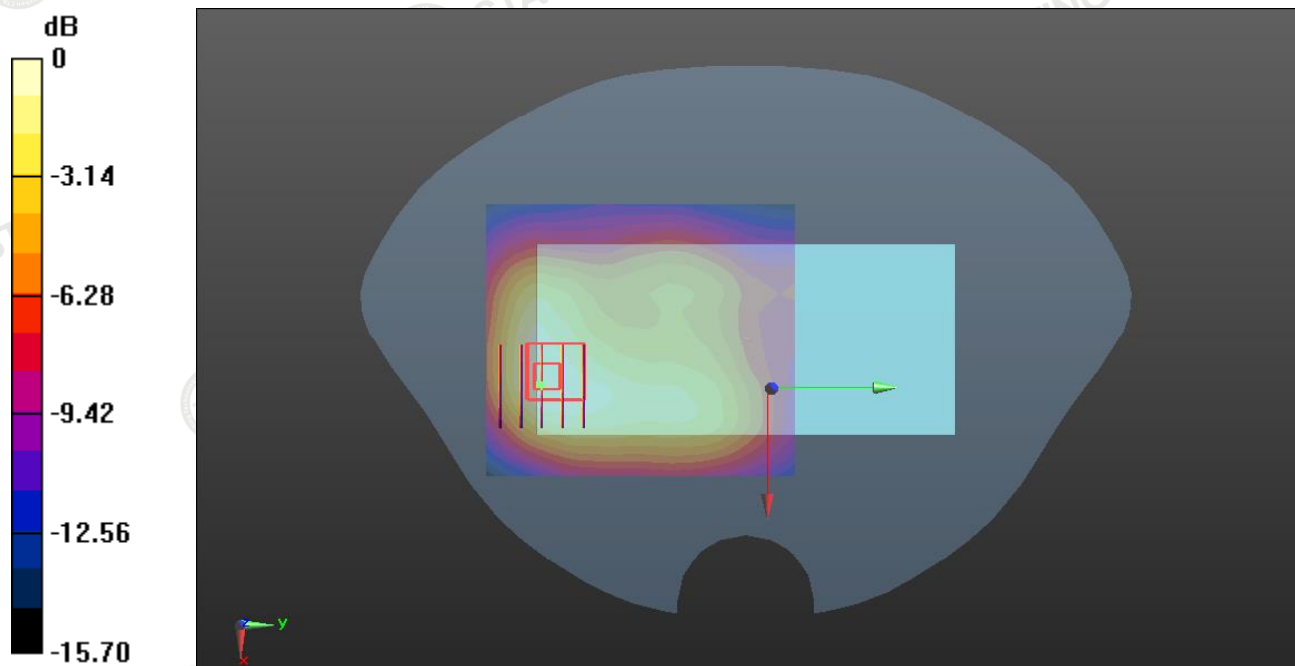

0 dB = 0.507 W/kg

#17.

Date: 05/24/2024

WCDMA IV_RMC 12.2Kbps_ Back_10mm_Ch1412

Communication System: UID 0, Generic WCDMA (0); Frequency: 1732.6 MHz; Duty Cycle: 1:1

Medium parameters used (interpolated): $f = 1732.6$ MHz; $\sigma = 1.393$ S/m; $\epsilon_r = 39.948$; $\rho = 1000$ kg/m³

Phantom section: Flat Section

DASY5 Configuration:

- Probe: EX3DV4 - SN7380; ConvF(8.35, 8.35, 8.35); Calibrated: June 21, 2023
- Sensor-Surface: 2mm (Mechanical Surface Detection)
- Electronics: DAE3 Sn428; Calibrated: Aug.30,2023;
- Phantom: Twin-SAM V8.0 ; Type: QD 000 P41 AA; Serial: 1974;
- DASY52 52.10.2(1495); SEMCAD X 14.6.12(7450)

Area Scan (71x81x1): Interpolated grid: dx=1.500 mm, dy=1.500 mm

Maximum value of SAR (interpolated) = 0.551 W/Kg

Zoom Scan (5x5x7)/Cube 0: Measurement grid: dx=8mm, dy=8mm, dz=5mm

Reference Value = 7.556 V/m; Power Drift = -0.03 dB

Peak SAR (extrapolated) = 0.735 W/kg

SAR(1 g) = 0.425 W/Kg; SAR(10 g) = 0.211 W/Kg

Maximum value of SAR (measured) = 0.585 W/Kg

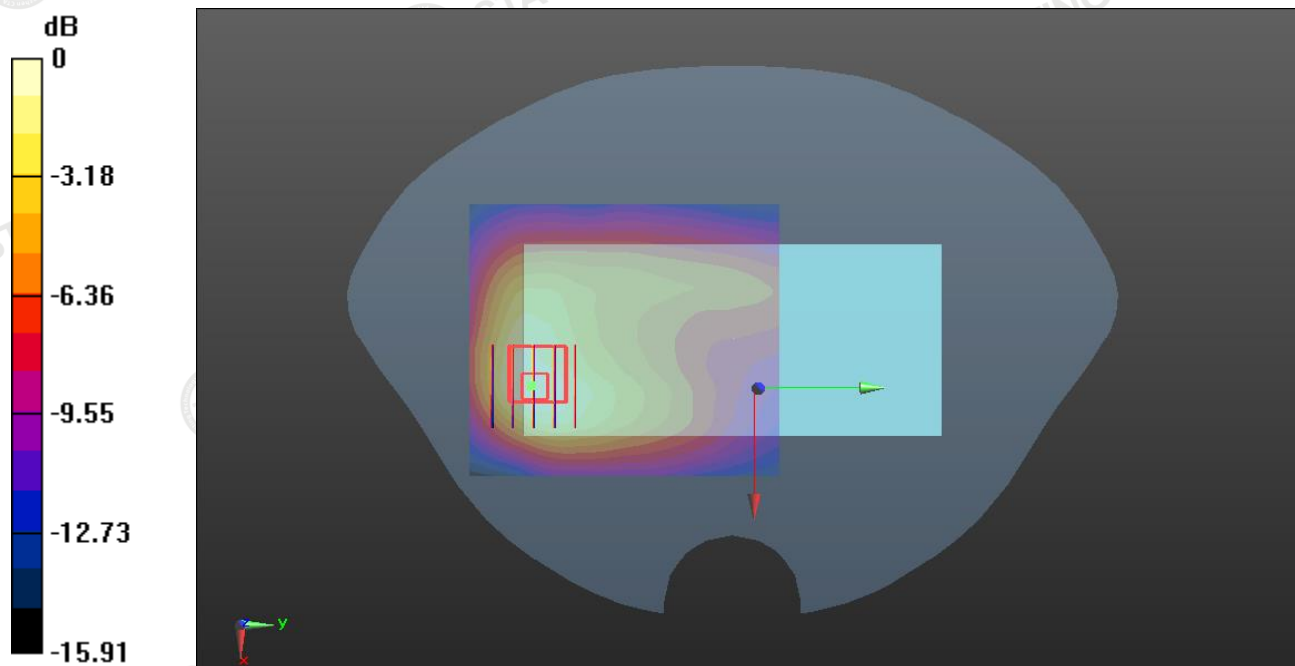

0 dB = 0.585 W/kg

#18.

Date: 05/23/2024

WCDMA V_RMC 12.2Kbps_ Back_10mm_Ch4233

Communication System: UID 0, Generic WCDMA (0); Frequency: 846.6 MHz; Duty Cycle: 1:1
 Medium parameters used (interpolated): $f = 846.6$ MHz; $\sigma = 0.887$ S/m; $\epsilon_r = 42.247$; $\rho = 1000$ kg/m³
 Phantom section: Flat Section

DASY5 Configuration:

- Probe: EX3DV4 - SN7380; ConvF(9.62, 9.62, 9.62); Calibrated: June 21, 2023
- Sensor-Surface: 2mm (Mechanical Surface Detection)
- Electronics: DAE3 Sn428; Calibrated: Aug.30,2023;
- Phantom: Twin-SAM V8.0 ; Type: QD 000 P41 AA; Serial: 1974;
- DASY52 52.10.2(1495); SEMCAD X 14.6.12(7450)

Area Scan (71x121x1): Interpolated grid: dx=1.500 mm, dy=1.500 mm
 Maximum value of SAR (interpolated) = 0.524 W/Kg

Zoom Scan (5x5x7)/Cube 0: Measurement grid: dx=8mm, dy=8mm, dz=5mm
 Reference Value = 19.64 V/m; Power Drift = -0.06 dB
 Peak SAR (extrapolated) = 0.675 W/Kg

SAR(1 g) = 0.305 W/Kg; SAR(10 g) = 0.188 W/Kg
 Maximum value of SAR (measured) = 0.511 W/Kg

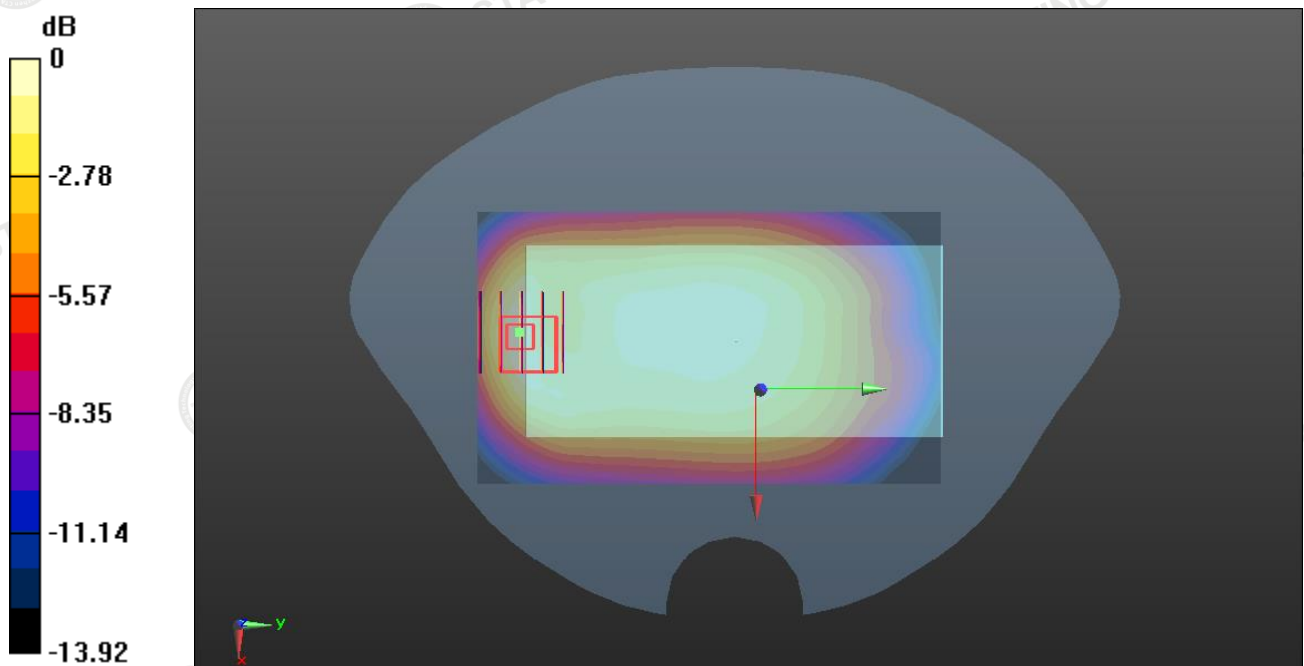

0 dB = 0.511 W/kg

#19.

Date: 05/29/2024

LTE Band 7_20M_QPSK_1RB#99_Back_10mm_Ch21100

Communication System: UID 0, Generic LTE (0); Frequency: 2535.0 MHz; Duty Cycle: 1:1

Medium parameters used (interpolated): $f = 2535.0$ MHz; $\sigma = 1.961$ S/m; $\epsilon_r = 39.023$; $\rho = 1000$ kg/m³

Phantom section: Flat Section

DASY5 Configuration:

- Probe: EX3DV4 - SN7380; ConvF(7.35, 7.35, 7.35); Calibrated: June 21, 2023
- Sensor-Surface: 2mm (Mechanical Surface Detection)
- Electronics: DAE3 Sn428; Calibrated: Aug.30,2023;
- Phantom: Twin-SAM V8.0 ; Type: QD 000 P41 AA; Serial: 1974;
- DASY52 52.10.2(1495); SEMCAD X 14.6.12(7450)

Area Scan (91x101x1): Interpolated grid: dx=1.200 mm, dy=1.200 mm

Maximum value of SAR (interpolated) = 1.05 W/Kg

Zoom Scan (7x7x7)/Cube 0: Measurement grid: dx=5mm, dy=5mm, dz=5mm

Reference Value = 8.078 V/m; Power Drift = -0.07 dB

Peak SAR (extrapolated) = 1.35 W/kg

SAR(1 g) = 0.441 W/kg; SAR(10 g) = 0.225 W/kg

Maximum value of SAR (measured) = 1.15 W/Kg

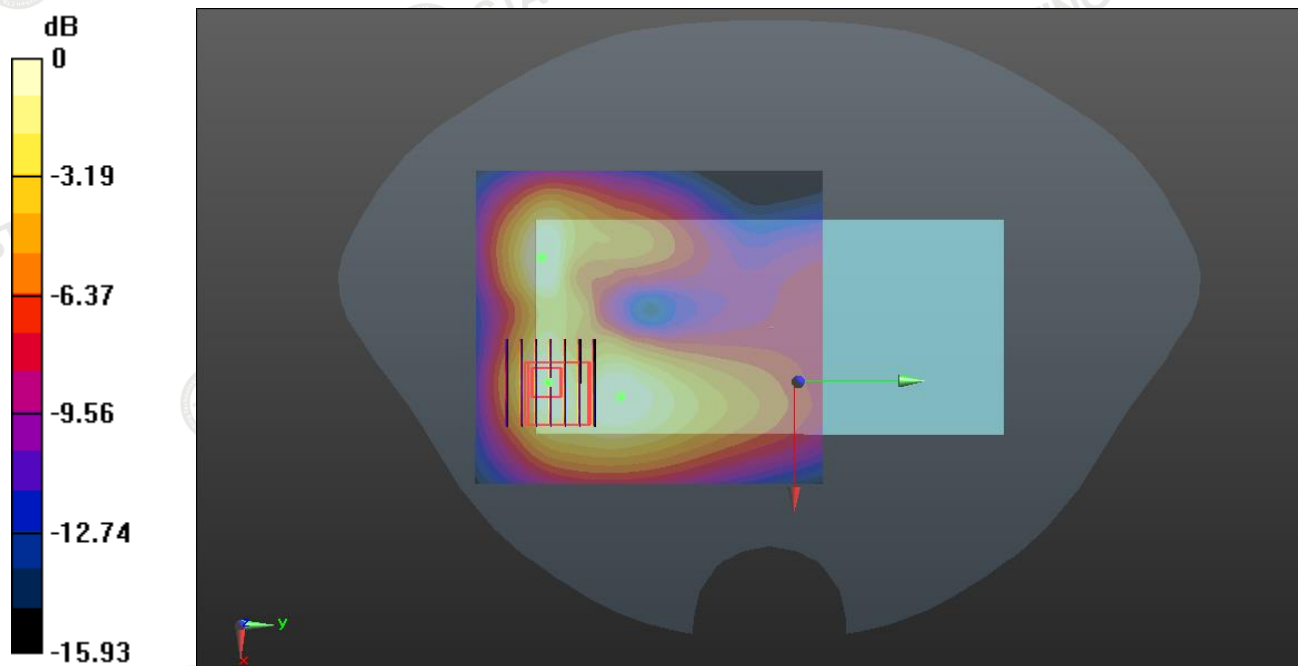

0 dB = 1.15 W/kg

#20.

Date: 05/22/2024

LTE Band 12_10M_QPSK_1RB#25_Back_0mm_Ch23130

Communication System: UID 0, LTE (0); Frequency: 711.0 MHz; Duty Cycle: 1:1

Medium parameters used (interpolated): $f = 711.0$ MHz; $\sigma = 0.876$ S/m; $\epsilon_r = 42.487$; $\rho = 1000$ kg/m³

Phantom section: Right Section

DASY5 Configuration:

- Probe: EX3DV4 - SN7380; ConvF(10.02, 10.02, 10.02); Calibrated: June 21, 2023
- Sensor-Surface: 2mm (Mechanical Surface Detection)
- Electronics: DAE3 Sn428; Calibrated: Aug.30,2023;
- Phantom: SAM 1; Type: SAM;
- Measurement SW: DASY52, Version 52.8 (2); SEMCAD X Version 14.6.10 (7164)

Area Scan (71x121x1): Interpolated grid: dx=1.500 mm, dy=1.500 mm

Maximum value of SAR (interpolated) = 0.579 W/kg

Zoom Scan (5x5x7)/Cube 0: Measurement grid: dx=8mm, dy=8mm, dz=5mm

Reference Value = 19.54 V/m; Power Drift = -0.08 dB

Peak SAR (extrapolated) = 0.993 W/kg

SAR(1 g) = 0.405 W/kg; SAR(10 g) = 0.339 W/kg

Maximum value of SAR (measured) = 0.754 W/Kg

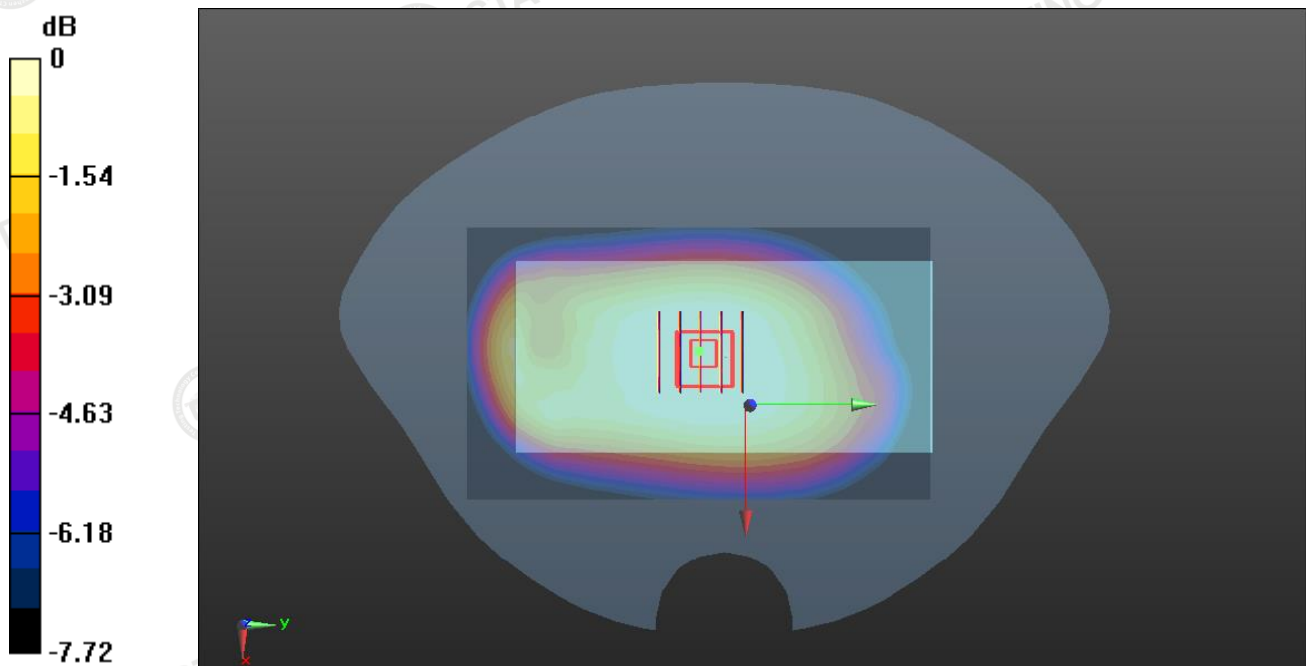

0 dB = 0.754 W/kg

#21.

Date: 05/28/2024

LTE Band 25_20M_QPSK_1RB#99_Back_10mm_Ch26140

Communication System: UID 0, Generic LTE (0); Frequency: 1860.0 MHz; Duty Cycle: 1:1

Medium parameters used (interpolated): $f = 1860.0$ MHz; $\sigma = 1.391$ S/m; $\epsilon_r = 39.392$; $\rho = 1000$ kg/m³

Phantom section: Flat Section

DASY5 Configuration:

- Probe: EX3DV4 - SN7380; ConvF(8.05, 8.05, 8.05); Calibrated: June 21, 2023
- Sensor-Surface: 2mm (Mechanical Surface Detection)
- Electronics: DAE3 Sn428; Calibrated: Aug.30,2023;
- Phantom: Twin-SAM V8.0 ; Type: QD 000 P41 AA; Serial: 1974;
- DASY52 52.10.2(1495); SEMCAD X 14.6.12(7450)

Area Scan (71x81x1): Interpolated grid: dx=1.500 mm, dy=1.500 mm

Maximum value of SAR (interpolated) = 0.836 W/Kg

Zoom Scan (5x5x7)/Cube 0: Measurement grid: dx=8mm, dy=8mm, dz=5mm

Reference Value = 8.965 V/m; Power Drift = 0.05 dB

Peak SAR (extrapolated) = 0.987 W/kg

SAR(1 g) = 0.592 W/Kg; SAR(10 g) = 0.347 W/Kg

Maximum value of SAR (measured) = 0.765 W/Kg

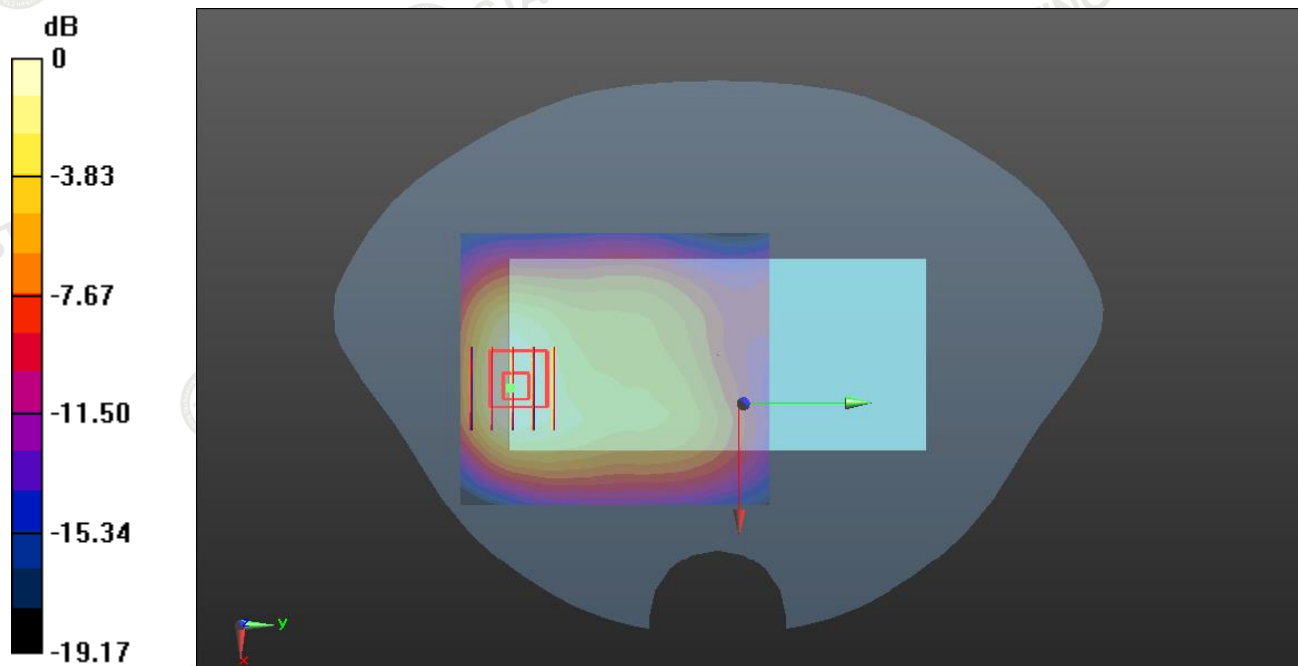

0 dB = 0.765 W/kg

#22.

Date: 05/23/2024

LTE Band 26 lower band_10M_QPSK_1RB#0_Back_10mm_Ch26740

Communication System: UID 0, Generic LTE (0); Frequency: 819.0 MHz; Duty Cycle: 1:1

Medium parameters used (interpolated): $f = 819.0$ MHz; $\sigma = 0.886$ S/m; $\epsilon_r = 41.685$; $\rho = 1000$ kg/m³

Phantom section: Flat Section

DASY5 Configuration:

- Probe: EX3DV4 - SN7380; ConvF(9.62, 9.62, 9.62); Calibrated: June 21, 2023
- Sensor-Surface: 2mm (Mechanical Surface Detection)
- Electronics: DAE3 Sn428; Calibrated: Aug.30,2023;
- Phantom: Twin-SAM V8.0 ; Type: QD 000 P41 AA; Serial: 1974;
- DASY52 52.10.2(1495); SEMCAD X 14.6.12(7450)

Area Scan (71x121x1): Interpolated grid: dx=1.500 mm, dy=1.500 mm

Maximum value of SAR (interpolated) = 0.654 W/Kg

Zoom Scan (5x5x7)/Cube 0: Measurement grid: dx=8mm, dy=8mm, dz=5mm

Reference Value = 15.98 V/m; Power Drift = 0.11 dB

Peak SAR (extrapolated) = 1.265 W/kg

SAR(1 g) = 0.487 W/Kg; SAR(10 g) = 0.325 W/Kg

Maximum value of SAR (measured) = 0.707 W/Kg

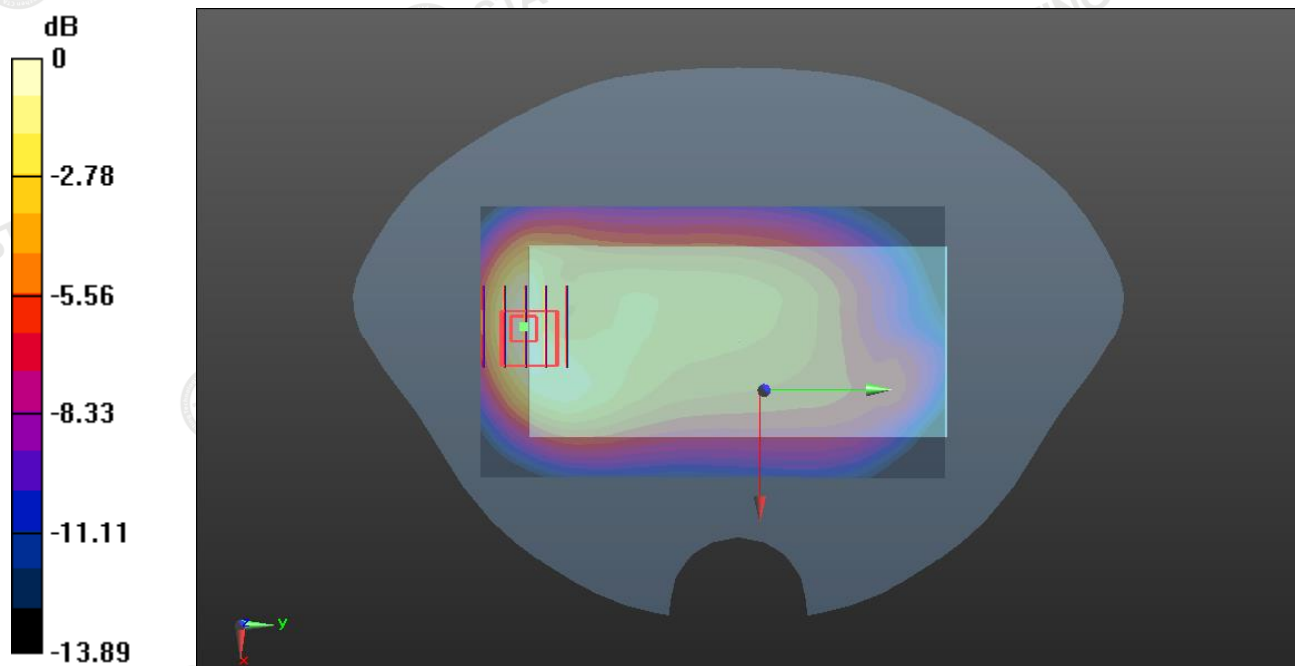

0 dB = 0.707 W/kg

#23.

Date: 05/23/2024

LTE Band 26 Higher band_15M_QPSK_1RB#37_Back_10mm_Ch26865

Communication System: UID 0, Generic LTE (0); Frequency: 831.5 MHz; Duty Cycle: 1:1

Medium parameters used (interpolated): $f = 831.5$ MHz; $\sigma = 0.908$ S/m; $\epsilon_r = 41.728$; $\rho = 1000$ kg/m³

Phantom section: Flat Section

DASY5 Configuration:

- Probe: EX3DV4 - SN7380; ConvF(9.62, 9.62, 9.62); Calibrated: June 21, 2023
- Sensor-Surface: 2mm (Mechanical Surface Detection)
- Electronics: DAE3 Sn428; Calibrated: Aug.30,2023;
- Phantom: Twin-SAM V8.0 ; Type: QD 000 P41 AA; Serial: 1974;
- DASY52 52.10.2(1495); SEMCAD X 14.6.12(7450)

Area Scan (61x131x1): Interpolated grid: dx=1.500 mm, dy=1.500 mm

Maximum value of SAR (interpolated) =0.618 W/Kg

Zoom Scan (5x5x7)/Cube 0: Measurement grid: dx=8mm, dy=8mm, dz=5mm

Reference Value = 15.55 V/m; Power Drift = 0.11 dB

Peak SAR (extrapolated) = 0.991 W/kg

SAR(1 g) = 0.484 W/Kg; SAR(10 g) = 0.319 W/Kg

Maximum value of SAR (measured) = 0.655 W/Kg

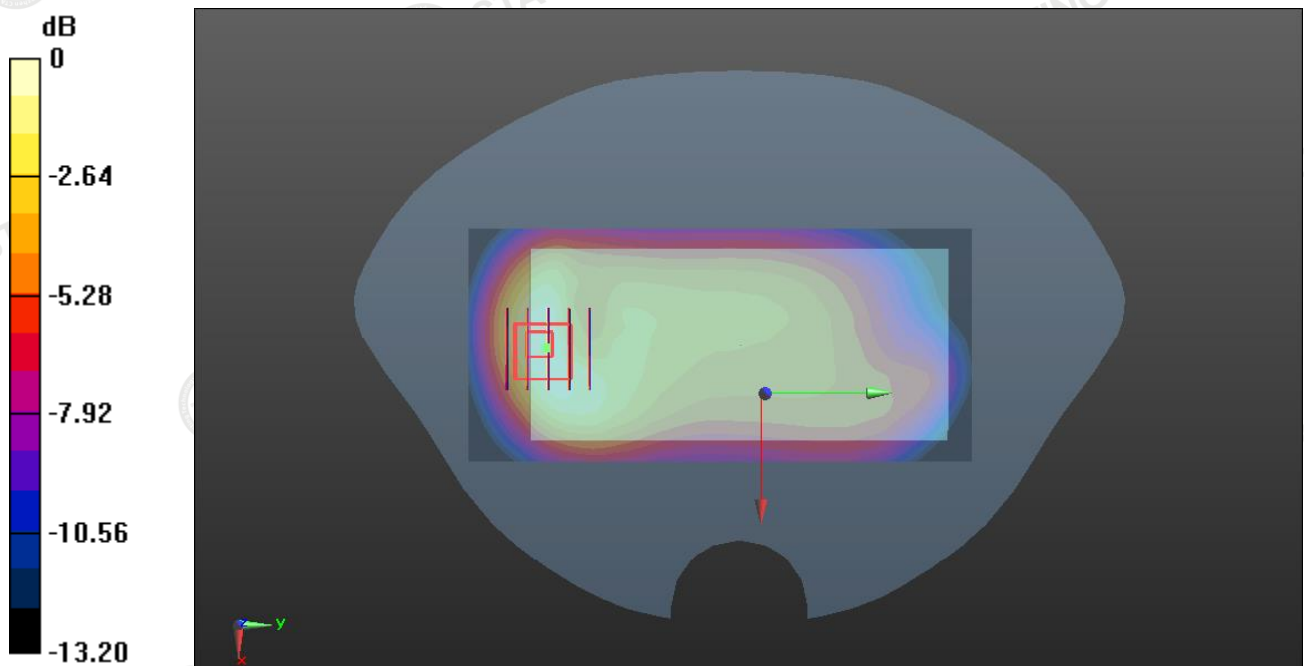

0 dB = 0.655 W/kg

#24.

Date: 05/24/2024

LTE Band 66_20M_QPSK_1RB#0_Back_10mm_Ch132322

Communication System: UID 0, Generic LTE (0); Frequency: 1745.0 MHz; Duty Cycle: 1:1

Medium parameters used (interpolated): $f = 1745.0$ MHz; $\sigma = 1.366$ S/m; $\epsilon_r = 40.112$; $\rho = 1000$ kg/m³

Phantom section: Flat Section

DASY5 Configuration:

- Probe: EX3DV4 - SN7380; ConvF(8.35, 8.35, 8.35); Calibrated: June 21, 2023
- Sensor-Surface: 2mm (Mechanical Surface Detection)
- Electronics: DAE3 Sn428; Calibrated: Aug.30,2023;
- Phantom: Twin-SAM V8.0 ; Type: QD 000 P41 AA; Serial: 1974;
- DASY52 52.10.2(1495); SEMCAD X 14.6.12(7450)

Area Scan (71x81x1): Interpolated grid: dx=1.500 mm, dy=1.500 mm

Maximum value of SAR (interpolated) = 0.890 W/Kg

Zoom Scan (5x5x7)/Cube 0: Measurement grid: dx=8mm, dy=8mm, dz=5mm

Reference Value = 11.460 V/m; Power Drift = -0.09 dB

Peak SAR (extrapolated) = 1.05 W/kg

SAR(1 g) = 0.605 W/Kg; SAR(10 g) = 0.385 W/Kg

Maximum value of SAR (measured) = 0.905 W/Kg

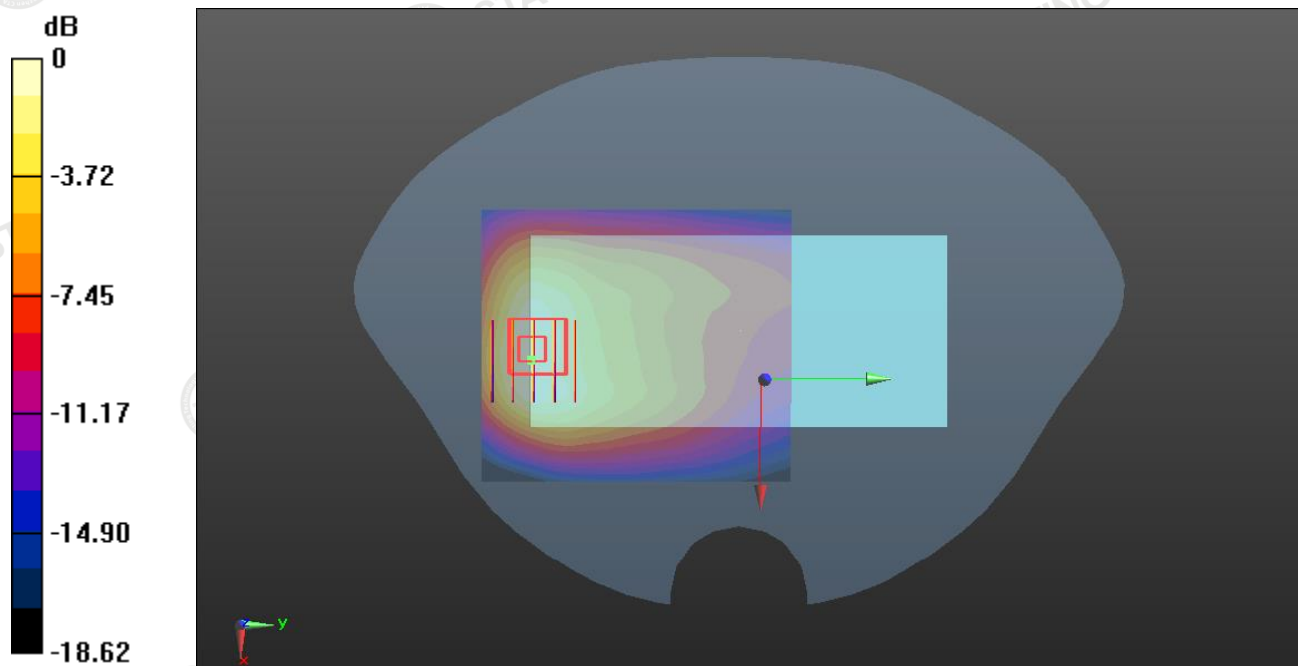

0 dB = 0.905 W/kg

#25.

Date: 05/29/2024

LTE Band 41_20M_QPSK_1RB#49_Bottom_10mm_Ch41140

Communication System: UID 0, Generic LTE (0); Frequency: 2645.0 MHz; Duty Cycle: 1:1

Medium parameters used (interpolated): $f = 2645.0$ MHz; $\sigma = 2.013$ S/m; $\epsilon_r = 39.335$; $\rho = 1000$ kg/m³

Phantom section: Flat Section

DASY5 Configuration:

- Probe: EX3DV4 - SN7380; ConvF(9.62, 9.62, 9.62); Calibrated: June 21, 2023
- Sensor-Surface: 2mm (Mechanical Surface Detection)
- Electronics: DAE3 Sn428; Calibrated: Aug.30,2023;
- Phantom: Twin-SAM V8.0 ; Type: QD 000 P41 AA; Serial: 1974;
- DASY52 52.10.2(1495); SEMCAD X 14.6.12(7450)

Area Scan (51x81x1): Interpolated grid: dx=1.200 mm, dy=1.200 mm

Maximum value of SAR (interpolated) =1.01 W/Kg

Zoom Scan (7x7x7)/Cube 0: Measurement grid: dx=5mm, dy=5mm, dz=5mm

Reference Value = 9.621 V/m; Power Drift = 0.05 dB

Peak SAR (extrapolated) = 1.29 W/kg

SAR(1 g) = 0.671 W/Kg; SAR(10 g) = 0.313 W/Kg

Maximum value of SAR (measured) = 1.01 W/Kg

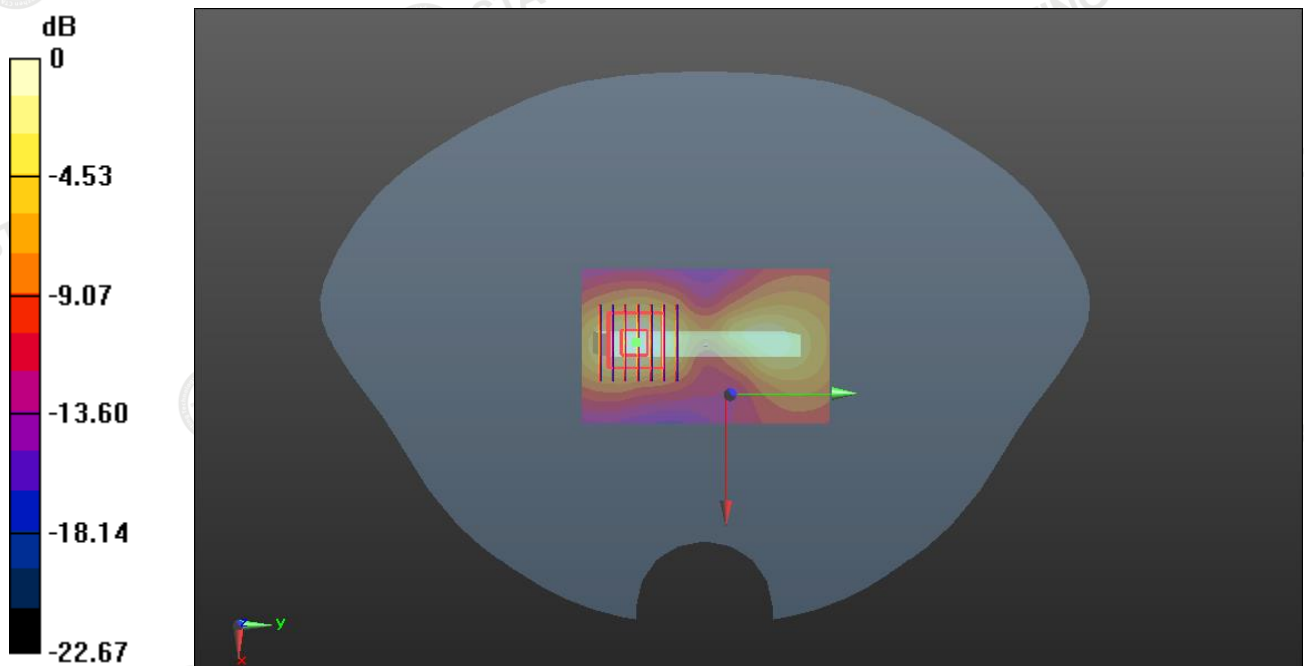

0 dB = 1.01 W/kg

#26.

Date: 05/30/2024

WLAN2.4GHz_802.11b 1Mbps_Back_10mm_Ch11

Communication System: UID 0, Generic WIFI(0); Frequency: 2462 MHz; Duty Cycle: 1:1

Medium parameters used (interpolated): $f = 2462$ MHz; $\sigma = 1.715$ S/m; $\epsilon_r = 40.207$; $\rho = 1000$ kg/m³

Phantom section: Flat Section

DASY5 Configuration:

- Probe: EX3DV4 - SN7380; ConvF(7.50, 7.50, 7.50); Calibrated: June 21, 2023
- Sensor-Surface: 2mm (Mechanical Surface Detection)
- Electronics: DAE3 Sn428; Calibrated: Aug.30,2023;
- Phantom: Twin-SAM V8.0 ; Type: QD 000 P41 AA; Serial: 1974;
- DASY52 52.10.2(1495); SEMCAD X 14.6.12(7450)

Area Scan (81x91x1): Interpolated grid: dx=1.200 mm, dy=1.200 mm

Maximum value of SAR (interpolated) = 0.258 W/Kg

Zoom Scan (7x7x7)/Cube 0: Measurement grid: dx=5mm, dy=5mm, dz=5mm

Reference Value = 5.344 V/m; Power Drift = -0.05 dB

Peak SAR (extrapolated) = 0.356 W/kg

SAR(1 g) = 0.191 W/Kg; SAR(10 g) = 0.112 W/Kg

Maximum value of SAR (measured) = 0.262 W/Kg

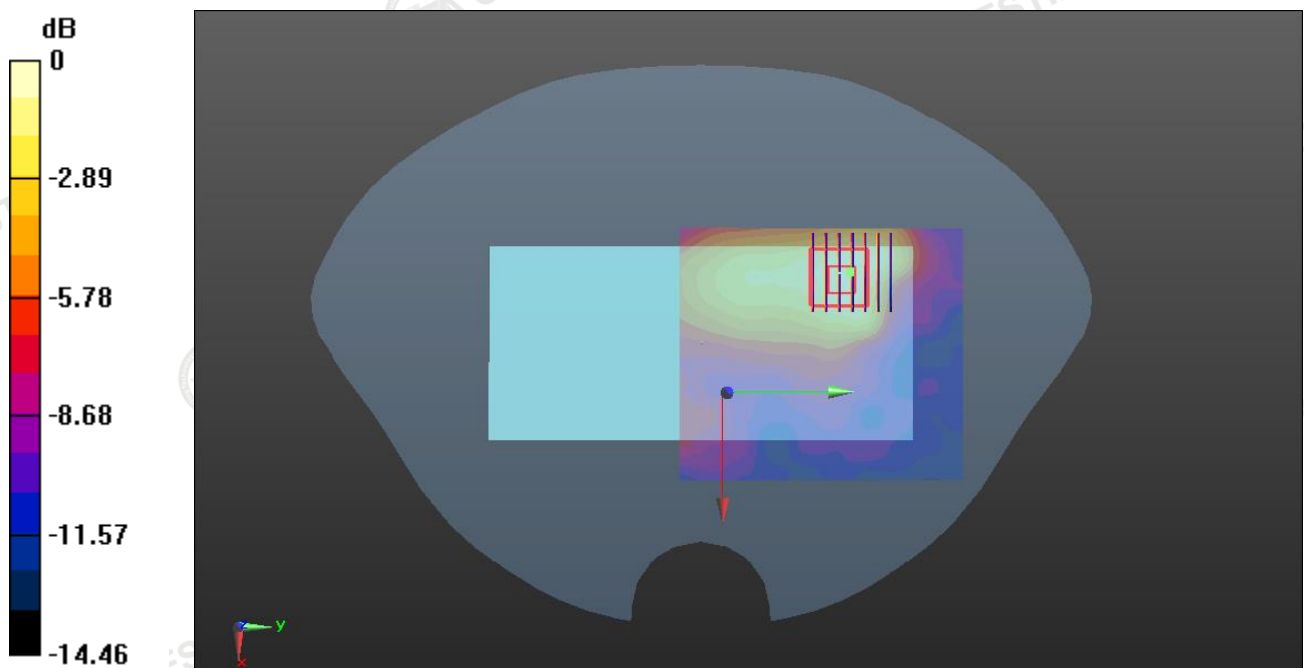

0 dB = 0.262 W/kg

Appendix D. DASY System Calibration Certificate



TTL
In Collaboration with
s p e a g
CALIBRATION LABORATORY

Addr: No.52 HuaYuanBei Road, Haidian District, Beijing, 100191, China
Tel: +86-10-62304633-2117
E-mail: cmf@caict.ac.cn http://www.caict.ac.cn



中国认可
国际互认
校准
CALIBRATION
CNAS L0570



CAICT

Client **ruixiang** Certificate No: **J23Z60276**

CALIBRATION CERTIFICATE

Object: EX3DV4 - SN : 7380

Calibration Procedure(s): FF-Z11-004-02
Calibration Procedures for Dosimetric E-field Probes



Calibration date: June 21, 2023

This calibration Certificate documents the traceability to national standards, which realize the physical units of measurements(SI). The measurements and the uncertainties with confidence probability are given on the following pages and are part of the certificate.

All calibrations have been conducted in the closed laboratory facility: environment temperature(22±3)°C and humidity<70%.

Calibration Equipment used (M&TE critical for calibration)

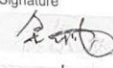
Primary Standards	ID #	Cal Date(Calibrated by, Certificate No.)	Scheduled Calibration
Power Meter NRP2	101919	12-Jun-23(CTTL, No.J23X05435)	Jun-24
Power sensor NRP-Z91	101547	12-Jun-23(CTTL, No.J23X05435)	Jun-24
Power sensor NRP-Z91	101548	12-Jun-23(CTTL, No.J23X05435)	Jun-24
Reference 10dBAAttenuator	18N50W-10dB	19-Jan-23(CTTL, No.J23X00212)	Jan-25
Reference 20dBAAttenuator	18N50W-20dB	19-Jan-23(CTTL, No.J23X00211)	Jan-25
Reference Probe EX3DV4	SN 7517	27-Jan-23(SPEAG, No.EX-7517_Jan23)	Jan-24
DAE4	SN 1555	25-Aug-22(SPEAG, No.DAE4-1555_Aug22)	Aug-23
Secondary Standards	ID #	Cal Date(Calibrated by, Certificate No.)	Scheduled Calibration
SignalGenerator MG3700A	6201052605	12-Jun-23(CTTL, No.J23X05434)	Jun-24
Network Analyzer E5071C	MY46110673	10-Jan-23(CTTL, No.J23X00104)	Jan-24
Reference 10dBAAttenuator	BT0520	11-May-23(CTTL, No.J23X04061)	May-25
Reference 20dBAAttenuator	BT0267	11-May-23(CTTL, No.J23X04062)	May-25
OCF DAK-3.5	SN 1040	18-Jan-23(SPEAG, No.OCP-DAK3.5-1040_Jan23)	Jan-24

	Name	Function	Signature
Calibrated by:	Yu Zongying	SAR Test Engineer	
Reviewed by:	Lin Hao	SAR Test Engineer	
Approved by:	Qi Dianyuan	SAR Project Leader	

Issued: June 27, 2023

This calibration certificate shall not be reproduced except in full without written approval of the laboratory.

Certificate No: J23Z60276
Page 1 of 9



Add: No.52 HuaYuanBei Road, Haidian District, Beijing, 100191, China
Tel: +86-10-62304633-2117
E-mail: emf@caict.ac.cn <http://www.caict.ac.cn>

Glossary:

TSL	tissue simulating liquid
NORM _{x,y,z}	sensitivity in free space
ConvF	sensitivity in TSL / NORM _{x,y,z}
DCP	diode compression point
CF	crest factor (1/duty_cycle) of the RF signal
A,B,C,D	modulation dependent linearization parameters
Polarization Φ	Φ rotation around probe axis
Polarization θ	θ rotation around an axis that is in the plane normal to probe axis (at measurement center), $\theta=0$ is normal to probe axis
Connector Angle	information used in DASY system to align probe sensor X to the robot coordinate system

Calibration is Performed According to the Following Standards:

- IEEE Std 1528-2013, "IEEE Recommended Practice for Determining the Peak Spatial-Averaged Specific Absorption Rate (SAR) in the Human Head from Wireless Communications Devices: Measurement Techniques", June 2013
- IEC 62209-1, "Measurement procedure for the assessment of Specific Absorption Rate (SAR) from hand-held and body-mounted devices used next to the ear (frequency range of 300 MHz to 6 GHz)", July 2016
- IEC 62209-2, "Procedure to determine the Specific Absorption Rate (SAR) for wireless communication devices used in close proximity to the human body (frequency range of 30 MHz to 6 GHz)", March 2010
- KDB 865664, "SAR Measurement Requirements for 100 MHz to 6 GHz"

Methods Applied and Interpretation of Parameters:

- NORM_{x,y,z}:** Assessed for E-field polarization $\theta=0$ ($f \leq 900\text{MHz}$ in TEM-cell; $f > 1800\text{MHz}$: waveguide). NORM_{x,y,z} are only intermediate values, i.e., the uncertainties of NORM_{x,y,z} does not effect the E^2 -field uncertainty inside TSL (see below ConvF).
- NORM(f)_{x,y,z} = NORM_{x,y,z} * frequency_response** (see Frequency Response Chart). This linearization is implemented in DASY4 software versions later than 4.2. The uncertainty of the frequency response is included in the stated uncertainty of ConvF.
- DCP_{x,y,z}:** DCP are numerical linearization parameters assessed based on the data of power sweep (no uncertainty required). DCP does not depend on frequency nor media.
- PAR:** PAR is the Peak to Average Ratio that is not calibrated but determined based on the signal characteristics.
- A_{x,y,z}; B_{x,y,z}; C_{x,y,z}; VR_{x,y,z}; A,B,C** are numerical linearization parameters assessed based on the data of power sweep for specific modulation signal. The parameters do not depend on frequency nor media. VR is the maximum calibration range expressed in RMS voltage across the diode.
- ConvF and Boundary Effect Parameters:** Assessed in flat phantom using E-field (or Temperature Transfer Standard for $f \leq 800\text{MHz}$) and inside waveguide using analytical field distributions based on power measurements for $f > 800\text{MHz}$. The same setups are used for assessment of the parameters applied for boundary compensation (alpha, depth) of which typical uncertainty valued are given. These parameters are used in DASY4 software to improve probe accuracy close to the boundary. The sensitivity in TSL corresponds to NORM_{x,y,z} * ConvF whereby the uncertainty corresponds to that given for ConvF. A frequency dependent ConvF is used in DASY version 4.4 and higher which allows extending the validity from $\pm 50\text{MHz}$ to $\pm 100\text{MHz}$.
- Spherical isotropy (3D deviation from isotropy):** in a field of low gradients realized using a flat phantom exposed by a patch antenna.
- Sensor Offset:** The sensor offset corresponds to the offset of virtual measurement center from the probe tip (on probe axis). No tolerance required.
- Connector Angle:** The angle is assessed using the information gained by determining the NORM_x (no uncertainty required).



In Collaboration with
s p e a g
 CALIBRATION LABORATORY



Add: No.52 HuaYuanBei Road, Haidian District, Beijing, 100191, China
 Tel: +86-10-62304633-2117
 E-mail: emf@caict.ac.cn http://www.caict.ac.cn

DASY/EASY – Parameters of Probe: EX3DV4 – SN:7380

Basic Calibration Parameters

	Sensor X	Sensor Y	Sensor Z	Unc (k=2)
Norm($\mu\text{V}/(\text{V}/\text{m})^2$) ^A	0.44	0.35	0.41	$\pm 10.0\%$
DCP(mV) ^B	100.5	101.6	100.6	

Modulation Calibration Parameters

UID	Communication System Name		A dB	B dB μV	C	D dB	VR mV	Unc ^E (k=2)
0	CW	X	0.0	0.0	1.0	0.00	161.9	$\pm 2.2\%$
		Y	0.0	0.0	1.0		139.0	
		Z	0.0	0.0	1.0		149.3	

The reported uncertainty of measurement is stated as the standard uncertainty of Measurement multiplied by the coverage factor $k=2$, which for a normal distribution Corresponds to a coverage probability of approximately 95%.

^A The uncertainties of Norm X, Y, Z do not affect the E²-field uncertainty inside TSL (see Page 4).
^B Numerical linearization parameter: uncertainty not required.
^E Uncertainty is determined using the max. deviation from linear response applying rectangular distribution and is expressed for the square of the field value.