

FCC- TEST REPORT

Report Number : **68.950.23.0960.01** Date of Issue: **2023-12-12**

Model : **TA2C-CS8**

Product Type : **TABLET PC**

Applicant : **ODS Corporation**

Address : **2-5 Kanda suda cho, Chiyoda ku, Tokyo 101-0041, Japan**

Manufacturer : **ODS Corporation**

Address : **2-5 Kanda suda cho, Chiyoda ku, Tokyo 101-0041, Japan**

Test Result : **Positive** Negative

Total pages including Appendices : **48**

Any use for advertising purposes must be granted in writing. This technical report may only be quoted in full. This report is the result of a single examination of the object in question and is not generally applicable evaluation of the quality of other products in regular production. For further details, please see testing and certification regulation, chapter A-3.4.

1 Table of Contents

1	Table of Contents	2
2	Details about the Test Laboratory	3
3	Description of the Equipment Under Test	4
4	Summary of Test Standards	5
5	Summary of Test Results	6
6	General Remarks	7
7	Test Setups	8
8	Systems Test Configuration	10
9	Technical Requirement	11
9.1	Conducted Emission	11
9.2	Conducted Peak Output Power.....	14
9.3	Power Spectral Density	18
9.4	6 dB Bandwidth	21
9.5	99% Bandwidth	24
9.6	Spurious RF Conducted Emissions	27
9.7	Band Edge.....	33
9.8	Spurious Radiated Emissions for Transmitter.....	37
10	Test Equipment List.....	47
11	System Measurement Uncertainty	48

2 Details about the Test Laboratory

Details about the Test Laboratory

Test Site 1

Company name: TÜV SÜD Certification and Testing (China) Co., Ltd. Shenzhen Branch
Building 12 & 13, Zhiheng Wisdomland Business Park, Guankou Erlu,
Nantou, Nanshan District Shenzhen 518052 P.R. China

Telephone: 86 755 8828 6998

Fax: 86 755 8828 5299

FCC Registration No.: 514049

FCC Designation Number: CN5009

3 Description of the Equipment Under Test

Product:	TABLET PC
Model no.:	TA2C-CS8
FCC ID:	2BDQY-TA2C-CS8
Options and accessories:	Adapter Model: ICP30A-050-3000 Input: 100-240VAC 50/60Hz, 0.8A Output: 5VDC, 3A Manufacturer: Shenzhen Shi Ying Yuan Electronics Co., Ltd.
Rating:	3.8VDC, 6000mAh, (Supplied by Rechargeable Li-ion Battery) or 5VDC (Supplied by external adapter for Charging rechargeable battery)
RF Transmission Frequency:	2402MHz-2480MHz
No. of Operated Channel:	40
Modulation:	GFSK
Antenna Type:	Internal antenna
Antenna Gain:	4.7dBi
Description of the EUT:	EUT is a TABLET PC with Bluetooth Low Energy/Bluetooth BDR+EDR, 2.4GHz Wi-Fi and 5GHz Wi-Fi functions Only Bluetooth Low Energy included in this report.

NOTE:

1. The above EUT's information is declared by manufacturer. Please refer to the specifications or user's manual for more detailed description.

4 Summary of Test Standards

Test Standards	
FCC Part 15 Subpart C 10-1-2021 Edition	PART 15 - RADIO FREQUENCY DEVICES Subpart C - Intentional Radiators

All the test methods were according to KDB 558074 D01 15.247 Meas Guidance v05r02 Measurement Guidance and ANSI C63.10-2020.

5 Summary of Test Results

Technical Requirements			
FCC Part 15 Subpart C			
Test Condition		Test Result	Test Site
§15.207	Conducted emission AC power port	Pass	Site 1
§15.247 (b) (3)	Conducted output power	Pass	Site 1
§15.247(e)	Power spectral density	Pass	Site 1
§15.247(a)(2)	6dB bandwidth	Pass	Site 1
§15.247(a)(1)	20dB Occupied bandwidth	N/A	--
§15.247(a)(2)	99% Occupied Bandwidth	Pass	Site 1
§15.247(a)(1)	Carrier frequency separation	N/A	--
§15.247(a)(1)(iii)	Number of hopping frequencies	N/A	--
§15.247(a)(1)(iii)	Dwell Time	N/A	--
§15.247(d)	Spurious RF conducted emissions	Pass	Site 1
§15.247(d)	Band edge	Pass	Site 1
§15.247(d) & §15.209 & §15.205	Spurious radiated emissions for transmitter	Pass	Site 1
§15.203	Antenna requirement	Pass See note 2	--

Note 1: N/A=Not Applicable.

Note 2: The EUT use an Internal antenna, which gain is 4.7dBi. In accordance to §15.203, it is considered sufficiently to comply with the provisions of this section.

6 General Remarks

Remarks

This submittal(s) (test report) is intended for FCC ID: 2BDQY-TA2C-CS8, complies with Section 15.207, 15.209, 15.247 of the FCC Part 15, Subpart C rules.

SUMMARY:

All tests according to the regulations cited on page 5 were

■ - Performed

□ - **Not** Performed

The Equipment under Test

■ - **Fulfills** the general approval requirements.

□ - **Does not** fulfill the general approval requirements.

Sample Received Date: 2023-11-17

Testing Start Date: 2023-11-17

Testing End Date: 2023-12-05

- TÜV SÜD Certification and Testing (China) Co., Ltd. Shenzhen Branch

Reviewed by:



John Zhi
Section Manager

Prepared by:



Joe Gu
Project Engineer

Tested by:



Carry Cai
Test Engineer

7 Test Setups

7.1 AC Power Line Conducted Emission test setups

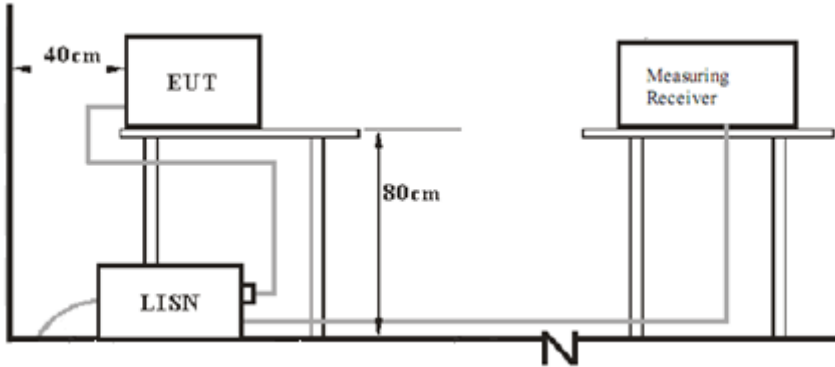

7.2 Radiated test setups

9kHz - 30MHz

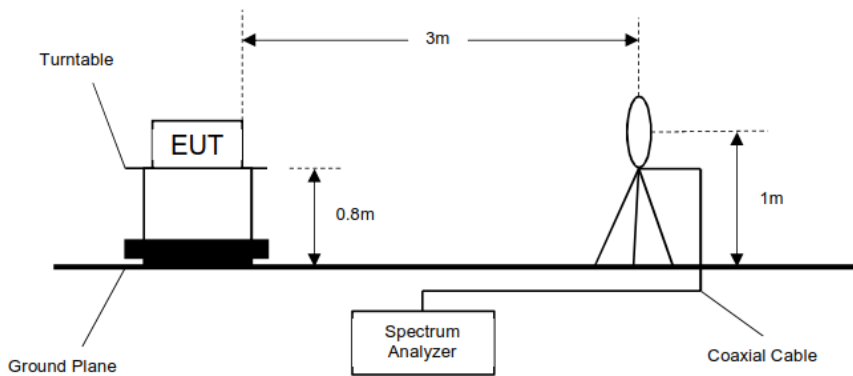

30MHz - 1GHz

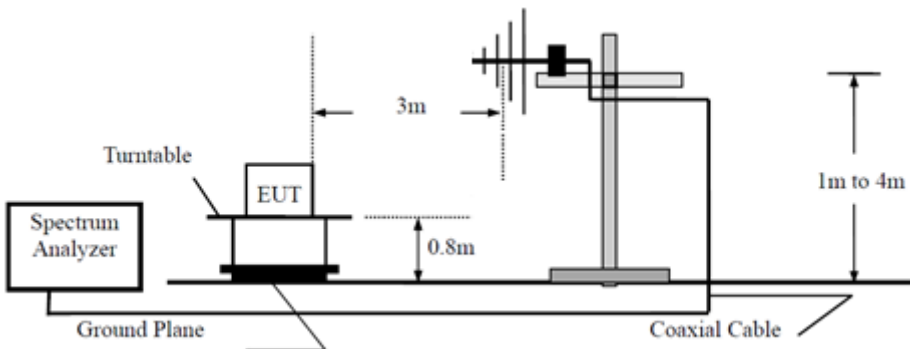

Above 1GHz

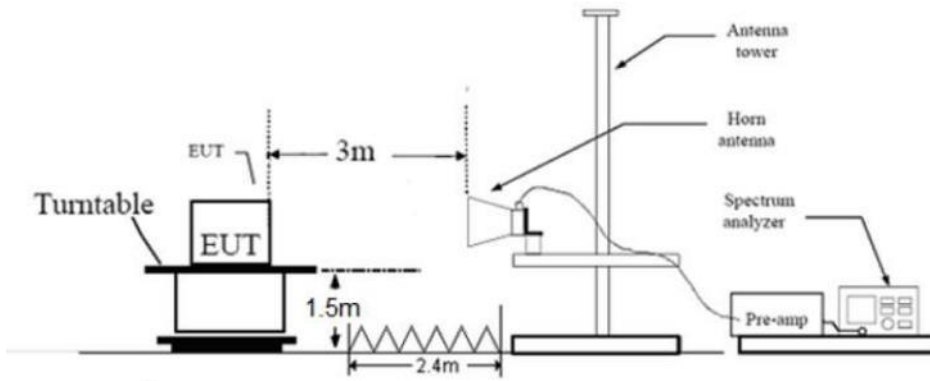

7.3 Conducted RF test setups

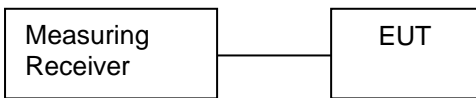

8 Systems Test Configuration

Auxiliary Equipment Used during Test:

Description	Manufacturer	Model NO.	S/N
Notebook	LENOVO	X220	429044C

The system was configured to non-hopping mode, testing channel 0, 19, 39.

9 Technical Requirement

9.1 Conducted Emission

Test Method

1. The EUT was placed 0.4 meter from the conducting wall of the shielding room was kept at least 80 centimeters from any other grounded conducting surface.
2. Connect EUT to the power mains through a line impedance stabilization network (LISN).
3. All the support units are connecting to the other LISN.
4. The LISN provides 50 ohm coupling impedance for the measuring instrument.
5. Both sides of AC line were checked for maximum conducted interference.
6. The frequency range from 150 kHz to 30 MHz was searched.
7. Set the test-receiver system to Peak Detect Function and specified bandwidth (IF Bandwidth = 9kHz) with Maximum Hold Mode. Then measurement is also conducted by Average Detector and Quasi-Peak Detector Function respectively.

Limit

According to §15.207, conducted emissions limit as below:

Frequency MHz	QP Limit dB μ V	AV Limit dB μ V
0.150-0.500	66-56*	56-46*
0.500-5	56	46
5-30	60	50

*Decreasing linearly with logarithm of the frequency

Conducted Emission

Product Type : TABLET PC
M/N : TA2C-CS8
Operating Condition : Transmit mode
Test Specification : Line
Comment : AC 120V/60Hz(External adapter)

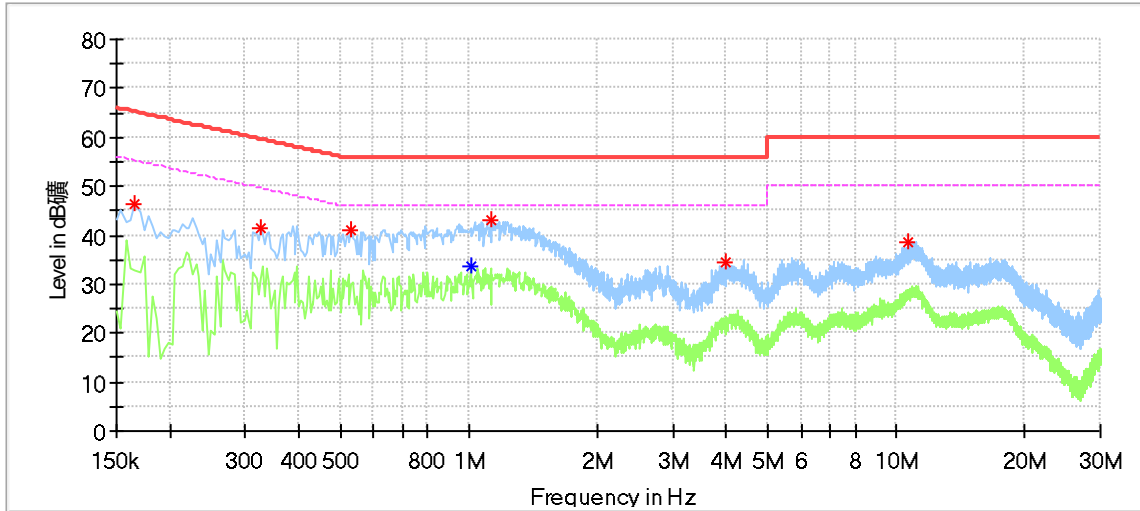

Frequency (MHz)	MaxPeak (dBμV)	Average (dBμV)	Limit (dBμV)	Margin (dB)	Line	Corr. (dB)
0.166000	46.27	---	65.16	18.89	L1	9.54
0.326000	41.58	---	59.55	17.97	L1	9.57
0.530000	41.00	---	56.00	15.00	L1	9.59
1.010000	---	33.61	46.00	12.39	L1	9.60
1.126000	42.91	---	56.00	13.09	L1	9.60
4.006000	34.58	---	56.00	21.42	L1	9.70
10.594000	38.63	---	60.00	21.37	L1	9.96

Remark:
Max Peak=Reading Level + Correction Factor
Correction Factor=Cable Loss + LISN Factor
(The Reading Level is recorded by software which is not shown in the sheet)

Conducted Emission

Product Type : TABLET PC
M/N : TA2C-CS8
Operating Condition : Transmit mode
Test Specification : Neutral
Comment : AC 120V/60Hz(External adapter)

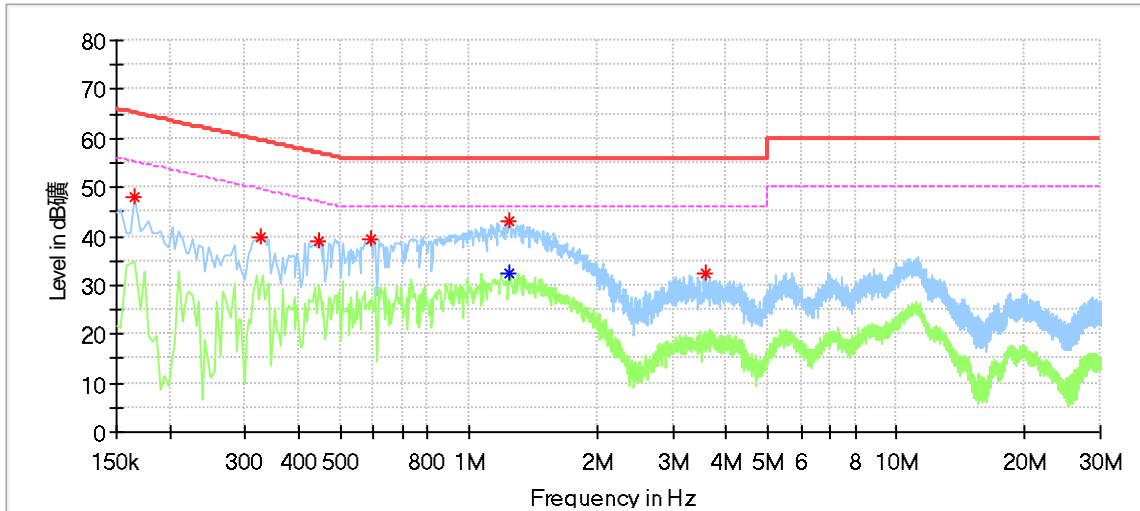

Frequency (MHz)	MaxPeak (dBµV)	Average (dBµV)	Limit (dBµV)	Margin (dB)	Line	Corr. (dB)
0.166000	48.03	---	65.16	17.13	N	9.57
0.326000	39.63	---	59.55	19.93	N	9.60
0.446000	38.97	---	56.95	17.98	N	9.61
0.590000	39.38	---	56.00	16.62	N	9.63
1.246000	---	32.55	46.00	13.45	N	9.63
1.250000	43.05	---	56.00	12.95	N	9.63
3.586000	32.27	---	56.00	23.73	N	9.71

Remark:

Max Peak=Reading Level + Correction Factor

Correction Factor=Cable Loss + LISN Factor

(The Reading Level is recorded by software which is not shown in the sheet)

9.2 Conducted Peak Output Power

Test Method

1. The EUT was placed on 0.8m height table, the RF output of EUT was connected to the spectrum analyzer by RF cable. The path loss was compensated to the results for each measurement.
2. Set to the maximum power setting and enable the EUT transmit continuously.
3. Use the following test receiver settings:
Span = approximately 5 times the 20dB bandwidth, centered on a hopping channel
RBW > the 20dB bandwidth of the emission being measured, VBW \geq RBW,
Sweep = auto, Detector function = peak, Trace = max hold
4. Allow the trace to stabilize. Use the marker-to-peak function to set the marker to the peak of the emission. The indicated level is the peak output power and record the results in the test report.
5. Repeat above procedures until all frequencies measured were complete.

Limits

According to §15.247 (b) (3), conducted output power limit as below:

Frequency Range MHz	Limit W	Limit dBm
2400-2483.5	≤ 1	≤ 30

Conducted Peak Output Power

Frequency MHz	Mode	Conducted Peak Output Power dBm	Result
Bottom channel 2402MHz	LE 1M	8.65	Pass
Middle channel 2440MHz	LE 1M	8.91	Pass
Top channel 2480MHz	LE 1M	8.50	Pass
Bottom channel 2402MHz	LE 2M	8.80	Pass
Middle channel 2440MHz	LE 2M	8.95	Pass
Top channel 2480MHz	LE 2M	8.57	Pass

Test Graphs:

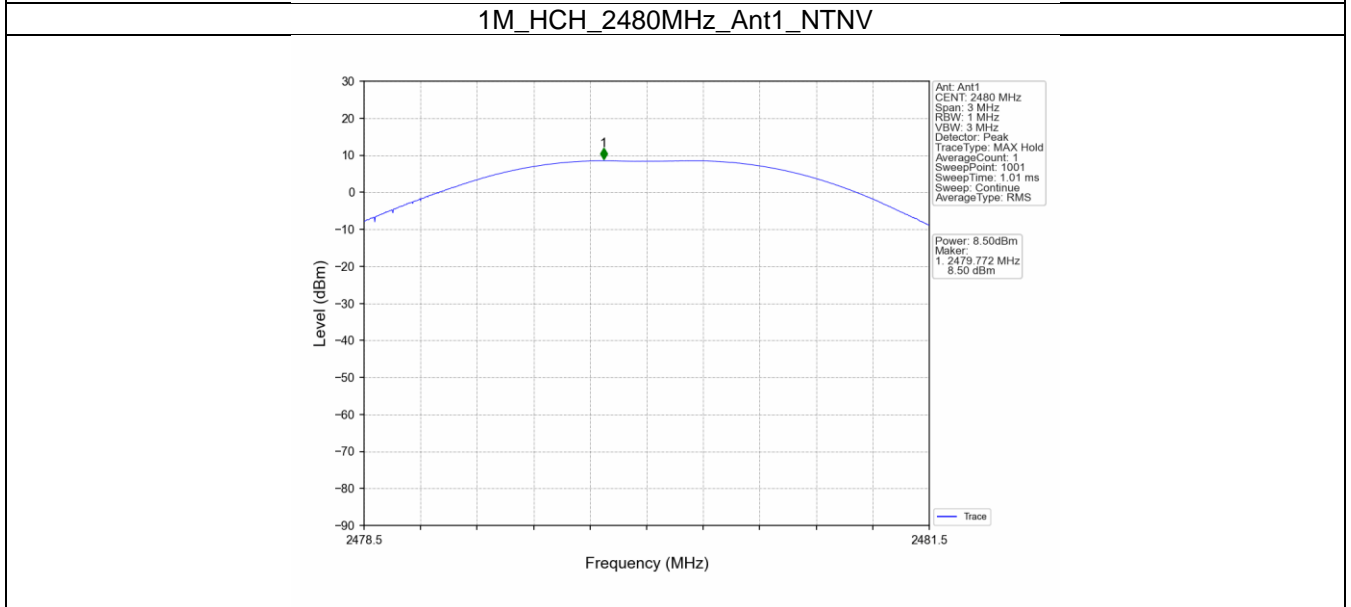
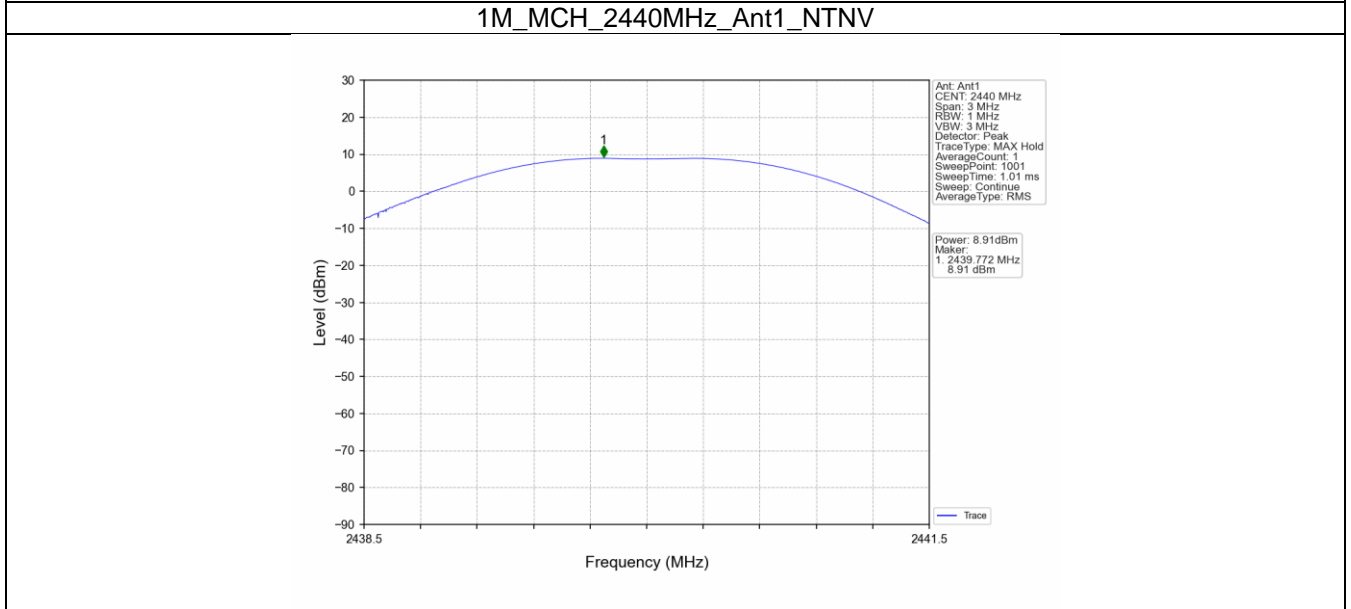
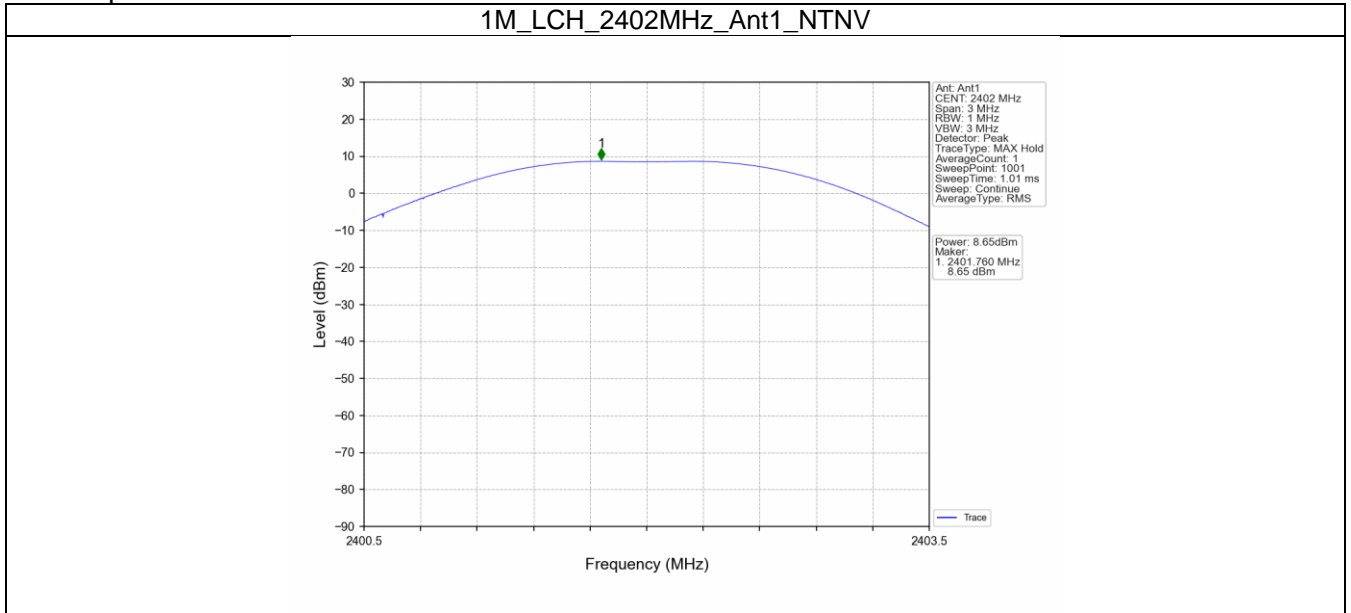

2M_LCH_2402MHz_Ant1_NTNV

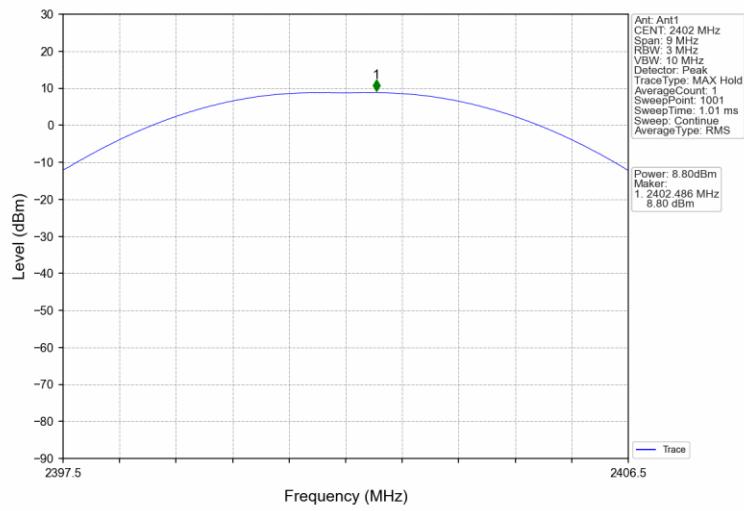

2M_MCH_2440MHz_Ant1_NTNV

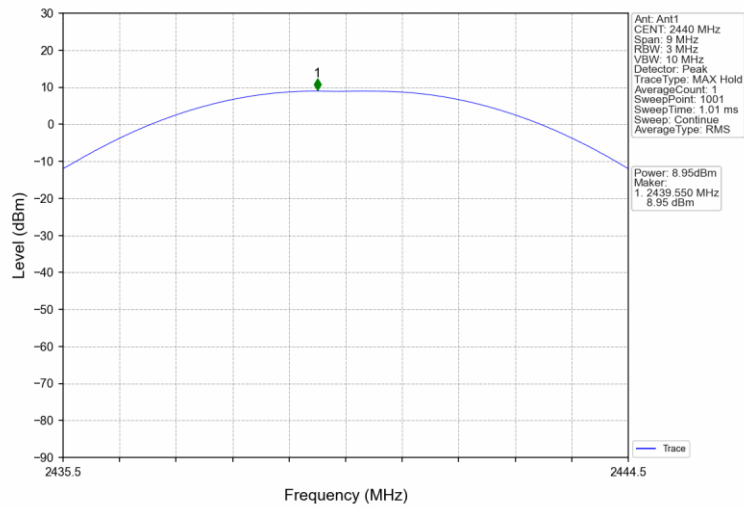

2M_HCH_2480MHz_Ant1_NTNV

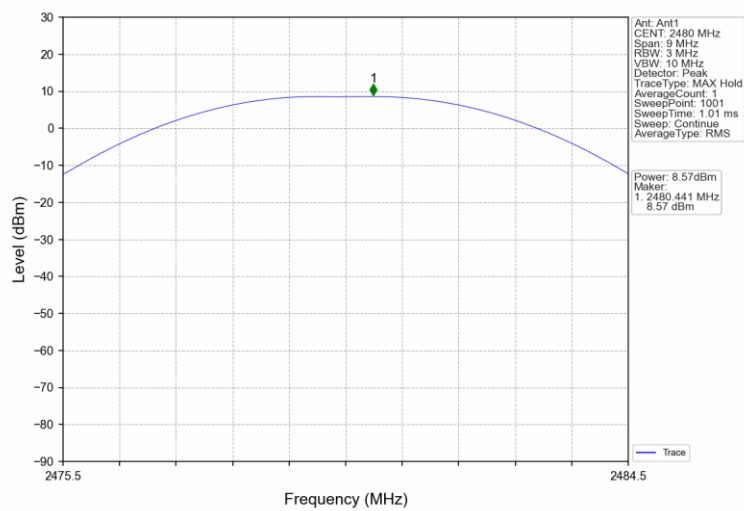

9.3 Power Spectral Density

Test Method

This procedure shall be used if maximum peak conducted output power was used to demonstrate compliance:

1. The RF output of EUT was connected to the spectrum analyzer. The path loss was compensated to the results for each measurement.
2. Set to the maximum power setting, the instrument center frequency is set to the nominal EUT channel center frequency enable the EUT transmit continuously.
3. Use the following spectrum analyzer settings:
4. Set analyzer center frequency to DTS channel center frequency. RBW=3kHz, VBW \geq 3RBW, Span=1.5 times DTS bandwidth, Detector=Peak, Sweep=auto, Trace= max hold.
5. Allow trace to fully stabilize, use the peak marker function to determine the maximum amplitude level within the RBW.
6. Repeat above procedures until other frequencies measured were completed.

Limit

According to §15.247(e), power spectral density limit as below:

Limit [dBm]

≤8

Test result

Frequency MHz	Mode	Power spectral density dBm/3kHz	Result
Bottom channel 2402MHz	LE 1M	-5.97	Pass
Middle channel 2440MHz	LE 1M	-5.73	Pass
Top channel 2480MHz	LE 1M	-6.07	Pass
Bottom channel 2402MHz	LE 2M	-7.38	Pass
Middle channel 2440MHz	LE 2M	-7.12	Pass
Top channel 2480MHz	LE 2M	-7.56	Pass

Test Graphs:

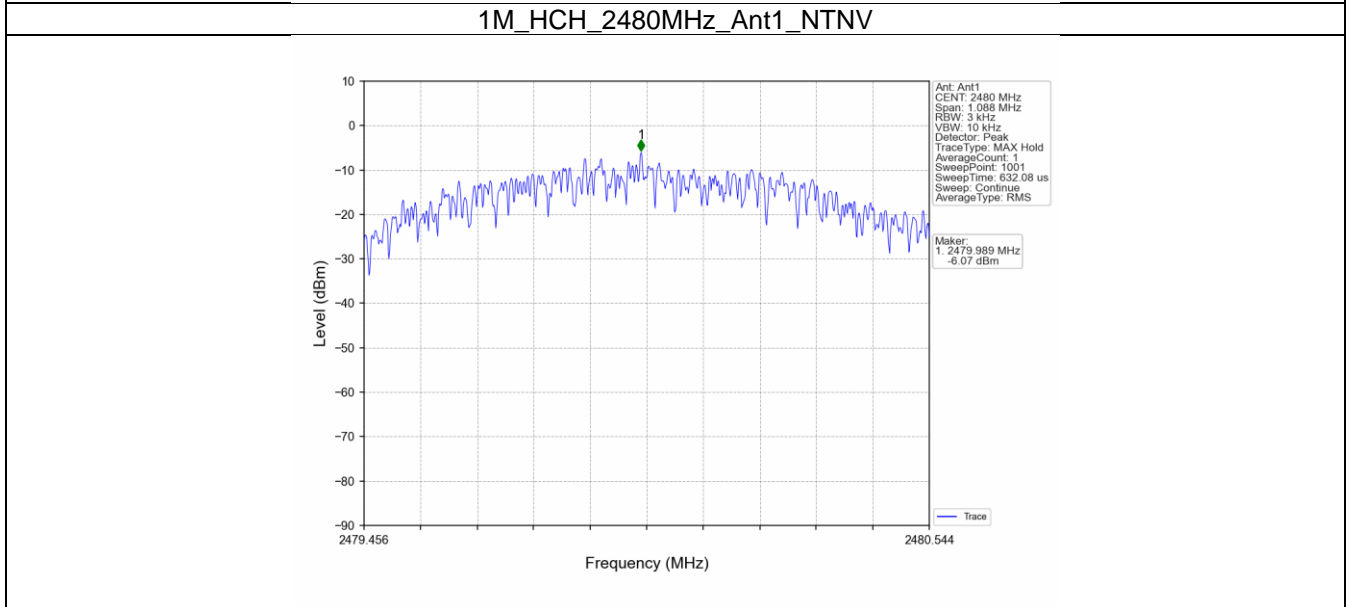
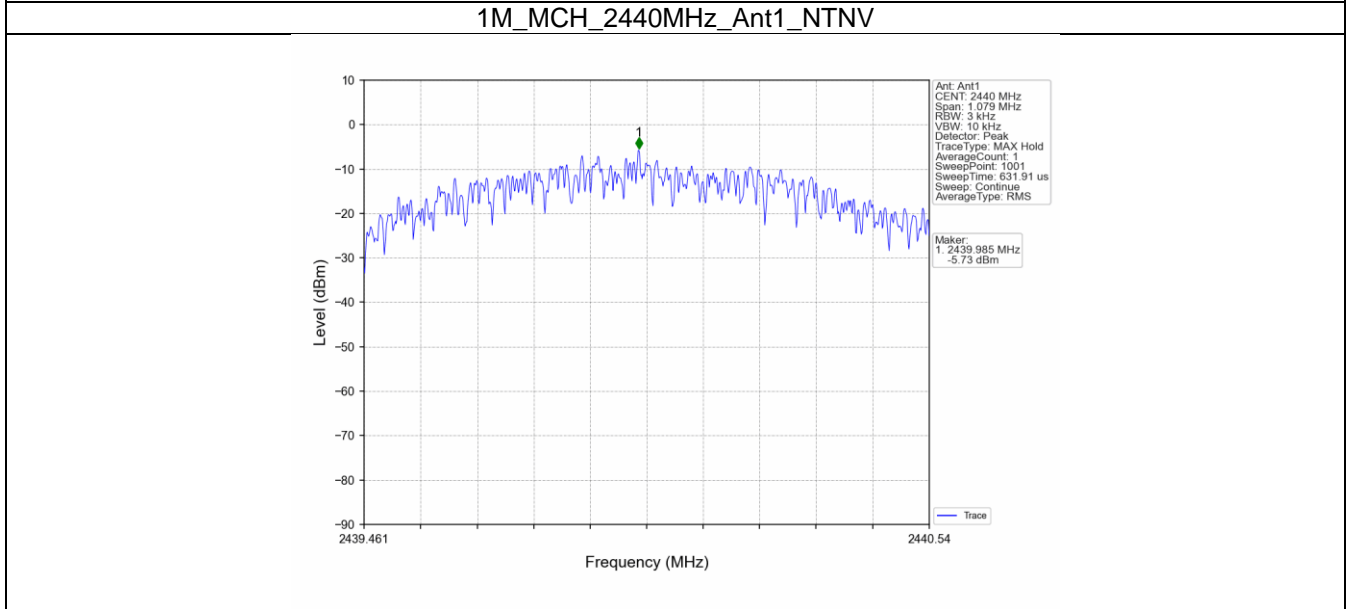
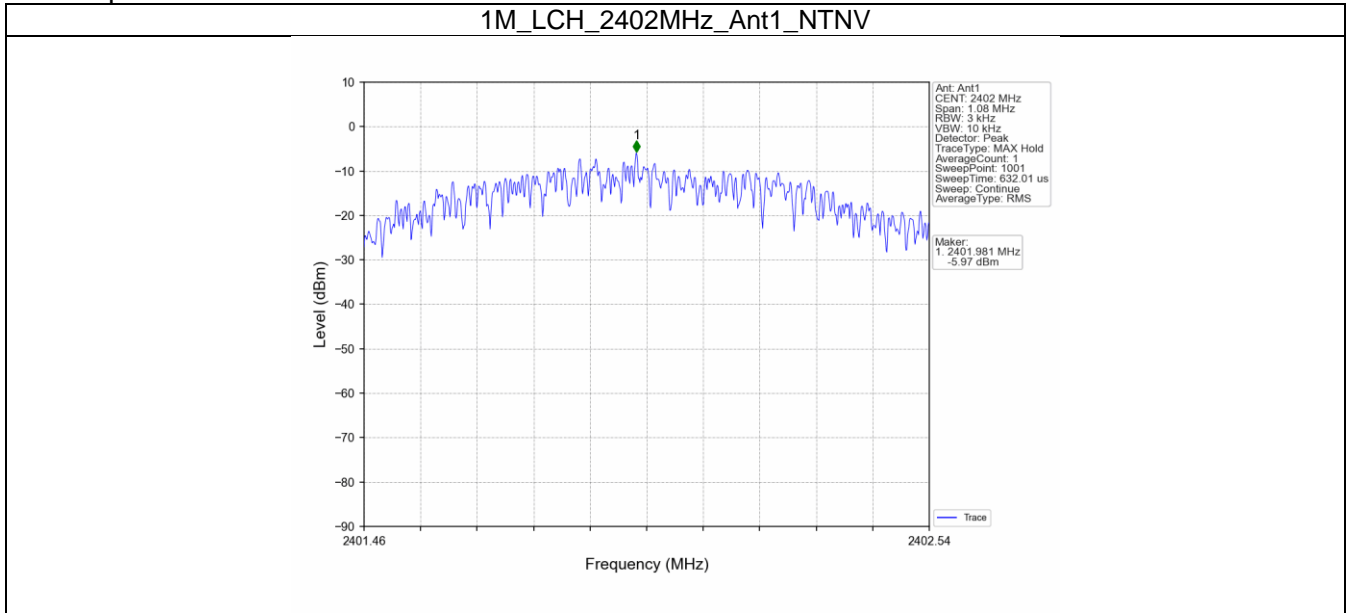

2M_LCH_2402MHz_Ant1_NTNV

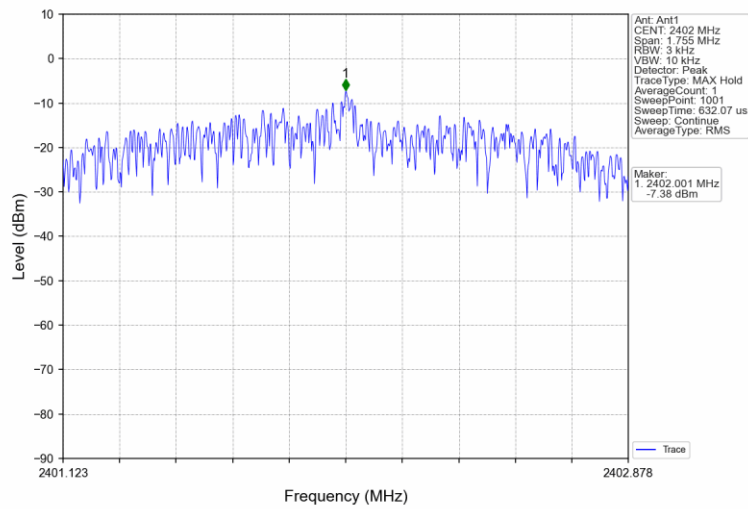

2M_MCH_2440MHz_Ant1_NTNV

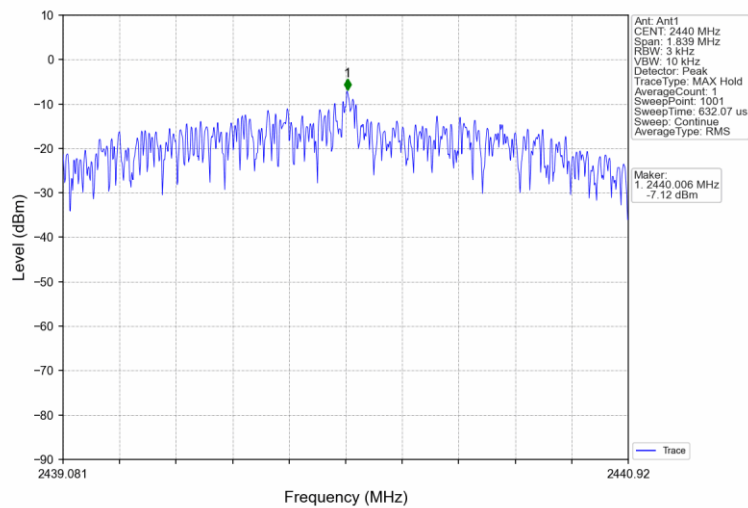

2M_HCH_2480MHz_Ant1_NTNV

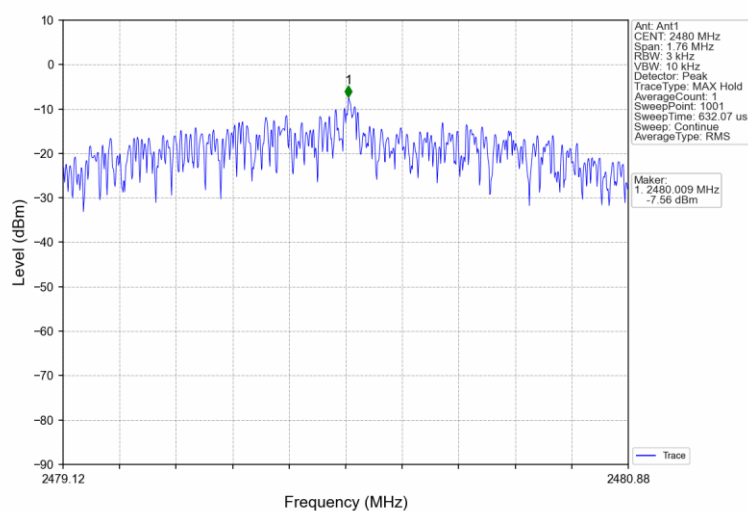

9.4 6 dB Bandwidth

Test Method

1. The RF output of EUT was connected to the spectrum analyzer. The path loss was compensated to the results for each measurement.
2. Set to the maximum power setting, the instrument center frequency is set to the nominal EUT channel center frequency enable the EUT transmit continuously.
3. Use the following spectrum analyzer settings:
RBW=100KHz, VBW≥3RBW, Sweep = auto, Detector function = peak, Trace = max hold
4. Use the automatic bandwidth measurement capability of an instrument, use the X dB bandwidth mode with X set to 6 dB.
5. Allow the trace to stabilize, record the 6 dB Bandwidth value.

Limit

According to §15.247(a)(2), 6 dB Bandwidth limit as below:

Limit [kHz]

≥500

Test result

Frequency MHz	Mode	6dB bandwidth MHz	Result
Bottom channel 2402MHz	LE 1M	0.720	Pass
Middle channel 2440MHz	LE 1M	0.719	Pass
Top channel 2480MHz	LE 1M	0.725	Pass
Bottom channel 2402MHz	LE 2M	1.170	Pass
Middle channel 2440MHz	LE 2M	1.226	Pass
Top channel 2480MHz	LE 2M	1.173	Pass

Test Graphs:

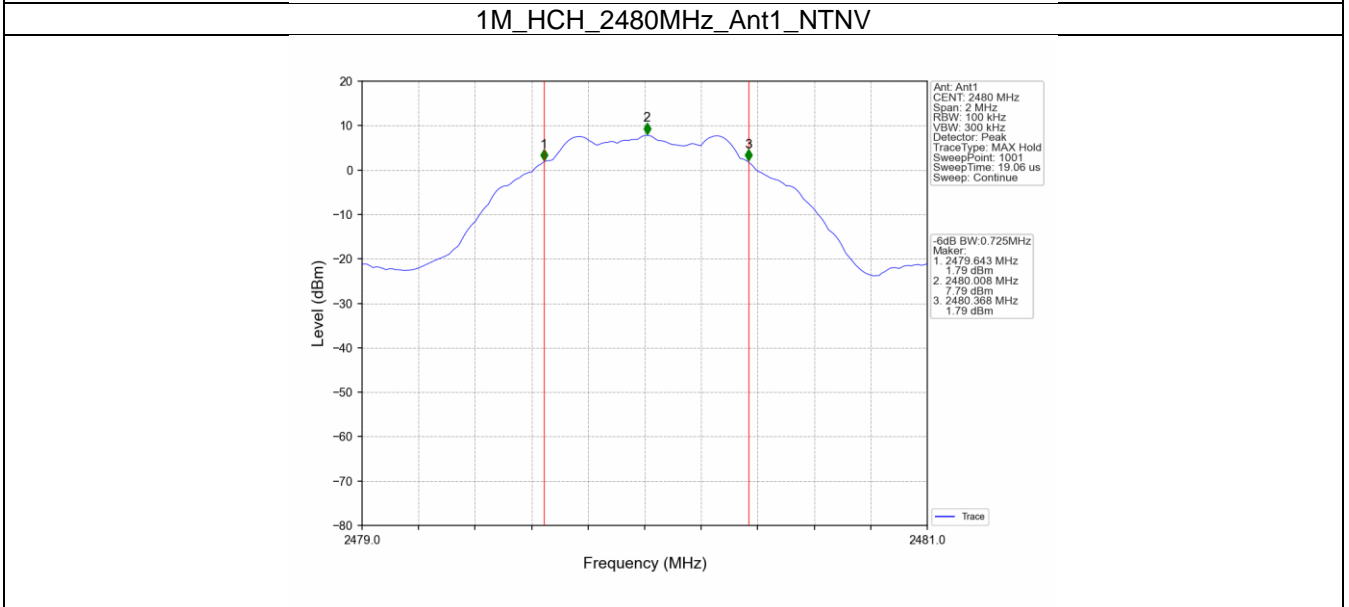
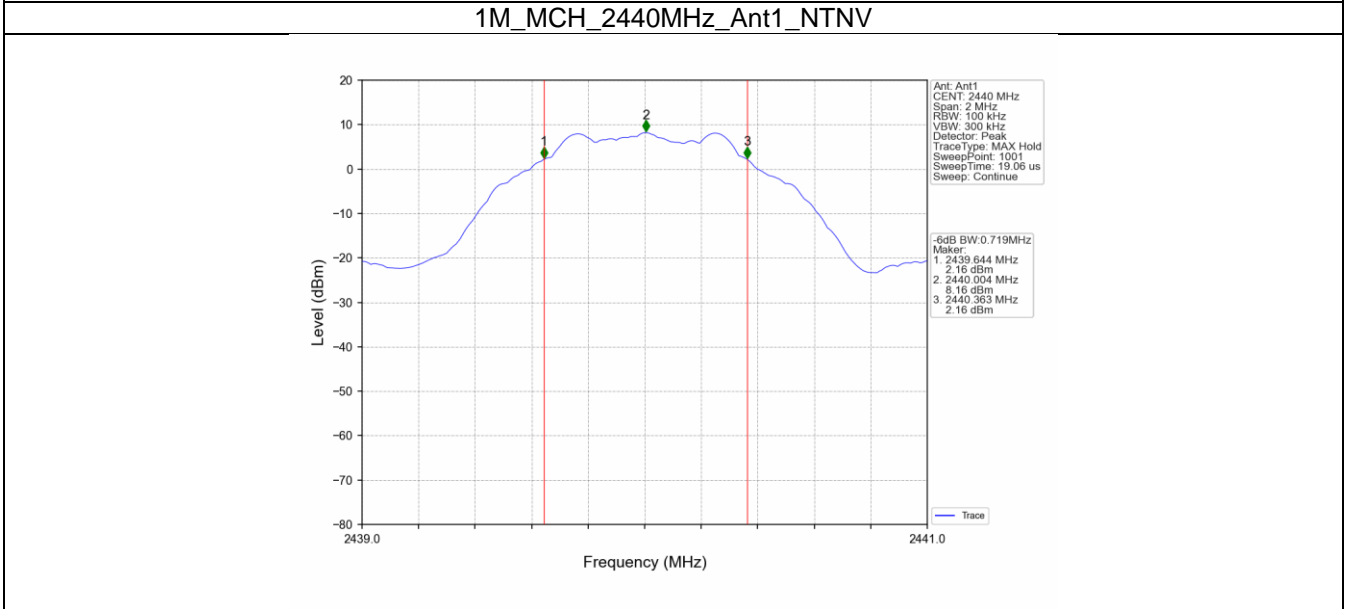
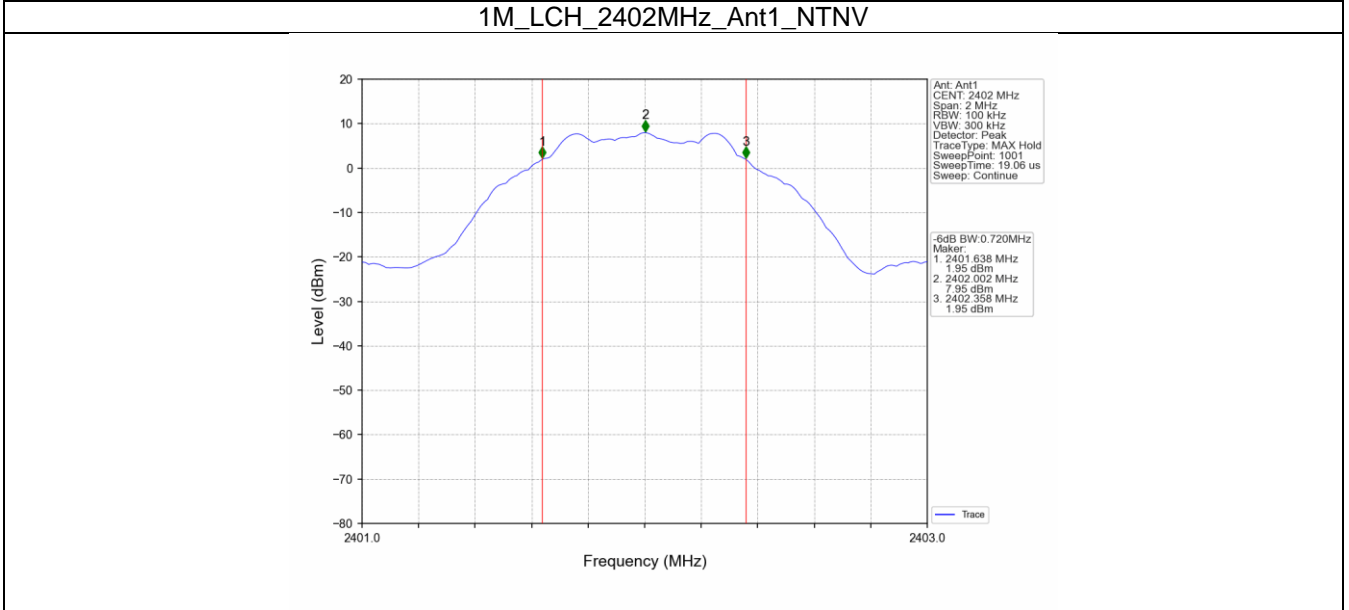

2M_LCH_2402MHz_Ant1_NTNV

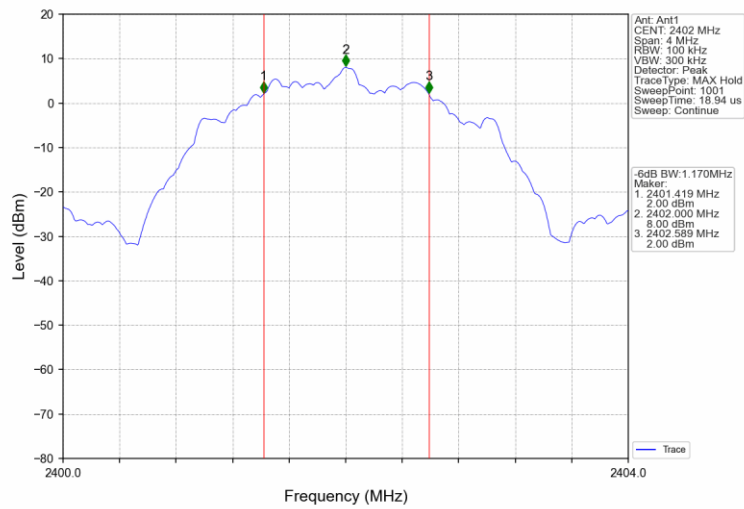

2M_MCH_2440MHz_Ant1_NTNV

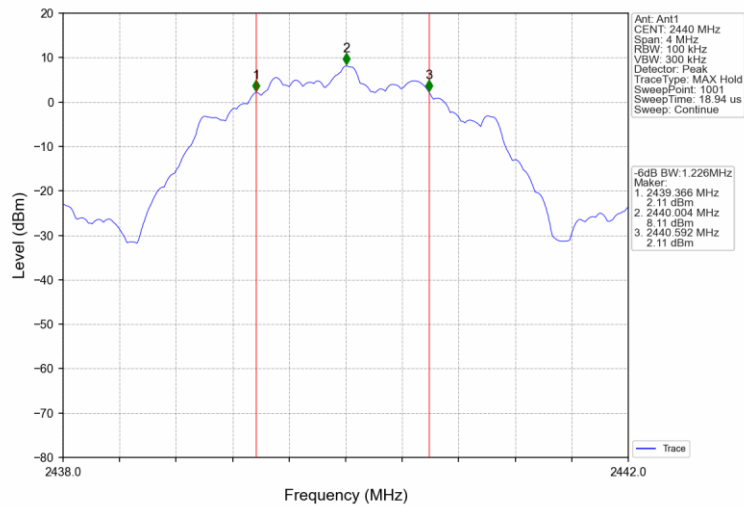

2M_HCH_2480MHz_Ant1_NTNV

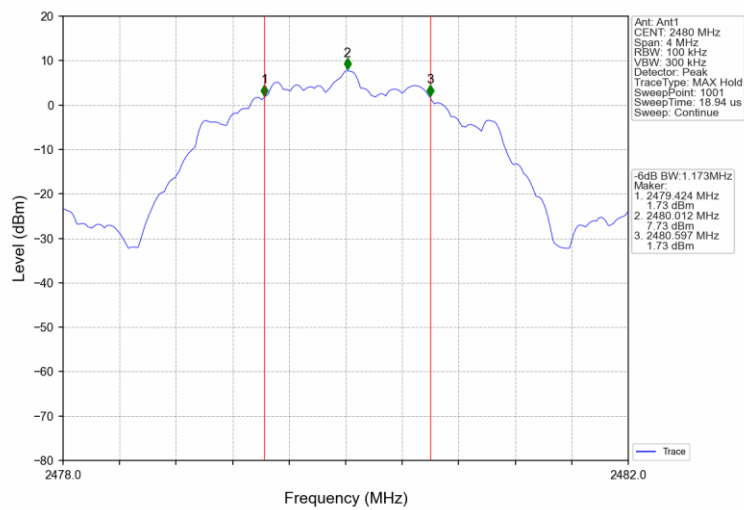

9.5 99% Bandwidth

Test Method

1. Connect EUT test port to spectrum analyzer.
2. Use the following spectrum analyzer settings:
RBW=1% to 5% of the actual occupied, VBW \geq 3RBW, Sweep = auto,
Detector function = peak, Trace = max hold
3. Use the occupied bandwidth measurement capability of test receiver.
4. Allow the trace to stabilize, record the occupied bandwidth value.

Limit

According to 15.247(a)(2), 99% Bandwidth limit as below:

Limit [kHz]

--

Test result

Frequency MHz	Mode	99% bandwidth MHz	Result
Bottom channel 2402MHz	LE 1M	1.048	Pass
Middle channel 2440MHz	LE 1M	1.048	Pass
Top channel 2480MHz	LE 1M	1.049	Pass
Bottom channel 2402MHz	LE 2M	2.116	Pass
Middle channel 2440MHz	LE 2M	2.118	Pass
Top channel 2480MHz	LE 2M	2.116	Pass

Test Graphs:

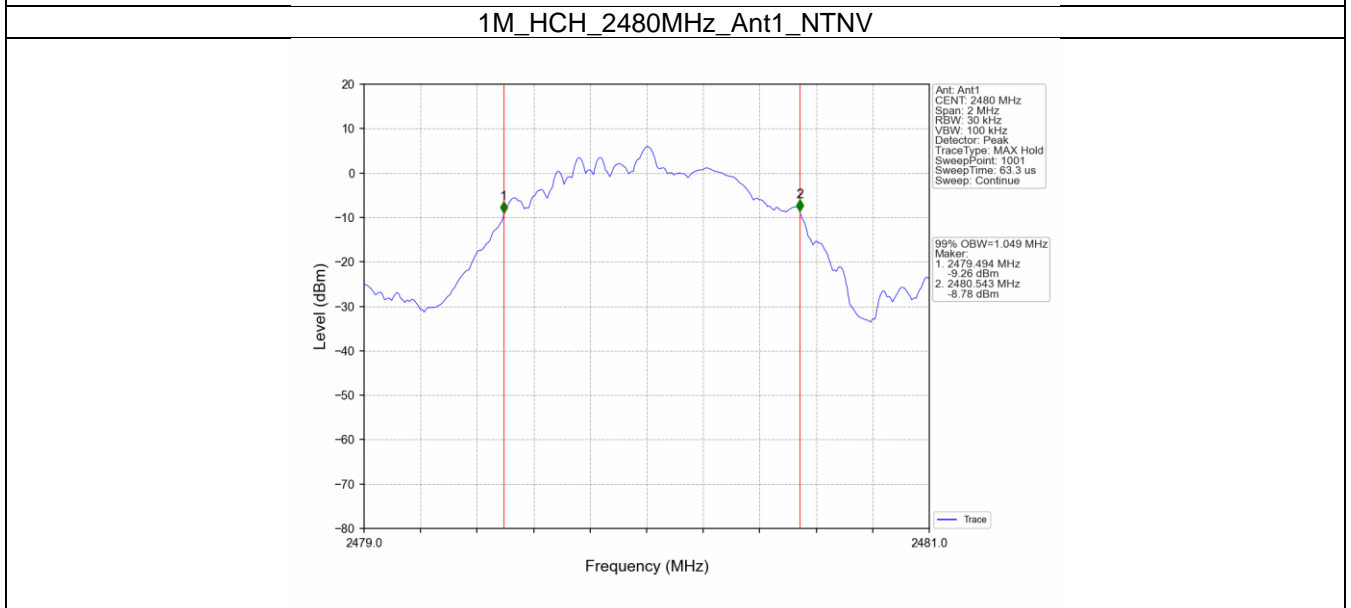
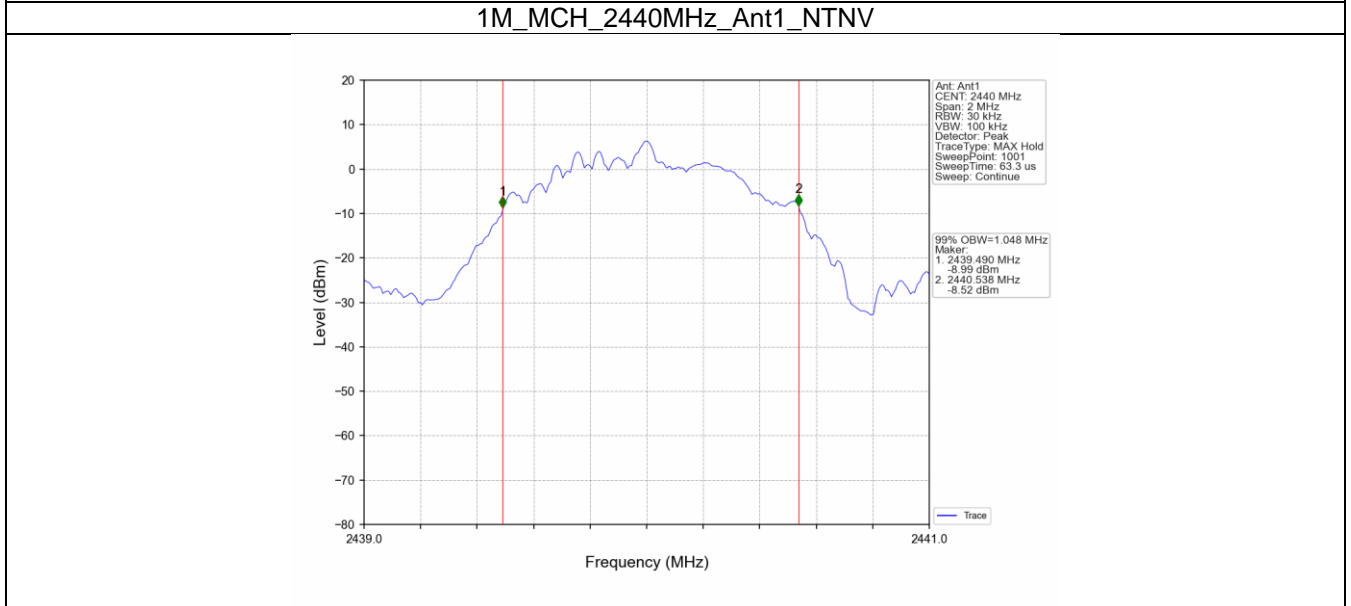
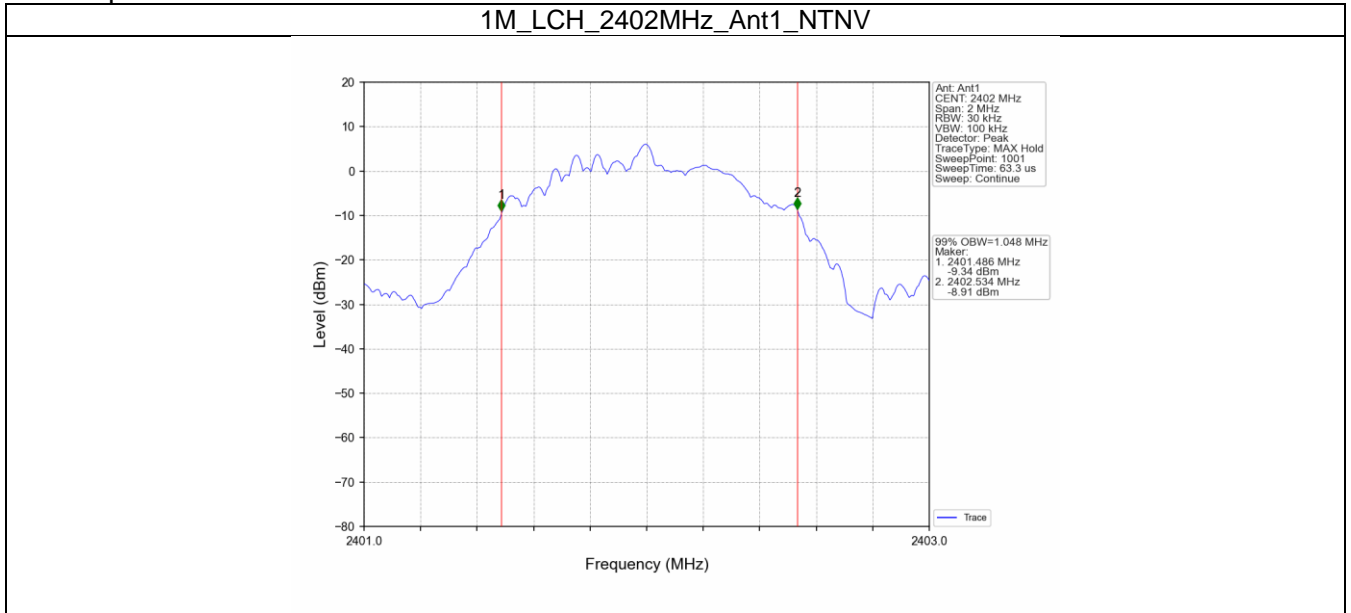

2M_LCH_2402MHz_Ant1_NTNV

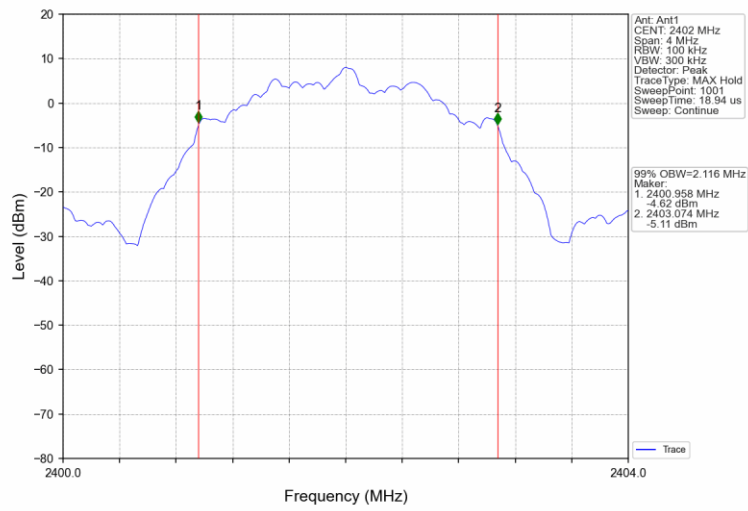

2M_MCH_2440MHz_Ant1_NTNV

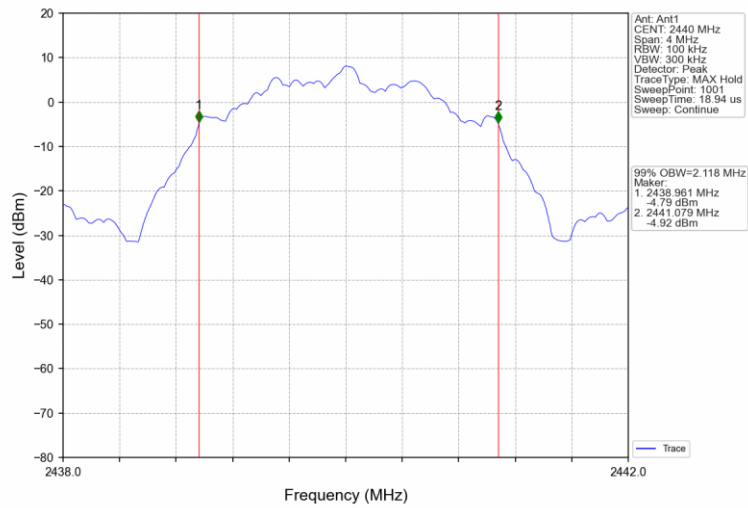

2M_HCH_2480MHz_Ant1_NTNV

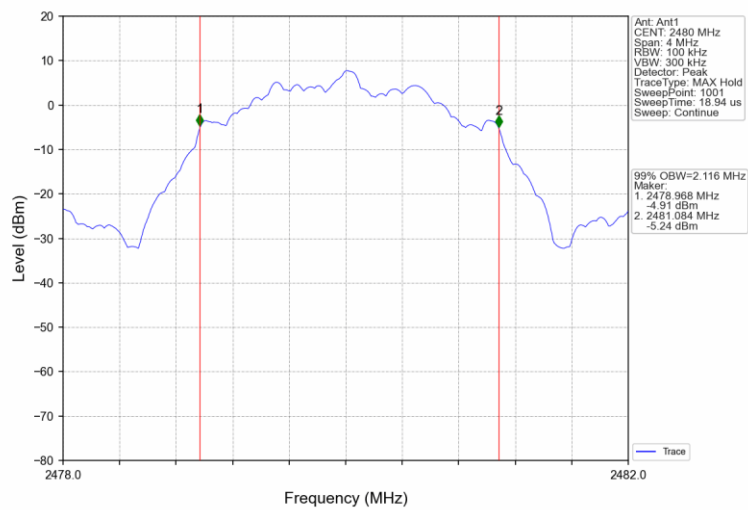

9.6 Spurious RF Conducted Emissions

Test Method

1. The RF output of EUT was connected to the spectrum analyzer by RF cable. The path loss was compensated to the results for each measurement.
2. Set to the maximum power setting, the instrument center frequency is set to the nominal EUT channel center frequency enable the EUT transmit continuously.
3. Use the following spectrum analyzer settings:
 Span = wide enough to capture the peak level of the in-band emission and all spurious emissions (e.g., harmonics) from the lowest frequency generated in the EUT up through the 10th harmonic. Typically, several plots are required to cover this entire span.
 RBW = 100 kHz, VBW≥3RBW, Sweep = auto, Detector function = peak, Trace = max hold
4. Allow the trace to stabilize. Set the marker on the peak of any spurious emission recorded.
5. The level displayed must comply with the limit specified in this Section. Submit these plots.
6. Repeat above procedures until all frequencies measured were complete.

Limit

According to §15.247(d), Spurious RF Conducted Emissions limit as below:

In any 100 kHz bandwidth outside the frequency band in which the spread spectrum or digitally modulated device is operating, the RF power that is produced shall be at least 20 dB below that in the 100 kHz bandwidth within the band that contains the highest level of the desired power, based on either an RF conducted or a radiated measurement, provided that the transmitter demonstrates compliance with the peak conducted power limits. If the transmitter complies with the conducted power limits based on the use of RMS averaging over a time interval, as permitted under § 15.247(b)(3), the attenuation required shall be 30 dB instead of 20 dB.

Frequency Range MHz	Limit (dBc)
30-25000	-20

Spurious RF conducted emissions

Mode	TX Type	Frequency (MHz)	ANT	Level of Reference (dBm)
1M	SISO	2402	1	7.94
		2440	1	8.16
		2480	1	7.80
2M	SISO	2402	1	7.99
		2440	1	8.11
		2480	1	7.76

Mode	TX Type	Frequency (MHz)	ANT	Level of Reference (dBm)	Limit (dBm)	Verdict
1M	SISO	2402	1	8.16	-11.84	Pass
		2440	1	8.16	-11.84	Pass
		2480	1	8.16	-11.84	Pass
2M	SISO	2402	1	8.11	-11.89	Pass
		2440	1	8.11	-11.89	Pass
		2480	1	8.11	-11.89	Pass

Note1: Refer to FCC Part 15.247 (d) and ANSI C63.10, the channel contains the maximum PSD level was used to establish the reference level.

1M_LCH_2402MHz_Ant1_NTNV

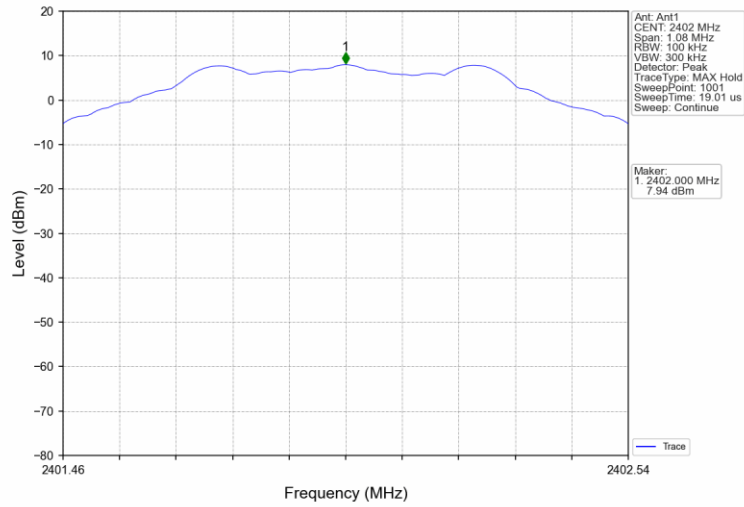

1M_MCH_2440MHz_Ant1_NTNV

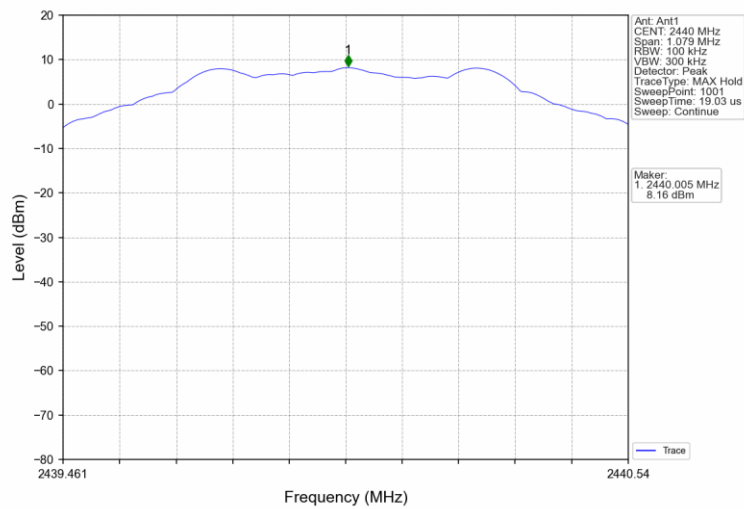

1M_HCH_2480MHz_Ant1_NTNV

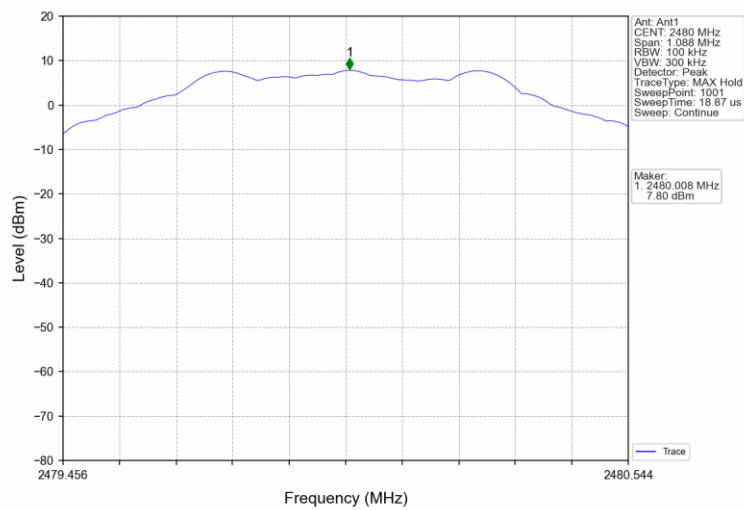

2M_LCH_2402MHz_Ant1_NTNV

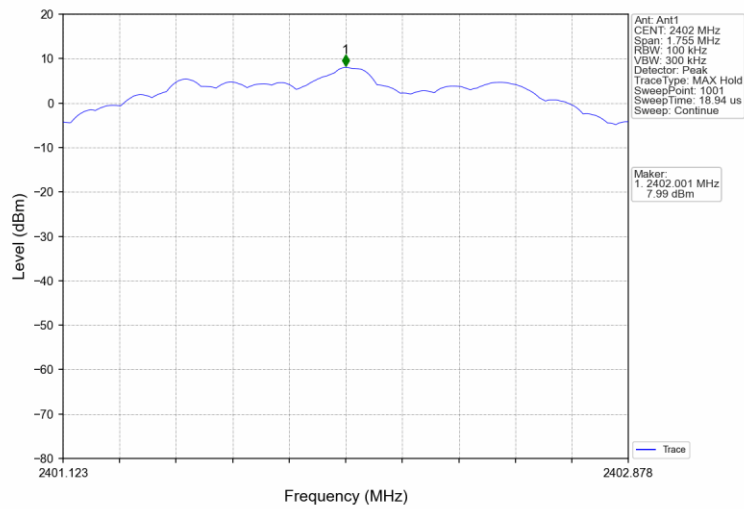

2M_MCH_2440MHz_Ant1_NTNV

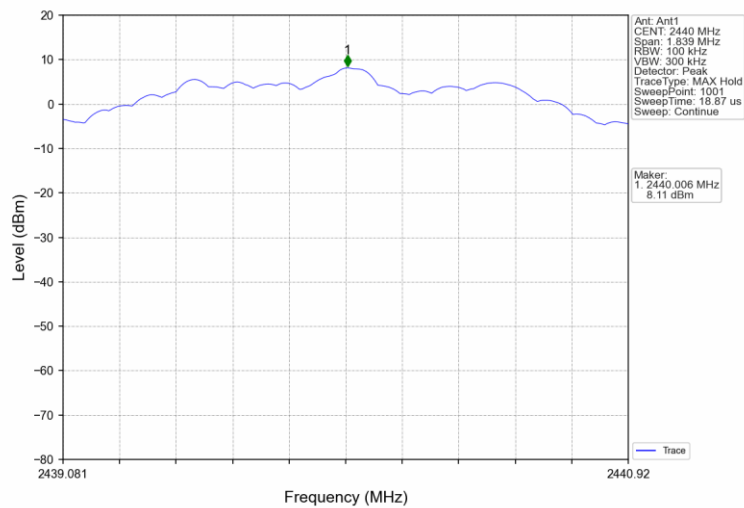

2M_HCH_2480MHz_Ant1_NTNV

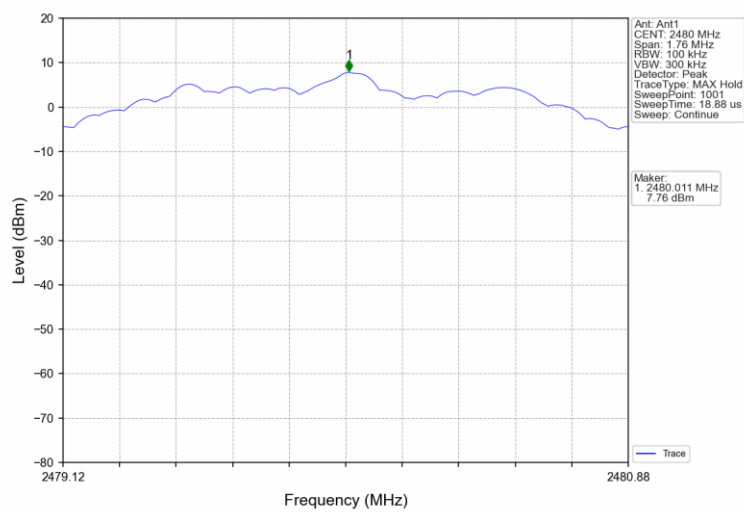

1M_LCH_2402MHz_Ant1_NTNV

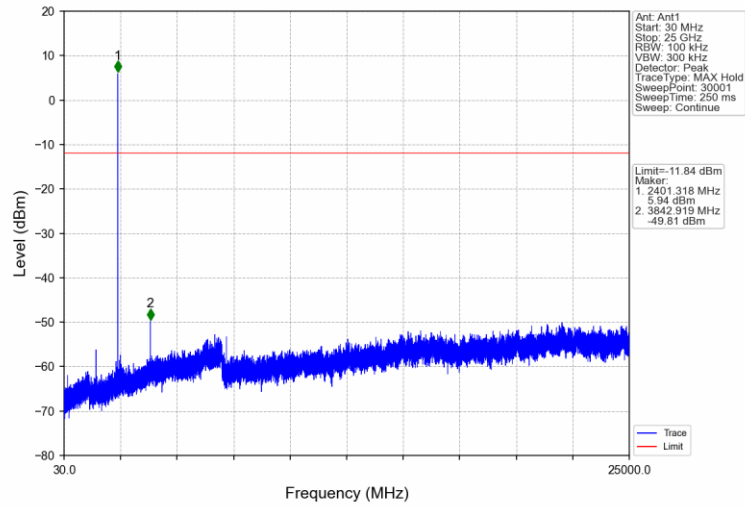

1M_MCH_2440MHz_Ant1_NTNV

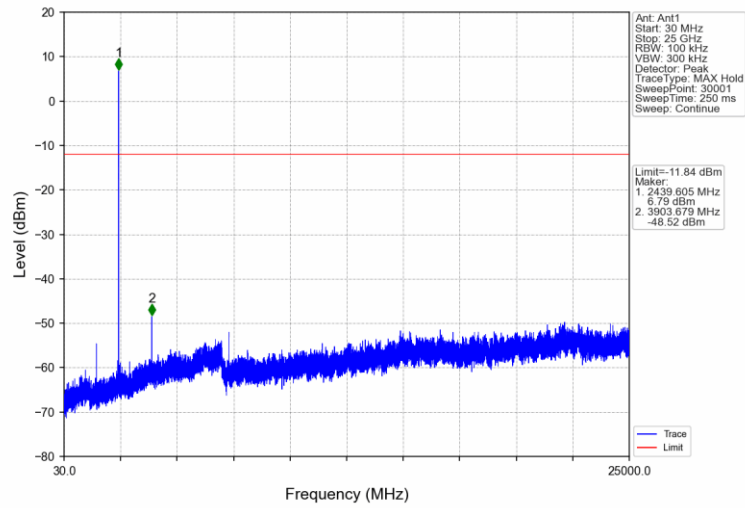

1M_HCH_2480MHz_Ant1_NTNV

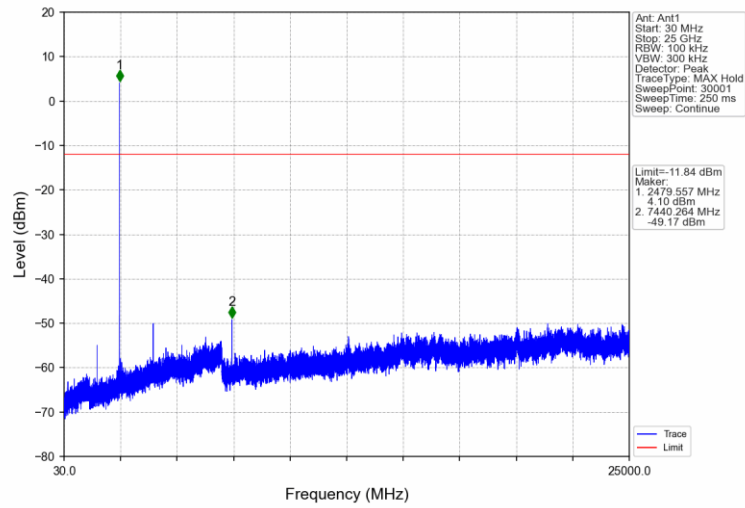

2M_LCH_2402MHz_Ant1_NTNV

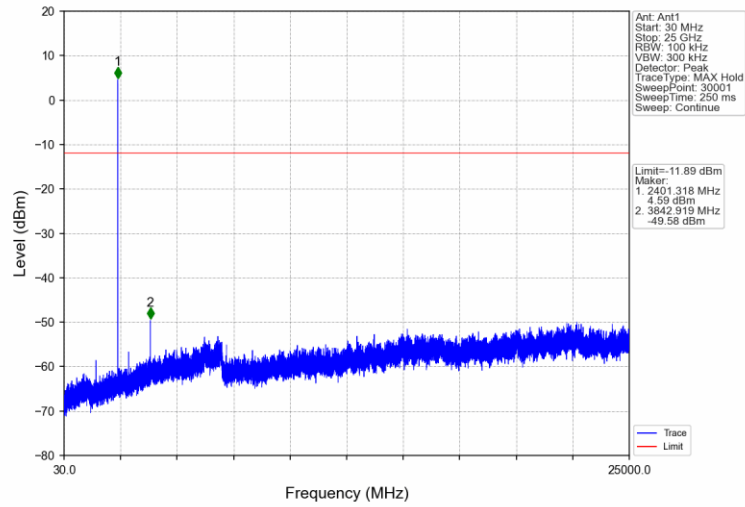

2M_MCH_2440MHz_Ant1_NTNV

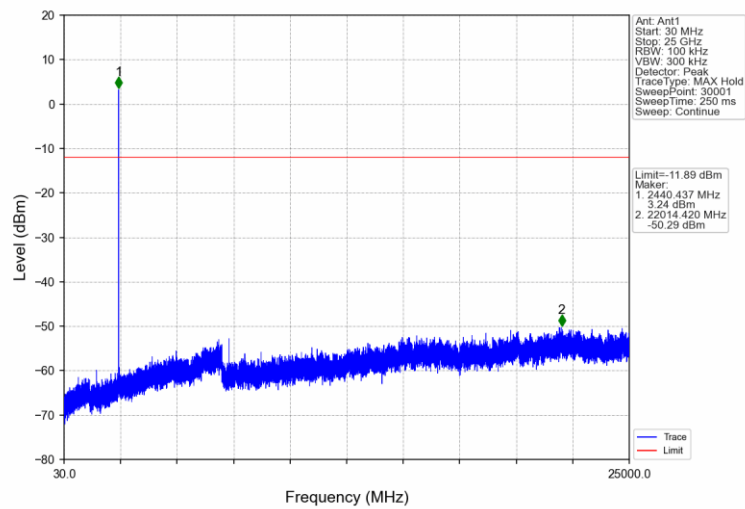

2M_HCH_2480MHz_Ant1_NTNV

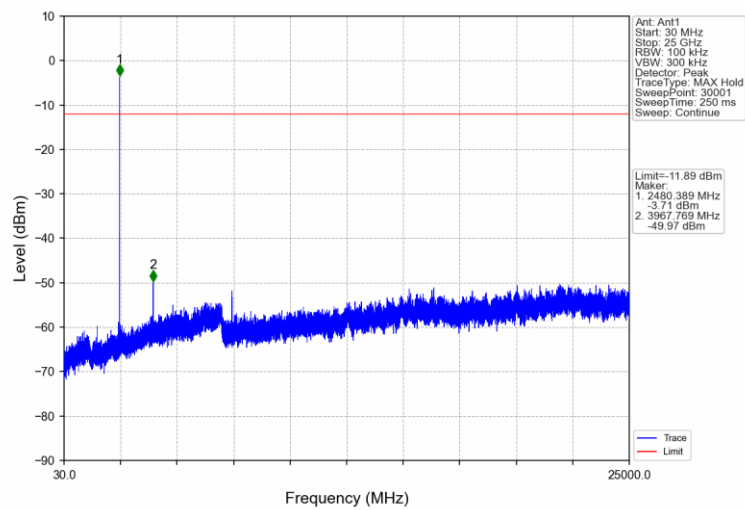

9.7 Band Edge

Test Method

1. The RF output of EUT was connected to the spectrum analyzer by RF cable. The path loss was compensated to the results for each measurement.
2. Set to the maximum power setting, the instrument center frequency is set to the nominal EUT channel center frequency enable the EUT transmit continuously.
3. Use the following spectrum analyzer settings:
Span = wide enough to capture the peak level of the in-band emission and all spurious
RBW = 100 kHz, VBW \geq 3RBW, Sweep = auto, Detector function = peak, Trace = max hold
4. Allow the trace to stabilize, use the peak and delta measurement to record the result.
5. The level displayed must comply with the limit specified in this Section.
6. Repeat above procedures until all frequencies measured were complete and submit all the plots.

Limit:

According to §15.247(d), Band Edge limit as below:

In any 100 kHz bandwidth outside the frequency band in which the spread spectrum or digitally modulated device is operating, the RF power that is produced shall be at least 20 dB below that in the 100 kHz bandwidth within the band that contains the highest level of the desired power, based on either an RF conducted or a radiated measurement, provided that the transmitter demonstrates compliance with the peak conducted power limits. If the transmitter complies with the conducted power limits based on the use of RMS averaging over a time interval, as permitted under § 15.247(b)(3), the attenuation required shall be 30 dB instead of 20 dB.

Frequency Range MHz	Limit (dBc)
30-25000	-20

Band edge testing

Mode	TX Type	Frequency (MHz)	ANT	Level of Reference (dBm)	Limit (dBm)	Verdict
1M	SISO	2402	1	8.16	-11.84	Pass
		2440	1	8.16	-11.84	Pass
		2480	1	8.16	-11.84	Pass
2M	SISO	2402	1	8.11	-11.89	Pass
		2440	1	8.11	-11.89	Pass
		2480	1	8.11	-11.89	Pass

Note1: Refer to FCC Part 15.247 (d) and ANSI C63.10, the channel contains the maximum PSD level was used to establish the reference level.

1M_LCH_2402MHz_Ant1_NTNV

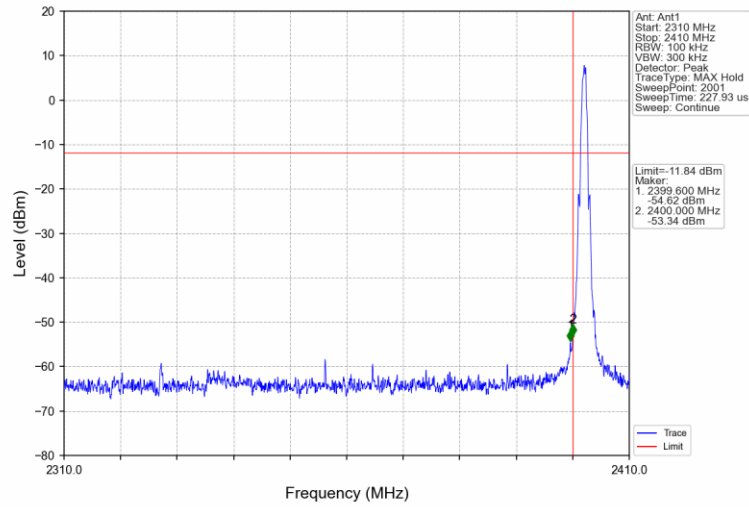

1M_HCH_2480MHz_Ant1_NTNV

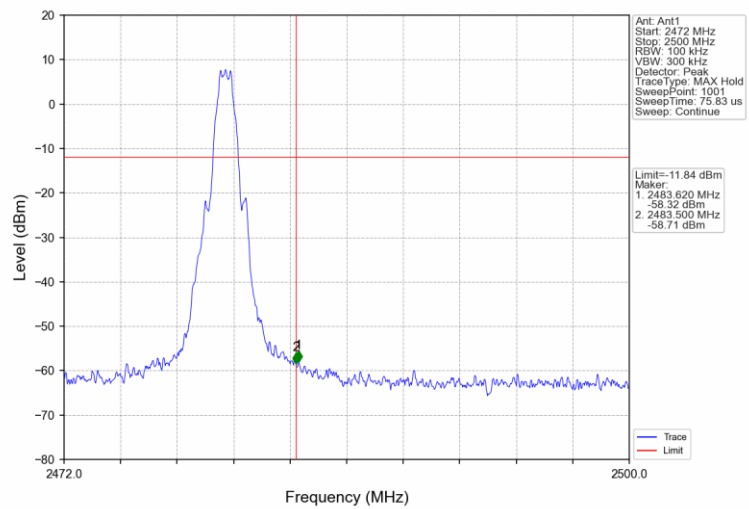

2M_LCH_2402MHz_Ant1_NTNV

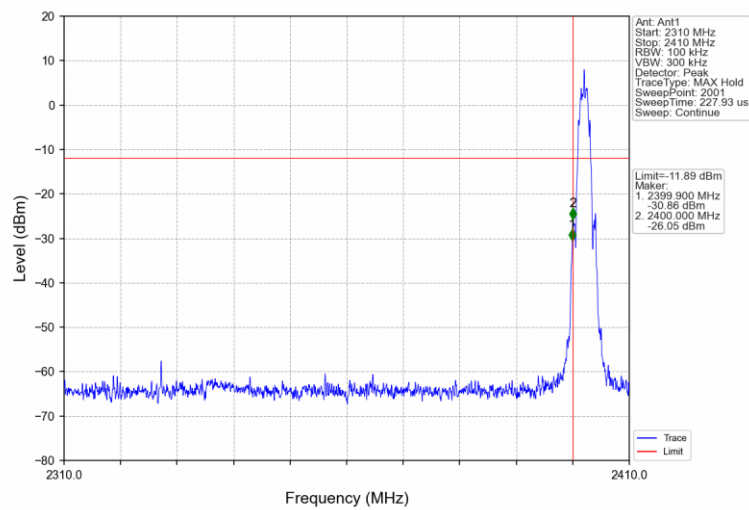

2M_HCH_2480MHz_Ant1_NTNV

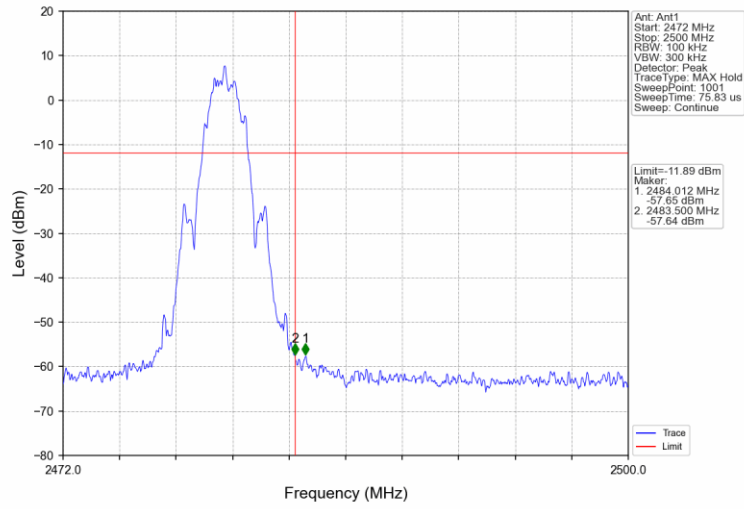

9.8 Spurious Radiated Emissions for Transmitter

Test Method

- 1: The EUT was placed on a turn table which is 1.5m above ground plane for above 1GHz and 0.8m above ground for below 1GHz at 3 meter chamber room for test. The table was rotated 360 degrees to determine the position of the highest radiation.
- 2: The EUT was set 3 meters away from the interference – receiving antenna, which was mounted on the top of a variable – height antenna tower.
- 3: The height of antenna is varied from one meter to four meters above the ground to determine the maximum value of the field strength. Both horizontal and vertical polarizations of the antenna are set to make the measurement.
- 4: For each suspected emission, the EUT was arranged to its worst case and then the antenna was tuned to heights from 1 meter to 4 meters and the rotatable table was turned from 0 degrees to 360 degrees to find the maximum reading.
- 5: Use the following spectrum analyzer settings According to C63.10:

For Below 1GHz

Use the following spectrum analyzer settings:

Span = wide enough to capture the peak level of the in-band emission and all spurious
 RBW = 100kHz to 120kHz, VBW ≥ RBW for peak measurement, Sweep = auto, Detector function = peak, Trace = max hold.

For Peak unwanted emissions Above 1GHz:

Span = wide enough to capture the peak level of the in-band emission and all spurious
 RBW = 1MHz, VBW ≥ RBW for peak measurement, Sweep = auto, Detector function = peak, Trace = max hold.

Procedures for average unwanted emissions measurements above 1000 MHz

- a) RBW = 1MHz.
- b) VBW \ [3 × RBW].
- c) Detector = RMS (power averaging), if [span / (# of points in sweep)] \ RBW / 2. Satisfying this condition can require increasing the number of points in the sweep or reducing the span. If the condition is not satisfied, then the detector mode shall be set to peak.
- d) Averaging type = power (i.e., rms) (As an alternative, the detector and averaging type may be set for linear voltage averaging. Some instruments require linear display mode to use linear voltage averaging. Log or dB averaging shall not be used.)
- e) Sweep time = auto.
- f) Perform a trace average of at least 100 traces if the transmission is continuous. If the transmission is not continuous, then the number of traces shall be increased by a factor of 1 / D, where D is the duty cycle. For example, with 50% duty cycle, at least 200 traces shall be averaged. (If a specific emission is demonstrated to be continuous—i.e., 100% duty cycle—then rather than turning ON and OFF with the transmit cycle, at least 100 traces shall be averaged.)
- g) If tests are performed with the EUT transmitting at a duty cycle less than 98%, then a correction factor shall be added to the measurement results prior to comparing with the emission limit, to compute the emission level that would have been measured had the test been performed at 100% duty cycle. The correction factor is computed as follows:
 - 1) If power averaging (rms) mode was used in the preceding step e), then the correction factor is [10 log (1 / D)], where D is the duty cycle. For example, if the transmit duty cycle was 50%, then 3 dB shall be added to the measured emission levels.
 - 2) If linear voltage averaging mode was used in the preceding step e), then the correction factor is [20 log (1 / D)], where D is the duty cycle. For example, if the transmit duty

cycle was 50%, then 6 dB shall be added to the measured emission levels.

3) If a specific emission is demonstrated to be continuous (100% duty cycle) rather than turning ON and OFF with the transmit cycle, then no duty cycle correction is required for that emission.

Limit

In any 100 kHz bandwidth outside the frequency band in which the spread spectrum or digitally modulated device is operating, the RF power that is produced shall be at least 20 dB below that in the 100 kHz bandwidth within the band that contains the highest level of the desired power, based on either an RF conducted or a radiated measurement, provided that the transmitter demonstrates compliance with the peak conducted power limits. If the transmitter complies with the conducted power limits based on the use of RMS averaging over a time interval, as permitted under § 15.247(b)(3), the attenuation required shall be 30 dB instead of 20 dB. Attenuation below the general field strength limits specified in § 15.209(a) is not required. In addition, radiated emissions which fall in the restricted bands, as defined in § 15.205(a), must also comply with the radiated emission limits specified in § 15.209(a).

Frequency MHz	Field Strength uV/m	Field Strength dBµV/m	Detector
30-88	100	40	QP
88-216	150	43.5	QP
216-960	200	46	QP
960-1000	500	54	QP
Above 1000	500	54	AV
Above 1000	5000	74	PK

Spurious radiated emissions for transmitter

According to C63.10, if the peak (or quasi-peak) measured value complies with the average limit, it is unnecessary to perform an average measurement, so AV emission value did not show in below table if the peak value complies with average limit.

Transmitting spurious emission test result as below:

Test data_30MHz to 1000MHz:

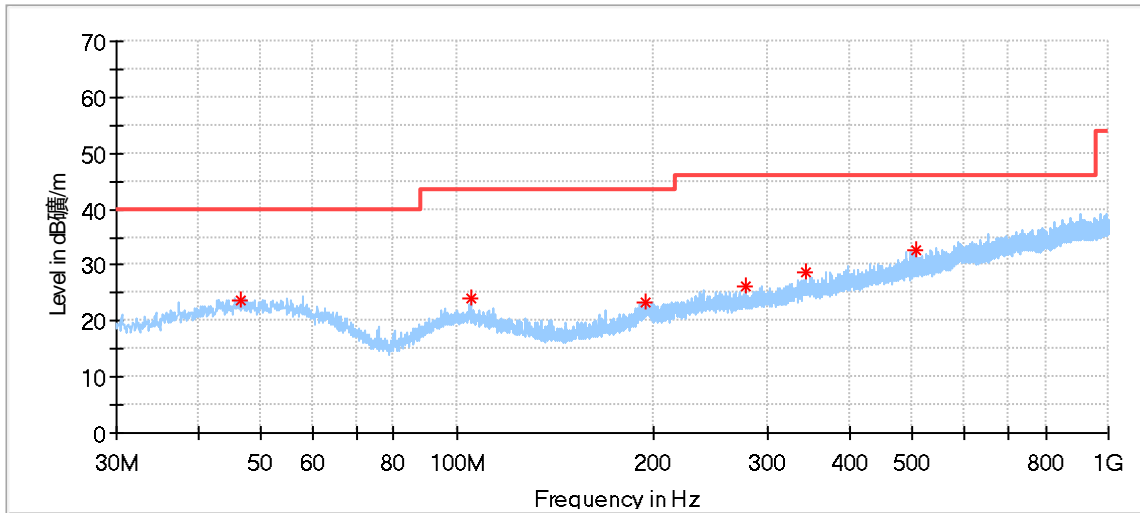

Frequency (MHz)	MaxPeak (dBµV/m)	Limit (dBµV/m)	Margin (dB)	Height (cm)	Pol	Azimuth (deg)	Corr. (dB/m)	Corr. (dB)
46.651667	23.79	40.00	16.21	200.0	H	209.0	18.45	---
104.797778	23.93	43.50	19.57	100.0	H	19.0	16.02	---
195.277222	23.45	43.50	20.05	100.0	H	305.0	16.35	---
277.026667	26.08	46.00	19.92	100.0	H	252.0	17.94	---
342.016667	28.73	46.00	17.27	100.0	H	89.0	19.89	---
506.701111	32.82	46.00	13.18	200.0	H	174.0	23.13	---

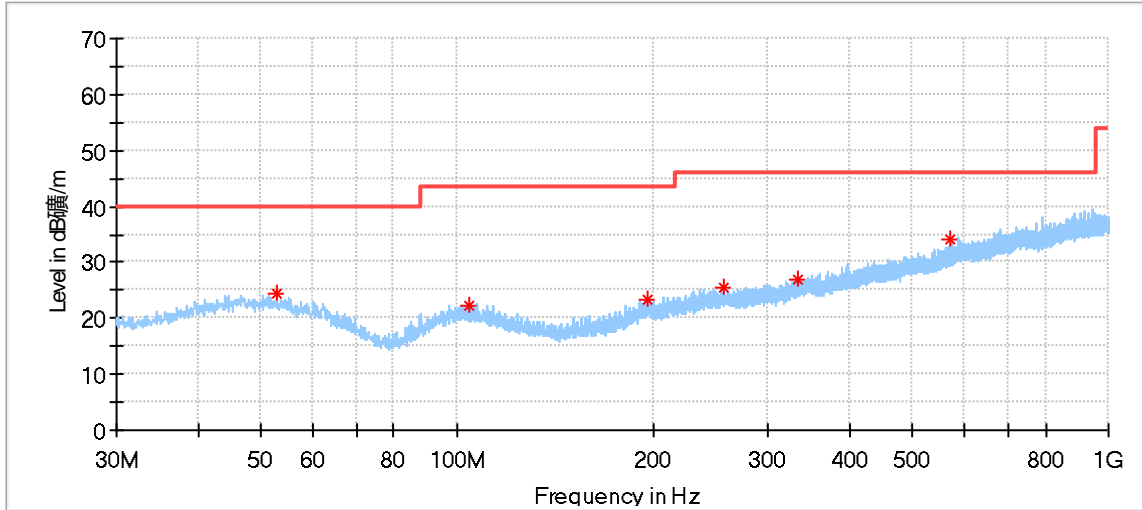

Frequency (MHz)	MaxPeak (dBµV/m)	Limit (dBµV/m)	Margin (dB)	Height (cm)	Pol	Azimuth (deg)	Corr. (dB/m)	Corr. (dB)
52.848889	24.50	40.00	15.50	200.0	V	42.0	18.15	---
104.043333	22.42	43.50	21.08	200.0	V	303.0	16.10	---
196.516667	23.16	43.50	20.34	200.0	V	227.0	16.36	---
256.279444	25.43	46.00	20.57	200.0	V	270.0	18.01	---
333.448333	26.97	46.00	19.03	200.0	V	42.0	19.52	---
572.553333	34.10	46.00	11.90	200.0	V	347.0	24.17	---

Test data 1GHz to 18GHz:

BLE_1M_Low Channel:

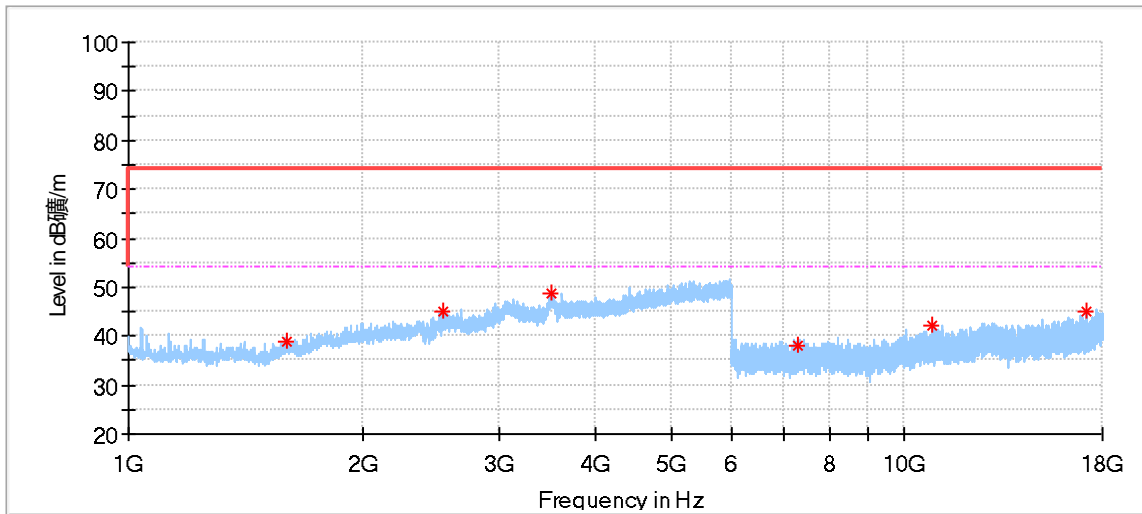

Frequency (MHz)	MaxPeak (dBµV/m)	Limit (dBµV/m)	Margin (dB)	Height (cm)	Pol	Azimuth (deg)	Corr. (dB/m)
1598.000000	39.08	74.00	34.92	150.0	H	218.0	-6.87
2551.500000	44.84	74.00	29.16	150.0	H	146.0	-1.34
3497.000000	48.88	74.00	25.12	150.0	H	85.0	4.25
7297.000000	38.21	74.00	35.79	150.0	H	183.0	6.63
10889.500000	42.25	74.00	31.75	150.0	H	332.0	10.84
17128.500000	44.83	74.00	29.17	150.0	H	287.0	18.86

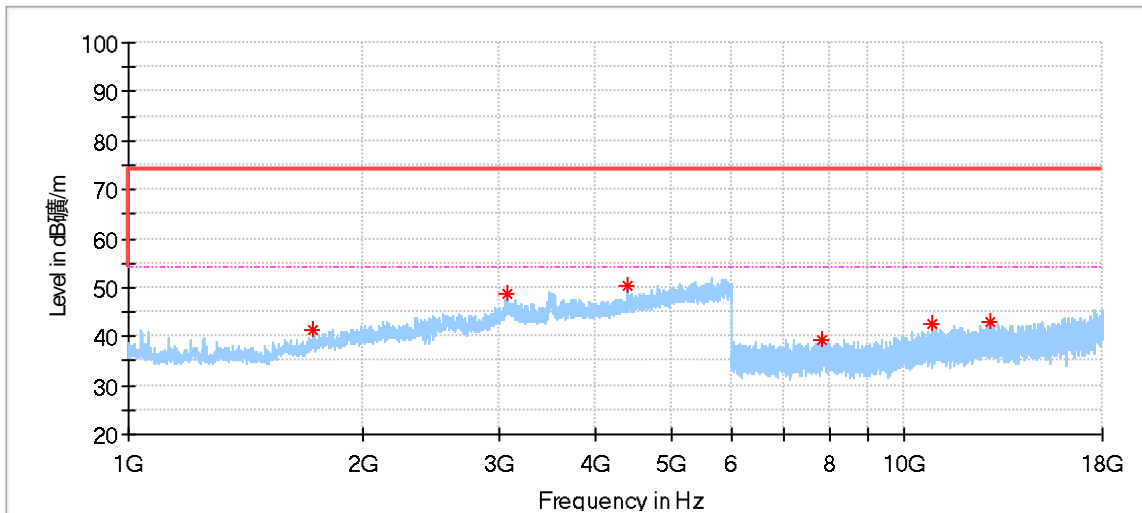

Frequency (MHz)	MaxPeak (dBµV/m)	Limit (dBµV/m)	Margin (dB)	Height (cm)	Pol	Azimuth (deg)	Corr. (dB/m)
1727.000000	41.45	74.00	32.55	150.0	V	180.0	-6.22
3076.000000	48.83	74.00	25.17	150.0	V	300.0	1.53
4393.000000	50.55	74.00	23.45	150.0	V	96.0	3.44
7822.500000	39.12	74.00	34.88	150.0	V	0.0	7.22
10866.500000	42.76	74.00	31.24	150.0	V	253.0	10.78
12884.500000	42.96	74.00	31.04	150.0	V	156.0	12.93

BLE_1M_Middle Channel:

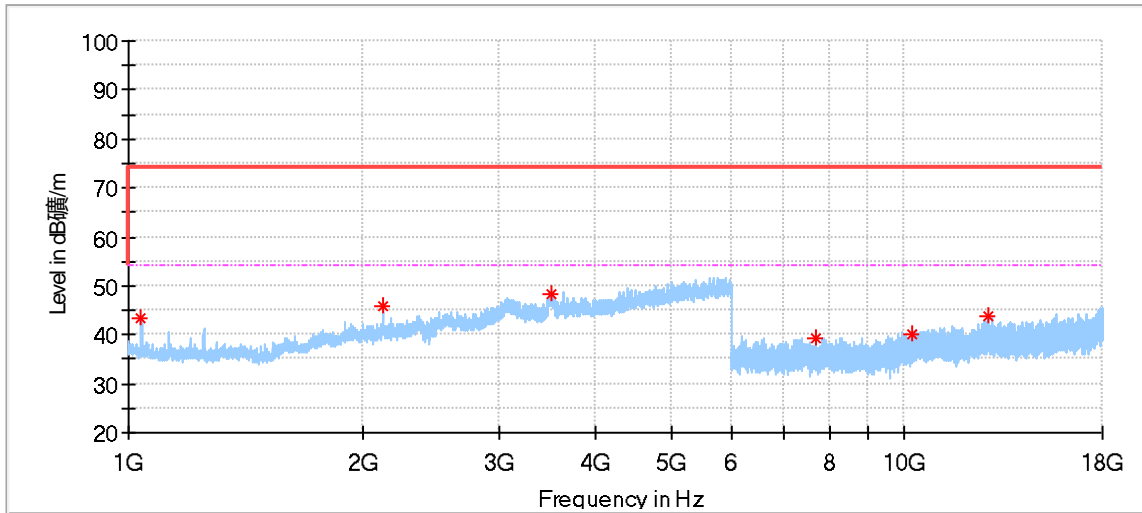

Frequency (MHz)	MaxPeak (dBµV/m)	Limit (dBµV/m)	Margin (dB)	Height (cm)	Pol	Azimuth (deg)	Corr. (dB/m)
1039.000000	43.19	74.00	30.81	150.0	H	198.0	-8.22
2129.000000	46.02	74.00	27.98	150.0	H	300.0	-3.62
3501.500000	48.45	74.00	25.55	150.0	H	95.0	4.41
7670.000000	39.36	74.00	34.64	150.0	H	306.0	7.04
10239.500000	40.19	74.00	33.81	150.0	H	179.0	9.73
12841.500000	43.65	74.00	30.35	150.0	H	179.0	12.95

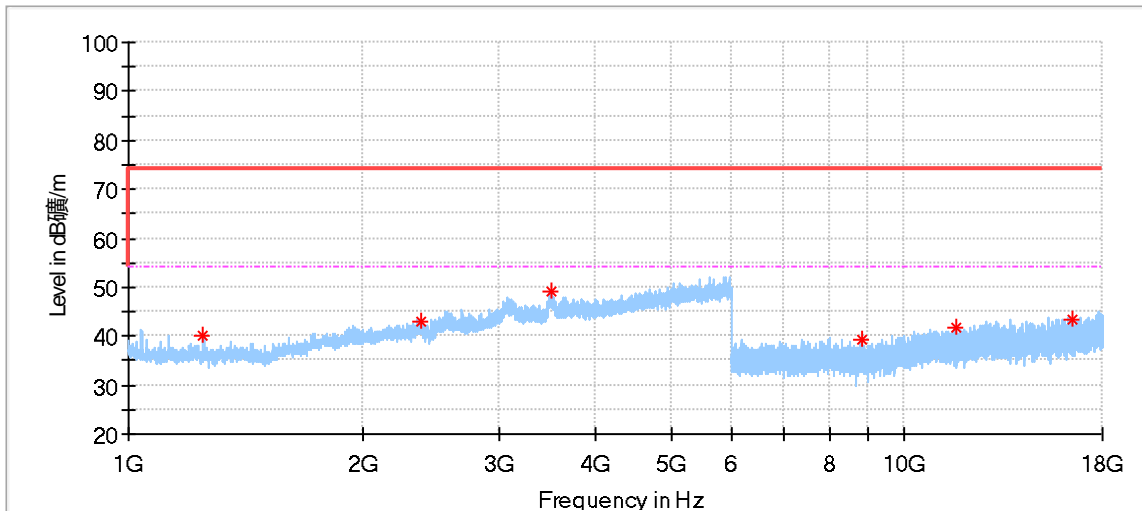

Frequency (MHz)	MaxPeak (dBµV/m)	Limit (dBµV/m)	Margin (dB)	Height (cm)	Pol	Azimuth (deg)	Corr. (dB/m)
1249.500000	40.17	74.00	33.83	150.0	V	13.0	-8.87
2378.000000	42.86	74.00	31.14	150.0	V	144.0	-2.55
3502.000000	48.96	74.00	25.04	150.0	V	120.0	4.39
8827.500000	39.10	74.00	34.90	150.0	V	205.0	7.88
11651.500000	41.57	74.00	32.43	150.0	V	253.0	11.24
16462.500000	43.20	74.00	30.80	150.0	V	131.0	17.20

BLE_1M_Highest Channel:

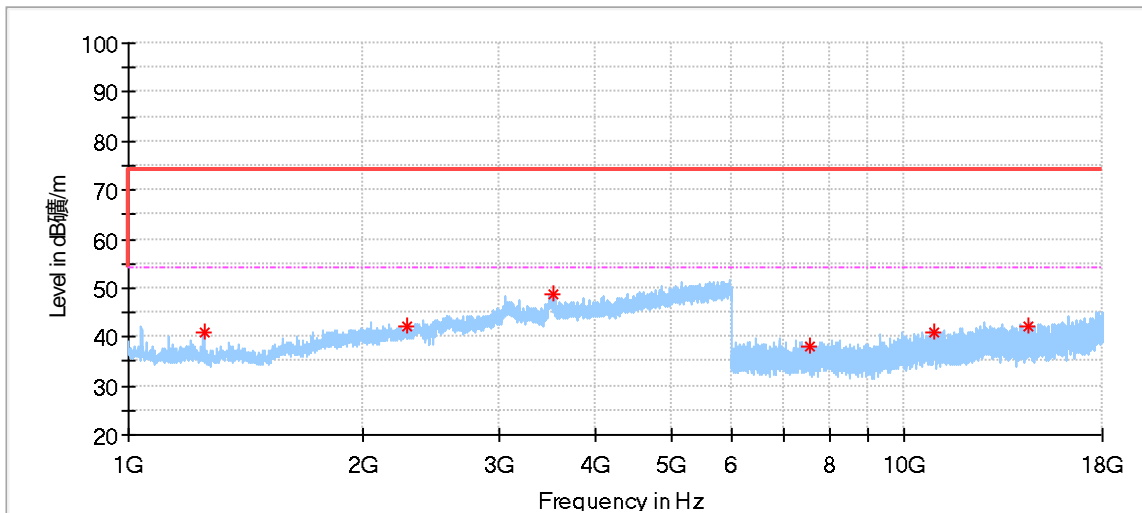

Frequency (MHz)	MaxPeak (dBµV/m)	Limit (dBµV/m)	Margin (dB)	Height (cm)	Pol	Azimuth (deg)	Corr. (dB/m)
1250.000000	41.00	74.00	33.00	150.0	H	252.0	-8.87
2284.000000	42.28	74.00	31.72	150.0	H	283.0	-3.34
3529.000000	48.66	74.00	25.34	150.0	H	283.0	3.02
7563.000000	38.11	74.00	35.89	150.0	H	309.0	6.89
10892.500000	40.76	74.00	33.24	150.0	H	356.0	10.85
14449.000000	42.28	74.00	31.72	150.0	H	201.0	13.34

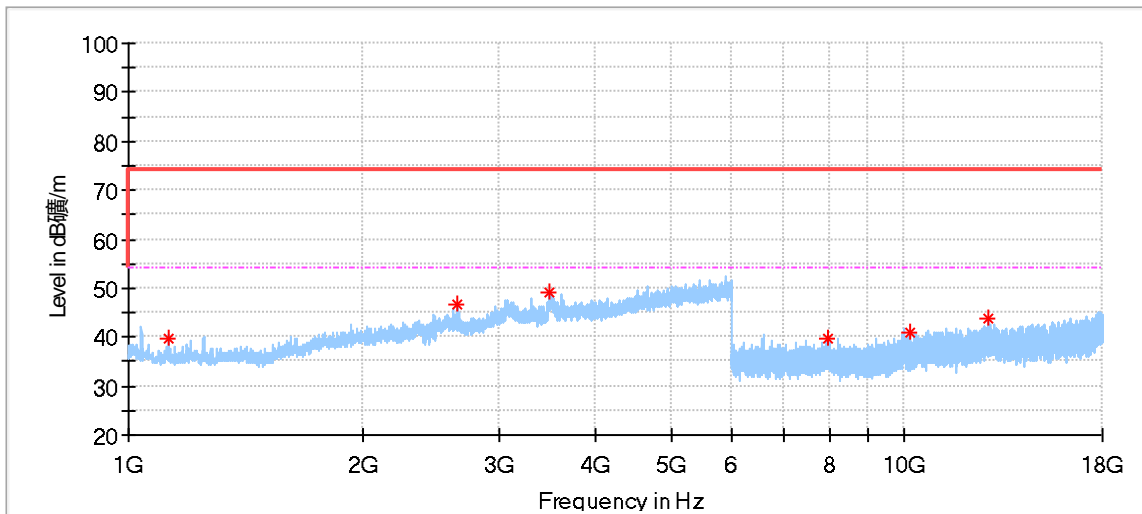

Frequency (MHz)	MaxPeak (dBµV/m)	Limit (dBµV/m)	Margin (dB)	Height (cm)	Pol	Azimuth (deg)	Corr. (dB/m)
1124.500000	39.88	74.00	34.12	150.0	V	108.0	-8.88
2659.500000	46.83	74.00	27.17	150.0	V	168.0	-1.48
3494.000000	48.95	74.00	25.05	150.0	V	144.0	4.03
7960.500000	39.56	74.00	34.44	150.0	V	149.0	7.34
10163.500000	41.11	74.00	32.89	150.0	V	100.0	9.62
12833.000000	43.78	74.00	30.22	150.0	V	249.0	12.96

BLE_2M_Low Channel:

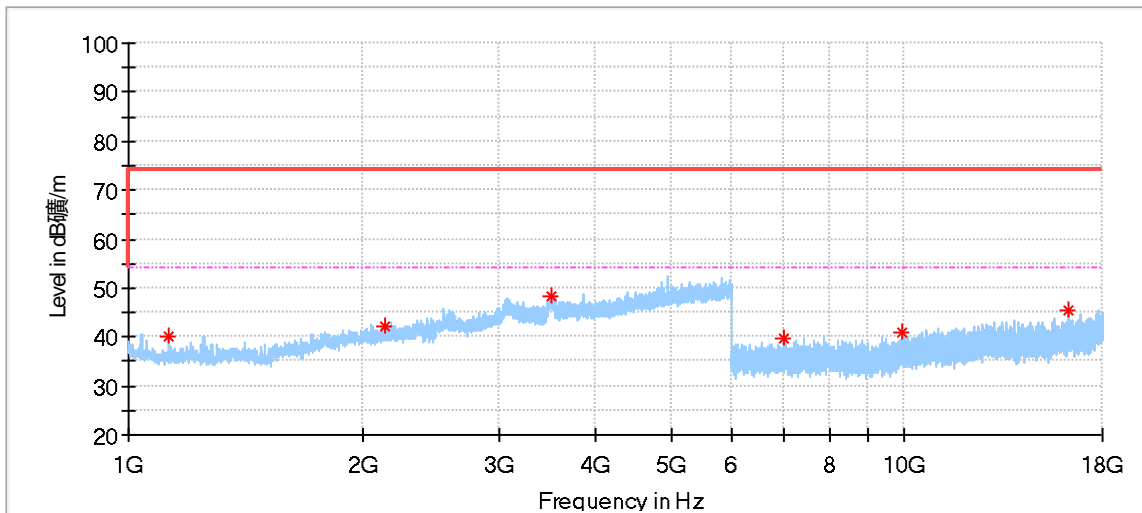

Frequency (MHz)	MaxPeak (dBµV/m)	Limit (dBµV/m)	Margin (dB)	Height (cm)	Pol	Azimuth (deg)	Corr. (dB/m)
1125.000000	40.19	74.00	33.81	150.0	H	358.0	-8.88
2147.000000	42.24	74.00	31.76	150.0	H	198.0	-3.60
3497.500000	48.42	74.00	25.58	150.0	H	85.0	4.29
6992.000000	39.50	74.00	34.50	150.0	H	99.0	6.28
9936.500000	40.89	74.00	33.11	150.0	H	287.0	9.40
16294.000000	45.33	74.00	28.67	150.0	H	183.0	16.80

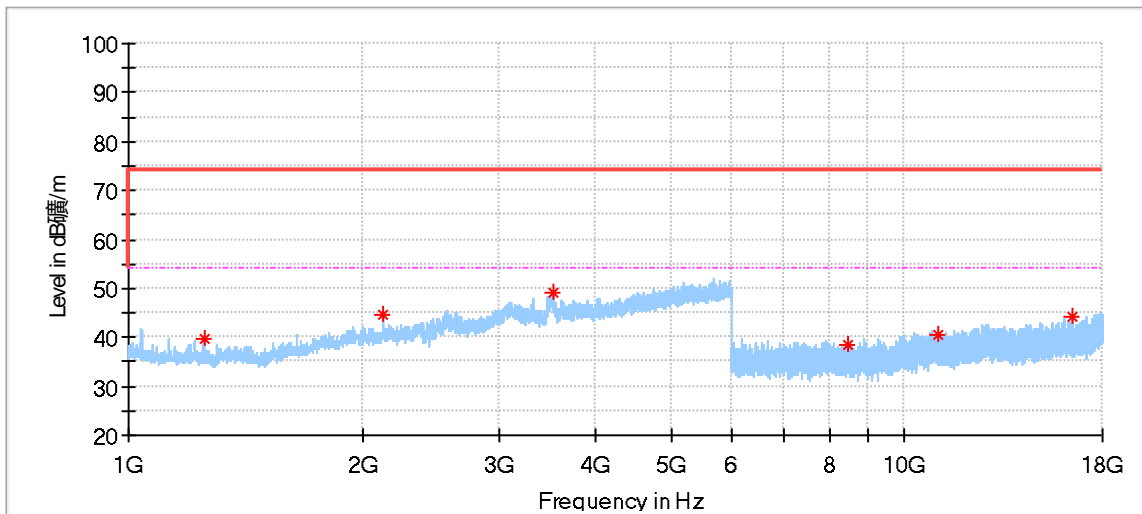

Frequency (MHz)	MaxPeak (dBµV/m)	Limit (dBµV/m)	Margin (dB)	Height (cm)	Pol	Azimuth (deg)	Corr. (dB/m)
1250.000000	39.62	74.00	34.38	150.0	V	99.0	-8.87
2131.500000	44.59	74.00	29.41	150.0	V	207.0	-3.59
3520.500000	48.97	74.00	25.03	150.0	V	219.0	3.45
8477.500000	38.65	74.00	35.35	150.0	V	356.0	7.60
11023.000000	40.49	74.00	33.51	150.0	V	177.0	10.84
16485.500000	44.30	74.00	29.70	150.0	V	80.0	17.31

BLE_2M_Middle Channel:

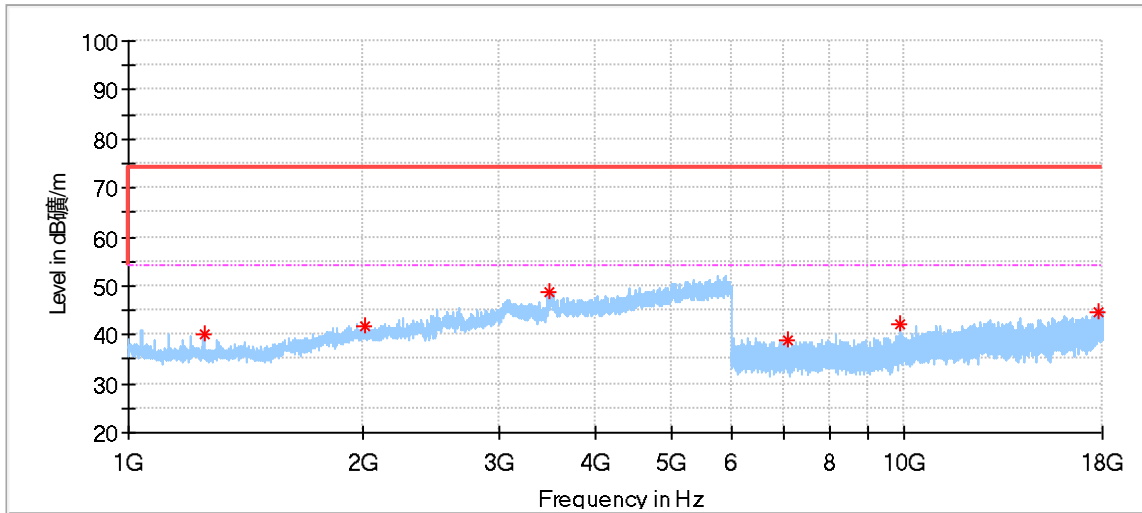

Frequency (MHz)	MaxPeak (dBµV/m)	Limit (dBµV/m)	Margin (dB)	Height (cm)	Pol	Azimuth (deg)	Corr. (dB/m)
1250.000000	40.30	74.00	33.70	150.0	H	210.0	-8.87
2016.500000	41.91	74.00	32.09	150.0	H	313.0	-4.02
3489.500000	48.69	74.00	25.31	150.0	H	4.0	3.68
7073.000000	38.87	74.00	35.13	150.0	H	73.0	6.45
9882.500000	42.23	74.00	31.77	150.0	H	332.0	9.37
17788.000000	44.64	74.00	29.36	150.0	H	31.0	19.84

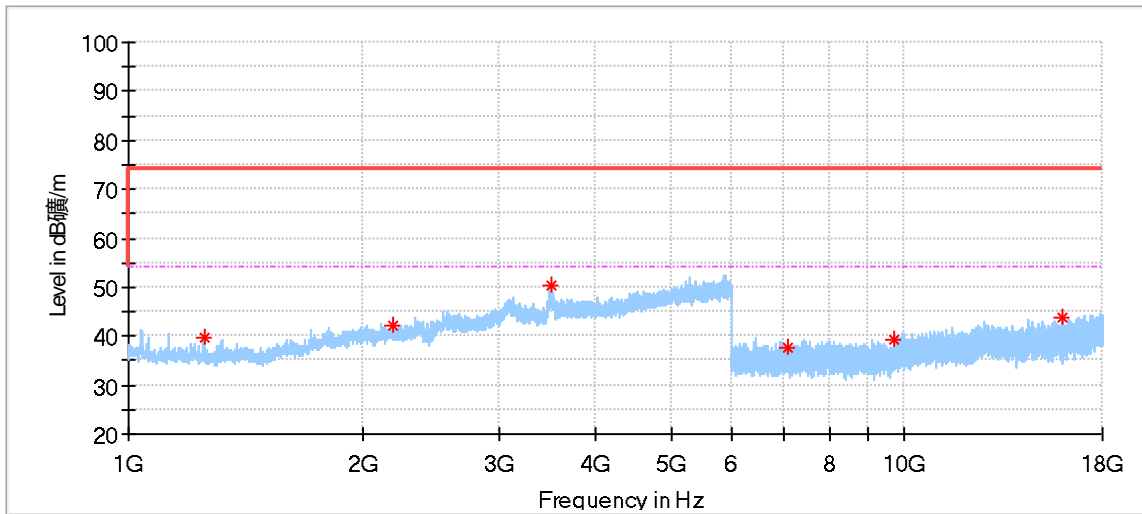

Frequency (MHz)	MaxPeak (dBµV/m)	Limit (dBµV/m)	Margin (dB)	Height (cm)	Pol	Azimuth (deg)	Corr. (dB/m)
1250.000000	39.71	74.00	34.29	150.0	V	168.0	-8.87
2195.500000	42.15	74.00	31.85	150.0	V	309.0	-3.60
3509.000000	50.50	74.00	23.50	150.0	V	240.0	4.03
7085.000000	37.50	74.00	36.50	150.0	V	52.0	6.46
9690.500000	39.27	74.00	34.73	150.0	V	301.0	9.00
15997.500000	43.63	74.00	30.37	150.0	V	327.0	16.26

BLE_2M_Highest Channel:

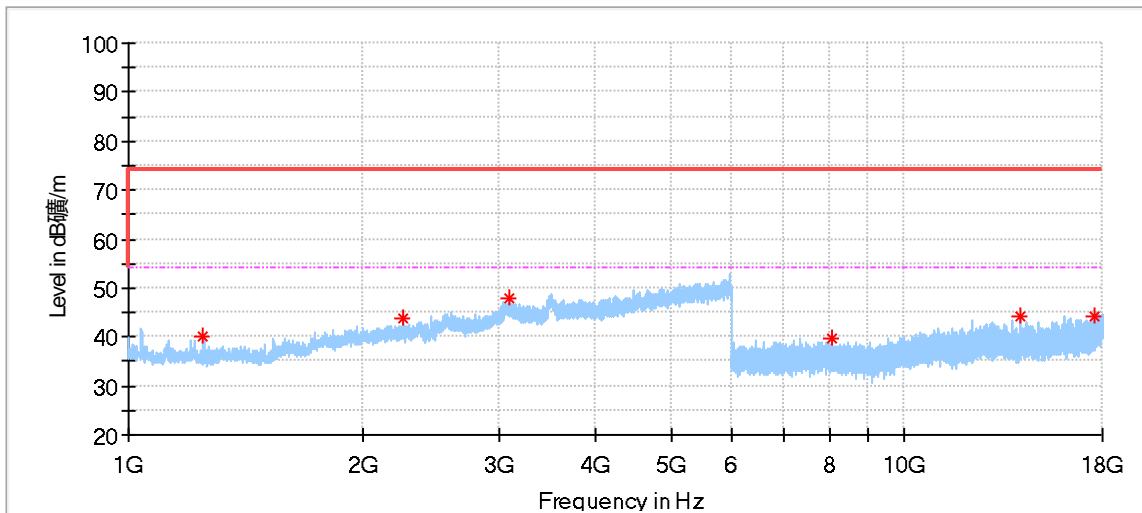

Frequency (MHz)	MaxPeak (dBµV/m)	Limit (dBµV/m)	Margin (dB)	Height (cm)	Pol	Azimuth (deg)	Corr. (dB/m)
1249.500000	40.05	74.00	33.95	150.0	H	202.0	-8.87
2254.000000	43.73	74.00	30.27	150.0	H	67.0	-3.31
3088.500000	47.89	74.00	26.11	150.0	H	77.0	1.58
8058.000000	39.50	74.00	34.50	150.0	H	28.0	7.49
14090.000000	44.17	74.00	29.83	150.0	H	240.0	12.70
17597.500000	44.27	74.00	29.73	150.0	H	198.0	19.45

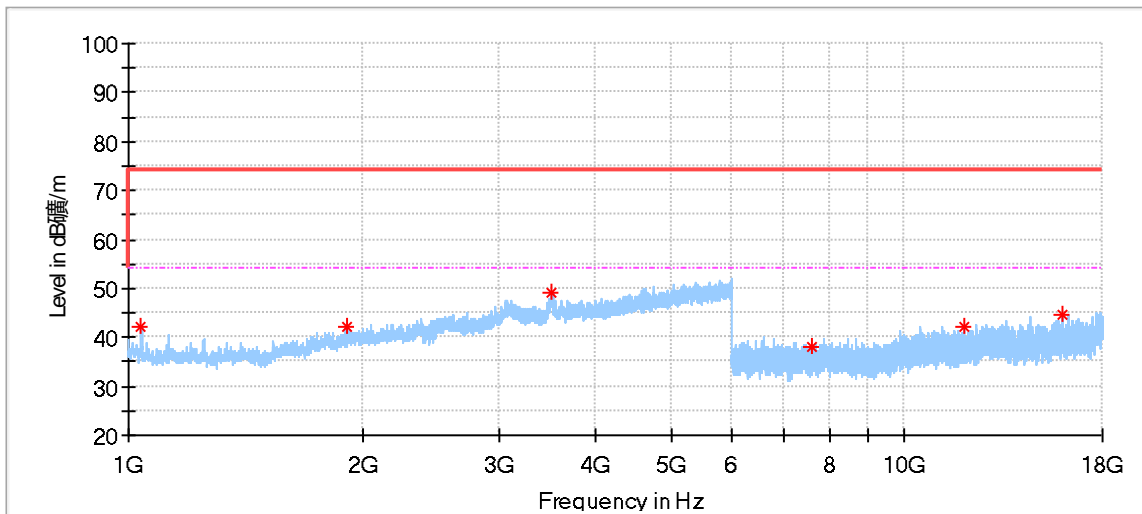

Frequency (MHz)	MaxPeak (dBµV/m)	Limit (dBµV/m)	Margin (dB)	Height (cm)	Pol	Azimuth (deg)	Corr. (dB/m)
1039.000000	42.23	74.00	31.77	150.0	V	192.0	-8.22
1911.500000	42.12	74.00	31.88	150.0	V	120.0	-4.62
3516.000000	49.15	74.00	24.85	150.0	V	276.0	3.68
7615.000000	37.89	74.00	36.11	150.0	V	350.0	6.87
11928.000000	42.06	74.00	31.94	150.0	V	4.0	11.54
16018.500000	44.44	74.00	29.56	150.0	V	350.0	16.30

Remark:

- (1) "*" means the emission(s) appear within the restrict bands shall follow the requirement of section 15.205.
- (2) Data of measurement within frequency range 9kHz-30MHz, 18-26GHz are the noise floor or attenuated more than 20dB below the permissible limits or the field strength is too small to be measured, so test data does not present in this report.
- (3) Corrected Amplitude = Read level + Corrector factor
 Above 1GHz: Corrector factor = Antenna Factor + Cable Loss- Amplifier Gain
 Below 1GHz: Corrector factor = Antenna Factor + Cable Loss

10 Test Equipment List

List of Test Instruments

Conducted Emission 2# Test

DESCRIPTION	MANUFACTURER	MODEL NO.	EQUIPMENT ID	SERIAL NO.	CAL INTERVAL (YEAR)	CAL. DUE DATE
EMI Test Receiver	Rohde & Schwarz	ESR 3	68-4-74-19-002	102590	1	2024-5-19
LISN	Rohde & Schwarz	ENV216	68-4-87-19-001	102472	1	2024-5-20
Attenuator	Shanghai Huaxiang	TS2-26-3	68-4-81-16-003	080928189	1	2024-5-19
Test software	Rohde & Schwarz	EMC32	68-4-90-19-005-A01	Version10.35.02	N/A	N/A
Shielding Room	TDK	CSR #2	68-4-90-19-005	----	3	2025-10-15

Radiated Emission Test 1# Test

DESCRIPTION	MANUFACTURER	MODEL NO.	EQUIPMENT ID	SERIAL NO.	CAL INTERVAL (YEAR)	CAL. DUE DATE
EMI Test Receiver	Rohde & Schwarz	ESR 7	68-4-74-19-001	102176	1	2024-5-20
Loop Antenna	Rohde & Schwarz	HFH2-Z2	68-4-80-14-006	100398	1	2024-8-7
3m Semi-anechoic chamber	TDK	SAC-3 #1	68-4-90-14-001	----	3	2024-5-28
Test software	Rohde & Schwarz	EMC32	68-4-90-14-001-A10	Version10.35.02	N/A	N/A

Radiated Emission 2# Test

DESCRIPTION	MANUFACTURER	MODEL NO.	EQUIPMENT ID	SERIAL NO.	CAL INTERVAL (YEAR)	CAL. DUE DATE
EMI Test Receiver	Rohde & Schwarz	ESR 26	68-4-74-14-002	101269	1	2024-5-20
Trilog Super Broadband Test Antenna	Schwarzbeck	VULB 9162	68-4-80-19-003	284	1	2024-3-5
Wave Guide Antenna	ETS	3117	68-4-80-19-001	00218954	1	2024-4-26
Pre-amplifier	Rohde & Schwarz	SCU 18F	68-4-29-19-001	100745	1	2024-5-19
Sideband Horn Antenna	Q-PAR	QWH-SL-18-40-K-SG	68-4-80-14-008	12827	1	2024-7-11
Pre-amplifier	Rohde & Schwarz	SCU 40A	68-4-29-14-002	100432	1	2024-8-1
Attenuator	Mini-circuits	UNAT-6+	68-4-81-21-002	15542	1	2024-5-19
3m Semi-anechoic chamber	TDK	SAC-3 #2	68-4-90-19-006	----	2	2024-5-28
Test software	Rohde & Schwarz	EMC32	68-4-90-19-006-A01	Version10.35.02	N/A	N/A

RF Conducted Test

Description	Manufacturer	Model no.	Equipment ID	Serial no.	Cal interval (year)	Cal. due date
Signal Analyzer	Rohde & Schwarz	FSV40	68-4-74-14-004	101030	1	2024-5-19
Test software	TST PASS	System for BT/WIFI	68-4-93-23-001-A03	Version 2.0	N/A	N/A
Shielding Room	TDK	TS8997	68-4-90-19-003	----	3	2025-10-15

11 System Measurement Uncertainty

For a 95% confidence level, the measurement expanded uncertainties for defined systems, in accordance with the recommendations of ISO 17025 were:

System Measurement Uncertainty	
Test Items	Extended Uncertainty
Uncertainty for Conducted Emission in new shielding room (68-4-90-19-005) 150kHz-30MHz (for test using AMN ENV216)	3.15dB
Uncertainty for Radiated Emission in 3m chamber (68-4-90-14-001) 9kHz-30MHz	4.70dB
Uncertainty for Radiated Emission in new 3m chamber (68-4-90-19-006) 30MHz-1000MHz	Horizontal: 4.63dB; Vertical: 4.78dB;
Uncertainty for Radiated Emission in new 3m chamber (68-4-90-19-006) 1000MHz-18000MHz	Horizontal: 5.38dB; Vertical: 5.38dB;
Uncertainty for Radiated Emission in new 3m chamber (68-4-90-19-006) 18GHz-40GHz	Horizontal: 5.29dB; Vertical: 5.29dB;
Uncertainty for Conducted RF test with TS 8997	RF Power Conducted: 1.31dB Frequency test involved: 0.6×10^{-8} or 1%

Measurement Uncertainty Decision Rule:

Determination of conformity with the specification limits is based on the decision rule according to IEC Guide 115: 2021, clause 4.4.3 and 4.5.1.

THE END