

FCC Test Report

Applicant : **GUANGDONG GOLOD TECHNOLOGY CO.,LTD**

Address : **(C60# factory) No.41 Dawang Avenue,
High-tech Zone, Zhaoqing, Guangdong,
526000, China**

Product Name : **Active speaker**

Report Date : **May 23, 2023**



Shenzhen Anbotek Compliance Laboratory Limited



Contents

1. General Information	6
1.1. Client Information	6
1.2. Description of Device (EUT)	6
1.3. Auxiliary Equipment Used During Test	7
1.4. Description of Test Configuration	7
1.5. Description Of Test Setup	8
1.6. Test Equipment List	9
1.7. Measurement Uncertainty	10
1.8. Description of Test Facility	10
2. Summary of Test Results	11
3. Conducted Emission Test	12
3.1. Test Standard and Limit	12
3.2. Test Setup	12
3.3. Test Procedure	12
3.4. Test Data	13
4. Radiation Spurious Emission and Band Edge	16
4.1. Test Standard and Limit	16
4.2. Test Setup	16
4.3. Test Procedure	17
4.4. Test Data	18
5. Maximum Peak Output Power Test	26
5.1. Test Standard and Limit	26
5.2. Test Setup	26
5.3. Test Procedure	26
5.4. Test Data	26
6. 20dB Occupy Bandwidth Test	27
6.1. Test Standard	27
6.2. Test Setup	27
6.3. Test Procedure	27
6.4. Test Data	27
7. Carrier Frequency Separation Test	28
7.1. Test Standard and Limit	28
7.2. Test Setup	28
7.3. Test Procedure	28
7.4. Test Data	28
8. Number of Hopping Channel Test	29
8.1. Test Standard and Limit	29



8.2. Test Setup	29
8.3. Test Procedure	29
8.4. Test Data	29
9. Dwell Time Test	30
9.1. Test Standard and Limit	30
9.2. Test Setup	30
9.3. Test Procedure	30
9.4. Test Data	30
10. 100kHz Bandwidth of Frequency Band Edge Requirement	31
10.1. Test Standard and Limit	31
10.2. Test Setup	31
10.3. Test Procedure	31
10.4. Test Data	31
11. Antenna Requirement	32
11.1. Test Standard and Requirement	32
11.2. Antenna Connected Construction	32
APPENDIX I -- TEST SETUP PHOTOGRAPH	33
APPENDIX II -- EXTERNAL PHOTOGRAPH	33
APPENDIX III -- INTERNAL PHOTOGRAPH	33



TEST REPORT

Applicant : GUANGDONG GOLOD TECHNOLOGY CO.,LTD
Manufacturer : GUANGDONG GOLOD TECHNOLOGY CO.,LTD
Product Name : Active speaker
Model No. : PSUFM1043BT, PSUFM1280B, PSUFM1288B, HDV-8015, HDV-8215,
MPD15TS, DM-2605, DM-2606, DM-2805, DM-2806, DM-2807, DM-2807,
DM-2808, DM-2810, DM-2815, DM-2085, DM-2105, DM-2210, DM-5012,
PM-5012, PM-5015
Trade Mark : N/A
Rating(s) : Input: AC 110~120V, 60Hz
Test Standard(s) : **FCC Part15 Subpart C, Section 15.247**
Test Method(s) : **ANSI C63.10: 2020**

The device described above is tested by Shenzhen Anbotek Compliance Laboratory Limited to determine the maximum emission levels emanating from the device and the severe levels of the device can endure and its performance criterion. The measurement results are contained in this test report and Shenzhen Anbotek Compliance Laboratory Limited is assumed full of responsibility for the accuracy and completeness of these measurements. Also, this report shows that the EUT (Equipment Under Test) is technically compliant with the FCC Part 15 Subpart C requirements.

This report applies to above tested sample only and shall not be reproduced in part without written approval of Shenzhen Anbotek Compliance Laboratory Limited.

Date of receipt

May 09, 2023

Date of Test

May 09 ~ 18, 2023

Prepared by

Nian Xiu Chen

(Nianxiu Chen)

Approved & Authorized Signer

Kingkong Jin

(Kingkong Jin)



Revision History

Report Version	Description	Issued Date
R00	Original Issue.	May 23, 2023



1. General Information

1.1. Client Information

Applicant	:	GUANGDONG GOLOD TECHNOLOGY CO.,LTD
Address	:	(C60# factory) No.41 Dawang Avenue, High-tech Zone, Zhaoqing, Guangdong, 526000, China
Manufacturer	:	GUANGDONG GOLOD TECHNOLOGY CO.,LTD
Address	:	(C60# factory) No.41 Dawang Avenue, High-tech Zone, Zhaoqing, Guangdong, 526000, China
Factory	:	DBL Electronics (Guangzhou) Co., Ltd
Address	:	No.3 Yuanxia Industrial park Longgui Town, Baiyun District Guangzhou, China 510445

1.2. Description of Device (EUT)

Product Name	:	Active speaker
Model No.	:	PSUFM1043BT, PSUFM1280B, PSUFM1288B, HDV-8015, HDV-8215, MPD15TS, DM-2605, DM-2606, DM-2805, DM-2806, DM-2807, DM-2807, DM-2808, DM-2810, DM-2815, DM-2085, DM-2105, DM-2210, DM-5012, PM-5012, PM-5015 (Note: All samples are the same except the model number, appearance and size, so we prepare "PSUFM1043BT" for test only.)
Trade Mark	:	N/A
Test Power Supply	:	AC 120, 60Hz
Test Sample No.	:	1-2-1(Normal Sample), 1-2-2(Engineering Sample)
Adapter	:	N/A
RF Specification		
Operation Mode	:	<input checked="" type="checkbox"/> BT BDR <input checked="" type="checkbox"/> BT EDR
Operation Frequency	:	2402~2480MHz
Number of Channel	:	79 Channels
Modulation Type	:	GFSK, $\pi/4$ -DQPSK
Antenna Type	:	PCB Antenna
Antenna Gain(Peak)	:	2.5 dBi (Provided by customer)
Remark: 1) For a more detailed features description, please refer to the manufacturer's specifications or the User's Manual.		



1.3. Auxiliary Equipment Used During Test

Description	Rating(s)
--	--

1.4. Description of Test Configuration

Channel	Freq. (MHz)	Channel	Freq. (MHz)	Channel	Freq. (MHz)	Channel	Freq. (MHz)	Channel	Freq. (MHz)
00	2402	17	2419	34	2436	51	2453	68	2470
01	2403	18	2420	35	2437	52	2454	69	2471
02	2404	19	2421	36	2438	53	2455	70	2472
03	2405	20	2422	37	2439	54	2456	71	2473
04	2406	21	2423	38	2440	55	2457	72	2474
05	2407	22	2424	39	2441	56	2458	73	2475
06	2408	23	2425	40	2442	57	2459	74	2476
07	2409	24	2426	41	2443	58	2460	75	2477
08	2410	25	2427	42	2444	59	2461	76	2478
09	2411	26	2428	43	2445	60	2462	77	2479
10	2412	27	2429	44	2446	61	2463	78	2480
11	2413	28	2430	45	2447	62	2464		
12	2414	29	2431	46	2448	63	2465		
13	2415	30	2432	47	2449	64	2466		
14	2416	31	2433	48	2450	65	2467		
15	2417	32	2434	49	2451	66	2468		
16	2418	33	2435	50	2452	67	2469		

Note:

1. The engineering test program was provided and the EUT was programmed to be in continuously transmitting mode.
2. EUT was tested with channel 0, 39 and 78.



1.5. Description Of Test Setup

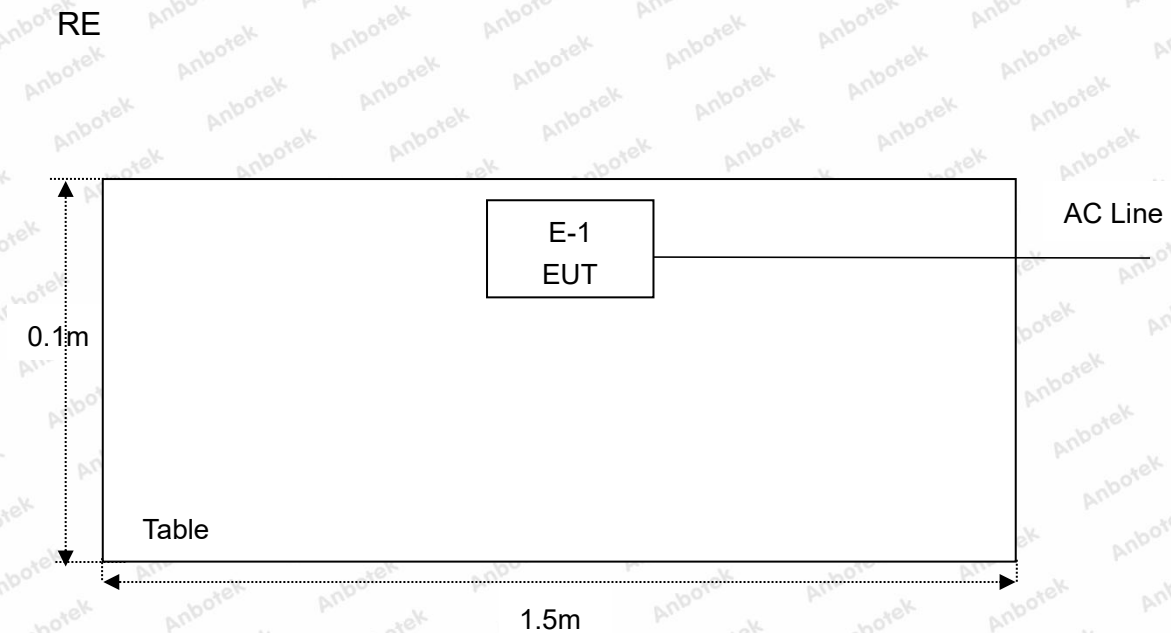
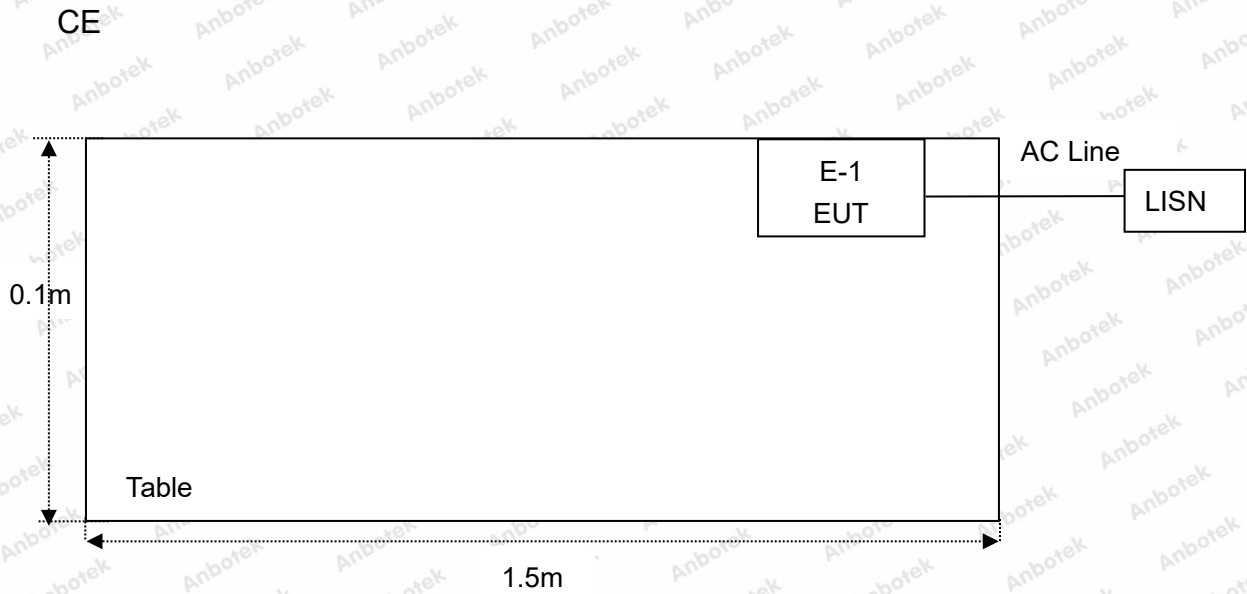

1.6. Test Equipment List

Item	Equipment	Manufacturer	Model No.	Serial No.	Last Cal.	Cal. Interval
1.	L.I.S.N. Artificial Mains Network	Rohde & Schwarz	ENV216	100055	Oct. 23, 2022	1 Year
2.	Three Phase V-type Artificial Power Network	CYBERTEK	EM5040DT	E215040DT001	Jul. 05, 2022	1 Year
3.	EMI Test Receiver	Rohde & Schwarz	ESCI	100627	Oct. 13, 2022	1 Year
4.	EMI Test Receiver	Rohde & Schwarz	ESR26	101481	Oct. 23, 2022	1 Year
5.	RF Switching Unit	Compliance Direction	RSU-M2	38303	Oct. 22, 2022	1 Year
6.	MXA Spectrum Analysis	Agilent	N9020A	MY51170037	Oct. 13, 2022	1 Year
7.	EMI Preamplifier	SKET Electronic	LNPA-0118G-45	SKET-PA-002	Oct. 13, 2022	1 Year
8.	Double Ridged Horn Antenna	SCHWARZBECK	BBHA 9120D	02555	Oct. 16, 2022	3 Year
9.	Bilog Broadband Antenna	Schwarzbeck	VULB9163	VULB 9163-289	Oct. 23, 2022	1 Year
10.	Loop Antenna	Schwarzbeck	FMZB1519B	00053	Oct. 23, 2022	1 Year
11.	Horn Antenna	A-INFO	LB-180400-KF	J211060628	Oct. 23, 2022	1 Year
12.	Pre-amplifier	SONOMA	310N	186860	Oct. 23, 2022	1 Year
13.	EMI Test Software EZ-EMC	SHURPLE	N/A	N/A	N/A	N/A
14.	MXA Spectrum Analysis	KEYSIGHT	N9020A	MY53280032	Oct. 13, 2022	1 Year
15.	MXG RF Vector Signal Generator	Agilent	N5182A	MY48180656	Oct. 13, 2022	1 Year
16.	Signal Generator	Agilent	E4421B	MY41000743	Oct. 13, 2022	1 Year
17.	DC Power Supply	IVYTECH	IV3605	1804D360510	Oct. 22, 2022	1 Year
18.	Constant Temperature Humidity Chamber	ZHONGJIAN	ZJ-KHWS80B	N/A	Oct. 19, 2022	1 Year
19.	Power Meter	Agilent	N1914A	MY50001102	Oct.26, 2022	1 Year



1.7. Measurement Uncertainty

Radiation Uncertainty	:	Ur = 3.9 dB (Horizontal)
	:	Ur = 3.8 dB (Vertical)
Conduction Uncertainty	:	Uc = 3.4 dB

1.8. Description of Test Facility

The test facility is recognized, certified, or accredited by the following organizations:

FCC-Registration No.: 184111

Shenzhen Anbotek Compliance Laboratory Limited, EMC Laboratory has been registered and fully described in a report filed with the (FCC) Federal Communications Commission. The acceptance letter from the FCC is maintained in our files. Registration No. 184111.

ISED-Registration No.: 8058A

Shenzhen Anbotek Compliance Laboratory Limited, EMC Laboratory has been registered and fully described in a report filed with the (ISED) Innovation, Science and Economic Development Canada. The acceptance letter from the ISED is maintained in our files. Registration 8058A.

Test Location

Shenzhen Anbotek Compliance Laboratory Limited.

1/F, Building D, Sogood Science and Technology Park, Sanwei community, Hangcheng Street, Bao'an District, Shenzhen, Guangdong, China.518102



2. Summary of Test Results

Standard Section	Test Item	Result
15.203/15.247(c)	Antenna Requirement	PASS
15.207	Conducted Emission	PASS
15.205/15.209	Spurious Emission	PASS
15.247(b)(1)	Conducted Peak Output Power	PASS
15.247(a)(1)	20dB Occupied Bandwidth	PASS
15.247(a)(1)	Carrier Frequencies Separation	PASS
15.247(a)(1)(iii)	Number of Hopping Channel	PASS
15.247(a)(1)(iii)	Dwell Time	PASS
15.247(d)	Band Edge	PASS
Remark: "N/A" is an abbreviation for Not Applicable.		



3. Conducted Emission Test

3.1. Test Standard and Limit

Test Standard	FCC Part15 Section 15.207		
Test Limit	Frequency	Maximum RF Line Voltage (dBuV)	
		Quasi-peak Level	Average Level
	150kHz~500kHz	66 ~ 56 *	56 ~ 46 *
	500kHz~5MHz	56	46
	5MHz~30MHz	60	50

Remark: (1) *Decreasing linearly with logarithm of the frequency.
 (2) The lower limit shall apply at the transition frequency.

3.2. Test Setup

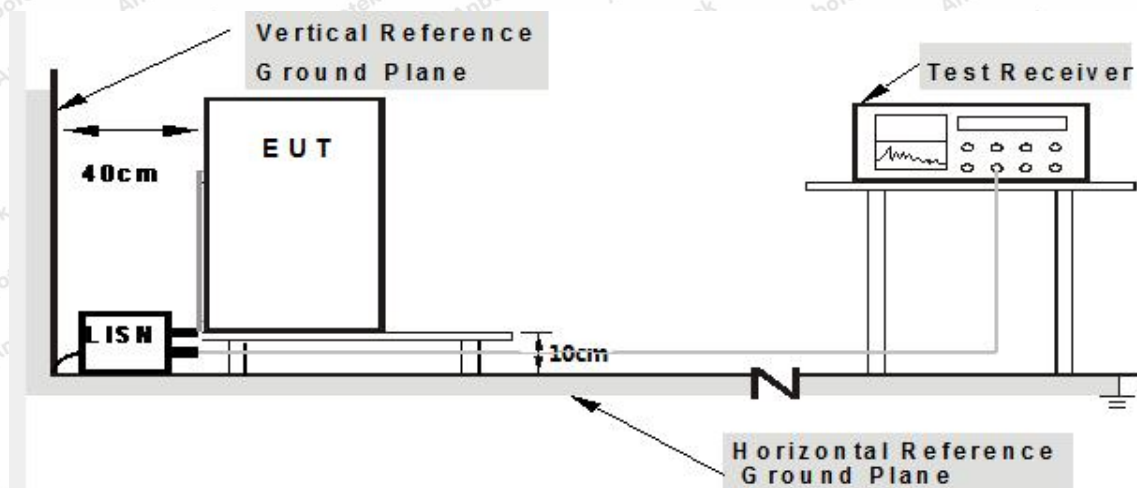

- Note:**
- 1.Support units were connected to second LISN.
 - 2.Both of LISNs (AMN) are 80 cm from EUT and at least 80 from other units and other metal planes

3.3. Test Procedure

The EUT system is connected to the power mains through a line impedance stabilization network (L.I.S.N.). This provides a 50ohm coupling impedance for the EUT system. Please refer the block diagram of the test setup and photographs. Both sides of AC line are checked to find out the maximum conducted emission. In order to find the maximum emission levels, the relative positions of equipment and all of the interface cables shall be changed according to FCC ANSI C63.10: 2020 on Conducted Emission Measurement.

The bandwidth of test receiver (ESCI) set at 9kHz.

The frequency range from 150kHz to 30MHz is checked.



3.4. Test Data

PASS

During the test, pre-scan all modes, only the worst case is recorded in the report.

AC conducted emission pre-test at both at AC 120V/60Hz and AC 240V/60Hz modes, recorded worst case AC 120V/60Hz.

Please to see the following pages.



Conducted Emission Test Data

Test Site: 1# Shielded Room
 Operating Condition: GFSK (2402MHz)
 Test Specification: AC 120V, 60Hz
 Comment: Live Line
 Temp.(°C)/Hum.(%RH): 28°C/51%RH

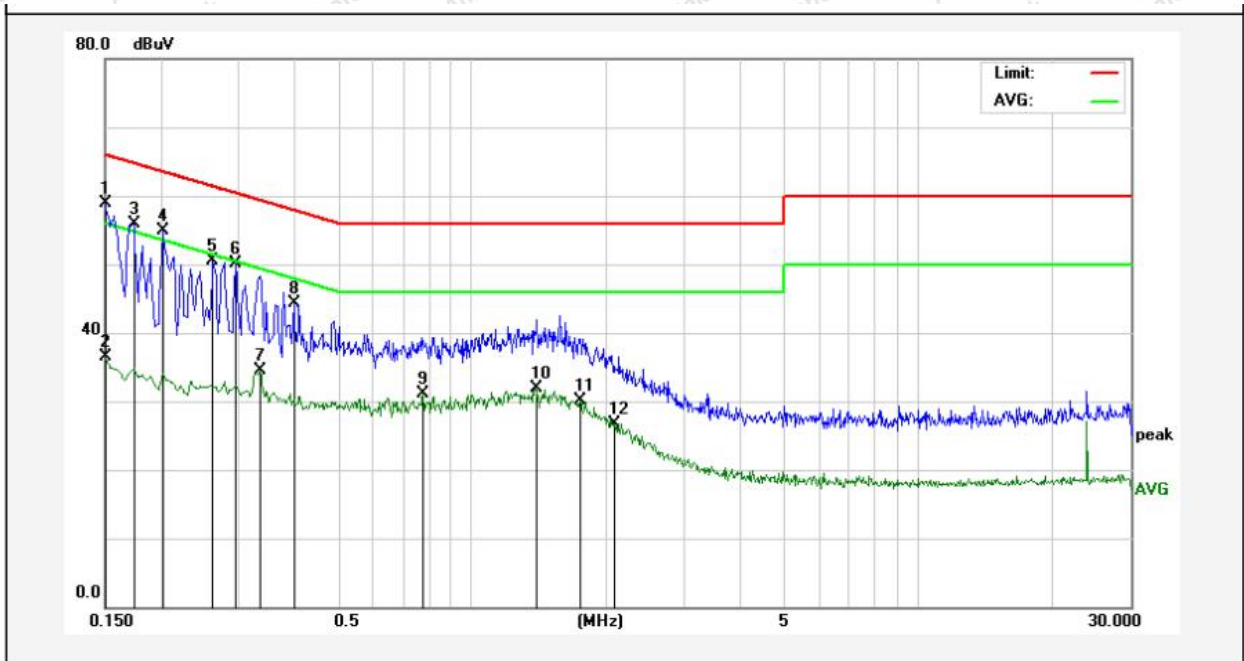

No.	Freq. (MHz)	Reading (dBuV)	Factor (dB)	Result (dBuV)	Limit (dBuV)	Over Limit (dB)	Detector	Remark
1	0.1500	49.04	9.82	58.86	65.99	-7.13	QP	
2	0.1500	26.63	9.82	36.45	55.99	-19.54	AVG	
3	0.1740	46.03	9.83	55.86	64.76	-8.90	QP	
4	0.2020	45.09	9.82	54.91	63.52	-8.61	QP	
5	0.2620	40.75	9.84	50.59	61.36	-10.77	QP	
6	0.2940	40.20	9.84	50.04	60.41	-10.37	QP	
7	0.3339	24.65	9.83	34.48	49.35	-14.87	AVG	
8	0.3980	34.59	9.81	44.40	57.89	-13.49	QP	
9	0.7780	21.15	9.87	31.02	46.00	-14.98	AVG	
10	1.3860	22.11	9.86	31.97	46.00	-14.03	AVG	
11	1.7500	20.24	9.86	30.10	46.00	-15.90	AVG	
12	2.0860	16.93	9.85	26.78	46.00	-19.22	AVG	

Note: Result = Reading + Factor Over Limit = Result - Limit



Conducted Emission Test Data

Test Site: 1# Shielded Room
 Operating Condition: GFSK (2402MHz)
 Test Specification: AC 120V, 60Hz
 Comment: Neutral Line
 Temp.(°C)/Hum.(%RH): 28°C/51%RH

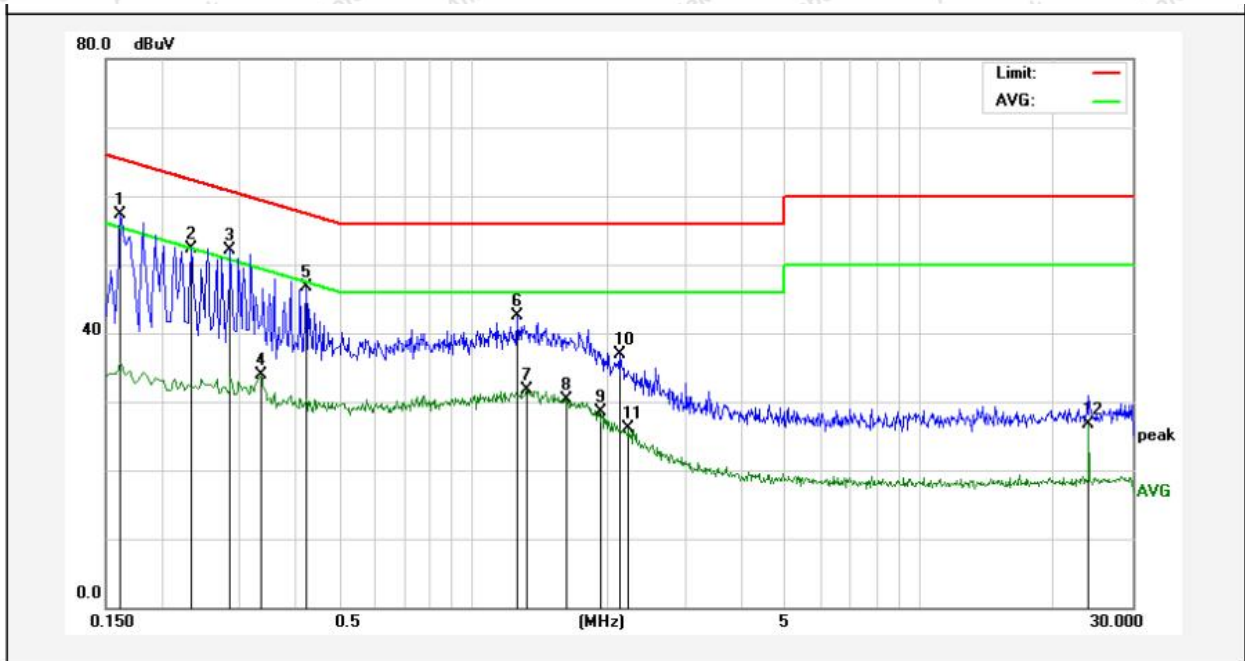

No.	Freq. (MHz)	Reading (dBuV)	Factor (dB)	Result (dBuV)	Limit (dBuV)	Over Limit (dB)	Detector	Remark
1	0.1620	47.44	9.83	57.27	65.36	-8.09	QP	
2	0.2340	42.58	9.82	52.40	62.30	-9.90	QP	
3	0.2860	42.36	9.84	52.20	60.64	-8.44	QP	
4	0.3339	24.00	9.83	33.83	49.35	-15.52	AVG	
5	0.4220	36.82	9.82	46.64	57.41	-10.77	QP	
6	1.2500	32.71	9.85	42.56	56.00	-13.44	QP	
7	1.3220	21.77	9.86	31.63	46.00	-14.37	AVG	
8	1.6260	20.44	9.85	30.29	46.00	-15.71	AVG	
9	1.9260	18.59	9.85	28.44	46.00	-17.56	AVG	
10	2.1380	26.97	9.85	36.82	56.00	-19.18	QP	
11	2.2260	16.29	9.85	26.14	46.00	-19.86	AVG	
12	24.0020	16.30	10.45	26.75	50.00	-23.25	AVG	

Note: Result = Reading + Factor Over Limit = Result - Limit



4. Radiation Spurious Emission and Band Edge

4.1. Test Standard and Limit

Test Standard	FCC Part15 C Section 15.209 and 15.205				
Test Limit	Frequency (MHz)	Field strength (microvolt/meter)	Limit (dBuV/m)	Remark	Measurement distance (m)
	0.009MHz~0.490MHz	2400/F(kHz)	-	-	300
	0.490MHz-1.705MHz	24000/F(kHz)	-	-	30
	1.705MHz-30MHz	30	-	-	30
	30MHz~88MHz	100	40.0	Quasi-peak	3
	88MHz~216MHz	150	43.5	Quasi-peak	3
	216MHz~960MHz	200	46.0	Quasi-peak	3
	960MHz~1000MHz	500	54.0	Quasi-peak	3
	Above 1000MHz	500	54.0	Average	3
-		74.0	Peak	3	

Remark:

(1)The lower limit shall apply at the transition frequency.

(2) 15.35(b), Unless otherwise specified, the limit on peak radio frequency emissions is 20dB above the maximum permitted average emission limit applicable to the equipment under test. This peak limit applies to the total peak emission level radiated by the device.

4.2. Test Setup

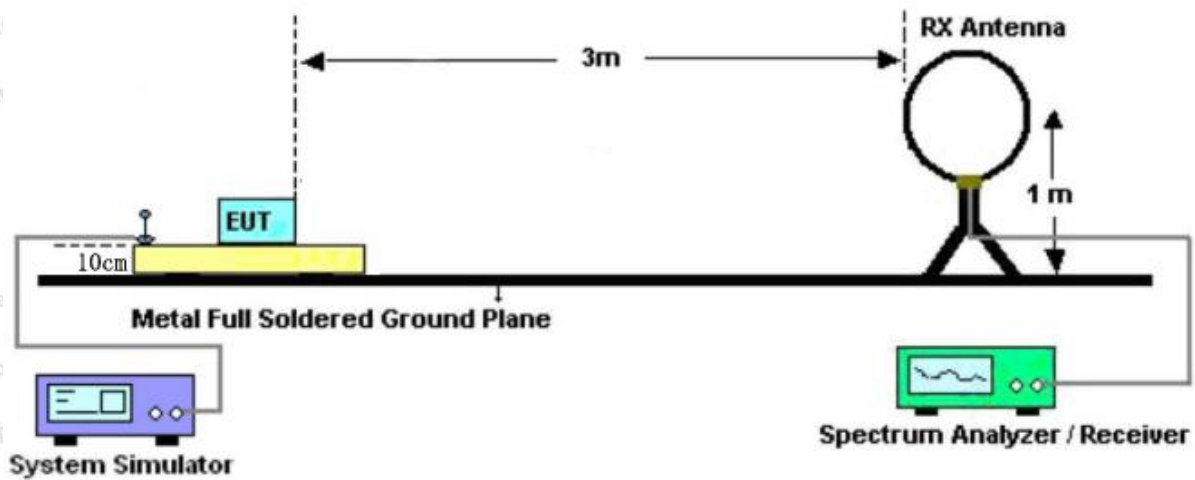

Figure 1. Below 30MHz



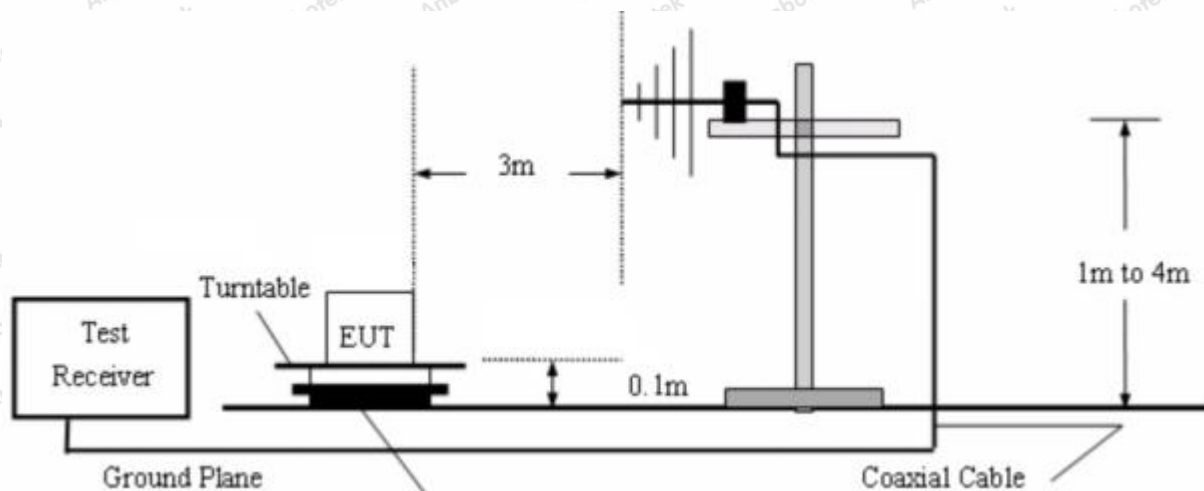

Figure 2. 30MHz to 1GHz

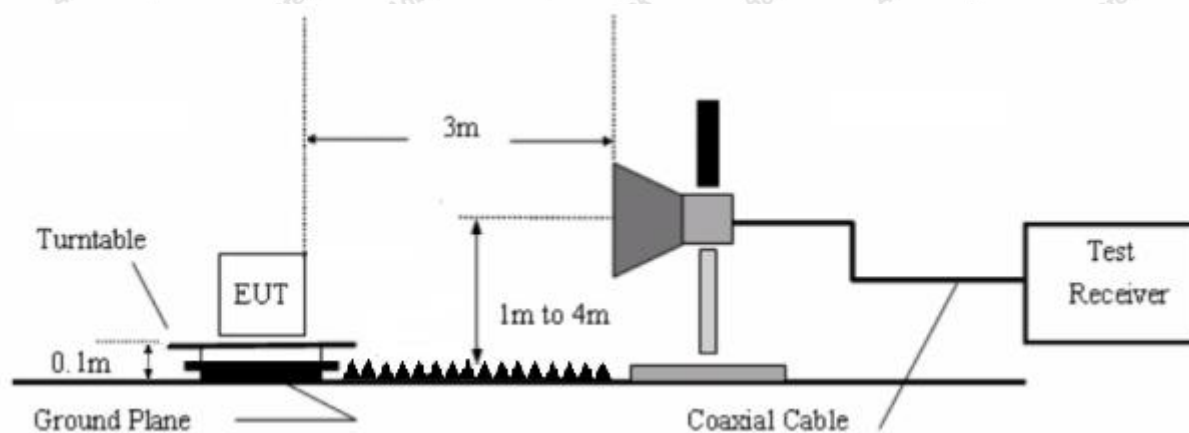

Figure 3. Above 1 GHz

4.3. Test Procedure

For below 1GHz: The EUT is placed on a turntable, which is 0.1m above the ground plane.

For above 1GHz: The EUT is placed on a turntable, which is 0.1m above the ground plane.

The turn table can rotate 360 degrees to determine the position of the maximum emission level. The EUT is set 3 meters away from the receiving antenna which is mounted on a antenna tower. The antenna can be moved up and down from 1 to 4 meters to find out the maximum emission level. Rotated the EUT through three orthogonal axes to determine the maximum emissions, both horizontal and vertical polarization of the antenna are set on test. The EUT is tested in 9*6*6 Chamber. The device is evaluated in xyz orientation.

For the radiated emission test above 1GHz:

Place the measurement antenna away from each area of the EUT determined to be a source of emissions at the specified measurement distance, while keeping the measurement antenna aimed at the source of emissions at each frequency of significant emissions, with polarization oriented for maximum response. The measurement antenna may have to be higher or lower than the EUT, depending on the radiation pattern of the emission and staying aimed at the emission source for



receiving the maximum signal. The final measurement antenna elevation shall be that which maximizes the emissions. The measurement antenna elevation for maximum emissions shall be restricted to a range of heights of from 1 m to 4 m above the ground or reference ground plane.

For 9kHz to 150kHz, Set the spectrum analyzer as:

RBW = 200Hz, VBW =1kHz, Detector= Quasi-Peak, Trace mode= Max hold, Sweep- auto couple.

For 150kHz to 30MHz, Set the spectrum analyzer as:

RBW = 9KHz, VBW =30kHz, Detector= Quasi-Peak, Trace mode= Max hold, Sweep- auto couple.

For 30MHz to 1000MHz, Set the spectrum analyzer as:

RBW = 120kHz, VBW =300kHz,Detector= Quasi-Peak, Trace mode= Max hold, Sweep- auto couple.

For above 1GHz,Set the spectrum analyzer as:

RBW =1MHz, VBW =1MHz, Detector= Peak, Trace mode= Max hold, Sweep- auto couple.

For average measurement: use duty cycle correction factor method (DCCF)

Average level = Peak level + DCCF

4.4. Test Data

PASS

During the test, Pre-scan all kind of the place mode (X-axis, Y-axis, Z-axis), and found the X-axis is the worst case.

The test results of 9kHz-30MHz was attenuated more than 20dB below the permissible limits, so the results don't record in the report.

During the test, pre-scan all modes, only the worst case is recorded in the report.



Test Results (30~1000MHz)

Test Mode: GFSK (2402MHz)

Power Source: AC 120V, 60Hz

Polarization: Vertical

Temp.(°C)/Hum.(%RH): 23.5°C/49%RH

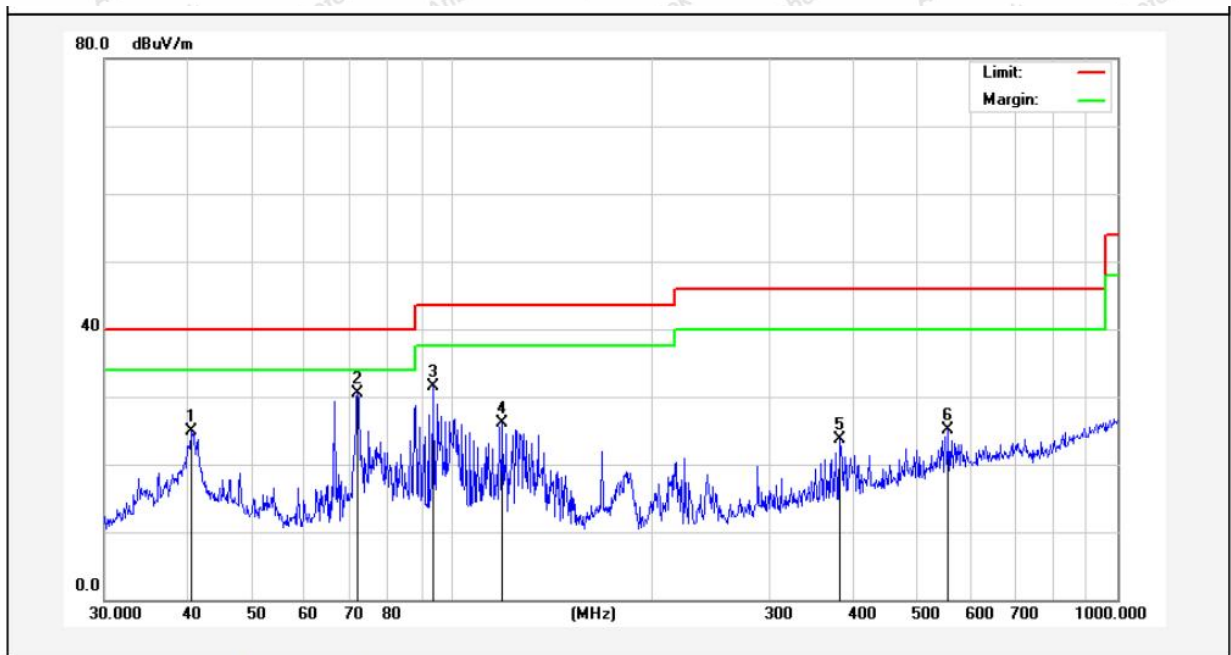

No.	Freq. (MHz)	Reading (dBuV)	Factor (dB/m)	Result (dBuV/m)	Limit (dBuV/m)	Over Limit (dB)	Detector	Height (cm)	degree (deg)	Remark
1	40.5591	39.54	-14.62	24.92	40.00	-15.08	QP			
2	72.0843	50.49	-19.94	30.55	40.00	-9.45	QP			
3	93.4402	48.76	-17.33	31.43	43.50	-12.07	QP			
4	119.0180	45.80	-19.76	26.04	43.50	-17.46	QP			
5	382.5879	38.42	-14.63	23.79	46.00	-22.21	QP			
6	556.7744	36.75	-11.61	25.14	46.00	-20.86	QP			

Note: Result = Reading + Factor Over Limit = Result - Limit



Test Results (30~1000MHz)

Test Mode: GFSK (2402MHz)
 Power Source: AC 120V, 60Hz
 Polarization: Horizontal
 Temp.(°C)/Hum.(%RH): 23.5°C/49%RH

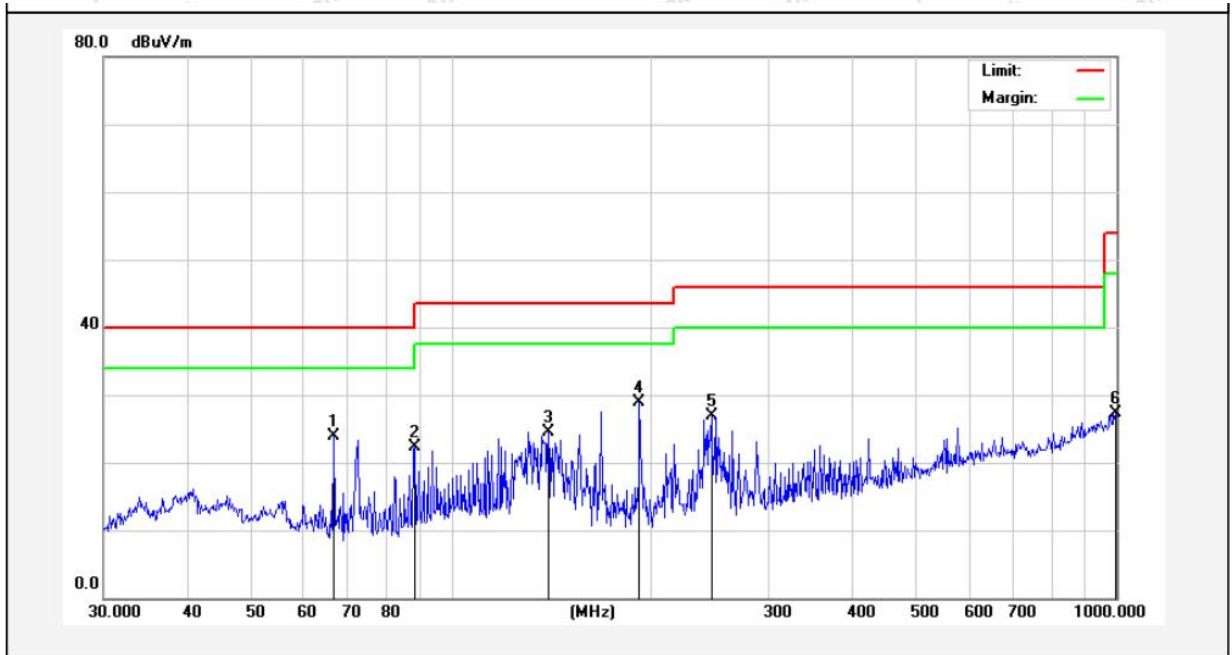

No.	Freq. (MHz)	Reading (dBuV)	Factor (dB/m)	Result (dBuV/m)	Limit (dBuV/m)	Over Limit (dB)	Detector	Height (cm)	degree (deg)	Remark
1	66.4989	44.08	-20.20	23.88	40.00	-16.12	QP			
2	88.0329	44.48	-22.26	22.22	43.50	-21.28	QP			
3	139.8508	47.65	-23.06	24.59	43.50	-18.91	QP			
4	191.7450	51.63	-22.68	28.95	43.50	-14.55	QP			
5	245.9509	48.52	-21.56	26.96	46.00	-19.04	QP			
6	996.4996	32.05	-4.83	27.22	54.00	-26.78	QP			

Note: Result = Reading + Factor Over Limit = Result - Limit



Test Results (1GHz-25GHz)

Test Mode: CH00			Test channel: Lowest			
Peak value:						
Frequency (MHz)	Reading (dBuV)	Factor (dB/m)	Result (dBuV/m)	Limit (dBuV/m)	Over Limit (dB)	polarization
4804.00	26.87	15.27	42.14	74.00	-31.86	Vertical
7206.00	28.09	18.09	46.18	74.00	-27.82	Vertical
9608.00	28.81	23.76	52.57	74.00	-21.43	Vertical
12010.00	*			74.00		Vertical
14412.00	*			74.00		Vertical
4804.00	27.27	15.27	42.54	74.00	-31.46	Horizontal
7206.00	28.15	18.09	46.24	74.00	-27.76	Horizontal
9608.00	28.11	23.76	51.87	74.00	-22.13	Horizontal
12010.00	*			74.00		Horizontal
14412.00	*			74.00		Horizontal
Average value:						
Frequency (MHz)	Reading (dBuV)	Factor (dB/m)	Result (dBuV/m)	Limit (dBuV/m)	Over Limit (dB)	polarization
4804.00	16.25	15.27	31.52	54.00	-22.48	Vertical
7206.00	17.12	18.09	35.21	54.00	-18.79	Vertical
9608.00	17.83	23.76	41.59	54.00	-12.41	Vertical
12010.00	*			54.00		Vertical
14412.00	*			54.00		Vertical
4804.00	15.62	15.27	30.89	54.00	-23.11	Horizontal
7206.00	17.21	18.09	35.30	54.00	-18.70	Horizontal
9608.00	17.42	23.76	41.18	54.00	-12.82	Horizontal
12010.00	*			54.00		Horizontal
14412.00	*			54.00		Horizontal



Test Results (1GHz-25GHz)

Test Mode: CH39				Test channel: Middle		
Peak value:						
Frequency (MHz)	Reading (dBuV)	Factor (dB/m)	Result (dBuV/m)	Limit (dBuV/m)	Over Limit (dB)	polarization
4882.00	26.89	15.42	42.31	74.00	-31.69	Vertical
7323.00	27.94	18.02	45.96	74.00	-28.04	Vertical
9764.00	27.82	23.80	51.62	74.00	-22.38	Vertical
12205.00	*			74.00		Vertical
14646.00	*			74.00		Vertical
4882.00	26.97	15.42	42.39	74.00	-31.61	Horizontal
7323.00	28.14	18.02	46.16	74.00	-27.84	Horizontal
9764.00	27.81	23.80	51.61	74.00	-22.39	Horizontal
12205.00	*			74.00		Horizontal
14646.00	*			74.00		Horizontal
Average value:						
Frequency (MHz)	Reading (dBuV)	Factor (dB/m)	Result (dBuV/m)	Limit (dBuV/m)	Over Limit (dB)	polarization
4882.00	15.98	15.42	31.40	54.00	-22.60	Vertical
7323.00	17.22	18.02	35.24	54.00	-18.76	Vertical
9764.00	17.69	23.80	41.49	54.00	-12.51	Vertical
12205.00	*			54.00		Vertical
14646.00	*			54.00		Vertical
4882.00	15.53	15.42	30.95	54.00	-23.05	Horizontal
7323.00	16.77	18.02	34.79	54.00	-19.21	Horizontal
9764.00	17.93	23.80	41.73	54.00	-12.27	Horizontal
12205.00	*			54.00		Horizontal
14646.00	*			54.00		Horizontal



Test Results (1GHz-25GHz)

Test Mode: CH78				Test channel: Highest		
Peak value:						
Frequency (MHz)	Reading (dBuV)	Factor (dB/m)	Result (dBuV/m)	Limit (dBuV/m)	Over Limit (dB)	polarization
4960.00	27.16	15.58	42.74	74.00	-31.26	Vertical
7440.00	27.95	17.93	45.88	74.00	-28.12	Vertical
9920.00	28.37	23.83	52.20	74.00	-21.80	Vertical
12400.00	*			74.00		Vertical
14880.00	*			74.00		Vertical
4960.00	27.04	15.58	42.62	74.00	-31.38	Horizontal
7440.00	28.17	17.93	46.10	74.00	-27.90	Horizontal
9920.00	28.49	23.83	52.32	74.00	-21.68	Horizontal
12400.00	*			74.00		Horizontal
14880.00	*			74.00		Horizontal
Average value:						
Frequency (MHz)	Reading (dBuV)	Factor (dB/m)	Result (dBuV/m)	Limit (dBuV/m)	Over Limit (dB)	polarization
4960.00	17.10	15.58	32.68	54.00	-21.32	Vertical
7440.00	18.23	17.93	36.16	54.00	-17.84	Vertical
9920.00	18.24	23.83	42.07	54.00	-11.93	Vertical
12400.00	*			54.00		Vertical
14880.00	*			54.00		Vertical
4960.00	16.97	15.58	32.55	54.00	-21.45	Horizontal
7440.00	18.14	17.93	36.07	54.00	-17.93	Horizontal
9920.00	17.83	23.83	41.66	54.00	-12.34	Horizontal
12400.00	*			54.00		Horizontal
14880.00	*			54.00		Horizontal

Remark:

1. During the test, pre-scan the GFSK, $\pi/4$ QPSK modulation, and found the GFSK modulation is worse case, the report only record this mode.
2. Result = Reading + Factor
3. "*" means the test results were attenuated more than 20dB below the permissible limits, so the results don't record in the report.



Radiated Band Edge:

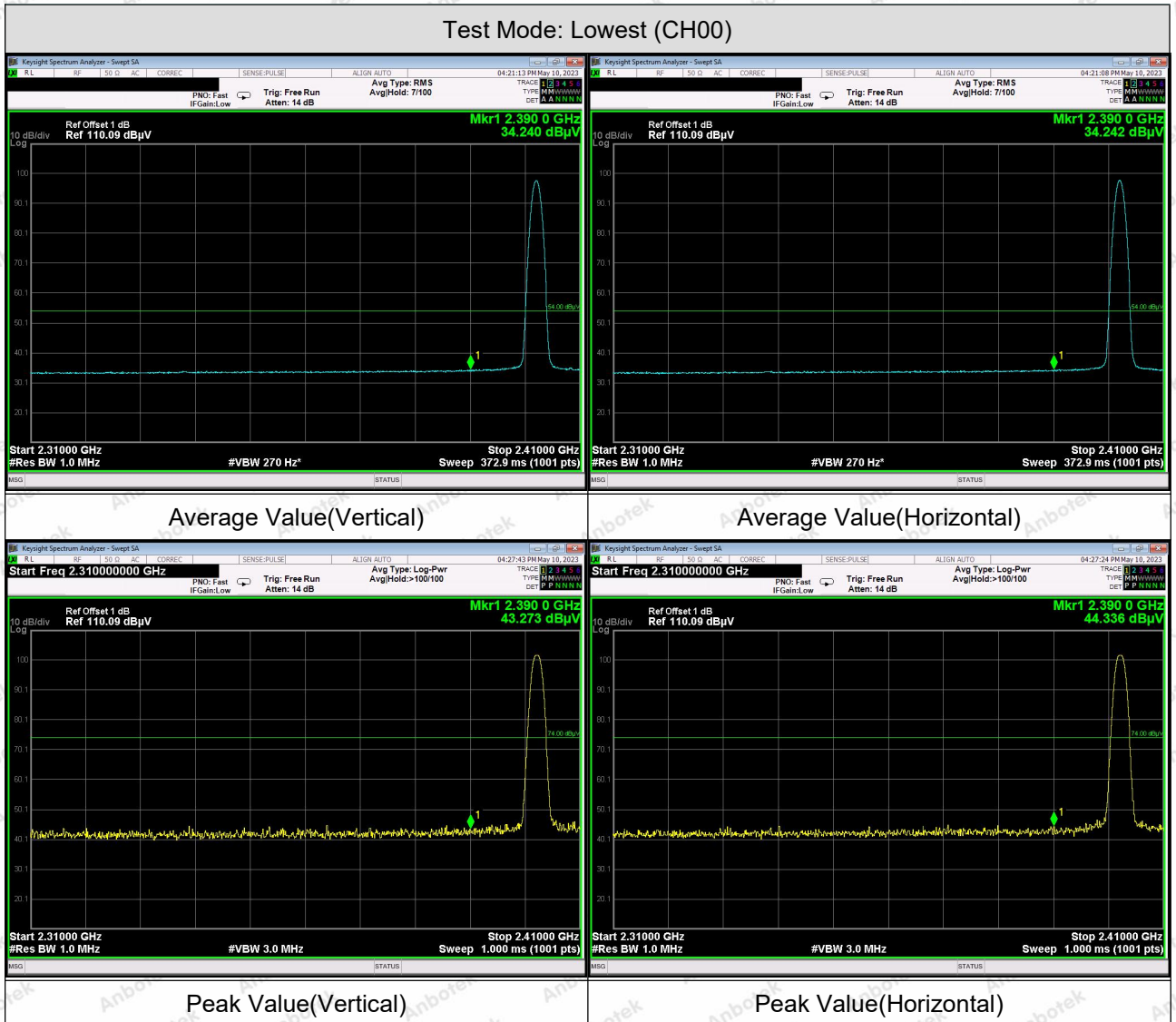

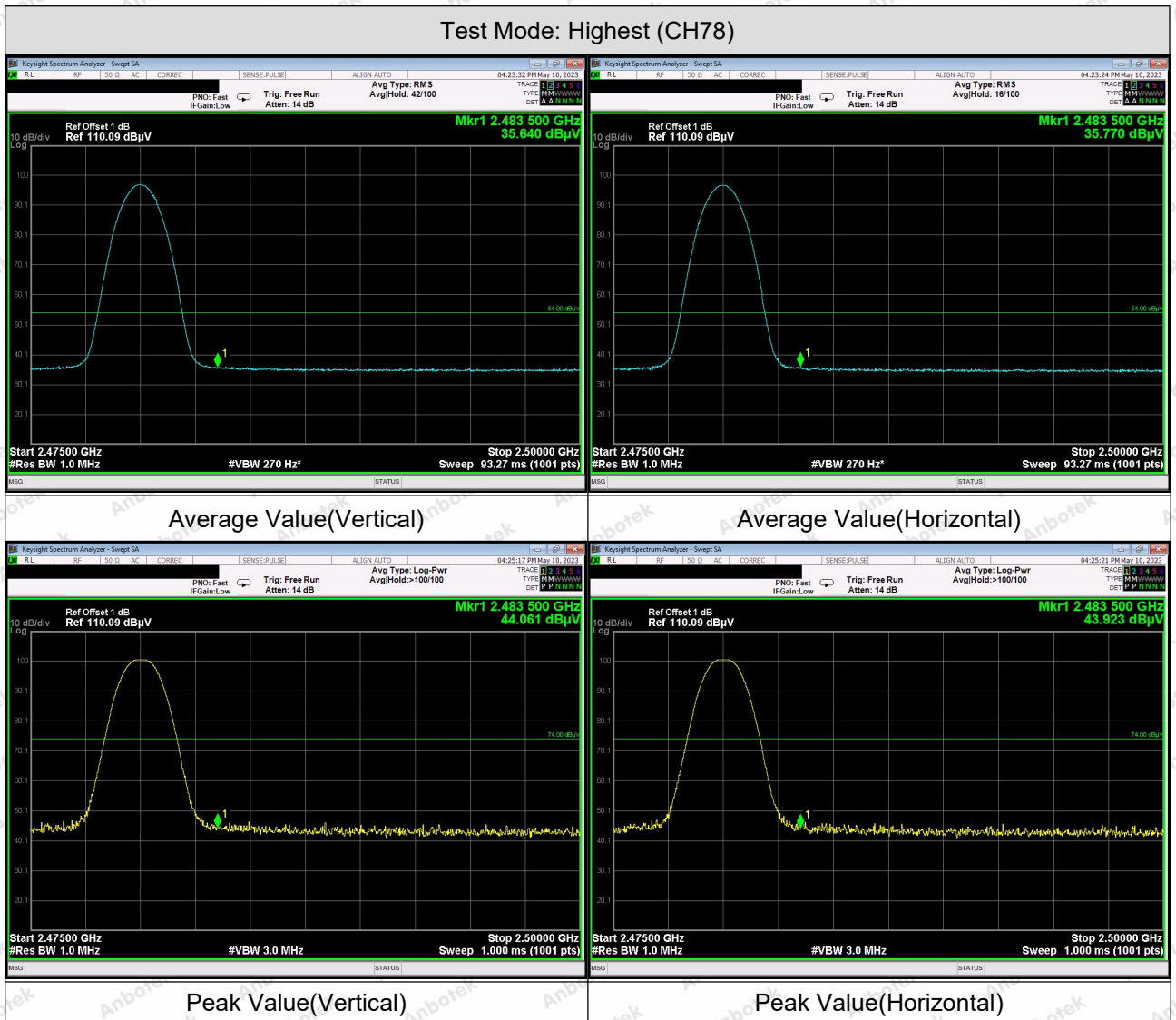

Remark:

1. During the test, pre-scan the GFSK, $\pi/4$ QPSK modulation, and found the GFSK modulation is worse case, the report only record this mode.



5. Maximum Peak Output Power Test

5.1. Test Standard and Limit

Test Standard	FCC Part15 C Section 15.247 (b)(1)
Test Limit	For frequency hopping systems operating in the 2400-2483.5 MHz band employing at least 75 non-overlapping hopping channels, and all frequency hopping systems in the 5725-5850 MHz band: 1 watt. For all other frequency hopping systems in the 2400-2483.5 MHz band: 0.125 watts.

5.2. Test Setup

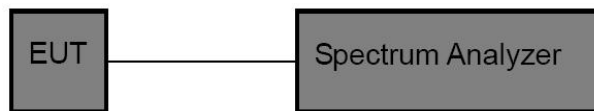

5.3. Test Procedure

1. The EUT was directly connected to the spectrum analyzer and antenna output port as show in the block diagram above,
2. Spectrum Setting:
 - RBW > the 20 dB bandwidth of the emission being measured
 - Span = approximately 5 times the 20 dB bandwidth, centered on a hopping channel
 - VBW ≥ RBW
 - Sweep = auto
 - Detector function = peak
 - Trace = max hold

5.4. Test Data

Pass

Please refer to Appendix C of the Appendix Test Data.



6. 20dB Occupy Bandwidth Test

6.1. Test Standard

Test Standard	FCC Part15 C Section 15.247 (a)(1)
---------------	------------------------------------

6.2. Test Setup

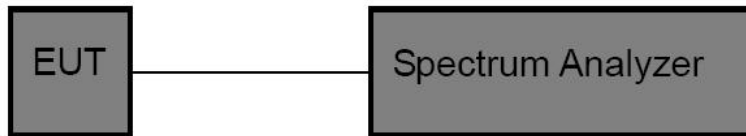

6.3. Test Procedure

Using the following spectrum analyzer settings:

1. Span= approximately 2 to 3 times the 20dB bandwidth, centered on a hopping channel.
2. Set the RBW $\geq 1\%$ of the 20 dB bandwidth.
3. Set the VBW \geq RBW
4. Sweep time = auto couple.
5. Detector function = peak.
6. Trace mode = max hold.
7. Allow trace to fully stabilize.

6.4. Test Data

Pass

Please refer to Appendix A of the Appendix Test Data.



7. Carrier Frequency Separation Test

7.1. Test Standard and Limit

Test Standard	FCC Part15 C Section 15.247 (a)(1)
Test Limit	2/3 of the 20dB bandwidth base on the transmission power is less than 0.125W.

7.2. Test Setup

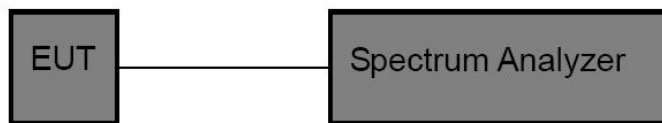

7.3. Test Procedure

The EUT must have its hopping function enabled. Using the following spectrum analyzer settings:

1. Span= Wide enough to capture the peaks of two adjacent channels
2. Set the RBW =approximately 30% of the channel spacing.
3. Set the VBW \geq RBW.
4. Sweep time = auto couple.
5. Detector function = peak.
6. Trace mode = max hold.
7. Allow trace to fully stabilize.

7.4. Test Data

Pass

Please refer to Appendix D of the Appendix Test Data.



8. Number of Hopping Channel Test

8.1. Test Standard and Limit

Test Standard	FCC Part15 C Section 15.247 (a)(1)(iii)
Test Limit	>15 channels

8.2. Test Setup

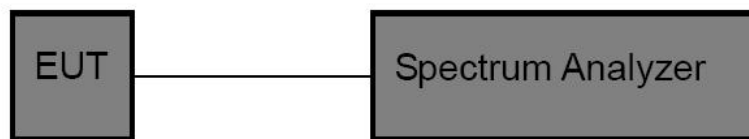

8.3. Test Procedure

The EUT must have its hopping function enabled. Using the following spectrum analyzer setting:

1. Span= the frequency band of operation
2. Set the RBW = less than 30% of the channel spacing or the 20 dB bandwidth, whichever is smaller.
3. Set the VBW \geq RBW.
4. Sweep time = auto couple.
5. Detector function = peak.
6. Trace mode = max hold.
7. Allow trace to fully stabilize.

8.4. Test Data

Pass

Please refer to Appendix F of the Appendix Test Data.



9. Dwell Time Test

9.1. Test Standard and Limit

Test Standard	FCC Part15 C Section 15.247 (a)(1)(iii)
Test Limit	0.4 s

9.2. Test Setup

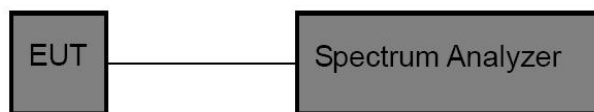

9.3. Test Procedure

The EUT must have its hopping function enabled. Use the following spectrum analyzer settings:

1. Span= zero span, centered on a hopping channel
2. Set the RBW = 1 MHz.
3. Set the VBW \geq RBW.
4. Sweep time = as necessary to capture the entire dwell time per hopping channel.
5. Detector function = peak.
6. Trace mode = max hold.
7. Allow trace to fully stabilize.

9.4. Test Data

Pass

Please refer to Appendix E of the Appendix Test Data.



10. 100kHz Bandwidth of Frequency Band Edge Requirement

10.1. Test Standard and Limit

Test Standard	FCC Part15 C Section 15.247 (d)
Test Limit	In any 100 kHz bandwidth outside the frequency bands in which the spread spectrum intentional radiator is operating, the radio frequency power that is produced by the intentional radiator shall be at least 20dB below that in the 100kHz bandwidth within the band that contains the highest level of the desired power, In addition, radiated emissions which fall in the restricted bands, as defined in §15.205(a), must also comply with the radiated emission limits specified in 15.209(a).

10.2. Test Setup

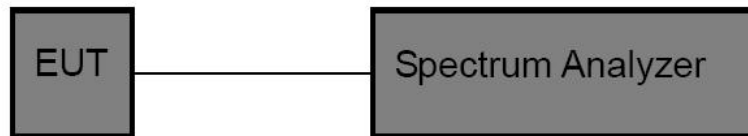

10.3. Test Procedure

The EUT must have its hopping/Non-hopping function enabled. Using the following spectrum analyzer setting:

1. Set the RBW = 100kHz.
2. Set the VBW = 300kHz.
3. Sweep time = auto couple.
4. Detector function = peak.
5. Trace mode = max hold.
6. Allow trace to fully stabilize.

10.4. Test Data

Pass

Please refer to Appendix G & Appendix H of the Appendix Test Data.



11. Antenna Requirement

11.1. Test Standard and Requirement

Test Standard	FCC Part15 Section 15.203 /247(c)
Requirement	<p>1) 15.203 requirement: An intentional radiator shall be designed to ensure that no antenna other than that furnished by the responsible party shall be used with the device. The use of a permanently attached antenna or of an antenna that uses a unique coupling to the intentional radiator, the manufacturer may design the unit so that a broken antenna can be replaced by the user, but the use of a standard antenna jack or electrical connector is prohibited.</p> <p>2) 15.247(c) (1)(i) requirement: Systems operating in the 2400-2483.5 MHz band that is used exclusively for fixed. Point-to-point operations may employ transmitting antennas with directional gain greater than 6dBi provided the maximum conducted output power of the intentional radiator is reduced by 1 dB for every 3 dB that the directional gain of the antenna exceeds 6 dBi.</p>

11.2. Antenna Connected Construction

The antenna is PCB Antenna which permanently attached, and the best case gain of the antenna is 2.5dBi. It complies with the standard requirement.



APPENDIX I -- TEST SETUP PHOTOGRAPH

Please refer to separated files Appendix I -- Test Setup Photograph

APPENDIX II -- EXTERNAL PHOTOGRAPH

Please refer to separated files Appendix II -- External Photograph

APPENDIX III -- INTERNAL PHOTOGRAPH

Please refer to separated files Appendix III -- Internal Photograph

----- End of Report -----

