

ZR51200 self-propelled baler

Operator's and maintenance manual

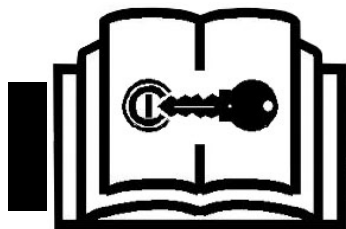

EN_o-m1_07_original instructions
Serial No. 101 -
Order No. 105400FA6
Cabled Assembly Order No. 510542686



Vermeer[®]

EQUIPPED TO
DO MORE.

Introduction

This manual explains the proper operation of your machine. Study and understand these instructions thoroughly before operating or maintaining the machine. Failure to do so could result in personal injury or equipment damage. Consult your Vermeer dealer if you do not understand the instructions in this manual, or need additional information.

The instructions, illustrations, and specifications in this manual are based on the latest information available at time of publication. Your machine may have product improvements and features not yet contained in this manual.

To provide a better view, some photographs or illustrations in the maintenance sections may show the machine shields removed. **Never operate the machine with the shields removed - keep all shields in place.** If removing a shield is necessary, return it to its operating position before operating the machine.

Vermeer Corporation reserves the right to make changes at any time without notice or obligation.

Operation and maintenance instructions are included in the two Operator's and Maintenance Manuals provided with the machine. The tethered (cabled) manual must remain attached to the machine for ready reference. Store it in the manual storage box when not in use.

Additional copies of the manuals are available from your dealer. Use the reorder number on the front cover to order additional manuals.

Copies of this manual are available in Spanish from your dealer. Other languages may also be available.

Se dispone de ejemplares de este manual en español.

NOTICE TO OWNER

Replacement manuals are free of charge by registering your **used** Vermeer machine. Your machine's Operator's, Maintenance and Parts Manuals may be available online at www.myvermeer.com. For questions about online or printed manuals, or to register a used machine, contact the Customer Data Department by telephone: 800-829-0051 or 641-628-3141; email: customerdata@vermeer.com; internet: www.vermeer.com or www.myvermeer.com; or, letter: Customer Data Dept., Vermeer Corporation, PO Box 200, Pella IA 50219 USA.

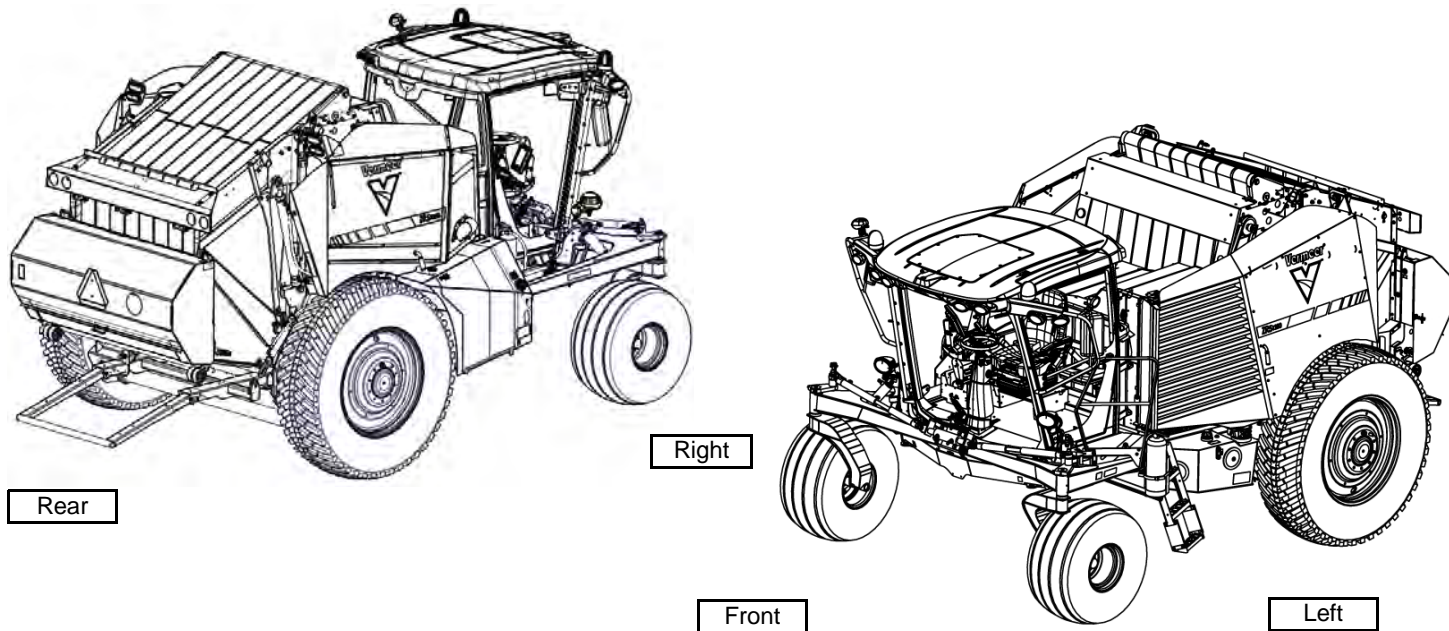

Orientation: Right and left sides of the machine are determined by facing in the direction of forward travel.

TRADEMARKS

VERMEER, VERMEER Logo, and EQUIPPED TO DO MORE are trademarks of Vermeer Manufacturing Company.

VERMEER NEW AGRICULTURAL EQUIPMENT LIMITED WARRANTY

EFFECTIVE JANUARY 01, 2020

One (1) Year / 12 Months

VERMEER CORPORATION (hereinafter "Vermeer") warrants each new Agricultural product of Vermeer's manufacture to be free from defects in material and workmanship, under normal use and service for one (1) full year after initial purchase/retail sale. This Limited Warranty shall apply only to complete machines of Vermeer's manufacture, parts are covered by a separate Limited Warranty.

EQUIPMENT AND ACCESSORIES NOT OF VERMEER'S MANUFACTURE ARE WARRANTED ONLY TO THE EXTENT OF THE ORIGINAL MANUFACTURER'S WARRANTY AND SUBJECT TO THEIR ALLOWANCE TO VERMEER ONLY IF FOUND DEFECTIVE BY SUCH MANUFACTURER.

EXTENDED WARRANTY OPTIONS ARE AVAILABLE FOR PURCHASE.

WARRANTY TERMS:

During the Limited Warranty period specified above, any defect in material or workmanship in any warranted item of Vermeer Agricultural Equipment not excluded below shall be repaired or replaced at Vermeer's option without charge by any authorized independent Vermeer dealer. The warranty repair or replacement must be made by a Vermeer independent authorized dealer at the dealer's location. Vermeer will pay for replacement parts and such authorized dealer's labor in accordance with Vermeer's labor reimbursement policy. Vermeer reserves the right to supply remanufactured replacement parts as it deems appropriate.

RETAIL PURCHASER RESPONSIBILITY:

This Limited Warranty requires proper maintenance and periodic inspections of the Agricultural Equipment as indicated in the Operator's/ Maintenance Manual furnished with each new Agricultural Equipment. The cost of routine or required maintenance and services is the responsibility of the retail purchaser. The retail purchaser is required to keep documented evidence that these services were performed.

This Vermeer New Agricultural Equipment Limited Warranty may be subject to cancellation if the above requirements are not performed.

Vermeer Agricultural Equipment with known failed or defective parts must be immediately removed from service.

EXCLUSIONS AND LIMITATIONS

The warranties contained herein shall **NOT APPLY TO:**

- (1) Any defect which was caused (in Vermeer's sole judgment) by other than normal use and service of the Agricultural Equipment, or by any of the following: (i) accident; (ii) misuse or negligence; (iii) overloading; (iv) lack of reasonable and proper maintenance; (v) improper repair or installation; (vi) unsuitable storage; (vii) non-Vermeer approved alteration or modification; (viii) natural calamities; (ix) vandalism; (x) parts or accessories installed on Agricultural Equipment which were not manufactured or installed by Vermeer authorized dealers; (xi) the elements; (xii) collision or other accident.
- (2) Any Agricultural Equipment whose identification numbers or marks have been altered or removed.
- (3) Any Agricultural Equipment which any of the required or recommended periodic inspection or services have been performed using parts not manufactured or supplied by Vermeer or meeting Vermeer Specifications including, but without limitation, lubricants (oil, grease), belt lacings, hydraulic fluids, engine tune-up parts, engine oil filters, air filters, hydraulic oil filters, and fuel filters.
- (4) New Agricultural Equipment delivered to the retail purchaser in which the equipment /warranty registration has not been completed and returned to Vermeer within ten (10) days from the date of purchase.
- (5) Any defect that was caused (in Vermeer's sole judgment) by operation of the Agricultural Equipment not abiding by standard operating procedures outlined in the Operator's Manual.
- (6) Engine, battery and tire Limited Warranties and support are the responsibility of the respective product's manufacturer. Re-treaded tires are expressly excluded from coverage under this Limited Warranty.
- (7) Transportation costs, if any, of transporting to the Vermeer dealer.
- (8) The travel time and expenses of the Vermeer dealer's service personnel to make a repair on the retail purchaser's site or other location.

- (9) In no event shall Vermeer's liability exceed the purchase price of the product.
- (10) Vermeer shall not be liable to any person under any circumstances for any incidental or consequential damages (including but not limited to, loss of profits, out of service time) occurring for any reason at any time.
- (11) Diagnostic and overtime labor premiums are not covered under this Limited Warranty Policy.
- (12) Depreciation damage caused by normal wear, lack of reasonable and proper maintenance, failure to follow operating instructions, misuse, and/or lack of proper protection during storage.
- (13) Accessory systems and electronics not of Vermeer's manufacture are warranted only to the extent of such manufacturer's respective Limited Warranty, if any.
- (14) Wear items which are listed by product group below:

COMMON WEAR ITEMS: roller chain, sprockets, clutches, clutch components, knives, bolts/torqued parts, hoses (unless otherwise specified under extended warranty).

BALE MOVERS: chains, motor sprocket, rear sprocket.

BALE PROCESSORS: coupler chain, DRV couplers, feed roller belting, flails.

BALE WRAPPERS: extension chain, film dispenser gear set, gearbox housing, knife assembly, plastic sprocket, shear bolts.

BALERS: belt lacings/cables, pickup teeth, scraper knives, service items, twine knives.

FEED MIXERS: knife blades, backing plates, edge deflectors.

RAKES/TEDDERS: teeth, tines.

MOWERS: blades, caps, discs, shoes.

MISC. BALE HANDLING EQUIPMENT: knife blades, tines (bale spikes).

PARTS WARRANTY

Parts replaced in the warranty period will receive the balance of the first year New Agricultural Equipment Limited Warranty, during the first twelve (12) months. Replacement parts after the original machine warranty, are warranted to be free from defects of materials for ninety (90) days or the part will be repaired or replaced, without labor coverage for removal and reinstallation.

EXCLUSIONS OF WARRANTIES: UNLESS OTHERWISE REQUIRED BY LAW, AND EXCEPT FOR THE WARRANTIES EXPRESSLY AND SPECIFICALLY MADE HEREIN, VERMEER MAKES NO OTHER WARRANTIES, AND ANY POSSIBLE LIABILITY OF VERMEER HEREIN UNDER IS IN LIEU OF ALL OTHER WARRANTIES, EXPRESS, IMPLIED, OR STATUTORY, INCLUDING, BUT NOT LIMITED TO, ANY WARRANTIES OF MERCHANTABILITY OR FITNESS FOR A PARTICULAR PURPOSE. VERMEER RESERVES THE RIGHT TO MODIFY, ALTER AND IMPROVE ANY PRODUCT WITHOUT INCURRING ANY OBLIGATION TO REPLACE ANY PRODUCT PREVIOUSLY SOLD WITH SUCH MODIFICATION. NO PERSON IS AUTHORIZED TO GIVE ANY WARRANTY, OR TO ASSUME ANY ADDITIONAL OBLIGATION ON VERMEER'S BEHALF.

NO DEALER WARRANTY. The selling dealer makes no warranty of its own and the dealer has no authority to make any representation or promise on behalf of Vermeer or to modify the terms or limitations of this warranty in any way.

ELECTRONIC SIGNATURES. Each of the parties hereto expressly agrees to conduct transactions by electronic means. Accordingly, the parties agree and intend that all electronic transmissions including, without limitation, electronic signatures, shall be considered equivalent to an original writing as provided under Iowa law, as it may be amended from time to time.

MANUFACTURED BY:

VERMEER CORPORATION, Pella, Iowa 50219 USA

This page intentionally left blank.

Receiving and delivery report

Dealer prep

Check or perform the following:

Receiving

- Check machine for shortage or damage in transit.
- Check condition of all safety signs, reflective decals, operating decals, and shields for transit damage.

Engine and drivetrain

- Check engine oil level.
- Check battery electrolyte level and battery charge.
- Check radiator coolant level.
- Check air cleaner element condition.
- Check belt tension.
- Check engine operation.

Hydraulics

- ___ Check hydraulic oil level.
- ___ Check hydraulic control operation.
- ___ Check hydraulic components for leaks or damage.

General

- ___ Check that *operator's and maintenance manual* is in drawer under operator's seat.
- ___ Check Operator Presence system operation.
- ___ Check neutral start interlock operation.
- ___ Check park brake operation.
- ___ Check machine lubrication.
- ___ Check that seat belt is installed.
- ___ Check shield installation and condition.
- ___ Check condition of all safety signs and decals.
- ___ Check bolts for tightness.
- ___ Check all phases of operation.
- ___ Check instruments.
- ___ Check work lights, headlights, taillights, and warning flashers.
- ___ Check wheel lug nut torque:
Front: 135 ft-lb (183 Nm)
Rear: 630 ft-lb +/- 50 ft-lb (854 Nm +/- 68 Nm)
- ___ Check for signs of leakage and oil level in gearbox.
- ___ Inspect tires and rims for damage.

- ___ Ensure tires are inflated as described below. Valve stem should be toward outside of baler.
Front Tires: 21.5L-16 FRM HWY Service at 20 psi (140 kPa)
Rear Tires: 480/80R38 (18.4R38) at 29 psi (200 kPa)
- ___ Ensure tailgate latches properly.
- ___ Ensure slow-moving vehicle (SMV) sign is installed facing forward with protective film removed.
- ___ Complete “Dealer/Owner information,” [page vi](#).
- ___ Complete “Identification numbers - record,” [page vii](#).

Electronic control unit - predelivery checks

- ___ Check that electronic control unit and display function correctly.
- ___ Fully open tailgate and ensure bale size is set to 46" (117 cm).
- ___ Ensure electrical connections are secure.
- ___ Inspect bale chamber-mounted controller sensors. Ensure they are intact, properly adjusted, and operating correctly.
 - Tailgate Lock Sensor
 - Bale Size Sensor
 - Netwrap Feed Sensor
 - Bale Shape Sensor
 - Bale Moisture Sensors

Delivery

Check and perform the following with the customer:

Machine - delivery review

- ___ Review “Intended use,” [page 15-1](#).
- ___ Review machine operation. Refer to [Sections 20, 40 and 50](#) of this [Operator’s and Maintenance Manual](#).
- ___ Review all remaining sections of this [Operator’s and Maintenance Manual](#).
- ___ Grease or oil all lubrication points; review lubrication decal.

Netwrap - delivery review

Refer to “Netwrap operation,” [page 40-1](#), for details.

- ___ Check netwrap system operation and adjust if needed.
- ___ Review netwrap settings on controller.
- ___ Explain operation.
- ___ Manually extend and retract to show start, feed, and home positions.
- ___ Load netwrap and explain proper netwrap routing.

Review of operation

Review and demonstrate with the customer the various aspects of the machine:

- ___ Overall explanation of how the machine works
- ___ Operation safety
- ___ Preparing the machine for operation
- ___ Check that highway lights operate correctly.
- ___ Check all chains for proper adjustment.
- ___ Check hydraulic density system function.
- ___ Run baler; check all phases of operation.

Warranty registration

- ___ Check that warranty registration information has been filled out and returned to Vermeer Corporation.

Dealer/Owner information

dealer

address

city

state / province

zip / postal code

country

phone number

email address

owner

address

city

state / province

zip / postal code

country

phone number

email address

Identification numbers - record

Power unit

Serial number tag located under right hand side of cab

Model number _____

Serial number _____

Bale chamber

Serial number tag located on left side of bale chamber

Model number _____

Serial number _____

Engine

Model number _____

Serial number _____

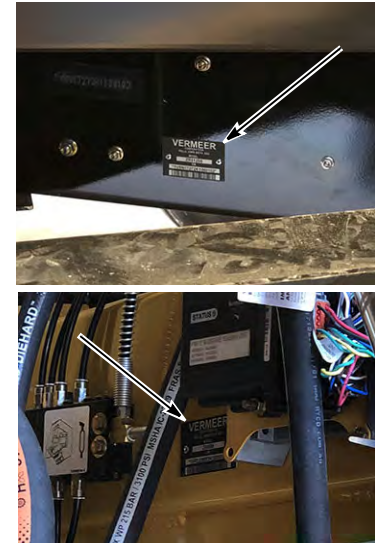

Display unit

Controller part number _____

Controller software/revision number _____

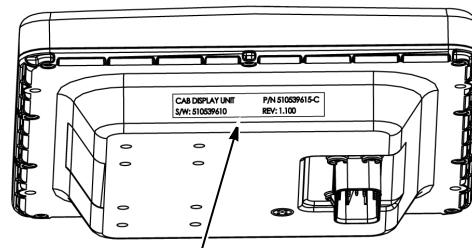

Electronic control unit

Controller part number _____

Controller software/revision number _____



Table of Contents

Receiving and delivery report i

Dealer prep	i
Receiving	i
Engine and drivetrain	i
Hydraulics	ii
General	ii
Electronic control unit - predelivery checks	iii
Delivery	iv
Machine - delivery review	iv
Netwrap - delivery review	iv
Review of operation	v
Warranty registration	v
Dealer/Owner information	vi
Identification numbers - record	vii
Power unit	vii
Bale chamber	vii
Engine	vii
Display unit	viii
Electronic control unit	viii

Safety messages	10-1
Safety symbol explanation	10-1

Diesel fuel and DEF requirements	12-1
Diesel fuel sulfur content	12-1
DEF (diesel exhaust fluid)	12-2

Intended use	15-1
---------------------	-------------

Emissions quick reference guide	18-1
--	-------------

Machine controls	20-1
Tailgate lock valve	20-1
Engine controls	20-2
Ground drive controls	20-3
Baler controls	20-9
Diesel particulate filter controls	20-11
Accessory controls	20-12
Cab access steps	20-16
Cab door	20-17
Emergency exit	20-18
Front sunscreen	20-19
Seat belts and seat controls	20-20
Operator presence system	20-21
Access panels and doors	20-22
Fuel and DEF fill locations	20-22
Hydraulic fluid fill	20-22
Fire extinguisher mounting location	20-24

Electronic controller	21-1
Electronic control system	21-1
Electronic control system - functions	21-1
Electronic control system - protection and care	21-2

Monitor face and control functions	21-3
Monitor - home screen.	21-3
Monitor functions and screen symbols	21-4
Navigation Softkeys	21-5
Bale Size Screen Symbols	21-7
Bale shape and information boxes	21-9
Bale weight	21-10
Bale chamber tailgate screen symbols	21-11
Fault screen symbols	21-12
Programming and Configuration Functions	21-13
Bale chamber setup screen	21-14
Vermeer TempSense operation	21-16
Vermeer TempSense regulatory notice	21-18
Starting procedure	22-1
Starting the engine	22-1
Extended idle periods	22-3
Cold weather starting	22-4
Jump-starting (12-volt system)	22-5
Battery explosion - avoid	22-5
Battery burns - avoid	22-5
Jump-starting procedure	22-6
Shutdown procedure	23-1
Stopping the engine	23-1
Preparing the equipment	25-1
Prepare the machine	25-1
Controls familiarity	25-1
Training	25-1
Operator presence system	25-2

Seat belt use	25-3
Prestarting inspection	25-4
Netwrap - prestarting inspection	25-6
SMV sign - position	25-6

Transporting the machine	30-1
Mount and dismount safely	30-1
Machine - clean	30-2
Seat belts	30-2
Fasten seat belts	30-2
Driving the machine	30-3
Trailing the machine	30-6
Loading	30-7
Unloading	30-7
Towing/Retrieval	30-8

Preparing the crop to bale	35-1
Conventional baling	35-1
Crop preparation	35-1
Moisture content	35-1
Windrow preparation	35-2

Netwrap operation	40-1
Netwrap - operational instructions	40-1
Netwrap components	40-3
Netwrap components - operating positions	40-5
Net storage location	40-6
Netwrap system - function overview	40-6
Netwrap - controller setup instructions	40-7
Netwrap system - setup procedure	40-7
Start softkey - manual netwrap cycle	40-10

Pause softkey - netwrap cycle	40-12	Safe operating practices	50-2
Manual control softkeys - netwrap	40-13	Fire prevention	50-4
Netwrap - Apply to Bale	40-14	Fire - extinguish.	50-5
Netwrap system - automatic cycle start.	40-15	Preparing for Operation	50-7
Netwrap - paused operation	40-15	Diesel particulate filter (DPF) safety.	50-8
Netwrap - normal operation	40-16	DPF alert indicators	50-9
Netwrap - manual start	40-20	Arriving at the field	50-10
Failed and misfed netwrap.	40-21	Crop feed direction	50-11
Netwrap misfeed - check for and remove.	40-22	Operator's station	50-11
Netwrap - loading and storage.	40-23	Prepare baler	50-12
Net loading operation	40-24	Bale formation	50-13
Netwrap - adjustments and maintenance	40-30	Baling speed	50-14
Netwrap feed sensing.	40-30	Bale density.	50-14
Netwrap system - optimize performance	40-31	Bale size	50-14
Netwrap brake pad-to-wheel clearance - adjust.	40-32	Bale shape	50-15
Netwrap shear bar clearance - adjust.	40-34	Baling	50-17
Netwrap brake spring (tension) - initial adjustment.	40-36	Wrapping the bale	50-19
Auto lube operation.	44-1	Wrapping the bale - electronic controller.	50-19
Auto lube - operational instructions	44-1	Wrapping the bale sequence - netwrap	50-20
Auto lube - setup procedure	44-2	Ejecting the Bale	50-21
Manual lube - setup procedure	44-3	Ejecting the bale	50-22
Moisture sensing	45-1	Unplugging the Baler	50-23
Operational moisture sensing - instructions.	45-1	Plugged pickup area	50-24
Moisture display - calibrate.	45-3	Flipped belt - reposition.	50-25
Moisture offset - settings.	45-5	Unloading and Loading Bale Chamber	50-26
Operating the machine	50-1	Operational messages	50-31
Operator Qualifications	50-1	Net not feeding alert	50-31
Personal protection	50-2	Tailgate open alert	50-32
		Handling round bales	51-1
		Bale carriers	51-1

Storing bales	51-2
Correct bale storage	51-2
Incorrect bale storage	51-3
Maintenance	60-1
Safety signs	60-1
Welding alert - electronic components	60-2
Battery disconnect procedure	60-2
Engine maintenance intervals	60-3
Greasing the machine	60-3
Recommended fluids	60-3
Maintenance Intervals	60-4
Maintenance - 10 Hours	60-6
Before each use	60-6
Misfed netwrap - check for and remove	60-8
After each use	60-9
Maintenance - every 50 hours	60-10
Check/Clean cabin air filter	60-10
Tires and rims - check	60-11
Grease points	60-12
Belt lacing and pins - inspect	60-13
Maintenance - every 100 hours	60-15
Overall machine - check	60-15
Levers, switches, buttons - check	60-15
Backup alarm - check	60-16
Neutral start interlock - check	60-16
Operator presence system - check	60-16
Hydraulic system - check	60-17
Maintenance - 250 hours	60-18
Wheel bearings - check	60-18
Maintenance - as required	60-20

Pickup teeth - replace	60-20
Chains - inspect/remove/install	60-21
Tailgate latches - adjust	60-24
Netwrap knife - adjust	60-25
Tailgate camera - clean	60-29
Specifications	65-1
Lubricants	65-1
Machine specifications	65-2

Section 10: Safety messages

General safety messages appear in this Safety Messages section. Specific safety messages are located in appropriate sections of the manual where a potential hazard may occur if the instructions or procedures are not followed.

A signal word **DANGER**, **WARNING** or **CAUTION** is used with the safety alert symbol.

Safety signs with signal word **DANGER**, **WARNING** or **CAUTION** are located near specific hazards.

DANGER	Indicates a hazardous situation that, if not avoided, will result in death or serious injury.
WARNING	Indicates a hazardous situation that, if not avoided, could result in death or serious injury.
CAUTION	Indicates a hazardous situation that, if not avoided, could result in minor or moderate injury.
NOTICE	Indicates information considered important, but not hazard-related.

Safety symbol explanation



This is the safety alert symbol. This symbol is used in combination with an exclamation mark or other symbols to alert you to the potential for death or serious injury.



This symbol indicates that at least one part of the machine is not operating correctly. Shutting down the machine may not be necessary, but some maintenance may be required.

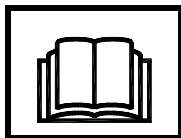

WARNING: Read Operator's Manual and safety signs before operating machine.

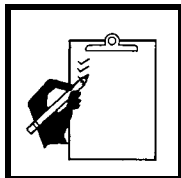

WARNING: Check machine before operating. Machine must be in good operating condition and all safety equipment installed and functioning properly.

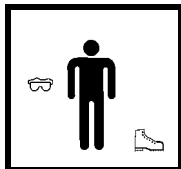

WARNING: Wear personal protection equipment. Wear close-fitting clothing and confine long hair. Refer to "Personal protection," [page 50-2](#) for additional personal protection requirements.



WARNING: Keep spectators away.



WARNING: Engine exhaust can asphyxiate or poison resulting in death or serious injury. Operate machine outdoors. If it is necessary to operate engine in an enclosed area, properly vent exhaust gases.

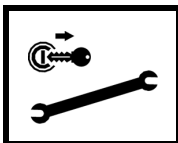

WARNING: Failure to use shutdown procedure can result in unexpected hazard(s). Death or serious injury could result due to entanglement, crushing, cutting, or other hazardous contact. Follow Shutdown Procedure after operating, before performing any service or maintenance, and before transporting. Refer to [Shutdown procedure](#), page 23-1.



WARNING: Pressurized fluid can penetrate body tissue and result in death or serious injury. Leaks can be invisible. Keep away from any suspected leak. Relieve pressure in the hydraulic system before searching for leaks, disconnecting hoses, or performing any other work on the system. If you must pressurize the system to find a suspected leak, use an object such as a piece of wood or cardboard rather than your hands. When loosening a fitting where some residual pressure may exist, slowly loosen the fitting until oil begins to leak. Wait for leaking to stop before disconnecting the fitting. Fluid injected under the skin must be removed immediately by a surgeon familiar with this type of injury.

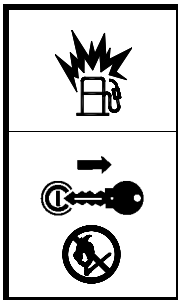

WARNING: Fuel and fumes can explode and burn.

Shut off engine before refueling. No flame. No smoking.

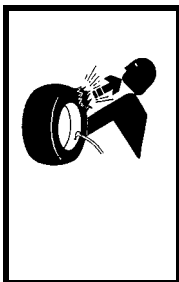

WARNING: Tire explosion can result if the following procedures are not followed:

- Maintain correct tire pressure. Do not inflate tire above recommended pressure.
- Low tire pressure can cause internal tire damage. Inflate to recommended pressure.
- Replace any wheel with cuts or bubbles. Replace any damaged rims.
- Do not weld or heat wheel assembly. Heating will increase tire pressure.



WARNING: Hot fluid under pressure can scald.

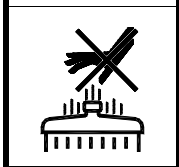

Allow engine to cool before opening radiator cap.



WARNING: Improper use of steps, ladders, and platforms can cause you to fall. Keep them clear of objects and debris which may cause difficulties stepping on or off the machine. Face the machine when mounting and dismounting. Maintain a 3-point hand/foot contact with the access system (one hand and two feet, or two hands and one foot). Keep all handrails in place.

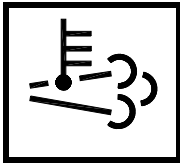

WARNING: When *High Exhaust System Temp (HEST) Lamp* is displayed, the exhaust gas temperature could exceed 1100°F (600°C) during regeneration. High temperature may result in fire, burn, or explosion hazards, which may result in personal injury or death. Do not expose flammable material or explosive atmospheres to exhaust gas or to exhaust system components during regeneration.



CAUTION: To prevent fires, routinely clear any combustible material from the engine exhaust system. Emission compliant exhaust systems use extreme high temperature that can ignite combustible material.



WARNING: Falling from machine can result in death or serious injury.



Riders are not allowed on the machine.
Do not climb. If access is needed, use suitable height stepladder.

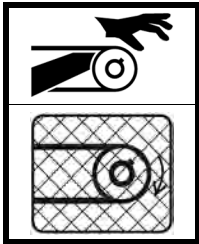

WARNING: Belts, rollers, and chains can cut off hand or arm.

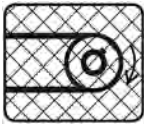

Keep all shields in place when operating.

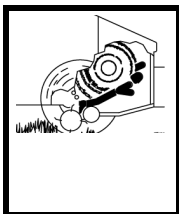

DANGER: Baler intake can pull you in, resulting in death or serious injury. Stay clear of pickup reel and feed intake area. Baler may take in crop faster than you can let go.

NEVER feed crop by hand.

NEVER remove any material from the baler intake while it is running.

NEVER try to unplug the baler while it is running. Refer to [page 50-24](#).

ALWAYS disengage baler ground drive, shut off engine, engage park brake, and remove key before manually unplugging or servicing.



WARNING: Rolling bale can crush.



Do not eject downhill.

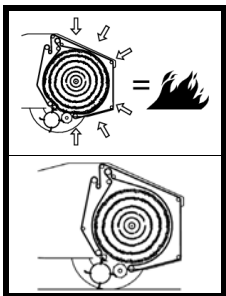

CAUTION: Oversize bale may result in premature baler failures and risk of fire.

Do not overfill baler.



WARNING: Failure to follow any of the preceding safety instructions or those that follow within this manual, could result in death or serious injury. This machine is to be used only for those purposes for which it was intended as explained in this Operator's Manual.

This page intentionally left blank.

Section 12: Diesel fuel and DEF requirements

Diesel fuel sulfur content

Emission compliant engines require Ultra Low Sulfur Diesel (ULSD) fuel, with sulfur content less than 15 ppm (15 mg/kg). Use of fuels other than what is specified in the engine manual will impact engine performance, damage engine emissions systems and may result in engine and exhaust system warranty being voided.

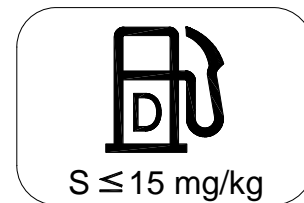

DEF (diesel exhaust fluid)

Fill DEF tank every time you fill fuel tank.

DEF must comply with the ISO 22241 specification. DEF must meet this standard to maintain system reliability. Additives should not be added to reduce the freezing temperature. Additives currently available are more corrosive than DEF and will cause component and system degradation and negatively impact reliability.

DEF freezes at temperatures below 12°F (-11°C) and DEF quality degrades rapidly at temperatures above 140°F (60°C). During operation, a heated tank is equipped to keep the DEF temperature above freezing. To maintain emissions compliance, urea concentration must remain between 31.8% and 33.2%. Most DEF manufacturers meet this concentration.

The shelf life of DEF is directly related to the temperature at which it is stored. Storage temperatures between 12° and 86°F (-11° and 30°C) are recommended to maintain optimal shelf life of up to 2 years.

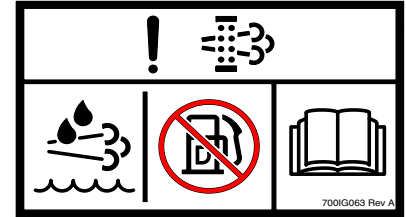

Consistent temperature °F (°C)	Shelf life (approximate months)
≤ 50 (10)	36
≤ 77 (25)	18
≤ 86 (30)	12
≤ 95 (35)	6
> 95 (35)	Test prior to use.

Section 15: Intended use

The ZR51200 is a self-propelled round baler, designed solely for use in baling agricultural crop material.

Always use the machine in accordance with the instructions contained in this operators and maintenance manual, safety signs on the machine, and other material provided by Vermeer Corporation.

Proper maintenance and repair is essential for safety and efficient machine operation. Do not use the machine if it is not in suitable operating condition.





In addition, ensure that a new operator is familiar with all the safety signs, decals, and control operations.

Understanding how a bale is formed and what the various parts of the baler do will aid in operating the baler more effectively.

This page intentionally left blank.

Section 18: Emissions quick reference guide

Cummins 4.5L (272 cid) stage V engines	
Engine oil:	Low ash oil only - API CJ-4 or ACEA-E3
Diesel fuel:	Ultra Low Sulfur Fuel (ULSD) only (S < 15 mg/kg)
Diesel exhaust fluid (DEF):	<ul style="list-style-type: none"> • DEF fluid has limited shelf life. Monitoring DEF quality is important. Engine could derate and shut down due to low DEF quality. • DEF must meet ISO22241-1 standards. • Best practice is to refill the DEF tank whenever filling fuel tank.
Starting:	<ul style="list-style-type: none"> • Refer to <i>Starting Procedure</i> portion of the operators manual. • Wait to start until Preheat Indicator is no longer displayed. • Do not engage starter for more than 30 seconds at a time. Allow starter motor to cool 2 minutes between attempts. • Engine ECM controls automatic ether dosage. DO NOT use any other cold start aids.
Engine warmup:	<ul style="list-style-type: none"> • Below 32°F (0°C), run engine at 1000-1200 rpm. • Engine may vary idle speed as it warms up. • During cold weather, an automatic regeneration to warm up the aftertreatment system is common.
Operation:	<ul style="list-style-type: none"> • Do not operate at high idle when engine is cold. • To prevent carbon build-up and cylinder glazing, limit unnecessary low idle time to 10 minutes. • To prevent permanent damage, fix all errors as they occur.
Shutdown:	<ul style="list-style-type: none"> • Except during an emergency, run engine at low idle for 3 to 5 minutes before shutting off engine. • Except during an emergency, do not shut down while Exhaust System Cleaning System Active Icon is ON. • Before disconnecting battery, verify that DEF system purge is complete. Refer to “Battery disconnect procedure,” page 60-2.
Refer to engine operator’s manual for more information. failure to follow instructions may void engine warranty.	

ISO symbol	What it means	What you should know, do or not do
	DEF tank level or DEF quality low	<ul style="list-style-type: none"> • This area of the screen will change as the level of DEF changes. • Icon will flash when DEF level is low. • Icon will flash and DEF Level red lamp FLASHES indicating DEF level is critically low. • Icon will flash and DEF Level red lamp SOLID indicating DEF level is zero. Power will be reduced or limited to idle. • Turn off engine when safe to do so and refill the DEF tank.
	Exhaust system cleaning lamp	<ul style="list-style-type: none"> • Illuminates when the exhaust system Regen is active. • Ensure that Disable SCR is not active and continue working until there is an opportunity to complete an exhaust system cleaning. To complete a manual exhaust system cleaning, select Initiate SCR in Engine Exhaust Regen Menu. • FLASHES when a stationary exhaust system cleaning event is initiated by selecting Initiate SCR. • This lamp will continue flashing until the stationary cleaning event is complete.
	Exhaust system cleaning stop lamp	<ul style="list-style-type: none"> • Illuminates when the exhaust system cleaning is disabled by selecting menu item Disable SCR, preventing a cleaning event. The Disable SCR should be used only when high exhaust temperatures present a hazard.
	High exhaust system temp (HEST) lamp	<ul style="list-style-type: none"> • May illuminate due to higher than normal exhaust temperature during exhaust cleaning. Operator should ensure exhaust pipe outlet is not directed toward any flammable or combustible surfaces. • Will illuminate during manual exhaust system cleaning.

Engine exhaust regen menu (located in advanced engine menu)

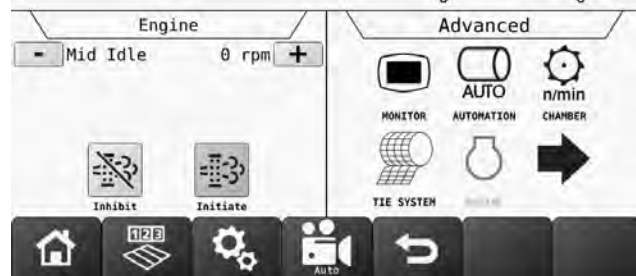

This page intentionally left blank.

Section 20: Machine controls

Tailgate lock valve

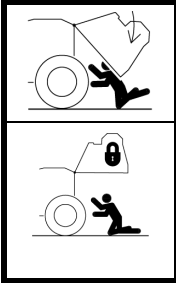

WARNING: A falling or closing tailgate can crush, resulting in death or serious injury.

Move tailgate lock valve to locked position before working under tailgate.

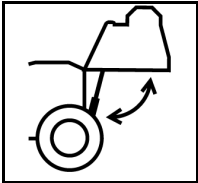

Rotate tailgate lock valve handle (1) down (counterclockwise) to place tailgate lock valve in LOCKED position (B). This prevents unexpected tailgate movement.

Rotate tailgate cylinder lock valve handle (1) up (clockwise) to place tailgate lock valve in UNLOCKED position (A).

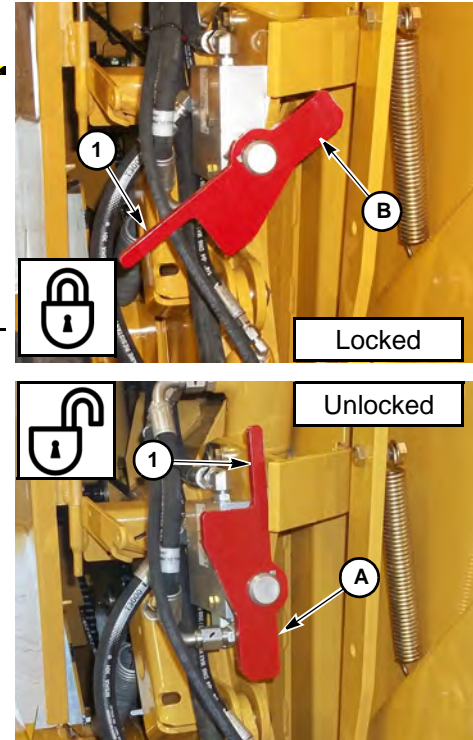

Engine controls

(1) Ignition switch

Vertical OFF
Shuts down engine and electrical system.

First position clockwise RUN/electrical system ON
Engine preheat position. Wait for *Wait-to-Start Indicator Light* to go out before cranking engine.

Second position clockwise START
Release key immediately after the engine starts.

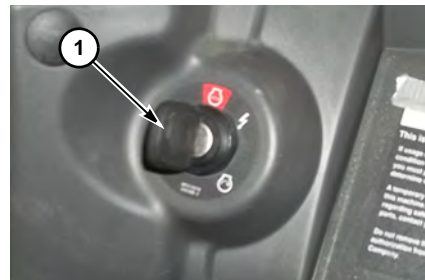

(2) Engine RPM rotary switch

Rotate right high idle

Rotate middle adjustable half idle

Rotate left low idle

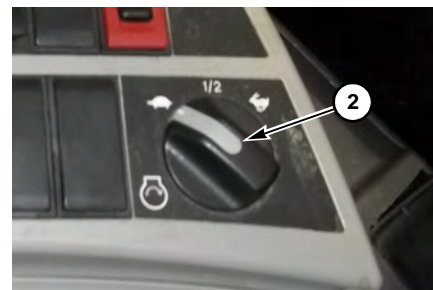
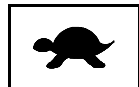

Ground drive controls

(1) Secondary brake pedal

Push down apply brake

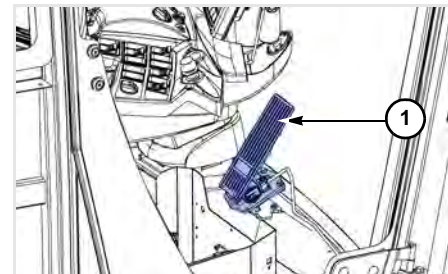

When brake pedal is released, machine resumes previous speed.

(2) Manual park brake switch (locking)

Press top of switch engage park brake
Park brake icon is shown on display



Press and hold, slide back to unlock
press bottom of switch disengage park brake
Ground drive is not allowed when manual park brake is engaged.

(3) Ground drive speed control lever



Push forward variable speed forward



Center neutral
Neutral Start Interlock system prohibits machine from starting if ground drive control is out of neutral. Park brake engages when machine is in neutral and disengages when moved out of neutral.



Pull backward variable speed REVERSE
Backup alarm will sound when ground drive control is moved in REVERSE. Refer to [page 60-16](#).

Move lever farther in either direction to increase ground speed.
Maximum forward ground speed may be reduced depending on setting of *Maximum Speed Limiter Rotary Switch*.

(4) Field/Transport mode switch (locking)

Press and hold, slide up to unlock, then push top of switch to enable Field mode.

Push bottom of switch to enable Transport mode.

(5) Maximum speed limiter rotary switch

Press to activate maximum speed limiter (forward speed only).
Rotate to adjust maximum speed limit. Set speed limit is shown on display.
Return *Ground Drive Speed Control Lever* to neutral, then press to deactivate.

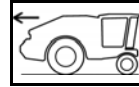
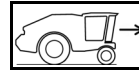

(6) Counter-rotation button

Press and holdenable Counter-Rotation mode

Press and hold button while rotating steering wheel left or right to counter-rotate drive wheels. Counter-rotation mode is only available while in Field mode.

(7) Pressto resume baling after ejecting a bale in Auto mode

(8) Pressto cancel Auto mode

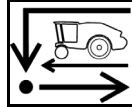

(9) Steering wheel

(10) Steering column tilt

Grab steering wheel with your hand.
Press lever down with foot and tilt column to desired position.
Release lever to lock steering column in position.

(11) Steering wheel tilt

Grab steering wheel with your hand.
Push lever up and tilt the steering wheel to the desired position.
Release lever to lock steering wheel position.

(12) Steering wheel extend

Grab steering wheel with your hand.
Rotate center knob a quarter turn to the left and push or pull steering wheel to the desired position.
Rotate center knob a quarter turn to the right to lock steering wheel position.

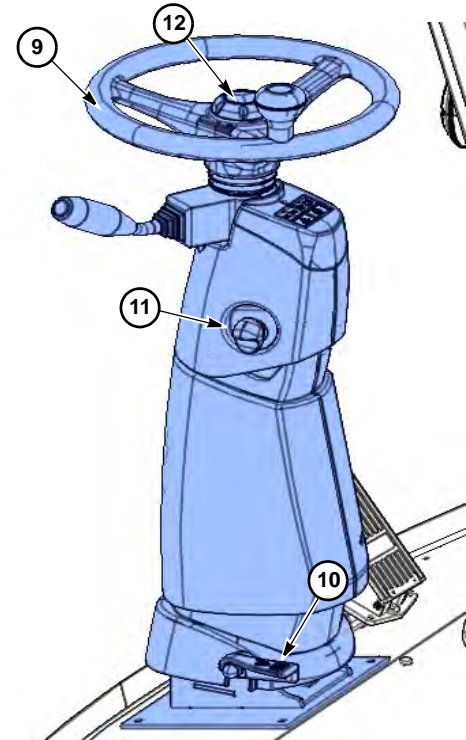
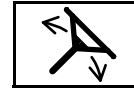
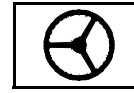

(13) Horn
Push button sound horn

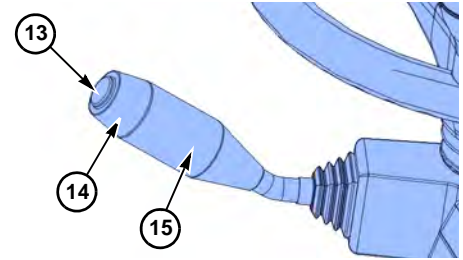

(14) Windshield washer control
Push knob spray washer fluid on windshield



(15) Windshield wiper control
Rotate knob to desired position.



Turn to position OFF



Turn to positionLOW speed



Turn to position HIGH speed



(16) Headlight control

Push forward low beam



Push forward again high beam

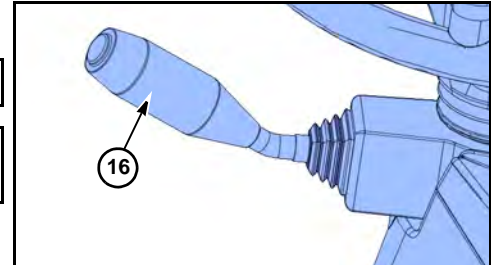

(17) Turn signal control

Push up right turn signal



Push down left turn signal

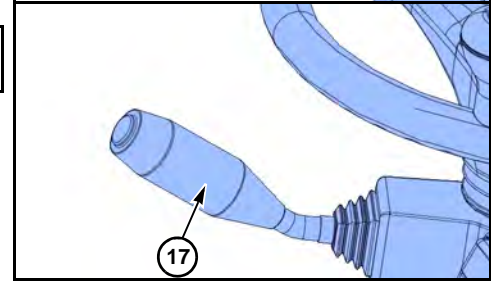

Baler controls

(1) Bale chamber drive control

Squeeze knob and collar, then pull engage baler drive

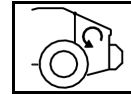

Push disengage baler drive

(2) Tailgate raise control

Push raise tailgate

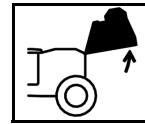

(3) Tailgate lower control

Push lower tailgate

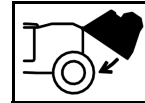

(4) Pickup lift control

Push button. raise pickup

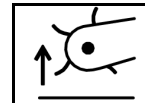

(5) Pickup lower control

Push button. lower pickup

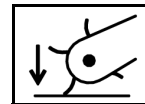

(6) Auto mode

Push bottom activate rear-eject Auto mode

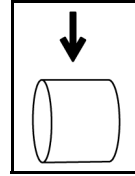

Push left activate left-eject Auto mode

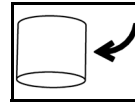

Push right activate right-eject Auto mode

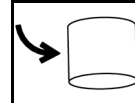

Push top no function



Diesel particulate filter controls

Under normal working conditions, the DPF regeneration process is automatic and requires no operator action. However, on occasion, a manual regeneration (regen) may be required.

(1) DPF initiate regeneration

Navigate to *Engine Advanced Settings Screen*.

Touch softkey.....Manual Regen on

In order for a manual regen to occur, park brake (either manual or while in NEUTRAL) must be engaged, engine must be at low idle, and coolant temperature and soot load must be at appropriate levels.

(2) DPF inhibit regeneration

Touch softkey.....Auto Regen off

NOTICE: Auto DPF regen should **not** be turned off unless high exhaust temperature presents an immediate hazard. To cancel DPF Inhibit, turn *Ignition Switch* off.

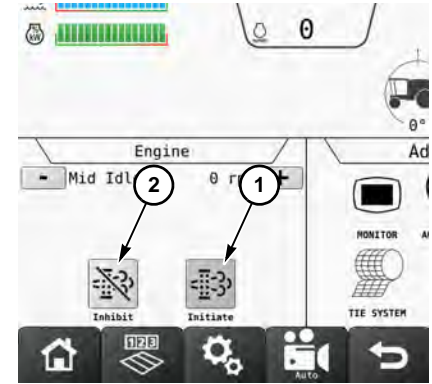
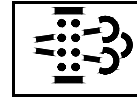

Accessory controls

(1) Warning flasher switch

Push top of switch warning flashers on

Push bottom of switch warning flashers off



(2) Dome light switch

Push. on

Push again. off

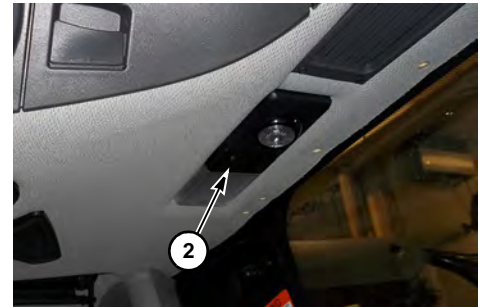
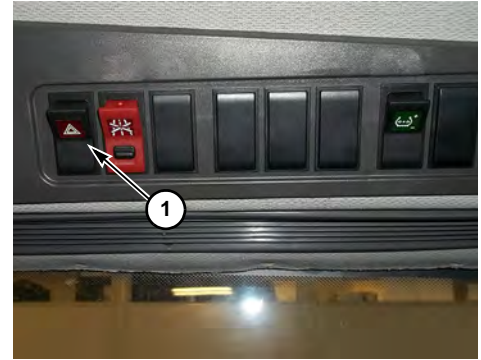

- (3) **Exterior mirrors switch**
Rotate outer knob select left or right mirror

Use center knob to adjust mirror position.

- (4) **Beacon light switch**
Rotate clockwise on
Rotate to center off



- (5) **Transport light switch**
Rotate to 1, no function
Rotate to 2, lower lights on
Rotate to 3rd position, two upper lights on
Rotate to O, all headlights off



- (6) **Work light switch**
Rotate to 1, upper work lights on
Rotate to 2, upper work lights on
Rotate to 3rd position, upper work lights on
Rotate to O, all work lights off

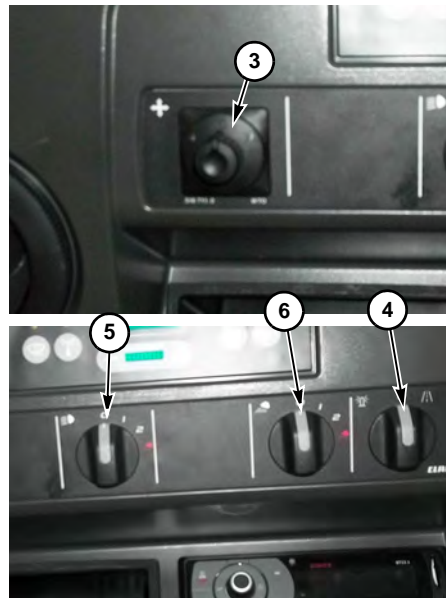

- (7) **A/C display screen**
- (8) **Function indicator bar**
- (9) **Function decrease softkey**
Touch softkey to decrease function operation.

- (10) **Function increase softkey**
Touch softkey to increase function operation.

- (11) **Defrost softkey**
Touch softkey to turn defrost function on and off.
LED (A) is illuminated when function is on.

- (12) **Manual fan speed softkey**
Touch softkey to turn manual fan speed function on.
LED (B) is illuminated when function is on.
Touch *Minus Softkey* (9) to decrease fan speed. Touch *Plus Softkey* (10) to increase fan speed.
When LED is not illuminated, *Plus/Minus softkeys* increase/decrease temperature setting.

- (13) **ECON mode softkey**
Touch softkey to turn ECON function on and off.
LED (C) is illuminated when function is on.

- (14) **Outside air temperature softkey**
Touch softkey to turn Outside Temperature function on and off.
LED (D) is illuminated when function is on.
Outside temperature is shown on display.

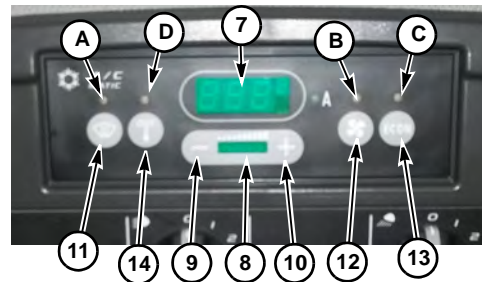
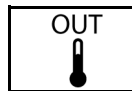
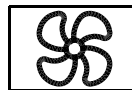
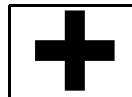

(15) 12-volt accessory outlet



Cab access steps

Use steps **(1)** and handholds **(2)** to enter and exit cab.

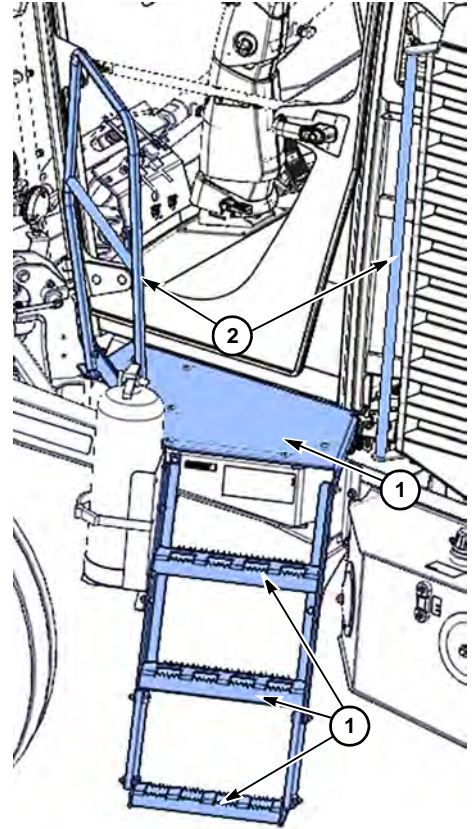

Cab door

- (1) **Outside latch**
Push button and pull handleopens door

- (2) **Inside lever**
Pull leveropens door

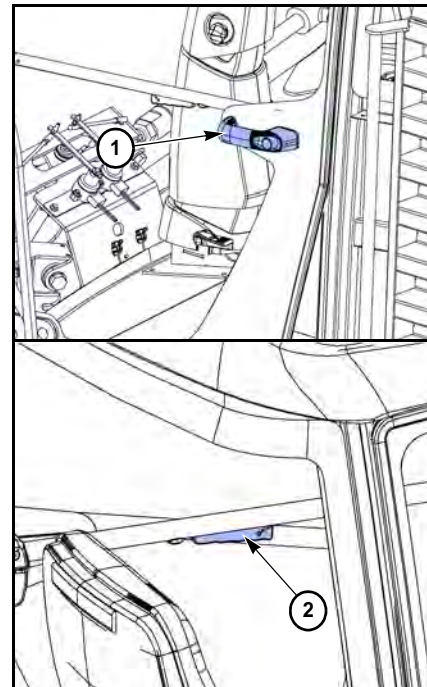

Emergency exit

(1) Emergency exit lever

Pull handle and swing up release emergency exit

Push handle forward, then push pane out fully open emergency exit

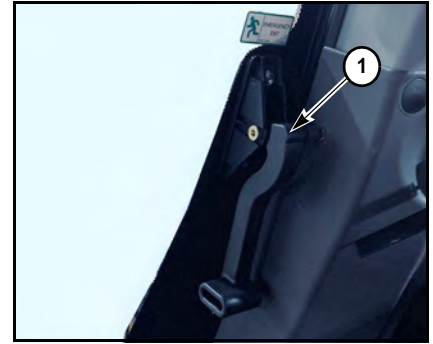

Front sunscreen

(1) Sunscreen

Pull the center of the roll-up sunscreen down to desired level.

(2) Release cord

Pull release cord to raise roll-up sunscreen.

Hold center of sunscreen to control retraction speed.

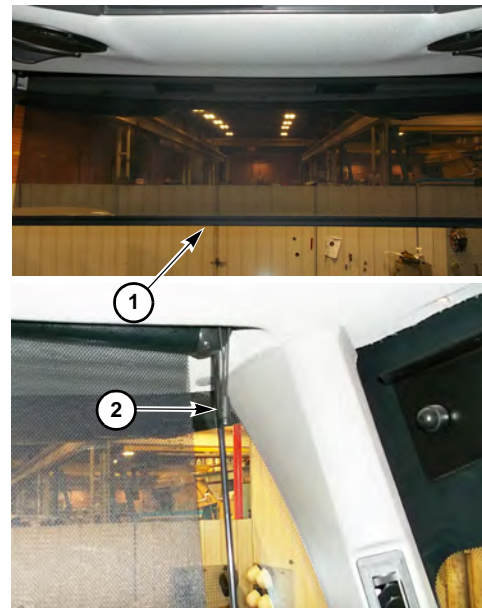

Seat belts and seat controls



WARNING: Failure to wear seat belt may lead to being thrown from seat which could result in death or serious injury. The seat belt is an essential part of safe operation. Always wear seat belt when machine is being driven.

(1) Seat belt

Seat belt must be worn at all times while operating machine.

Machine has a 2" (5 cm) seat belt with inertia reel. Belt length adjustments are not required. Ensure all slack is removed from belt. Seat belt must be snug but not tight.

(2) Seat suspension adjustment switch

Press adjust height of seat

(3) Seat base slide lever

Pull Up slide seat base forward or backward

(4) Seat tilt lever

Pull Up adjusts tilt of seat

(5) Operator presence switch

The seat is equipped with an operator presence switch. The operator must be seated to operate multiple machine functions.

(6) Instructional seat with seat belt

Use only temporarily for instructing new operator or diagnosing the machine. Not a passenger seat.

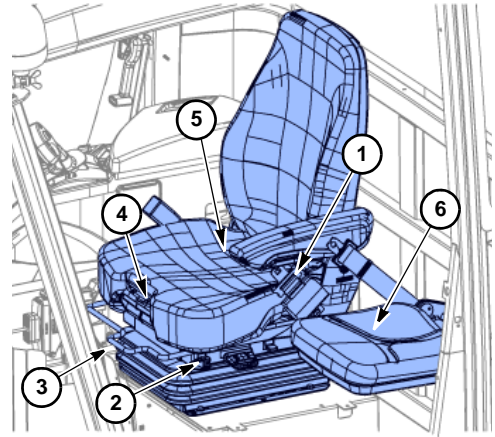

Operator presence system

The machine is equipped with an Operator Presence system that uses a switch in the seat to detect the presence of an operator. The operator must be seated for engine start, as well as the ground drive and other machine functions to be engaged.

If the operator leaves the seat while ground drive or other machine functions are engaged, ground drive will move to zero and most other machine functions will stop (netwrap will not stop). Controls must then be reset to neutral or off before resuming work.

The Operator Presence system must be maintained in good functional condition. Contact your Vermeer dealer if it does not function correctly.

Access panels and doors

Fuel and DEF fill locations

- (1) Fuel fill
- (2) DEF fill

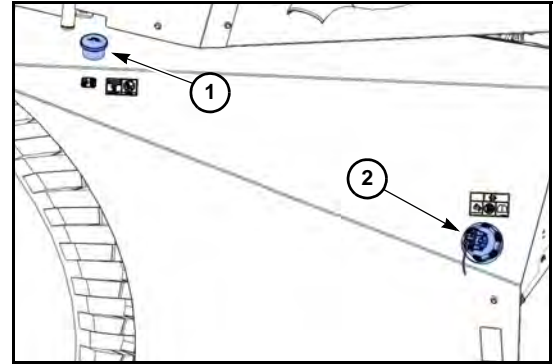

Hydraulic fluid fill

- (3) Hydraulic fluid fill
- (4) Hydraulic fluid level gauge

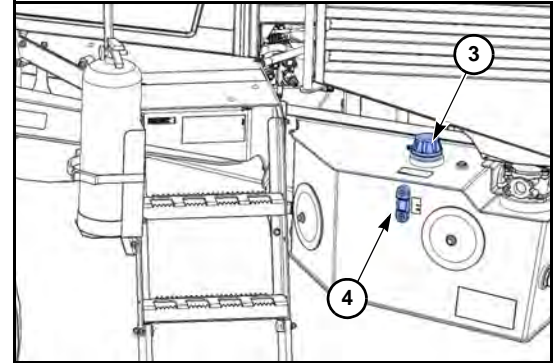

(5) Left side access door

Turn handle **(A)** counterclockwise and pull to open.

(6) Right side access door

Turn handle **(B)** counterclockwise and pull to open.

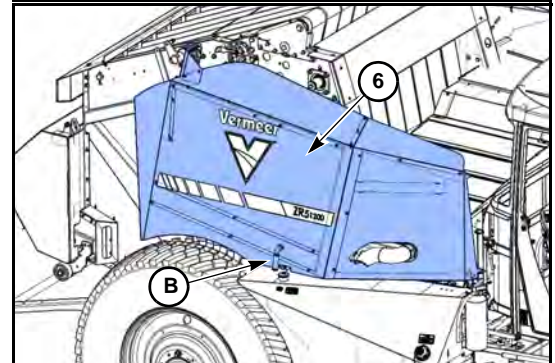
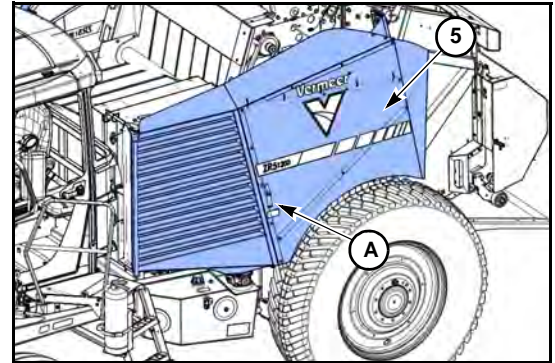

Fire extinguisher mounting location

Two fire extinguishers are available with the machine. An ABC fire extinguisher (1) is mounted on the right side of machine by the DEF tank. A water fire extinguisher (2) is mounted outside the left side cab door.

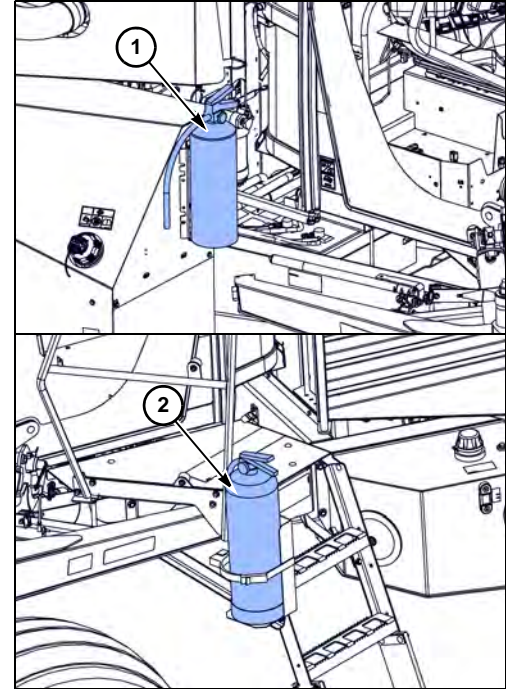

Section 21: Electronic controller

Electronic control system

The electronic control system includes Electronic Control Unit (ECU) mounted on the bale chamber and power unit, and the monitor mounted on the machine. The ECUs sense inputs, controls outputs, activates automatic sequences, and send information to the monitor. Wire harnessing includes sensors, outputs, a Controller Area Network (CAN) bus, and data line, which allows communication between the ECUs and monitor in real-time.

Electronic control system - functions

The electronic control system incorporates the following functions:

- bale size indication
- bale count indication
- fault and alarm information
- field statistics display
- tailgate status indication (open or closed)
- bale shape indication
- starts and monitors netwrap operation
- crop moisture display

Electronic control system - protection and care

The electronic control system is designed for 12-volt operation. Operation with other on-board power supplies is not permissible!

NOTICE: The monitor is **not** waterproof or dust proof and can be damaged by moisture and excess dust.

Clean the monitor with a moist, fuzz free, cotton cloth. If necessary, a mild cleaning agent can be used. Do not use acid or abrasive cleaning agents.

Monitor face and control functions

Monitor - home screen



Monitor power on/off

Monitor is turned on/off with machine *Ignition Keyswitch*.

Monitor consists of a liquid crystal display (LCD) (1) with a bank of softkeys (2) on the bottom of the monitor and touchscreen.

When monitor is turned on, ECU also turns on and screen indicates control system is performing system checks and loading machine information into the monitor.

If faults are detected during system check, fault identification screen is displayed.

If no faults are detected, default “Home” screen (3) then appears after 10–15 seconds and machine is ready for baling. Use *Expand Softkey* (4) to switch between default “Home” screen and alternate “Home” screen (5).

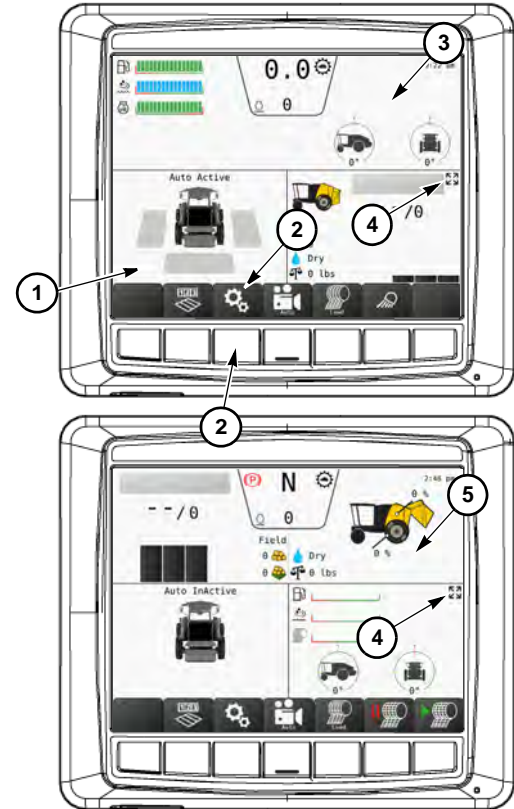

Monitor functions and screen symbols



Audible sound device (1)

Volume selection can be made in the Program Selection/ Configuration menu.



USB data port (2)

Available for installing new software. Located on bottom of monitor.

When "Home" screen (3) is shown, screen indicates which function is taking place and parameters of bale shape and size and other bale and field statistics made during bale formation.



Baler operation icon (4)

Appears during normal baling operation to indicate tailgate is closed and locked.

Belt speed (A) and pickup speed (B) are shown on display as a percentage of standard speed.



Tie operation status (5)

Shows current status of selected tie operation. For example: display shows netwrap function is progressing through a cycle.



Netwrap roll diameter monitor (6)

Monitor shows amount of remaining netwrap roll to inform operator when netwrap roll needs to be replaced.

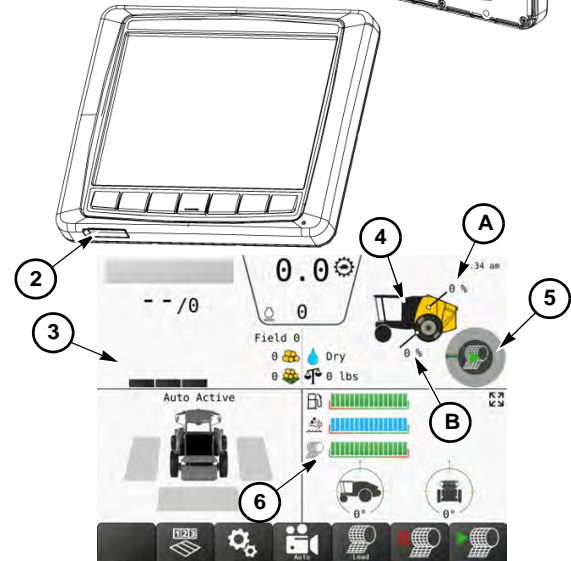
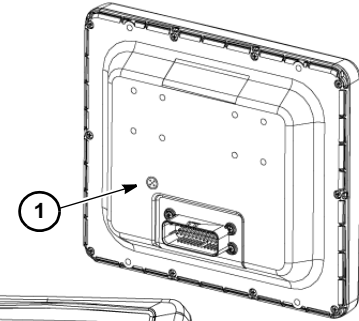

Navigation Softkeys



Home softkey (1)

Touch softkey to return to the “Home” screen.



Back softkey (2)

Touch softkey to return to previous screen.



Expand softkey (3)

Use this selector softkey to navigate between default Home screen and alternate Home screen.



Settings softkey (4)

Touch softkey to access settings menu screen.



Field control softkey (5)

Touch softkey to access field control screen.

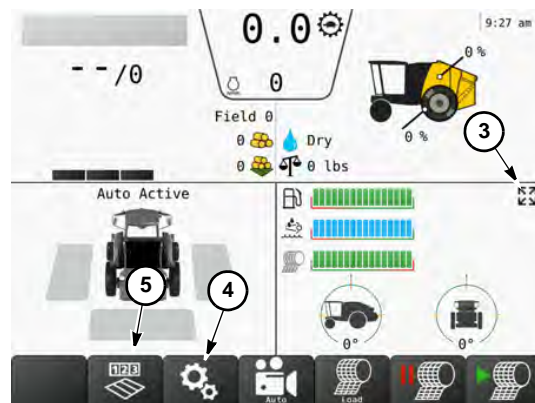
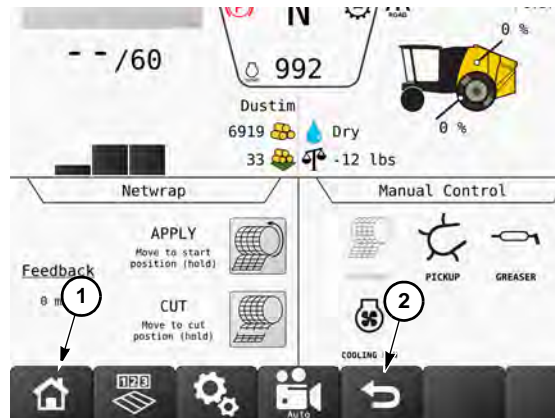



Camera mode softkey (6)

Touch softkey to open Camera mode selection.



Auto camera selection softkey (7)

Touch softkey to enter Auto Camera mode. Camera will automatically switch between *Pickup* and *Tailgate Camera mode*.



Pickup camera selection softkey (8)

Touch softkey to enter *Pickup Camera mode*.



Tailgate camera selection softkey (9)

Touch softkey to enter *Tailgate Camera mode*.

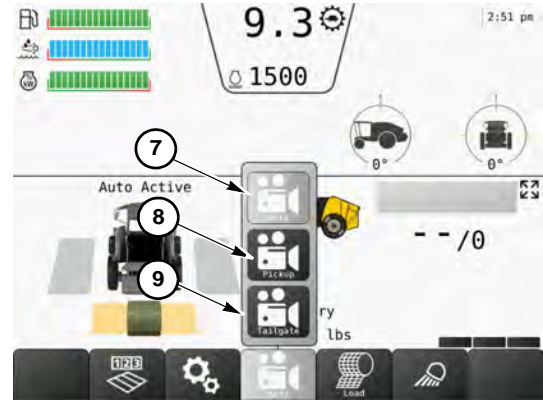
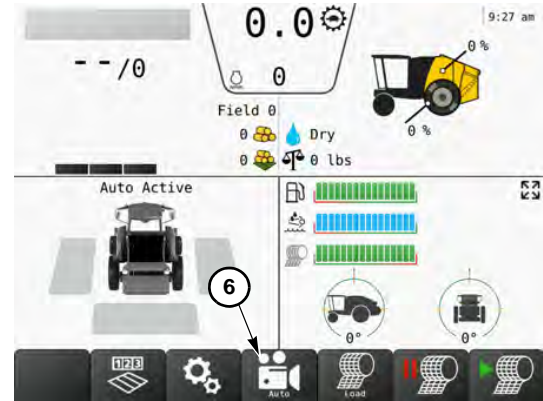

Bale Size Screen Symbols

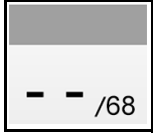

Current bale size (1)

Indicates current size of bale in chamber during bale formation and displayed as a numerical value (in/cm). A “-” will be shown until the bale reaches 30" (76 cm). Beginning with 31" (79 cm), the current bale size will be shown.



Full bale target size (2)

Full bale target size number selected.

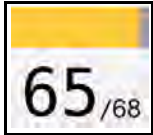

Near full bale (5)

When “Near Full Alert” feature is set to 7, bar color changes to yellow and two short beeps sound when bale is at a preset size or default of 7" (18 cm) below full bale size. When set to 0 yellow bar will not appear with no sound. To change near full alert setting contact your Vermeer dealer.

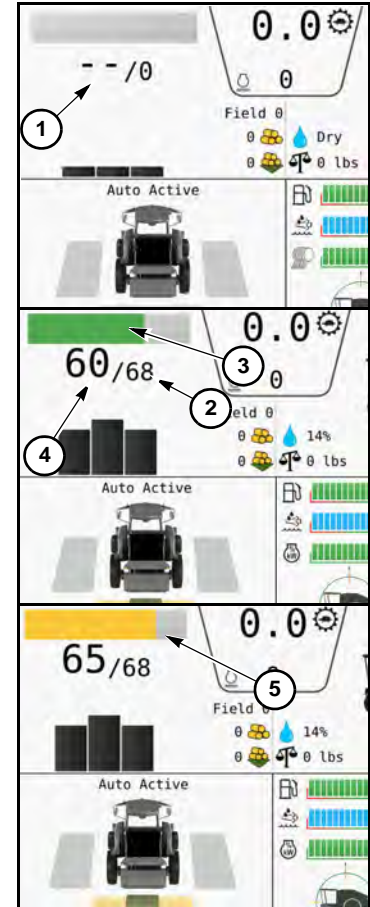

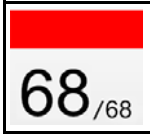

Full bale (6)

Bar color changes to red and one long beep sounds.



Bale size overflow (7)

When bar fills beyond the line which represents a full bale, an overflow alarm is displayed and logged when sensed bale size is at least 55" (140 cm) **(8)** and signal from overflow sensor is received.

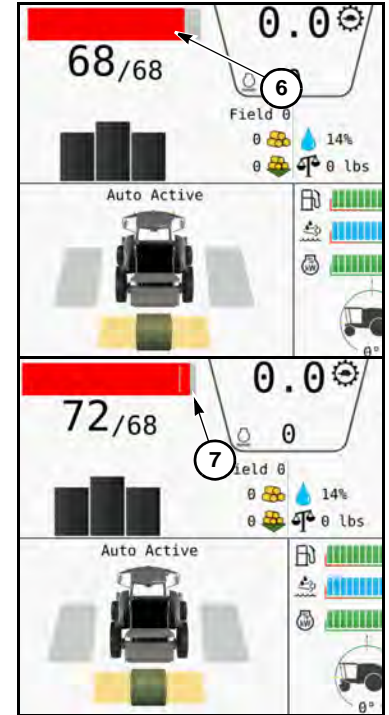

Bale shape and information boxes



Bale shape bars (1)

Indicate belt tension at left-hand end, right-hand end, and center of bale. Tighter belts correspond to a part of bale containing more hay, and are indicated by taller bars on the display.

Touch *Settings* softkey (4), *Calibration* softkey (5), *Bale Shape* softkey (6), then follow on-screen directions (7) to calibrate bale shape bar display.

Field information data (2)

Information shows different field information. Touch *Field Control* softkey (3) to switch between field information.

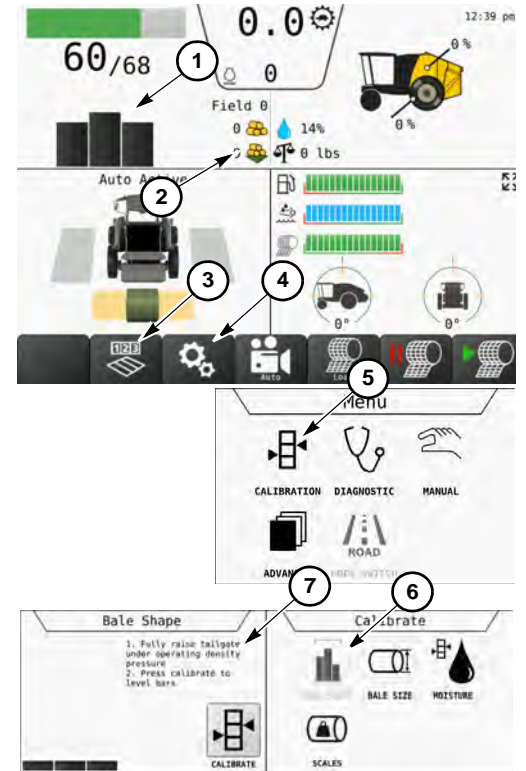

Bale weight



Weight display (1)

Provides real-time bale weight data in pounds while baling.



Zero scale

Touch *Settings* softkey (2), *Calibration* softkey (3), *Scales* softkey (4), then follow on-screen directions (5) to zero scale.

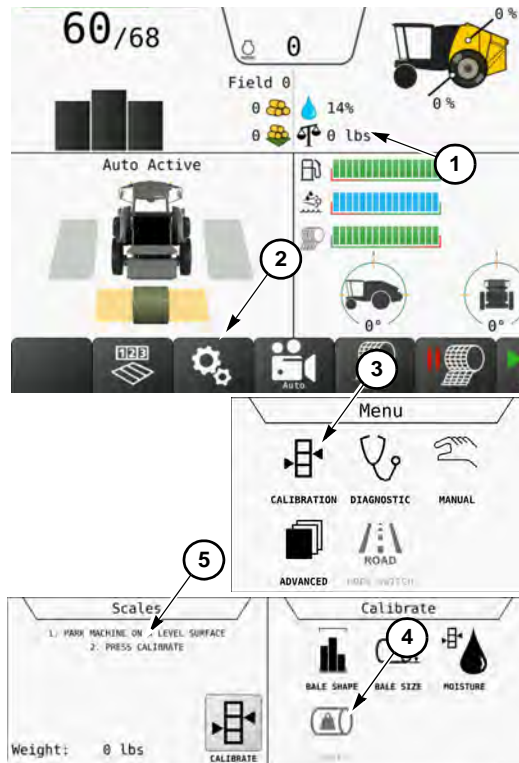

Bale chamber tailgate screen symbols



Tailgate fully closed (1)

When symbol is present, tailgate is fully closed and locked for normal operation. A short signal also sounds to indicate that the tailgate is closed completely.



Bale wrap complete (2)

When symbol is present, bale wrap is complete, open tailgate.



Tailgate unlocked and open (3)

When symbol is present, tailgate is unlocked and open.

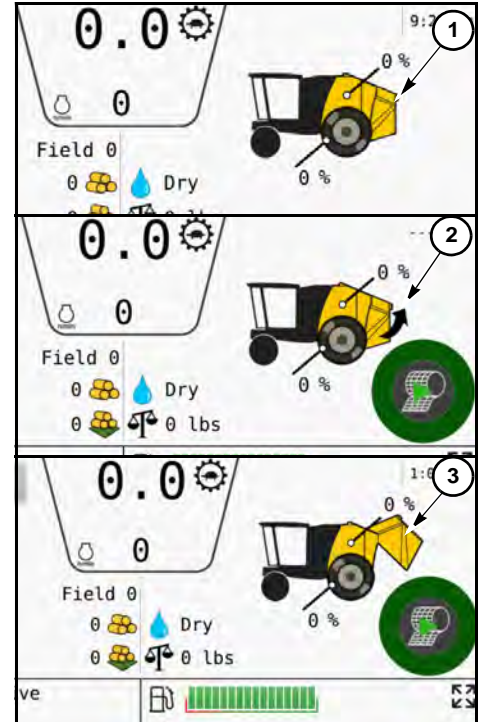

Fault screen symbols



High priority alert (red) (1)

High Priority Alert Indicator where damage to machine is likely. Stop all operations and shut down machine.



Medium priority alert (yellow) (2)

Medium Priority Alert Indicator where damage to machine is possible, but where normal operation of machine may be continued temporarily.

Number of active faults (3)

High priority fault will be stored in memory list.
Medium priority fault will be stored in memory list.

Diagnostic troubleshooting codes (DTC) (4)

A combination of Suspect Parameter Number (SPN) and Failure Mode Identifier (FMI), which are standard ISO fault codes.

Error description (5)

Text describes the current fault displayed.



OK softkey (6)

Touch Green Check softkey to acknowledge notification of fault and return to previous screen or menu.

When a fault occurs, follow on-screen instructions.

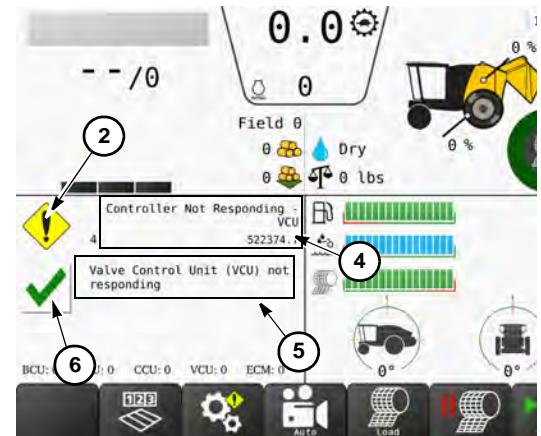
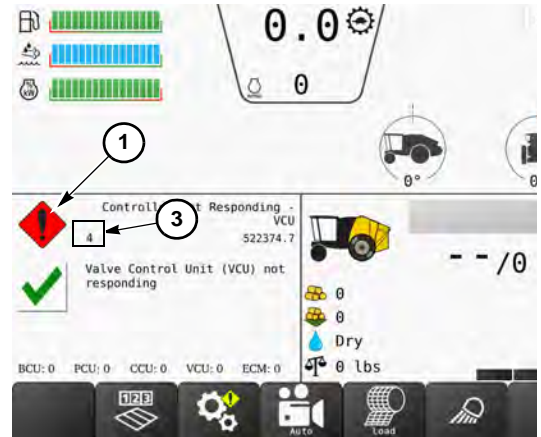

Programming and Configuration Functions

To resume normal operation touch Home softkey to return to the “Home” screen.

Depending on software revision, the ECU may have additional settings not explained in this manual. These additional settings should remain at factory-set values to ensure proper operation.

Bale chamber setup screen

Bale chamber setup screen allows operator to adjust bale target size and set net wraps.

To view baler setup menu screens:

Step 1: Touch *Settings softkey* (1) to access “Baler Setup” screen (2).

Step 2: Menu items appear for changing parameters:

“Bale Size” (3)

“Net Wraps” (4)

Step 3: Touch *Home softkey* (5) to return to “Home” screen.

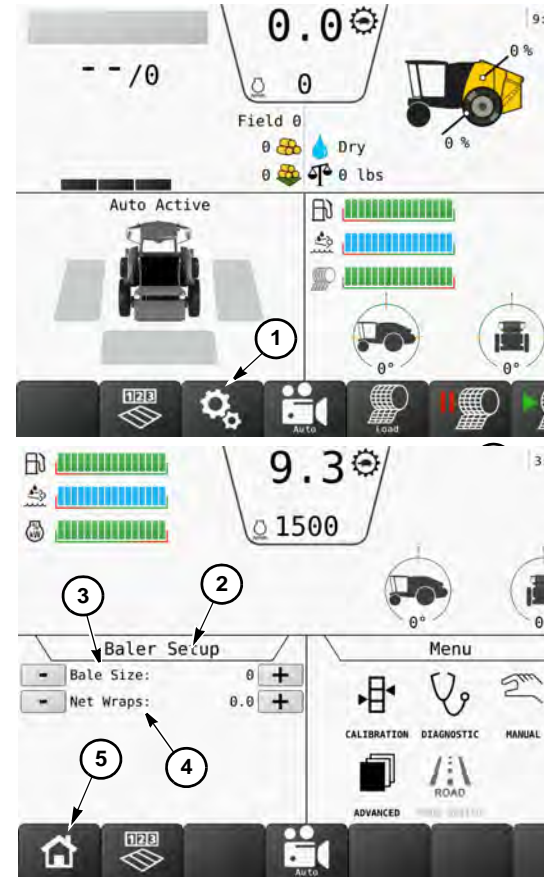

Bale size - setup mode

Generally, the smallest desirable bale is 46" (117 cm) in diameter. Maximum bale size is 72" (183 cm). Rotary sensor **(6)** senses bale size during bale formation, and provides this information to the operator via bale size bar display on the monitor.

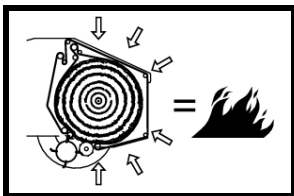

CAUTION: Oversized bales place excessive load on belts, rollers and bearings which could result in product or property damage and is a fire hazard.

When in "Baler Setup" screen **(1)**:

- Step 1:** Touch *Minus* **(2)** or *Plus* **(3)** softkeys to adjust "Bale Size" setting **(4)**.
- If adjusting bale size during bale formation, full bale size setting cannot be less than current bale size.
 - Adjustments to bale size are not allowed during wrap cycle.
 - Recalibrate bale size to confirm actual bale size matches current bale size with wrapped bale in chamber.
- Step 2:** Touch *Home* softkey **(5)** to save settings and return to the "Home" screen.

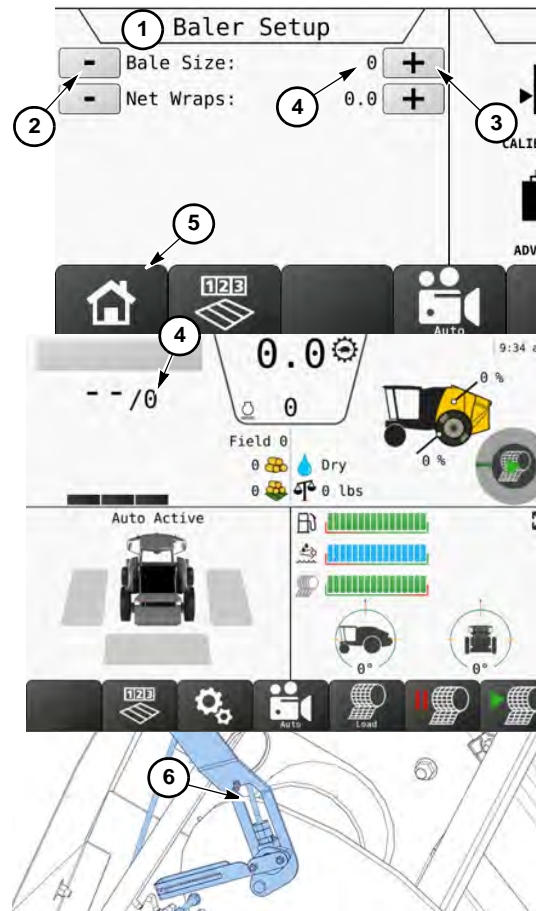

Vermeer TempSense operation

Bearing status can be monitored via the home screen. High bearing temperatures can be indicative of a worn or dry bearing, and can cause issues with proper baler operation.

Bearing temperature and status are represented with icons of various colors:

- **Green:** Normal bearing state.
- **Gray:** Bearing sensor is disconnected or offline.
- **Yellow:** Bearing temperature is above normal operating range. Monitor closely.
- **Red:** Bearing temperature is high and requires operator attention. Stop baling immediately and repair as necessary.

To view bearing temperature information:

Step 1: Touch the *baler speed/bearing status softkey* (1) from the “Home” screen to switch from the baler speed overview (2) to bearing status overview (3).

Left and right bearing statuses are represented using a single-colored dot (4) on the overview screen. More detailed information can be viewed on the bearing temperature screen.

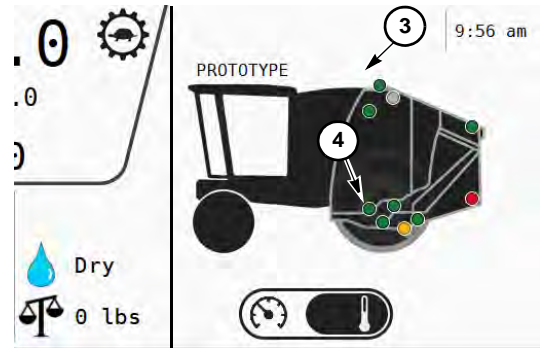
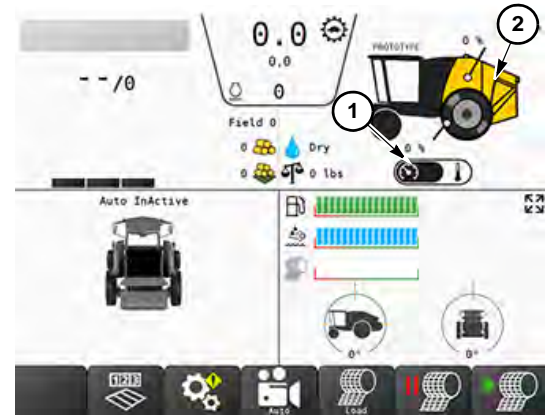

Step 2: Touch anywhere on the bearing status overview to access the bearing temperature screen (5).

The bearing temperature screen shows both sides of the machine, and provides individual bearing temperatures represented using individual colored dots with a number (6).

The number corresponds to list (7) that provides the temperature of each individual bearing.

If a bearing icon is colored in gray (indicating sensor is disconnected or offline), no temperature will be provided in list (7).

Step 3: Touch *Home softkey* (8) to return to the “Home” screen.

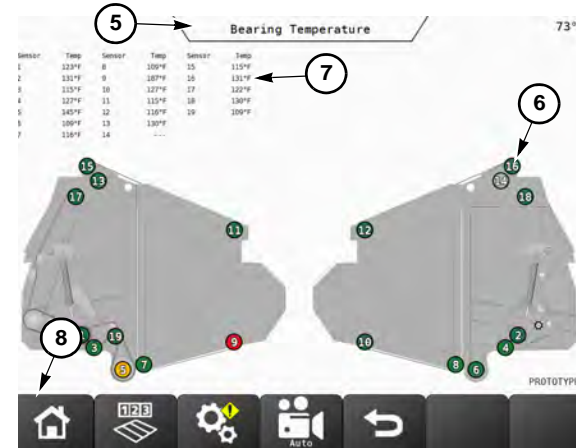

Vermeer TempSense regulatory notice

FCC notice

This device complies with part 15 of the FCC Rules. Operation is subject to the following two conditions:

- (1) This device may not cause harmful interference; and
- (2) This device must accept any interference received, including interference that may cause undesired operation.

NOTE: This equipment has been tested and found to comply with the limits for a Class A digital device, pursuant to part 15 of the FCC Rules. These limits are designed to provide reasonable protection against harmful interference when the equipment is operated in a commercial environment. This equipment generates, uses and can radiate radio frequency energy and, if not installed and used in accordance with the instruction manual, may cause harmful interference to radio communications. Operation of this equipment in a residential area is likely to cause harmful interference in which case the user will be required to correct the interference at his own expense.

Any changes or modifications in construction of this device which are not expressly approved by the party responsible for compliance could void the user's authority to operate the equipment.

IC radiation exposure statement

To comply with RF exposure compliance requirements, the device should be installed and operated with a minimum of 20 cm (7.87 in) between the device and your body. The device should not be used in other configurations.

Pour se conformer aux exigences de conformité en matière d'exposition aux RF, l'appareil doit être installé et utilisé à une distance minimale de 20 cm (7,87 po) entre l'appareil et votre corps. L'appareil ne doit pas être utilisé dans d'autres configurations.

Industry Canada statement

This device complies with Industry Canada's license-exempt RSSs. Operation is subject to the following two conditions:

- (1) This device may not cause harmful interference; and
- (2) This device must accept any interference received, including interference that may cause undesired operation.

Le présent appareil est conforme aux CNR d'Industrie Canada applicables aux appareils radio exempts de licence. L'exploitation est autorisée aux deux conditions suivantes : (1) l'appareil ne doit pas produire de brouillage, et (2) l'utilisateur de l'appareil doit accepter tout brouillage radioélectrique subi, même si le brouillage est susceptible d'en compromettre le fonctionnement.

This page intentionally left blank.

Section 22: Starting procedure

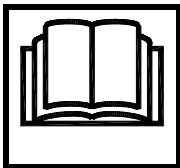

WARNING: Read operator's and maintenance manual and safety signs before operating machine.

Starting the engine

Complete daily maintenance before starting engine. Refer to [Maintenance, page 60-1](#).

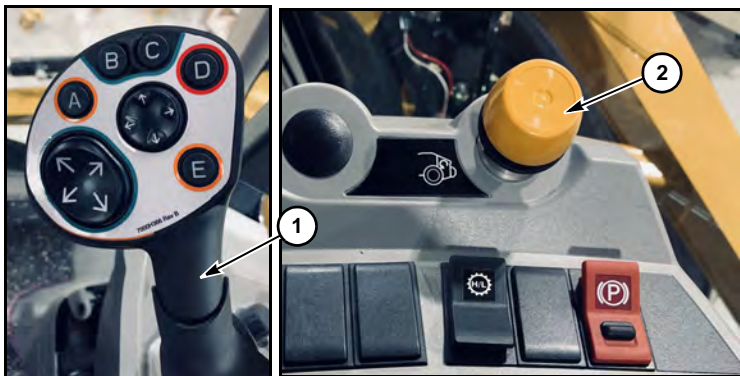

Step 1: Use the following control settings to start the machine:

- (1) **Ground drive lever**neutral
- (2) **Baler drive control**pushed to off
- (3) **Operator**must be in seat

Step 2: Sound horn (4) to signal engine starting.

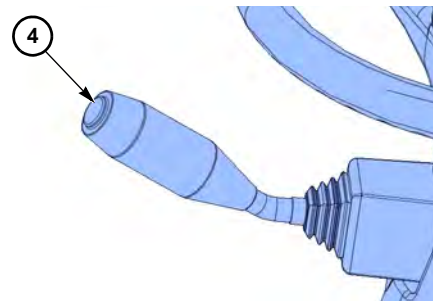

Step 3: Turn ignition switch **(5)** to on and wait for wait-to-start indicator light to go out.

Step 4: Start engine. Allow keyswitch to return to on position immediately after engine starts.

NOTICE: Do not crank starter motor for more than 20 seconds per attempt. Allow starter motor to cool 2 minutes between attempts.

Step 5: Allow engine to idle for 3–5 minutes or until coolant temperature begins to rise. **Wait for engine to run smoothly at idle** before proceeding with normal operation.

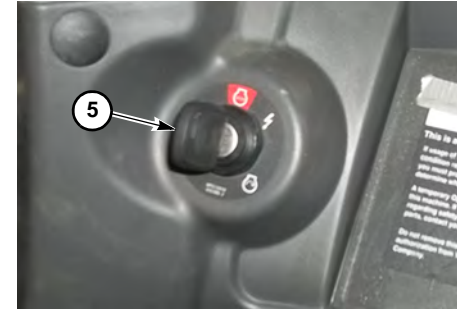

Extended idle periods

If extended idle is necessary for any reason, consult the engine operation manual for allowable idle RPM and time periods. Prolonged idle at slow speeds can allow engine to cool and damage engine components.

Cold weather starting



CAUTION: Handheld aerosol starting aid use can cause explosion. Personal injury is possible from flying debris and fire. Do not use handheld aerosol starting aids such as ether.



NOTICE: Handheld aerosol starting aid use can cause explosion. Engine damage is possible. Do not use handheld aerosol.

For frequent starts below 10°F (-12°C), consult your Vermeer dealer. Refer to the engine operation manual for additional information.

Engine can be forced to derate if DEF is not completely thawed out within 30 minutes of startup.

Jump-starting (12-volt system)

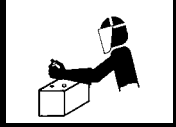
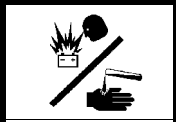
Battery explosion - avoid



WARNING: Battery fumes are flammable and can explode. Keep all burning materials away from battery. Battery explosion can blind. Acid can blind and burn. Tools and cable clamps can make sparks.

Do not smoke. Shield eyes and face. Read instructions.

Do not jump-start or charge a battery that is frozen or low on electrolyte.

Avoid explosion hazard. If equipped with battery caps, they must be in place and tight to reduce risk of battery explosion.

NOTICE: Use only a 12-volt system for jump-starting. Do not allow booster vehicle to be in contact with the disabled machine. Vehicles in contact have a ground connection which allows a spark to occur at the battery when the positive jumper cable is connected or removed.

Battery burns - avoid

Battery contains sulfuric acid which can cause severe burns. Avoid contact with eyes, skin, and clothing.

In case of acid contact:

External: Flush with plenty of water. If eyes have been exposed, flush with water for 15 minutes and get prompt medical attention.

Internal: Drink large quantities of water or milk, follow with milk of magnesia, beaten egg, or vegetable oil. Call a physician immediately.

Jump-starting procedure

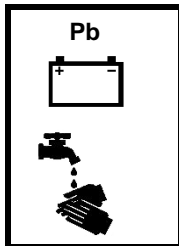

WARNING: Battery post, terminals, and related accessories contain lead and lead compounds.

Wash hands after handling.

Step 1: Turn ignition key off.

Step 2: Connect jumper cables in the following order:

- Red **(A)** to discharged battery positive (+) terminal **(1)**.
- Red **(A)** to boost battery positive (+) terminal **(2)**.
- Black **(B)** to boost battery negative (-) terminal **(3)**.
- Black **(B)** to discharged machine frame **(4)**, away from discharged battery.

Step 3: Start engine.

Step 4: Remove cables in **reverse** order and install red cover over positive battery cable clamp.

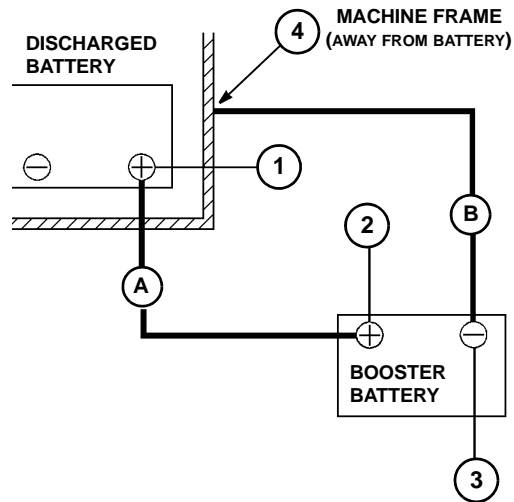

Section 23: Shutdown procedure

Stopping the engine

When stopping the machine, use the following shutdown procedure:

For your safety and the safety of others, the shutdown procedure must be followed before dismounting from the cab for servicing, cleaning, or inspecting the baler.

Step 1: Ensure bale chamber is empty. Do not leave bale or partial bale in bale chamber.

Step 2: Place ground drive lever in neutral.

Step 3: Fully lower pickup.

Step 4: Reduce engine speed to low and disengage bale chamber drive.

NOTICE: Whenever practical and safe, **allow engine to idle low for 1 to 5 minutes** before shutting down after operating at full power. Please consult your engine manual for details.

Step 5: Turn ignition switch to off and remove key.

Tailgate hydraulic controls are automatically set to neutral and pickup will lower when engine is shut down.

If working in bale chamber, move tailgate cylinder lock valve handle **(1)** down to locked position **(A)** to prevent unexpected tailgate movement.

A variation of the above procedure may be used if so instructed within this manual or if an emergency requires it.

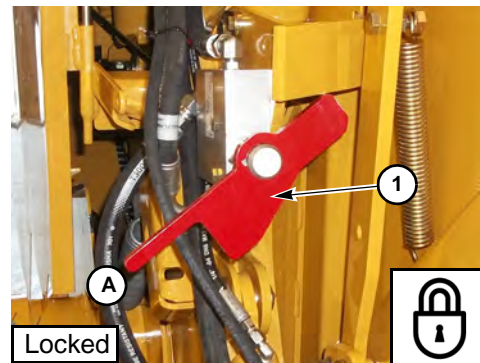

This page intentionally left blank.

Section 25: Preparing the equipment

Prepare the machine

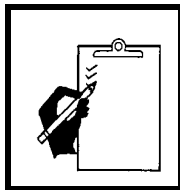

WARNING: Check machine before operating. Machine must be in good operating condition and all safety equipment installed and functioning properly.

Controls familiarity

Refer to “Machine controls,” [page 20-1](#), for control locations and operating instructions.

Adjust seat for best access to controls.

Training

Before operating machine, operator should be trained in the operation of the machine. Refer to “Operator Qualifications,” [page 50-1](#). Initial training should be conducted at a site free of obstacles and review the following:

- all sections of this manual
- processes and procedures used to form and wrap a bale
- transporting machine
- setup of the machine

Operator presence system

The machine is equipped with an Operator Presence system that uses a switch in the seat to detect the presence of an operator. The operator must be seated for engine start, as well as the ground drive and other machine functions to be engaged.

If the operator leaves the seat while ground drive or other machine functions are engaged, ground drive will move to zero and most other machine functions will stop (netwrap will not stop). Controls must then be reset to NEUTRAL or OFF before resuming work.

The Operator Presence system must be maintained in good functional condition. Contact your Vermeer dealer if it does not function correctly.

Seat belt use



WARNING: Failure to wear seat belt may lead to being thrown from seat. The seat belt is an essential part of safe operation. Always wear seat belt when machine is being driven.

The instructional seat is provided for training or diagnosing purposes only and is not intended for children or other passengers.

Seat belt must be worn at all times while operating machine. A person riding in the instructional seat must also wear a seat belt. Do not allow children or other passengers to ride on the machine or in the cab.

The seat belt is an essential part of safe operation. Inspect seat belt every time it is used, looking for cuts or worn webbing, or any defect in the latch assembly. If any wear or damage is noted, do not operate machine until seat belt is replaced.

If it is necessary to clean belts, use a mild soap solution and lukewarm water. Do not use bleach, dye, solvents, or other chemicals which may weaken the belts.

To fasten automatic locking retractor seat belts:

- Step 1:** Pull latch steadily until it reaches buckle.
If retractor locks before latch reaches buckle, allow webbing to fully retract to release retractor.
- Step 2:** Insert latch into buckle until positive snap is heard.
Wear seat belt low and snug.
- Step 3:** Ensure there are no twists in seat belt webbing.
- Step 4:** Allow retractor to take up any slack in webbing.
- Step 5:** Pull sharply on webbing to ensure retractor is locked.

Prestarting inspection



WARNING: Before attempting to operate the baler, refer again to the [Safety Messages](#) section for important safety information. Refer to [page 10-1](#).

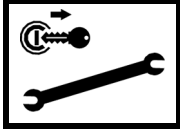

WARNING: Use Shutdown Procedure before servicing, cleaning, repairing or transporting machine. Refer to [Shutdown procedure](#), page [23-1](#), for instructions.



WARNING: Pressurized fluid can penetrate body tissue and result in death or serious injury. Leaks can be invisible. Keep away from any suspected leak. Relieve pressure in the hydraulic system before searching for leaks, disconnecting hoses, or performing any other work on the system. If you must pressurize the system to find a suspected leak, use an object such as a piece of wood or cardboard rather than your hands. When loosening a fitting where some residual pressure may exist, slowly loosen the fitting until oil begins to leak. Wait for leaking to stop before disconnecting the fitting. Fluid injected under the skin must be removed immediately by a surgeon familiar with this type of injury.

Familiarize yourself with the [operator's and maintenance manual](#) before attempting to operate the machine.

Ensure you are familiar with the location and function of each machine control before operating the machine. Refer to "Machine controls," [page 20-1](#).

Before using this machine each day, check or perform the listed items and make corrections as necessary.

- ___ Ensure fire extinguishers **(1)** are filled and pressurized correctly.
- ___ Check transport and work lights for proper function and for any damage.
- ___ Check hydraulic system for connection leaks, and kinked and worn hoses.
- ___ Check that safety signs, guards, shields, and other safety equipment are attached and in good condition.
- ___ Check that drive system is free of foreign material.
- ___ Check belts and belt lacing for wear and damage.
- ___ Use compressed air to remove dirt and debris buildup from all areas of machine, including engine compartment. Refer to [page 60-9](#).
- ___ Check chains for proper tension and lubrication.
- ___ Check bearings and shafts for evidence of bearing failure.
- ___ Ensure rollers and pickup reel are free of crop buildup and foreign material such as netwrap.
- ___ Ensure moisture sensing plates are clean.
- ___ Check all pickup teeth to ensure they are not damaged or missing.
- ___ Check wiring and connections for wear and damage.
- ___ Check condition of tires and rims.
- ___ Ensure tires are inflated as described below. Valve stem should be toward outside.
Front Tires at 20 psi (140 kPa)
Rear Tires at 29 psi (200 kPa)
- ___ Torque wheel lug nuts to:
Front wheels – 135 ft-lb (185 Nm)
Rear wheels – 630 ft-lb +/- 50 ft-lb (854 Nm +/- 68 Nm)

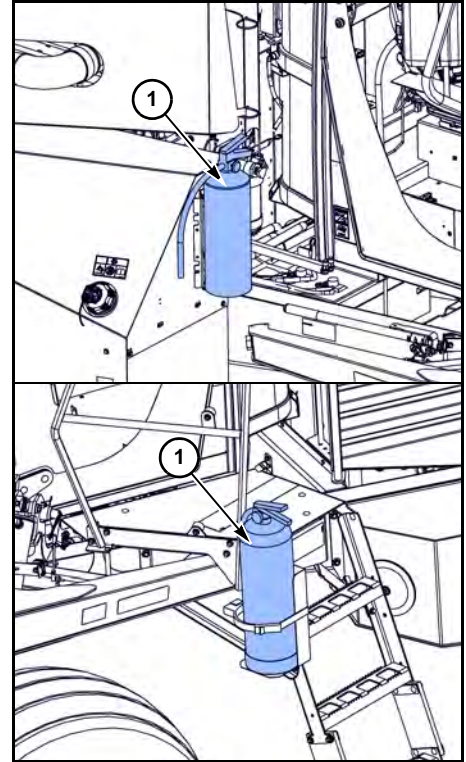

Netwrap - prestarting inspection

- ___ Ensure netwrap mechanism is clean and free of buildup and debris.
- ___ Ensure netwrap shear bar and knife are not damaged.
- ___ Check bottom net guide weldment and guide fingers for damage, rust or corrosion, adjustment, and proper operation.
- ___ Check net feed sensor for damage, adjustment, and proper operation.

Refer to [Section 40](#) for Netwrap operating instructions.

SMV sign - position

Ensure slow-moving vehicle (SMV) sign (1) is properly installed on rear of machine as shown and in good condition.

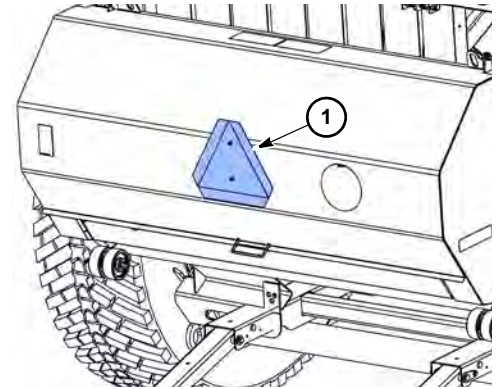

Section 30: Transporting the machine

Mount and dismount safely



WARNING: Improper use of steps, ladders, and platforms can cause you to fall. Keep them clear of objects and debris which may cause difficulties stepping on or off the machine. Face the machine when mounting and dismounting. Maintain a 3-point hand/foot contact with the access system (one hand and two feet, or two hands and one foot). Keep all handrails in place.

- Do not use any controls as handholds when climbing on or off the machine.
- Never jump off the machine.

Machine - clean

Thoroughly clean machine before transporting to keep debris from falling off the machine and onto the road. Remove accumulated trash and debris.

NOTICE: Do not use high pressure washers or steam cleaners to clean machine. Use compressed air.

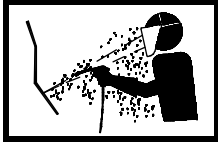

WARNING: Eye injury possible. Wear a face shield when using compressed air to clean machine.

Seat belts

Fasten seat belts



WARNING: Failure to wear seat belt may lead to being thrown from seat. The seat belt is an essential part of safe operation. Always wear seat belt when machine is being driven.

The instructional seat is provided for training or diagnosing purposes only and is not intended for children or other passengers.

Driving the machine



WARNING: Machine motion can cause rider to fall and be crushed or run over resulting in death or serious injury.



Do not allow anyone to ride on machine.



WARNING: Machine can strike or run over a person resulting in death or serious injury.



Before steering or driving machine, clear area and sound horn to warn others to stay away.

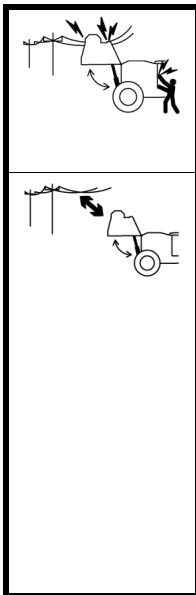

DANGER: Electrocution hazard exists around an energized overhead power line. If equipment gets near or contacts energized overhead power line, all connected equipment and surrounding ground surface will be energized. Death or serious injury will result due to electrocution.

Keep machine away from energized overhead power lines according to chart below.

<u>Voltage, kV</u>	<u>Minimum Clearance Distance, ft (m)</u>
up to 50	10 (3.1)
>50 to 200	15 (4.6)
>200 to 350	20 (6.1)
>350 to 500	25 (7.7)
>500 to 750	35 (10.7)
>750 to 1000	45 (13.8)

If arcing or contact occurs, do the following:

- If on machine, stay on machine. Anyone on ground should shuffle away keeping feet together on the ground.
- Contact utility company to shut off electrical power.
- Do not allow anyone to approach the machine or any connected equipment.
- Do not resume operation until utility company declares area safe.



WARNING: Before traveling in reverse, clear area and warn others to stay away. Death or serious injury could result if a person is struck or run over by the machine.

Whenever machine ground drive control is in reverse, backup warning alarm sounds. Use horn (1) to further alert ground personnel in the area when necessary.

Before driving on public roads, check applicable laws concerning the use of lights, a slow-moving vehicle sign, and other possible requirements.

Before driving or operating the machine, survey the area around the machine for persons or obstacles. Drive machine at a speed suitable for the terrain. Use slower ground speeds when driving on hillsides or uneven terrain, or near ditches, gullies, holes, or barriers. Avoid sudden stopping, starting, or turning unless necessary.

If operator visibility is obstructed, use a spotter to help maneuver machine whenever necessary. The spotter must stay out of the machine's travel path and be in full view of the operator at all times.

Push *Ground Drive Speed Control Lever* (2) slowly ahead to drive machine forward; pull lever slowly back to drive machine in reverse. Use the steering wheel (3) to steer the machine in the desired direction.

Press *Maximum Speed Limiter Rotary Switch* (4) to activate. Turn rotary switch to adjust and set maximum speed limit (forward speed only). Return *Ground Drive Speed Control Lever* to NEUTRAL, then press to deactivate. Approximate maximum speed (5) is shown on display.

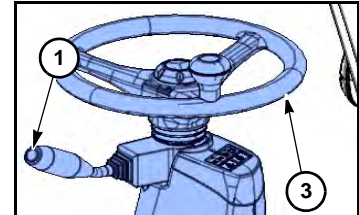
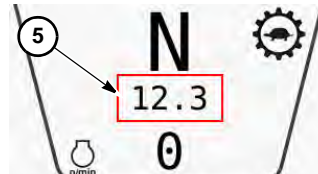

Trailer the machine

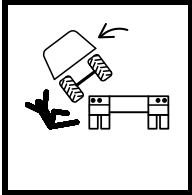

WARNING: Unintended machine movement may occur when loading or unloading on slippery, dirty or uneven trailer surfaces. Death or serious injury can result if struck or crushed by machine. Ensure trailer is level and all loading surfaces are clean and free of debris. Do not attempt to load onto slippery trailer surfaces. Use smooth and controlled steering movements.

- Read the towing vehicle and trailer manuals for safety precautions and information.
- Ensure gross weight of the machine is within the gross weight limits of the trailer and the towing vehicle.
- Load machine on a level surface.
- Properly attach trailer to towing vehicle and chock wheels or engage park brake of towing vehicle.
- Ensure you are qualified to operate the machine. Refer to “Training,” [page 25-1](#). Refer to “Operator Qualifications,” [page 50-1](#).
- Verify machine is in transport mode before loading or unloading.
- Verify pickup is fully raised before loading or unloading.
- **Slowly** drive machine on and off trailer squarely to minimize steering.
- Position machine at location for tie-downs and weight distribution as recommended by trailer manufacturer.

Loading

- Step 1: Place trailer on a level surface.
- Step 2: Verify that machine is in Transport mode.
- Step 3: Align machine with centerline of the trailer to minimize steering while loading.
- Step 4: **Slowly** drive machine squarely onto trailer.
- Step 5: Position machine at correct tie-down location as recommended by the trailer manufacturer.
- Step 6: Refer to [Shutdown procedure, page 23-1](#).
- Step 7: Chain each corner of machine to trailer using two front tie-down points (1) and two rear tie-down points (2).
- Step 8: Cover or remove slow-moving vehicle sign from machine.

Unloading

- Step 1: Place trailer on a level surface.
- Step 2: Uncover or install slow-moving vehicle sign on machine.
- Step 3: Remove chains and load binders.
- Step 4: Start engine. Refer to [Starting procedure, page 22-1](#).
- Step 5: **Slowly** drive machine squarely off trailer.

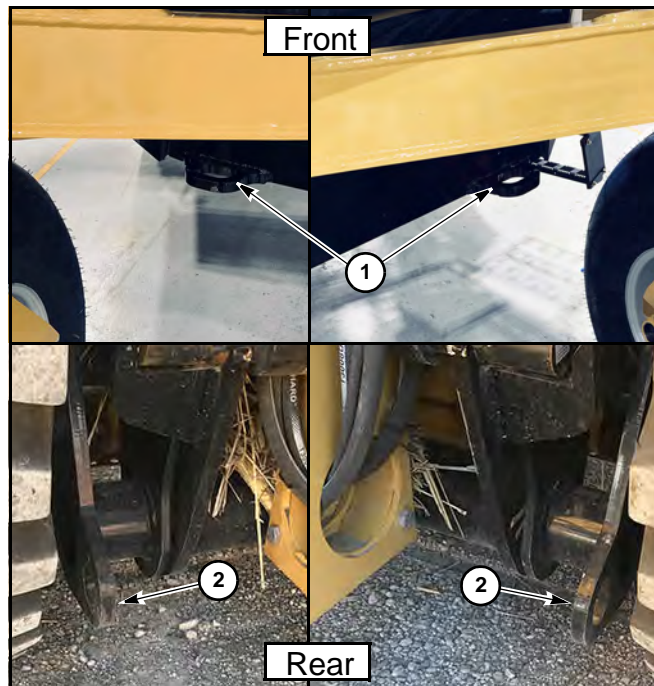

Towing/Retrieval

Never tow a disabled machine farther than is required to move the machine a short distance to locate the machine out of traffic and to where repairs can be performed safely. Do not tow machine more than 600 ft (183 m) and do not exceed 3 mph (4.8 km/h).



WARNING: Death or serious injury could result when retrieving or towing a disabled machine incorrectly.

- Attach towing cables to tie-down/towing lugs on front **(1)** or rear **(2)** of machine.
- Use only wire rope cable with sufficient strength. Inspect cable for fraying and wear. Do not use if frayed or worn.
- The strength of the towing cable must be at least 150% of the towing machine weight.
- Use a towing machine with sufficient power, weight and braking capacity to maintain control of the disabled machine. The towing machine should be at least as large as the disabled machine. If retrieving on a downhill grade, use a second machine on the opposite end of the disabled machine to prevent the disabled machine from overrunning the towing machine.
- Provide barriers to prevent injury to machine operators if cable fails. Keep anyone on the ground at least two times the length of the cable away.
- Never try to jerk the disabled machine in order to get the machine to move. Sudden cable overload may cause cable to fail.

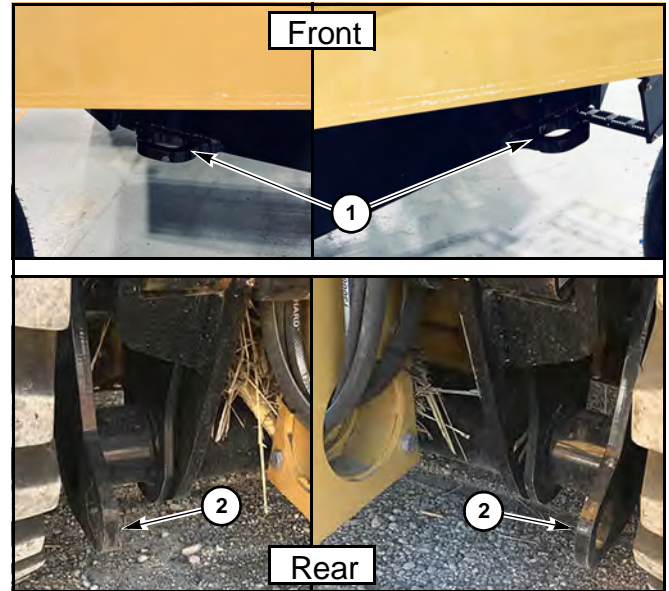

To release machine park brake for towing:

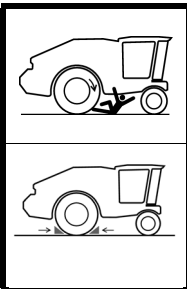

DANGER: Runover will crush.

Chock wheels before releasing park brake.

- Step 1: Follow *Shutdown procedure*, page 23-1.
- Step 2: Chock rear wheels.
- Step 3: Back out each high pressure relief valve (1) three full turns. There are two valves per pump, four valves total.
- Step 4: Locate ball valve (2) under left side of cab, then remove nylon tie and close valve.

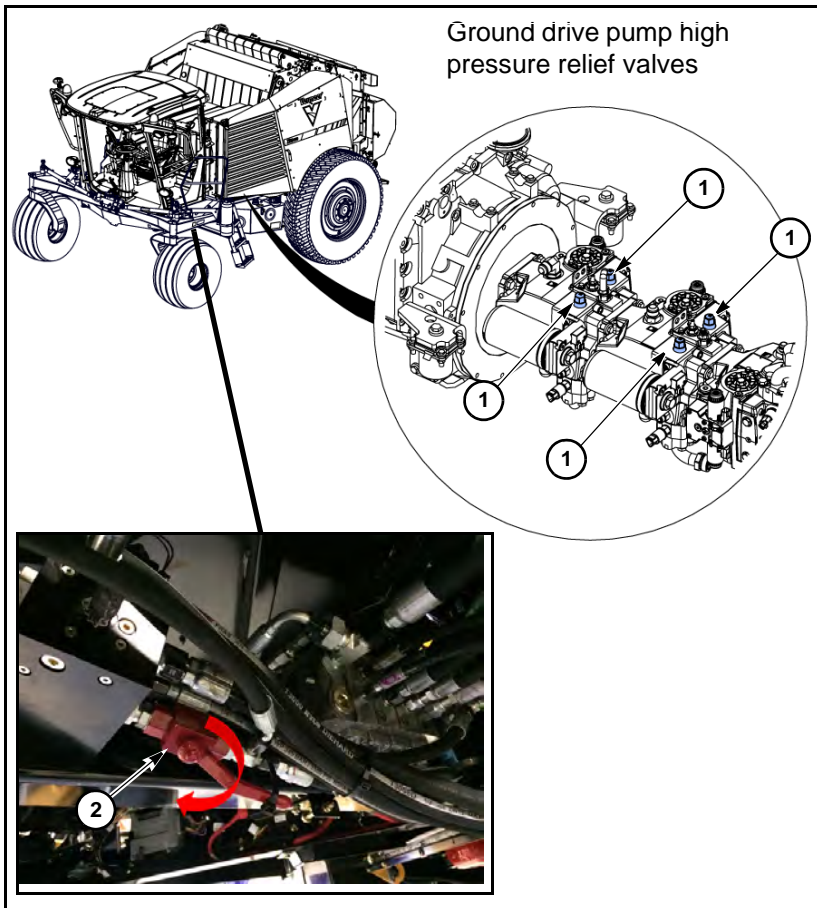

- Step 5:** Remove and retain two bolts and nuts from pump prevention plate **(3)**.
- Step 6:** Actuate park brake release pump handle **(4)** until oil can be heard squeaking over relief valve (between 7–10 strokes).
- Step 7:** Remove wheel chocks and tow machine to a safe location.
- Step 8:** Chock rear wheels.
- Step 9:** Open ball valve and install new nylon tie.
- Step 10:** Install retained bolts and nuts on pump prevention plate.
- Step 11:** Tighten high pressure relief valves and torque to 52 ft-lb (70 Nm).

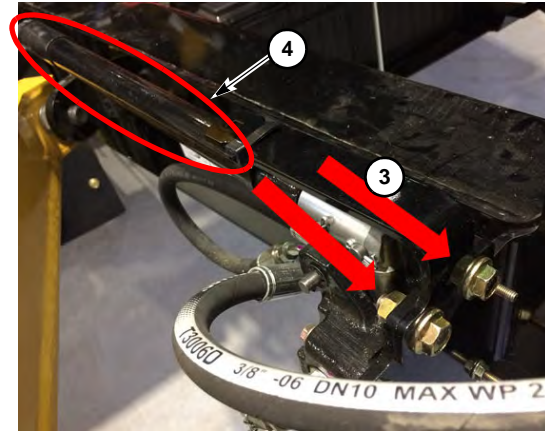

This page intentionally left blank.

Section 35: Preparing the crop to bale

Conventional baling

Crop preparation

General crops:

- Condition crop to ensure a uniform moisture content between leaves and stems. This promotes faster and more even drying, and prevents gumming and wrapping of baler rollers.
- On longer crops that are stiff, springy, and wiry, conditioning makes the stems limp. If they are not made limp, the bale will resist rolling while being formed and stems will stick out between the belts.

Cornstalks:

- Either do not chop, or chop coarsely to ensure easier bale formation.

Moisture content

Baling at the proper moisture content helps in forming firm and well-shaped bales, and preserves feed quality. Crop, weather condition, and storage method all affect what the optimum moisture content should be. Generally, moisture content should be 50–70% for silage and below 18% for dry hay. Refer to [page 45-1](#) for details on determining crop moisture content.

- Crop that is too wet will result in operating difficulties and spoilage during storage.
- Crop that is too dry will result in excessive leaf loss and poorly packed bales.

Windrow preparation

- Ensure windrow is no wider than 47" (119 cm) or half width at 24" (61 cm). Refer to illustration at right.
- Windrows wider than bale chamber may cause bale starting difficulty.
- Follow instructions below for windrow preparations.
- Full-width windrows must have consistent thickness of material all the way across the row.
- Windrows that are the same width as the bale chamber will result in well-shaped bales that have firmly packed sides. They also allow the crop to dry more easily and uniformly.
- Windrows that are narrower than half the width of the pickup also result in acceptable bales. Crop will be evenly distributed the width of the bale as the baler weaves across the windrow.
- Windrows that are wider than half the width of the pickup will result in barrel-shaped bales that are difficult to handle, stack poorly, have unevenly spaced twine, and shed twine easily.

NOTICE: Never make windrows wider than the width of the bale chamber 47" (119 cm). Difficulty in core starting may result. Windrows other than 24 or 47" (61 or 119 cm) wide will cause poorly shaped bales.

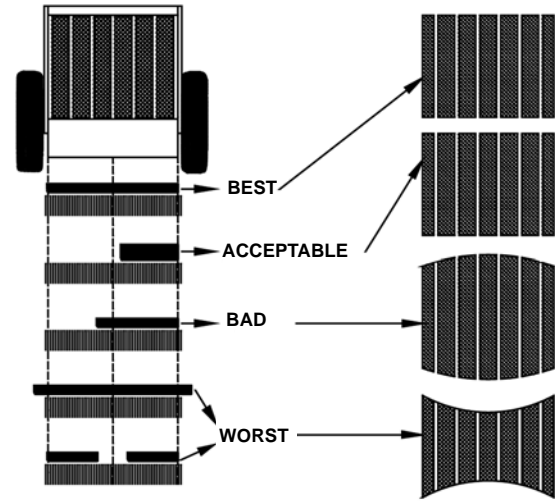

Section 40: Netwrap operation

Netwrap - operational instructions

Netwrap system is used to apply mesh netting to the exterior of a round bale, to complete the bale package before bale ejection. The netting contains the round bale, ensuring it cannot come apart, while shedding water to reduce spoilage.

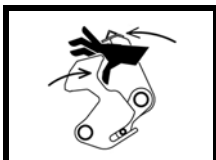

WARNING: Netwrap can move suddenly. Crushing injury possible.

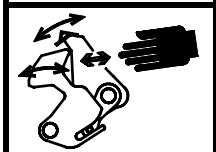

Keep hands away from moving parts.

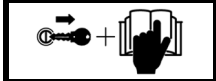

Shut off machine. Read manual before servicing.

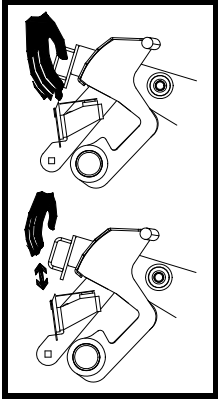

WARNING: Sharp knife can cut. Keep hands away from knife.

Wear heavy gloves when working around knife.

Netwrap components

Feed pan (1) - A combination steel pan and spreader bar that netwrap (2) rests over during regular baling operation. Feed pan shown in the home position.

Shear bar (3) - Moves down in the "Home" position, pinching netwrap against the netwrap knife mount (diving board) (4), where knife (5) cuts netwrap. Net Load position shown.

Knife (5) - A vertical steel knife is used to cut the netwrap at the end of a wrapping cycle.

Brake (6) - A mechanical friction pad against a drum is used to provide tension to the netwrap while it is feeding.

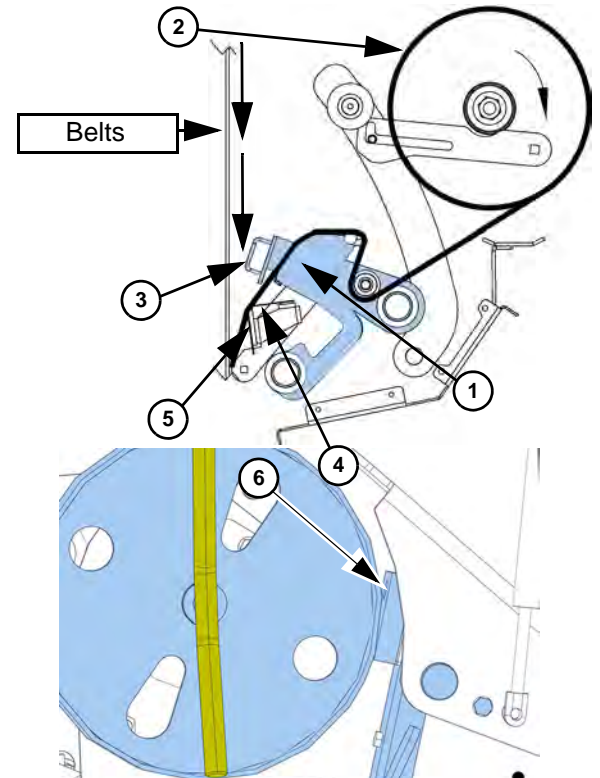

Brake release weldment (7) - Weldment is tied to the shear bar that rotates rearward, contacting the brake arm to release the brake from the wheel and forward to place the brake against the wheel. Brake release weldment releases the brake arm (8).

Netwrap feed sensor (9) - Senses when the netwrap roll is rotating, turning brake wheel (10), and sends pulses to the ECU.

Actuator (11) - Electric Actuator extends to hold the shear bar closed to pinch and cut the netwrap. Actuator retracts to open up shear bar, remove brake tension, and then push feed pan into the belts to start the netwrap feeding into the baler. Actuator stops between these two positions while net is applied. It also controls brake release weldment (7) on right hand side.

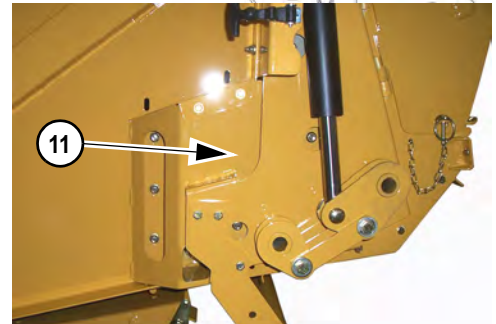
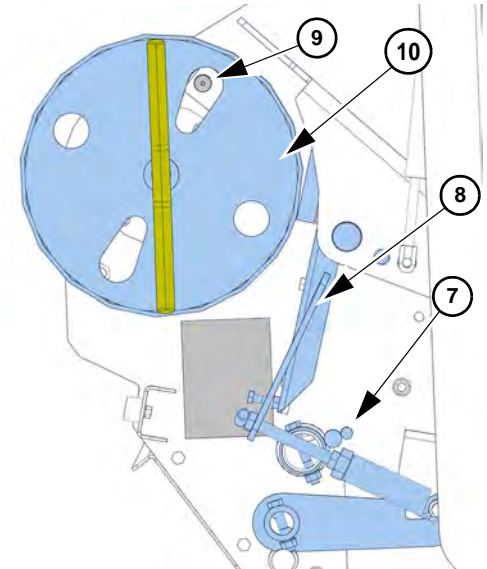

Netwrap components - operating positions

There are three main positions netwrap feed pan operates between throughout a cycle:

- **Start position** - Start position describes the actuator position that starts the netwrap spooling. Feed pan is pushed into the belts and the brake pad removed from the wheel by retracting the actuator until the belt tension causes the actuator to stall.
- **Feed position** - Feed position describes the netwrap feeding position in the cycle after the netwrap has started. Actuator partially extends, allowing the brake pad to reapply tension to the wheel and netwrap. Amount of time spent in this position is dependent on number of wraps to apply, and bale size.
- **Cut/Home position** - Cut/home position is the final position the actuator moves in the cycle. When the desired amount of netwrap has been applied, actuator extends until it stalls, which closes the knife to cut netwrap off. Loose end is pinched between the knife and shear bar surface so it is prepared for the next cycle. This is the position the netwrap system should be in while baling.

Shear bar holds the loose end of the netwrap against the netwrap knife mount (diving board) to keep it from coming off the feed pan after the cut sequence. It moves up and back to start the net and within 3-1/2" (89 mm) (timing hole) of the Home position while net is applying.

Pulses sent to the ECU, when netwrap is feeding into baler, are used to monitor the netwrap operation and control the actuator movement.

- **Net load** - When loading a new roll of netwrap, the operator must open the shear bar to feed the netwrap through. To do this the system must be moved from its typical "Home" position into the Net Load position. Refer to [page 40-24](#).

Net storage location

An extra roll of net (1) may be stored inside the netwrap chamber. Secure extra roll with straps.

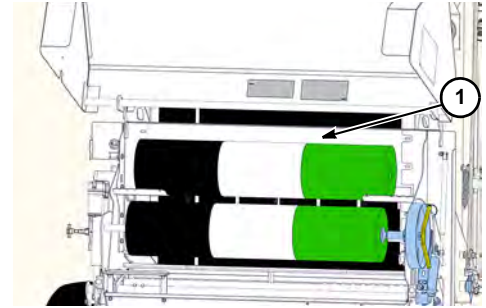

Netwrap system - function overview

Netwrap functions:

- Set up electronic controller for netwrap mode. Refer to “Netwrap - controller setup instructions,” [page 40-7](#).
- Apply netwrap to a bale. Refer to “Netwrap - Apply to Bale,” [page 40-14](#).
- Check netwrap if system failed or misfed. Refer to “Failed and misfed netwrap,” [page 40-21](#).
- Check for and remove misfed netwrap. Refer to “Netwrap misfeed - check for and remove,” [page 40-22](#).
- Follow instructions in case netwrap needs loaded. Refer to “Netwrap - loading and storage,” [page 40-23](#).
- Check and adjust netwrap tension. Refer to “Netwrap brake spring (tension) - initial adjustment,” [page 40-36](#).
- Adjust net guide weldment. Refer to “Netwrap brake spring (tension) - initial adjustment,” [page 40-36](#).
- Adjust netwrap knife. Refer to “Netwrap knife - adjust,” [page 60-25](#).

Netwrap - controller setup instructions

Netwrap system - setup procedure

Netwrap system is enabled and parameters set with the electronic control system.

- Step 1:** From Home screen (1) touch and release *Settings softkey* (2) to open Settings menu.
- Step 2:** On Settings screen touch the *Minus* (3) or *Plus* (4) to adjust “Number of Wraps” setting (5) to desired value.
- Step 3:** Touch *Home softkey* (6) to save settings and return to the Home screen.

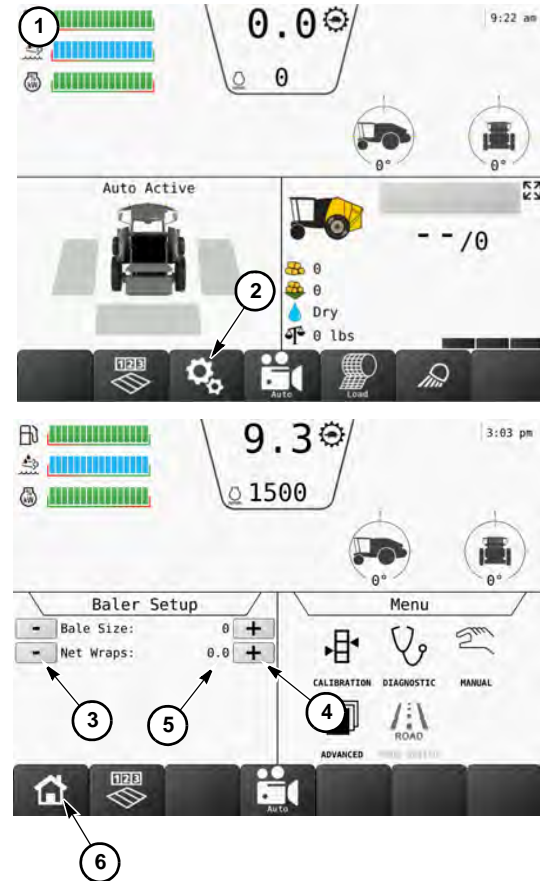

Step 4: On Home screen (1), touch *Settings softkey* (2) to open Settings screen.

Step 5: Touch *Advanced softkey* (7) to advance to Advanced Settings screen.

Step 6: In Advanced Settings screen, touch *Tie System softkey* (8).

Step 7: Touch *Minus softkey* (9) to decrease time or touch *Plus softkey* (10) to increase time.

Value shows time in milliseconds from when actuator moves net into belts to when brake is applied adding tension to netwrap.

Step 8: Touch *Home softkey* (6) to save settings and return to the Home screen.

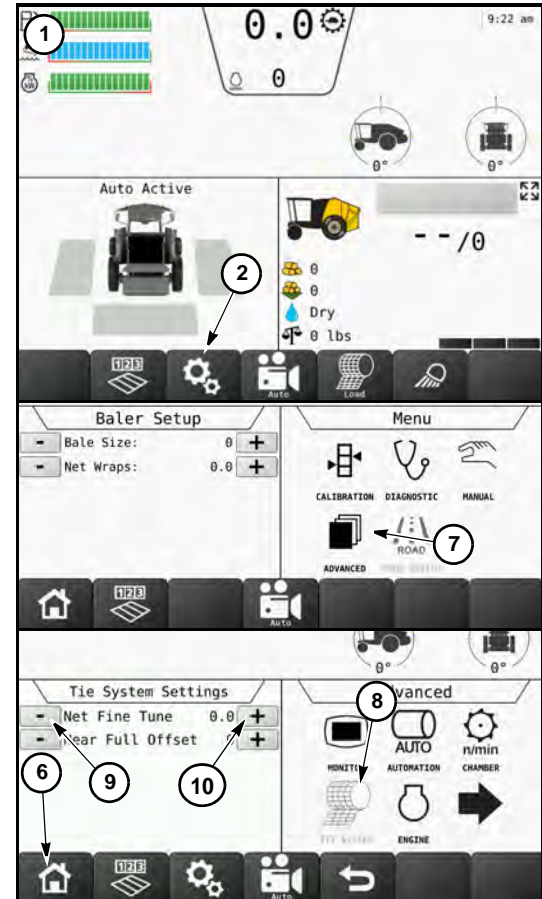

Netwrap density settings

Net wraps **(1)** is the netwrap density setting.

- This setting should equal total number of wraps applied to bale, assuming baler operates at rated drive speed during wrap cycle.
- Setting can be adjusted between 1.5 and 8. Note full bale size is set at 72" (183 cm). If bale size is less than 60" (152 cm) more wraps will be applied because this is a time setting.
- A higher number will result in more netwrap on bale. Conversely a low number means less netwrap on bale.

Different crops and baling conditions may require changes in these settings. Note settings are calculated for a 60" (152 cm) bale.

- Hay (alfalfa, dry grass): 2-1/4 wraps minimum.
- Straw (short dry crop): 3-1/4 wraps minimum.
- Cornstalks, rotary combined straw: 4-1/4 wraps minimum.

Neither field nor total bale counts will increase unless netwrap cycle is completed and bale size drops below 25% of target full bale size. This prevents bale counts from increasing if multiple netwrap cycles are performed.

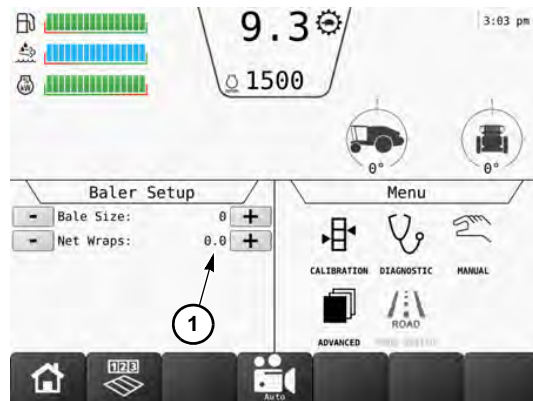

Start softkey - manual netwrap cycle

Touch *Start softkey* (1) to begin a tie cycle before full bale is reached, begin a paused tie cycle, or restart a tie cycle.

To manually start the tying process:

Step 1: Stop forward motion.

Step 2: Touch and release *Start softkey* (1) to start the tie cycle. Remain stopped during tie cycle.

Number of wraps applied is controlled by the Netwrap setting. Different crops and baling conditions may require changes in these settings, refer to [page 40-7](#).

Step 3: Netwrap mechanism automatically moves to start wrapping process.

- Display will show net application symbol (2) to indicate that net is being applied to the bale.
- While netwrap is feeding into bale chamber the display will show progress of tie cycle (3).
- Actuator will move feed pan toward baler belts where it is pulled around bale. Shear bar moves away from netwrap, allowing it to be pulled from roll.
- When netwrap cycle is complete, open tailgate symbol (4) appears indicating cycle is done and bale should be ejected.

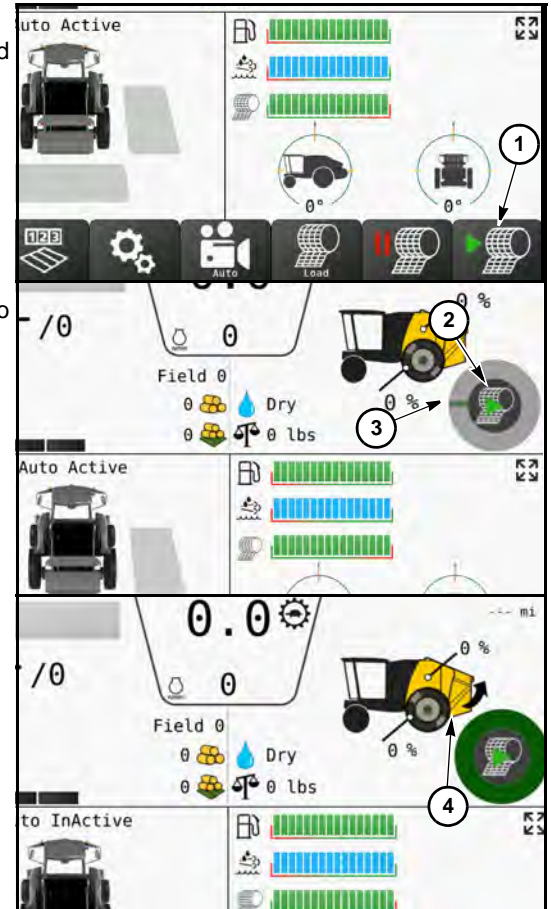

- Step 4: Open tailgate. *Tailgate Open* icon (5) appears to indicate tailgate is unlocked and open.
- Step 5: After bale has moved away from tailgate, close tailgate. Audible device sounds 1 beep, indicating tailgate is closed (6) and baler is now ready to continue baling.
- Step 6: When tailgate is closed, bale size indicator (7) goes to gray, showing no bale in chamber, bale size goes to 0 (8), bale shape indicator bars (9) minimize, and bale count should increase by 1 (10).

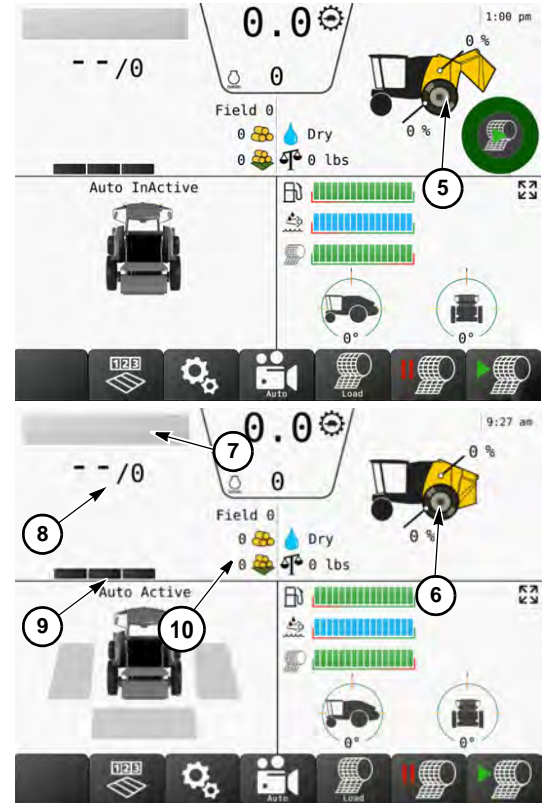

Pause softkey - netwrap cycle

Netwrap system normally functions automatically unless the user enters paused mode. In paused mode, the full bale sound is activated when the sensed bale size reaches full bale size, but the tie cycle does not start. The user must touch *Start softkey* or *Pause softkey* to start the wrapping cycle. If in paused mode, and the sensed bale size is below full bale size and the *Pause softkey* is touched again to exit paused mode, the wrapping cycle will not start.

Paused mode may be entered at any time. paused mode is exited at any time by touching the *Pause softkey* again or by touching *Start softkey*. paused mode is a non-latching mode, and the system will re-enter automatic mode when pause is exited.

To pause the tying process while netwrap is being applied to the bale:

Step 1: Touch and release *Pause softkey* (1) to manually pause wrapping procedure or prevent it from starting.

Step 2: Netwrap application indicator stops (2) to show Netwrap in paused mode.

Step 3: Touch and release *Pause softkey* (1) or *Start softkey* (3) to resume normal netwrap application operation.

NOTICE: If net is feeding, it will continue to feed in paused mode.

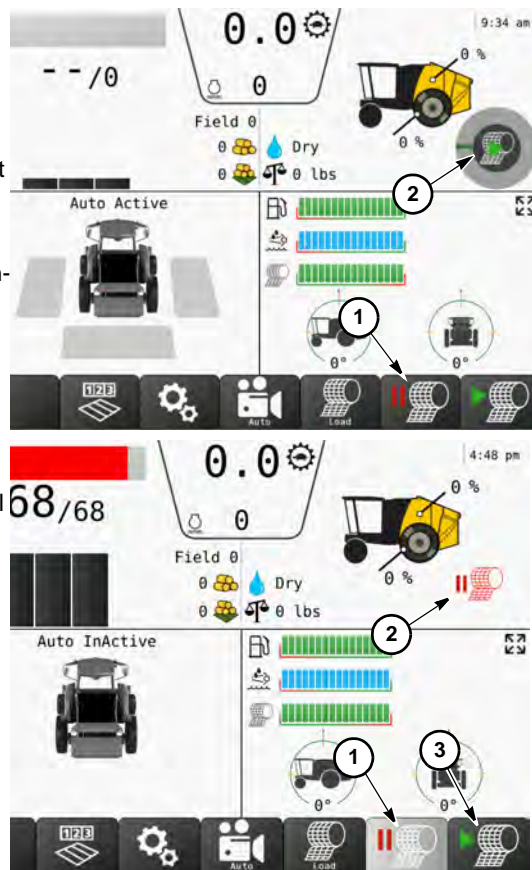

Manual control softkeys - netwrap

- Step 1: Touch and release *Settings softkey (1)* to open Settings screen.
- Step 2: On Settings screen select *Manual softkey (2)* to open Manual Control screen (3).
- Step 3: In Manual Control screen, touch *Netwrap softkey (4)*, then touch and hold *Apply softkey (5)* to manually retract netwrap mechanism toward start netwrap position. Releasing the softkey will stop mechanism movement.
- Step 4: Touch and hold *Cut softkey (6)* to manually extend netwrap mechanism toward cut position. Releasing the softkey will stop mechanism movement.
- Step 5: Touch *Home softkey (7)* to save settings and return to the Home screen.

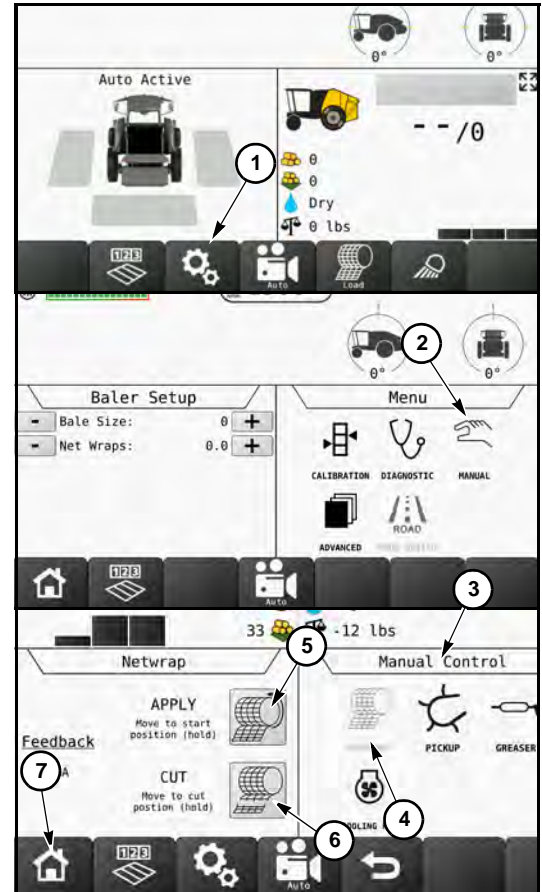

Netwrap - Apply to Bale

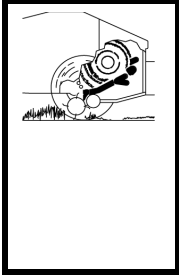

DANGER: Baler intake can pull you in, resulting in death or serious injury. Stay clear of pickup reel and feed intake area. Baler may take in crop faster than you can let go.

NEVER feed crop by hand.

NEVER remove any material from the baler intake while it is running.

NEVER try to unplug the baler while it is running. Refer to “Unplugging the Baler,” [page 50-23](#).

ALWAYS disengage baler ground drive, shut off engine, engage park brake, and remove key before manually unplugging or servicing.

Netwrap system - automatic cycle start

Netwrap - paused operation

In this example, tie cycle will start automatically at full bale size of 68" (173 cm) **(1)** unless paused mode **(2)** is enabled.

When the controller is powered up with a bale at or above full bale size in the chamber:

- *Pause softkey* will display a red netwrap and softkey will lighten **(2)** to show tie cycle is in PAUSED mode.
- Engage baler drive, then touch and release *Pause softkey* or *Start softkey* **(3)** to begin or complete a wrap cycle.
- If the bale has already been tied off, eject bale and resume normal operation.

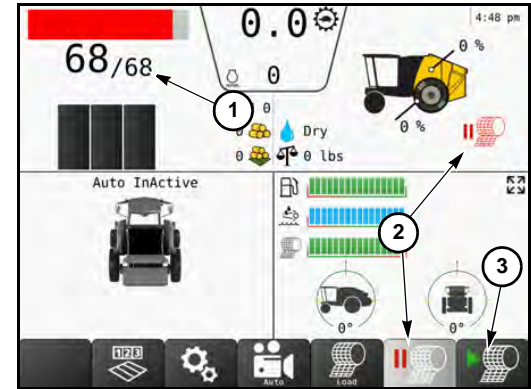

Netwrap - normal operation

Step 1: When current bale size of 65" (165 cm) **(1)** approaches target full bale size of 68" (173 cm) **(2)**:

- Bale size indicator **(3)** color will change to yellow for near full bale.
- Audible alert will sound three short beeps.

Step 2: When current bale size of 65" (165 cm) **(4)** equals target full bale size of 68" (173 cm) **(2)**:

- Bale size indicator **(5)** color will change to red for full bale.
- Audible alert will sound a 3-second long beep.
- Machine ground drive will come to a stop unless *Pause softkey* **(6)** is pressed.

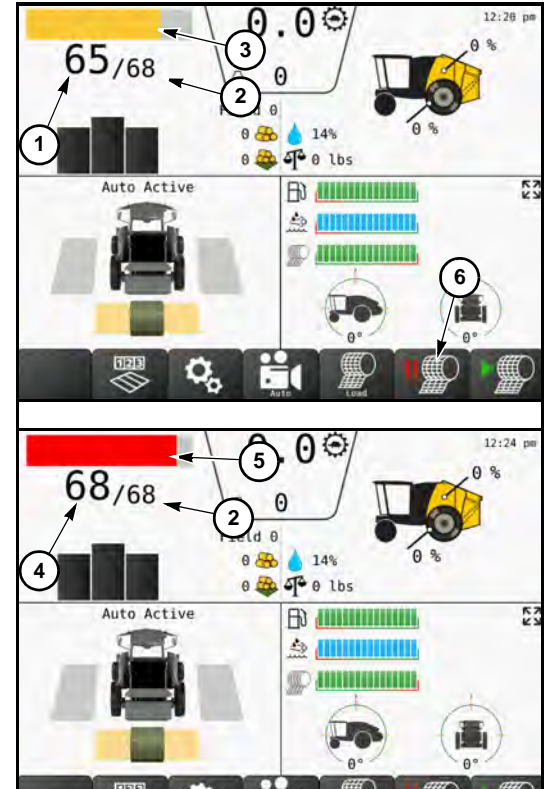

Step 3: If netwrap is paused, stop forward movement within 6 seconds - do not overfill baler.

If an netwrap is not paused, forward movement is controlled by the software. Refer to [page 50-19](#).

Step 4: ECU controller automatically begins the tie cycle. Remain stopped during tie cycle.

Number of wraps applied is controlled by the Number of Wraps setting. Different crops, baling conditions, and bale size setting may require changes in these settings. Refer to [page 40-7](#).

- Hay (alfalfa, dry grass): 2-1/4 wraps minimum.
- Straw (short dry crop): 3-1/4 wraps minimum.
- Cornstalks, rotary combined straw: 4-1/4 wraps minimum.

Step 5: Netwrap mechanism automatically moves to start wrapping process.

- Display will show net application symbol **(6)** to indicate that net is being applied to the bale.
- While netwrap is feeding into bale chamber the display **(7)** will show progress of tie cycle as green color advances around circular display.
- Actuator will move feed pan **(8)** toward baler belts where net is pulled around bale. Shear bar **(9)** moves away from netwrap knife mount (diving board) allowing netwrap to be pulled from roll.
- While netwrap is feeding into bale chamber, the actuator movement causes pad to move against the brake wheel to add resistance to brake wheel rotation, thereby adding tension to and stretching netwrap as it feeds onto bale.

Brake pad-to-wheel clearance is set at 1/16" (1.6 mm). Refer to [page 40-32](#) for instructions.

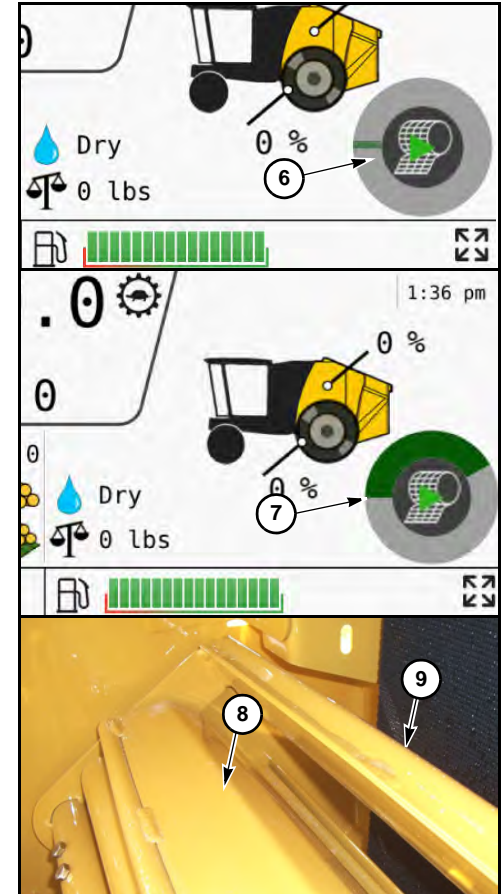

Step 6: When circular bar **(10)** completely fills with green color, display shows programmed amount of net has been applied:

- Netwrap mechanism retracts.
- Shear bar **(11)** moves down onto netwrap knife mount (diving board) holding netwrap so knife **(12)** cuts the netwrap.
- Netwrap mechanism will remain in this position until next bale is finished.

Step 7: When tie cycle is complete, audible device sounds 1 beep, indicating application is finished, and arrow icon **(13)** flashes.

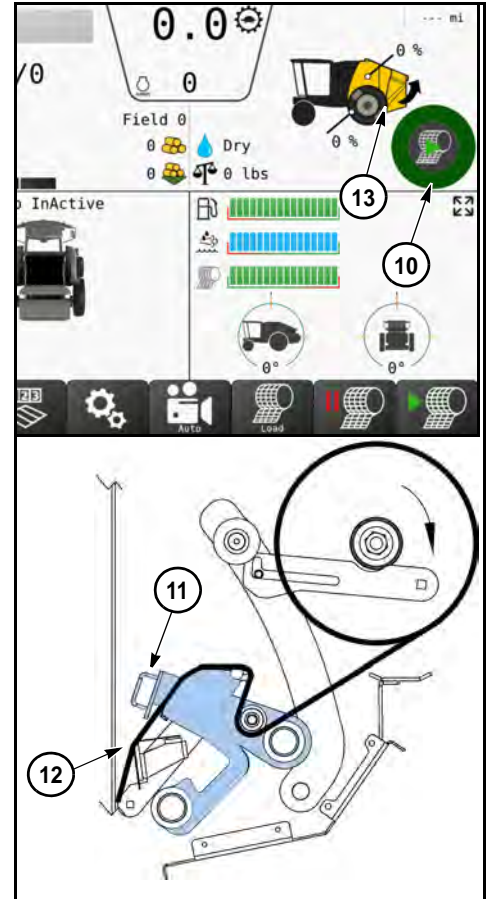

Step 8: Use machine hydraulic controls to open tailgate, open tailgate symbol **(14)** appears.

If an auto mode direction is selected, tailgate will open automatically after machine comes to a stop at full bale and wrapping cycle is completed. Refer to [page 50-19](#).

Step 9: As tailgate opens, bale will roll from baler.

Step 10: After bale has moved away from tailgate, close tailgate. Audible device sounds 1 beep, indicating tailgate is closed and latched. Machine is now ready to continue baling.

If an auto mode direction is selected, tailgate will close automatically after full bale is ejected. Refer to [page 50-19](#).

Step 11: When tailgate is closed, bale size indicator **(15)** goes gray, showing no bale in chamber, bale size goes to 0 **(16)**, bale shape indicator bars **(17)** minimize, and bale count should increase by 1 **(18)**.

Step 12: Inspect bale to ensure required number of wraps have been applied. If not, refer to [page 40-7](#) to make adjustments.

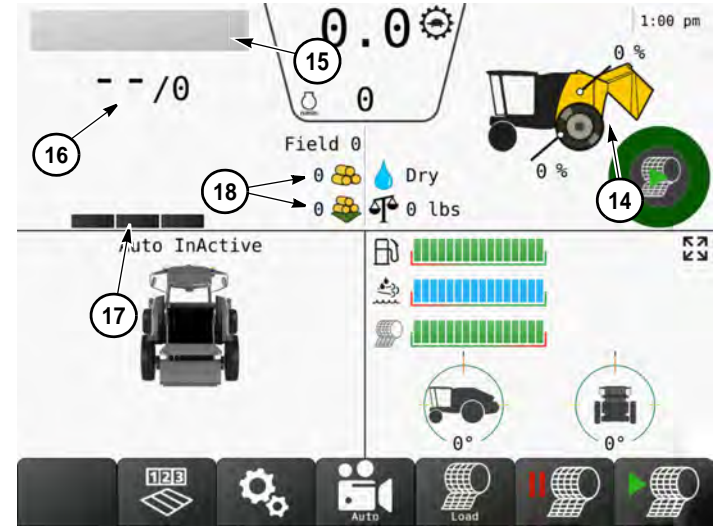

Netwrap - manual start

Use manual start to complete a bale when finished in a field and/or at the end of the day so a bale is not left in bale chamber for an extended period of time.

To stop the baling process and wrap a bale before bale chamber is full:

- Step 1:** Stop forward motion.
- Step 2:** Touch and release *Start softkey (1)* to manually start wrapping the bale.
- Step 3:** Follow Steps 4–12 on previous pages to finish wrapping and ejecting bale.

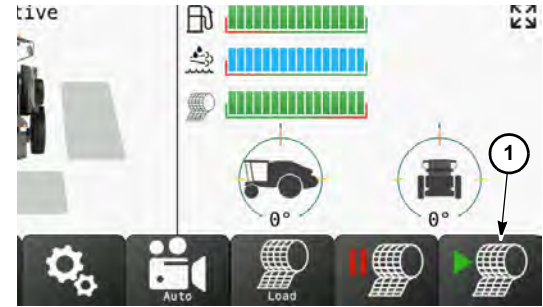

Failed and misfed netwrap

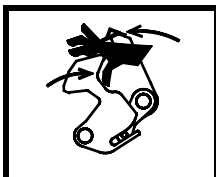

WARNING: Netwrāp can move suddenly. Crushing injury possible.

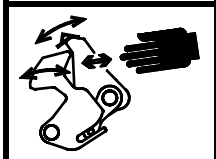

Keep hands away from moving parts.

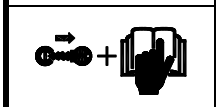

Shut off machine. Read manual before servicing.

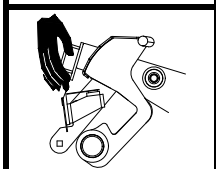

WARNING: Sharp knife can cut.

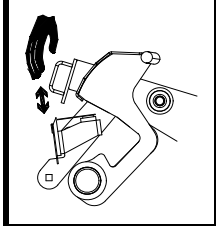

Keep hands away from knife. Wear heavy gloves when working around knife.

Netwrap misfeed - check for and remove

NOTICE: **Never** run netwrap without a bale in the chamber. Netwrap will become caught and tangled in the pickup and/or rotor. Removal will require cutting netwrap out in small pieces.

Step 1: Relieve belt tension as follows:

- Fully open tailgate.
- Install density cylinder stop.
- Close tailgate until belts are loose.
- Move tailgate cylinder lock valve to locked position. Follow [Shutdown procedure](#), page 23-1.

Step 2: Inspect all drive and idler rollers for wrapped netwrap.

Step 3: Use a suitable knife to cut netwrap away from rollers and bearings.

Step 4: Inspect pickup reel for wrapped netwrap.

Step 5: Insert a suitable knife between stripper bands to cut netwrap away from pickup reel.

Step 6: If netwrap wraps around rollers or pickup reel again within 10 service hours or a day of operation, recalibrate bale size.

After the issue has been corrected and if bale is still in chamber:

- Start engine and engage baler drive.
- Increase engine to full idle.
- Press and release *Start Key* to rewrap bale. This will ensure bale is sufficiently covered with netwrap prior to ejection.

Netwrap - loading and storage

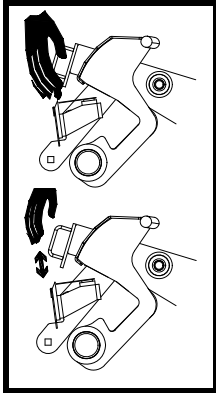

WARNING: Sharp knife can cut.

Keep hands away from knife. Wear heavy gloves when working around knife.

Net loading operation

To load netwrap:

- Step 1:** Touch and release *Load softkey* (1) to move netwrap mechanism into optimal position for loading a roll of netwrap.
 - Step 2:** Load menu screen (A) will display showing netwrap routing diagram.
 - Step 3:** Continue with Step 4 on the following page to load netwrap roll.
- After netwrap roll is correctly installed, press and hold *Home softkey* (2).

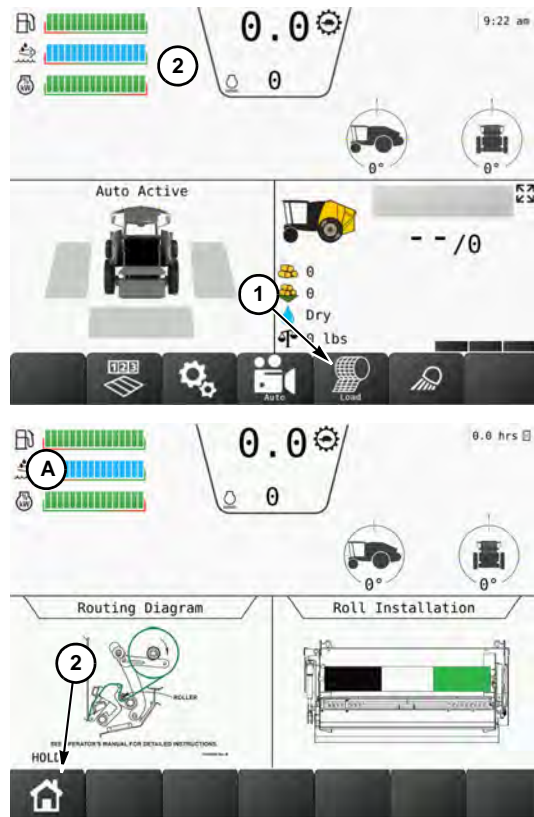

- Step 4: Open netwrap access door (3).
- Step 5: Loosen spindle T-handle (4) to allow cardboard tube to slide off rubber bushing on spindle (5).
- Step 6: Remove linchpin (6) and swing left side spindle support (7) open to remove cardboard tube.
- Step 7: Inspect netwrap contact surfaces for debris. Surfaces must be kept clean and smooth for proper operation.
- Step 8: Push tensioning roller (8) toward front of baler until it latches.

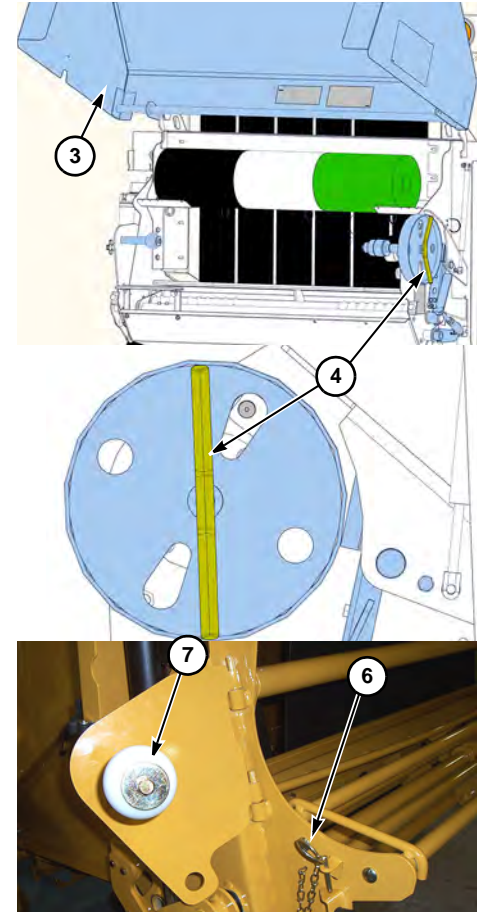
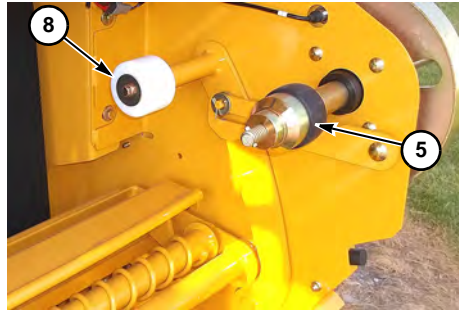

Step 9: Slide roll of netwrap (9) onto spindle (5) on right side with the netwrap coming off the bottom (10) of the roll.

Step 10: Swing spindle support (7) into opposite end of netwrap roll and secure with linchpin (6).

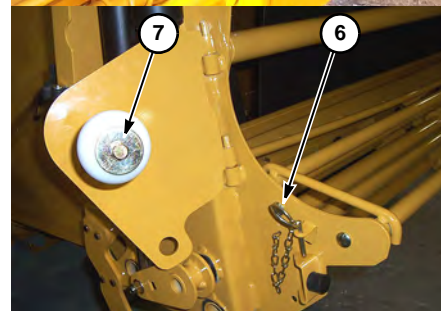
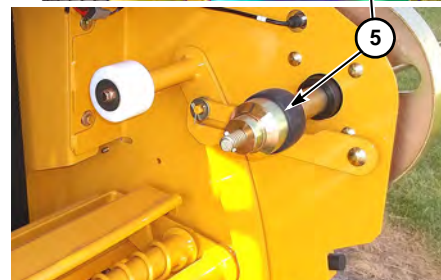
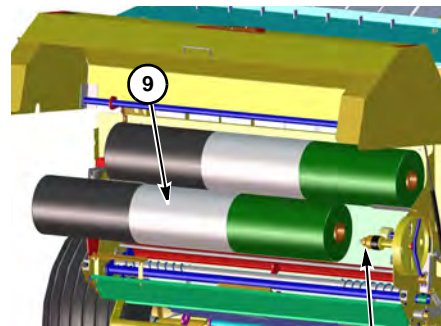
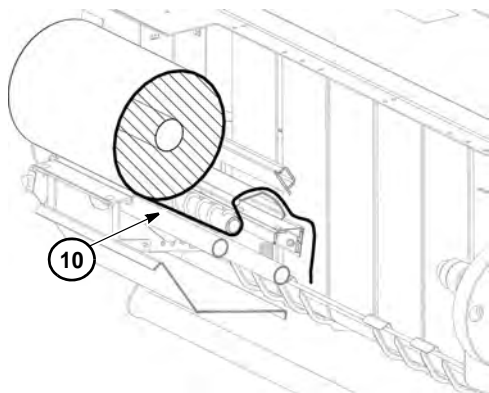

- Step 11: Gather leading edge of netwrap (11) as shown.
- Step 12: Route netwrap under spiral roller (12), then over feed pan (13).
- Step 13: Pull netwrap through so it hangs 4" (10 cm) below front of feed pan (13). Spread netwrap so it is at least 1/2 the width of the pan.

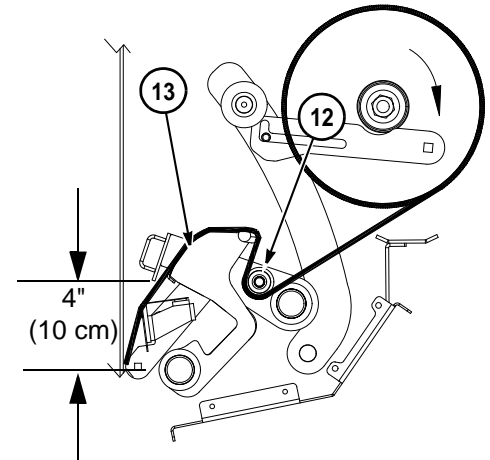
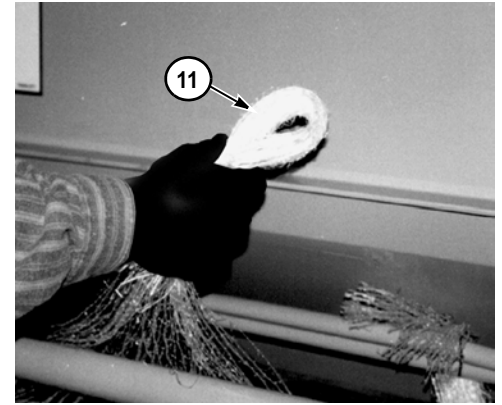
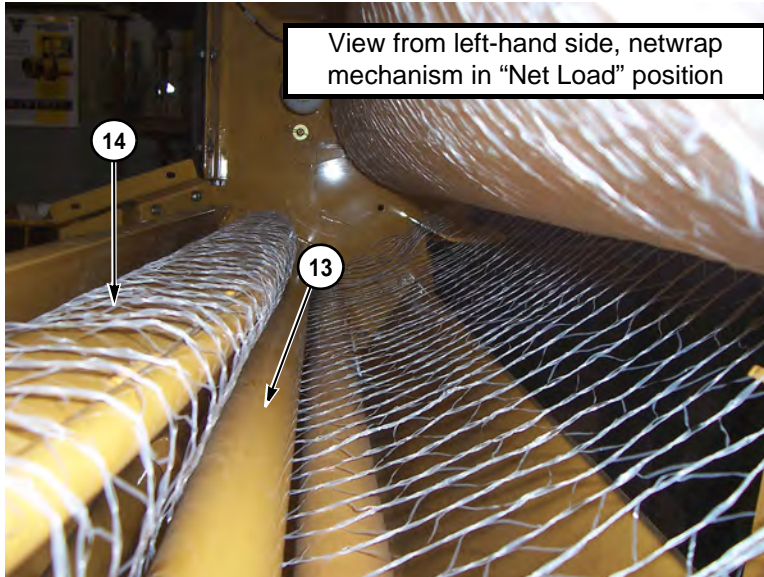

Step 14: Use small slots on storage cradle pads **(14)** as guides to center netwrap roll **(9)**.

Step 15: Tightening brake wheel T-handle **(4)** may move net roll slightly to the right.

Step 16: Tighten brake wheel T-handle **(4)** to expand rubber bushing on spindle **(5)** gripping cardboard tube.

Step 17: Ensure net roll is still centered after tightening brake wheel.

If T-handle is not sufficiently tight, NO NET FEED error may come up and net may not cut well.

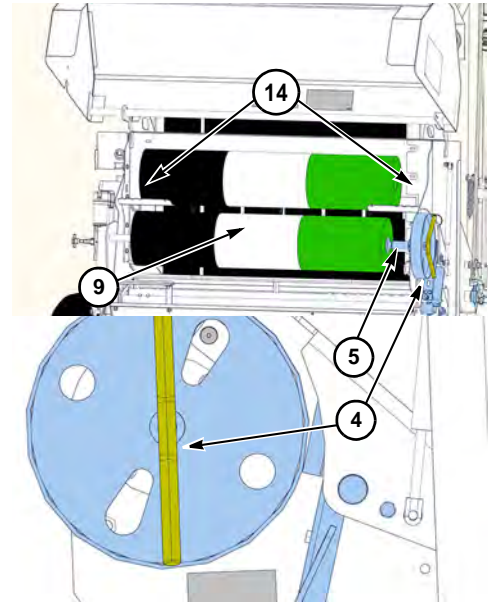

- Step 18: Close netwrap access door.
- Step 19: With Load menu screen **(A)** displayed, touch and hold *Home softkey* **(2)** for one second to retract the mechanism and stage the system for the next netwrap cycle.
- Step 20: Display will return to Home screen **(15)**, baler is now ready to continue baling.

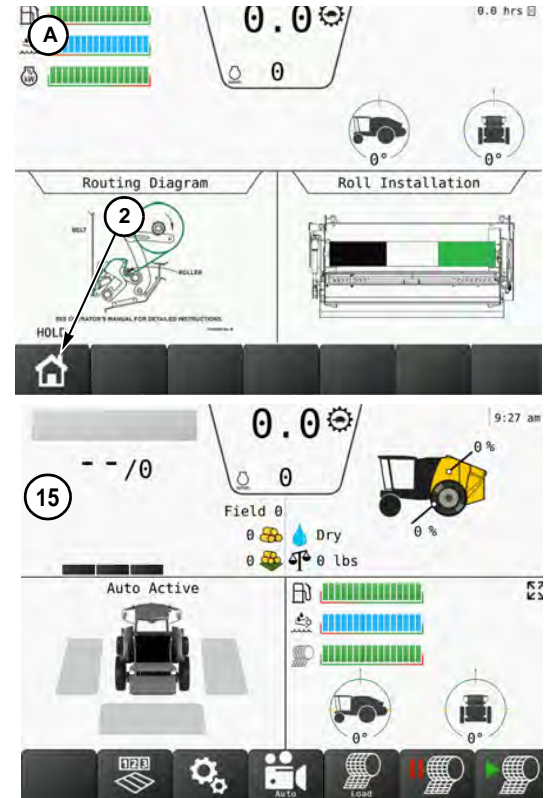

Netwrap - adjustments and maintenance

Netwrap feed sensing

- Sensor (1) senses brake wheel (2) rotation to determine if net is or is not feeding off the roll.
- There should be 1/16–1/8" (1.6–3 mm) clearance between brake wheel and sensor.

After new roll is installed, weight of roll on brake wheel may affect clearance between brake wheel and sensor.

- To check sensor and circuit, rotate wheel out of cycle. Feeding code should be displayed.

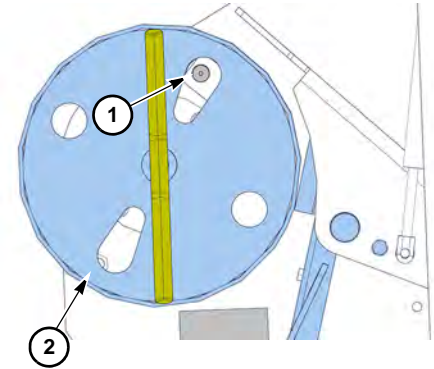

Netwrap system - optimize performance

Ensure the following three conditions are met to achieve optimal netwrap system performance. See adjustment details on following pages indicated below.

Brake pad-to-wheel clearance:

- For net to start feeding properly, there should be no more than 1/16" (1.6 mm) clearance between brake pad (2) and brake wheel (1) at closest point of contact. This ensures positive feeding of netwrap material until a sufficient amount has been applied for starting. Refer to [page 40-32](#).

Shear bar clearance:

- As netwrap continues to feed as indicated (4) on display, shear bar (5) rotates forward and down and should stop with top edge near center of timing hole (6) in right-hand side of netwrap system frame. Netwrap material is now under tension and positioned on a path free from interference with any system components. Refer to [page 40-34](#).

Brake spring (tension):

- Brake spring (3) should be adjusted to apply as much tension as possible to netwrap material after start of wrap cycle. Maximizing netwrap tension can help optimize bale appearance, increase the number of bales wrapped per roll of netwrap, and ensure netwrap cuts properly at end of wrap cycle. Refer to [page 40-36](#).

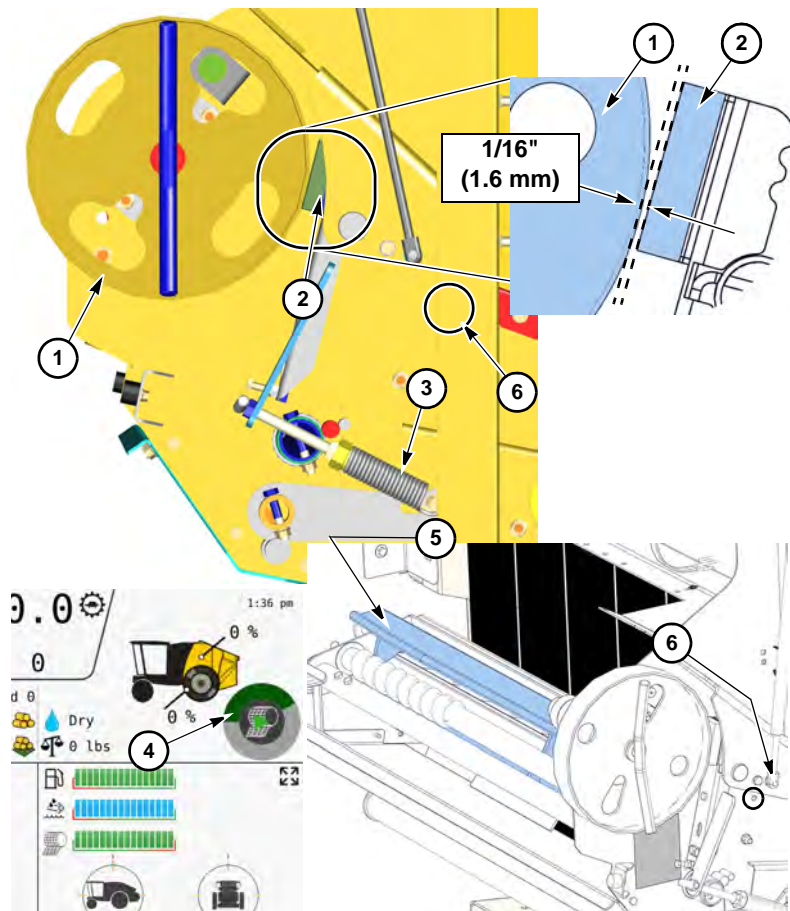

Netwrap brake pad-to-wheel clearance - adjust

Step 1: Press *Start softkey* (1) to fully extend feed pan (2) against belts (3).

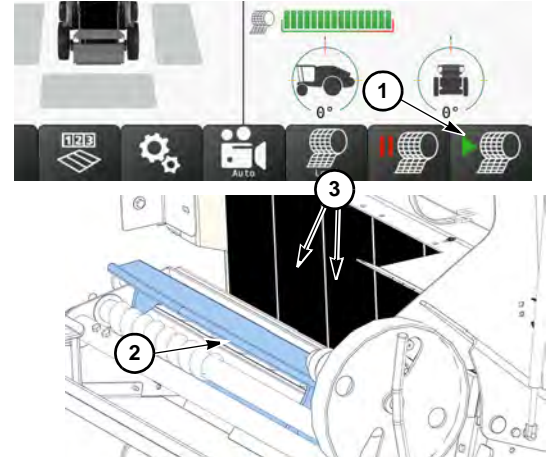

Step 2: With feed pan **(2)** fully extended against belts **(3)**, there must be no more than 1/16" (1.6 mm) clearance between brake wheel **(4)** and brake pad **(5)**.

Step 3: Adjust screw **(7)** as follows:

Loosen lock nut **(6)**.

- Out (rearward) - to bring brake pad **(5)** closer to brake wheel **(4)**.
- In (forward) - To move brake pad **(5)** further from brake wheel **(4)**.

Tighten lock nut **(6)** to secure.

Step 4: Repeat previous steps as needed to verify proper adjustment.

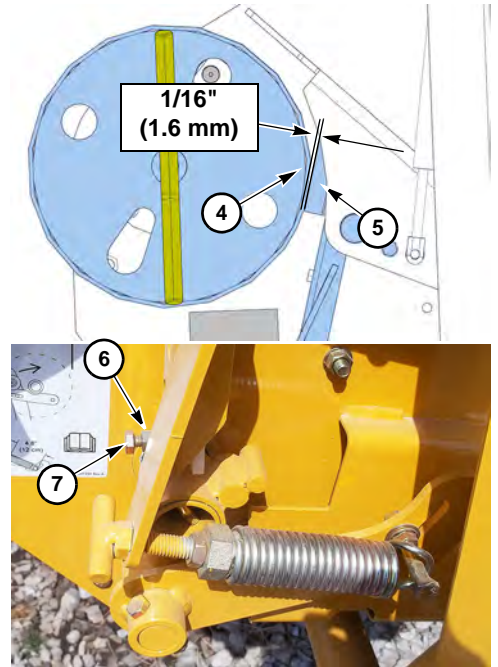

Netwrap shear bar clearance - adjust

- Step 1:** Touch and release *Settings softkey (1)* on Home screen (A).
- Step 2:** Touch and release *Manual softkey (2)* on Settings screen (B).
- Step 3:** Touch and release *Netwrap softkey (3)* on Manual Control screen (C), then touch and hold *Cut softkey (4)* and/or *Apply (5)* softkeys as needed to position top edge of shear bar (6) in center of timing hole (7).

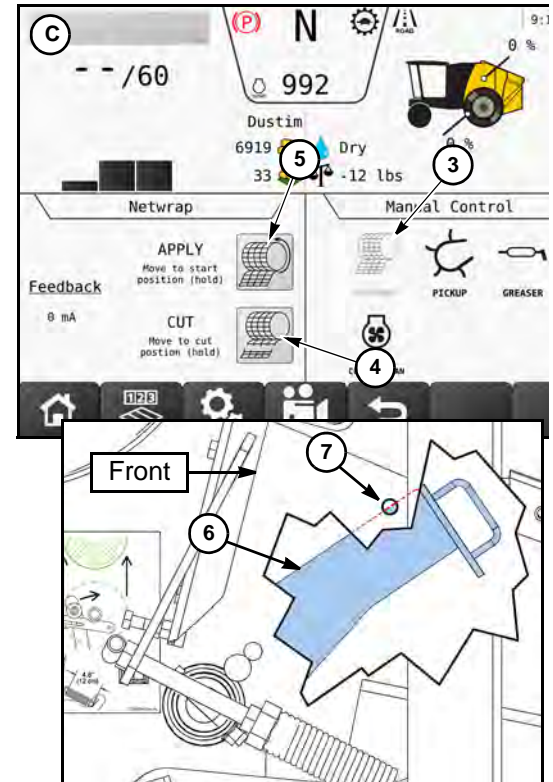
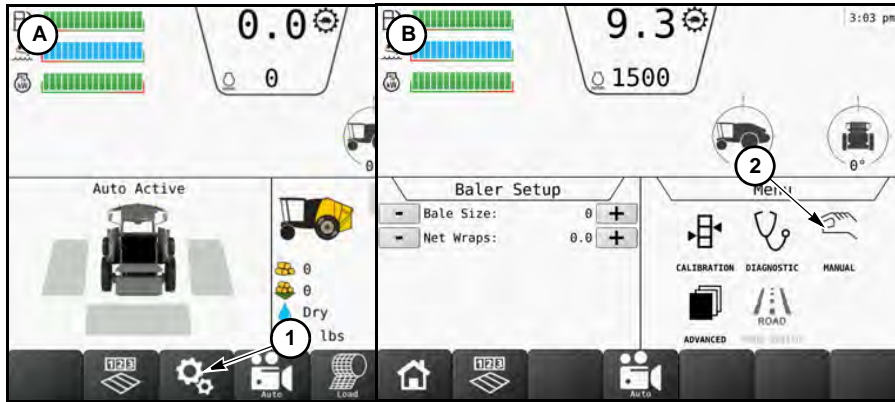

Step 4: Add timing marks **(8)** and **(9)** as shown to side panel and brake release weldment **(10)**, respectively. This helps verify position of shear bar **(6)** later in this procedure.

Step 5: Touch and hold *Cut* softkey **(4)** to manually retract netwrap mechanism to cut/home position.

Step 6: Make a bale and allow wrap cycle to start automatically. When display **(11)** indicates netwrap is feeding into bale chamber, disengage bale chamber drive, press *Pause* softkey, then turn off ignition.

Step 7: Ensure timing marks **(8)** and **(9)** are aligned. If mark **(9)** is to the rear of mark **(8)**, increase “Net Fine Tune” setting. If mark **(9)** is to the front of mark **(8)**, decrease “Net Fine Tune” setting.

Setting can be adjusted between 1.5 and 8, because this is a time setting. Refer to [page 40-9](#).

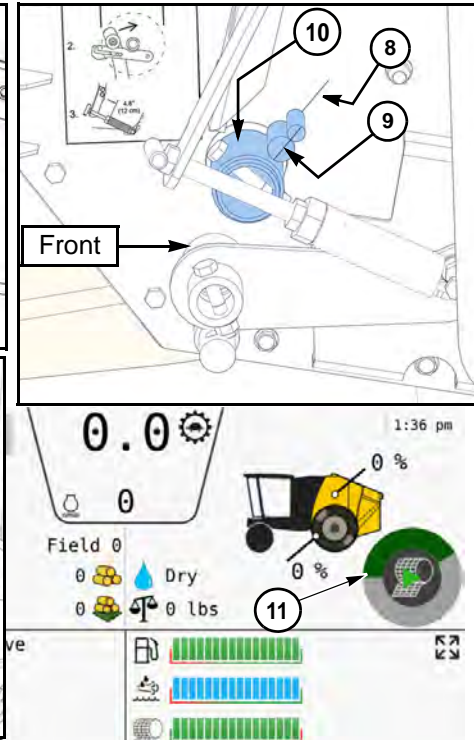
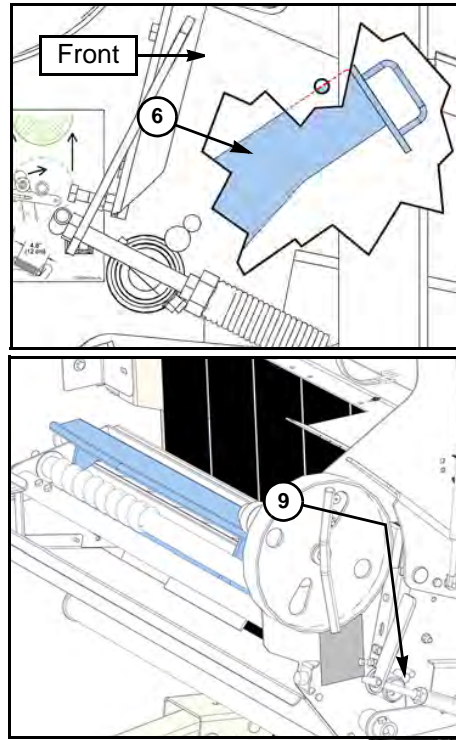

Netwrap brake spring (tension) - initial adjustment

Different brands and widths of netwrap may have varying tensile strength. Readjustment of netwrap tension may be needed when changing to a different brand or width of netwrap.

To adjust:

- Step 1:** Remove netwrap roll and ensure netwrap tension roller (5) is in unlocked position as shown.
- Step 2:** Loosen jam nut (2) and remove T-bolt (1).
- Step 3:** Ensure hook end of netwrap brake spring (4) is attached to hole (B).
- Hole (C) produces the most netwrap tension, hole (B) produces medium netwrap tension, and hole (A) produces the least netwrap tension.
- Step 4:** Install and adjust T-bolt (1) to produce a slight drag on brake wheel (6) when rotated by hand. Spring length (3) is 4.8" (12 cm) from end of spring coil to inside end of spring hook as shown.
- Step 5:** Tighten jam nut (2) to secure.

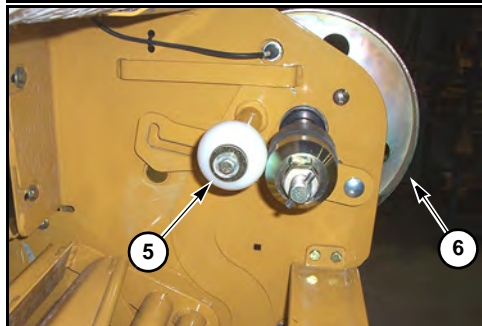
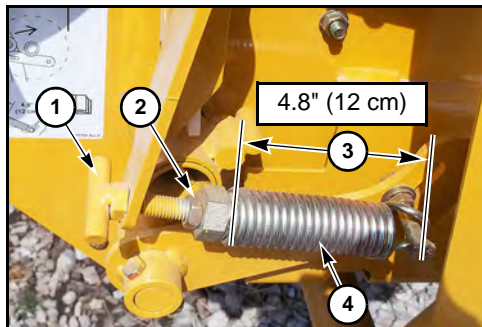
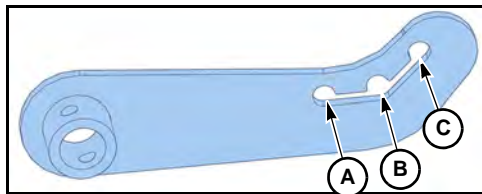

NOTICE: This is the minimum allowable spring tension. Spring (4) should never be loose.

Step 6: Install new roll of netwrap to ensure maximum roll diameter. Refer to [page 40-23](#).

Step 7: Make a bale and start the wrap cycle.

- If the net breaks before it is cut and controller shows a Net Not Feeding (520286.17) error code, netwrap tension is too high. Repeat Steps 2–3, moving hook end of spring (7) rearward to position (B) or position (A) and adjust spring (4) tension.
- If net is properly applied to bale and no error codes appear, proceed to next step.

Step 8: Continue to bale until netwrap roll is nearly empty, 6" (15 cm) or less in diameter. If net is properly applied to bales and no error codes appear, increase spring (4) tension as follows:

- Repeat starting at Step 2 on previous page and move hook end of spring (4) to position (C).
- If already using position (C) and setting is too tight, then proceed to Step 9.

Step 9: Tighten T-bolt (1) in one-turn increments each bale to increase netwrap material tension. This may cause net to break before it is cut and controller shows Net Not Feeding (520286.17) error code. Loosen T-bolt (1) as needed to restore proper wrap cycle operation and tighten jam nut (2) to secure. This is the optimal netwrap tension.

Step 10: Ensure wrap cycle operates properly with new roll of netwrap installed.

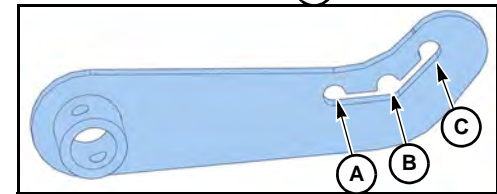
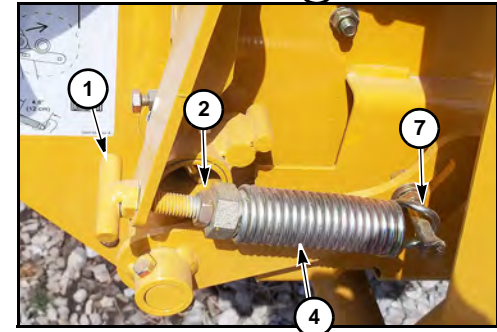
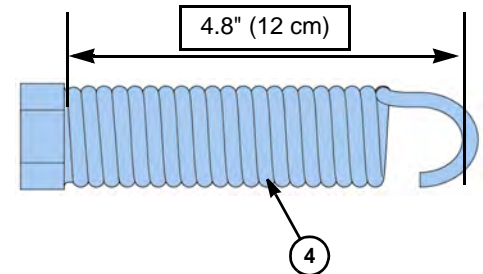

This page intentionally left blank.

Section 44: Auto lube operation

Auto lube - operational instructions

This option is used to either automatically or manually apply grease to four drive roller bearings, two drum roller bearings, and two start roller bearings.

Greaser motor is activated with the ECU after the bale size grows above 30".

Auto grease pump (1) and manifold (2) are located on the left side of the machine.

Grease cartridge located inside canister (3) is empty when spring loaded handle (5) is fully retracted into canister.

To replenish grease cartridge:

- Step 1:** Clean top of tube (4) where it threads into housing.
- Step 2:** Pull handle (5) fully out and lock in place.
- Step 3:** Unscrew canister (3) from auto grease pump (1) and remove grease cartridge from inside canister.
- Step 4:** Insert grease cartridge into canister and screw canister back into auto grease pump. Leave canister loose two turns before fully tight.
- Step 5:** Release handle (5).
- Step 6:** See instructions on the following pages to manually operate auto grease pump and purge air out of the system. Grease is pumping if current is 2.5 amps.
- Step 7:** After auto grease pump cycles one time, tighten canister (3).

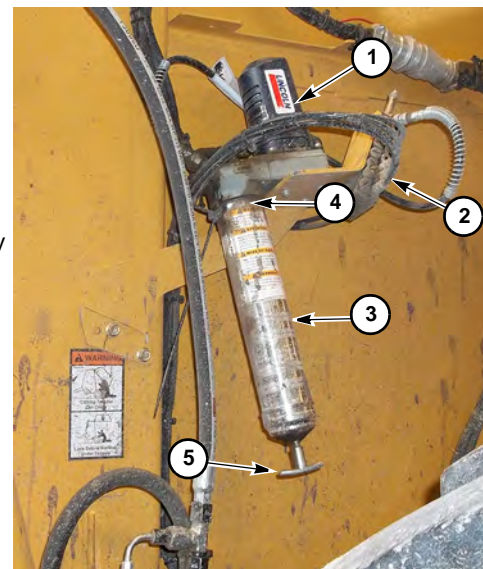

Auto lube - setup procedure

Auto lube function setup:

- Step 1:** Start from Home screen **(1)** open.
- Step 2:** Touch *Settings softkey* **(2)**, touch *Manual softkey*, then touch *Greaser softkey* **(3)**.
- Step 3:** Next to Auto Lube touch *Up arrow softkey* **(4)** or *Down arrow softkey* **(5)** to adjust amount of lubrication to be applied.

Select from Off, Low, Medium, and High. Medium is the default setting.

ECU automatically powers grease pump for 3 seconds for a grease amount of:

- High - every 5 bales
- Medium - every 10 bales
- Low - every 20 bales

With setting at medium, and 10 bales completed, controller will turn on grease pump for 3 seconds, and send grease to the four drive roller bearings, two drum roller bearings, two start roller bearings and cross drive shaft bearing. Cycle will repeat after another 10 bales.

- Step 4:** When auto lube is working, green OK/Pumping indicator **(6)** will come on.
- Step 5:** If auto lube is not working, red Not Pumping indicator **(7)** will come on, indicating grease is not pumping normally due to an air pocket at top of grease tube, tube out of grease, or greaser circuit not properly working.
- Step 6:** Touch Home softkey **(8)** to save settings and return to the “Home” screen.
- Step 7:** Touch *Back softkey* **(9)** to save settings and return to the previous screen.

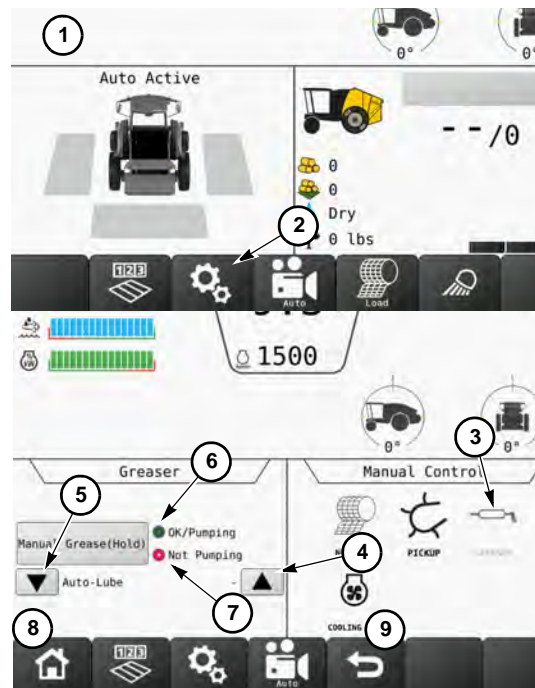

Manual lube - setup procedure

To use Manual Lube selection softkey:

Step 1: Touch and hold *Manual Lube softkey (1)* to manually apply lube to bearings any time.

When the softkey is held for 3 seconds the following will occur:

- If grease is pumping normally, green OK/Pumping indicator **(2)** will come on.
- If grease is not pumping normally, red Not Pumping indicator **(3)** will come on, indicating grease is not pumping normally due to an air pocket at top of grease tube, tube out of grease, or greaser circuit not properly working.

When the softkey is held for 15 seconds (maximum), the manual greaser function can be used to:

- purge air from grease lines
- perform special maintenance

If necessary, release softkey and touch and hold softkey again to continue to purge grease lines.

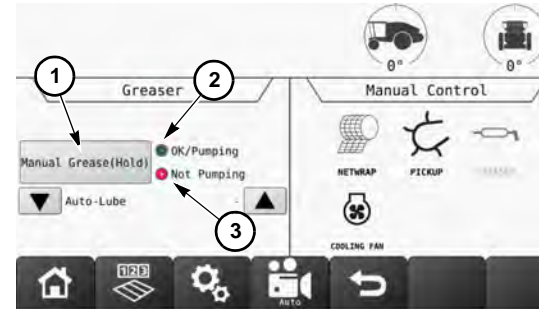

This page intentionally left blank.

Section 45: Moisture sensing

Operational moisture sensing - instructions

Moisture sensors are used to measure the amount of moisture contained in each bale.

To sense bale moisture content, two conductive plates are installed on either side of the bale chamber, and wiring connects the plates to the controller.

Because of many variations in forage harvesting, moisture indicator **(1)** should not be used as an absolute measurement but rather as a helpful guideline.

An electronic forage moisture tester can be a useful tool when baling. However, do not use a moisture tester as your sole source of information to make forage management decisions. There are many factors that can adversely affect the tester's accuracy. These include surface moisture, bale density, crop variety, temperature of the hay, overall climatic conditions and whether you use a crop preservative. Use meter readings as guides, not absolute moisture values.

Factors affecting accuracy of moisture reading are as follows:

- Only crop that contacts sensing pad **(2)** is measured.
- Varying crop density and pressure with which it contacts sensing pad.
- Natural variations within the plant before proper curing – the higher the moisture, the more variable the reading
- Use of crop preservative agent could increase the moisture reading by up to 4%.
- Percentage of grass in crop – sensors are initially set for 100% alfalfa, more grass in the crop may result in higher readings.

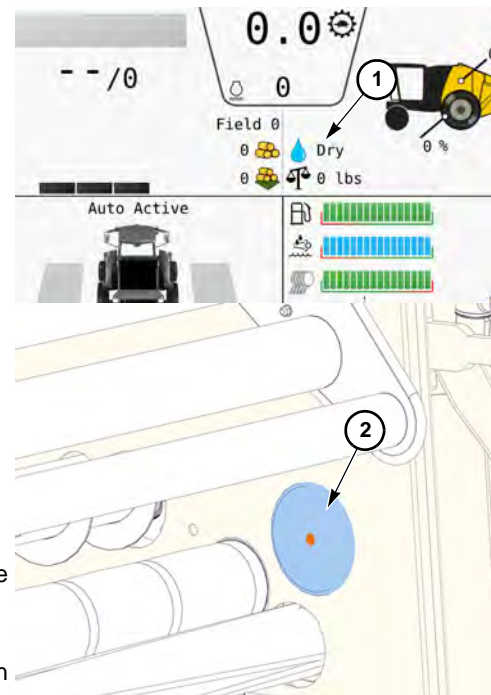

Moisture sensing operates within a range of 7–29% moisture. When operating at moisture levels above 29%, moisture display **(1)** will read “WET.” As such, display will not provide an accurate moisture reading in silage crop conditions. When operating at moisture levels less than 7%, moisture display will read “DRY.” Accuracy rating is +/- 5%.

Number displayed reflects percent of moisture content in crop material.

Moisture display - calibrate

Moisture sensing pads (1) are installed above the bale start roller (2) as shown.

Use electronic forage moisture tester as a means to test moisture of crop surface. Bale density, crop variety, temperature of the hay, overall climatic conditions and use of a crop preservative can all affect readings. Use meter readings as guides, not absolute moisture values. Moisture sensing operates within a range of 7–29% moisture.

Moisture display should be recalibrated periodically or when changing between crop types (when switching from alfalfa to grass hay, for example). This will help ensure as much accuracy as possible. Use the following procedure:

- Step 1: Ensure “FIELD” bale count is set to zero.
- Step 2: Bale a few bales to record an average moisture value.
- Step 3: Obtain representative crop sample from bales made in Step 2.
- Step 4: Cut crop into 1" (2.5 cm) pieces, keeping leaves and stems uniformly mixed.
- Step 5: Set a plate and paper towel on a digital scale.

A more accurate scale will provide more accurate results.

- Step 6: Ensure scale reading is zero with plate and paper towel on scale.
- Step 7: Put 100 grams (g) of crop sample onto paper towel. Spread sample as uniformly thin as possible.
- Step 8: Put a 10 fl-oz (300 ml) covered glass of water in the corner of a microwave oven. This will help prevent damage to oven by capturing unabsorbed microwaves as the crop sample dries.

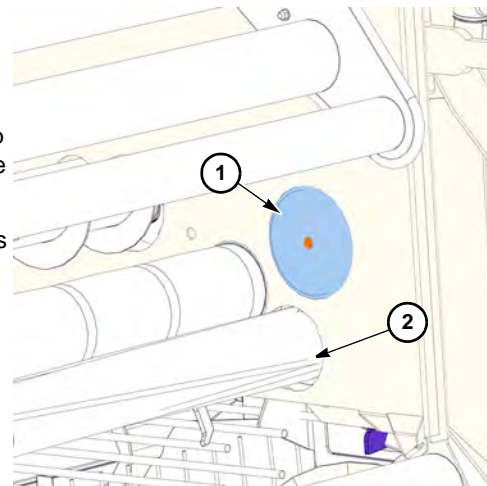

Step 9: Put the plate, paper towel, and crop sample in the oven and cook on HIGH for 5 minutes.

NOTICE: Ensure crop sample does not burn. If burning occurs, obtain a fresh crop sample and repeat Steps 1–13 using shorter intervals in the oven.

Step 10: Weigh the dried crop sample and record dry sample weight.

Step 11: Change the water, stir the sample, and cook sample on HIGH for 2 more minutes.

Step 12: Once again weigh the dried crop sample and record dry sample weight.

Step 13: Repeat Steps 11–12 until sample weight does not change more than 1.0 g between weight measurements. At this point crop sample is dry. Record final dry weight.

Step 14: Calculate moisture content as described below:

Percent moisture = $100 \text{ g (initial weight in grams, Step 7) - final dry weight (Step 13) in grams}$

• Example: $100 \text{ g (initial) - 82 g (final) = 18\% moisture}$

• Example: $82 \text{ g (final) = 82\% Dry Matter}$

With experience you can adjust cooking times and decide whether or not the glass of water is necessary. This procedure usually provides a moisture measurement that is within 2% of the true sample moisture content.

For hay, this procedure takes 10 to 20 minutes, depending on initial moisture content of sample. Practice this procedure several times before baling day to minimize time spent.

Step 15: If “Moisture” content ([Step 2](#)) is different from moisture content measured in Steps 3–14, follow the moisture offset procedure.

Moisture offset - settings

Displayed Moisture Value may be user-offset due to variations between sensed and actual/tested moisture values.

To set the Moisture Offset:

- Step 1: Touch *Settings* softkey (1) to open selections menu.
- Step 2: Touch *Calibration* softkey (2) to advance to Calibrate screen (3).
- Step 3: Touch *Moisture* softkey (4) to open Moisture Offset screen (5), shown on the following page.

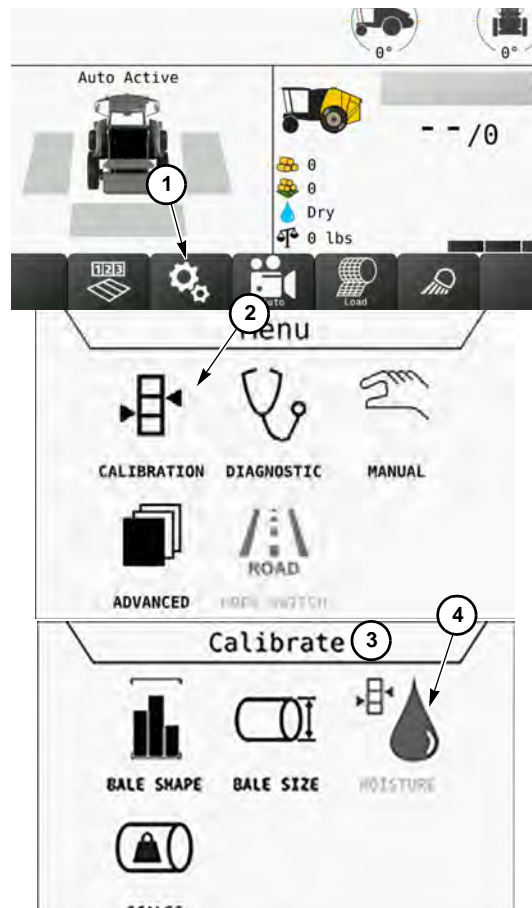

Step 4: Touch *Minus softkey (6)* to decrease offset value or *Plus softkey (7)* to increase offset value.

Moisture value may be offset by -5 to +5 percentage points, with zero value displayed as '0' **(8)**. The calibrated value is displayed, stored in statistics, and stored through power cycles.

Step 5: Touch *Back softkey (9)* to save settings and return to previous screen or menu, or touch *Home softkey (10)* to save settings and return to the "HOME" screen.

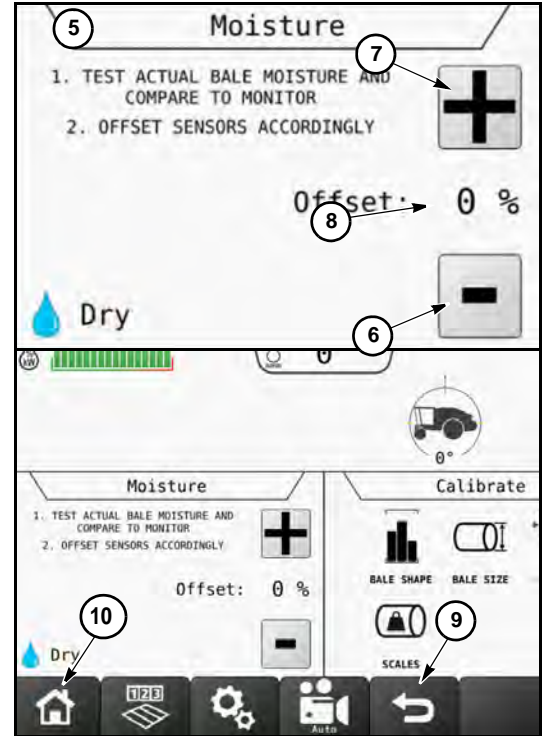

Section 50: Operating the machine

Familiarize yourself with this [operator's and maintenance manual](#) before attempting to operate the machine.

This section contains the following information:

- machine method of operation
- operation instructions for using the bale chamber in various crops, conditions, and applications
- unplugging procedures

Operator Qualifications

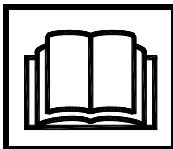

WARNING: Read Operator's Manual and safety signs before operating machine.

Allow only responsible, properly instructed individuals to operate machine.

Become familiar with the controls, operation, and use of the machine under the supervision of a trained and experienced operator.

Operator must be familiar with the workplace's safety rules and regulations, and must be mentally and physically capable of operating machine safely.

Personal protection



WARNING: Wear required personal protective equipment. Wear close-fitting clothing and confine long hair. Avoid jewelry, such as rings, wristwatches, necklaces, or bracelets. Always wear safety glasses and safety shoes.

Some working conditions and regulations may require the use of other appropriate PPE, such as hearing protection, hard hat, gloves, face shield, or any other PPE necessary to provide proper safety protection for the work being performed.

Safe operating practices

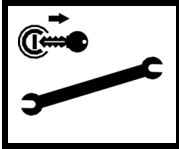

WARNING: Use shutdown procedure before servicing, cleaning, repairing, or transporting machine. Refer to page [23-1](#).

Never leave machine controls unattended while baler is operating.

Be sure you are familiar with location and function of each baler control before operating baler. Refer to “Machine controls,” [page 20-1](#).

Keeps doors and windows closed while operating machine.



WARNING: Failure to wear seat belt may lead to being thrown from seat. The seat belt is an essential part of safe operation. Always wear seat belt when machine is being driven.

The instructional seat is provided for training or diagnosing purposes only and is not intended for children or other passengers.

Seat belt must be worn at all times while operating machine. A person riding in the instructional seat must also wear a seat belt and avoid obstructing view of operator. Do not allow children or other passengers to ride on the machine or in the cab.

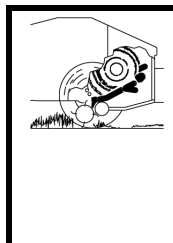

DANGER: Baler intake can pull you in, resulting in death or serious injury. Stay clear of pickup reel and feed intake area. Baler may take in crop faster than you can let go. NEVER feed crop or twine by hand.

NEVER remove any material from the baler intake while it is running.

NEVER try to unplug the baler while it is running. Refer to [page 50-24](#).

ALWAYS disengage baler drive, shut off engine, engage park brake, and remove key before manually unplugging or servicing.



WARNING: Falling from baler can result in serious injury.

Riders are not allowed on the baler.

Do not climb. If access is needed, use suitable height stepladder.

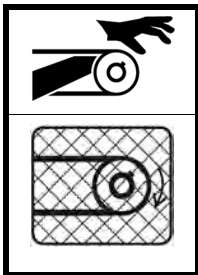

WARNING: Belts, rollers, and chains can cut off hand or arm.

Keep all shields in place when operating.

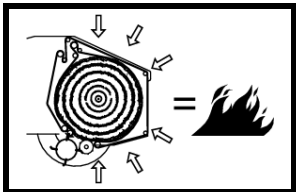

CAUTION: Oversized bales place excessive load on belts, rollers and bearings which could result in product or property damage and is a fire hazard.

Fire prevention

A fire can ignite during certain baling conditions - especially when baling dry material. To help reduce this risk:

- Eject bales as soon as they have been wrapped. Never leave a baler unattended with a bale in the chamber.
- Do not allow foreign material to build up under shields or near potentially hot areas of the baler such as roller bearings. Remove any buildup as part of the regular maintenance operations.



- Keep baler clean. Do not over-lubricate chains. Clean excess oil and grease off shields and baler sides around chains.
- Stop machine immediately if the baler plugs. Continuing to run baler may result in excessive heat buildup along the belts, rollers, or chains. Use [Shutdown procedure](#), page [23-1](#), and remove plug before proceeding. Refer to [page 50-23](#).
- Check regularly for overheating of moving parts such as bearings. Monitor for bearing temperature variations using bearing status screen. Refer to [page 21-16](#). Check for peeled paint or discolored metal, or use a suitable non-contact thermometer to measure temperature of the surrounding area.
- Stop and investigate any noticeable changes in baling performance, which might indicate that a part is starting to fail. Use [Shutdown procedure](#), page [23-1](#), and determine the source of any unusual sounds, smells, or sights. Replace worn or overheating parts before continuing to bale.
- Before parking the baler, verify that there are no areas on the baler hot enough to start a fire. Do not park a hot baler near or inside a building.

Fire - extinguish



WARNING: Do not risk personal injury by trying to extinguish a fire that is too far advanced.

If you can safely extinguish the fire, follow these guidelines:

- Step 1:** Leave baler drive engaged. This allows for more even heat distribution, and helps increase likelihood of successfully extinguishing fire.
- Step 2:** Position machine facing into wind to help prevent the fire from overtaking the cab.
- Step 3:** Eject any crop from the bale chamber and drive away from the ejected crop.
- Step 4:** Fully close tailgate and disengage baler drive.
- Step 5:** Press and hold bale chamber unload switch to fully extend arms until bale chamber is on ground. Refer to [page 50-28](#).
- Step 6:** Drive power unit away from bale chamber and shut off engine.

Step 7: Spray water from fire extinguisher at the base of the flame to extinguish it and cool surrounding parts. Refill fire extinguisher, if possible, and continue to extinguish the fire as needed.

Preparing for Operation



WARNING: Ensure operator is the only person riding the baler, unless the baler is equipped with an approved instructional seat and seat belt. Never carry riders on machine. Falling from machine can result in death or serious injury.

For instructions, refer to “Preparing the equipment,” [page 25-1](#).

- Preparing the crop. Refer to “Crop preparation,” [page 35-1](#).
- Preparing the windrow. Refer to “Windrow preparation,” [page 35-2](#).
- Determining moisture content. Refer to “Operational moisture sensing - instructions,” [page 45-1](#).

NOTICE: An electronic forage moisture sensor can be a useful tool when baling. However, do not use a moisture sensor as your sole source of information to make forage management decisions. There are many factors that can adversely affect the sensor's accuracy. These include surface moisture, bale density, crop variety, temperature of the hay, overall climatic conditions and the use of a crop preservative. Use meter readings as guides, not absolute moisture values.

Diesel particulate filter (DPF) safety

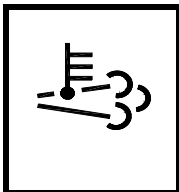

WARNING: When *Regen Active Icon* is displayed, the exhaust gas temperature could exceed 1100°F (600°C) during regeneration. High temperature may result in fire, burn, or explosion hazards, which may result in death or serious injury. Do not expose flammable material or explosive atmospheres to exhaust gas or to exhaust system components during regeneration.

The *Regeneration Active Icon* turns on and off during normal machine operation as the engine completes regeneration. It does not signify the need for engine service.



NOTICE: To prevent fires, routinely clear any combustible material from the engine exhaust system. Tier 4 Final/Stage V emission compliant exhaust systems use extreme high temperature that can ignite combustible material.

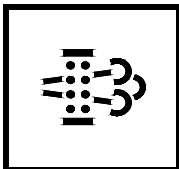

ALERT: The *DPF Indicator* indicates a need for a manual regeneration, due to engine or operator conditions being outside the range for automatic regeneration. Move machine to a safe location and press *DPF Manual Regeneration Button*. After regeneration, follow these guidelines to reduce soot buildup in the DPF:

- Only inhibit DPF regeneration when necessary due to fire hazard.
- Limit idling time.
- Operate engine at higher load.
- Use proper engine oil. Refer to “Specifications,” [page 65-1](#).
- Use only ultra low sulfur diesel fuel.

NOTICE: Prolonged inhibiting of DPF regeneration can cause damage to engines and aftertreatment system.

DPF alert indicators



DPF Inhibit Regeneration Indicator indicates *Inhibit DPF Regeneration Button* has been pressed. If regeneration is inhibited for too long, more alerts will illuminate and eventually the engine will derate.



Amber *Engine Alert Indicator*, when illuminated along with *DPF Icon*, indicates DPF soot level is high and will automatically cause engine to partially derate. Perform a DPF manual regeneration at the earliest and safest opportunity.

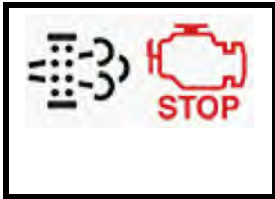

Red *Engine Alert Indicator*, when illuminated along with *DPF Icon*, indicates machine operation has been allowed to continue beyond initial alerts. Engine will completely derate, and rolling shutdowns could occur. This may result in premature failure of exhaust system components and an engine service technician will be required to perform a service regeneration.

Arriving at the field



WARNING: Be alert and use extreme caution when operating on hillsides or near ditches, gullies, holes, or obstructions where rollover could occur. Watch out for and avoid any object that might interfere with the proper operation of the baler (i.e. stones and limbs).



DANGER: Electrocution hazard exists around an energized overhead power line. If equipment gets near or contacts energized overhead power line, all connected equipment and surrounding ground surface will be energized. Death or serious injury will result due to electrocution.

Keep machine away from energized overhead power lines according to chart below.

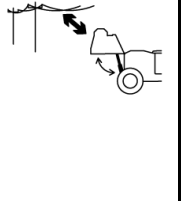

<u>Voltage, kV</u>	<u>Minimum Clearance Distance, ft (m)</u>
up to 50	10 (3.1)
>50 to 200	15 (4.6)
>200 to 350	20 (6.1)
>350 to 500	25 (7.7)
>500 to 750	35 (10.7)
>750 to 1000	45 (13.8)

If arcing or contact occurs, do the following:

- If on machine, stay on machine. Anyone on ground should shuffle away keeping feet together on the ground.
- Contact utility company to shut off electrical power.
- Do not allow anyone to approach the machine or any connected equipment.
- Do not resume operation until utility company declares area safe.

Crop feed direction

Generally, the crop should be fed into the baler leaf (or seed head) end first. The leaf end is more flexible and will start a bale more easily.

- If a sickle bar mower was used to cut the crop, baling should be done the same direction as mower travel.
- If a rotary mower was used to cut the crop, baling should be done the opposite direction of mower travel.

Operator's station



WARNING: Never leave machine controls unattended while operating.
Never leave machine unattended with tailgate open unless tailgate lock valve is engaged.

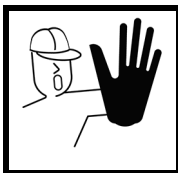

WARNING: Contact with machine or bales can result in death or serious injury.
Survey area around baler for persons or obstacles before moving the machine.
Keep all spectators and other workers away from machine and work area while in operation.

Prepare baler

Step 1: Start machine. Pickup is automatically lowered.

Step 2: Check pickup height adjustment.

Step 3: Check that tailgate is closed and latched - use machine hydraulic control.

Step 4: Adjust controller settings if necessary.

Step 5: Engage bale chamber drive.

After core of bale is formed, decreasing baler drive speed may be advisable under the following conditions:

- When baling very dry or short-stemmed crops
- When baling crops in small windrows

Step 6: Align machine with **center of windrow**.

Bale formation

- Windrowed crop is lifted from the ground by the pickup tines and fed onto the drum roller.
- Pickup reel rotates around dual cam tracks (one cam track at each end). Pickup teeth aggressively lift windrow over front side of pickup bands, then retract to release crop at rear of pickup bands. Dual augers at each end of pickup are designed to move a small amount of excess crop inward and up into bale chamber. Pickup may plug if too much crop is fed to augers while starting a new bale. Therefore, it is important that windrow width is within maximum limits described on the previous page.
- Machine hydraulics drive powered windguard rotor, which helps pickup move crop into bale chamber. This option is typically recommended for baling cornstalks.
- Drum roller moves crop rearward against the belts. The belts move crop up until crop contacts down-moving belts and the start roller. This begins the rolling action that forms the bale core.
- As bale increases in size, belt slack expands around bale and lower belt tightener arm moves up.
- Lower belt tightener arm initially moves upward without restriction. This helps ensure quick and successful bale starting.
- After bale core is formed, lower belt tightener arm contacts upper belt tightener arm. As bale grows, lower and upper belt tightener arms move upward together.
- As bale grows, belt tightener movement is restricted by a combination of spring and hydraulic cylinder pressure. This tightens belts and packs crop material into a dense bale. Friction between crop material and bale chamber walls also increases bale density.
- Target full bale size (1) can be set anywhere between 35–72" (76–183 cm). Current bale size as indicated by the bar graph (2) just before bale ejection should match actual size of ejected bale. Belt length may change over time. As belt length changes, actual bale size will become larger or smaller than current bale size (3).

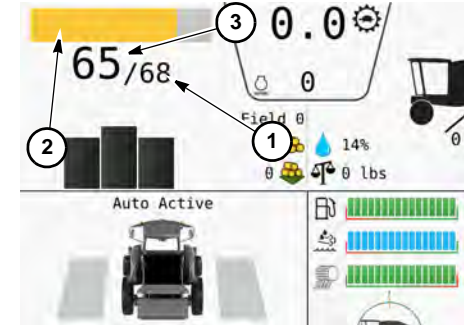

Baling speed

General baling speed depends on conditions. Never bale faster than conditions allow.

Reduce speed on hills, for rough terrain, and until operator is proficient at forming a bale.

Bale density

Factors influencing bale density:

- Type of crop and shape of windrow - refer to "Preparing the crop to bale," [page 35-1](#).
- Baling speed - when crop is fed rapidly into the baler, more crop is added to the bale per revolution and density is reduced.
- Belt tension - spring and adjustable hydraulic resistance maintain belt tension. The higher the belt tension, the denser and heavier the bale will be.
- Friction and pressure from bale chamber sidewalls - if density is too high, main drive overload clutch may disengage.

Bale size

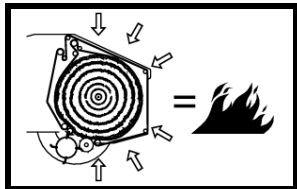

CAUTION: Bales over 72" (183 cm) place excessive load on belts, rollers and bearings which could result in product or property damage and is a fire hazard.

- Generally, the smallest desirable bale is 46" (117 cm) in diameter. Maximum bale size is 72" (183 cm).
- Do not leave a partially formed bale in the chamber. Ensure bale chamber is empty before shutting down baler.

Bale shape

Bale shape sensors

With electronic control system, rotary sensors (1) are used to sense belt tension during bale formation, and provide this information to the operator via bale shape bar shown on display. Tighter belts correspond to an area of bale containing more hay, and indicated by taller bars on the display.

Sensors help to achieve a high material intake and well-shaped round bales. The bale chamber must be evenly supplied with material over the entire width of the machine by an appropriate driving style.

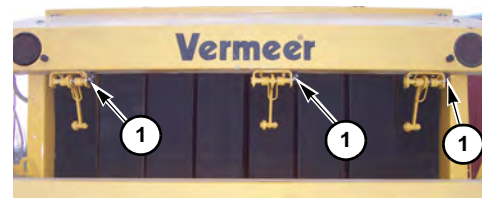

Bale shape indicators

With electronic control system, bale shape indicators are used to show shape of bale.

Bale chamber is evenly supplied with material over the entire width of the machine.

Continue driving.

Currently too little material in the left part of the bale chamber.

Steer machine a bit to the right and let the left part of the pickup collect more material, until the left sensor bar is of equal height again.

Currently too little material in the right part of the bale chamber.

Steer machine a bit to the left and let the right part of the pickup collect more material, until the right sensor bar is of equal height again.

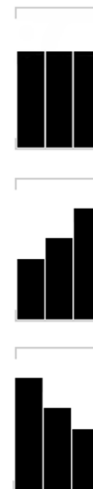

Baling

Single windrow (1/2 width of bale chamber):

- Step 1:** Position baler to direct windrow to the center of the pickup, drive straight forward for 2–5 seconds, then steer hard left.
- Step 2:** When windrow reaches right edge of pickup, drive straight forward for 1–2 seconds.
- Step 3:** Steer hard right to return windrow to left edge of pickup.
- Step 4:** When windrow reaches left edge of pickup, drive straight forward for 1–2 seconds.
- Step 5:** Steer hard left to return windrow to right edge of pickup.
- Step 6:** Repeat Steps 2–5.

NOTICE: Steps 2–5 must be done in rapid succession to successfully form the core of the bale. If the core is only formed on one side of baler, belt flipping may result. Continue to weave quickly until bale size begins to grow.

Bale shape sensing function described in Steps 7–10 (next page) is optional equipment. Use weaving pattern shown at right when baling without bale shape sensing.

After core of bale is formed, decreasing baler drive speed may be advisable under the following conditions:

- When baling very dry or short-stemmed crops
- When baling crops in small windrows

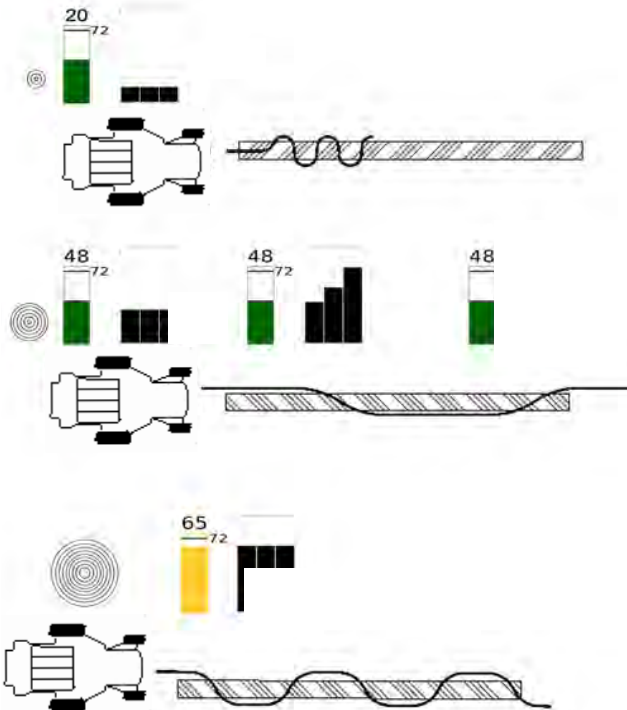

Step 7: Feed crop to the right edge of bale chamber for several seconds until controller display **(1)** indicates 4–5 more bars on the right side, then steer right.

Step 8: Feed crop to the left edge of bale chamber for several seconds until controller display indicates 4–5 more bars on the left side, then steer left.

Step 9: Continue baling, alternating from side to side as in Steps 7 and 8, until bale reaches full size. Left and right controller bars **(1)** will rise and fall.

Step 10: When nearing the target full bale size, feed crop more slowly or weave more quickly to keep the bars even as shown **(2)**.

Step 11: Wrap bale with netwrap. Refer to “Netwrap - Apply to Bale,” [page 40-14](#).

If Auto mode direction is selected, bale will be wrapped automatically when full bale is reached.

Double window (full width of bale chamber):

- Position baler centered on the window.
- Drive, without weaving, until bale reaches full size. The full width window eliminates the need for weaving.
- Follow Step 11 to finish bale. *No action required if Auto mode direction is selected.*

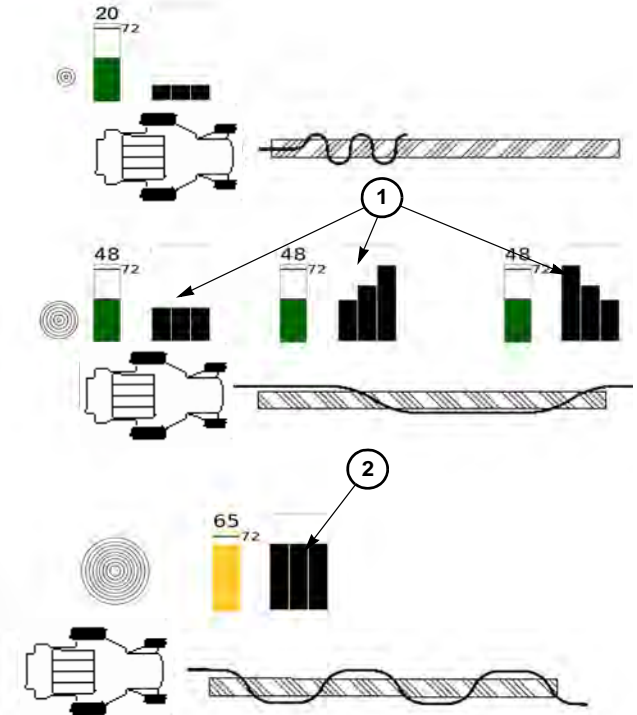

Wrapping the bale

Wrapping the bale - electronic controller

Standard operation – When current bale size **(1)** is equal to target full bale size **(2)**, controller automatically begins the bale wrapping cycle using either twine or netwrap.

Auto mode – If an auto mode direction is selected, bale will be automatically ejected. Bale is ejected after machine automatically comes to a stop at full bale and wrapping cycle is completed. If no direction is selected or auto mode is canceled, you must manually eject bale after machine automatically comes to a stop at full bale and wrapping cycle is completed. Refer to [page 20-10](#).

Netwrap – Refer to page [40-14](#).

Operator can manually begin bale wrapping cycle at any time by pressing and releasing the *Start softkey (3)*.

When wrapping cycle is finished, audible device sounds, 1 beep, and tailgate can be opened to eject bale. If an auto mode direction is selected, tailgate will automatically open when wrapping cycle is finished.

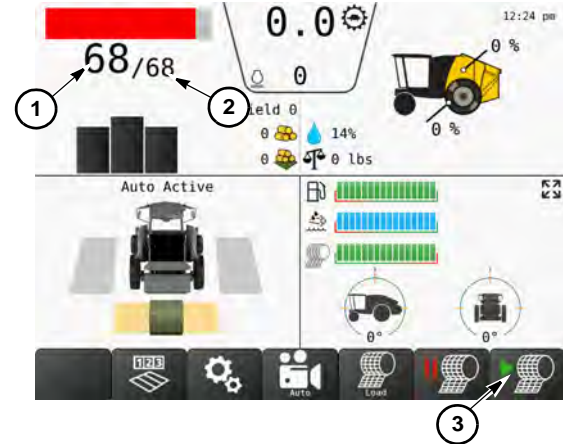

Wrapping the bale sequence - netwrap

- Controller sends power to an electric actuator connected to netwrap mechanism.
- Feed pan pushes against belts, which pull netwrap into bale chamber.
- As feed pan is extending forward toward belts, brake release weldment (6) rotates rearward and pushes against bottom of brake arm (4).
- Brake arm (4) pivots around pin (3), pulling brake pad (2) forward and away from brake wheel (1). This allows brake wheel to rotate freely and helps ensure netwrap feeds correctly at beginning of wrap cycle.
- As netwrap begins to feed into bale chamber, netwrap mechanism reverses and retracts slightly toward home/cut position. Brake release weldment (6) rotates forward and releases brake arm. Netwrap tension spring (5) takes over, pulls brake arm (4) forward, and brings brake pad (2) into contact with brake wheel (1).
- As netwrap continues to feed onto bale, netwrap tension spring (5) forces brake pad (2) against brake wheel. This adds resistance to brake wheel rotation, thereby adding tension to and stretching netwrap as it feeds onto bale.
- When desired amount of netwrap has been applied to bale, netwrap mechanism returns to home/cut position. Shear bar rotates down and pinches netwrap against netwrap knife assembly. Netwrap cuts as it pulls across netwrap knife.
- Amount of netwrap applied to bale is adjustable by pressing and holding *Net Density Key* while pressing and releasing *Up/Down Arrow Keys*.

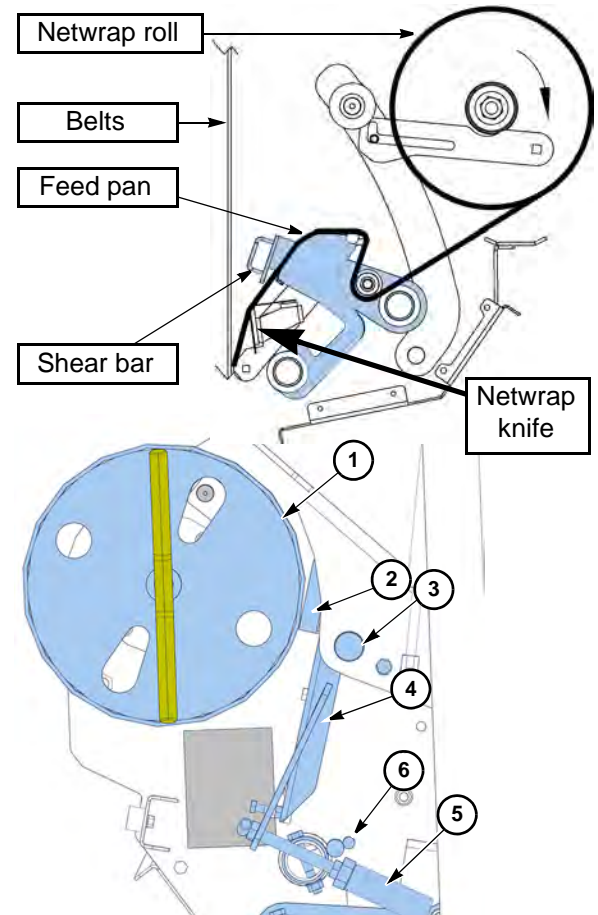

Ejecting the Bale

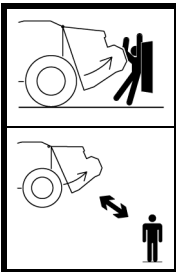

WARNING: Opening tailgate can crush, resulting in death or serious injury.

Stay away from rear of baler. Warn others to stay away before opening tailgate.



WARNING: Rolling bale can crush

Do not eject downhill.



WARNING: Contact with baler or bales can result in death or serious injury.

Survey area around baler for persons or obstacles before moving the machine.

Keep all spectators and other workers away from baler and work area while in operation.

Ejecting the bale

NOTICE: Bale ramp is **not** designed to force bales away from baler. It is designed to help bales roll clear of tailgate on level to slightly downhill grades. On steeper slopes, backing away from windrow prior to ejecting bale will be necessary.

NOTICE: Do not back over a windrow; damage to pickup will result.

Step 1: After wrapping bale, fully open tailgate - bale will eject.

Icon **(1)** indicates open tailgate.

If an auto mode direction is selected, bale will be automatically ejected.

Bale may not roll far enough to clear tailgate if its rolling speed is reduced.

Possible causes:

- Ejecting bale up a slope - eject on level ground.
- Bale is soft - increase density setting, improve windrow shape.
- Bale is sticking in bale chamber - add restrictor plates.
- Insufficient hydraulic flow to tailgate circuit - check machine hydraulics.

NOTICE: Do not leave a bale in the chamber for an extended period of time - it can become distorted and difficult to eject.

Step 2: If bale drive was shut off, start it to align belts.

Step 3: Close and latch tailgate. Hold machine hydraulic control until tailgate closed icon **(2)** appears indicating tailgate has closed and latched. Audible device sounds 1 beep, indicating tailgate is closed and machine is now ready to continue baling.

If an auto direction is selected, tailgate automatically closes.

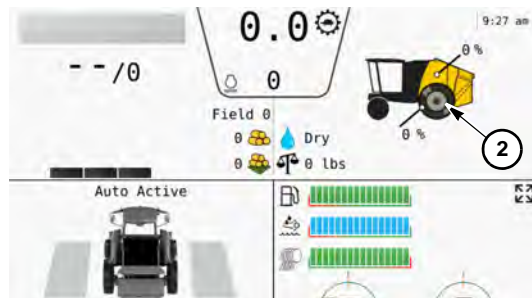
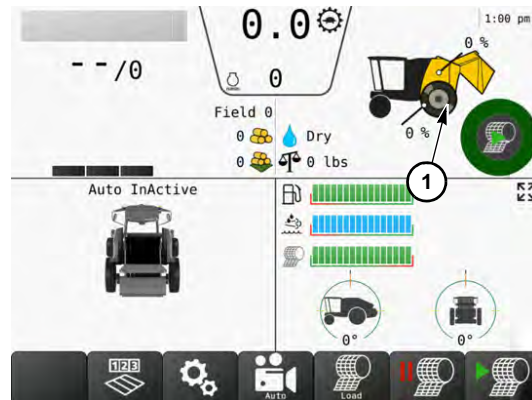

Unplugging the Baler

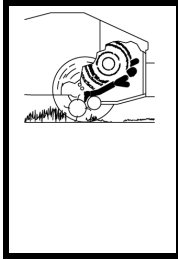

DANGER: Baler intake can pull you in, resulting in death or serious injury. Stay clear of pickup reel and feed intake area. Baler may take in crop faster than you can let go.
NEVER feed crop or twine by hand.
NEVER remove any material from the baler intake while it is running.
NEVER try to unplug the baler while it is running. Refer to [page 50-24](#).
ALWAYS disengage baler ground drive, shut off engine, engage park brake, and remove key before manually unplugging or servicing.

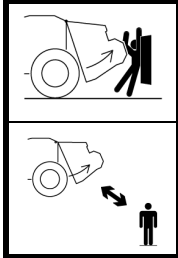

WARNING: Opening tailgate can crush, resulting in death or serious injury.

Stay away from rear of baler. Warn others to stay away before opening tailgate.

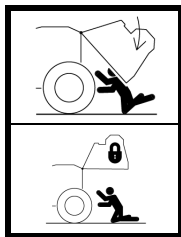

WARNING: A falling or closing tailgate can crush, resulting in death or serious injury.

Lock before working under tailgate.

Plugged pickup area

- Step 1:** Back up from incoming crop (this may be enough to clear the plug).
- Step 2:** Reverse pickup (2–3 seconds at a time) while bale chamber is engaged to clear plug. If plug does not clear after three attempts, then continue to next step.
- Step 3:** Disengage bale chamber drive.
- Step 4:** With engine operating at or near low idle speed, engage bale chamber drive. If plug does not clear, ensure pickup is fully lowered and proceed as follows:
- Step 5:** Open tailgate and remove failed core.
- Step 6:** Move tailgate cylinder lock valve to locked position.
- Step 7:** Follow [Shutdown procedure](#), page 23-1.
- Step 8:** Pull crop material through bale chamber to clear the throat.
- Step 9:** Move tailgate cylinder lock valve to unlocked position.
- Step 10:** Close and latch tailgate.
- Step 11:** Repeat Steps 4–10 as required.

Flipped belt - reposition

- Step 1: Open tailgate fully.
- Step 2: Shut off machine, remove key, and install cylinder stop on density cylinder.
- Step 3: Start machine and using hydraulics, close tailgate partially to loosen belts.
- Step 4: Move tailgate cylinder lock to locked position. Refer to page [20-1](#).
- Step 5: Follow [Shutdown procedure](#), page [23-1](#).
- Step 6: Find lace on flipped belt and remove pin and discard.
- Step 7: Rethread belt.
- Step 8: Install new pin **(1)**.
- Step 9: Move tailgate cylinder lock to unlocked position.
- Step 10: Start machine and open tailgate fully.
- Step 11: Shut off machine, remove key, and remove cylinder stop on density cylinder.



Unloading and Loading Bale Chamber

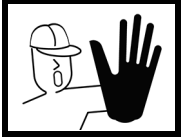

WARNING: Contact with baler or bales can result in death or serious injury. Survey area around baler for persons or obstacles before moving the machine. Keep all spectators and other workers away from baler and work area while in operation.

The bale chamber can be unloaded for cleaning, maintenance, service, or replacement. A hard level surface is required or machine damage could result. Follow the steps below to unload or load the bale chamber.

To unload bale chamber:

- Step 1:** Park machine on a hard level surface.
- Step 2:** Follow shutdown procedure. Refer to “Shutdown procedure,” [page 23-1](#).
- Step 3:** Turn handle **(1)** counterclockwise and pull left side access door **(2)** open.

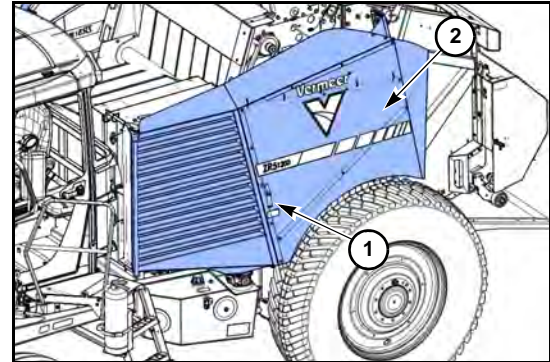

- Step 4: Press and hold button **(3)** while pulling lever **(4)** toward front of machine and disconnect hydraulic lines **(5)**.
- Step 5: Disconnect electrical connector **(6)**.
- Step 6: Support hydraulic lines **(5)** and electrical connector **(6)** by hanging them on hook **(7)**.
- Step 7: Disconnect electrical connector caps **(8)**.

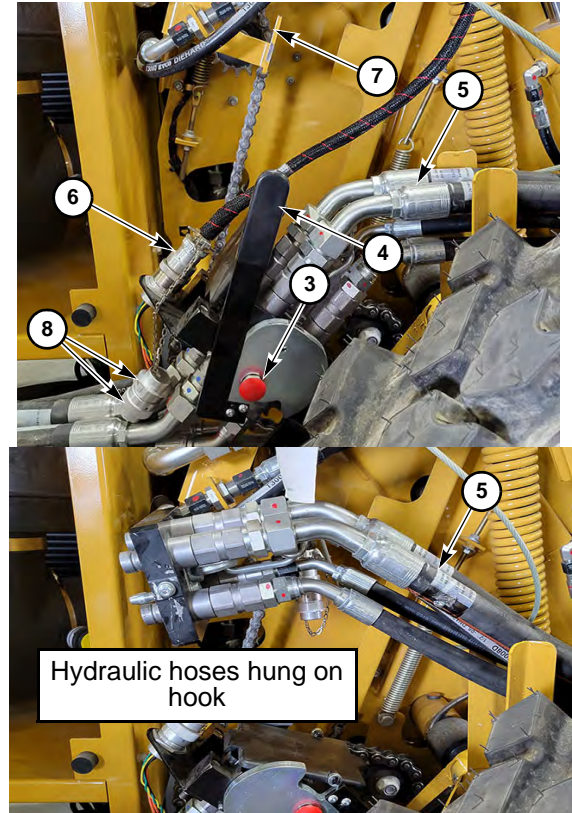

- Step 8:** Install caps **(8)** on electrical connectors.
- Step 9:** Start engine.
- Step 10:** Press and hold bale chamber unload switch **(9)** to fully extend arms **(10)** until bale chamber is on hard level surface.
- Step 11:** Drive power unit away from bale chamber.

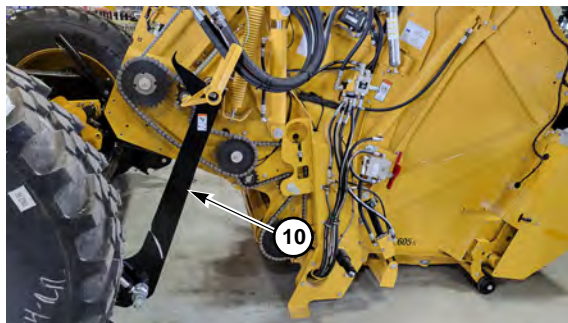

If an emergency requires it, follow **ONLY** steps 10 and 11 to unload the bale chamber and drive the power unit away.

NOTE: Machine damage could result.

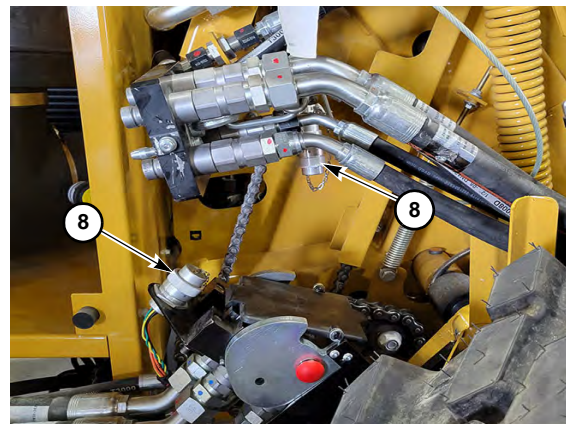

To load bale chamber:

- Step 1:** Back power unit up to bale chamber until arms **(10)** are in correct position.
- Step 2:** Press and hold bale chamber loading switch **(11)** until bale chamber is fully loaded onto power unit.

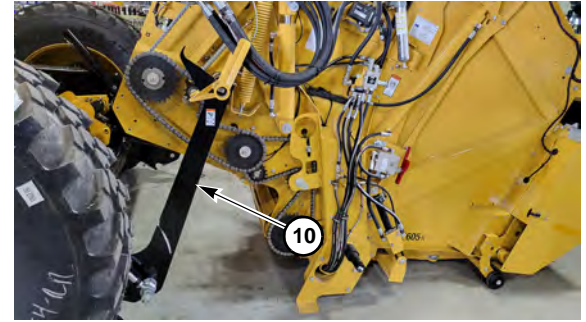

Step 3: Remove connector caps **(8)**.

Step 4: Clean any dirt or debris from faces of hydraulic couplings.

Step 5: Connect hydraulic lines **(5)** and pull lever **(4)** toward rear of machine to lock lines in place.

Step 6: Connect electrical connector **(6)**.

Step 7: Connect caps **(8)** together.

Step 8: Close left side access door.

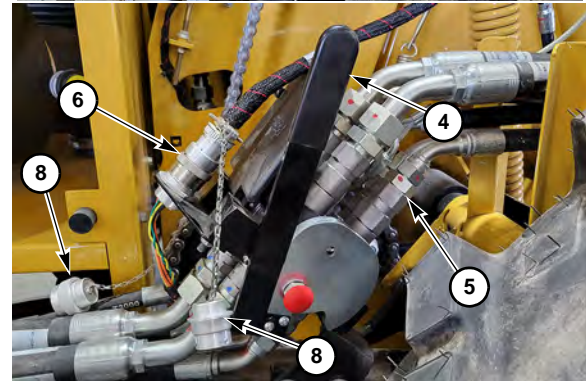
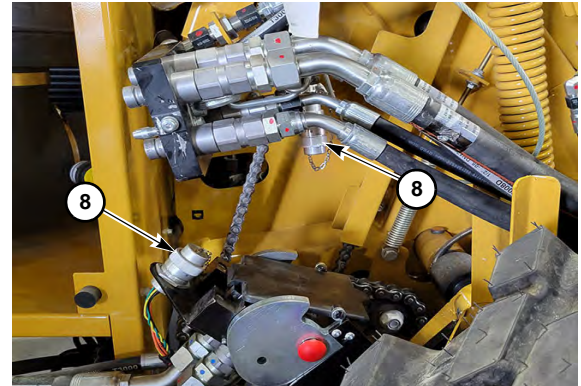

Operational messages

Net not feeding alert

During the baling operation an alert may sound with several intermittent tones, to indicate a fault has occurred. A message appears on screen **(1)** for the fault and what actions are needed to correct the issue.

High priority alert, audio device will sound with 12 intermittent tones.

Medium priority alert, audio device will sound with six intermittent tones.

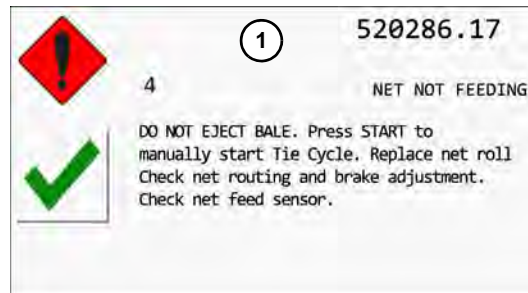

Tailgate open alert

If the tailgate is sensed as open anytime other than after a tie cycle and up to 8 seconds after a bale is counted [sensed bale size drops below 30" (76 cm)], an alert is displayed. Audible device sounds, six beeps, indicating to the operator that tailgate needs to be closed.

- Alert screen **(1)** appears.
- Display indicates an open tailgate message **(2)**.
- Close tailgate using the machine's hydraulic control.
- Alert screen **(1)** disappears.
- Home screen appears and display indicates a closed tailgate **(3)** for normal operation.

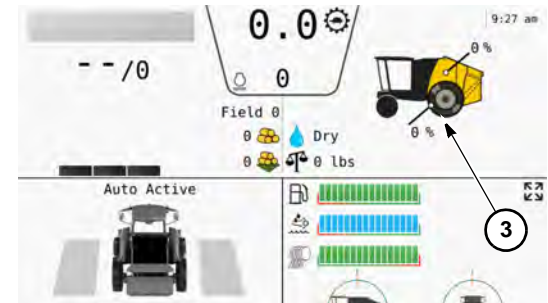
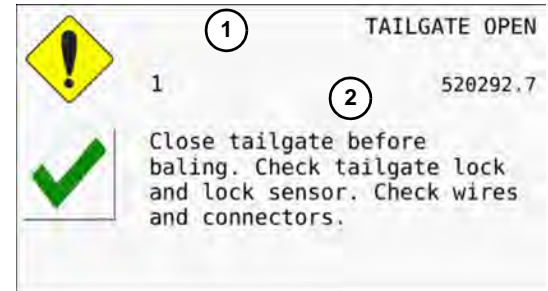

This page intentionally left blank.

Section 51: Handling round bales

Bale carriers

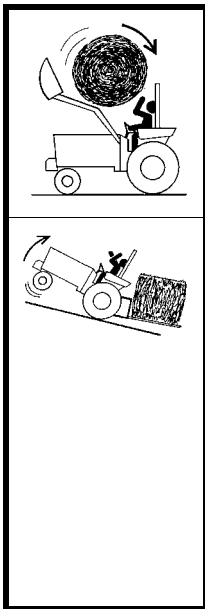

WARNING: Rapid or sudden movement can greatly increase the possibility of tractor rollover.

Sloped ground, rough terrain, or adverse conditions may adversely affect braking, steering, and stability.

Suddenly applying tractor brakes when carrying a bale on a rear-mounted bale carrier may cause the front end of the tractor to swing over - possibly resulting in loss of control.

- Use a tractor with a rollover protection structure (ROPS) or a cab with built-in rollover protection.
- Use only tractors that are large enough to maintain adequate stability when handling bales. Additional front or rear end weight may be required. Follow recommendations of bale carrier manufacturer.
- Rear wheels should be set at maximum width, if possible, to increase tractor stability.
- Never carry a bale in a high position unless absolutely necessary and then only with extreme caution - moving very slowly and smoothly.
- Front-mounted bale handler must be equipped with a grapple or similar restraint device to prevent bale from rolling down loader arms onto tractor operator.

Storing bales



WARNING: Do not store bales on a surface that is too steep and where the potential for tipping over exists. Serious injury to people, especially children, could result.

Crops such as straw, sudan grass, and other non-hay crops have a greater tendency to absorb moisture and should be stored under plastic, shedded, or wrapped with netwrap.

Hay, alfalfa, forage sorghums, and grasses will roll into weather resistant bales and can be stored outside because the round shape helps resist moisture penetration and wind damage.

A few days after crop is baled, a protective crust forms on outside of the bale. Precipitation on the bale follows plant stems around the surface to the ground. The crust on well-formed bales is no more than 3–4" (8–10 cm) thick and is mostly edible by livestock.

Correct bale storage

Place on solid, high ground.

Align single rows (1) at least 1 ft (30 cm) apart.

Rows should follow slope of ground.

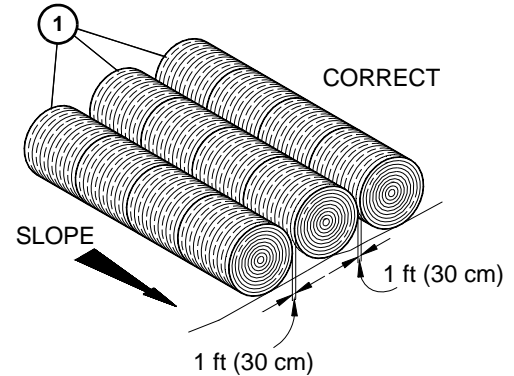

Incorrect bale storage

Water will collect between stacked bales (2), causing spoilage.

Stacks can be used if covered under plastic.

Bales stored on end (3) cannot shed water and will spoil rapidly.

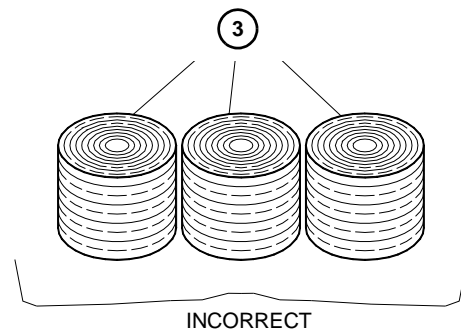
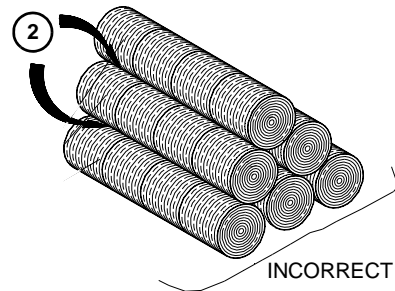

This page intentionally left blank.

Section 60: Maintenance

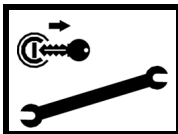

WARNING: Use Shutdown Procedure before servicing, cleaning, repairing, or transporting machine. Refer to [Shutdown procedure, page 23-1](#), for instructions.

Visually inspect machine daily before starting the machine.

Make no modifications to your equipment unless specifically recommended or requested by Vermeer Corporation.

Safety signs

Safety signs located on your machine contain important and useful information that will help you operate your equipment safely. Refer to the [parts manual](#) for locations.

To assure that all safety signs remain in place and in good condition, follow the below instructions:

- Keep safety signs clean. Use soap and water - not mineral spirits, abrasive cleaners, or other similar cleaners that will damage the sign.
- Replace any damaged or missing safety signs. When attaching signs, the temperature of the mounting surface must be at least 40°F (5°C). The mounting surface must also be clean and dry.
- When replacing a machine component with a safety sign attached, replace safety sign also.

Replacement safety signs can be purchased from your Vermeer dealer.

Welding alert - electronic components

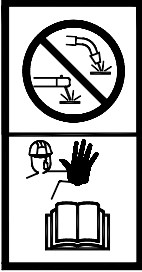

NOTICE: Welding will damage electronic components. Disconnecting battery ground will not prevent damage.

To prevent damage to electronic modules and controllers, unplug them before welding. Observe the following precautions:

- Follow [Shutdown procedure](#), page 23-1.
- Disconnect battery. Follow procedure below.
- Do not clamp welding ground to any electrical component.
- Clamp welding ground on the part being welded, or as close to it as possible. Do not allow weld current to pass through bearings or other moving components.
- Thoroughly clean the welding location and remove paint.
- Protect wiring and wiring harnesses from weld spatter.
- If welding an engine-mounted component, remove it before welding.
- Use proper welding procedures.

Battery disconnect procedure

Fault codes and undesirable machine operation may occur if the following procedure is not followed when disconnecting machine battery.

- Step 1:** Allow engine control module (ECM) enough time (up to 15 minutes) after machine shut down to properly power down.
- Step 2:** Verify that DEF system purge is complete.
- Step 3:** Disconnect negative battery cable then disconnect positive battery cable.
- Step 4:** Unplug all controllers.

Engine maintenance intervals

Refer to the Engine Operation and Maintenance Manual, supplied with each machine, for maintenance interval schedule and all maintenance instructions.

Read and understand the warnings and instructions in the Engine Operation and Maintenance Manual before performing any maintenance procedures.

Use fuel consumption, service hours, or calendar time, whichever occurs first, to determine maintenance intervals.

Greasing the machine

As a general rule, grease machine after it is shut down for the day. This protects the metal under the seals from corrosion caused by condensation as the temperature drops.

Verify all fittings and grease applicator nozzle are clean before applying grease. If any grease fittings are missing, replace them immediately.

Recommended fluids

Use specified lubricants. Refer to Engine Operation and Maintenance Manual, supplied with each machine, for details on lubricant specifications.

MAINTENANCE INTERVALS

Initial = Initial maintenance on new machine. Regular maintenance interval may be different.

- = Regular maintenance interval.

The maintenance intervals outlined in the following chart are based on normal operating conditions. When operating under severe conditions, maintenance intervals should be shortened.

Service	Maintenance interval - service hours				
	Every 10 hours	Every 50 hours	Every 100 hours	Every 250 hours	As required
Before each use - inspect safety signs and operating decals	●				
Before each use - inspect hydraulic system.	●				
Before each use - check for and remove misfed netwrap	●				
After each use - clean and inspect machine.	●				
After first 10 hours, then every 50 hours - torque wheel lug bolts to: Front wheels – 135 ft-lb (183 Nm) Rear wheels – 630 ft-lb +/- 50 ft-lb (854 Nm +/- 68 Nm)	INITIAL				
After each use - grease belt tightener pivots	●				
After each use - lubricate chains	●				
Check/Clean cabin air filters		●			
Tires and rims - check		●			
Torque wheel lug bolts to: Front wheels – 135 ft-lb (183 Nm) Rear wheels – 630 ft-lb +/- 50 ft-lb (854 Nm +/- 68 Nm)		●			
Wheel bearings - grease		●			
Belt lacing and pins - inspect		●			
Overall machine - check			●		
Backup alarm - check			●		

Service	Maintenance interval - service hours				
	Every 10 hours	Every 50 hours	Every 100 hours	Every 250 hours	As required
Neutral start interlock - check			●		
Hydraulic system - check			●		
Wheel bearings - check and repack if necessary				●	
Pickup teeth - replace					●
Chains - inspect/remove/install					●
Lights - replace					●
Tailgate latches - adjust					●
Netwrap knife - adjust					●

Maintenance - 10 Hours

Before each use

Safety signs and operating decals - inspect

safety signs - Check machine for any worn or missing safety signs and operating decals (refer to the [parts manual](#) safety sign information).

Inspect hydraulic system components



WARNING: Pressurized fluid can penetrate body tissue and result in death or serious injury. Leaks can be invisible. Keep away from any suspected leak. Relieve pressure in the hydraulic system before searching for leaks, disconnecting hoses, or performing any other work on the system. If you must pressurize the system to find a suspected leak, use an object such as a piece of wood or cardboard rather than your hands. When loosening a fitting where some residual pressure may exist, slowly loosen the fitting until oil begins to leak. Wait for leaking to stop before disconnecting the fitting. Fluid injected under the skin must be removed immediately by a surgeon familiar with this type of injury.

Inspect for leaks, wear, and damage. Repair components as needed.

Suspension accumulator pressure - relieve

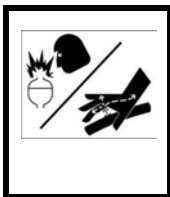

WARNING: Pressurized system. Failure to relieve accumulator pressure could lead to explosion or fluid injection. Relieve hydraulic pressure from suspension accumulator before attempting to do any work on the hydraulic system.

Follow procedure below to relieve suspension accumulator hydraulic pressure:

- Step 1:** Touch *Settings softkey (1)* on home screen.
- Step 2:** Touch *Advanced softkey (2)*, touch *Arrow softkey (5)*, then touch *Suspension softkey (3)*.
- Step 3:** Touch and hold *Release softkey (4)* for 1.5 seconds. This will release pressure from the suspension accumulator.
- Step 4:** Wait for 1 minute before shutting machine down.
- Step 5:** Follow [Shutdown procedure](#), page 23-1.

Suspension accumulator pressurizes when engine is started. Steps 1–5 must be repeated to release pressure if engine is started before work can be completed.

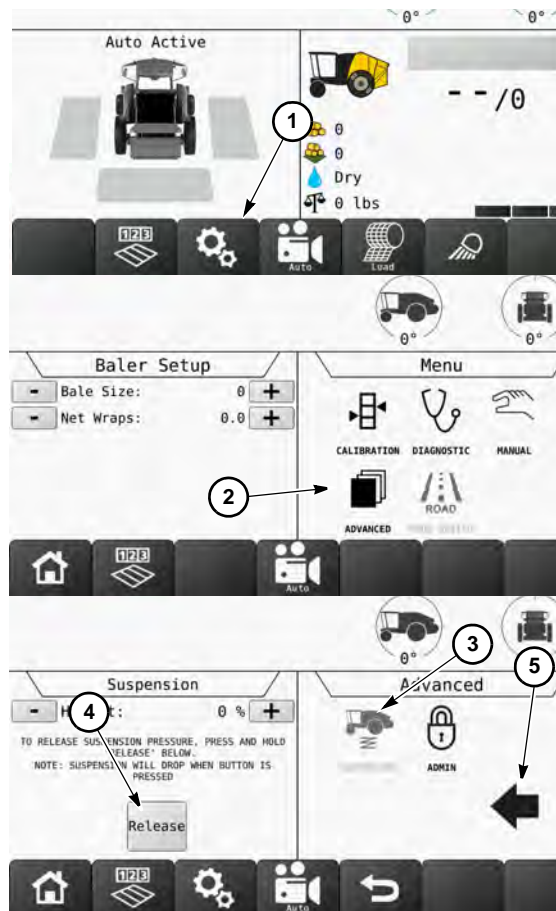

Misfed netwrap - check for and remove



WARNING: Opening tailgate can crush, resulting in death or serious injury.

Stay away from rear of baler. Warn others to stay away before opening tailgate.

Step 1: Relieve belt tension as follows:

- Fully open tailgate.
- Engage belt tightener arm lock.
- Close tailgate until belts are loose.
- Ensure bale ramp is fully lowered.
- Move tailgate lock valve to LOCKED position and follow [Shutdown procedure](#), page 23-1.

Step 2: Inspect all drive and idler rollers for wrapped netwrap.

Step 3: Use a suitable knife to cut netwrap away from rollers and bearings. Use caution not to cut into rubber coating on belt drive rollers.

Step 4: Inspect pickup reel for wrapped netwrap.

Step 5: Insert a suitable knife between stripper bands to cut netwrap away from pickup reel.

Step 6: If netwrap wraps around rollers or pickup reel again within 10 service hours or a day of operation, recalibrate bale size.

After each use

Clean and inspect machine

Remove accumulated trash and debris.

NOTICE: Do not use high pressure washers or steam cleaners to clean machine. Use compressed air.

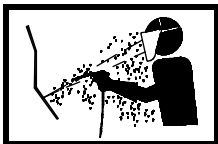

WARNING: Eye injury possible. Wear a face shield when using compressed air to clean machine.

Inspect safety signs and operating decals for wear and damage. (Refer to the [parts manual](#) and [operator's and maintenance manual](#) for safety sign information.)

Wheel lug nuts - torque

- Torque lug nuts **(1)** to:
 - Front Wheels – 135 ft-lb (183 Nm)
 - Rear Wheels – 630 ft-lb +/- 50 ft-lb (854 Nm +/- 68 Nm)
- Torque after first 10 hours of operation, then at 50-hour intervals.

Machine - grease

As a general rule, grease machine after it is shut down for the day. This protects metal under seals from corrosion caused by condensation as temperature drops.

Ensure all fittings and nozzle of grease applicator are clean before applying grease. If any grease fittings are missing, replace them immediately.

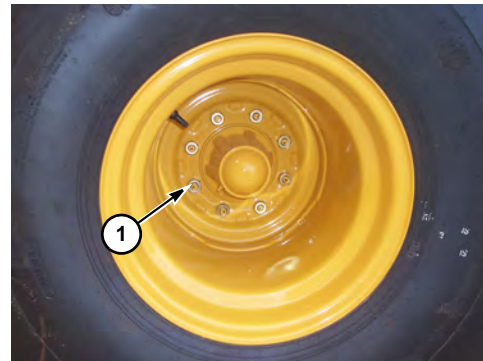

Maintenance - every 50 hours

Check/Clean cabin air filter

- Step 1:** Open cover (1) on cab roof.
- Cover is secured with a screw from the factory. This must be removed when opening for the first time, and is not required for normal use.
- Step 2:** Unlock and remove filters.
- Step 3:** Vacuum clean or knock off dirt on surface of filter.
- Step 4:** Replace any damaged filters.
- Step 5:** Insert filters.
- Step 6:** Close cover.

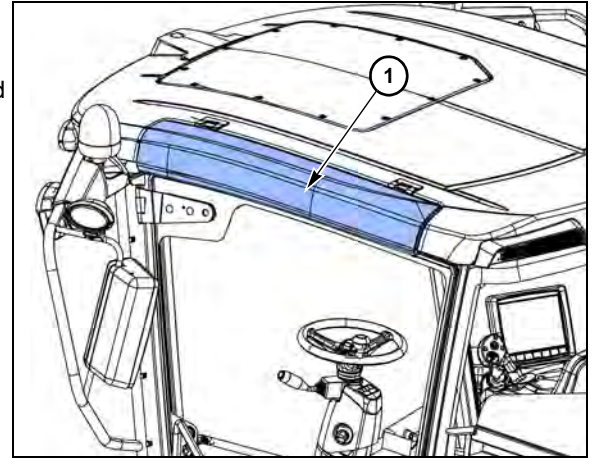

Tires and rims - check



WARNING: Tire explosion can result if the following procedures are not followed:

- Maintain correct tire pressure. Do not inflate tire above recommended pressure.
- Low tire pressure can cause internal tire damage. Inflate to recommended pressure.
- Replace any tires with cuts or bubbles. Replace any damaged rims.
- Do not weld or heat wheel assembly. Heating will increase tire pressure.

- Check tires and rims for damage.
- Check tires for correct pressure.
 - Front tires – 20 psi (140 kPa)
 - Rear tires – 29 psi (200 kPa)
- Check lug nuts; torque to (check after first 10 hours of operation, then at 50-hour intervals):
 - Front wheels – 135 ft-lb (183 Nm)
 - Rear wheels – 630 ft-lb +/- 50 ft-lb (854 Nm +/- 68 Nm)

Grease points

(1) Wheel bearings

three shots one fitting each wheel

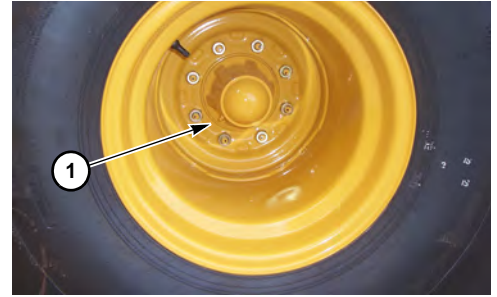

Belt lacing and pins - inspect

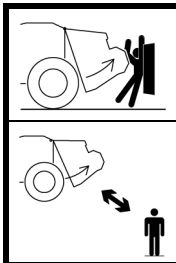

WARNING: Opening tailgate can crush, resulting in death or serious injury.

Stay away from rear of baler. Warn others to stay away before opening tailgate.

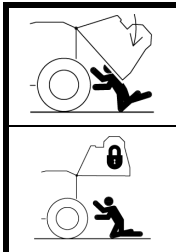

WARNING: A falling or closing tailgate can crush, resulting in death or serious injury.

Move tailgate lock valve to LOCKED position before working under tailgate.



WARNING: Falling from baler can result in serious injury.

Riders are not allowed on the baler.
Do not climb. If access is needed, use suitable height stepladder.

Inspect pin **(1)** every 500 to 1000 bales and replace as necessary. When operating baler in sandy and dirty conditions where potential for soil contamination is higher, pins should be checked more often.

Pins **(2)** and **(4)** are new. Pin **(3)** is severely worn. When pins develop this “segmented” appearance, they should be replaced immediately.

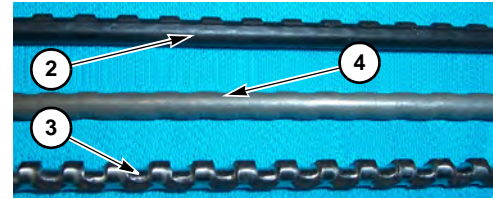

Maintenance - every 100 hours

Overall machine - check

Shields and guards - Check that all shields and guards are installed and are fastened securely to the machine. Replace or repair any shields or guards that are damaged or have missing parts.

Safety signs - Check machine for any worn or missing safety signs and operating decals. Refer to [parts manual](#) for replacement parts.

Hardware - Check machine for loose, worn, or missing parts and hardware. Tighten any loose parts and replace any worn or missing parts. Refer to [parts manual](#) for replacement parts..

Frame - Check frame and contact dealer immediately if you notice any bending or cracking.

Highway lights - Check that red marker/stop lights, amber flasher/turn lights, road lights and maintenance lights are operating properly.

Slip-resistant material - Check for worn or missing slip-resistant strips. Replace at once if damaged. Refer to [parts manual](#) for replacement parts.

Levers, switches, buttons - check

Check levers, lever switches and buttons, and console switches and buttons for freedom of movement. Refer to "Machine controls," [page 20-1](#).

Backup alarm - check

The backup alarm must operate correctly to alert personnel in the area when the machine is moving in reverse.

The backup alarm sounds when:

- the operator is seated and
- the machine is propelled in reverse

Neutral start interlock - check

Neutral start interlock system must work for safety.

Step 1: Clear area around machine.

Step 2: With engine off, move ground drive control out of neutral.

Step 3: Attempt to start engine. Machine must not start if ground drive control is out of neutral.

Contact your Vermeer dealer if machine does start when ground drive control is out of neutral.

Operator presence system - check

Operator presence system must work for safety.

Step 1: Clear area around machine.

Step 2: With engine off, and operator not in seat, attempt to start engine. Machine must not start.

Step 3: With engine off, and operator in seat, start engine. Follow [Starting procedure](#), page [22-1](#).

Step 4: Verify that ground drive moves to zero and most other machine functions stop (netwrap will not stop) when operator weight is removed from seat while function is engaged.

Step 5: Controls must be reset to neutral or off before resuming work.

Contact your Vermeer dealer if operator presence system does not function correctly.

Hydraulic system - check



WARNING: Pressurized fluid can penetrate body tissue and result in death or serious injury. Leaks can be invisible. Keep away from any suspected leak. Relieve pressure in the hydraulic system before searching for leaks, disconnecting hoses, or performing any other work on the system. If you must pressurize the system to find a suspected leak, use an object such as a piece of wood or cardboard rather than your hands. When loosening a fitting where some residual pressure may exist, slowly loosen the fitting until oil begins to leak. Wait for leaking to stop before disconnecting the fitting. Fluid injected under the skin must be removed immediately by a surgeon familiar with this type of injury.

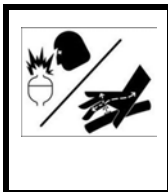

WARNING: Pressurized system. Failure to relieve accumulator pressure could lead to explosion or fluid injection. Relieve hydraulic pressure from suspension accumulator before attempting to do any work on the hydraulic system.

- Relieve hydraulic pressure from suspension accumulator. Refer to "Suspension accumulator pressure - relieve," [page 60-7](#).
- Check hydraulic lines and fittings for leaks or damage. Check for rubbing or pinching of lines which might damage the line. Repair or replace as necessary.
- Ensure all connections are tight and hoses are in good condition before applying hydraulic pressure to the system.
- Check for leaking hoses, kinked hoses, and for hoses that rub against each other or other parts of the machine. Replace all deteriorated or damaged hoses.
- When a hose with a protective sleeve is replaced, always install a new protective sleeve over the new hose.
- Check hydraulic cylinders for leaks and damage. Repair or replace as required.
- Check density system for correct pressure.

Maintenance - 250 hours

Wheel bearings - check

- Step 1:** Park machine on level ground.
- Step 2:** Chock both wheels on opposite side of wheel to be checked to prevent movement.
- Step 3:** Jack up machine until wheel is off the ground. Support machine with suitable blocking.
- Step 4:** Remove dust cap (12).
- Step 5:** Remove cotter pin (4) and castellated nut (11).
- Step 6:** Remove spindle washer (9), outer bearing (8), and inspect lubricant.
- If a generous amount of grease is on bearing and in housing, and if grease is soft, grease will not need changing.
 - If lubricant is caked and bearings seem dry, bearings should be repacked.

To repack bearings:

- Step 7:** Remove lug nuts (10).
- Step 8:** Remove tire and rim assembly (not shown).
- Step 9:** Remove hub (6). If hub is tight, use a wheel puller for removal.
- Step 10:** Remove seal (2) and inspect for damage. Replace if damaged.
- Step 11:** Remove inner bearing (3).
- Step 12:** Wash bearings (3) and (8), bearing races (5) and (7), and inside of hub (6) with solvent and wipe clean.

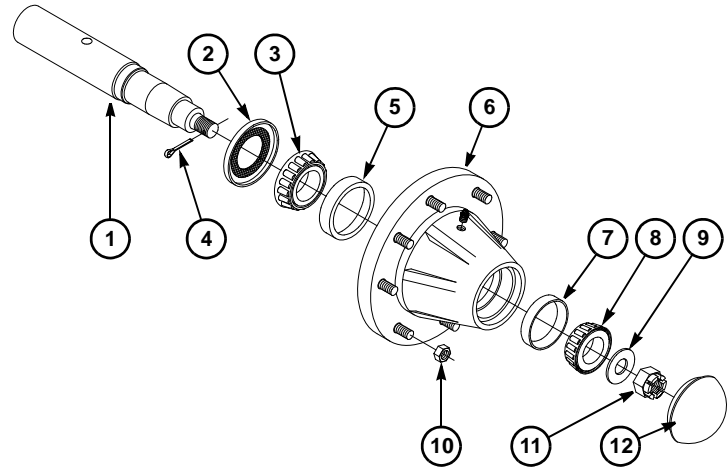

- Step 13: Inspect bearings **(3)** and **(8)** and races **(5)** and **(7)** for cracks, scratches, and wear; replace if damaged.
- Step 14: Pack bearings **(3)** and **(8)** with fresh grease. Pack grease between roller cage **(A)** and inner race **(B)** as shown until entire bearing is filled with grease.
- Step 15: Install inner bearing **(3)** in hub **(6)**.
- Step 16: Install seal **(2)** in hub **(6)**.
- Step 17: Install outer bearing **(8)** in hub **(6)**.
- Step 18: Slide hub **(6)** onto spindle **(1)**.
When sliding hub onto spindle, watch that outside bearing **(8)** does not work out of hub.
- Step 19: Install spindle washer **(9)** and castellated nut **(11)**.
- Step 20: While rotating hub **(6)**, torque nut **(11)** to 45 ft-lb (61 Nm). Hub must rotate while tightening nut to seat bearings properly.
- Step 21: Loosen nut **(11)** just enough to align nearest slot for cotter pin **(4)** installation.
- Step 22: Install and secure cotter pin **(4)**.
- Step 23: Use rubber mallet to install dust cap **(12)** into hub **(6)**.
- Step 24: Mount tire and rim assembly; Torque lug nuts **(10)** to 135 ft-lb (183 Nm). Re-torque after 10 and 50 hours of operation.
- Step 25: Remove blocks and lower jack. Repeat procedure for the other wheel.

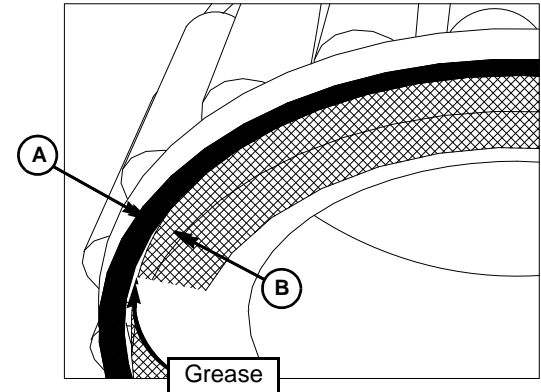
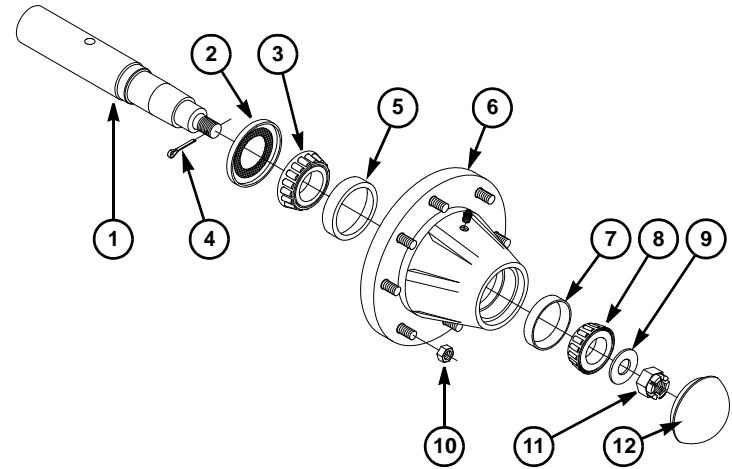

Maintenance - as required

Pickup teeth - replace

Pickup teeth **(3)** are mounted in pairs and have a stripper band **(1)** between them.

To replace:

- Step 1:** Fully lower pickup. Follow [Shutdown procedure](#), page [23-1](#).
- Step 2:** Remove bolts **(4)** and stripper band **(1)**.
There are two bolts **(4)** on both top and bottom of stripper band.
- Step 3:** Remove hardware **(2)** and double tooth **(3)**.
- Step 4:** Secure new double tooth using **new** grade 8 hardware. Do not reuse hardware **(2)**.
- Step 5:** Reinstall stripper band **(1)** using top bolts **(4)**. Leave bolts **(4)** loose.
- Step 6:** Install bottom bolts **(4)** and torque to 19 ft-lb (26 Nm), then torque top bolts **(4)** to 19 ft-lb (26 Nm).

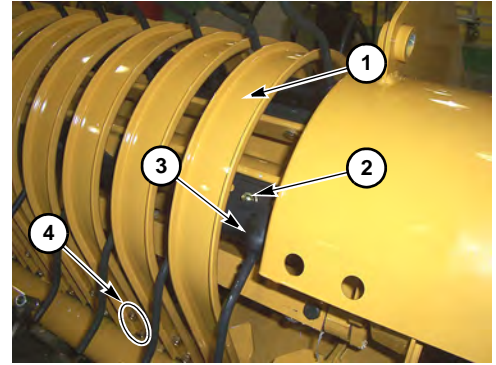

Chains - inspect/remove/install

Standard roller chain

To inspect and remove a standard chain:

Inspect for wear when adjusting tension. A chain is worn out when it is 3% longer than new or it no longer meshes properly with sprockets. Use the following procedure to measure chain wear:

- Step 1:** Loosen chain, remove cotter pins (4), retainer (3), and master link (2).
- Step 2:** Remove chain from baler and lay the chain on a flat surface.
- Step 3:** Push ends of the chain toward the middle to remove all the slack between the links. Measure distance (1) from the center of the link pin on one end to the center of the pin hole on the other end.
- Step 4:** Convert this length to a decimal value and multiply by 1.03.
- Step 5:** Pull on both ends of the chain to fully stretch the chain and measure stretched distance (5). If distance (5) is greater than 1.03 times distance (1), the chain is worn beyond its useful life. Replace it.
- Step 6:** Replace worn sprockets when replacing chain. Worn, deformed teeth will damage the new chain.

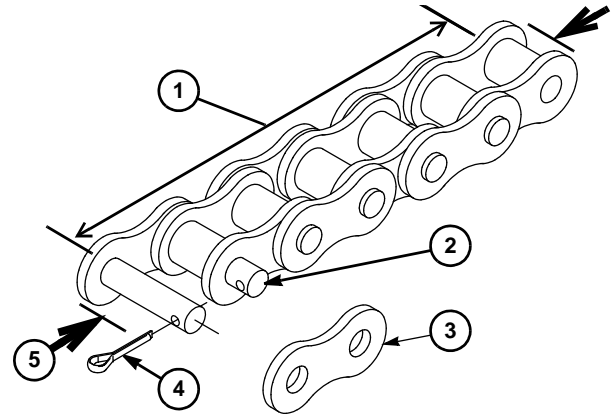

Remove and wash chains in solvent at the end of the season. Wipe clean, lubricate, and install on baler.

To install a chain:

- Step 1:** Thoroughly lubricate chain with light oil.
- Step 2:** Install chain onto sprockets in the same orientation from which it was removed.
- Step 3:** Pull ends of chain together and install new master link (2), retainer (3), and secure with cotter pins (4).

O-ring roller chain



CAUTION: If O-ring chain, which uses a special lubricant of polytetrafluoroethylene (PTFE) impregnated grease, is heated above 500°F (260°C) it may produce fumes which are irritating to the eyes and which may cause flu-like symptoms and/or nausea. Provide adequate ventilation if grinding pins to disassemble chain.



CAUTION: If handling O-ring chain lubricant, which contains polytetrafluoroethylene (PTFE) impregnated grease:

- Use oil resistant gloves.
- Do not smoke.
- Do not contaminate cigarettes or cigars with lubricant.

To inspect and remove a chain:

Inspect for wear when adjusting tension. A chain is worn out when it is 3% longer than new or it no longer meshes properly with sprockets. Use the following procedure to measure chain wear:

Step 1: Loosen chain, remove two cotter pins (4), coverside (3), two O-rings (6), and master link (2). Do not reuse connecting link components when installing chain.

Step 2: Remove chain from baler and lay the chain on a flat surface.

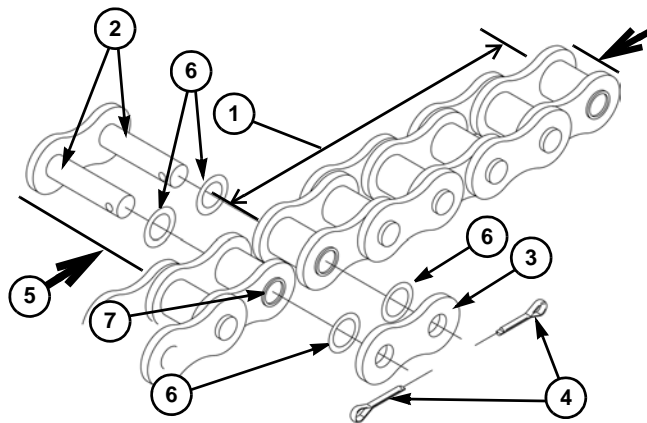

- Step 3:** Push ends of the chain toward the middle to remove all the slack between the links. Measure distance **(1)** from the center of the link pin on one end to the center of the pin hole on the other end.
 - Step 4:** Convert this length to a decimal value and multiply by 1.03.
 - Step 5:** Pull on both ends of the chain to fully stretch the chain and measure stretched distance **(5)**. If distance **(5)** is greater than 1.03 times distance **(1)**, the chain is worn beyond its useful life. Replace it.
 - Step 6:** Replace worn sprockets when replacing chain. Worn, deformed teeth will damage the new chain.
- Remove and wash chains in kerosene at the end of the season. Wipe clean, lubricate, and install on baler.

To install chain:

- Step 1:** Thoroughly lubricate chain with recommended chain lubricant.
- Step 2:** When reinstalling chain onto baler always use a new connecting link kit, which includes a specially formulated polytetrafluoroethylene (PTFE) impregnated grease lubricant.
- Step 3:** Follow instructions in connecting link kit to install connecting link pin **(2)**, O-rings **(6)**, coverside **(3)**, and cotter pins **(4)**.
- Step 4:** After chain is installed follow chain adjustment procedures for each separate chain. Refer to the following page.

Tailgate latches - adjust

There should be a 1/16–1/8" (1.5–3 mm) gap between latch plate **(1)** and tailgate latch.

To adjust:

- Step 1:** Open tailgate.
- Step 2:** Move tailgate lock valve to LOCKED position and follow [Shutdown procedure](#), page 23-1.
- Step 3:** On both sides of baler, loosen bolts **(2)** just enough to enable movement of latch plate **(1)**.
- Step 4:** Fully close and latch tailgate.
- Step 5:** On both sides of baler, move latch plate **(1)** forward until it bumps tailgate latch hook.
- Step 6:** Repeat Steps 1–2.
- Step 7:** On both sides of baler, move latch plate **(1)** rearward 1/16–1/8" (1.5–3 mm) and tighten bolts **(2)** to secure.

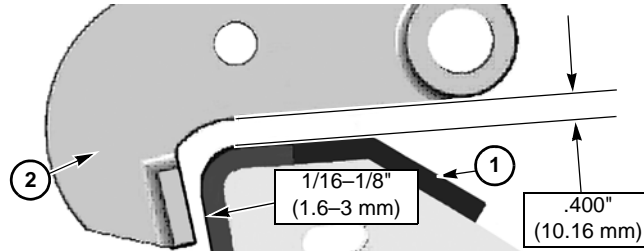
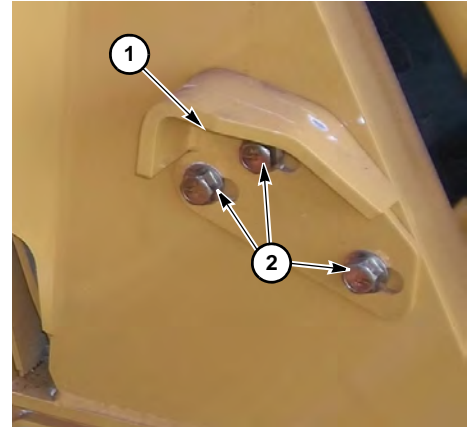

Netwrap knife - adjust

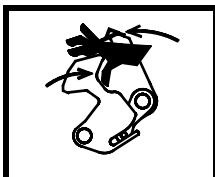

WARNING: Netwrap can move suddenly. Crushing injury possible.

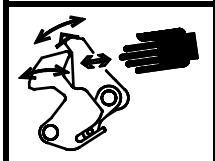

Keep hands away from moving parts.

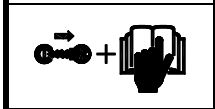

Shut off tractor. Read manual before servicing.

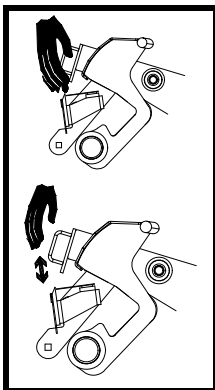

WARNING: Sharp knife can cut.

Keep hands away from knife. Wear heavy gloves when working around knife.

Wear heavy gloves when working around knife.

If netwrap system performance decreases or when replacing netwrap knife parts, use following procedure to adjust netwrap knife components:

- Step 1:** Move netwrap mechanism to "Net Load" position.
- Step 2:** Open tailgate approximately 25%.
- Step 3:** Follow *Shutdown procedure*, page 23-1.
- Step 4:** Remove bolts (2) from each side of baler and remove pan (1).
- Step 5:** Remove bolts (4) from each side of baler to remove netwrap knife assembly (3).

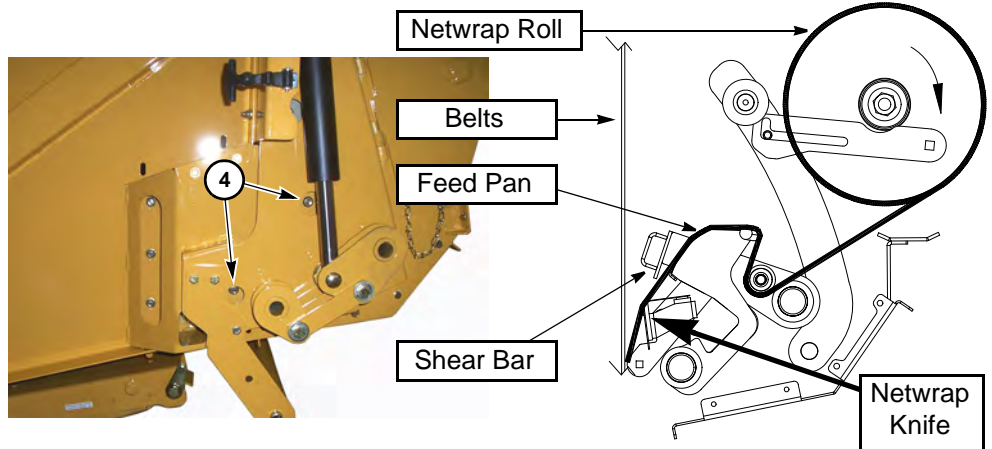
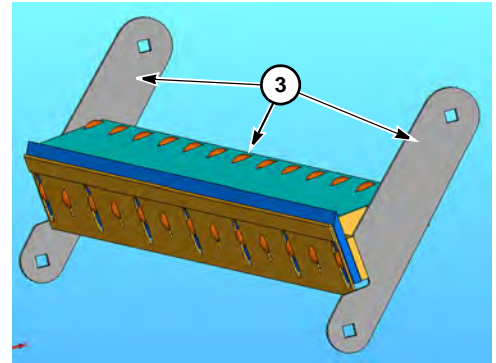
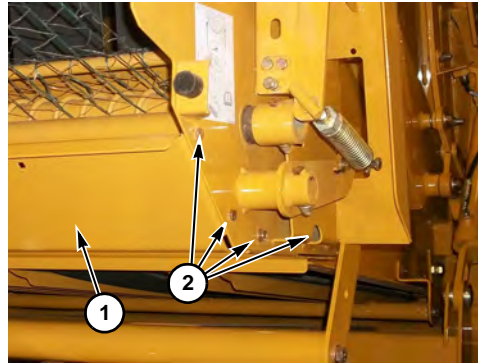

To assemble netwrap knife:

Step 6: Secure horizontal spring steel **(5)** to knife mount **(9)** using three 5/16 x 1" carriage bolts **(10)** and lock nuts (one bolt in middle and one bolt at each end of knife mount).

Ensure beveled edge of knife **(6)** faces front of machine as shown.

Step 7: Secure knife **(6)** to knife mount **(9)** using three 5/16 x 1" carriage bolts **(8)** and lock nuts (one bolt in middle and one bolt at each end of knife mount).

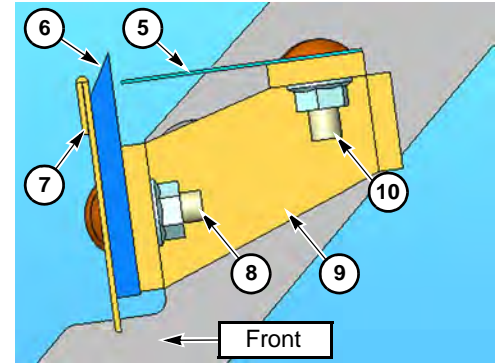

Refer to graphics on previous page when necessary.

- Step 8:** Ensure horizontal spring steel **(5)** is consistently 1/16" (2 mm) to rear of knife **(6)** from one end to the other. Install and tighten all bolts **(10)**.
- Step 9:** Ensure top of knife **(6)** is consistently 1/8" (3 mm) above top of horizontal spring steel **(5)** from one end to the other. Install and tighten bolts **(8)** at locations **(B)**.
- Step 10:** Secure knife guard **(7)** to knife mount **(9)** using three 5/16 x 1" carriage bolts and lock nuts **(8)** at outer and middle locations **(A)**.
- Step 11:** Ensure top of knife guard **(7)** is consistently 1/4" (6 mm) below top of knife **(6)** from one end to the other. Install and tighten all bolts **(8)** at locations **(A)**.
- Step 12:** Follow Steps 4–5 in reverse order to reinstall netwrap knife assembly in baler.
- Step 13:** Close tailgate and move netwrap mechanism back to home/cut position.

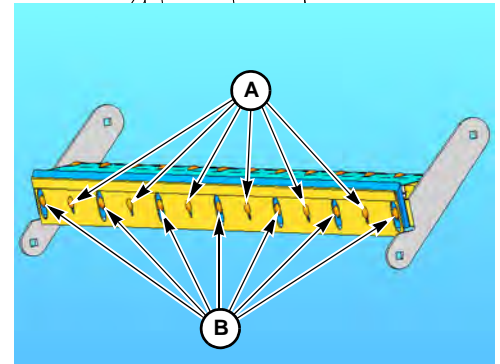
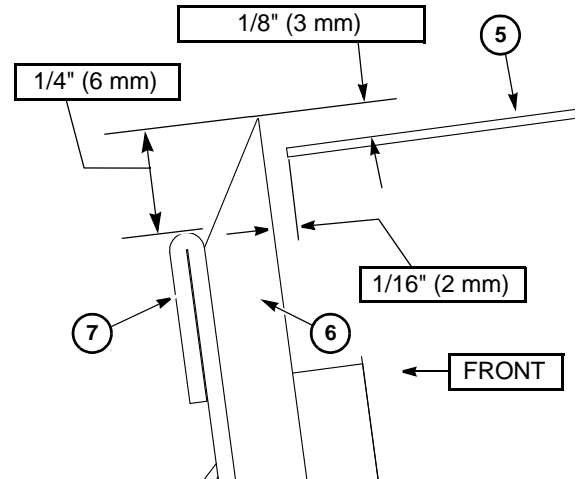

Tailgate camera - clean

Use an appropriate ladder to access tailgate camera **(1)** attached on top of right rear light mount. Clean lens cover of dirt and debris.

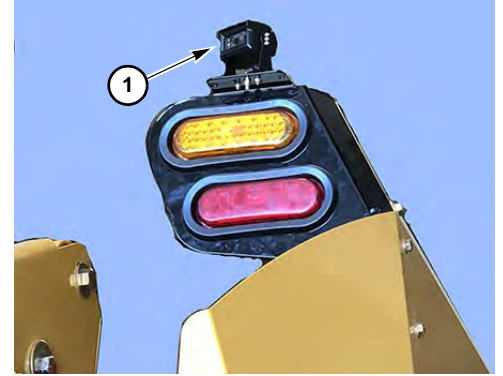

This page intentionally left blank.

Section 65: Specifications

Lubricants

Lubricant/Recommendation	Capacity	Specifications/Notes
Engine oil With filter: Without filter:	13.7 qt (13 L) 11.6 qt (11 L)	15W-40 that meets CES20081 and API CJ-4/SL specifications. Refer to the Engine Operation Manual, supplied with each machine, for service requirements.
Hydraulic fluid <i>Vermeer HyPower Hydraulic Fluid</i> ISO 68 oils are recommended and should be used for most applications. Use of any other hydraulic fluid without written factory approval will jeopardize warranty.	Tank: 25 gal (94.6 L) Total System: 42 gal (159 L) (approximate)	ISO 68 Oil (Vermeer HyPower 68): -4–104°F (-20–40°C) (Below +23°F or -5°C refer to “Cold weather starting,” page 22-4)
Grease <i>Vermeer Ultra LC Grease</i>	As required	EP grease: Vermeer Ultra LC or equivalent

Machine specifications

Engine	Stage V
Model number	Cummins B4.5L - Stage V
Power	200 hp (149 kW) at 2500 rpm
Peak torque	575 ft-lb (780 Nm) at 1500 rpm
Fuel type	Use diesel fuel with ultra low sulfur content to meet government emission requirements. Less than 15 ppm (15 mg/kg)
Fuel capacity	93 gal (356 L)
DEF type	32.5% high purity urea that meets: API Certification, DIN70700, ISO 22241-1, AUS - 32
DEF capacity	8.8 gal (33.3 L)
Oil capacity	13.7 qt (13 L) with filter; 11.6 qt (11 L) without filter Specifications: Refer to the Engine Manual supplied with each machine.
Maximum engine inclination	45° front down, 40° rear down, 45° hot side down, 45° cold side down NOTICE: Engine operating angles do not indicate safe machine operating angles.
Battery (1)	Group size: 8D (8D-MHD) 12-volt negative ground (12-volt system) 1400 cold cranking amps, 30 seconds, 0°F (-18°C) Reserve capacity: 450 min @ 25 amp output at 80°F (27°C)

Coolant medium	Use a 50/50 mixture of Extended Life (ELC) Nitrite-Free (NF) coolant and distilled or deionized water. Never add pure antifreeze to the system; always dilute to a 50/50 mixture. Never use Supplemental Cooling Additives (SCAs) with ELC coolant. Refer to the Engine Operation Manual for more detailed information.
Coolant capacity	Capacity: 7.5 gal (28.4 L)

General machine	
Weight	19,500 lb (8850 kg); power unit with bale chamber and pickup
Length	20.7 ft (6.3 m) with rubber tires
Width	142" (361 cm)
Height	124" (315 cm)
Tire pressure	Front: 21.5L-16 FRM HWY Service – 20 psi (140 kPa) Rear: 480/80R38 (18.4R38) – 29 psi (200 kPa)
Lug nut torque (tires)	Front: 135 ft-lb (183 Nm) Rear: 630 ft-lb +/- 50 ft-lb (854 Nm +/- 68 Nm)

Air conditioner - refrigerant and oil	Amount and specification
Refrigerant	4 lb (1.81 kg) total system charge; R134a
Oil	2 oz (59 ml) total new system volume; SP-15

NOTICE: Air conditioner service must be performed by a certified technician.

- Follow OEM instructions when replacing a compressor.
- Other system components may require replacement at the same time a compressor is replaced or the compressor warranty may be voided.

Index

A

Access panels and doors, 20-22
Accessory controls, 20-12
After each use, 60-9
Arriving at the field, 50-10
Auto lube - operational instructions, 44-1
Auto lube - setup procedure, 44-2

B

Backup alarm - check, 60-16
Bale carriers, 51-1
Bale chamber setup screen, 21-14
Bale chamber tailgate screen symbols, 21-11
Bale chamber, vii
Bale density, 50-14
Bale formation, 50-13
Bale shape and information boxes, 21-9
Bale shape, 50-15
Bale Size Screen Symbols, 21-7
Bale size, 50-14
Bale weight, 21-10
Baler controls, 20-9
Baling speed, 50-14
Baling, 50-17
Battery burns - avoid, 22-5
Battery disconnect procedure, 60-2
Battery explosion - avoid, 22-5
Before each use, 60-6

[ZR51200 Self-Propelled Baler](#)

Belt lacing and pins - inspect, 60-13

C

Cab access steps, 20-16
Cab door, 20-17
Chains - inspect/remove/install, 60-21
Check/Clean cabin air filter, 60-10
Cold weather starting, 22-4
Controls familiarity, 25-1
Conventional baling, 35-1
Correct bale storage, 51-2
Crop feed direction, 50-11
Crop preparation, 35-1

D

Dealer prep, i
Dealer/Owner information, vi
DEF (diesel exhaust fluid), 12-2
Delivery, iv
Diesel fuel sulfur content, 12-1
Diesel particulate filter (DPF) safety, 50-8
Diesel particulate filter controls, 20-11
Display unit, viii
DPF alert indicators, 50-9
Driving the machine, 30-3

E

Ejecting the Bale, 50-21

[Index](#)

Ejecting the bale, 50-22
Electronic control system - functions, 21-1
Electronic control system - protection and care, 21-2
Electronic control system, 21-1
Electronic control unit - predelivery checks, iii
Electronic control unit, viii
Emergency exit, 20-18
Engine and drivetrain, i
Engine controls, 20-2
Engine maintenance intervals, 60-3
Engine, vii
Extended idle periods, 22-3

F

Failed and misfed netwrap, 40-21
Fasten seat belts, 30-2
Fault screen symbols, 21-12
Fire - extinguish, 50-5
Fire extinguisher mounting location, 20-24
Fire prevention, 50-4
Flipped belt - reposition, 50-25
Front sunscreen, 20-19
Fuel and DEF fill locations, 20-22

G

General, ii
Grease points, 60-12
Greasing the machine, 60-3
Ground drive controls, 20-3

H

Hydraulic fluid fill, 20-22

Hydraulic system - check, 60-17
Hydraulics, ii

I

Identification numbers - record, vii
Incorrect bale storage, 51-3
Introduction, 1-2

J

Jump-starting (12-volt system), 22-5
Jump-starting procedure, 22-6
Levers, switches, buttons - check, 60-15
Loading, 30-7
Lubricants, 65-1

K

L

M

Machine - clean, 30-2
Machine - delivery review, iv
Machine specifications, 65-2
Maintenance - 10 Hours, 60-6
Maintenance - 250 hours, 60-18
Maintenance - as required, 60-20
Maintenance - every 100 hours, 60-15
Maintenance - every 50 hours, 60-10
Maintenance Intervals, 60-4
Manual control softkeys - netwrap, 40-13
Manual lube - setup procedure, 44-3

Misfed netwrap - check for and remove, 60-8
Moisture content, 35-1
Moisture display - calibrate, 45-3
Moisture offset - settings, 45-5
Monitor - home screen, 21-3
Monitor face and control functions, 21-3
Monitor functions and screen symbols, 21-4
Mount and dismount safely, 30-1

N

Navigation Softkeys, 21-5
Net loading operation, 40-24
Net not feeding alert, 50-31
Net storage location, 40-6
Netwrap - adjustments and maintenance, 40-30
Netwrap - Apply to Bale, 40-14
Netwrap - controller setup instructions, 40-7
Netwrap - delivery review, iv
Netwrap - loading and storage, 40-23
Netwrap - manual start, 40-20
Netwrap - normal operation, 40-16
Netwrap - operational instructions, 40-1
Netwrap - paused operation, 40-15
Netwrap - prestarting inspection, 25-6
Netwrap brake pad-to-wheel clearance - adjust, 40-32
Netwrap brake spring (tension) - initial adjustment, 40-36
Netwrap components - operating positions, 40-5
Netwrap components, 40-3
Netwrap feed sensing, 40-30
Netwrap knife - adjust, 60-25
Netwrap misfeed - check for and remove, 40-22

Netwrap shear bar clearance - adjust, 40-34
Netwrap system - automatic cycle start, 40-15
Netwrap system - function overview, 40-6
Netwrap system - optimize performance, 40-31
Netwrap system - setup procedure, 40-7
Neutral start interlock - check, 60-16

O

Operational messages, 50-31
Operational moisture sensing - instructions, 45-1
Operator presence system - check, 60-16
Operator presence system, 20-21
Operator presence system, 25-2
Operator Qualifications, 50-1
Operator's station, 50-11
Overall machine - check, 60-15

P

Pause softkey - netwrap cycle, 40-12
Personal protection, 50-2
Pickup teeth - replace, 60-20
Plugged pickup area, 50-24
Power unit, vii
Prepare baler, 50-12
Prepare the machine, 25-1
Preparing for Operation, 50-7
Prestarting inspection, 25-4
Programming and Configuration Functions, 21-13

Q

R

Receiving and delivery report, i
Receiving, i
Recommended fluids, 60-3
Review of operation, v

S

Safe operating practices, 50-2
Safety signs, 60-1
Safety symbol explanation, 10-1
Seat belt use, 25-3
Seat belts and seat controls, 20-20
Seat belts, 30-2
SMV sign - position, 25-6
Start softkey - manual netwrap cycle, 40-10
Starting the engine, 22-1
Stopping the engine, 23-1
Storing bales, 51-2

T

Table of Contents, ix
Tailgate camera - clean, 60-29
Tailgate latches - adjust, 60-24
Tailgate lock valve, 20-1
Tailgate open alert, 50-32
Tires and rims - check, 60-11
Towing/Retrieval, 30-8
Trademarks, 1-3
Trailer the machine, 30-6
Training, 25-1

U

Unloading and Loading Bale Chamber, 50-26
Unloading, 30-7
Unplugging the Baler, 50-23

V

VERMEER NEW AGRICULTURAL EQUIPMENT LIMITED
WARRANTY, 1-4
Vermeer TempSense operation, 21-16
Vermeer TempSense regulatory notice, 21-18

W

Warranty registration, v
Welding alert - electronic components, 60-2
Wheel bearings - check, 60-18
Windrow preparation, 35-2
Wrapping the bale - electronic controller, 50-19
Wrapping the bale sequence - netwrap, 50-20
Wrapping the bale, 50-19

X

Y

Z

Revision history

Revision	Date	Page	Description
o-m1_00	09/18	All	First Edition Operator's and Maintenance Manual released
o-m1_01	04/19	All	Update controller screenshots. Updated auto bale direction information.
o-m1_02	06/19	Section 20, 30	Corrected joystick controls decal and added park brake release procedure.
o-m1_03	01/21	Introduction, Section 20, 30	Updated warranty information and added maximum speed limiter rotary switch information.
o-m1_04	10/21	Section 50	Added bale chamber removal.
o-m1_05	12/21	Section 2, 25, 60, 65	Updated rear wheel lug torque specification.

When operated in California, any off-road diesel vehicle may be subject to the California Air Resources Board In-Use Off-Road Diesel Vehicle Regulation. It therefore could be subject to retrofit or accelerated turnover requirements to reduce emissions of air pollutants. For more information, please visit the California Air Resources Board website at <http://www.arb.ca.gov/msprog/ordiesel/ordiesel.htm>.

CALIFORNIA
Proposition 65 Warning

Diesel engine exhaust and some of its constituents are known to the State of California to cause cancer, birth defects, and other reproductive harm.

CALIFORNIA
Proposition 65 Warning

Battery posts, terminals, and related accessories contain lead and lead compounds, chemicals known to the State of California to cause cancer and reproductive harm. Wash hands after handling.