



# TEST REPORT

**Product Name** : QI2-15W 3-IN-1 MAGNETIC WIRELESS CHARGER  
**Brand Name** : LISEN, AINOPE, VEICO  
**Model** : 2E587  
**Series Model** : N/A  
**FCC ID** : 2AW73-2E587  
**Applicant** : **Shenzhen Xiangdangwen Technology Co.,Ltd.**  
**Address** : 106, 1/F, No.313-4 Building, Huachang Road, LangkoCommunity,  
Dalang Street, Longhua District,Shenzhen, China  
**Manufacturer** : **Huizhou Yimai Electronics Technology Co., Ltd.**  
**Address** : 3rd Floor, Building B, Huakai High-tech Industrial Park,Electronic  
City Road, Longxi Street, Boluo Country  
**Standard(s)** : FCC CFR Title 47 Part 15 Subpart C  
**Date of Receipt** : July 30, 2024  
**Date of Test** : July 30, 2024~ Aug.15, 2024  
**Issued Date** : Aug.15, 2024

**Issued By:** **Guangdong Asia Hongke Test Technology Limited**  
B1/F, Building 11, Junfeng Industrial Park, Chongqing Road, Heping Community, Fuhai Street,  
Bao'an District, Shenzhen, Guangdong, China  
Tel.: +86 0755-230967639 Fax.: +86 0755-230967639

**Reviewed by:** Leon Yi  
Leon.yi

**Approved by:** Sean She  
Sean She



Note: This device has been tested and found to comply with the standard(s) listed, this test report merely corresponds to the test sample. It is not permitted to copy extracts of these test result without the written permission of the test laboratory. This report shall not be reproduced except in full, without the written approval of Guangdong Asia Hongke Test Technology Limited. If there is a need to alter or revise this document, the right belongs to Guangdong Asia Hongke Test Technology Limited, and it should give a prior written notice of the revision document. This test report must not be used by the client to claim product endorsement.



**Report Revise Record**

<b>Report Version</b>	<b>Issued Date</b>	<b>Notes</b>
M1	Aug.15, 2024	Initial Release

# Contents

<b>1</b>	<b>TEST SUMMARY.....</b>	<b>4</b>
1.1	TEST STANDARDS.....	4
1.2	TEST SUMMARY .....	4
1.3	TEST FACILITY .....	5
1.4	MEASUREMENT UNCERTAINTY .....	5
<b>2</b>	<b>GENGENERAL INFORMATION .....</b>	<b>6</b>
2.1	ENVIRONMENTAL CONDITIONS .....	6
2.2	GENERAL DESCRIPTION OF EUT .....	6
2.3	DESCRIPTION OF THE TEST MODE .....	7
2.4	SPECIAL ACCESSORIES .....	7
2.5	EQUIPMENT LIST FOR THE TEST .....	7
<b>3</b>	<b>TEST CONDITIONS AND RESULTS .....</b>	<b>9</b>
3.1	CONDUCTED EMISSIONS TEST .....	9
3.2	RADIATED EMISSIONS.....	12
3.3	20dB BANDWIDTH.....	18
3.4	ANTENNA REQUIREMENT.....	20
<b>4</b>	<b>TEST SETUP PHOTOGRAPHS OF EUT .....</b>	<b>21</b>
<b>5</b>	<b>EXTERNAL PHOTOGRAPHS OF EUT .....</b>	<b>21</b>
<b>6</b>	<b>INTERNAL PHOTOGRAPHS OF EUT .....</b>	<b>21</b>

# 1 TEST SUMMARY

## 1.1 Test Standards

The tests were performed according to following standards:

[FCC Rules Part 15.207,15.209, 15.215\(c\)](#)

[ANSI C63.10: 2013](#): American National Standard for Testing Unlicensed Wireless Devices

## 1.2 Test Summary

Test Item	Section in CFR 47	Test Result
Electric Field Radiated Emissions	FCC Part 15 C (Section15.209)	PASS
20dB Bandwidth/99% Bandwidth	FCC Part 15 C (Section15.215(c))	PASS
AC Power Line Conducted Emission	FCC Part 15 C (Section15.207)	PASS
Antenna Requirement	FCC Part 15 C (Section15.203)	PASS

### 1.3 Test Facility

**Test Laboratory:**

**Guangdong Asia Hongke Test Technology Limited**

B1/F, Building 11, Junfeng Industrial Park, Chongqing Road, Heping Community, Fuhai Street, Bao'an District, Shenzhen, Guangdong, China

The test facility is recognized, certified or accredited by the following organizations:

**FCC-Registration No.: 251906 Designation Number: CN1376**

Guangdong Asia Hongke Test Technology Limited has been registered and fully described in a report filed with the (FCC) Federal Communications Commission. The acceptance letter from the FCC is maintained in our files.

**IC —Registration No.: 31737 CAB identifier: CN0165**

The 3m Semi-anechoic chamber of Guangdong Asia Hongke Test Technology Limited has been registered by Certification and Engineering Bureau of Industry Canada for radio equipment testing with Registration No.: 31737

**A2LA-Lab Cert. No.: 7133.01**

Guangdong Asia Hongke Test Technology Limited has been accredited by A2LA for technical competence in the field of electrical testing, and proved to be in compliance with ISO/IEC 17025: 2017 General Requirements for the Competence of Testing and Calibration Laboratories and any additional program requirements in the identified field of testing.

### 1.4 Measurement uncertainty

The data and results referenced in this document are true and accurate. The reader is cautioned that there may be errors within the calibration limits of the equipment and facilities. The measurement uncertainty was calculated for all measurements listed in this test report according to CISPR 16 - 4 “Specification for radio disturbance and immunity measuring apparatus and methods – Part 4: Uncertainty in EMC Measurements” and is documented in the Guangdong Asia Hongke Test Technology Limited’s quality system according to DIN EN ISO/IEC 17025. Furthermore, component and process variability of devices similar to that tested may result in additional deviation. The manufacturer has the sole responsibility of continued compliance of the device.

Hereafter the best measurement capability for Asia Hongke laboratory is reported:

Test	Measurement Uncertainty	Notes
Power Line Conducted Emission	150KHz~30MHz ±1.20 dB	(1)
Radiated Emission	9KHz~30Hz ±3.10dB	(1)
Radiated Emission	9KHz~1GHz ±3.75dB	(1)
Radiated Emission	1GHz~18GHz ±3.88 dB	(1)
Radiated Emission	18GHz~40GHz ±3.88dB	(1)
RF power, conducted	30MHz~6GHz ±0.16dB	(1)
RF power density, conducted	±0.24dB	(1)
Spurious emissions, conducted	±0.21dB	(1)
Temperature	±1℃	(1)
Humidity	±3%	(1)
DC and low frequency voltages	±1.5%	(1)
Time	±2%	(1)
Duty cycle	±2%	(1)

The report uncertainty of measurement  $y \pm U$ , where expanded uncertainty U is based on a standard uncertainty Multiplied by a coverage factor of  $k=2$ , providing a level of confidence of approximately 95%

## 2 GENGGENERAL INFORMATION

### 2.1 Environmental conditions

During the measurement the environmental conditions were within the listed ranges:

Normal Temperature:	25°C
Relative Humidity:	55 %
Air Pressure:	101 kPa

### 2.2 General Description of EUT

Product Name:	QI2-15W 3-IN-1 MAGNETIC WIRELESS CHARGER
Model/Type reference:	2E587
Power Supply:	INPUT: 5V=3A 9V=3A 12V=3A Phone Output: 5W/7.5W/10W/15W(QI2) Earbuds output: 5W iwatch output: 5W
Hardware version:	N/A
Software version:	N/A
Sample(s) Status:	AiTSZ-240730003-01(Normal sample) AiTSZ-240730003-02(Engineer sample)
<b>Wireless Charger:</b>	
Operation frequency:	Coil1: For Phone: 113kHz-205kHz Coil2: For Earphone: 113kHz-205kHz Coil3: Watch: 300kHz-350kHz
Modulation Technology:	ASK
Antenna Type:	Loop coil Antenna
Antenna gain:	0dBi
<b>Remark:</b> The above DUT's information was declared by manufacturer. For more detailed features description, please refer to the manufacturer's specifications or the User's Manual.	

### 2.3 Description of the test mode

Equipment under test was operated during the measurement under the following conditions:

Charging and communication mode

Test Modes:		
Mode 1	AC/DC Adapter+ EUT + Earphone + Watch + phone(Battery Status:< 1%)	Record
Mode 2	AC/DC Adapter+ EUT + Earphone + Watch + phone(Battery Status:< 50%)	Pre-tested
Mode 3	AC/DC Adapter+ EUT + Earphone + Watch + phone(Battery Status:< 99%)	Pre-tested
Mode 4	Stand-by mode.	Pre-tested

Note: All test modes were pre-tested, but we only recorded the worst case in this report.

### 2.4 Special Accessories

Follow auxiliary equipment(s) test with EUT that provided by the manufacturer or laboratory is listed as follow:

Description	Manufacturer	Model	Serial No.	Provided by	Other
Adapter	HNT	HNT-QC530	/	Test lab	/
Phone	YBZ	15W	/	Test lab	/
Watch	Apple	S6	/	Test lab	/
Earphone	PocBuds	K6	/	Test lab	/

### 2.5 Equipment List for the Test

No	Test Equipment	Manufacturer	Model No	Serial No	Cal. Date	Cal. Due Date
1	Spectrum Analyzer	R&S	FSV40	101470	2023.09.08	2024.09.07
2	Spectrum Analyzer	Keysight	N9020A	MY51280643	2023.09.08	2024.09.07
3	EMI Measuring Receiver	R&S	ESR	101660	2023.09.08	2024.09.07
4	Low Noise Pre-Amplifier	HP	HP8447E	1937A01855	2023.09.08	2024.09.07
5	Low Noise Pre-Amplifier	Tsj	MLA-0120-A02-34	2648A04738	2023.09.08	2024.09.07
6	Passive Loop	ETS	6512	00165355	2022.09.04	2024.09.03
7	TRILOG Super Broadband test Antenna	SCHWARZBECK	VULB9160	9160-3206	2021.08.29	2024.08.28
8	Broadband Horn Antenna	SCHWARZBECK	BBHA9120D	452	2021.08.29	2024.08.28
9	SHF-EHF Horn Antenna 15-40GHz	SCHWARZBECK	BBHA9170	BBHA9170367d	2021.08.29	2024.08.28
10	EMI Measuring Receiver	R&S	ESR	101160	2023.09.13	2024.09.12
11	LISN	SCHWARZBECK	NNLK 8129	8130179	2023.10.29	2024.10.28
12	Pulse Limiter	R&S	ESH3-Z2	102789	2023.09.13	2024.09.12
13	Pro.Temp&Humi.chamber	MENTEK	MHP-150-1C	MAA08112501	2023.09.08	2024.09.07
14	RF Automatic Test system	MW	MW100-RFCB	21033016	2023.09.08	2024.09.07

15	Signal Generator	Agilent	N5182A	MY50143009	2023.09.08	2024.09.07
16	Wideband Radio communication tester	R&S	CMW500	1201.0002K50	2023.09.08	2024.09.07
17	RF Automatic Test system	MW	MW100-RFCB	21033016	2023.09.08	2024.09.07
18	DC power supply	ZHAOXIN	RXN-305D-2	28070002559	N/A	N/A
19	RE Software	EZ	EZ-EMC_RE	Ver.AIT-03A	N/A	N/A
20	CE Software	EZ	EZ-EMC_CE	Ver.AIT-03A	N/A	N/A
21	RF Software	MW	MTS 8310	2.0.0.0	N/A	N/A
22	temporary antenna connector(Note)	NTS	R001	N/A	N/A	N/A

Note: The temporary antenna connector is soldered on the PCB board in order to perform conducted tests and this temporary antenna connector is listed in the equipment list.



### 3 TEST CONDITIONS AND RESULTS

#### 3.1 Conducted Emissions Test

##### LIMIT

Frequency range (MHz)	Limit (dBuV)	
	Quasi-peak	Average
0.15-0.5	66 to 56*	56 to 46*
0.5-5	56	46
5-30	60	50

\* Decreases with the logarithm of the frequency.

##### TEST CONFIGURATION

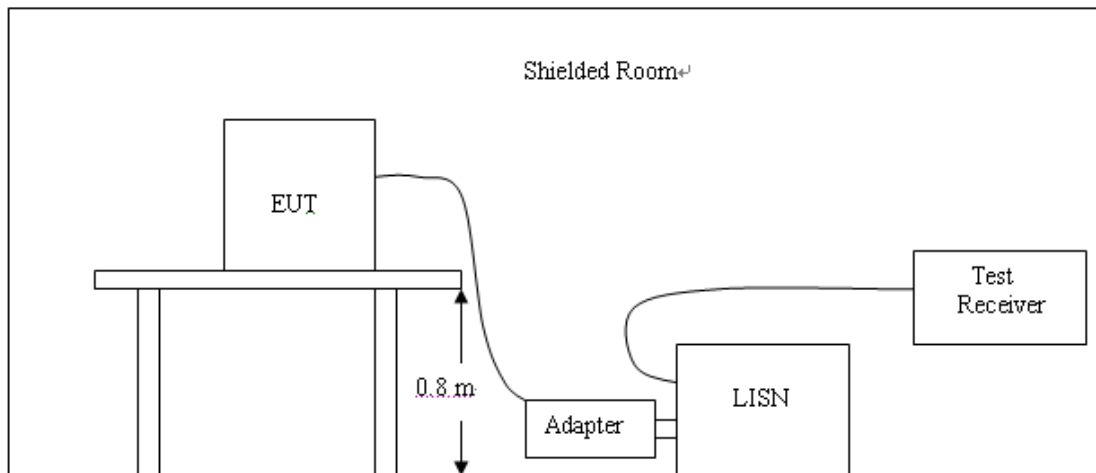

##### TEST PROCEDURE

1. The equipment was set up as per the test configuration to simulate typical actual usage per the user's manual. The EUT is a tabletop system; a wooden table with a height of 0.8 meters is used and is placed on the ground plane as per ANSI C63.10:2013.
2. Support equipment, if needed, was placed as per ANSI C63.10:2013.
3. All I/O cables were positioned to simulate typical actual usage as per ANSI C63.10:2013.
4. The adapter received AC120V/60Hz power through a Line Impedance Stabilization Network (LISN) which supplied power source and was grounded to the ground plane.
5. All support equipments received AC power from a second LISN, if any.
6. The EUT test program was started. Emissions were measured on each current carrying line of the EUT using a spectrum Analyzer / Receiver connected to the LISN powering the EUT. The LISN has two monitoring points: Line 1 (Hot Side) and Line 2 (Neutral Side). Two scans were taken: one with Line 1 connected to Analyzer / Receiver and Line 2 connected to a 50 ohm load; the second scan had Line 1 connected to a 50 ohm load and Line 2 connected to the Analyzer / Receiver.
7. Analyzer / Receiver scanned from 150 KHz to 30MHz for emissions in each of the test modes.
8. During the above scans, the emissions were maximized by cable manipulation.

**TEST RESULTS**

Remark: Both 120 VAC, 50/60 Hz and 240 VAC, 50/60 Hz power supply have been tested, only the worst result of 120 VAC, 60 Hz was reported as below:

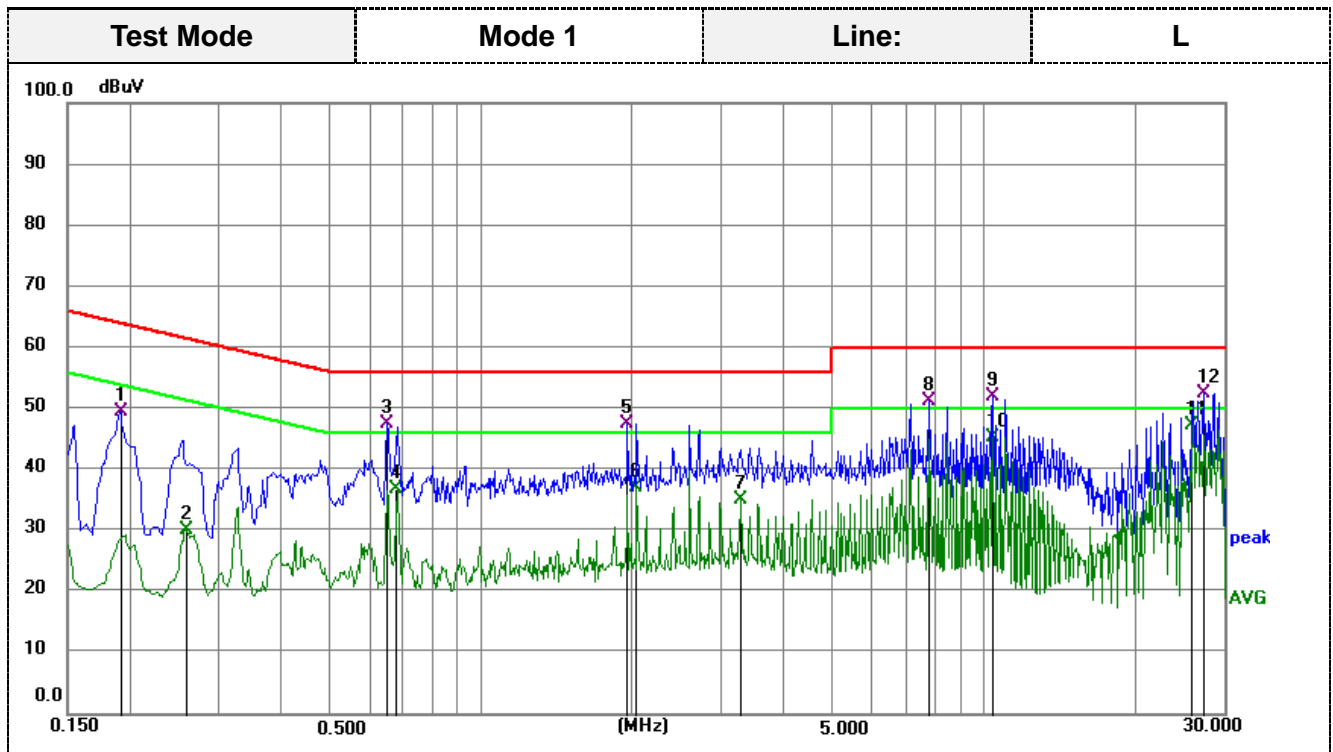

Remark: Correct Factor = Insertion loss of LISN + Cable loss + Insertion loss of Pulse Limiter;  
 Measurement Result = Reading Level + Correct Factor;  
 Margin = Measurement Result - Limit

No.	Frequency (MHz)	Reading (dBuV)	Correct (dB)	Result (dBuV)	Limit (dBuV)	Margin (dB)	Remark
1	0.1905	38.84	10.69	49.53	64.01	-14.48	QP
2	0.2580	19.57	10.70	30.27	51.50	-21.23	AVG
3	0.6495	36.85	10.68	47.53	56.00	-8.47	QP
4	0.6809	26.08	10.68	36.76	46.00	-9.24	AVG
5	1.9500	36.78	10.77	47.55	56.00	-8.45	QP
6	2.0400	26.31	10.78	37.09	46.00	-8.91	AVG
7	3.2820	24.32	10.87	35.19	46.00	-10.81	AVG
8	7.8045	40.13	11.06	51.19	60.00	-8.81	QP
9	10.4010	40.83	11.08	51.91	60.00	-8.09	QP
10	10.4010	34.32	11.08	45.40	50.00	-4.60	AVG
11	26.0069	35.47	11.79	47.26	50.00	-2.74	AVG
12	27.3075	40.70	11.68	52.38	60.00	-7.62	QP

Test Mode	Mode 1	Line:	N
-----------	--------	-------	---

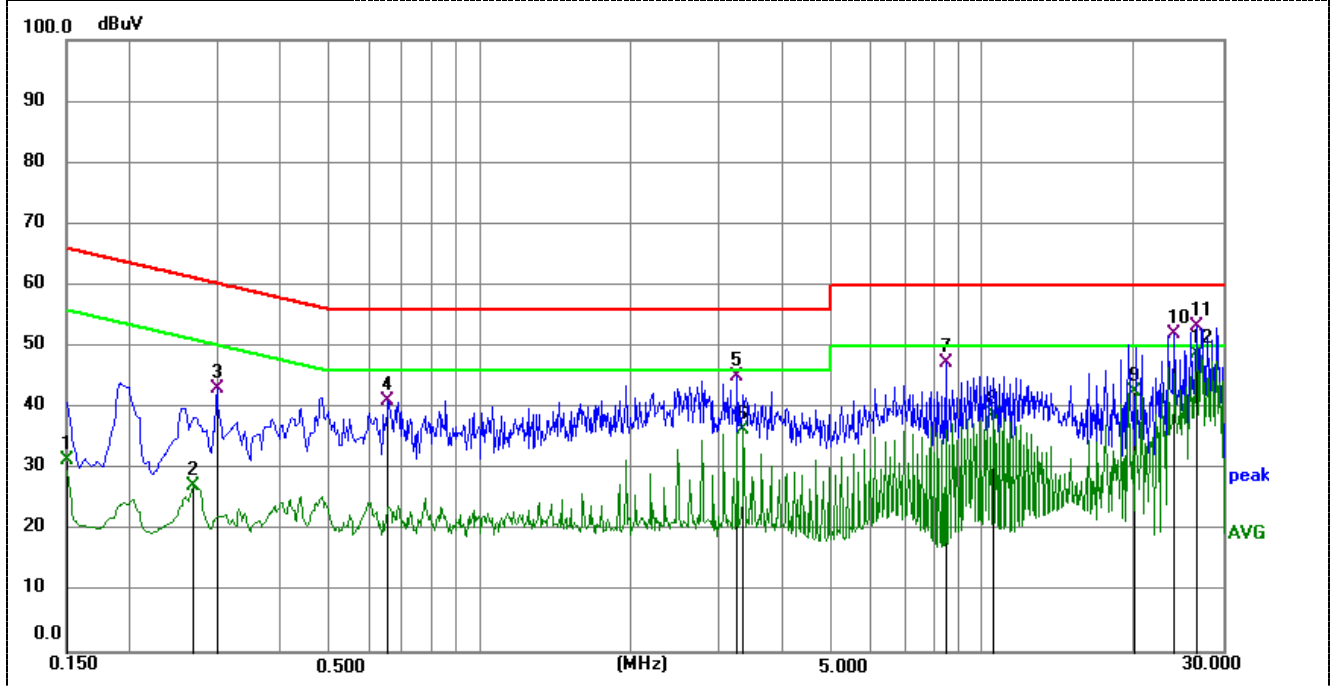

Remark: Correct Factor = Insertion loss of LISN + Cable loss + Insertion loss of Pulse Limiter;  
 Measurement Result = Reading Level + Correct Factor;

Margin = Measurement Result- Limit

No.	Frequency (MHz)	Reading (dBuV)	Correct (dB)	Result (dBuV)	Limit (dBuV)	Margin (dB)	Remark
1	0.1500	19.52	11.84	31.36	56.00	-24.64	AVG
2	0.2670	16.36	10.69	27.05	51.21	-24.16	AVG
3	0.2985	32.40	10.69	43.09	60.28	-17.19	QP
4	0.6540	30.48	10.67	41.15	56.00	-14.85	QP
5	3.2505	34.18	10.83	45.01	56.00	-10.99	QP
6	3.3450	25.48	10.91	36.39	46.00	-9.61	AVG
7	8.4345	36.13	11.04	47.17	60.00	-12.83	QP
8	10.4730	27.78	11.06	38.84	50.00	-11.16	AVG
9	20.1299	30.83	11.67	42.50	50.00	-7.50	AVG
10	24.0224	40.40	11.69	52.09	60.00	-7.91	QP
11	26.6235	41.66	11.66	53.32	60.00	-6.68	QP
12	26.6235	37.19	11.66	48.85	50.00	-1.15	AVG

### 3.2 Radiated Emissions

#### Limit

For intentional device, according to § 15.209(a), the general requirement of field strength of radiated emission out of authorized band shall not exceed the following table at a 3 meters measurement distance.

In addition, radiated emissions which fall in the restricted bands, as defined in §15.205(a), must also comply with the radiated emission limits specified in §15.209(a)

Radiated emission limits

Frequency (MHz)	Distance (Meters)	Radiated (dBµV/m)	Radiated (µV/m)
0.009-0.49	3	$20\log(2400/F(\text{KHz}))+40\log(300/3)$	$2400/F(\text{KHz})$
0.49-1.705	3	$20\log(24000/F(\text{KHz}))+40\log(30/3)$	$24000/F(\text{KHz})$
1.705-30	3	$20\log(30)+40\log(30/3)$	30
30-88	3	40.0	100
88-216	3	43.5	150
216-960	3	46.0	200
Above 960	3	54.0	500

#### TEST CONFIGURATION

(A) Radiated Emission Test Set-Up, Frequency Below 30MHz

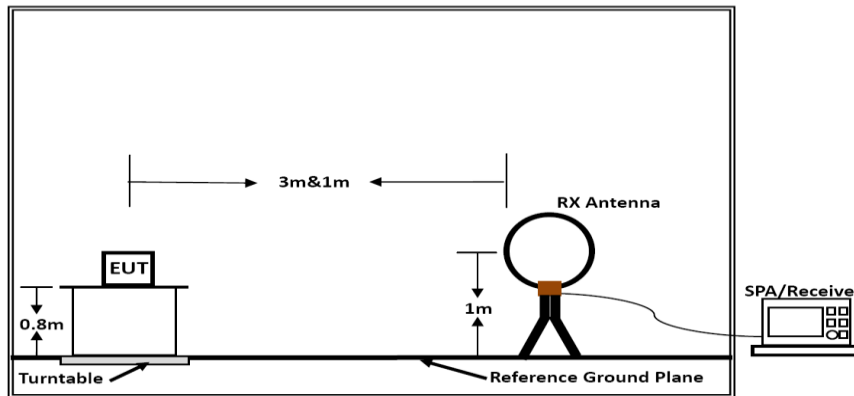

Below 30MHz

(B) Radiated Emission Test Set-Up, Frequency below 1000MHz

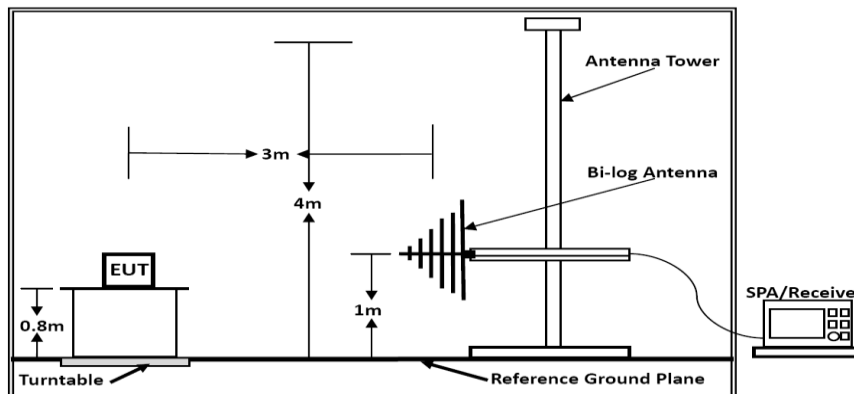

Below 1GHz

(C) Radiated Emission Test Set-Up, Frequency above 1000MHz

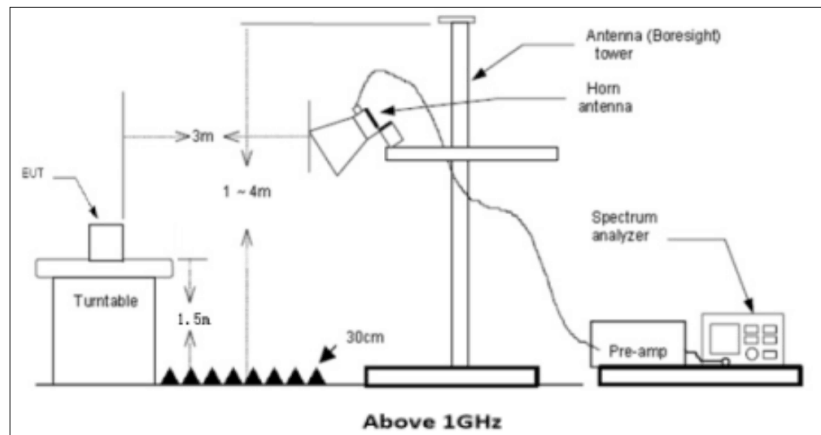

**Test Procedure**

1. Below 1GHz measurement the EUT is placed on a turntable which is 0.8m above ground plane, and above 1GHz measurement EUT was placed on a low permittivity and low loss tangent turn table which is 1.5m above ground plane.
2. Maximum procedure was performed by raising the receiving antenna from 1m to 4m and rotating the turn table from 0°C to 360°C to acquire the highest emissions from EUT
3. And also, each emission was to be maximized by changing the polarization of receiving antenna both horizontal and vertical.
4. Repeat above procedures until all frequency measurements have been completed.
5. Radiated emission test frequency band from 9KHz to 1000MHz.
6. The distance between test antenna and EUT as following table states:

Test Frequency range	Test Antenna Type	Test Distance
9KHz-30MHz	Active Loop Antenna	3
30MHz-1GHz	Bilog Antenna	3

7. Setting test receiver/spectrum as following table states:

Test Frequency range	Test Receiver/Spectrum Setting	Detector
9KHz-150KHz	RBW=200Hz/VBW=3KHz, Sweep time=Auto	QP
150KHz-30MHz	RBW=9KHz/VBW=100KHz, Sweep time=Auto	QP
30MHz-1GHz	RBW=120KHz/VBW=1000KHz, Sweep time=Auto	QP

**TEST RESULTS**

Remark:

All test modes described in section 2.3 has been tested, only the worst result of Mode 1 is recorded as below:

**For 9KHz-150KHz**

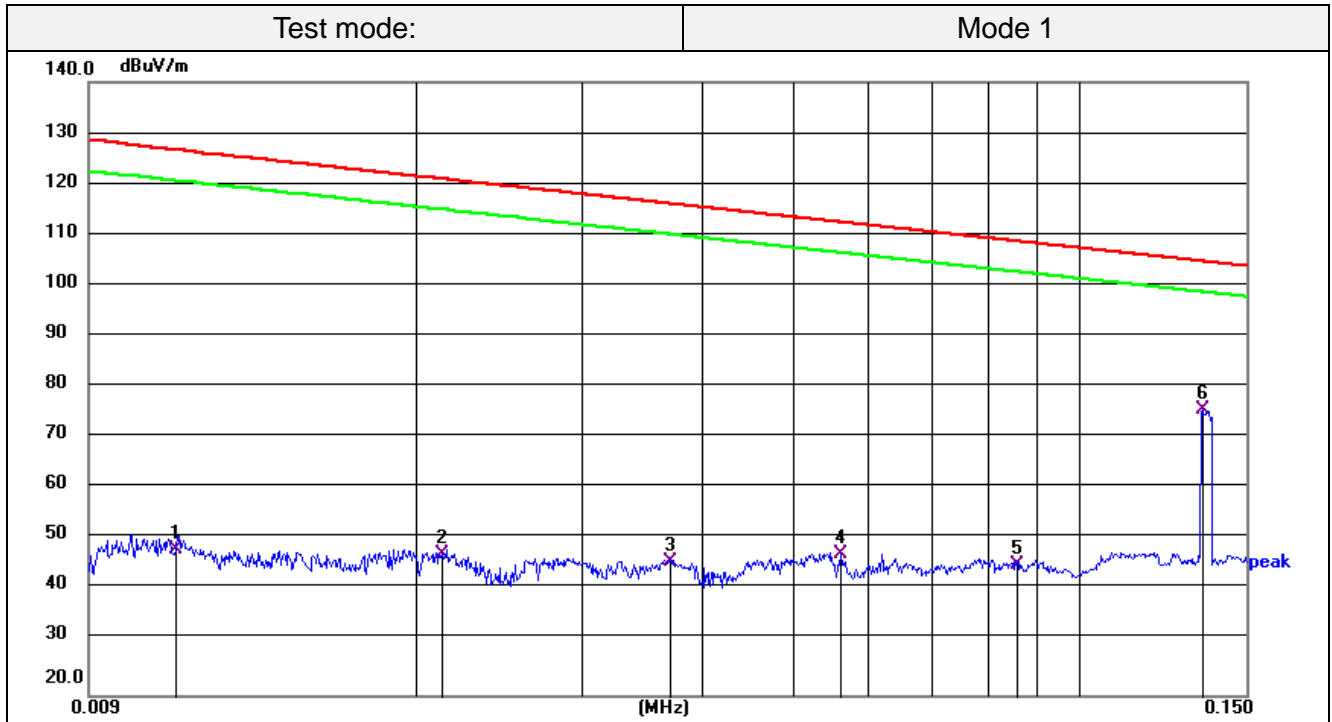

Remark:  
 Emission Level = Reading + Factor;  
 Factor = Antenna Factor + Cable Loss;  
 Margin= Emission Level - Limit.

No.	Frequency (MHz)	Reading (dBuV)	Factor (dB/m)	Level (dBuV/m)	Limit (dBuV/m)	Margin (dB)	Det.
1	0.0111	27.25	21.36	48.61	126.70	-78.09	QP
2	0.0212	26.89	20.87	47.76	121.08	-73.32	QP
3	0.0370	24.49	21.82	46.31	116.24	-69.93	QP
4	0.0560	25.24	22.62	47.86	112.64	-64.78	QP
5	0.0860	23.11	22.61	45.72	108.91	-63.19	QP
6 *	0.1345	54.01	22.05	76.06	105.03	-28.97	QP

**For 150KHz-30MHz**

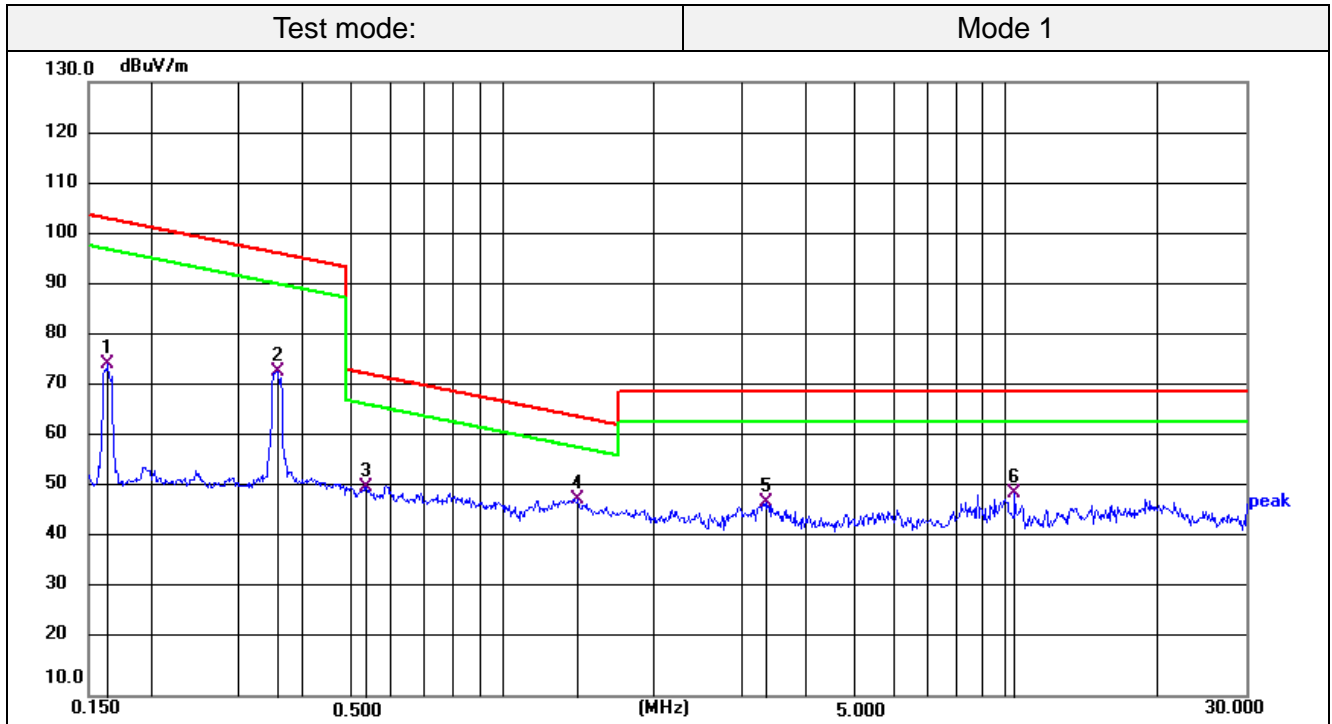

Remark:  
 Emission Level = Reading + Factor;  
 Factor = Antenna Factor + Cable Loss;  
 Margin= Emission Level - Limit.

No.	Frequency (MHz)	Reading (dBuV)	Factor (dB/m)	Level (dBuV/m)	Limit (dBuV/m)	Margin (dB)	Det.
1	0.1640	52.99	21.83	74.82	103.31	-28.49	QP
2	0.3557	51.87	21.57	73.44	96.58	-23.14	QP
3	0.5350	29.00	21.90	50.90	73.04	-22.14	QP
4 *	1.4106	26.02	22.52	48.54	64.62	-16.08	QP
5	3.3456	25.17	22.70	47.87	69.54	-21.67	QP
6	10.3971	26.96	22.68	49.64	69.54	-19.90	QP

**For 30MHz-1GHz**

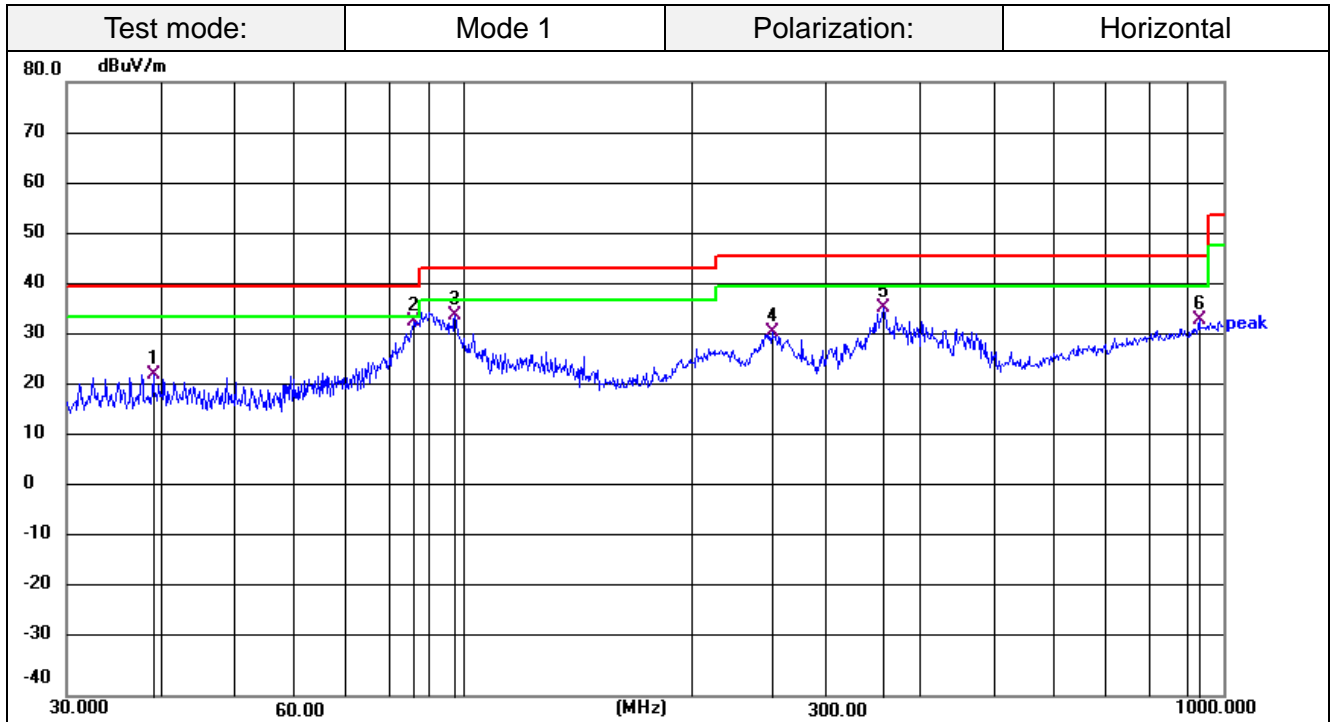

Remark:  
 Emission Level = Reading + Factor;  
 Factor = Antenna Factor + Cable Loss – Pre-amplifier;  
 Margin= Emission Level - Limit.

No.	Frequency (MHz)	Reading (dBuV)	Factor (dB/m)	Level (dBuV/m)	Limit (dBuV/m)	Margin (dB)	Det.
1	39.0245	39.41	-16.60	22.81	40.00	-17.19	QP
2 *	85.8984	54.09	-20.96	33.13	40.00	-6.87	QP
3	97.4560	54.79	-20.49	34.30	43.50	-9.20	QP
4	254.7284	49.42	-18.40	31.02	46.00	-14.98	QP
5	356.6758	51.37	-15.59	35.78	46.00	-10.22	QP
6	929.0082	37.68	-4.06	33.62	46.00	-12.38	QP



Test mode:	Mode 1	Polarization:	Vertical
------------	--------	---------------	----------

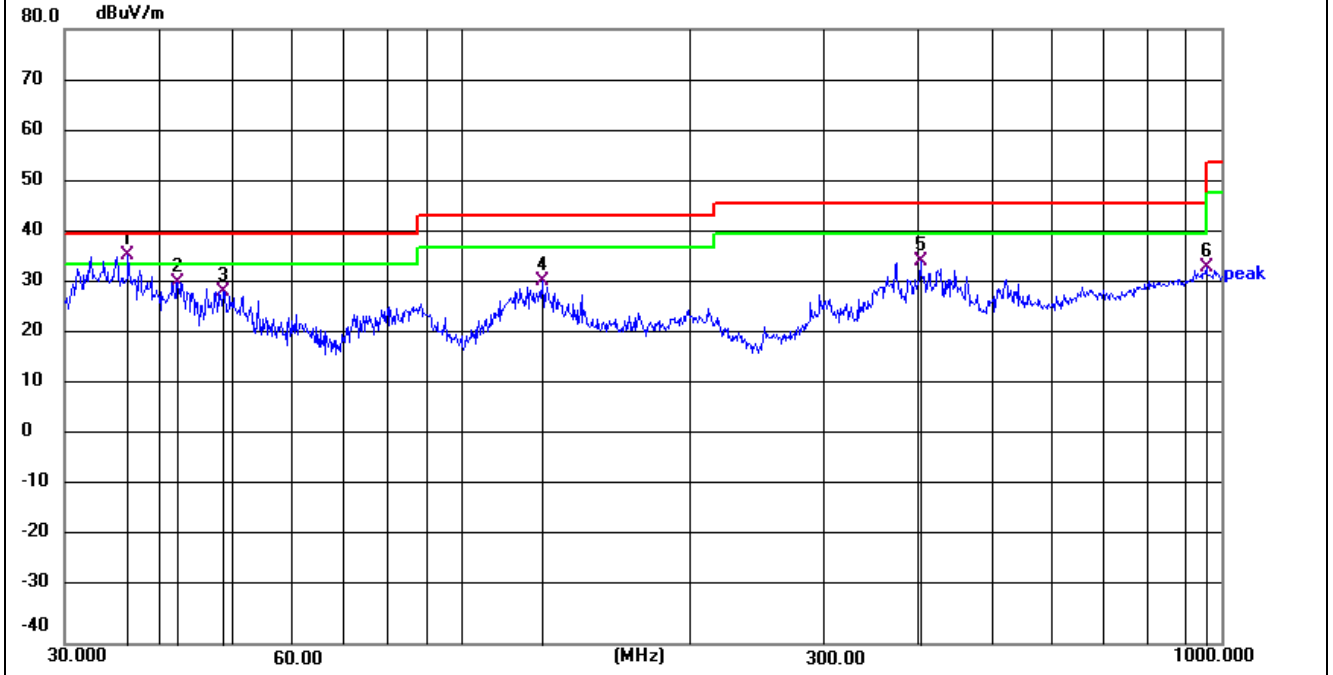

**Remark:**

Emission Level = Reading + Factor;  
 Factor = Antenna Factor + Cable Loss – Pre-amplifier;  
 Margin= Emission Level - Limit.

No.	Frequency (MHz)	Reading (dBuV)	Factor (dB/m)	Level (dBuV/m)	Limit (dBuV/m)	Margin (dB)	Det.
1 *	36.3814	52.80	-17.00	35.80	40.00	-4.20	QP
2	42.3022	47.24	-16.57	30.67	40.00	-9.33	QP
3	48.6719	45.48	-16.62	28.86	40.00	-11.14	QP
4	127.6645	48.85	-17.87	30.98	43.50	-12.52	QP
5	401.8385	49.17	-14.52	34.65	46.00	-11.35	QP
6	955.4381	37.00	-3.49	33.51	46.00	-12.49	QP

### 3.3 20dB Bandwidth

#### Limit

The 20dB bandwidth shall be less than 80% of the permitted frequency band.

#### Test Procedure

1. Set RBW = 30Hz.
2. Set the video bandwidth (VBW)  $\geq 3 \times$  RBW.
3. Detector = Peak.
4. Trace mode = max hold.
5. Sweep = auto couple.
6. Allow the trace to stabilize.
7. Measure the maximum width of the emission that is constrained by the frequencies associated with the two outermost amplitude points (upper and lower frequencies) that are attenuated by 20 dB relative to the maximum level measured in the fundamental emission.

#### Test setup

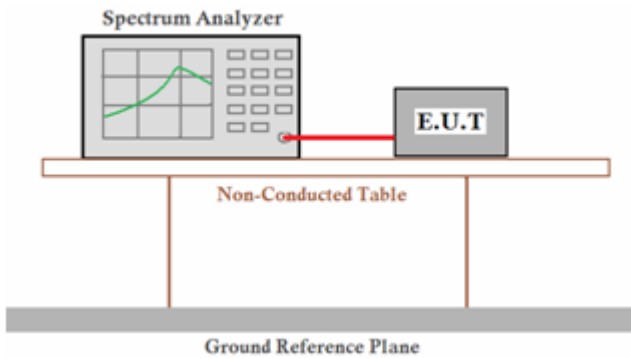

#### Test Results

Mode	Frequency (KHz)	20dB Bandwidth (KHz)	99% OBW (KHz)	Conclusion
Tx Mode	134.5	0.091	-	PASS
Tx Mode	164.0	0.095	-	PASS
Tx Mode	355.7	0.092	-	PASS

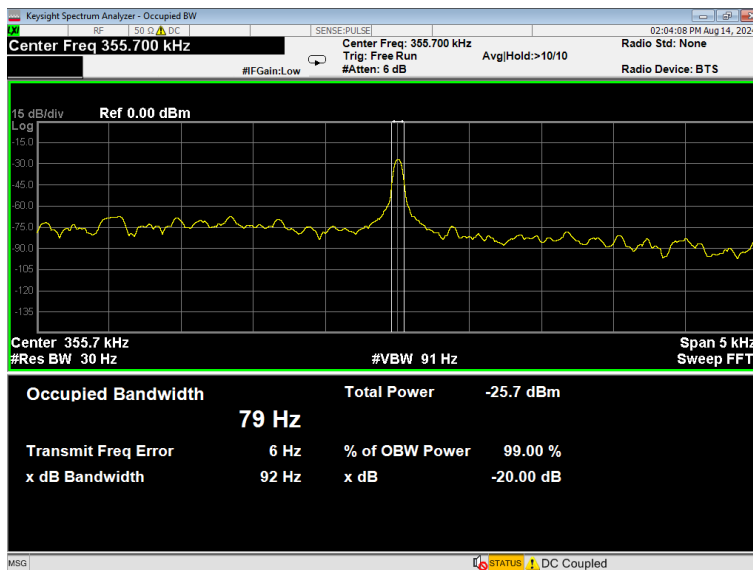
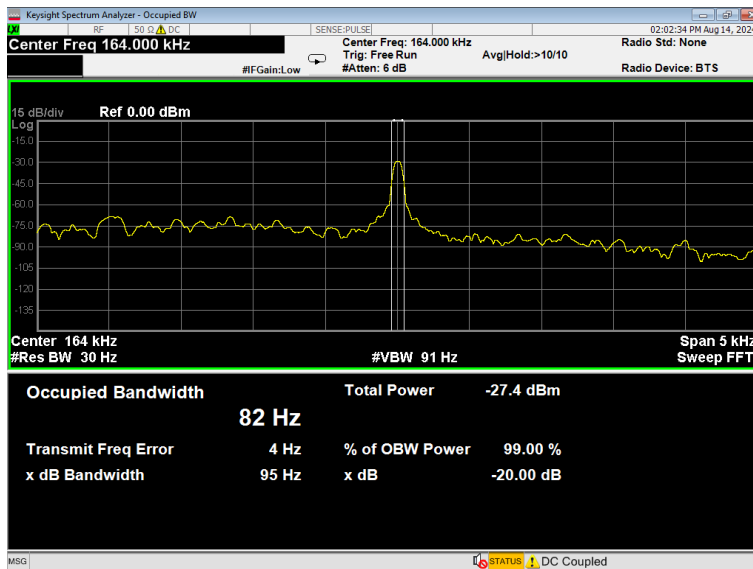
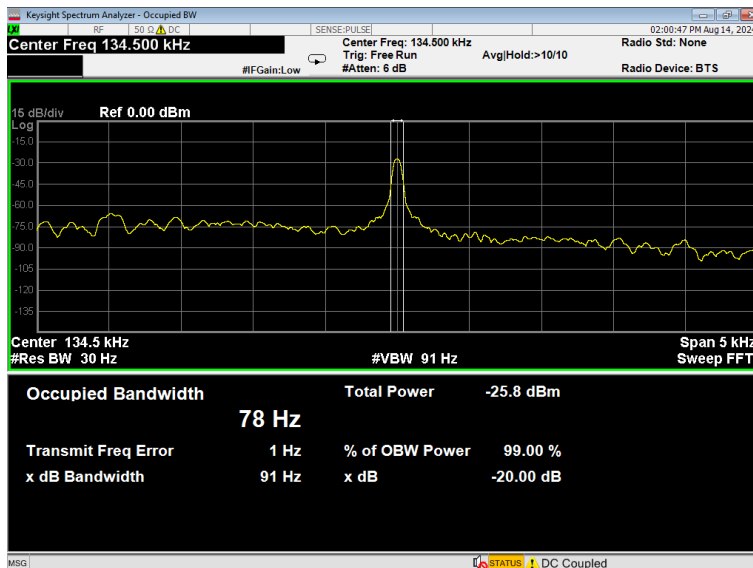

### **3.4 Antenna Requirement**

#### **Standard Applicable**

**For intentional device, according to FCC 47 CFR Section 15.203:**

An intentional radiator shall be designed to ensure that no antenna other than that furnished by the responsible party shall be used with the device. The use of a permanently attached antenna or of an antenna that uses a unique coupling to the intentional radiator, the manufacturer may design the unit so that a broken antenna can be replaced by the user, but the use of a standard antenna jack or electrical connector is prohibited

#### **Confirmation**

The EUT's antenna is an Inductive Loop coil Antenna, the best case gain of the antenna is 0dBi.

#### **4 Test Setup Photographs of EUT**

Please refer to separated files for Test Setup Photos of the EUT.

#### **5 External Photographs of EUT**

Please refer to separated files for External Photos of the EUT.

#### **6 Internal Photographs of EUT**

Please refer to separated files for Internal Photos of the EUT.

\*\*\*\*\* End of Report \*\*\*\*\*