



# RF TEST REPORT

**Applicant** Huawei Device Co., Ltd.  
**Product** 1500Mbps Wireless Router  
**FCC ID** 2ATEYWS7001  
**Model** WS7001  
**Report No.** R2108A0722-R2V3  
**Issue Date** October 11, 2021

TA Technology (Shanghai) Co., Ltd. tested the above equipment in accordance with the requirements in **FCC CFR47 Part 15E (2020)**. The test results show that the equipment tested is capable of demonstrating compliance with the requirements as documented in this report.

Prepared by: Peng Tao

Approved by: Kai Xu

---

**TA Technology (Shanghai) Co., Ltd.**

No.145, Jintang Rd, Tangzhen Industry Park, Pudong Shanghai, China

TEL: +86-021-50791141/2/3

FAX: +86-021-50791141/2/3-8000



## TABLE OF CONTENT

|   |     |
|---|-----|
| 1. Test Laboratory .....                            | 5   |
| 1.1. Notes of the test report.....                  | 5   |
| 1.2. Test facility .....                            | 5   |
| 1.3. Testing Location .....                         | 5   |
| 2. General Description of Equipment under Test..... | 6   |
| 2.1. Applicant and Manufacturer Information.....    | 6   |
| 2.2. General information.....                       | 6   |
| 3. Applied Standards .....                          | 8   |
| 4. Test Configuration .....                         | 9   |
| 5. Test Case Results .....                          | 11  |
| 5.1. Occupied Bandwidth .....                       | 11  |
| 5.2. Average Power Output.....                      | 24  |
| 5.3. Frequency Stability.....                       | 36  |
| 5.4. Power Spectral Density.....                    | 39  |
| 5.5. Unwanted Emission .....                        | 97  |
| 5.6. Conducted Emission .....                       | 169 |
| 6. Main Test Instruments.....                       | 172 |
| ANNEX A: The EUT Appearance .....                   | 173 |
| ANNEX B: Test Setup Photos .....                    | 174 |



| Version | Revision description                                       | Issue Date         |
|---------|--|--------------------|
| Rev.0   | Initial issue of report.                                   | September 15, 2021 |
| Rev.1   | Update information in Page 102.<br>Update data in Page131. | September 22, 2021 |
| Rev.2   | Update data in Page28.                                     | September 22, 2021 |
| Rev.3   | Update information in Page 6 and Page 10.                  | October 11, 2021   |

Note: This revised report (Report No. R2108A0722-R2V3) supersedes and replaces the previously issued report (Report No. R2108A0722-R2V2). Please discard or destroy the previously issued report and dispose of it accordingly.

## Summary of measurement results

| Number | Test Case              | Clause in FCC rules | Verdict |
|--------|------------------------|---------------------|---------|
| 1      | Average output power   | 15.407(a)           | PASS    |
| 2      | Occupied bandwidth     | 15.407(e)           | PASS    |
| 3      | Frequency stability    | 15.407(g)           | PASS    |
| 4      | Power spectral density | 15.407(a)           | PASS    |
| 5      | Unwanted Emissions     | 15.407(b)           | PASS    |
| 6      | Conducted Emissions    | 15.207              | PASS    |

Date of Testing: August 13, 2021 ~ September 10, 2021  
Date of Sample Received: August 10, 2021

Note: PASS: The EUT complies with the essential requirements in the standard.  
FAIL: The EUT does not comply with the essential requirements in the standard.  
All indications of Pass/Fail in this report are opinions expressed by TA Technology (Shanghai) Co., Ltd. based on interpretations and/or observations of test results. Measurement Uncertainties were not taken into account and are published for informational purposes only.



## 1. Test Laboratory

### 1.1. Notes of the test report

This report shall not be reproduced in full or partial, without the written approval of **TA technology (shanghai) co., Ltd.** The results documented in this report apply only to the tested sample, under the conditions and modes of operation as described herein. Measurement Uncertainties were not taken into account and are published for informational purposes only. This report is written to support regulatory compliance of the applicable standards stated above.

### 1.2. Test facility

#### **FCC (Designation number: CN1179, Test Firm Registration Number: 446626)**

TA Technology (Shanghai) Co., Ltd. has been listed on the US Federal Communications Commission list of test facilities recognized to perform electromagnetic emissions measurements.

#### **A2LA (Certificate Number: 3857.01)**

TA Technology (Shanghai) Co., Ltd. has been listed by American Association for Laboratory Accreditation to perform electromagnetic emission measurement.

### 1.3. Testing Location

Company: TA Technology (Shanghai) Co., Ltd.  
Address: No.145, Jintang Rd, Tangzhen Industry Park, Pudong  
City: Shanghai  
Post code: 201201  
Country: P. R. China  
Contact: Xu Kai  
Telephone: +86-021-50791141/2/3  
Fax: +86-021-50791141/2/3-8000  
Website: <http://www.ta-shanghai.com>  
E-mail: [xukai@ta-shanghai.com](mailto:xukai@ta-shanghai.com)

## 2. General Description of Equipment under Test

### 2.1. Applicant and Manufacturer Information

|                             |   |
|-----------------------------|---|
| <b>Applicant</b>            | Huawei Device Co., Ltd.   |
| <b>Applicant address</b>    | No.2 of Xincheng Road, Songshan Lake Zone, Dongguan, Guangdong 523808, People's Republic of China |
| <b>Manufacturer</b>         | Huawei Device Co., Ltd.   |
| <b>Manufacturer address</b> | No.2 of Xincheng Road, Songshan Lake Zone, Dongguan, Guangdong 523808, People's Republic of China |

### 2.2. General information

| EUT Description              |   |              |     |
|------------------------------|---|--------------|-----|
| Model                        | WS7001  |              |     |
| SN                           | PDUQU21705000031  |              |     |
| Hardware Version             | AM1TC7001M  |              |     |
| Software Version             | 11.0.3.3  |              |     |
| Power Supply                 | DC / AC adapter   |              |     |
| Antenna Type                 | External Antenna  |              |     |
| Antenna Gain                 | Antenna 1: 5.0 dBi<br>Antenna 2: 5.0 dBi  |              |     |
| Test Band                    | U-NII-1(5150MHz-5250MHz)<br>U-NII-3(5725MHz-5850MHz)  |              |     |
| Modulation Type              | 802.11a/n (HT20/HT40) : OFDM<br>802.11ac (VHT20/VHT40/VHT80): OFDM<br>802.11ax SU mode (HE20/HE40/HE80): OFDM |              |     |
| Max. Power Output            | 23.97 dBm   |              |     |
| Operating Frequency Range(s) | U-NII-1: 5150MHz-5250MH<br>U-NII-3: 5725MHz -5850MHz  |              |     |
| Extreme temperature range:   | -20 ° C to 50° C  |              |     |
| Operating temperature range: | 0 ° C to 40° C  |              |     |
| Operating voltage range:     | 11.4 V to 12.6 V  |              |     |
| State DC voltage:            | 12V   |              |     |
| EUT Accessory                |   |              |     |
| Accessory                    | Model   | Manufacturer | No. |
| Adapter                      | HW-120100U01  | UE/HONOR     | 1   |
|                              | HW-120100E01  |              | 2   |
|                              | HW-120100B01  |              | 3   |



Note: 1. The EUT is sent from the applicant to TA and the information of the EUT is declared by the applicant.

2. There is more than one Adapter, each one should be applied throughout the compliance test respectively, and however, only the worst case (Adapter 1) will be recorded in this report.



### 3. Applied Standards

According to the specifications of the manufacturer, it must comply with the requirements of the following standards:

**Test standards:**

**FCC CFR47 Part 15E (2020)** Unlicensed National Information Infrastructure Devices

**ANSI C63.10 (2013)**

**Reference standard:**

**KDB 789033 D02 General UNII Test Procedures New Rules v02r01**

**KDB 662911 D01 Multiple Transmitter Output v02r01**



## 4. Test Configuration

### Test Mode

The EUT has been associated with peripherals and configuration operated in a manner tended to maximize its emission characteristics in a typical application.

The radiated emission was measured in the following position: EUT stand-up position (Z axis), lie-down position (X, Y axis). The worst emission was found in stand-up position (Z axis) and the worst case was recorded.

In order to find the worst case condition, Pre-tests are needed at the presence of different data rate. Preliminary tests have been done on all the configuration for confirming worst case. Data rate below means worst-case rate of each test item.

Worst-case data rates are shown as following table.

| Mode           | Data Rate |           |      |
|----------------|-----------|-----------|------|
|                | Antenna 1 | Antenna 2 | MIMO |
| 802.11a        | 6 Mbps    | 6 Mbps    | /    |
| 802.11n HT20   | MCS0      | MCS0      | MCS8 |
| 802.11n HT40   | MCS0      | MCS0      | MCS8 |
| 802.11ac VHT20 | MCS0      | MCS0      | MCS0 |
| 802.11ac VHT40 | MCS0      | MCS0      | MCS0 |
| 802.11ac VHT80 | MCS0      | MCS0      | MCS0 |
| 802.11ax HE20  | MCS0      | MCS0      | MCS0 |
| 802.11ax HE40  | MCS0      | MCS0      | MCS0 |
| 802.11ax HE80  | MCS0      | MCS0      | MCS0 |

The device supports non-beamforming and beamforming function in 802.11n/ac, after pre-testing, beamforming mode has the worst emission value, so the worst case was recorded.

The worst case Antenna mode for each of the following tests for Wi-Fi:

| Test Cases                     | Antenna 1         | Antenna 2 | CDD/MIMO |
|--------------------------------|-------------------|-----------|----------|
| Average conducted output power | O                 | O         | O        |
| Occupied bandwidth             | --                | --        | O        |
| Frequency stability            | 802.11a           | --        | --       |
| Power Spectral Density         | O                 | O         | O        |
| Unwanted Emissions             | O                 | --        | --       |
| Conducted Emissions            | 802.11ac<br>VHT20 | --        | --       |
| Note: "O": test all bands      |                   |           |          |

According to RF Output power results in chapter 5.1, MIMO was selected as the worst antenna for 802.11n HT20/40, 802.11ac VHT20/40/80, and 802.11ax HE20/40/80. SISO Antenna 1 was selected as the worst SISO antenna for 802.11a.

**Wireless Technology and Frequency Range**

| Wireless Technology  |         | Bandwidth | Channel | Frequency |         |
|--|---------|-----------|---------|-----------|---------|
| Wi-Fi  | U-NII-1 | 20 MHz    | 36      | 5180MHz   |         |
|  |         |           | 40      | 5200MHz   |         |
|  |         |           | 44      | 5220MHz   |         |
|  |         |           | 48      | 5240MHz   |         |
|  |         | 40 MHz    | 38      | 5190MHz   |         |
|  |         |           | 46      | 5230MHz   |         |
|  | U-NII-3 | 80 MHz    | 42      | 5210MHz   |         |
|  |         |           | 20 MHz  | 149       | 5745MHz |
|  |         |           |         | 153       | 5765MHz |
|  |         | 157       |         | 5785MHz   |         |
|  |         | 161       |         | 5805MHz   |         |
|  |         | 165       |         | 5825MHz   |         |
| 40 MHz   | 151     | 5755MHz   |         |           |         |
|  | 159     | 5795MHz   |         |           |         |
|  |         | 80 MHz    | 155     | 5775MHz   |         |
| Does this device support TPC Function? <input checked="" type="checkbox"/> Yes <input type="checkbox"/> No |         |           |         |           |         |
| Does this device support TDWR Band? <input type="checkbox"/> Yes <input checked="" type="checkbox"/> No    |         |           |         |           |         |

## 5. Test Case Results

### 5.1. Occupied Bandwidth

#### Ambient condition

| Temperature | Relative humidity | Pressure |
|-------------|-------------------|----------|
| 23°C ~25°C  | 45%~50%           | 101.5kPa |

#### Method of Measurement

The EUT was connected to the spectrum analyzer through an external attenuator (20dB) and a known loss cable.

For U-NII-1, set RBW  $\approx$ 1% OCB kHz, VBW  $\geq$  3  $\times$  RBW, measure the maximum width of the emission that is constrained by the frequencies associated with the two outermost amplitude points (upper and lower frequencies) that are attenuated by 26 dB relative to the maximum level measured in the fundamental emission.

For U-NII-3, Set RBW = 100 kHz, VBW  $\geq$  3  $\times$  RBW, measure the maximum width of the emission that is constrained by the frequencies associated with the two outermost amplitude points (upper and lower frequencies) that are attenuated by 6 dB relative to the maximum level measured in the fundamental emission.

Note: The automatic bandwidth measurement capability of a spectrum analyzer or EMI receiver may be employed if it implements the functionality described above.

Use the 99 % power bandwidth function of the instrument

#### Test Setup

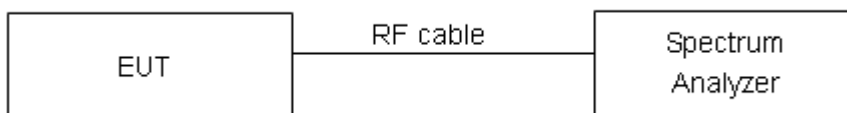

#### Limits

Rule FCC Part §15.407(e)

Within the 5.725-5.85 GHz band, the minimum 6 dB bandwidth of U-NII devices shall be at least 500 kHz.

#### Measurement Uncertainty

The assessed measurement uncertainty to ensure 95% confidence level for the normal distribution is with the coverage factor  $k = 2$ ,  $U = 936$  Hz.

**Test Results:****U-NII-1**

| Mode              | Carrier frequency (MHz) | 99% bandwidth (MHz) | Minimum 26 dB bandwidth (MHz) | Conclusion |
|-------------------|-------------------------|---------------------|-------------------------------|------------|
| 802.11a           | 5180                    | 16.951              | 22.28                         | PASS       |
|                   | 5200                    | 17.068              | 22.49                         | PASS       |
|                   | 5240                    | 17.312              | 28.79                         | PASS       |
| 802.11n<br>HT20   | 5180                    | 18.004              | 23.21                         | PASS       |
|                   | 5200                    | 18.117              | 24.01                         | PASS       |
|                   | 5240                    | 18.319              | 27.74                         | PASS       |
| 802.11n<br>HT40   | 5190                    | 36.546              | 44.32                         | PASS       |
|                   | 5230                    | 36.554              | 44.29                         | PASS       |
| 802.11ac<br>VHT20 | 5180                    | 17.921              | 23.22                         | PASS       |
|                   | 5200                    | 18.015              | 24.15                         | PASS       |
|                   | 5240                    | 18.297              | 26.69                         | PASS       |
| 802.11ac<br>VHT40 | 5190                    | 36.764              | 45.30                         | PASS       |
|                   | 5230                    | 36.774              | 44.94                         | PASS       |
| 802.11ac VHT80    | 5210                    | 76.538              | 86.53                         | PASS       |
| 802.11ax<br>HE 20 | 5180                    | 19.134              | 23.08                         | PASS       |
|                   | 5200                    | 19.218              | 23.18                         | PASS       |
|                   | 5240                    | 19.674              | 30.77                         | PASS       |
| 802.11ax<br>HE 40 | 5190                    | 38.316              | 44.73                         | PASS       |
|                   | 5230                    | 38.279              | 44.79                         | PASS       |
| 802.11ax HE 80    | 5210                    | 77.711              | 82.47                         | PASS       |



## U-NII-3

| Mode              | Carrier frequency (MHz) | 99% bandwidth (MHz) | Minimum 6 dB bandwidth (MHz) | Limit (kHz) | Conclusion |
|-------------------|-------------------------|---------------------|------------------------------|-------------|------------|
| 802.11a           | 5745                    | 17.020              | 16.44                        | 500         | PASS       |
|                   | 5825                    | 16.975              | 16.44                        | 500         | PASS       |
| 802.11n<br>HT20   | 5745                    | 18.289              | 17.64                        | 500         | PASS       |
|                   | 5825                    | 18.361              | 17.64                        | 500         | PASS       |
| 802.11n<br>HT40   | 5755                    | 36.727              | 36.48                        | 500         | PASS       |
|                   | 5795                    | 37.145              | 36.48                        | 500         | PASS       |
| 802.11ac<br>VHT20 | 5745                    | 18.159              | 17.64                        | 500         | PASS       |
|                   | 5825                    | 18.262              | 17.64                        | 500         | PASS       |
| 802.11ac<br>VHT40 | 5755                    | 36.935              | 36.48                        | 500         | PASS       |
|                   | 5795                    | 37.249              | 36.48                        | 500         | PASS       |
| 802.11ac VHT80    | 5775                    | 76.558              | 76.64                        | 500         | PASS       |
| 802.11ax<br>HE 20 | 5745                    | 19.273              | 18.80                        | 500         | PASS       |
|                   | 5825                    | 19.210              | 18.72                        | 500         | PASS       |
| 802.11ax<br>HE 40 | 5755                    | 38.353              | 38.00                        | 500         | PASS       |
|                   | 5795                    | 38.448              | 38.00                        | 500         | PASS       |
| 802.11ax HE 80    | 5775                    | 77.678              | 77.44                        | 500         | PASS       |

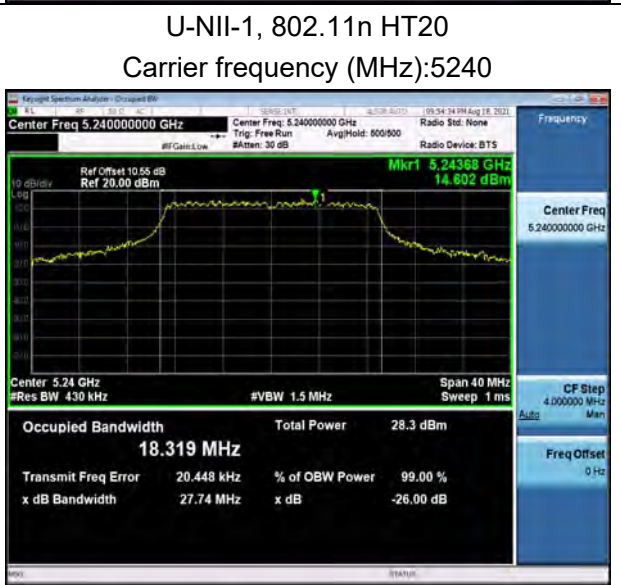
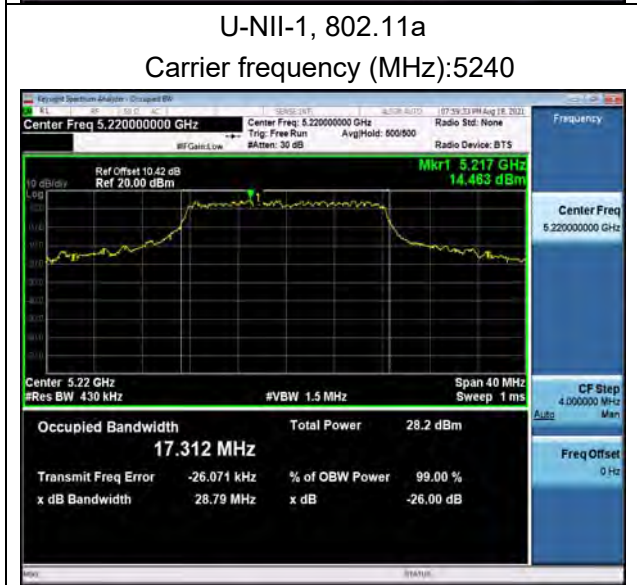
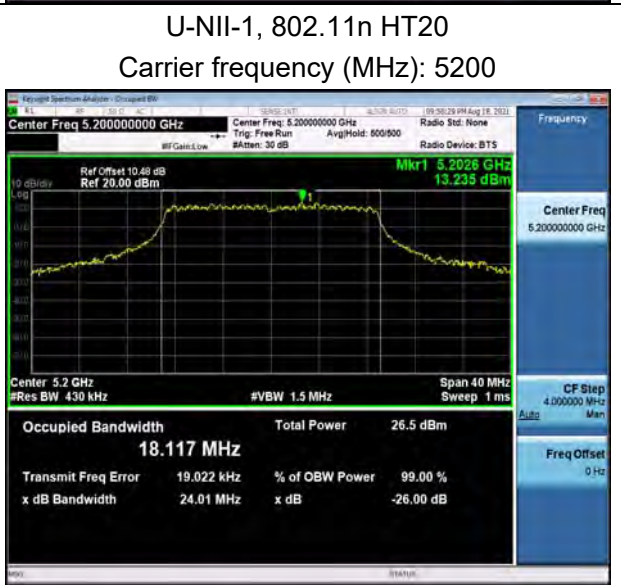
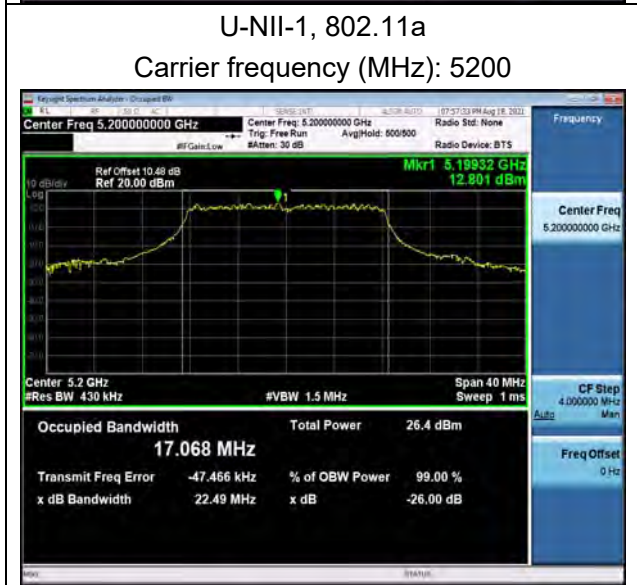
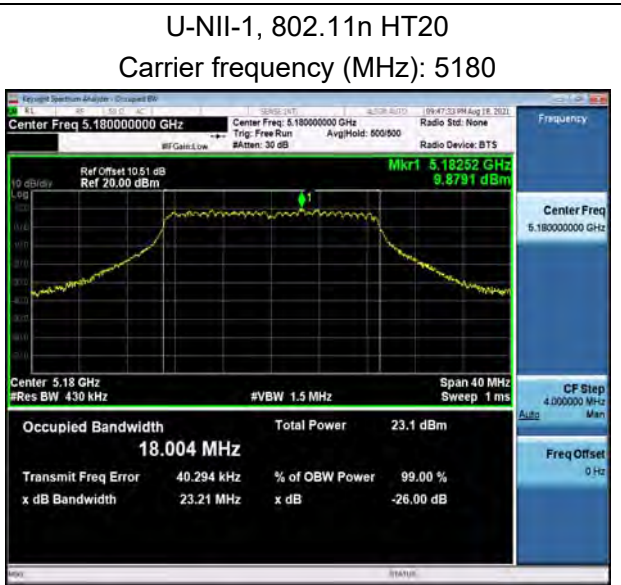
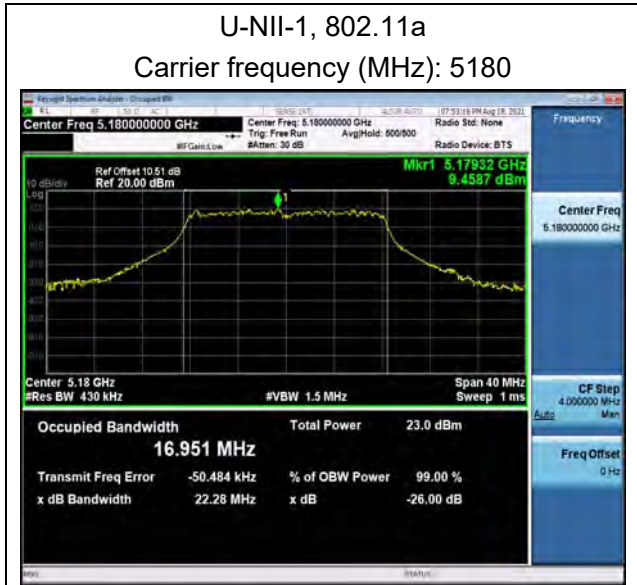



U-NII-1, 802.11n HT40  
Carrier frequency (MHz): 5190



U-NII-1, 802.11n HT40  
Carrier frequency (MHz): 5230



U-NII-1, 802.11ac VHT20  
Carrier frequency (MHz): 5180

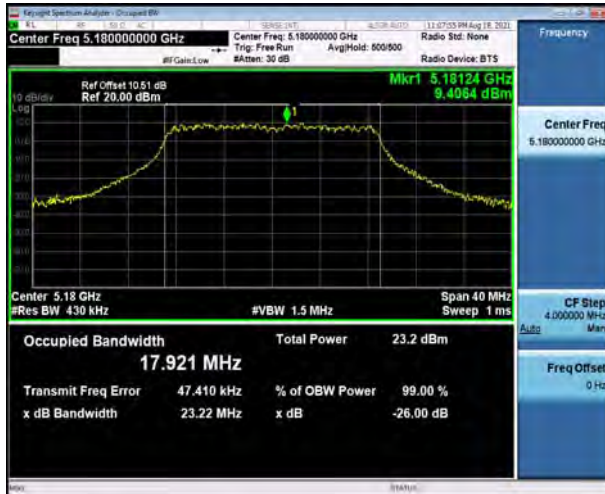

U-NII-1, 802.11ax HE20  
Carrier frequency (MHz): 5180

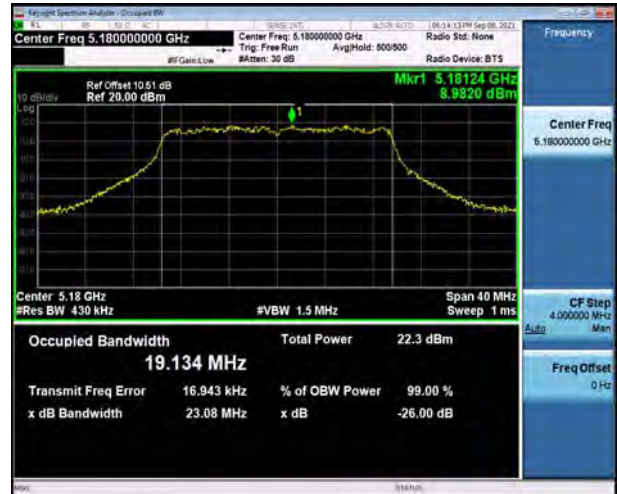

U-NII-1, 802.11ac VHT20  
Carrier frequency (MHz): 5200



U-NII-1, 802.11ax HE20  
Carrier frequency (MHz): 5200



U-NII-1, 802.11ac VHT20  
Carrier frequency (MHz):5240



U-NII-1, 802.11ax HE20  
Carrier frequency (MHz):5240



U-NII-1, 802.11ac VHT40  
Carrier frequency (MHz): 5190



U-NII-1, 802.11ax HE40  
Carrier frequency (MHz): 5190



U-NII-1, 802.11ac VHT40  
Carrier frequency (MHz): 5230



U-NII-1, 802.11ax HE40  
Carrier frequency (MHz): 5230





U-NII-1, 802.11ac VHT80  
Carrier frequency (MHz): 5210



U-NII-1, 802.11ax HE80  
Carrier frequency (MHz): 5210

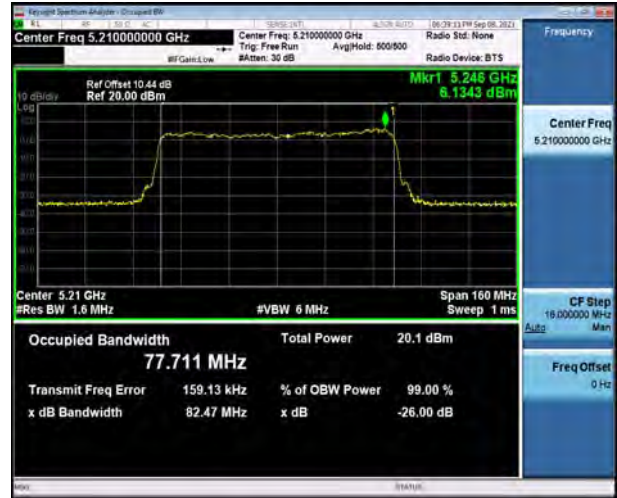



99% bandwidth

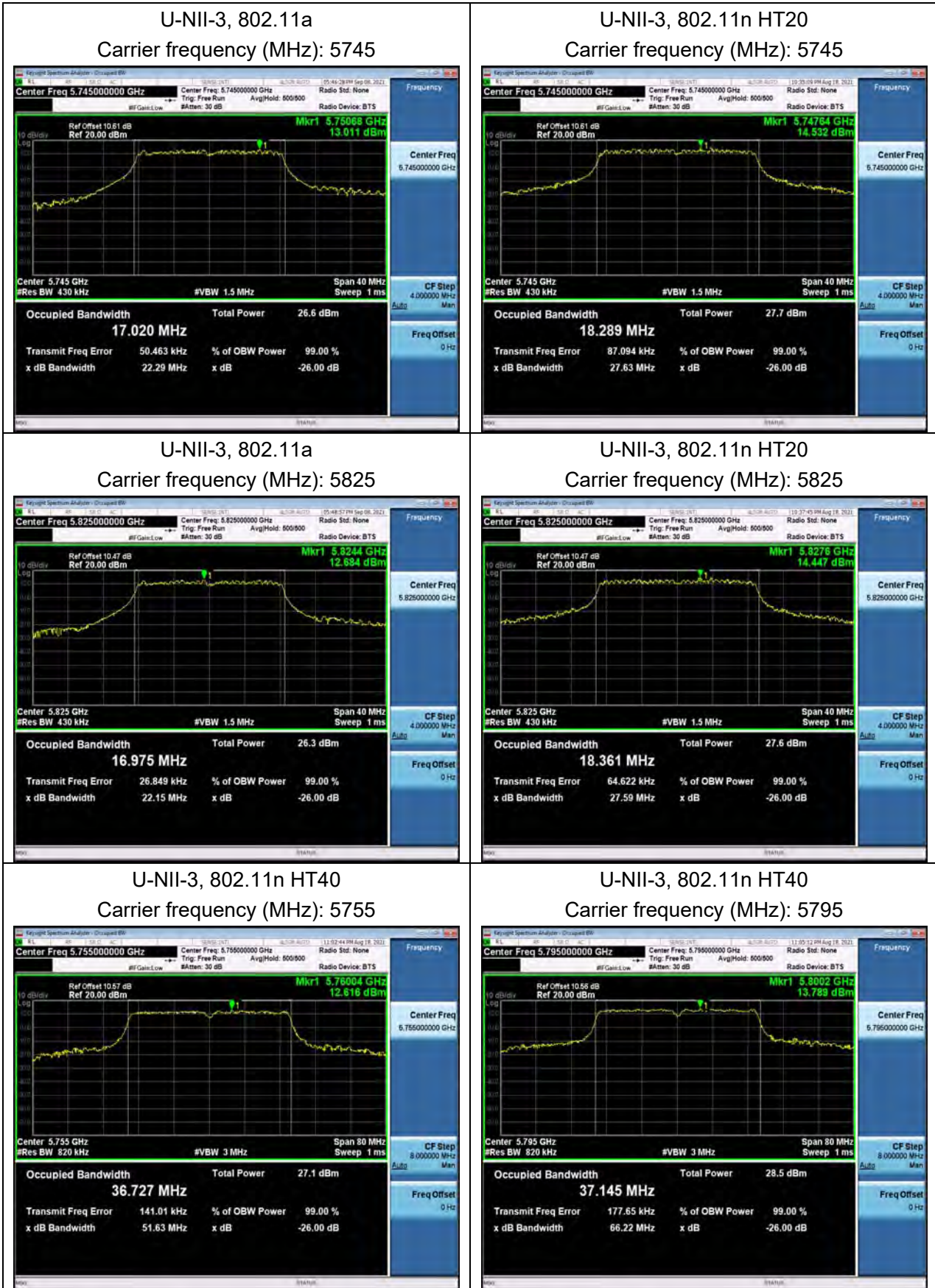



U-NII-3, 802.11ac VHT20  
Carrier frequency (MHz): 5745



U-NII-3, 802.11ax HE20  
Carrier frequency (MHz): 5745

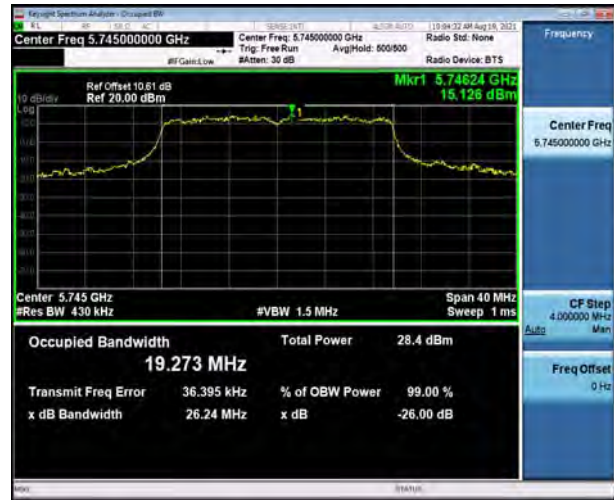

U-NII-3, 802.11ac VHT20  
Carrier frequency (MHz): 5825



U-NII-3, 802.11ax HE20  
Carrier frequency (MHz): 5825

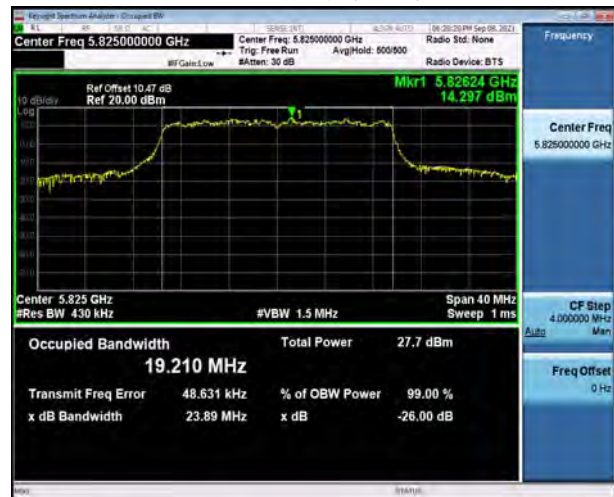

U-NII-3, 802.11ac VHT40  
Carrier frequency (MHz): 5755

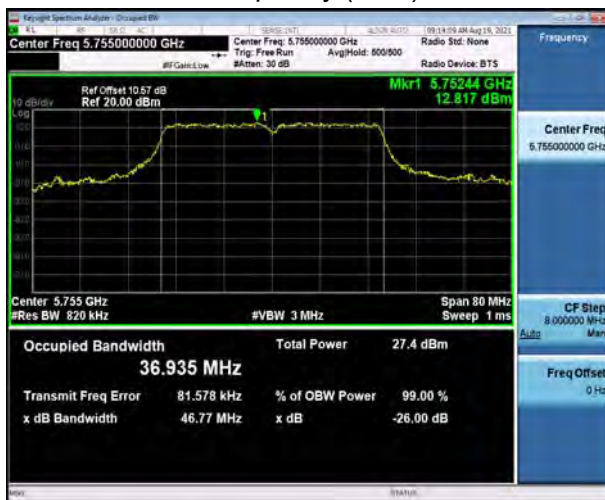

U-NII-3, 802.11ax HT40  
Carrier frequency (MHz): 5755





U-NII-3, 802.11ac VHT40  
Carrier frequency (MHz): 5795



U-NII-3, 802.11ax HE40  
Carrier frequency (MHz): 5795



U-NII-3, 802.11ac VHT80  
Carrier frequency (MHz): 5775



U-NII-3, 802.11ax HE80  
Carrier frequency (MHz): 5775

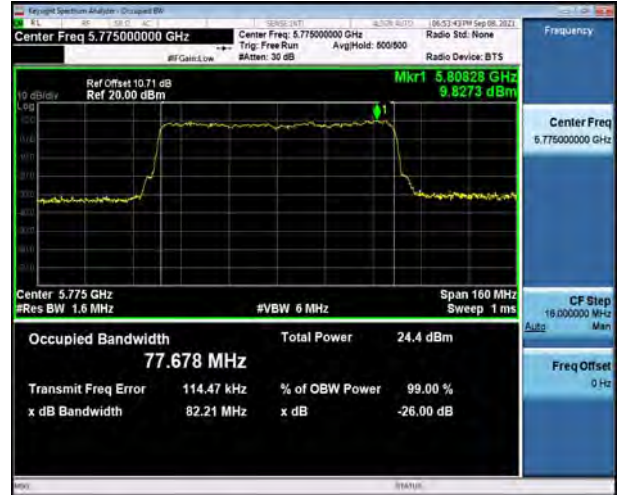





Minimum 6 dB bandwidth

U-NII-3, 802.11a

Carrier frequency (MHz): 5745

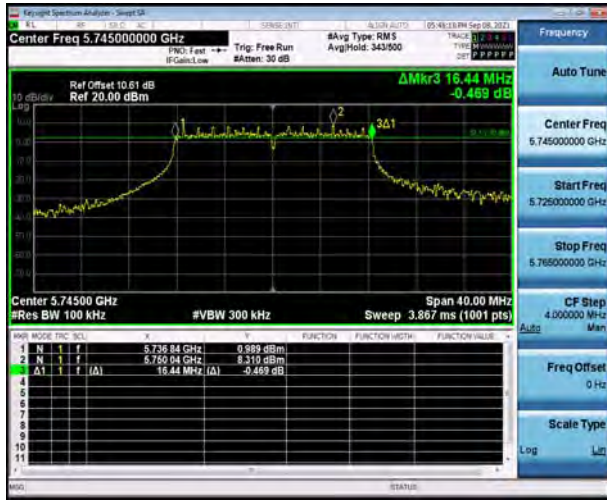

U-NII-3, 802.11n HT20

Carrier frequency (MHz): 5745

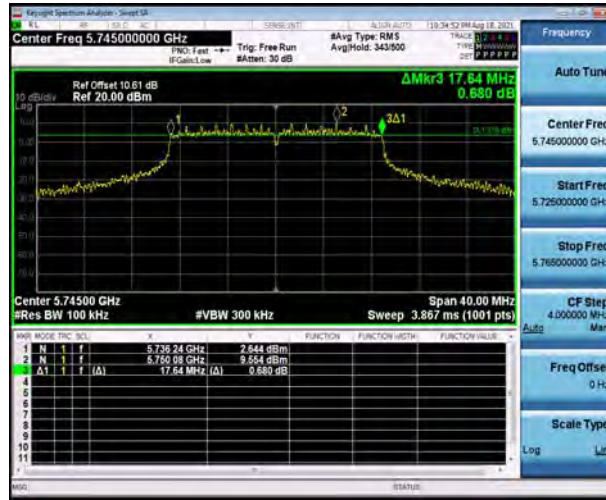

U-NII-3, 802.11a

Carrier frequency (MHz): 5825



U-NII-3, 802.11n HT20

Carrier frequency (MHz): 5825



U-NII-3, 802.11n HT40

Carrier frequency (MHz): 5755

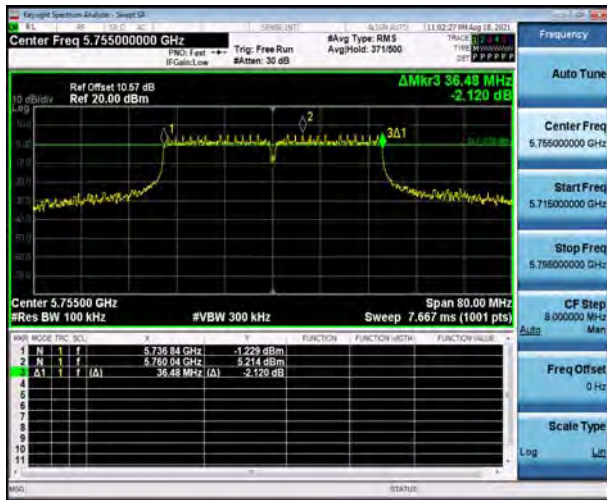

U-NII-3, 802.11n HT40

Carrier frequency (MHz): 5795

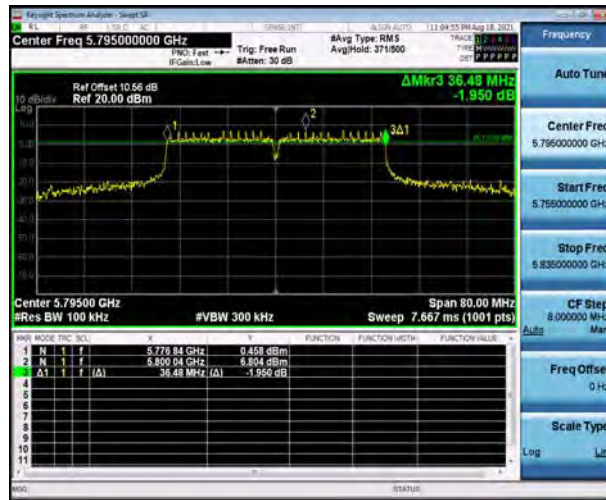



U-NII-3, 802.11ac VHT20  
Carrier frequency (MHz): 5745

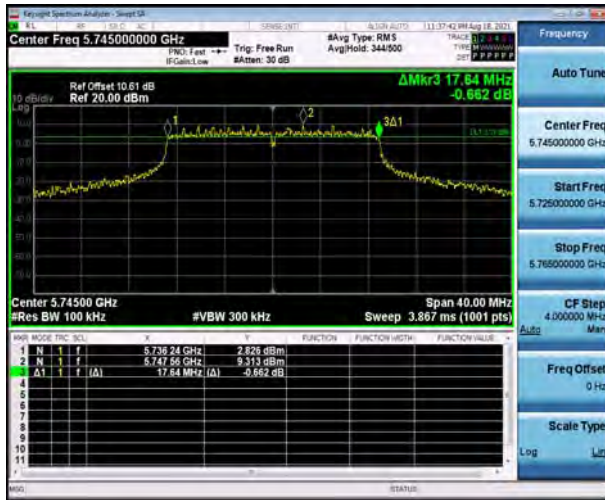

U-NII-3, 802.11ax HE20  
Carrier frequency (MHz): 5745

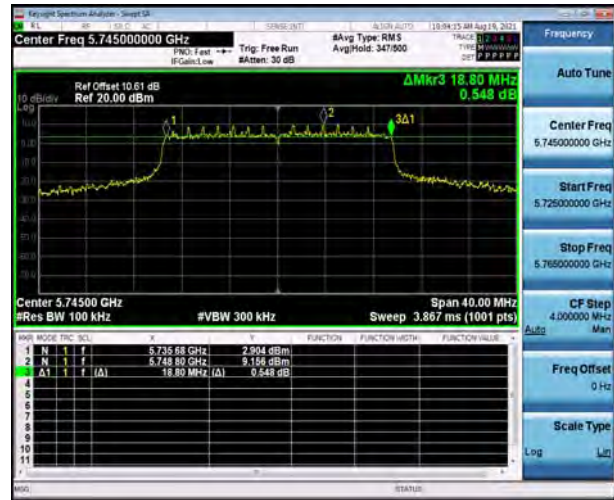

U-NII-3, 802.11 ac VHT20  
Carrier frequency (MHz): 5825

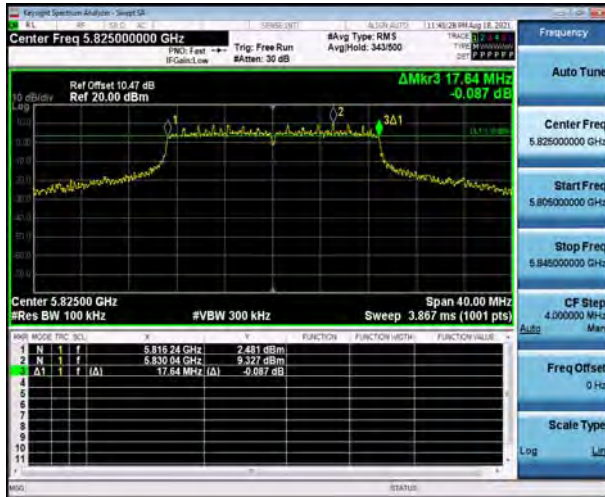

U-NII-3, 802.11ax HE20  
Carrier frequency (MHz): 5825

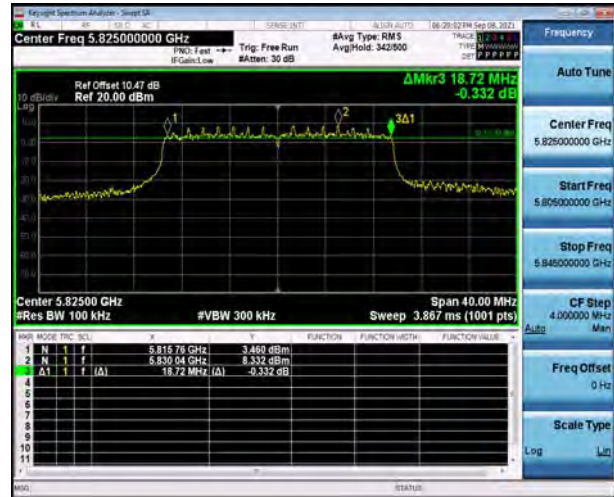

U-NII-3, 802.11ac VHT40  
Carrier frequency (MHz): 5755

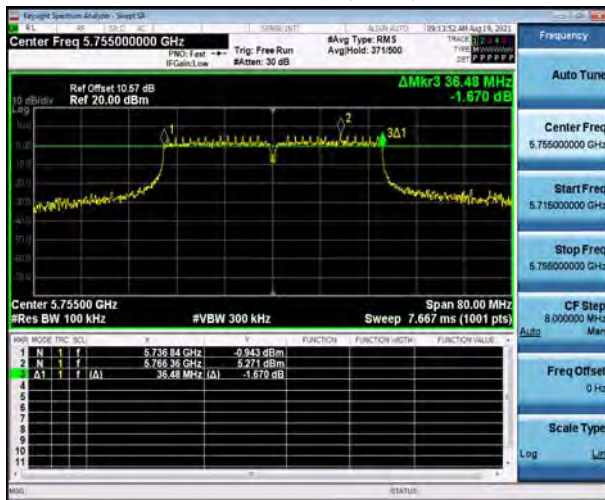

U-NII-3, 802.11ax HE 40  
Carrier frequency (MHz): 5755







U-NII-3, 802.11ac VHT40  
Carrier frequency (MHz): 5795

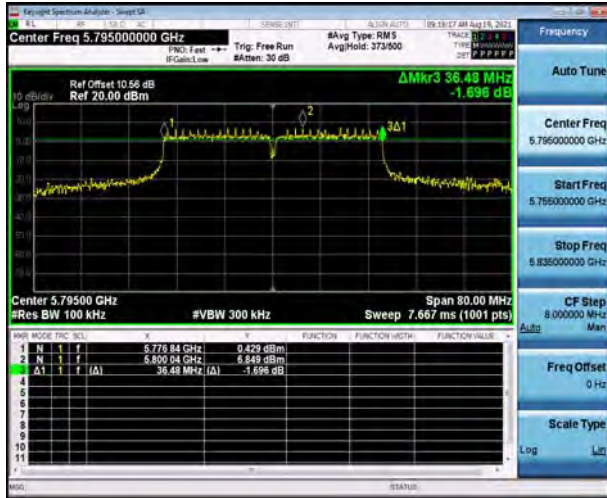

U-NII-3, 802.11ax HE40  
Carrier frequency (MHz): 5795

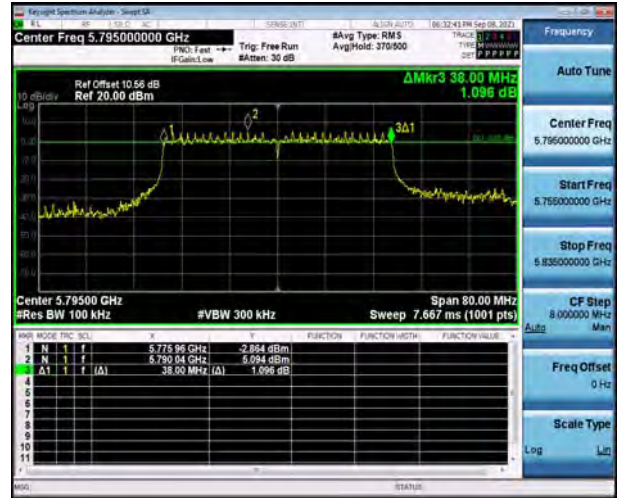

U-NII-3, 802.11ac VHT80  
Carrier frequency (MHz): 5775

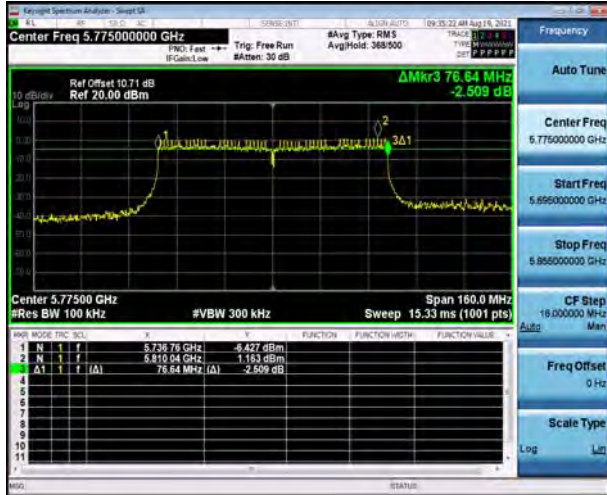

U-NII-3, 802.11ax HE80  
Carrier frequency (MHz): 5775



## 5.2. Average Power Output

### Ambient condition

| Temperature | Relative humidity | Pressure |
|-------------|-------------------|----------|
| 23°C ~25°C  | 45%~50%           | 101.5kPa |

### Methods of Measurement

During the process of the testing, The EUT was connected to the average power meter through an external attenuator and a known loss cable. The EUT is max power transmission with proper modulation. We use Maximum average Conducted Output Power Level Method in KDB789033 for this test

The conducted Power is measured at each antenna port. The measured results at the various antenna ports are then summed mathematically.

### Test Setup

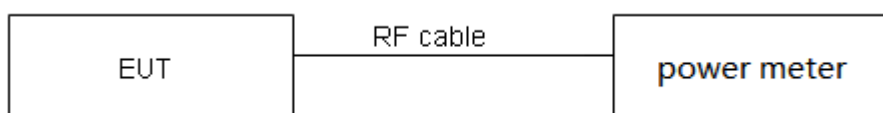

### Limits

Rule FCC Part 15.407(a)(1)(2)(3)

(1) For the band 5.15-5.25 GHz.

(i) For an outdoor access point operating in the band 5.15-5.25 GHz, the maximum conducted output power over the frequency band of operation shall not exceed 1 W provided the maximum antenna gain does not exceed 6 dBi. In addition, the maximum power spectral density shall not exceed 17 dBm in any 1 megahertz band. If transmitting antennas of directional gain greater than 6 dBi are used, both the maximum conducted output power and the maximum power spectral density shall be reduced by the amount in dB that the directional gain of the antenna exceeds 6 dBi. The maximum e.i.r.p. at any elevation angle above 30 degrees as measured from the horizon must not exceed 125 mW (21 dBm).

(ii) For an indoor access point operating in the band 5.15-5.25 GHz, the maximum conducted output power over the frequency band of operation shall not exceed 1 W provided the maximum antenna gain does not exceed 6 dBi. In addition, the maximum power spectral density shall not exceed 17 dBm in any 1 megahertz band. If transmitting antennas of directional gain greater than 6 dBi are used, both the maximum conducted output power and the maximum power spectral density shall be reduced by the amount in dB that the directional gain of the antenna exceeds 6 dBi.

(iii) For fixed point-to-point access points operating in the band 5.15-5.25 GHz, the maximum conducted output power over the frequency band of operation shall not exceed 1 W. In addition, the maximum power spectral density shall not exceed 17 dBm in any 1 megahertz band. Fixed point-to-point U-NII devices may employ antennas with directional gain up to 23 dBi without any corresponding reduction in the maximum conducted output power or maximum power spectral density. For fixed point-to-point transmitters that employ a directional antenna gain greater than 23





dBi, a 1 dB reduction in maximum conducted output power and maximum power spectral density is required for each 1 dB of antenna gain in excess of 23 dBi. Fixed, point-to-point operations exclude the use of point-to-multipoint systems, omnidirectional applications, and multiple collocated transmitters transmitting the same information. The operator of the U-NII device, or if the equipment is professionally installed, the installer, is responsible for ensuring that systems employing high gain directional antennas are used exclusively for fixed, point-to-point operations.

(iv) For client devices in the 5.15-5.25 GHz band, the maximum conducted output power over the frequency band of operation shall not exceed 250 mW provided the maximum antenna gain does not exceed 6 dBi. In addition, the maximum power spectral density shall not exceed 11 dBm in any 1 megahertz band. If transmitting antennas of directional gain greater than 6 dBi are used, both the maximum conducted output power and the maximum power spectral density shall be reduced by the amount in dB that the directional gain of the antenna exceeds 6 dBi.

(2) For the band 5.725-5.85 GHz, the maximum conducted output power over the frequency band of operation shall not exceed 1 W. In addition, the maximum power spectral density shall not exceed 30 dBm in any 500-kHz band. If transmitting antennas of directional gain greater than 6 dBi are used, both the maximum conducted output power and the maximum power spectral density shall be reduced by the amount in dB that the directional gain of the antenna exceeds 6 dBi.

#### **Measurement Uncertainty**

The assessed measurement uncertainty to ensure 95% confidence level for the normal distribution is with the coverage factor  $k = 2$ ,  $U = 0.44$  dB.

**Test Results**
**SISO Antenna 1**

| Mode           | T <sub>on</sub> (ms) | T <sub>(on+off)</sub> (ms) | Duty cycle | Duty cycle correction Factor(dB) |
|----------------|----------------------|----------------------------|------------|----------------------------------|
| 802.11a        | 1.36                 | 1.46                       | 0.93       | 0.31                             |
| 802.11n HT20   | 1.28                 | 1.38                       | 0.93       | 0.33                             |
| 802.11n HT40   | 0.63                 | 0.74                       | 0.85       | 0.70                             |
| 802.11ac VHT20 | 1.28                 | 1.38                       | 0.93       | 0.33                             |
| 802.11ac VHT40 | 0.63                 | 0.73                       | 0.86       | 0.64                             |
| 802.11ac VHT80 | 0.31                 | 0.42                       | 0.74       | 1.32                             |
| 802.11ax HE20  | 0.98                 | 1.09                       | 0.90       | 0.46                             |
| 802.11ax HE40  | 0.52                 | 0.62                       | 0.84       | 0.76                             |
| 802.11ax HE80  | 0.28                 | 0.38                       | 0.74       | 1.33                             |

Note: when Duty cycle  $\geq 0.98$ , Duty cycle correction Factor not required.

**SISO Antenna 2**

| Mode           | T <sub>on</sub> (ms) | T <sub>(on+off)</sub> (ms) | Duty cycle | Duty cycle correction Factor(dB) |
|----------------|----------------------|----------------------------|------------|----------------------------------|
| 802.11a        | 1.36                 | 1.47                       | 0.93       | 0.34                             |
| 802.11n HT20   | 1.27                 | 1.37                       | 0.93       | 0.33                             |
| 802.11n HT40   | 0.63                 | 0.74                       | 0.85       | 0.70                             |
| 802.11ac VHT20 | 1.27                 | 1.37                       | 0.93       | 0.33                             |
| 802.11ac VHT40 | 0.63                 | 0.74                       | 0.85       | 0.70                             |
| 802.11ac VHT80 | 0.31                 | 0.42                       | 0.74       | 1.32                             |
| 802.11ax HE20  | 0.99                 | 1.09                       | 0.91       | 0.42                             |
| 802.11ax HE40  | 0.52                 | 0.62                       | 0.84       | 0.76                             |
| 802.11ax HE80  | 0.28                 | 0.38                       | 0.74       | 1.33                             |

Note: when Duty cycle  $\geq 0.98$ , Duty cycle correction Factor not required.

**MIMO with Beamforming**

| Mode           | T <sub>on</sub> (ms) | T <sub>(on+off)</sub> (ms) | Duty cycle | Duty cycle correction Factor(dB) |
|----------------|----------------------|----------------------------|------------|----------------------------------|
| 802.11a        | 1.36                 | 1.46                       | 0.93       | 0.31                             |
| 802.11n HT20   | 1.27                 | 1.37                       | 0.93       | 0.33                             |
| 802.11n HT40   | 0.63                 | 0.74                       | 0.85       | 0.70                             |
| 802.11ac VHT20 | 1.28                 | 1.38                       | 0.93       | 0.33                             |
| 802.11ac VHT40 | 0.63                 | 0.74                       | 0.85       | 0.70                             |
| 802.11ac VHT80 | 0.31                 | 0.42                       | 0.74       | 1.32                             |
| 802.11ax HE20  | 0.99                 | 1.09                       | 0.91       | 0.42                             |
| 802.11ax HE40  | 0.52                 | 0.62                       | 0.84       | 0.76                             |
| 802.11ax HE80  | 0.28                 | 0.38                       | 0.74       | 1.33                             |

Note: when Duty cycle  $\geq 0.98$ , Duty cycle correction Factor not required.

**MIMO without Beamforming**

| Mode           | T <sub>on</sub> (ms) | T <sub>(on+off)</sub> (ms) | Duty cycle | Duty cycle correction Factor(dB) |
|----------------|----------------------|----------------------------|------------|----------------------------------|
| 802.11a        | 1.36                 | 1.46                       | 0.93       | 0.31                             |
| 802.11n HT20   | 1.27                 | 1.37                       | 0.93       | 0.33                             |
| 802.11n HT40   | 0.63                 | 0.74                       | 0.85       | 0.70                             |
| 802.11ac VHT20 | 1.27                 | 1.38                       | 0.92       | 0.36                             |
| 802.11ac VHT40 | 0.63                 | 0.74                       | 0.85       | 0.70                             |
| 802.11ac VHT80 | 0.31                 | 0.41                       | 0.76       | 1.21                             |
| 802.11ax HE20  | 0.99                 | 1.09                       | 0.91       | 0.42                             |
| 802.11ax HE40  | 0.52                 | 0.62                       | 0.84       | 0.76                             |
| 802.11ax HE80  | 0.28                 | 0.38                       | 0.74       | 1.33                             |

Note: when Duty cycle  $\geq 0.98$ , Duty cycle correction Factor not required.

Note: Average Power with duty factor = Average Power Measured +Duty cycle correction factor

**SISO Antenna 1**

**U-NII-1**

| Test Mode         | Channel/<br>Frequency<br>(MHz) | Average<br>Power<br>Measured<br>(dBm) | Average<br>Power with<br>duty factor<br>(dBm) | Limit<br>(dBm) | Conclusion |
|-------------------|--------------------------------|---------------------------------------|---|----------------|------------|
| 802.11a           | 36/5180                        | 14.65                                 | 14.96   | 30.00          | PASS       |
|                   | 40/5200                        | 18.13                                 | 18.44   | 30.00          | PASS       |
|                   | 44/5220                        | 20.04                                 | 20.35   | 30.00          | PASS       |
|                   | 48/5240                        | 19.59                                 | 19.90   | 30.00          | PASS       |
| 802.11n<br>HT20   | 36/5180                        | 14.77                                 | 15.10   | 30.00          | PASS       |
|                   | 40/5200                        | 18.32                                 | 18.65   | 30.00          | PASS       |
|                   | 44/5220                        | 20.06                                 | 20.39   | 30.00          | PASS       |
|                   | 48/5240                        | 20.22                                 | 20.55   | 30.00          | PASS       |
| 802.11n<br>HT40   | 38/5190                        | 11.68                                 | 12.38   | 30.00          | PASS       |
|                   | 46/5230                        | 13.57                                 | 14.27   | 30.00          | PASS       |
| 802.11ac<br>VHT20 | 36/5180                        | 14.51                                 | 14.84   | 30.00          | PASS       |
|                   | 40/5200                        | 18.01                                 | 18.34   | 30.00          | PASS       |
|                   | 44/5220                        | 20.32                                 | 20.65   | 30.00          | PASS       |
|                   | 48/5240                        | 20.26                                 | 20.59   | 30.00          | PASS       |
| 802.11ac<br>VHT40 | 38/5190                        | 12.12                                 | 12.76   | 30.00          | PASS       |
|                   | 46/5230                        | 13.95                                 | 14.59   | 30.00          | PASS       |
| 802.11ac VHT80    | 42/5210                        | 10.36                                 | 11.68   | 30.00          | PASS       |
| 802.11ax HE20     | 36/5180                        | 13.95                                 | 14.41   | 30.00          | PASS       |
|                   | 40/5200                        | 18.20                                 | 18.66   | 30.00          | PASS       |
|                   | 44/5220                        | 20.11                                 | 20.57   | 30.00          | PASS       |
|                   | 48/5240                        | 20.47                                 | 20.93   | 30.00          | PASS       |
| 802.11ax HE40     | 38/5190                        | 11.00                                 | 11.76   | 30.00          | PASS       |
|                   | 46/5230                        | 13.46                                 | 14.22   | 30.00          | PASS       |
| 802.11ax HE80     | 42/5210                        | 10.34                                 | 11.67   | 30.00          | PASS       |

Note: Average Power with duty factor = Average Power Measured +Duty cycle correction factor



## U-NII-3

| Network Standards | Channel/<br>Frequency<br>(MHz) | Average<br>Power<br>Measured<br>(dBm) | Average<br>Power with<br>duty factor<br>(dBm) | Limit<br>(dBm) | Conclusion |
|-------------------|--------------------------------|---------------------------------------|---|----------------|------------|
| 802.11a           | 149/5745                       | 20.12                                 | 20.43   | 30.00          | PASS       |
|                   | 165/5825                       | 19.71                                 | 20.02   | 30.00          | PASS       |
| 802.11n<br>HT20   | 149/5745                       | 20.07                                 | 20.40   | 30.00          | PASS       |
|                   | 165/5825                       | 19.75                                 | 20.08   | 30.00          | PASS       |
| 802.11n<br>HT40   | 151/5755                       | 16.84                                 | 17.54   | 30.00          | PASS       |
|                   | 159/5795                       | 18.27                                 | 18.97   | 30.00          | PASS       |
| 802.11ac<br>VHT20 | 149/5745                       | 19.97                                 | 20.30   | 30.00          | PASS       |
|                   | 165/5825                       | 19.68                                 | 20.01   | 30.00          | PASS       |
| 802.11ac<br>VHT40 | 151/5755                       | 16.79                                 | 17.43   | 30.00          | PASS       |
|                   | 159/5795                       | 18.32                                 | 18.96   | 30.00          | PASS       |
| 802.11ac VHT80    | 155/5775                       | 16.22                                 | 17.54   | 30.00          | PASS       |
| 802.11ax HE20     | 149/5745                       | 19.62                                 | 20.08   | 30.00          | PASS       |
|                   | 165/5825                       | 18.80                                 | 19.26   | 30.00          | PASS       |
| 802.11ax HE40     | 151/5755                       | 17.02                                 | 17.78   | 30.00          | PASS       |
|                   | 159/5795                       | 18.75                                 | 19.51   | 30.00          | PASS       |
| 802.11ax HE80     | 155/5775                       | 16.11                                 | 17.44   | 30.00          | PASS       |

Note: Average Power with duty factor = Average Power Measured +Duty cycle correction factor



## SISO Antenna 2

## U-NII-1

| Test Mode         | Channel/<br>Frequency<br>(MHz) | Average<br>Power<br>Measured<br>(dBm) | Average<br>Power with<br>duty factor<br>(dBm) | Limit<br>(dBm) | Conclusion |
|-------------------|--------------------------------|---------------------------------------|---|----------------|------------|
| 802.11a           | 36/5180                        | 14.95                                 | 15.29   | 30.00          | PASS       |
|                   | 40/5200                        | 18.32                                 | 18.66   | 30.00          | PASS       |
|                   | 44/5220                        | 20.32                                 | 20.66   | 30.00          | PASS       |
|                   | 48/5240                        | 19.89                                 | 20.23   | 30.00          | PASS       |
| 802.11n<br>HT20   | 36/5180                        | 15.14                                 | 15.47   | 30.00          | PASS       |
|                   | 40/5200                        | 18.17                                 | 18.50   | 30.00          | PASS       |
|                   | 44/5220                        | 19.96                                 | 20.29   | 30.00          | PASS       |
|                   | 48/5240                        | 20.26                                 | 20.59   | 30.00          | PASS       |
| 802.11n<br>HT40   | 38/5190                        | 12.07                                 | 12.77   | 30.00          | PASS       |
|                   | 46/5230                        | 13.77                                 | 14.47   | 30.00          | PASS       |
| 802.11ac<br>VHT20 | 36/5180                        | 14.97                                 | 15.30   | 30.00          | PASS       |
|                   | 40/5200                        | 18.27                                 | 18.60   | 30.00          | PASS       |
|                   | 44/5220                        | 20.00                                 | 20.33   | 30.00          | PASS       |
|                   | 48/5240                        | 20.04                                 | 20.37   | 30.00          | PASS       |
| 802.11ac<br>VHT40 | 38/5190                        | 12.13                                 | 12.83   | 30.00          | PASS       |
|                   | 46/5230                        | 13.82                                 | 14.52   | 30.00          | PASS       |
| 802.11ac VHT80    | 42/5210                        | 10.02                                 | 11.34   | 30.00          | PASS       |
| 802.11ax HE20     | 36/5180                        | 13.21                                 | 13.63   | 30.00          | PASS       |
|                   | 40/5200                        | 18.23                                 | 18.65   | 30.00          | PASS       |
|                   | 44/5220                        | 19.89                                 | 20.31   | 30.00          | PASS       |
|                   | 48/5240                        | 19.94                                 | 20.36   | 30.00          | PASS       |
| 802.11ax HE40     | 38/5190                        | 10.36                                 | 11.12   | 30.00          | PASS       |
|                   | 46/5230                        | 13.78                                 | 14.54   | 30.00          | PASS       |
| 802.11ax HE80     | 42/5210                        | 10.00                                 | 11.33   | 30.00          | PASS       |

Note: Average Power with duty factor = Average Power Measured +Duty cycle correction factor



## U-NII-3

| Test Mode         | Channel/<br>Frequency<br>(MHz) | Average<br>Power<br>Measured<br>(dBm) | Average<br>Power with<br>duty factor<br>(dBm) | Limit<br>(dBm) | Conclusion |
|-------------------|--------------------------------|---------------------------------------|---|----------------|------------|
| 802.11a           | 149/5745                       | 19.46                                 | 19.80   | 30.00          | PASS       |
|                   | 165/5825                       | 19.36                                 | 19.70   | 30.00          | PASS       |
| 802.11n<br>HT20   | 149/5745                       | 19.35                                 | 19.68   | 30.00          | PASS       |
|                   | 165/5825                       | 19.35                                 | 19.68   | 30.00          | PASS       |
| 802.11n<br>HT40   | 151/5755                       | 16.35                                 | 17.05   | 30.00          | PASS       |
|                   | 159/5795                       | 18.28                                 | 18.98   | 30.00          | PASS       |
| 802.11ac<br>VHT20 | 149/5745                       | 19.74                                 | 20.07   | 30.00          | PASS       |
|                   | 165/5825                       | 19.64                                 | 19.97   | 30.00          | PASS       |
| 802.11ac<br>VHT40 | 151/5755                       | 16.49                                 | 17.19   | 30.00          | PASS       |
|                   | 159/5795                       | 18.41                                 | 19.11   | 30.00          | PASS       |
| 802.11ac VHT80    | 155/5775                       | 16.15                                 | 17.47   | 30.00          | PASS       |
| 802.11ax HE20     | 149/5745                       | 19.60                                 | 20.02   | 30.00          | PASS       |
|                   | 165/5825                       | 18.71                                 | 19.13   | 30.00          | PASS       |
| 802.11ax HE40     | 151/5755                       | 16.70                                 | 17.46   | 30.00          | PASS       |
|                   | 159/5795                       | 18.58                                 | 19.34   | 30.00          | PASS       |
| 802.11ax HE80     | 155/5775                       | 15.88                                 | 17.21   | 30.00          | PASS       |

Note: Average Power with duty factor = Average Power Measured +Duty cycle correction factor



## MIMO with beamforming

## U-NII-1

| Test Mode          | Channel/<br>Frequency<br>(MHz) | MIMO<br>Antenna 1                     |   | MIMO<br>Antenna 2                     |   | Total<br>Power<br>(dBm) | Limit<br>(dBm) | Conclusion |
|--------------------|--------------------------------|---------------------------------------|---|---------------------------------------|---|-------------------------|----------------|------------|
|                    |                                | Average<br>Power<br>Measured<br>(dBm) | Average<br>Power with<br>duty factor<br>(dBm) | Average<br>Power<br>Measured<br>(dBm) | Average<br>Power with<br>duty factor<br>(dBm) |                         |                |            |
| U-NII-1<br>802.11a | 36/5180                        | 14.82                                 | 15.13   | 15.58                                 | 15.89   | 18.54                   | 30.00          | PASS       |
|                    | 40/5200                        | 18.16                                 | 18.47   | 18.85                                 | 19.16   | 21.84                   | 30.00          | PASS       |
|                    | 44/5220                        | 20.01                                 | 20.32   | 20.62                                 | 20.93   | 23.64                   | 30.00          | PASS       |
|                    | 48/5240                        | 19.67                                 | 19.98   | 20.01                                 | 20.32   | 23.16                   | 30.00          | PASS       |
| 802.11n<br>HT20    | 36/5180                        | 14.65                                 | 14.98   | 15.32                                 | 15.65   | 18.34                   | 30.00          | PASS       |
|                    | 40/5200                        | 18.04                                 | 18.37   | 18.66                                 | 18.99   | 21.70                   | 30.00          | PASS       |
|                    | 44/5220                        | 19.85                                 | 20.18   | 20.48                                 | 20.81   | 23.52                   | 30.00          | PASS       |
|                    | 48/5240                        | 19.93                                 | 20.26   | 20.54                                 | 20.87   | 23.59                   | 30.00          | PASS       |
| 802.11n<br>HT40    | 38/5190                        | 11.70                                 | 12.40   | 12.01                                 | 12.71   | 15.57                   | 30.00          | PASS       |
|                    | 46/5230                        | 13.80                                 | 14.50   | 13.95                                 | 14.65   | 17.58                   | 30.00          | PASS       |
| 802.11ac<br>VHT20  | 36/5180                        | 14.66                                 | 14.99   | 15.29                                 | 15.62   | 18.32                   | 30.00          | PASS       |
|                    | 40/5200                        | 18.03                                 | 18.36   | 18.68                                 | 19.01   | 21.70                   | 30.00          | PASS       |
|                    | 44/5220                        | 20.18                                 | 20.51   | 20.79                                 | 21.12   | 23.83                   | 30.00          | PASS       |
|                    | 48/5240                        | 20.05                                 | 20.38   | 20.73                                 | 21.06   | 23.74                   | 30.00          | PASS       |
| 802.11ac<br>VHT40  | 38/5190                        | 12.04                                 | 12.74   | 12.29                                 | 12.99   | 15.88                   | 30.00          | PASS       |
|                    | 46/5230                        | 13.72                                 | 14.42   | 13.96                                 | 14.66   | 17.55                   | 30.00          | PASS       |
| 802.11ac<br>VHT80  | 42/5210                        | 10.32                                 | 11.64   | 10.30                                 | 11.62   | 14.64                   | 30.00          | PASS       |
| 802.11ax<br>HE 20  | 36/5180                        | 13.77                                 | 14.19   | 13.90                                 | 14.32   | 17.26                   | 30.00          | PASS       |
|                    | 40/5200                        | 18.34                                 | 18.76   | 19.02                                 | 19.44   | 22.12                   | 30.00          | PASS       |
|                    | 44/5220                        | 20.20                                 | 20.62   | 20.76                                 | 21.18   | 23.92                   | 30.00          | PASS       |
|                    | 48/5240                        | 20.18                                 | 20.60   | 20.88                                 | 21.30   | 23.97                   | 30.00          | PASS       |
| 802.11ax<br>HE 40  | 38/5190                        | 10.84                                 | 11.60   | 10.82                                 | 11.58   | 14.60                   | 30.00          | PASS       |
|                    | 46/5230                        | 13.52                                 | 14.28   | 13.75                                 | 14.51   | 17.41                   | 30.00          | PASS       |
| 802.11ax<br>HE 80  | 42/5210                        | 10.33                                 | 11.66   | 10.29                                 | 11.62   | 14.65                   | 30.00          | PASS       |

Note: 1. For Total Power, according to KDB 662911 D01 Multiple Transmitter Output v02r01 1),

The Total Power =  $10\log(10^{(\text{Power antenna1 in dBm}/10)} + 10^{(\text{Power antenna2 in dBm}/10)})$ .

2. The manufacturer declared the transmitter output signals is CDD mode And  $N_{ss}=1$ . According to KDB 662911 D01

Multiple Transmitter Output v02r01 2)f)(i): If all antennas have the same gain, Directional gain =  $G_{ANT} + \text{Array Gain}$ ,

For power measurements on IEEE 802.11 devices,

Array Gain = 0 dB (i.e., no array gain) for  $N_{ANT} \leq 4$ ;





Array Gain = 0 dB (i.e., no array gain) for channel widths  $\geq 40$  MHz for any  $N_{ANT}$ ;

Array Gain =  $5 \log(N_{ANT}/N_{SS})$  dB or 3 dB, whichever is less, for 20-MHz channel widths with  $N_{ANT} \geq 5$ .

So directional gain =  $G_{ANT} + \text{Array Gain} = 5 + 0 = 5$  dBi  $< 6$  dBi. So the power limit is 30dBm.

## U-NII-3

| Test Mode        | Channel/<br>Frequency<br>(MHz) | MIMO<br>Antenna 1                     |   | MIMO<br>Antenna 2                     |   | Total<br>Power<br>(dBm) | Limit<br>(dBm) | Conclusion |
|------------------|--------------------------------|---------------------------------------|---|---------------------------------------|---|-------------------------|----------------|------------|
|                  |                                | Average<br>Power<br>Measured<br>(dBm) | Average<br>Power with<br>duty factor<br>(dBm) | Average<br>Power<br>Measured<br>(dBm) | Average<br>Power with<br>duty factor<br>(dBm) |                         |                |            |
| 802.11a          | 149/5745                       | 18.73                                 | 19.04   | 19.08                                 | 19.39   | 22.23                   | 30.00          | PASS       |
|                  | 165/5825                       | 18.55                                 | 18.86   | 18.79                                 | 19.10   | 21.99                   | 30.00          | PASS       |
| 802.11n<br>HT20  | 149/5745                       | 19.76                                 | 20.09   | 19.95                                 | 20.28   | 23.20                   | 30.00          | PASS       |
|                  | 165/5825                       | 19.45                                 | 19.78   | 19.76                                 | 20.09   | 22.95                   | 30.00          | PASS       |
| 802.11n<br>HT40  | 151/5755                       | 16.33                                 | 17.03   | 16.45                                 | 17.15   | 20.10                   | 30.00          | PASS       |
|                  | 159/5795                       | 18.56                                 | 19.26   | 18.68                                 | 19.38   | 22.33                   | 30.00          | PASS       |
| 802.11ac<br>HT20 | 149/5745                       | 19.86                                 | 20.19   | 20.03                                 | 20.36   | 23.28                   | 30.00          | PASS       |
|                  | 165/5825                       | 19.57                                 | 19.90   | 19.79                                 | 20.12   | 23.02                   | 30.00          | PASS       |
| 802.11ac<br>HT40 | 151/5755                       | 16.31                                 | 17.01   | 16.37                                 | 17.07   | 20.05                   | 30.00          | PASS       |
|                  | 159/5795                       | 18.43                                 | 19.13   | 18.52                                 | 19.22   | 22.18                   | 30.00          | PASS       |
| 802.11ac<br>HT80 | 155/5775                       | 16.44                                 | 17.76   | 16.37                                 | 17.69   | 20.73                   | 30.00          | PASS       |
| 802.11ax<br>HT20 | 149/5745                       | 19.80                                 | 20.22   | 20.02                                 | 20.44   | 23.34                   | 30.00          | PASS       |
|                  | 165/5825                       | 18.96                                 | 19.38   | 19.22                                 | 19.64   | 22.52                   | 30.00          | PASS       |
| 802.11ax<br>HT40 | 151/5755                       | 16.71                                 | 17.47   | 16.61                                 | 17.37   | 20.43                   | 30.00          | PASS       |
|                  | 159/5795                       | 18.81                                 | 19.57   | 18.71                                 | 19.47   | 22.53                   | 30.00          | PASS       |
| 802.11ax<br>HT80 | 155/5775                       | 14.54                                 | 15.87   | 14.49                                 | 15.82   | 18.85                   | 30.00          | PASS       |

Note: 1. For Total Power, according to KDB 662911 D01 Multiple Transmitter Output v02r01 1),

The Total Power =  $10 \log(10^{(\text{Power antenna1 in dBm}/10)} + 10^{(\text{Power antenna2 in dBm}/10)})$ .

2. The manufacturer declared the transmitter output signals is CDD mode And  $N_{SS}=1$ . According to KDB 662911 D01 Multiple Transmitter Output v02r01 2)f)(i): If all antennas have the same gain, Directional gain =  $G_{ANT} + \text{Array Gain}$ ,

For power measurements on IEEE 802.11 devices,

Array Gain = 0 dB (i.e., no array gain) for  $N_{ANT} \leq 4$ ;

Array Gain = 0 dB (i.e., no array gain) for channel widths  $\geq 40$  MHz for any  $N_{ANT}$ ;

Array Gain =  $5 \log(N_{ANT}/N_{SS})$  dB or 3 dB, whichever is less, for 20-MHz channel widths with  $N_{ANT} \geq 5$ .

So directional gain =  $G_{ANT} + \text{Array Gain} = 5 + 0 = 5$  dBi  $< 6$  dBi. So the power limit is 30dBm.



## MIMO without beamforming

## U-NII-1

| Test Mode          | Channel/<br>Frequency<br>(MHz) | MIMO<br>Antenna 1                     |   | MIMO<br>Antenna 2                     |   | Total<br>Power<br>(dBm) | Limit<br>(dBm) | Conclusion |
|--------------------|--------------------------------|---------------------------------------|---|---------------------------------------|---|-------------------------|----------------|------------|
|                    |                                | Average<br>Power<br>Measured<br>(dBm) | Average<br>Power with<br>duty factor<br>(dBm) | Average<br>Power<br>Measured<br>(dBm) | Average<br>Power with<br>duty factor<br>(dBm) |                         |                |            |
| U-NII-1<br>802.11a | 36/5180                        | 14.71                                 | 15.02   | 15.34                                 | 15.65   | 18.35                   | 30.00          | PASS       |
|                    | 40/5200                        | 18.01                                 | 18.32   | 18.76                                 | 19.07   | 21.72                   | 30.00          | PASS       |
|                    | 44/5220                        | 19.89                                 | 20.20   | 20.46                                 | 20.77   | 23.50                   | 30.00          | PASS       |
|                    | 48/5240                        | 19.58                                 | 19.89   | 19.96                                 | 20.27   | 23.09                   | 30.00          | PASS       |
| 802.11n<br>HT20    | 36/5180                        | 14.66                                 | 14.99   | 15.30                                 | 15.63   | 18.33                   | 30.00          | PASS       |
|                    | 40/5200                        | 18.00                                 | 18.33   | 18.66                                 | 18.99   | 21.68                   | 30.00          | PASS       |
|                    | 44/5220                        | 19.85                                 | 20.18   | 20.41                                 | 20.74   | 23.48                   | 30.00          | PASS       |
|                    | 48/5240                        | 20.07                                 | 20.40   | 20.66                                 | 20.99   | 23.71                   | 30.00          | PASS       |
| 802.11n<br>HT40    | 38/5190                        | 11.73                                 | 12.43   | 11.90                                 | 12.60   | 15.53                   | 30.00          | PASS       |
|                    | 46/5230                        | 13.70                                 | 14.40   | 13.84                                 | 14.54   | 17.48                   | 30.00          | PASS       |
| 802.11ac<br>VHT20  | 36/5180                        | 14.75                                 | 15.11   | 15.30                                 | 15.66   | 18.40                   | 30.00          | PASS       |
|                    | 40/5200                        | 17.94                                 | 18.30   | 18.59                                 | 18.95   | 21.65                   | 30.00          | PASS       |
|                    | 44/5220                        | 20.05                                 | 20.41   | 20.60                                 | 20.96   | 23.70                   | 30.00          | PASS       |
|                    | 48/5240                        | 20.05                                 | 20.41   | 20.68                                 | 21.04   | 23.75                   | 30.00          | PASS       |
| 802.11ac<br>VHT40  | 38/5190                        | 11.97                                 | 12.67   | 12.24                                 | 12.94   | 15.82                   | 30.00          | PASS       |
|                    | 46/5230                        | 13.67                                 | 14.37   | 13.86                                 | 14.56   | 17.48                   | 30.00          | PASS       |
| 802.11ac<br>VHT80  | 42/5210                        | 10.29                                 | 11.50   | 10.34                                 | 11.55   | 14.54                   | 30.00          | PASS       |
| 802.11ax<br>HE 20  | 36/5180                        | 13.72                                 | 14.14   | 13.90                                 | 14.32   | 17.24                   | 30.00          | PASS       |
|                    | 40/5200                        | 18.12                                 | 18.54   | 18.74                                 | 19.16   | 21.87                   | 30.00          | PASS       |
|                    | 44/5220                        | 19.96                                 | 20.38   | 20.54                                 | 20.96   | 23.69                   | 30.00          | PASS       |
|                    | 48/5240                        | 19.98                                 | 20.40   | 20.61                                 | 21.03   | 23.73                   | 30.00          | PASS       |
| 802.11ax<br>HE 40  | 38/5190                        | 10.78                                 | 11.54   | 10.82                                 | 11.58   | 14.57                   | 30.00          | PASS       |
|                    | 46/5230                        | 13.33                                 | 14.09   | 13.50                                 | 14.26   | 17.19                   | 30.00          | PASS       |
| 802.11ax<br>HE 80  | 42/5210                        | 10.27                                 | 11.60   | 10.22                                 | 11.55   | 14.58                   | 30.00          | PASS       |

Note: 1. For Total Power, according to KDB 662911 D01 Multiple Transmitter Output v02r01 1),

The Total Power =  $10\log(10^{(\text{Power antenna1 in dBm}/10)} + 10^{(\text{Power antenna2 in dBm}/10)})$ .

2. The manufacturer declared the transmitter output signals is CDD mode And  $N_{ss}=1$ . According to KDB 662911 D01

Multiple Transmitter Output v02r01 2)f)(i): If all antennas have the same gain, Directional gain =  $G_{ANT} + \text{Array Gain}$ ,

For power measurements on IEEE 802.11 devices,

Array Gain = 0 dB (i.e., no array gain) for  $N_{ANT} \leq 4$ ;



Array Gain = 0 dB (i.e., no array gain) for channel widths  $\geq 40$  MHz for any  $N_{ANT}$ ;

Array Gain =  $5 \log(N_{ANT}/N_{SS})$  dB or 3 dB, whichever is less, for 20-MHz channel widths with  $N_{ANT} \geq 5$ .

So directional gain =  $G_{ANT} + \text{Array Gain} = 5 + 0 = 5$  dBi  $< 6$  dBi. So the power limit is 30dBm.

## U-NII-3

| Test Mode        | Channel/<br>Frequency<br>(MHz) | MIMO<br>Antenna 1                     |   | MIMO<br>Antenna 2                     |   | Total<br>Power<br>(dBm) | Limit<br>(dBm) | Conclusion |
|------------------|--------------------------------|---------------------------------------|---|---------------------------------------|---|-------------------------|----------------|------------|
|                  |                                | Average<br>Power<br>Measured<br>(dBm) | Average<br>Power with<br>duty factor<br>(dBm) | Average<br>Power<br>Measured<br>(dBm) | Average<br>Power with<br>duty factor<br>(dBm) |                         |                |            |
| 802.11a          | 149/5745                       | 19.87                                 | 20.18   | 20.09                                 | 20.40   | 23.30                   | 30.00          | PASS       |
|                  | 165/5825                       | 19.58                                 | 19.89   | 19.83                                 | 20.14   | 23.03                   | 30.00          | PASS       |
| 802.11n<br>HT20  | 149/5745                       | 19.71                                 | 20.04   | 19.84                                 | 20.17   | 23.11                   | 30.00          | PASS       |
|                  | 165/5825                       | 19.44                                 | 19.77   | 19.73                                 | 20.06   | 22.93                   | 30.00          | PASS       |
| 802.11n<br>HT40  | 151/5755                       | 16.57                                 | 17.27   | 16.62                                 | 17.32   | 20.30                   | 30.00          | PASS       |
|                  | 159/5795                       | 18.72                                 | 19.42   | 18.65                                 | 19.35   | 22.39                   | 30.00          | PASS       |
| 802.11ac<br>HT20 | 149/5745                       | 19.64                                 | 20.00   | 19.72                                 | 20.08   | 23.05                   | 30.00          | PASS       |
|                  | 165/5825                       | 19.45                                 | 19.81   | 19.64                                 | 20.00   | 22.92                   | 30.00          | PASS       |
| 802.11ac<br>HT40 | 151/5755                       | 16.39                                 | 17.09   | 16.48                                 | 17.18   | 20.14                   | 30.00          | PASS       |
|                  | 159/5795                       | 18.52                                 | 19.22   | 18.56                                 | 19.26   | 22.25                   | 30.00          | PASS       |
| 802.11ac<br>HT80 | 155/5775                       | 16.29                                 | 17.50   | 16.23                                 | 17.44   | 20.48                   | 30.00          | PASS       |
| 802.11ax<br>HT20 | 149/5745                       | 19.54                                 | 19.96   | 19.67                                 | 20.09   | 23.03                   | 30.00          | PASS       |
|                  | 165/5825                       | 18.90                                 | 19.32   | 19.22                                 | 19.64   | 22.49                   | 30.00          | PASS       |
| 802.11ax<br>HT40 | 151/5755                       | 16.85                                 | 17.61   | 16.65                                 | 17.41   | 20.53                   | 30.00          | PASS       |
|                  | 159/5795                       | 18.86                                 | 19.62   | 18.80                                 | 19.56   | 22.60                   | 30.00          | PASS       |
| 802.11ax<br>HT80 | 155/5775                       | 16.45                                 | 17.78   | 16.28                                 | 17.61   | 20.70                   | 30.00          | PASS       |

Note: 1. For Total Power, according to KDB 662911 D01 Multiple Transmitter Output v02r01 1),

The Total Power =  $10 \log(10^{(\text{Power antenna1 in dBm}/10)} + 10^{(\text{Power antenna2 in dBm}/10)})$ .

2. The manufacturer declared the transmitter output signals is CDD mode And  $N_{SS}=1$ . According to KDB 662911 D01 Multiple Transmitter Output v02r01 2)f)(i): If all antennas have the same gain, Directional gain =  $G_{ANT} + \text{Array Gain}$ ,

For power measurements on IEEE 802.11 devices,

Array Gain = 0 dB (i.e., no array gain) for  $N_{ANT} \leq 4$ ;

Array Gain = 0 dB (i.e., no array gain) for channel widths  $\geq 40$  MHz for any  $N_{ANT}$ ;

Array Gain =  $5 \log(N_{ANT}/N_{SS})$  dB or 3 dB, whichever is less, for 20-MHz channel widths with  $N_{ANT} \geq 5$ .

So directional gain =  $G_{ANT} + \text{Array Gain} = 5 + 0 = 5$  dBi  $< 6$  dBi. So the power limit is 30dBm.

### 5.3. Frequency Stability

#### Ambient condition

| Temperature | Relative humidity | Pressure |
|-------------|-------------------|----------|
| 23°C ~25°C  | 45%~50%           | 101.5kPa |

#### Method of Measurement

##### 1. Frequency stability with respect to ambient temperature

a) Supply the EUT with a nominal ac voltage or install a new or fully charged battery in the EUT. If possible, a dummy load shall be connected to the EUT because an antenna near the metallic walls of an environmental test chamber could affect the output frequency of the EUT. If the EUT is equipped with a permanently attached, adjustable-length antenna, then the EUT shall be placed in the center of the chamber with the antenna adjusted to the shortest length possible. Turn ON the EUT and tune it to one of the number of frequencies shown in 5.6.

b) Couple the unlicensed wireless device output to the measuring instrument by connecting an antenna to the measuring instrument with a suitable length of coaxial cable and placing the measuring antenna near the EUT (e.g., 15 cm away), or by connecting a dummy load to the measuring instrument, through an attenuator if necessary.

c) Adjust the location of the measurement antenna and the controls on the measurement instrument to obtain a suitable signal level (i.e., a level that will not overload the measurement instrument but is strong enough to allow measurement of the operating or fundamental frequency of the EUT).

d) Turn the EUT OFF and place it inside the environmental temperature chamber. For devices that have oscillator heaters, energize only the heater circuit.

e) Set the temperature control on the chamber to the highest specified in the regulatory requirements for the type of device and allow the oscillator heater and the chamber temperature to stabilize.

f) While maintaining a constant temperature inside the environmental chamber, turn the EUT ON and record the operating frequency at startup, and at 2 minutes, 5 minutes, and 10 minutes after the EUT is energized. Four measurements in total are made.

g) Measure the frequency at each of frequencies specified in 5.6.

h) Switch OFF the EUT but do not switch OFF the oscillator heater.

i) Lower the chamber temperature by not more than 10°C, and allow the temperature inside the chamber to stabilize.

j) Repeat step f) through step i) down to the lowest specified temperature.

##### 2. Frequency stability when varying supply voltage

Unless otherwise specified, these tests shall be made at ambient room temperature (+15°C to +25 °C). An antenna shall be connected to the antenna output terminals of the EUT if possible. If the EUT is equipped with or uses an adjustable-length antenna, then it shall be fully extended.

a) Supply the EUT with nominal voltage or install a new or fully charged battery in the EUT. Turn ON the EUT and couple its output to a frequency counter or other frequency-measuring instrument.



- b) Tune the EUT to one of the number of frequencies required in 5.6. Adjust the location of the measurement antenna and the controls on the measurement instrument to obtain a suitable signal level (i.e., a level that will not overload the measurement instrument but is strong enough to allow measurement of the operating or fundamental frequency of the EUT).
- c) Measure the frequency at each of the frequencies specified in 5.6.
- d) Repeat the above procedure at 85% and 115% of the nominal supply voltage.

**Limit**

Manufacturers of U-NII devices are responsible for ensuring frequency stability such that an emission is maintained within the band of operation under all conditions of normal operation as specified in the users manual.

**Measurement Uncertainty**

The assessed measurement uncertainty to ensure 95% confidence level for the normal distribution is with the coverage factor  $k = 2$ ,  $U = 936\text{Hz}$

**Test Results**

| Voltage (V)      | Temperature (°C) | U-NII-1 Test Results |             |             |             |
|------------------|------------------|----------------------|-------------|-------------|-------------|
|                  |                  | 5200MHz              |             |             |             |
|                  |                  | 1min                 | 2min        | 5min        | 10min       |
| 12               | -20              | 5199.991109          | 5199.982812 | 5199.979666 | 5199.975256 |
| 12               | -10              | 5199.999787          | 5199.981301 | 5199.975178 | 5199.971668 |
| 12               | 0                | 5199.998069          | 5199.980823 | 5199.971795 | 5199.970378 |
| 12               | 10               | 5199.997140          | 5199.980041 | 5199.967363 | 5199.960959 |
| 12               | 20               | 5199.990564          | 5199.973366 | 5199.958880 | 5199.955212 |
| 12               | 30               | 5199.982715          | 5199.968923 | 5199.953988 | 5199.954769 |
| 12               | 40               | 5199.981527          | 5199.964900 | 5199.947941 | 5199.949935 |
| 12               | 50               | 5199.977591          | 5199.958884 | 5199.940924 | 5199.947831 |
| 11.4             | 20               | 5199.976751          | 5199.951583 | 5199.937686 | 5199.942647 |
| 12.6             | 20               | 5199.968854          | 5199.950704 | 5199.932336 | 5199.942368 |
| Max $\Delta$ MHz |                  | -0.031146            | -0.049296   | -0.067664   | -0.057632   |
| PPM              |                  | -5.989632            | -9.479956   | -13.012267  | -11.083050  |

| Voltage (V)      | Temperature (°C) | U-NII-3 Test Results |             |             |             |
|------------------|------------------|----------------------|-------------|-------------|-------------|
|                  |                  | 5785MHz              |             |             |             |
|                  |                  | 1min                 | 2min        | 5min        | 10min       |
| 12               | -20              | 5784.994516          | 5784.986466 | 5784.981190 | 5784.975293 |
| 12               | -10              | 5784.987087          | 5784.977933 | 5784.972502 | 5784.972728 |
| 12               | 0                | 5784.985824          | 5784.970332 | 5784.968388 | 5784.963267 |
| 12               | 10               | 5784.977316          | 5784.964517 | 5784.961800 | 5784.954742 |
| 12               | 20               | 5784.972394          | 5784.959448 | 5784.960645 | 5784.954648 |
| 12               | 30               | 5784.964791          | 5784.957281 | 5784.960629 | 5784.945059 |
| 12               | 40               | 5784.959179          | 5784.953693 | 5784.955488 | 5784.940510 |
| 12               | 50               | 5784.953823          | 5784.948078 | 5784.948029 | 5784.938662 |
| 11.4             | 20               | 5784.951253          | 5784.944360 | 5784.945901 | 5784.933468 |
| 12.6             | 20               | 5784.944959          | 5784.934452 | 5784.939520 | 5784.925323 |
| Max $\Delta$ MHz |                  | -0.055041            | -0.065548   | -0.060480   | -0.074677   |
| PPM              |                  | -9.514501            | -11.330597  | -10.454661  | -12.908681  |

## 5.4. Power Spectral Density

### Ambient condition

| Temperature | Relative humidity | Pressure |
|-------------|-------------------|----------|
| 23°C ~25°C  | 45%~50%           | 101.5kPa |

### Method of Measurement

The EUT was connected to the spectrum analyzer through an external attenuator (20dB) and a known loss cable.

Set RBW = 1MHz, VBW =3MHz for the band 5.150-5.250GHz.

Set RBW = 470kHz, VBW =1.5MHz for the band 5.725-5.850GHz

The conducted PSD is measured at each antenna port. The measured results at the various antenna ports are then summed mathematically.

### Test setup

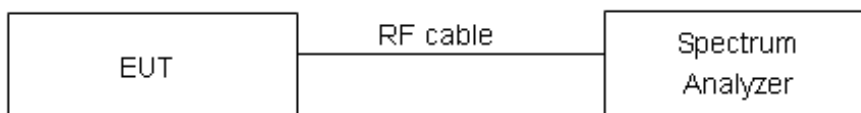

### Limits

Rule FCC Part 15.407(a)(1)/ Part 15.407(a)(2) / Part 15.407(a)(3)

For an indoor access point operating in the band 5.15-5.25 GHz, the maximum power spectral density shall not exceed 17 dBm in any 1 megahertz band. If transmitting antennas of directional gain greater than 6 dBi are used, both the maximum conducted output power and the maximum power spectral density shall be reduced by the amount in dB that the directional gain of the antenna exceeds 6 dBi.

For client devices in the 5.15-5.25 GHz band, the maximum conducted output power over the frequency band of operation shall not exceed 250 mW provided the maximum antenna gain does not exceed 6 dBi. In addition, the maximum power spectral density shall not exceed 11 dBm in any 1 megahertz band. If transmitting antennas of directional gain greater than 6 dBi are used, both the maximum conducted output power and the maximum power spectral density shall be reduced by the amount in dB that the directional gain of the antenna exceeds 6 dBi.

For the band 5.725-5.85 GHz, the maximum power spectral density shall not exceed 30 dBm in any 500kHz band. If transmitting antennas of directional gain greater than 6 dBi are used, both the maximum conducted output power and the maximum power spectral density shall be reduced by the amount in dB that the directional gain of the antenna exceeds 6 dBi.

| Frequency Bands/MHz | Limits       |
|---------------------|--------------|
| 5150-5250           | 17 dBm/MHz   |
| 5725-5850           | 30dBm/500kHz |



## Measurement Uncertainty

The assessed measurement uncertainty to ensure 95% confidence level for the normal distribution is with the coverage factor  $k = 2$ ,  $U = 0.75\text{dB}$ .



**Test Results:****SISO Antenna 1****U-NII-1**

| Mode              | Channel Number | Power Spectral Density (dBm /MHz) | Limit (dBm /MHz) | Conclusion |
|-------------------|----------------|-----------------------------------|------------------|------------|
| 802.11a           | 36             | 3.97                              | 17               | PASS       |
|                   | 40             | 7.49                              | 17               | PASS       |
|                   | 44             | 9.84                              | 17               | PASS       |
|                   | 48             | 8.87                              | 17               | PASS       |
| 802.11n<br>HT20   | 36             | 3.99                              | 17               | PASS       |
|                   | 40             | 7.57                              | 17               | PASS       |
|                   | 44             | 9.02                              | 17               | PASS       |
|                   | 48             | 9.41                              | 17               | PASS       |
| 802.11n<br>HT40   | 38             | -1.88                             | 17               | PASS       |
|                   | 46             | -0.17                             | 17               | PASS       |
| 802.11ac<br>VHT20 | 36             | 3.74                              | 17               | PASS       |
|                   | 40             | 7.09                              | 17               | PASS       |
|                   | 44             | 9.16                              | 17               | PASS       |
|                   | 48             | 9.43                              | 17               | PASS       |
| 802.11ac<br>VHT40 | 38             | -1.40                             | 17               | PASS       |
|                   | 46             | 0.36                              | 17               | PASS       |
| 802.11ac<br>VHT80 | 42             | -5.24                             | 17               | PASS       |
| 802.11ax<br>HE20  | 36             | 3.02                              | 17               | PASS       |
|                   | 40             | 7.43                              | 17               | PASS       |
|                   | 44             | 9.22                              | 17               | PASS       |
|                   | 48             | 9.77                              | 17               | PASS       |
| 802.11ax<br>HE 40 | 38             | -2.55                             | 17               | PASS       |
|                   | 46             | -0.03                             | 17               | PASS       |
| 802.11ax HE80     | 42             | -5.68                             | 17               | PASS       |

Note: Offset already includes Duty cycle correction factor, so all read value in test plots are already the final results of the Power Spectral Density.



## U-NII-3

| Mode              | Channel Number | PSD(dBm/470kHz) | PSD(dBm/500kHz) | Limit (dBm/500kHz) | Conclusion |
|-------------------|----------------|-----------------|-----------------|--------------------|------------|
| 802.11a           | 149            | 6.10            | 6.37            | 30                 | PASS       |
|                   | 165            | 5.70            | 5.97            | 30                 | PASS       |
| 802.11n<br>HT20   | 149            | 6.10            | 6.37            | 30                 | PASS       |
|                   | 165            | 5.67            | 5.94            | 30                 | PASS       |
| 802.11n<br>HT40   | 151            | 2.09            | 2.36            | 30                 | PASS       |
|                   | 159            | 3.71            | 3.98            | 30                 | PASS       |
| 802.11ac<br>VHT20 | 149            | 6.27            | 6.54            | 30                 | PASS       |
|                   | 165            | 5.58            | 5.85            | 30                 | PASS       |
| 802.11ac<br>VHT40 | 151            | 2.18            | 2.45            | 30                 | PASS       |
|                   | 159            | 3.50            | 3.77            | 30                 | PASS       |
| 802.11ac<br>VHT80 | 155            | -2.72           | -2.45           | 30                 | PASS       |
| 802.11ax<br>HE20  | 149            | 5.88            | 6.15            | 30                 | PASS       |
|                   | 165            | 4.80            | 5.07            | 30                 | PASS       |
| 802.11ax<br>HE40  | 151            | 0.70            | 0.34            | 30                 | PASS       |
|                   | 159            | 1.92            | 2.19            | 30                 | PASS       |
| 802.11ax HE80     | 155            | -2.83           | -2.56           | 30                 | PASS       |

Note:1. Offset already includes Duty cycle correction factor, so all read value in test plots are already the final results of the Power Spectral Density.  
2.  $PSD(dBm/500kHz) = RSD(dBm/470kHz) + 10 * \log_{10}(500/470)$   
 $10 * \log_{10}(500/470) = 0.27$



## SISO Antenna 2

## U-NII-1

| Mode              | Channel Number | Power Spectral Density (dBm /MHz) | Limit (dBm /MHz) | Conclusion |
|-------------------|----------------|-----------------------------------|------------------|------------|
| 802.11a           | 36             | 4.54                              | 17               | PASS       |
|                   | 40             | 7.91                              | 17               | PASS       |
|                   | 44             | 9.65                              | 17               | PASS       |
|                   | 48             | 9.20                              | 17               | PASS       |
| 802.11n<br>HT20   | 36             | 4.35                              | 17               | PASS       |
|                   | 40             | 7.44                              | 17               | PASS       |
|                   | 44             | 9.07                              | 17               | PASS       |
|                   | 48             | 9.29                              | 17               | PASS       |
| 802.11n<br>HT40   | 38             | -1.73                             | 17               | PASS       |
|                   | 46             | 0.29                              | 17               | PASS       |
| 802.11ac<br>VHT20 | 36             | 4.15                              | 17               | PASS       |
|                   | 40             | 7.30                              | 17               | PASS       |
|                   | 44             | 9.30                              | 17               | PASS       |
|                   | 48             | 9.14                              | 17               | PASS       |
| 802.11ac<br>VHT40 | 38             | -1.56                             | 17               | PASS       |
|                   | 46             | 0.17                              | 17               | PASS       |
| 802.11ac<br>VHT80 | 42             | -5.56                             | 17               | PASS       |
| 802.11ax<br>HE20  | 36             | 2.44                              | 17               | PASS       |
|                   | 40             | 7.24                              | 17               | PASS       |
|                   | 44             | 9.07                              | 17               | PASS       |
|                   | 48             | 8.87                              | 17               | PASS       |
| 802.11ax<br>HE 40 | 38             | -3.13                             | 17               | PASS       |
|                   | 46             | -0.01                             | 17               | PASS       |
| 802.11ax<br>HE80  | 42             | -5.20                             | 17               | PASS       |

Note: Offset already includes Duty cycle correction factor, so all read value in test plots are already the final results of the Power Spectral Density.



## U-NII-3

| Mode              | Channel Number | PSD(dBm/470kHz) | PSD(dBm/500kHz) | Limit (dBm/500kHz) | Conclusion |
|-------------------|----------------|-----------------|-----------------|--------------------|------------|
| 802.11a           | 149            | 5.22            | 5.49            | 30                 | PASS       |
|                   | 165            | 5.61            | 5.88            | 30                 | PASS       |
| 802.11n<br>HT20   | 149            | 5.22            | 5.49            | 30                 | PASS       |
|                   | 165            | 5.07            | 5.34            | 30                 | PASS       |
| 802.11n<br>HT40   | 151            | 1.92            | 2.19            | 30                 | PASS       |
|                   | 159            | 3.43            | 3.70            | 30                 | PASS       |
| 802.11ac<br>VHT20 | 149            | 5.41            | 5.68            | 30                 | PASS       |
|                   | 165            | 5.66            | 5.93            | 30                 | PASS       |
| 802.11ac<br>VHT40 | 151            | 1.90            | 2.17            | 30                 | PASS       |
|                   | 159            | 2.82            | 3.09            | 30                 | PASS       |
| 802.11ac<br>VHT80 | 155            | -3.02           | -2.75           | 30                 | PASS       |
| 802.11ax<br>HE20  | 149            | 5.34            | 5.61            | 30                 | PASS       |
|                   | 165            | 4.73            | 5.00            | 30                 | PASS       |
| 802.11ax<br>HE40  | 151            | 0.17            | 0.44            | 30                 | PASS       |
|                   | 159            | 2.06            | 2.33            | 30                 | PASS       |
| 802.11ax HE80     | 155            | -2.91           | -2.64           | 30                 | PASS       |

Note: 1. Offset already includes Duty cycle correction factor, so all read value in test plots are already the final results of the Power Spectral Density.  
2.  $PSD(dBm/500kHz) = RSD(dBm/470kHz) + 10 * \log_{10}(500/470)$   
 $10 * \log_{10}(500/470) = 0.27$

**MIMO with Beamforming****U-NII-1**

| Mode              | Channel/<br>Frequency<br>(MHz) | Power Spectral Density |              |                            | Limit<br>(dBm<br>/MHz) | Conclusion |
|-------------------|--------------------------------|------------------------|--------------|----------------------------|------------------------|------------|
|                   |                                | Antenna 1              | Antenna 2    | Total PSD<br>(dBm<br>/MHz) |                        |            |
|                   |                                | PSD(dBm/MHz)           | PSD(dBm/MHz) |                            |                        |            |
| 802.11a           | 36/5180                        | 4.24                   | 4.94         | 7.61                       | 14.99                  | PASS       |
|                   | 40/5200                        | 7.36                   | 8.23         | 10.83                      | 14.99                  | PASS       |
|                   | 44/5220                        | 9.46                   | 10.07        | 12.78                      | 14.99                  | PASS       |
|                   | 48/5240                        | 9.05                   | 9.46         | 12.27                      | 14.99                  | PASS       |
| 802.11n<br>HT20   | 36/5180                        | 3.85                   | 4.36         | 7.12                       | 14.99                  | PASS       |
|                   | 40/5200                        | 7.06                   | 7.93         | 10.53                      | 14.99                  | PASS       |
|                   | 44/5220                        | 9.13                   | 9.53         | 12.34                      | 14.99                  | PASS       |
|                   | 48/5240                        | 9.14                   | 9.65         | 12.41                      | 14.99                  | PASS       |
| 802.11n<br>HT40   | 38/5190                        | -1.82                  | -1.33        | 1.44                       | 14.99                  | PASS       |
|                   | 46/5230                        | 0.09                   | 0.70         | 3.41                       | 14.99                  | PASS       |
| 802.11ac<br>VHT20 | 36/5180                        | 3.91                   | 4.47         | 7.21                       | 14.99                  | PASS       |
|                   | 40/5200                        | 7.19                   | 7.80         | 10.51                      | 14.99                  | PASS       |
|                   | 44/5220                        | 9.40                   | 9.78         | 12.60                      | 14.99                  | PASS       |
|                   | 48/5240                        | 9.11                   | 9.90         | 12.53                      | 14.99                  | PASS       |
| 802.11ac<br>VHT40 | 38/5190                        | -1.21                  | -1.61        | 1.60                       | 14.99                  | PASS       |
|                   | 46/5230                        | 0.04                   | 0.33         | 3.20                       | 14.99                  | PASS       |
| 802.11ac<br>VHT80 | 42/5210                        | -5.30                  | -5.29        | -2.29                      | 14.99                  | PASS       |
| 802.11ax<br>HE20  | 36/5180                        | 4.03                   | 3.75         | 6.91                       | 14.99                  | PASS       |
|                   | 40/5200                        | 7.60                   | 8.19         | 10.91                      | 14.99                  | PASS       |
|                   | 44/5220                        | 9.33                   | 9.79         | 12.57                      | 14.99                  | PASS       |
|                   | 48/5240                        | 9.26                   | 10.02        | 12.66                      | 14.99                  | PASS       |
| 802.11ax<br>HE40  | 38/5190                        | -3.02                  | -2.65        | 0.18                       | 14.99                  | PASS       |
|                   | 46/5230                        | -0.20                  | 0.02         | 2.93                       | 14.99                  | PASS       |
| 802.11ax<br>HE80  | 42/5210                        | -4.76                  | -5.68        | -2.19                      | 14.99                  | PASS       |

Note: 1. Offset already includes Duty cycle correction factor, so all read value in test plots are already the final results of the Power Spectral Density.

2. For Total PSD, according to KDB 662911 D01 Multiple Transmitter Output v02r01 2)a), the power spectral density= $10\log(10^{(\text{PSD antenna1 in dBm}/10)} + 10^{(\text{PSD antenna2 in dBm}/10)})$

3. The manufacturer declared the transmitter output signals is CDD mode And Nss=1. According to KDB 662911 D01 Multiple Transmitter Output v02r01 2)e)(i): If all antennas have the same gain, Directional gain = GANT + Array Gain, For PSD measurements on all devices, Array Gain= $10\log(\text{Nant}/\text{Nss})\text{dB}$ , so directional gain=GANT+Array Gain= $5+10\log(2/1)=8.01>6\text{ dBi}$ . So the PSD limit is  $17-(\text{directional gain}-6\text{ dBi})=17-(8.01-6)=14.99\text{ dBm}$ .



## U-NII-3

| Mode              | Channel/<br>Frequency<br>(MHz) | Power Spectral Density |                     |                     |                     | Total<br>PSD<br>(dBm<br>/500kHz) | Limit<br>(dBm<br>/500kHz) | Conclusion |
|-------------------|--------------------------------|------------------------|---------------------|---------------------|---------------------|----------------------------------|---------------------------|------------|
|                   |                                | Antenna 1              |                     | Antenna 2           |                     |                                  |                           |            |
|                   |                                | PSD(dBm/<br>470kHz)    | PSD(dBm/<br>500kHz) | PSD(dBm/<br>470kHz) | PSD(dBm/<br>500kHz) |                                  |                           |            |
| 802.11a           | 149/5745                       | 5.14                   | 5.41                | 5.30                | 5.57                | 8.50                             | 27.99                     | PASS       |
|                   | 165/5825                       | 4.47                   | 4.74                | 4.99                | 5.26                | 8.02                             | 27.99                     | PASS       |
| 802.11n<br>HT20   | 149/5745                       | 6.11                   | 6.38                | 5.99                | 6.26                | 9.33                             | 27.99                     | PASS       |
|                   | 165/5825                       | 5.21                   | 5.48                | 5.57                | 5.84                | 8.67                             | 27.99                     | PASS       |
| 802.11n<br>HT40   | 151/5755                       | 2.25                   | 3.21                | 1.87                | 2.83                | 6.04                             | 27.99                     | PASS       |
|                   | 159/5795                       | 2.13                   | 3.10                | 2.21                | 3.18                | 6.15                             | 27.99                     | PASS       |
| 802.11ac<br>VHT20 | 149/5745                       | 5.81                   | 6.08                | 6.14                | 6.41                | 9.26                             | 27.99                     | PASS       |
|                   | 165/5825                       | 5.68                   | 5.95                | 5.66                | 5.93                | 8.95                             | 27.99                     | PASS       |
| 802.11ac<br>VHT40 | 151/5755                       | 2.42                   | 3.38                | 2.21                | 3.18                | 6.29                             | 27.99                     | PASS       |
|                   | 159/5795                       | 2.44                   | 3.41                | 2.38                | 3.35                | 6.39                             | 27.99                     | PASS       |
| 802.11ac<br>VHT80 | 155/5775                       | -2.56                  | -2.29               | -2.27               | -2.00               | 0.87                             | 27.99                     | PASS       |
| 802.11ax<br>HE20  | 149/5745                       | 5.80                   | 6.07                | 6.24                | 6.51                | 9.30                             | 27.99                     | PASS       |
|                   | 165/5825                       | 4.82                   | 5.09                | 5.00                | 5.27                | 8.19                             | 27.99                     | PASS       |
| 802.11ax<br>HE40  | 151/5755                       | 0.22                   | 0.49                | -0.20               | 0.07                | 3.30                             | 27.99                     | PASS       |
|                   | 159/5795                       | 2.06                   | 2.33                | 2.00                | 2.27                | 5.31                             | 27.99                     | PASS       |
| 802.11ax<br>HE80  | 155/5775                       | -4.44                  | -4.17               | -4.38               | -4.11               | -1.13                            | 27.99                     | PASS       |

Note: 1. For Total Power, according to KDB 662911 D01 Multiple Transmitter Output v02r01 1),  
The Total Power =  $10\log(10^{(\text{PSD antenna1 in dBm}/10)} + 10^{(\text{PSD antenna2 in dBm}/10)})$

2. The manufacturer declared the transmitter output signals is CDD mode And Nss=1. According to KDB 662911 D01 Multiple Transmitter Output v02r01 2)e)(i): If all antennas have the same gain, Directional gain = GANT + Array Gain, For PSD measurements on all devices, Array Gain =  $10\log(\text{Nant}/\text{Nss})\text{dB}$ , so directional gain = GANT + Array Gain =  $5 + 10\log(2/1) = 8.01 > 6\text{ dBi}$ . So the PSD limit is  $30 - (\text{directional gain} - 6\text{ dBi}) = 30 - (8.01 - 6) = 27.99\text{dBm}$ .

3. Offset already includes Duty cycle correction factor, so all read value in test plots are already the final results of the Power Spectral Density.

4.  $\text{PSD}(\text{dBm}/500\text{kHz}) = \text{RSD}(\text{dBm}/470\text{kHz}) + 10 * \text{LOG}10(500/470)$      $10 * \text{LOG}10(500/470) = 0.27$

**MIMO without Beamforming****U-NII-1**

| Mode              | Channel/<br>Frequency<br>(MHz) | Power Spectral Density |              |                            | Limit<br>(dBm<br>/MHz) | Conclusion |
|-------------------|--------------------------------|------------------------|--------------|----------------------------|------------------------|------------|
|                   |                                | Antenna 1              | Antenna 2    | Total PSD<br>(dBm<br>/MHz) |                        |            |
|                   |                                | PSD(dBm/MHz)           | PSD(dBm/MHz) |                            |                        |            |
| 802.11a           | 36/5180                        | 4.27                   | 4.61         | 7.45                       | 14.99                  | PASS       |
|                   | 40/5200                        | 7.44                   | 8.06         | 10.77                      | 14.99                  | PASS       |
|                   | 44/5220                        | 9.17                   | 9.67         | 12.44                      | 14.99                  | PASS       |
|                   | 48/5240                        | 8.86                   | 9.17         | 12.03                      | 14.99                  | PASS       |
| 802.11n<br>HT20   | 36/5180                        | 3.79                   | 4.37         | 7.10                       | 14.99                  | PASS       |
|                   | 40/5200                        | 7.04                   | 8.02         | 10.57                      | 14.99                  | PASS       |
|                   | 44/5220                        | 9.14                   | 9.70         | 12.44                      | 14.99                  | PASS       |
|                   | 48/5240                        | 9.63                   | 9.85         | 12.75                      | 14.99                  | PASS       |
| 802.11n<br>HT40   | 38/5190                        | -2.07                  | -1.79        | 1.08                       | 14.99                  | PASS       |
|                   | 46/5230                        | 0.11                   | 0.29         | 3.21                       | 14.99                  | PASS       |
| 802.11ac<br>VHT20 | 36/5180                        | 4.14                   | 4.53         | 7.35                       | 14.99                  | PASS       |
|                   | 40/5200                        | 7.19                   | 7.87         | 10.55                      | 14.99                  | PASS       |
|                   | 44/5220                        | 9.28                   | 10.06        | 12.70                      | 14.99                  | PASS       |
|                   | 48/5240                        | 9.07                   | 9.90         | 12.52                      | 14.99                  | PASS       |
| 802.11ac<br>VHT40 | 38/5190                        | -1.51                  | -1.51        | 1.50                       | 14.99                  | PASS       |
|                   | 46/5230                        | 0.13                   | 0.22         | 3.18                       | 14.99                  | PASS       |
| 802.11ac<br>VHT80 | 42/5210                        | -5.84                  | -4.92        | -2.34                      | 14.99                  | PASS       |
| 802.11ax<br>HE20  | 36/5180                        | 2.88                   | 3.01         | 5.95                       | 14.99                  | PASS       |
|                   | 40/5200                        | 7.22                   | 7.92         | 10.59                      | 14.99                  | PASS       |
|                   | 44/5220                        | 9.11                   | 9.64         | 12.39                      | 14.99                  | PASS       |
|                   | 48/5240                        | 8.87                   | 9.61         | 12.26                      | 14.99                  | PASS       |
| 802.11ax<br>HE40  | 38/5190                        | -2.78                  | -2.67        | 0.29                       | 14.99                  | PASS       |
|                   | 46/5230                        | -0.27                  | -0.17        | 2.79                       | 14.99                  | PASS       |
| 802.11ax<br>HE80  | 42/5210                        | -5.51                  | -4.89        | -2.18                      | 14.99                  | PASS       |

Note: 1. Offset already includes Duty cycle correction factor, so all read value in test plots are already the final results of the Power Spectral Density.

2. For Total PSD, according to KDB 662911 D01 Multiple Transmitter Output v02r01 2)a), the power spectral density= $10\log(10^{(\text{PSD antenna1 in dBm}/10)}+10^{(\text{PSD antenna2 in dBm}/10)})$

3. The manufacturer declared the transmitter output signals is CDD mode And Nss=1. According to KDB 662911 D01 Multiple Transmitter Output v02r01 2)f)(i): If all antennas have the same gain, Directional gain = GANT + Array Gain, For PSD measurements on all devices, Array Gain= $10\log(\text{Nant}/\text{Nss})\text{dB}$ , so directional gain=GANT+Array Gain= $5+10\log(2/1)=8.01>6\text{dBi}$ . So the PSD limit is  $17-(\text{directional gain}-6\text{dBi})=17-(8.01-6)=14.99\text{dBm}$ .



## U-NII-3

| Mode              | Channel/<br>Frequency<br>(MHz) | Power Spectral Density |                     |                     |                     |                                  | Limit<br>(dBm<br>/500kHz) | Conclusion |
|-------------------|--------------------------------|------------------------|---------------------|---------------------|---------------------|----------------------------------|---------------------------|------------|
|                   |                                | Antenna 1              |                     | Antenna 2           |                     | Total<br>PSD<br>(dBm<br>/500kHz) |                           |            |
|                   |                                | PSD(dBm/<br>470kHz)    | PSD(dBm/<br>500kHz) | PSD(dBm/<br>470kHz) | PSD(dBm/<br>500kHz) |                                  |                           |            |
| 802.11a           | 149/5745                       | 5.64                   | 5.91                | 5.75                | 6.02                | 8.97                             | 27.99                     | PASS       |
|                   | 165/5825                       | 5.55                   | 5.82                | 5.78                | 6.04                | 8.94                             | 27.99                     | PASS       |
| 802.11n<br>HT20   | 149/5745                       | 5.64                   | 5.91                | 5.75                | 6.02                | 8.97                             | 27.99                     | PASS       |
|                   | 165/5825                       | 5.59                   | 5.86                | 5.55                | 5.82                | 8.85                             | 27.99                     | PASS       |
| 802.11n<br>HT40   | 151/5755                       | 2.18                   | 3.15                | 2.29                | 3.26                | 6.21                             | 27.99                     | PASS       |
|                   | 159/5795                       | 2.30                   | 3.27                | 2.51                | 3.48                | 6.39                             | 27.99                     | PASS       |
| 802.11ac<br>VHT20 | 149/5745                       | 5.54                   | 5.81                | 5.62                | 5.89                | 8.86                             | 27.99                     | PASS       |
|                   | 165/5825                       | 5.29                   | 5.56                | 5.94                | 6.21                | 8.91                             | 27.99                     | PASS       |
| 802.11ac<br>VHT40 | 151/5755                       | 2.20                   | 3.17                | 2.14                | 3.11                | 6.15                             | 27.99                     | PASS       |
|                   | 159/5795                       | 2.43                   | 3.39                | 2.47                | 3.44                | 6.43                             | 27.99                     | PASS       |
| 802.11ac<br>VHT80 | 155/5775                       | -2.65                  | -2.38               | -2.49               | -2.22               | 0.72                             | 27.99                     | PASS       |
| 802.11ax<br>HE20  | 149/5745                       | 5.71                   | 5.98                | 5.97                | 6.24                | 9.12                             | 27.99                     | PASS       |
|                   | 165/5825                       | 4.79                   | 5.06                | 5.06                | 5.33                | 8.21                             | 27.99                     | PASS       |
| 802.11ax<br>HE40  | 151/5755                       | 0.13                   | 0.40                | 0.23                | 0.50                | 3.46                             | 27.99                     | PASS       |
|                   | 159/5795                       | 2.20                   | 2.47                | 1.88                | 2.15                | 5.33                             | 27.99                     | PASS       |
| 802.11ax<br>HE80  | 155/5775                       | -2.72                  | -2.45               | -2.91               | -2.64               | 0.47                             | 27.99                     | PASS       |

Note: 1. For Total Power, according to KDB 662911 D01 Multiple Transmitter Output v02r01 1),

The Total Power =  $10\log(10^{(\text{PSD antenna1 in dBm}/10)} + 10^{(\text{PSD antenna2 in dBm}/10)})$

2. The manufacturer declared the transmitter output signals is CDD mode And Nss=1. According to KDB 662911 D01 Multiple Transmitter Output v02r01 2)f)(i): If all antennas have the same gain, Directional gain = GANT + Array Gain, For PSD measurements on all devices, Array Gain =  $10\log(\text{Nant}/\text{Nss})$  dB, so directional gain = GANT + Array Gain =  $5 + 10\log(2/1) = 8.01 > 6$  dBi. So the PSD limit is  $30 - (\text{directional gain} - 6 \text{ dBi}) = 30 - (8.01 - 6) = 27.99$  dBm.

3. Offset already includes Duty cycle correction factor, so all read value in test plots are already the final results of the Power Spectral Density..

4.  $\text{PSD}(\text{dBm}/500\text{kHz}) = \text{RSD}(\text{dBm}/470\text{kHz}) + 10 * \text{LOG}10(500/470)$   $10 * \text{LOG}10(500/470) = 0.27$





SISO Antenna 1

U-NII-1, 802.11a, Channel No.: 36

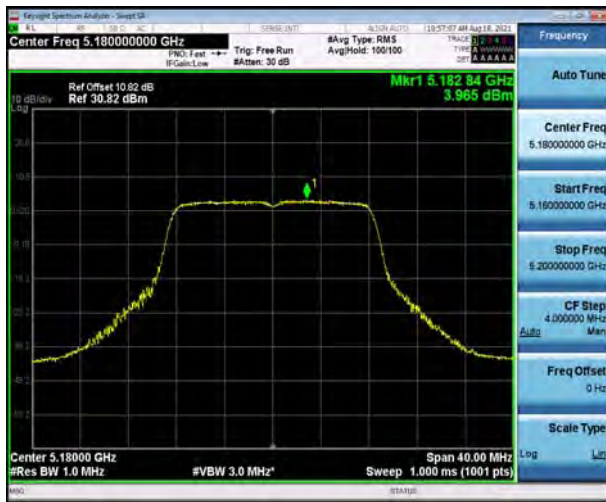

U-NII-1, 802.11n HT20, Channel No.: 36



U-NII-1, 802.11a, Channel No.: 40



U-NII-1, 802.11n HT20, Channel No.: 40



U-NII-1, 802.11a, Channel No.: 44



U-NII-1, 802.11n HT20, Channel No.: 44

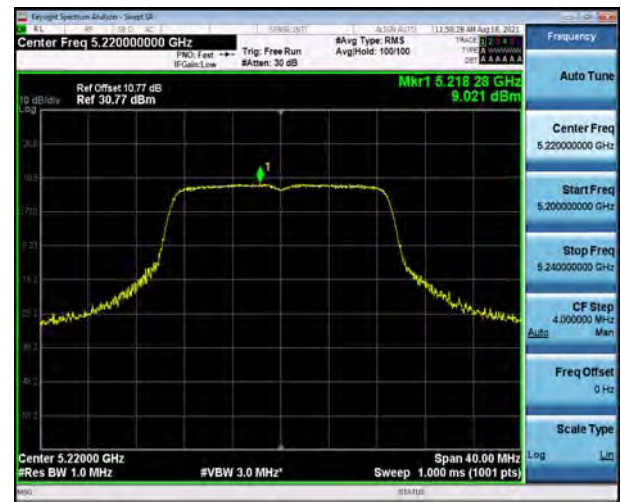



U-NII-1, 802.11a, Channel No.: 48



U-NII-1, 802.11n HT20, Channel No.: 48



U-NII-1, 802.11n HT40, Channel No.: 38



U-NII-1, 802.11ac VHT20, Channel No.: 36



U-NII-1, 802.11n HT40, Channel No.: 46



U-NII-1, 802.11ac VHT20, Channel No.: 40







U-NII-1, 802.11ac VHT40, Channel No.: 38



U-NII-1, 802.11ac VHT20, Channel No.: 44

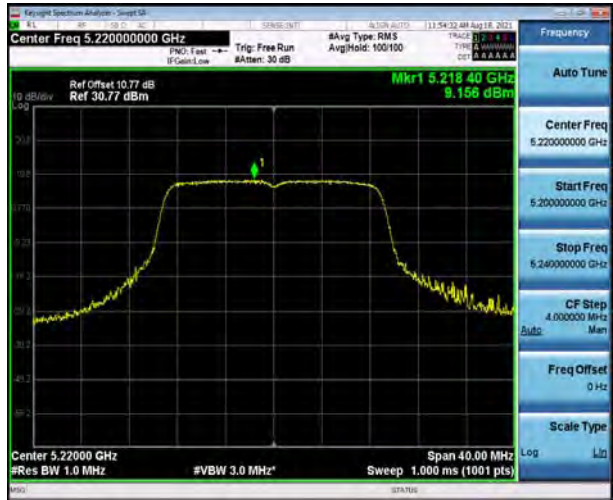

U-NII-1, 802.11ac VHT40, Channel No.: 46

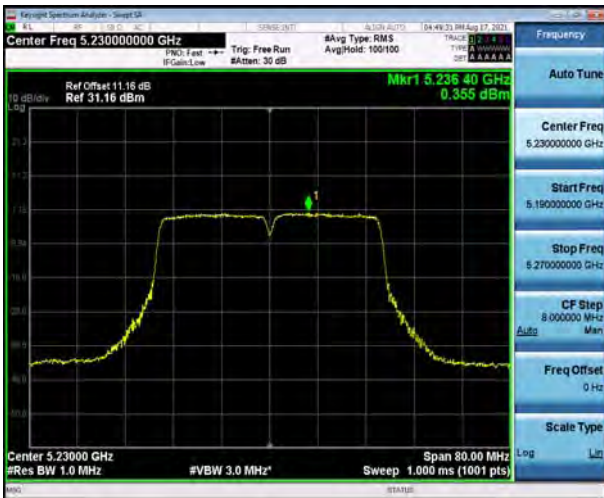

U-NII-1, 802.11ac VHT20, Channel No.: 48

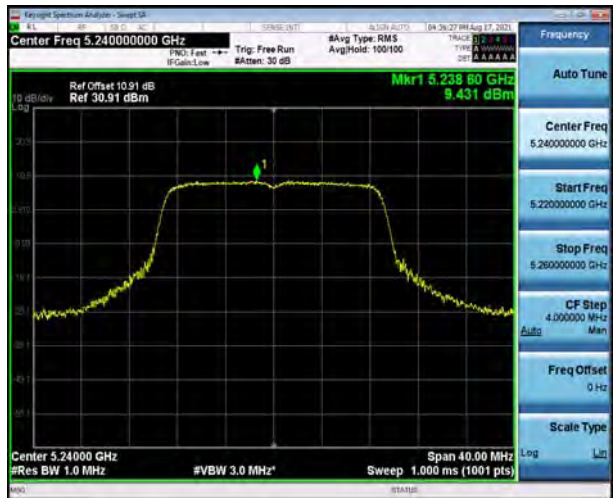

U-NII-1, 802.11ac VHT80, Channel No.: 42



U-NII-1, 802.11ax HE20, Channel No.: 36

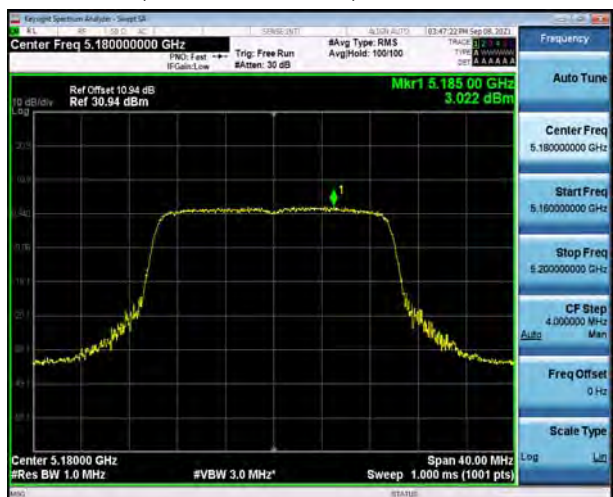



U-NII-1, 802.11ax HE40, Channel No.: 38



U-NII-1, 802.11ax HE20, Channel No.: 40



U-NII-1, 802.11ax HE40, Channel No.: 46

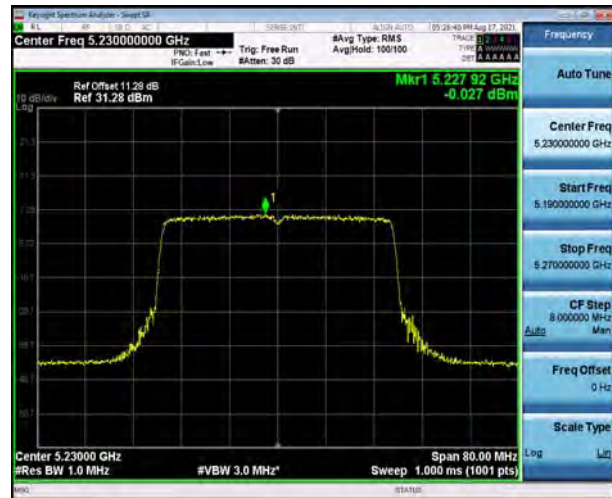

U-NII-1, 802.11ax HE20, Channel No.: 44



U-NII-1, 802.11ax HE80, Channel No.: 42



U-NII-1, 802.11ax HE20, Channel No.: 48







U-NII-3, 802.11a, Channel No.: 149



U-NII-3, 802.11n HT20, Channel No.: 149



U-NII-3, 802.11a, Channel No.: 165



U-NII-3, 802.11n HT20, Channel No.: 165





U-NII-3, 802.11n HT40, Channel No.: 151

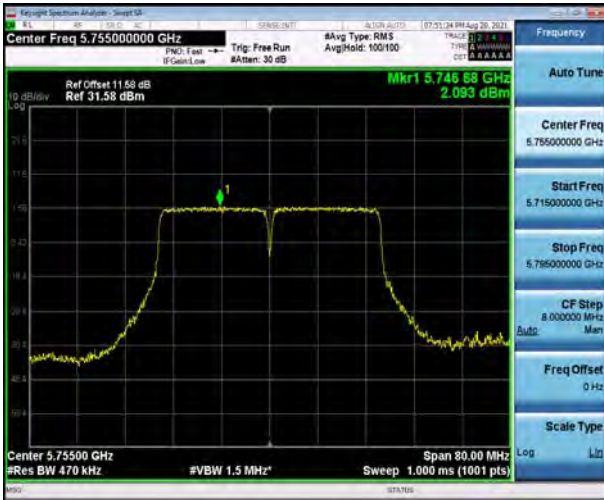

U-NII-3, 802.11ac VHT20, Channel No.: 149



U-NII-3, 802.11n HT40, Channel No.: 159



U-NII-3, 802.11ac VHT20, Channel No.: 165



U-NII-3, 802.11ac VHT40, Channel No.: 151



U-NII-3, 802.11ac VHT80, Channel No.: 155







U-NII-3, 802.11ac VHT40, Channel No.: 159

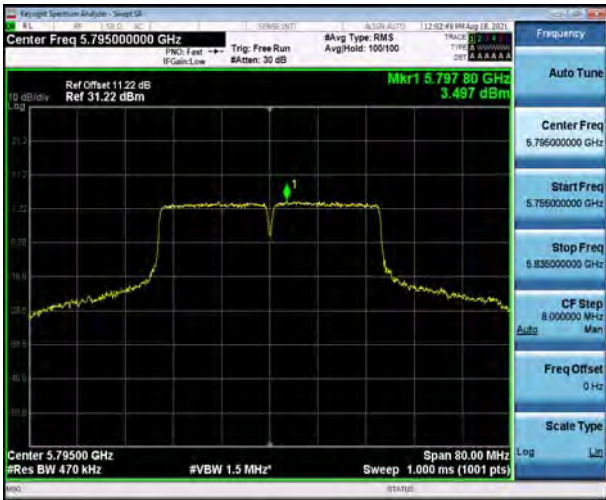

U-NII-3, 802.11ax HE20, Channel No.: 149



U-NII-3, 802.11ax HE40, Channel No.: 151

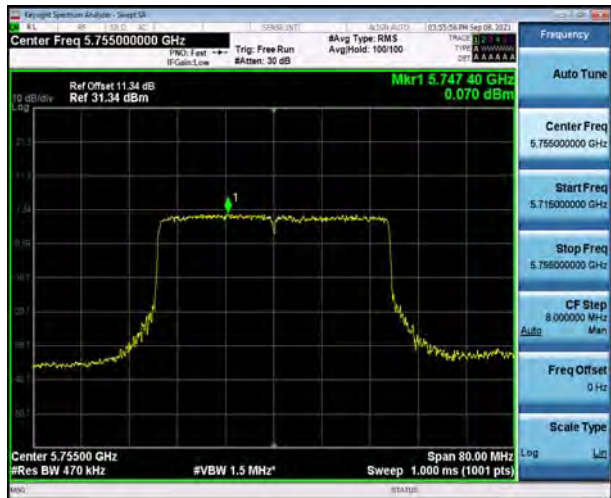

U-NII-3, 802.11ax HE20, Channel No.: 165

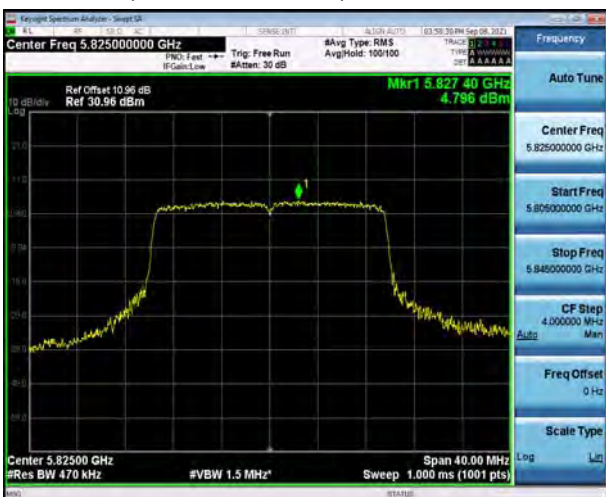

U-NII-3, 802.11ax HE40, Channel No.: 159



U-NII-3, 802.11ax HE80, Channel No.: 155

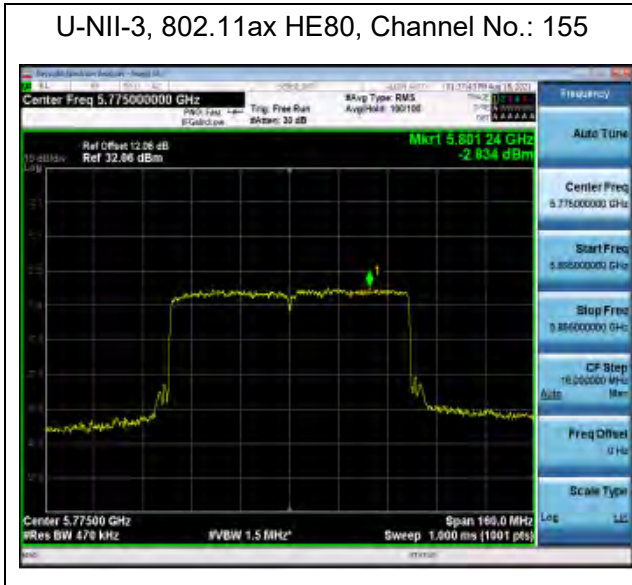





SISO Antenna 2

U-NII-1, 802.11a, Channel No.: 36

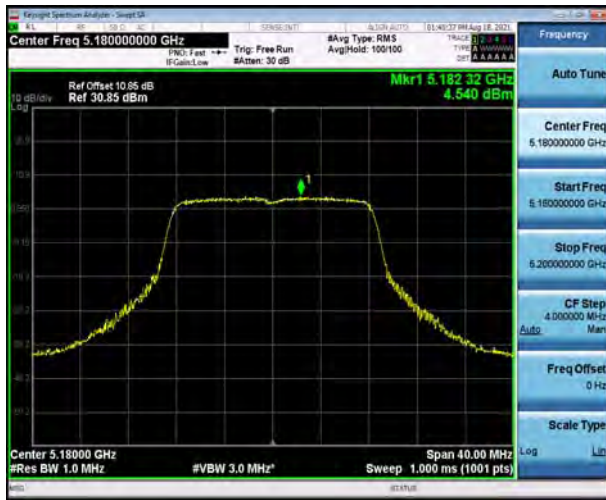

U-NII-1, 802.11n HT20, Channel No.: 36



U-NII-1, 802.11a, Channel No.: 40

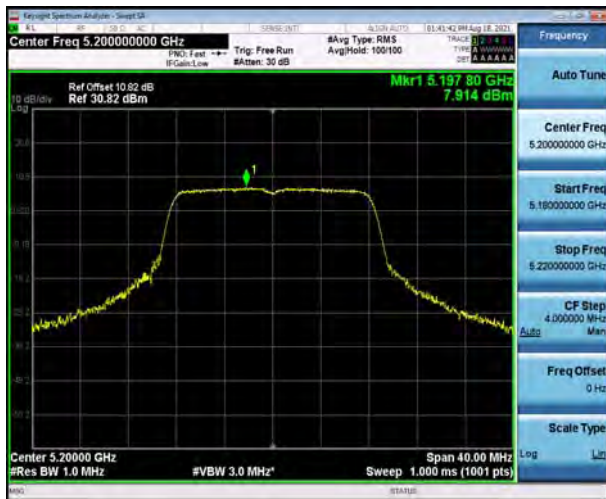

U-NII-1, 802.11n HT20, Channel No.: 40



U-NII-1, 802.11a, Channel No.: 44



U-NII-1, 802.11n HT20, Channel No.: 44





U-NII-1, 802.11a, Channel No.: 48

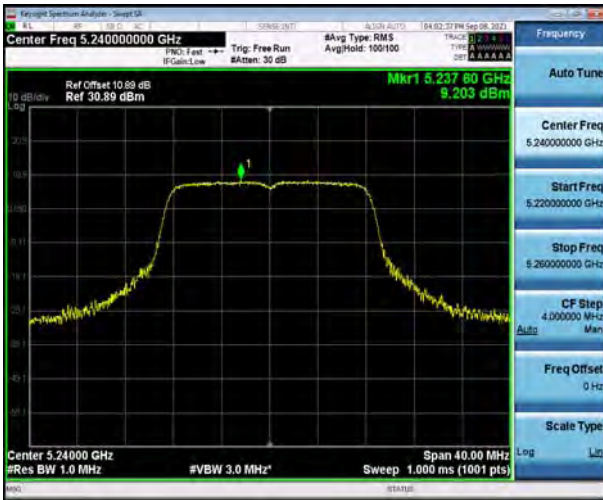

U-NII-1, 802.11n HT20, Channel No.: 48



U-NII-1, 802.11n HT40, Channel No.: 38



U-NII-1, 802.11ac VHT20, Channel No.: 36

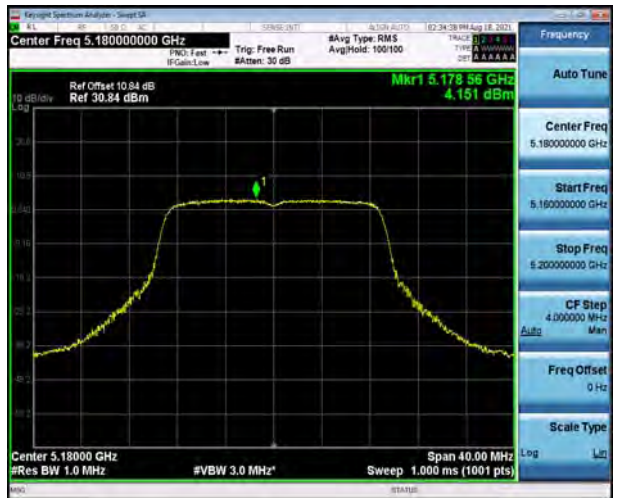

U-NII-1, 802.11n HT40, Channel No.: 46

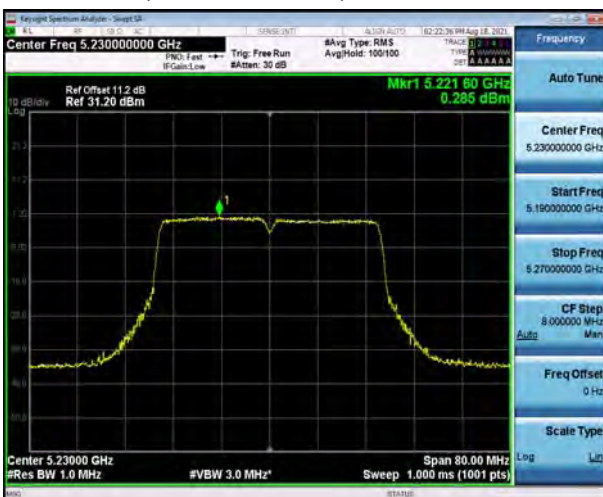

U-NII-1, 802.11ac VHT20, Channel No.: 40

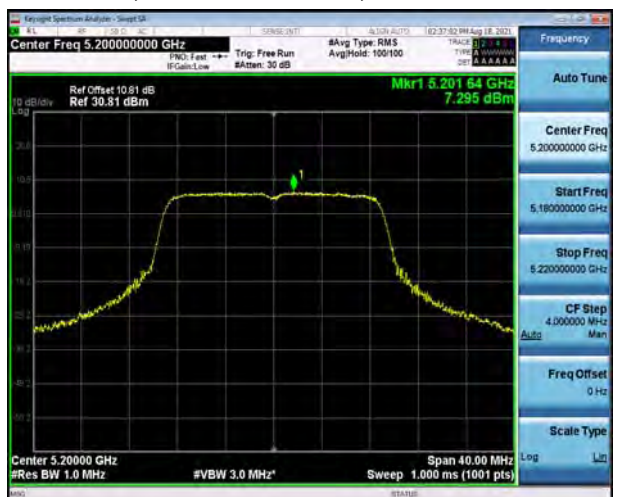





U-NII-1, 802.11ac VHT40, Channel No.: 38



U-NII-1, 802.11ac VHT20, Channel No.: 44



U-NII-1, 802.11ac VHT40, Channel No.: 46

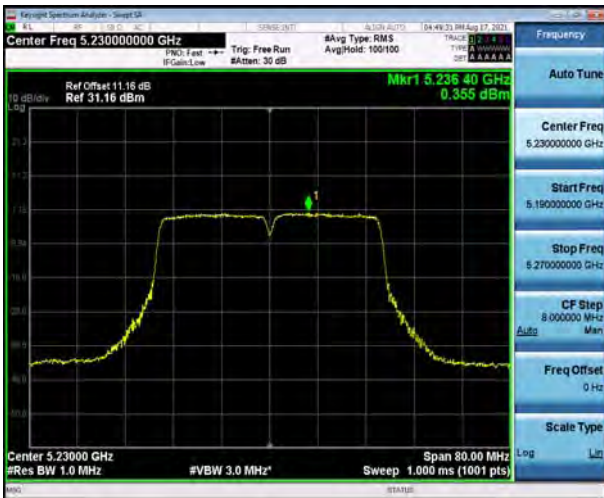

U-NII-1, 802.11ac VHT20, Channel No.: 48



U-NII-1, 802.11ac VHT80, Channel No.: 42



U-NII-1, 802.11ax HE20, Channel No.: 36





U-NII-1, 802.11ax HE40, Channel No.: 38



U-NII-1, 802.11ax HE20, Channel No.: 40



U-NII-1, 802.11ax HE40, Channel No.: 46



U-NII-1, 802.11ax HE20, Channel No.: 44



U-NII-1, 802.11ax HE80, Channel No.: 42



U-NII-1, 802.11ax HE20, Channel No.: 48







U-NII-3, 802.11a, Channel No.: 149



U-NII-3, 802.11n HT20, Channel No.: 149



U-NII-3, 802.11a, Channel No.: 165



U-NII-3, 802.11n HT20, Channel No.: 165





U-NII-3, 802.11n HT40, Channel No.: 151

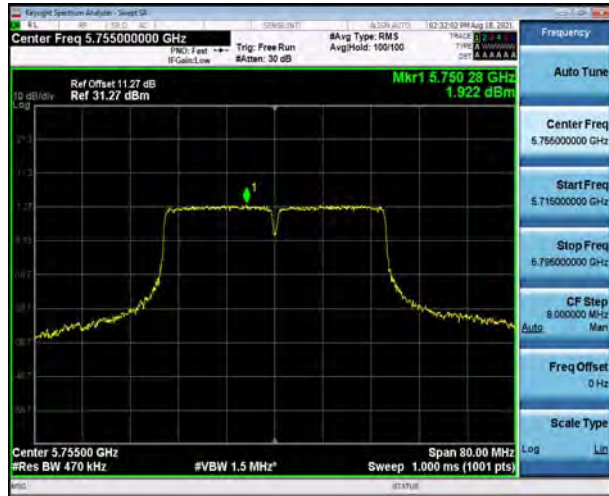

U-NII-3, 802.11ac VHT20, Channel No.: 149



U-NII-3, 802.11n HT40, Channel No.: 159



U-NII-3, 802.11ac VHT20, Channel No.: 165



U-NII-3, 802.11ac VHT40, Channel No.: 151



U-NII-3, 802.11ac VHT80, Channel No.: 155







U-NII-3, 802.11 ac VHT40, Channel No.: 159



U-NII-3, 802.11ax HE20, Channel No.: 149



U-NII-3, 802.11ax HE40, Channel No.: 151



U-NII-3, 802.11ax HE20, Channel No.: 165



U-NII-3, 802.11ax HE40, Channel No.: 159

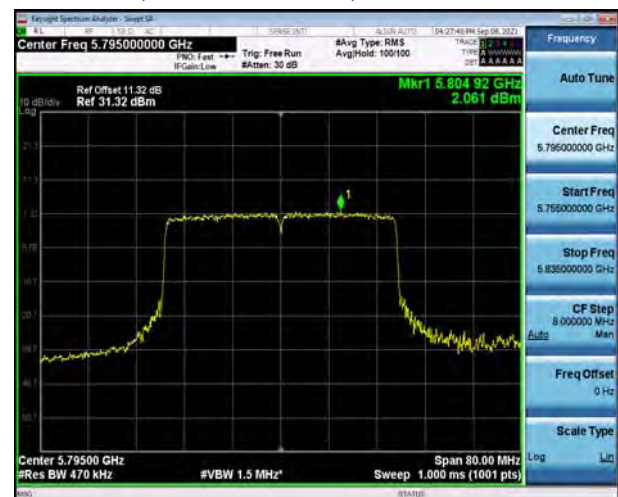

U-NII-3, 802.11ax HE80, Channel No.: 155

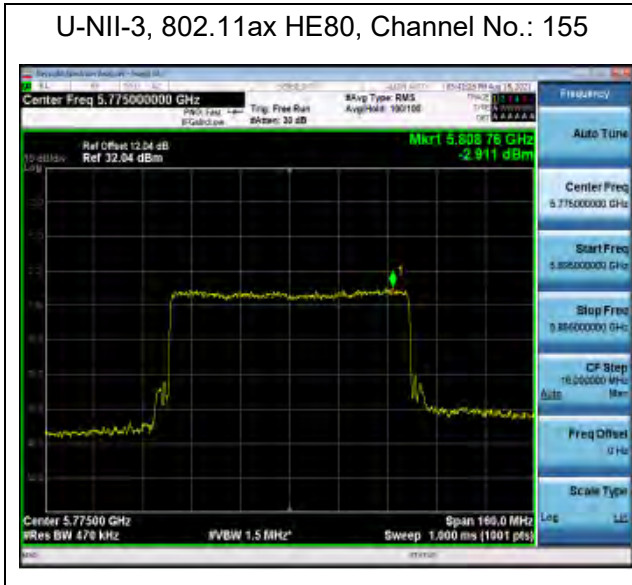





# MIMO without beamforming

## Antenna 1

U-NII-1, 802.11a, Channel No.: 36



U-NII-1, 802.11n HT20, Channel No.: 36

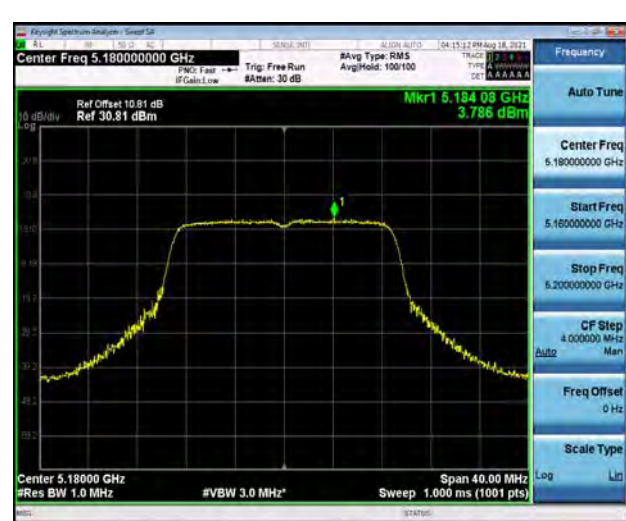

U-NII-1, 802.11a, Channel No.: 40



U-NII-1, 802.11n HT20, Channel No.: 40



U-NII-1, 802.11a, Channel No.: 44



U-NII-1, 802.11n HT20, Channel No.: 44





U-NII-1, 802.11a, Channel No.: 48



U-NII-1, 802.11n HT20, Channel No.: 48



U-NII-1, 802.11n HT40, Channel No.: 38



U-NII-1, 802.11ac VHT20, Channel No.: 36

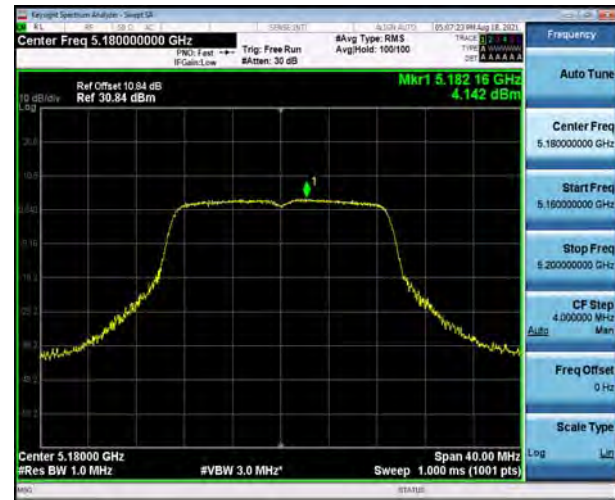

U-NII-1, 802.11n HT40, Channel No.: 46



U-NII-1, 802.11ac VHT20, Channel No.: 40







U-NII-1, 802.11ac VHT40, Channel No.: 38



U-NII-1, 802.11ac VHT20, Channel No.: 44



U-NII-1, 802.11ac VHT40, Channel No.: 46

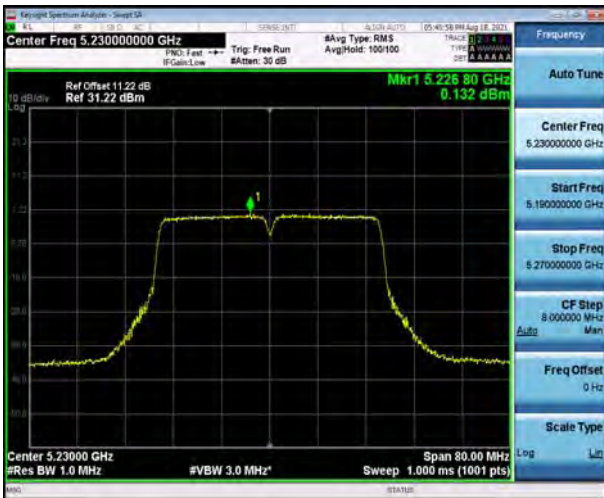

U-NII-1, 802.11ac VHT20, Channel No.: 48



U-NII-1, 802.11ac VHT80, Channel No.: 42



U-NII-1, 802.11ax HE20, Channel No.: 36

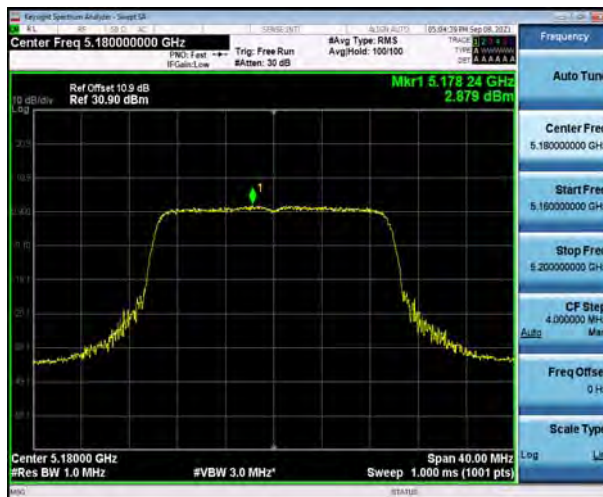



U-NII-1, 802.11ax HE40, Channel No.: 38



U-NII-1, 802.11ax HE20, Channel No.: 40



U-NII-1, 802.11ax HE40, Channel No.: 46



U-NII-1, 802.11ax HE20, Channel No.: 44



U-NII-1, 802.11ax HE80, Channel No.: 42



U-NII-1, 802.11ax HE20, Channel No.: 48







U-NII-3, 802.11a, Channel No.: 149



U-NII-3, 802.11n HT20, Channel No.: 149



U-NII-3, 802.11a, Channel No.: 165



U-NII-3, 802.11n HT20, Channel No.: 165







U-NII-3, 802.11n HT40, Channel No.: 151

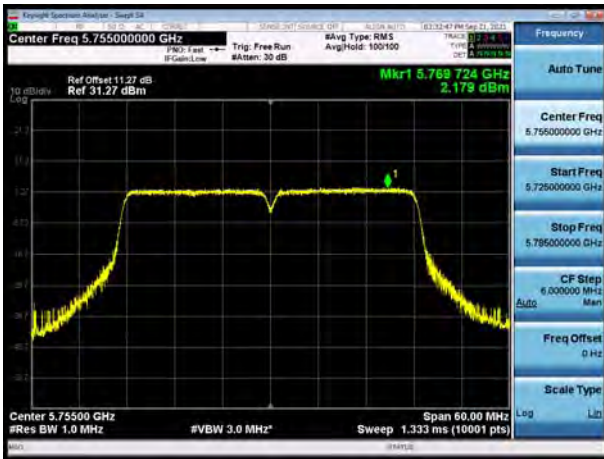

U-NII-3, 802.11ac VHT20, Channel No.: 149



U-NII-3, 802.11n HT40, Channel No.: 159

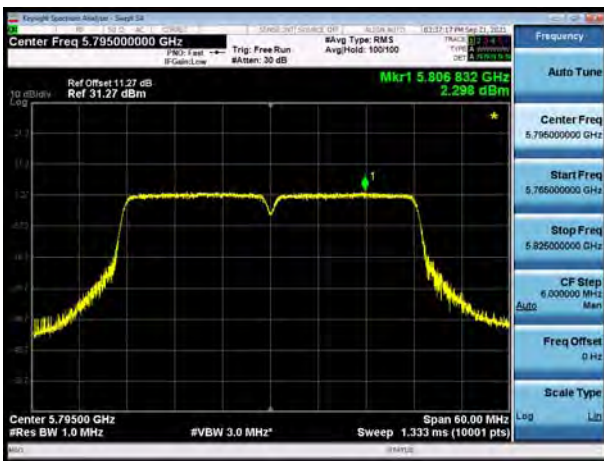

U-NII-3, 802.11ac VHT20, Channel No.: 165



U-NII-3, 802.11ac VHT40, Channel No.: 151

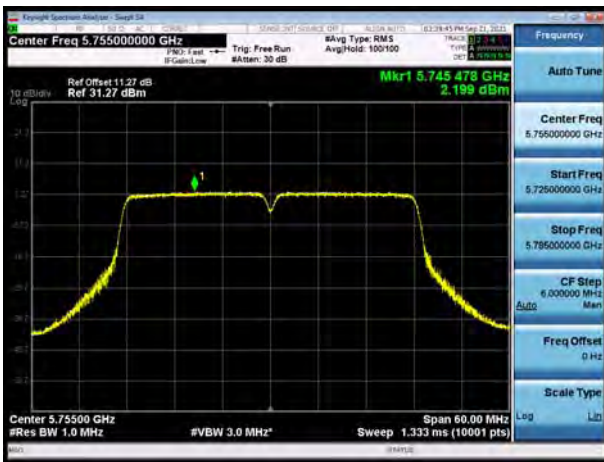

U-NII-3, 802.11ac VHT80, Channel No.: 155



U-NII-3, 802.11ac VHT40, Channel No.: 159

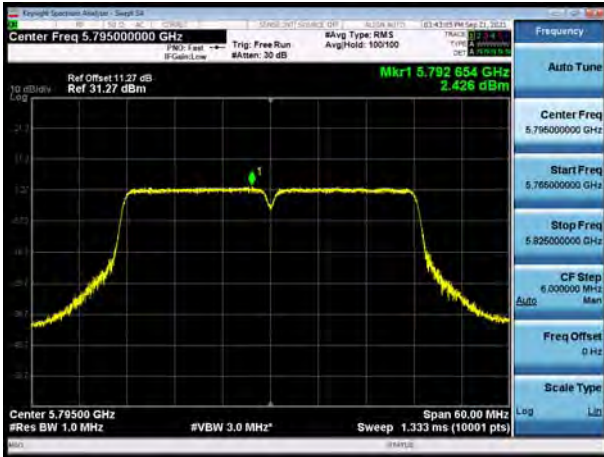

U-NII-3, 802.11ax HE20, Channel No.: 149



U-NII-3, 802.11ax HE40, Channel No.: 151



U-NII-3, 802.11ax HE20, Channel No.: 165



U-NII-3, 802.11ax HE40, Channel No.: 159



U-NII-3, 802.11ax HE80, Channel No.: 155

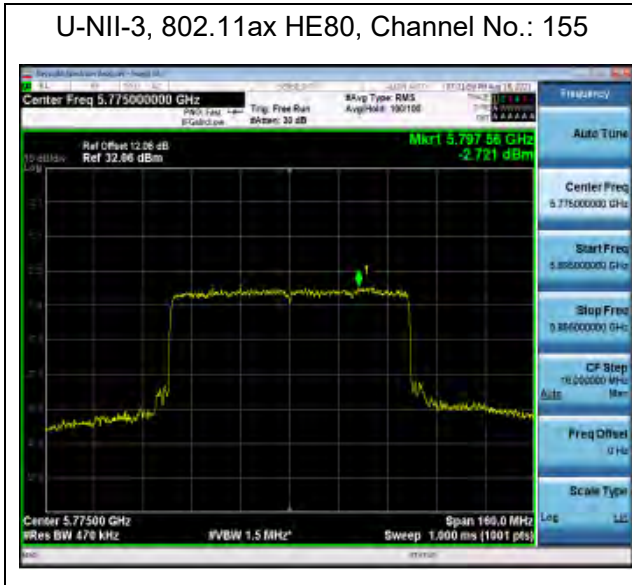





### MIMO without beamforming

#### Antenna 2

U-NII-1, 802.11a, Channel No.: 36

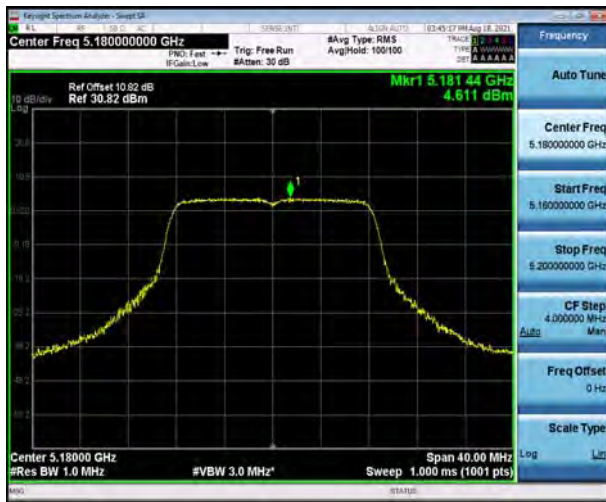

U-NII-1, 802.11n HT20, Channel No.: 36



U-NII-1, 802.11a, Channel No.: 40



U-NII-1, 802.11n HT20, Channel No.: 40

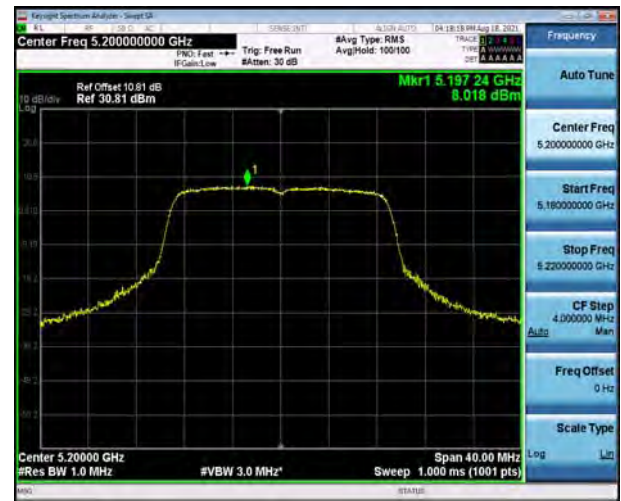

U-NII-1, 802.11a, Channel No.: 44



U-NII-1, 802.11n HT20, Channel No.: 44





U-NII-1, 802.11a, Channel No.: 48

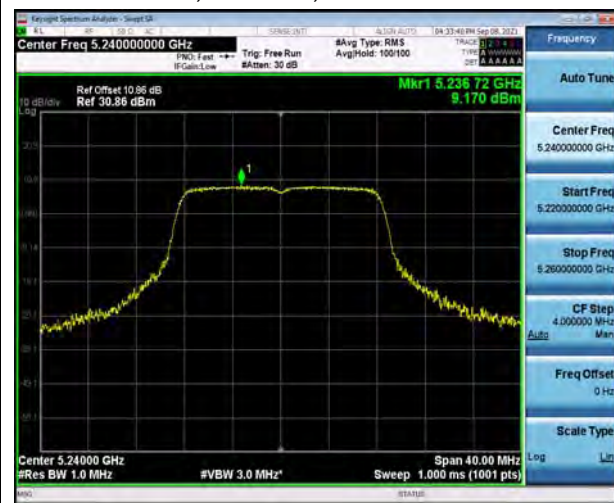

U-NII-1, 802.11n HT20, Channel No.: 48



U-NII-1, 802.11n HT40, Channel No.: 38



U-NII-1, 802.11ac VHT20, Channel No.: 36

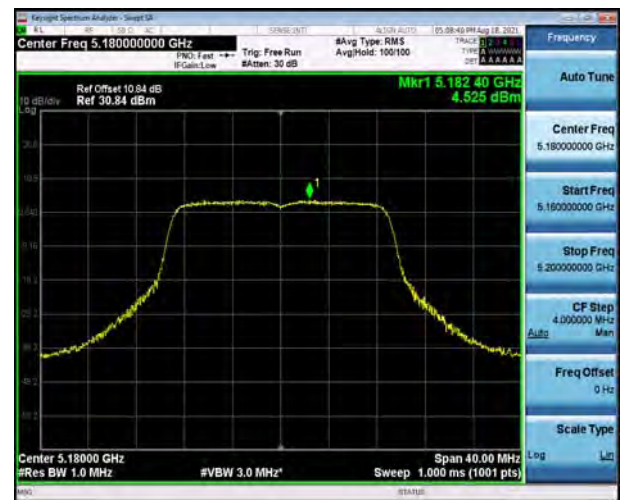

U-NII-1, 802.11n HT40, Channel No.: 46



U-NII-1, 802.11ac VHT20, Channel No.: 40







U-NII-1, 802.11ac VHT40, Channel No.: 38



U-NII-1, 802.11ac VHT20, Channel No.: 44



U-NII-1, 802.11ac VHT40, Channel No.: 46

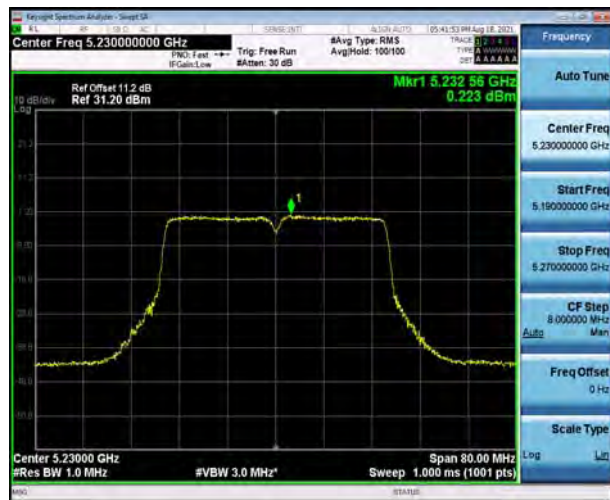

U-NII-1, 802.11ac VHT20, Channel No.: 48



U-NII-1, 802.11ac VHT80, Channel No.: 42



U-NII-1, 802.11ax HE20, Channel No.: 36







U-NII-1, 802.11ax HE40, Channel No.: 38



U-NII-1, 802.11ax HE20, Channel No.: 40



U-NII-1, 802.11ax HE40, Channel No.: 46



U-NII-1, 802.11ax HE20, Channel No.: 44



U-NII-1, 802.11ax HE80, Channel No.: 42



U-NII-1, 802.11ax HE20, Channel No.: 48





U-NII-3, 802.11a, Channel No.: 149



U-NII-3, 802.11n HT20, Channel No.: 149



U-NII-3, 802.11a, Channel No.: 165



U-NII-3, 802.11n HT20, Channel No.: 165







U-NII-3, 802.11n HT40, Channel No.: 151

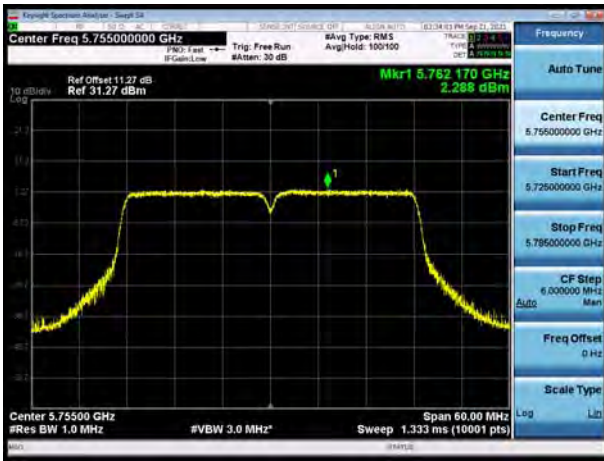

U-NII-3, 802.11ac VHT20, Channel No.: 149



U-NII-3, 802.11n HT40, Channel No.: 159

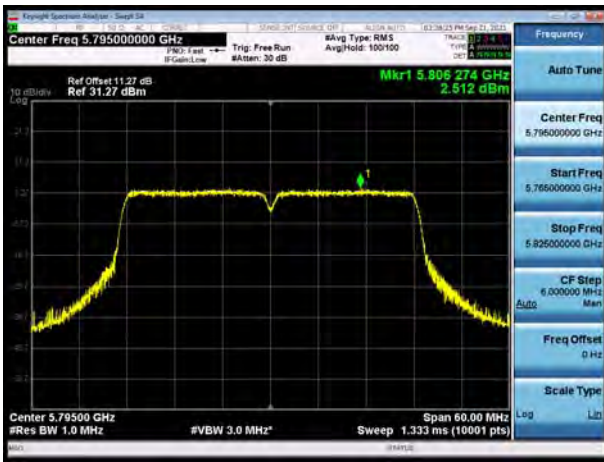

U-NII-3, 802.11ac VHT20, Channel No.: 165



U-NII-3, 802.11ac VHT40, Channel No.: 151

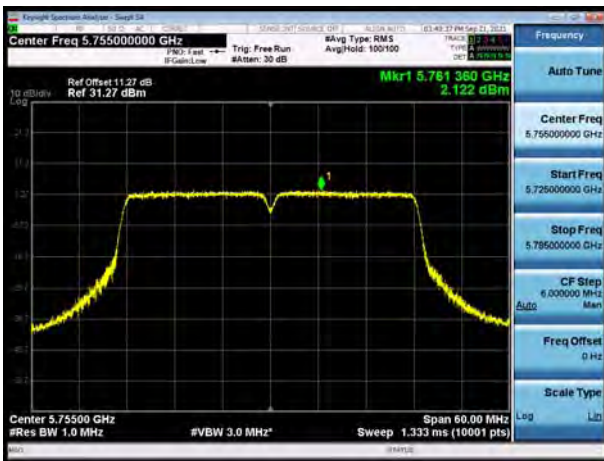

U-NII-3, 802.11ac VHT80, Channel No.: 155



U-NII-3, 802.11ac VHT40, Channel No.: 159

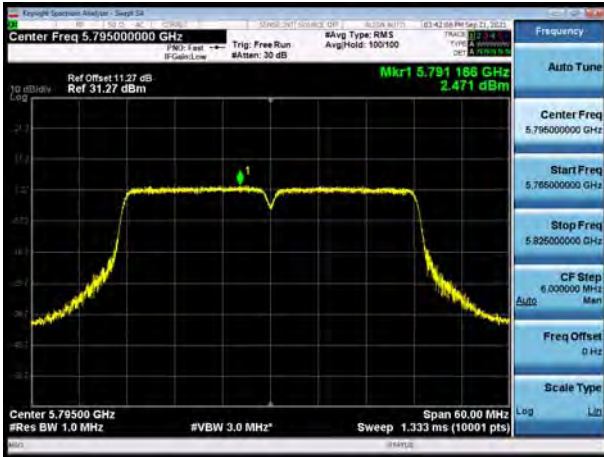

U-NII-3, 802.11ax HE40, Channel No.: 151



U-NII-3, 802.11ax HE20, Channel No.: 149



U-NII-3, 802.11ax HE40, Channel No.: 159



U-NII-3, 802.11ax HE20, Channel No.: 165

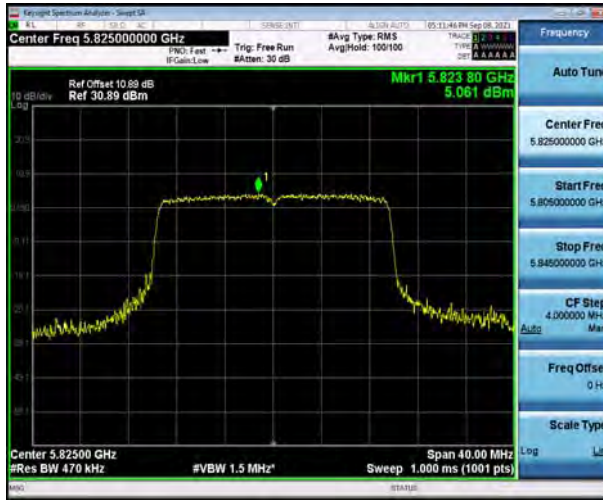



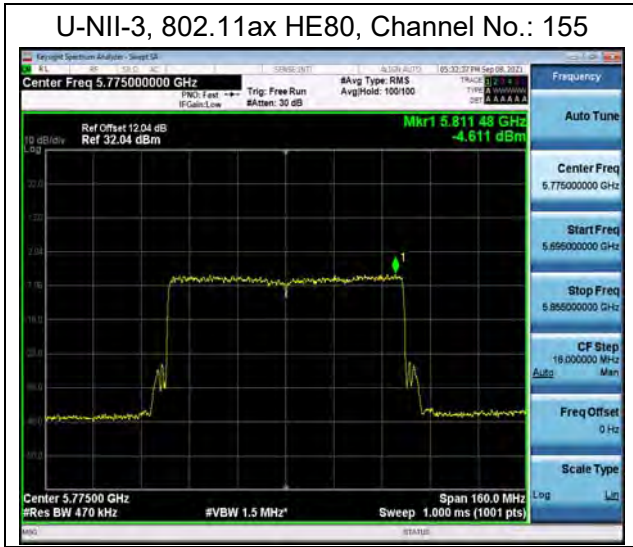



### MIMO with beamforming

#### Antenna 1

U-NII-1, 802.11a, Channel No.: 36



U-NII-1, 802.11n HT20, Channel No.: 36



U-NII-1, 802.11a, Channel No.: 40



U-NII-1, 802.11n HT20, Channel No.: 40



U-NII-1, 802.11a, Channel No.: 44



U-NII-1, 802.11n HT20, Channel No.: 44





U-NII-1, 802.11a, Channel No.: 48

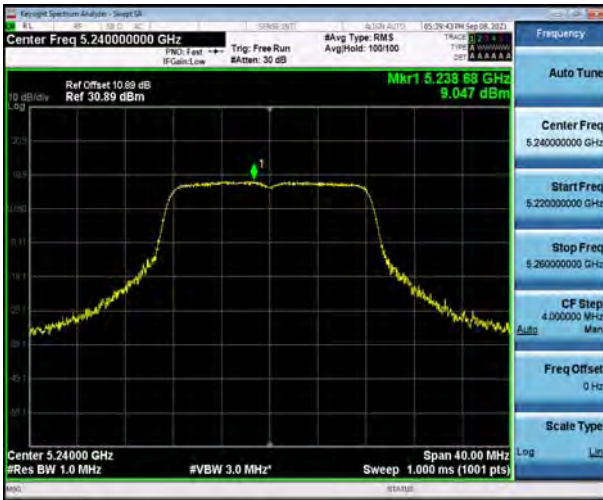

U-NII-1, 802.11n HT20, Channel No.: 48



U-NII-1, 802.11n HT40, Channel No.: 38



U-NII-1, 802.11ac VHT20, Channel No.: 36



U-NII-1, 802.11n HT40, Channel No.: 46



U-NII-1, 802.11ac VHT20, Channel No.: 40

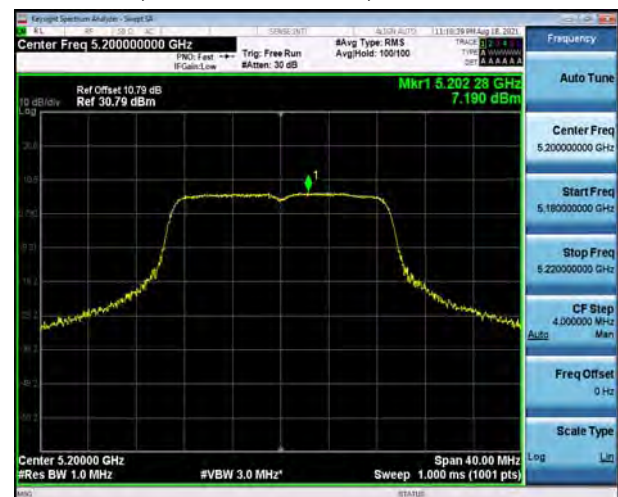





U-NII-1, 802.11ac VHT40, Channel No.: 38



U-NII-1, 802.11ac VHT20, Channel No.: 44



U-NII-1, 802.11ac VHT40, Channel No.: 46

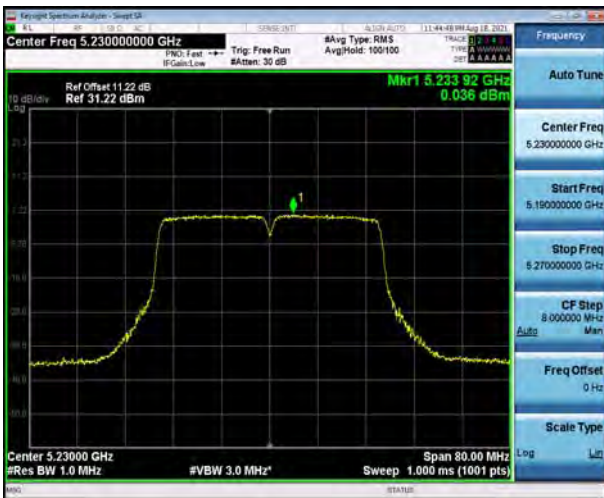

U-NII-1, 802.11ac VHT20, Channel No.: 48



U-NII-1, 802.11ac VHT80, Channel No.: 42



U-NII-1, 802.11ax HE20, Channel No.: 36

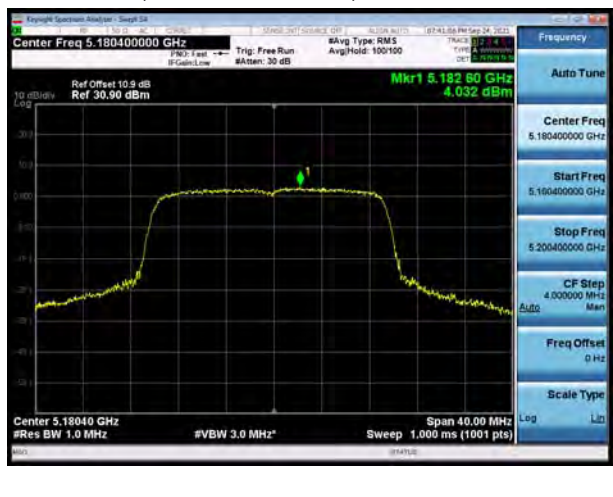





U-NII-1, 802.11ax HE40, Channel No.: 38



U-NII-1, 802.11ax HE20, Channel No.: 40



U-NII-1, 802.11ax HE40, Channel No.: 46



U-NII-1, 802.11ax HE20, Channel No.: 44



U-NII-1, 802.11ax HE80, Channel No.: 42



U-NII-1, 802.11ax HE20, Channel No.: 48





U-NII-3, 802.11a, Channel No.: 149



U-NII-3, 802.11n HT20, Channel No.: 149



U-NII-3, 802.11a, Channel No.: 165



U-NII-3, 802.11n HT20, Channel No.: 165



U-NII-3, 802.11n HT40, Channel No.: 151

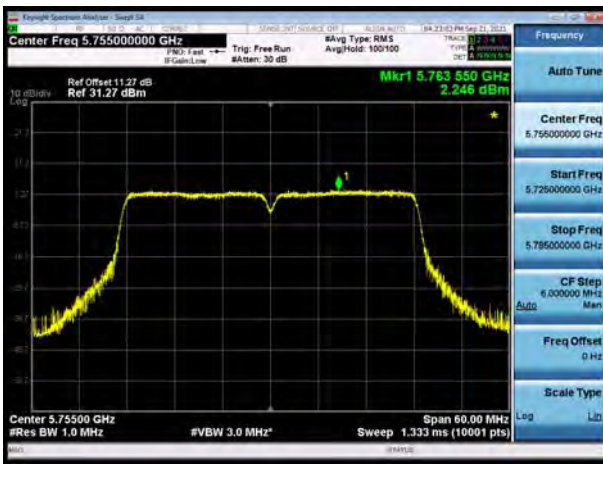

U-NII-3, 802.11ac VHT20, Channel No.: 149







U-NII-3, 802.11n HT40, Channel No.: 159

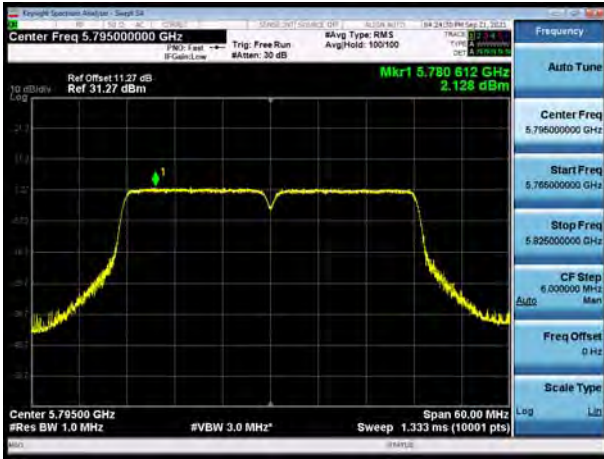

U-NII-3, 802.11ac VHT20, Channel No.: 165



U-NII-3, 802.11ac VHT40, Channel No.: 151

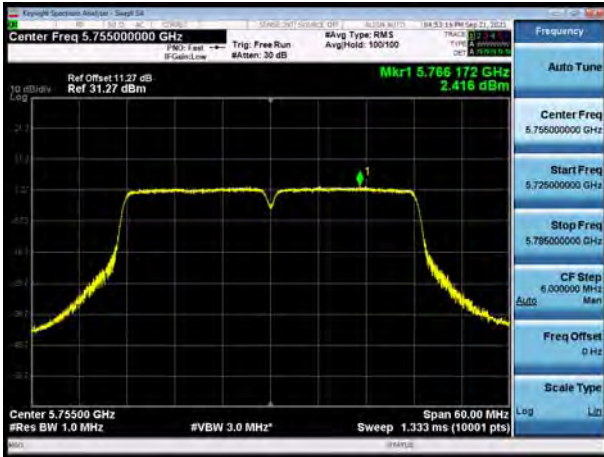

U-NII-3, 802.11ac VHT40, Channel No.: 159

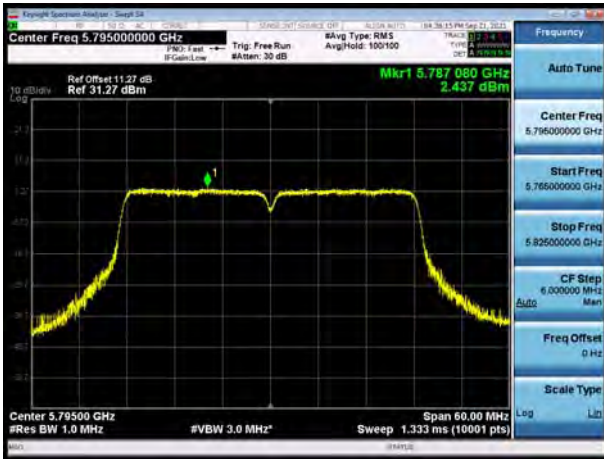

U-NII-3, 802.11ac VHT80, Channel No.: 155







U-NII-3, 802.11ax HE40, Channel No.: 151



U-NII-3, 802.11ax HE20, Channel No.: 149



U-NII-3, 802.11ax HE40, Channel No.: 159



U-NII-3, 802.11ax HE20, Channel No.: 165



U-NII-3, 802.11ax HE80, Channel No.: 155





### MIMO with beamforming

#### Antenna 2

U-NII-1, 802.11a, Channel No.: 36



U-NII-1, 802.11n HT20, Channel No.: 36

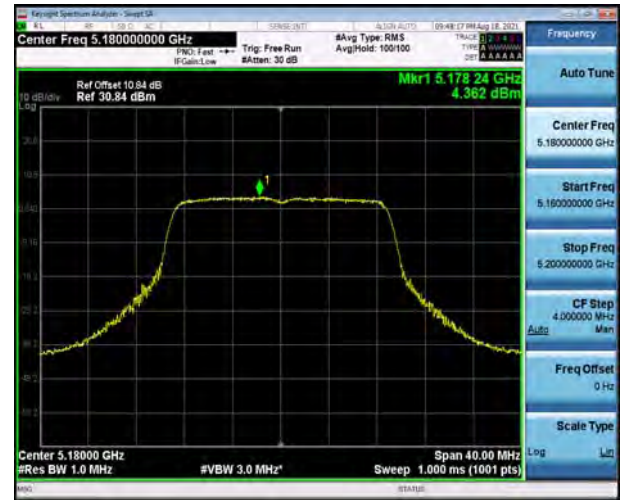

U-NII-1, 802.11a, Channel No.: 40



U-NII-1, 802.11n HT20, Channel No.: 40

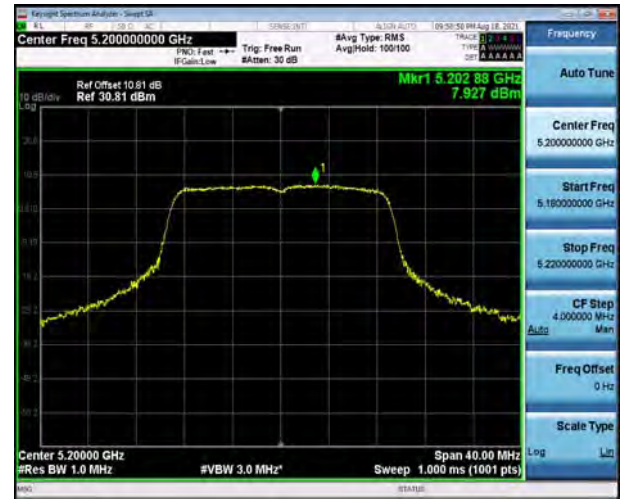

U-NII-1, 802.11a, Channel No.: 44



U-NII-1, 802.11n HT20, Channel No.: 44







U-NII-1, 802.11a, Channel No.: 48

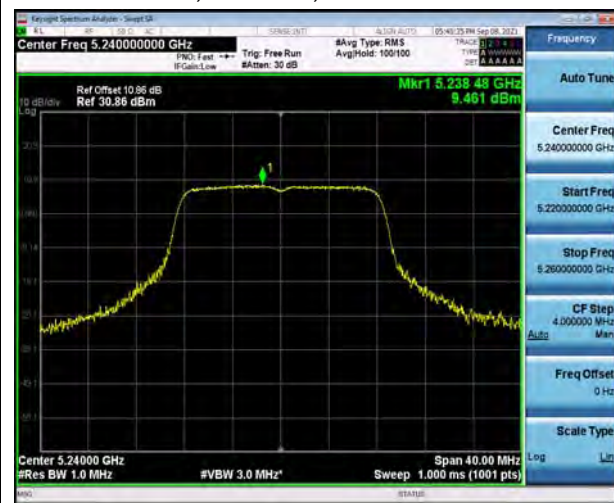

U-NII-1, 802.11n HT20, Channel No.: 48



U-NII-1, 802.11n HT40, Channel No.: 38



U-NII-1, 802.11ac VHT20, Channel No.: 36



U-NII-1, 802.11n HT40, Channel No.: 46

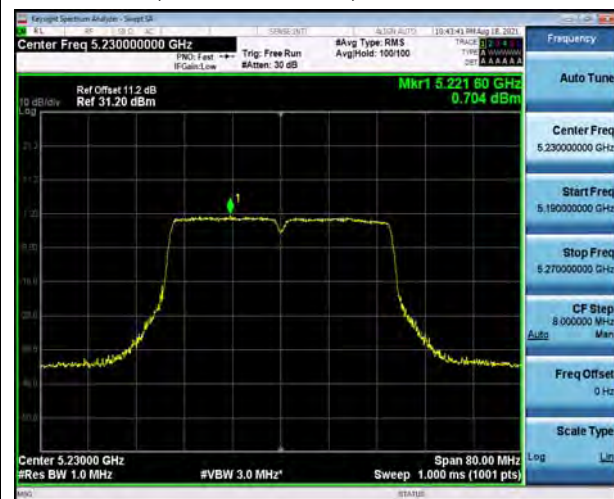

U-NII-1, 802.11ac VHT20, Channel No.: 40







U-NII-1, 802.11ac VHT40, Channel No.: 38



U-NII-1, 802.11ac VHT20, Channel No.: 44



U-NII-1, 802.11ac VHT40, Channel No.: 46



U-NII-1, 802.11ac VHT20, Channel No.: 48



U-NII-1, 802.11ac VHT80, Channel No.: 42



U-NII-1, 802.11ax HE20, Channel No.: 36





U-NII-1, 802.11ax HE40, Channel No.: 38



U-NII-1, 802.11ax HE20, Channel No.: 40



U-NII-1, 802.11ax HE40, Channel No.: 46

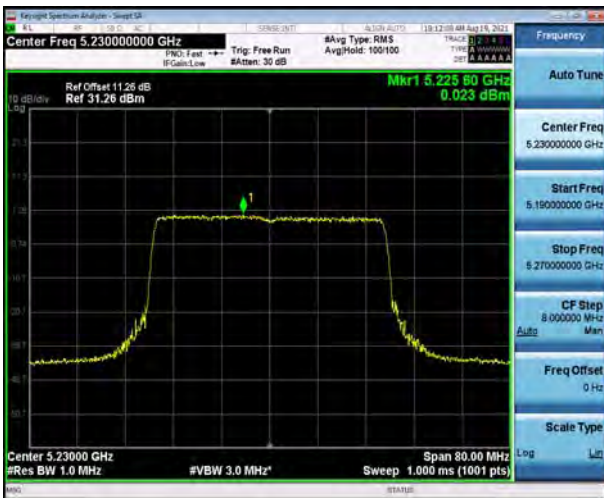

U-NII-1, 802.11ax HE20, Channel No.: 44



U-NII-1, 802.11ax HE80, Channel No.: 42



U-NII-1, 802.11ax HE20, Channel No.: 48







U-NII-3, 802.11a, Channel No.: 149



U-NII-3, 802.11n HT20, Channel No.: 149



U-NII-3, 802.11a, Channel No.: 165



U-NII-3, 802.11n HT20, Channel No.: 165





U-NII-3, 802.11n HT40, Channel No.: 151

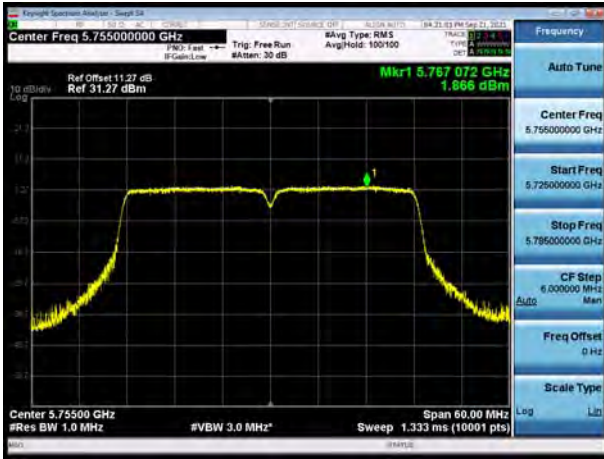

U-NII-3, 802.11ac VHT20, Channel No.: 149



U-NII-3, 802.11n HT40, Channel No.: 159

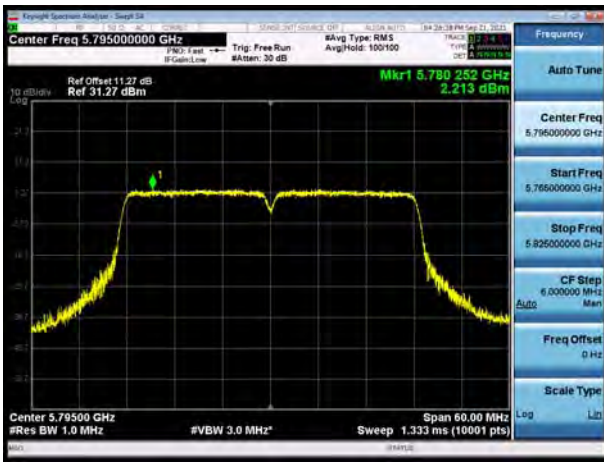

U-NII-3, 802.11ac VHT20, Channel No.: 165

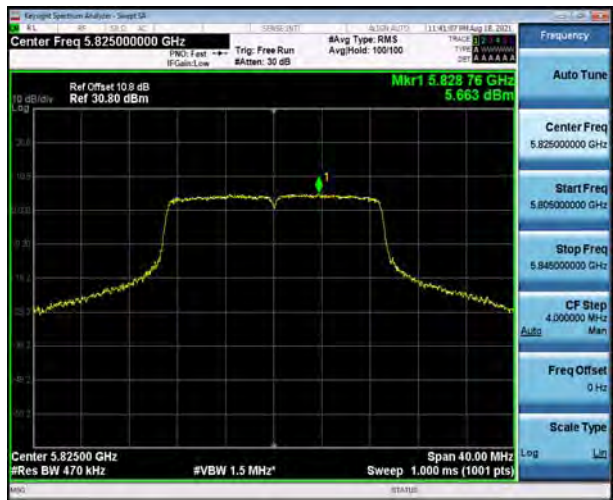

U-NII-3, 802.11ac VHT40, Channel No.: 151

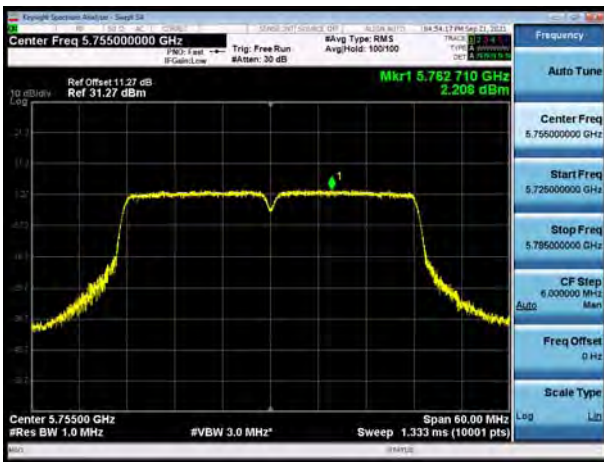



U-NII-3, 802.11ac VHT40, Channel No.: 159

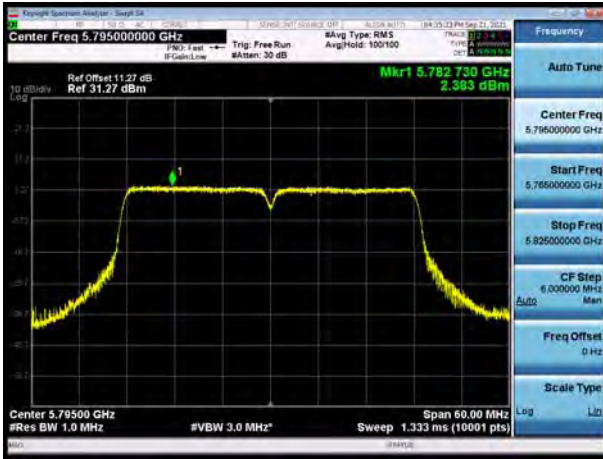

U-NII-3, 802.11ac VHT80, Channel No.: 155



U-NII-3, 802.11ax HE40, Channel No.: 151



U-NII-3, 802.11ax HE20, Channel No.: 149



U-NII-3, 802.11ax HE40, Channel No.: 159



U-NII-3, 802.11ax HE20, Channel No.: 165



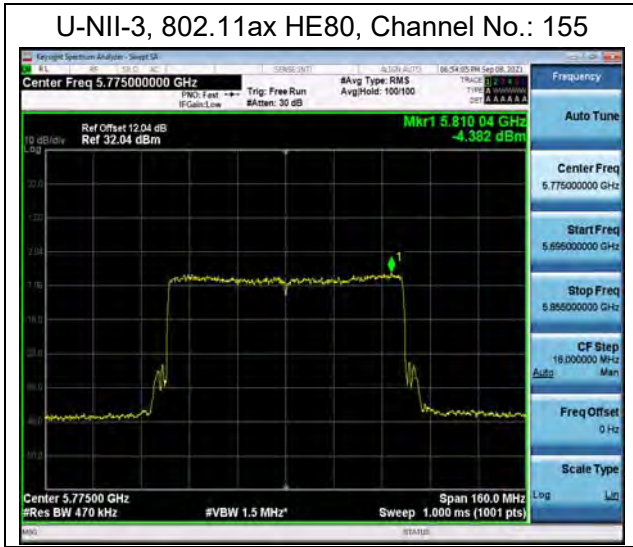



## 5.5. Unwanted Emission

### Ambient condition

| Temperature | Relative humidity | Pressure |
|-------------|-------------------|----------|
| 23°C ~25°C  | 45%~50%           | 101.5kPa |

### Method of Measurement

The test set-up was made in accordance to the general provisions of ANSI C63.10. The Equipment Under Test (EUT) was set up on a non-conductive table in the semi-anechoic chamber. The test was performed at the distance of 3 m between the EUT and the receiving antenna. The radiated emissions measurements were made in a typical installation configuration.

Sweep the whole frequency band range from 9kHz to the 10th harmonic of the carrier, and the emissions less than 20 dB below the permissible value are reported.

During the test, the height of receive antenna shall be moved from 1 to 4 meters, and the antenna shall be performed under horizontal and vertical polarization. The turntable shall be rotated from 0 to 360 degrees for detecting the maximum of radiated spurious signal level. The measurements shall be repeated with orthogonal polarization of the test antenna. The data of cable loss and antenna factor has been calibrated in full testing frequency range before the testing.

Set the spectrum analyzer in the following:

9kHz~150 kHz

RBW=200Hz, VBW=1kHz/ Sweep=AUTO

150 kHz~30MHz

RBW=9KHz, VBW=30KHz,/ Sweep=AUTO

Below 1GHz

RBW=100kHz / VBW=300kHz / Sweep=AUTO

a) Peak emission levels are measured by setting the instrument as follows:

Above 1GHz

PEAK: RBW=1MHz VBW=3MHz/ Sweep=AUTO

b) Average emission levels are measured by setting the instrument as follows:

Above 1GHz

AVERAGE: RBW=1MHz / VBW=3MHz / Sweep=AUTO

c) Detector: The measurements employing a CISPR quasi-peak detector except for the frequency bands 9-90 kHz, 110-490 kHz and above 1000 MHz. Radiated emission limits in these three bands are based on measurements employing an average detector.

d) Averaging type = power (i.e., rms) (As an alternative, the detector and averaging type may be set for linear voltage averaging. Some instruments require linear display mode to use linear voltage averaging. Log or dB averaging shall not be used.)

e) Sweep time = auto.

f) Perform a trace average of at least 100 traces if the transmission is continuous. If the transmission is not continuous, then the number of traces shall be increased by a factor of  $1 / D$ , where  $D$  is the duty cycle. For example, with 50% duty cycle, at least 200 traces shall be averaged. (If a specific



emission is demonstrated to be continuous—i.e., 100% duty cycle—then rather than turning ON and OFF with the transmit cycle, at least 100 traces shall be averaged.)

g) If tests are performed with the EUT transmitting at a duty cycle less than 98%, then a correction factor shall be added to the measurement results prior to comparing with the emission limit, to compute the emission level that would have been measured had the test been performed at 100% duty cycle. The correction factor is computed as follows:

1) If power averaging (rms) mode was used in the preceding step e), then the correction factor is  $[10 \log (1 / D)]$ , where D is the duty cycle. For example, if the transmit duty cycle was 50%, then 3 dB shall be added to the measured emission levels.

2) If linear voltage averaging mode was used in the preceding step e), then the correction factor is  $[20 \log (1 / D)]$ , where D is the duty cycle. For example, if the transmit duty cycle was 50%, then 6 dB shall be added to the measured emission levels.

3) If a specific emission is demonstrated to be continuous (100% duty cycle) rather than turning ON and OFF with the transmit cycle, then no duty cycle correction is required for that emission.

Reduce the video bandwidth until no significant variations in the displayed signal are observed in subsequent traces, provided the video bandwidth is no less than 1 Hz. For regulatory requirements that specify averaging only over the transmit duration (e.g., digital transmission system [DTS] and Unlicensed National Information Infrastructure [U-NII]), the video bandwidth shall be greater than  $[1 / (\text{minimum transmitter on time})]$  and no less than 1 Hz.

The field strength of spurious emission was measured in the following position: EUT stand-up position (Z axis), lie-down position (X, Y axis). The worst emission was found in stand-up position (Z axis) and the loop antenna is vertical, others antenna are vertical and horizontal.

The test is in transmitting mode.

9KHz~~~30MHz

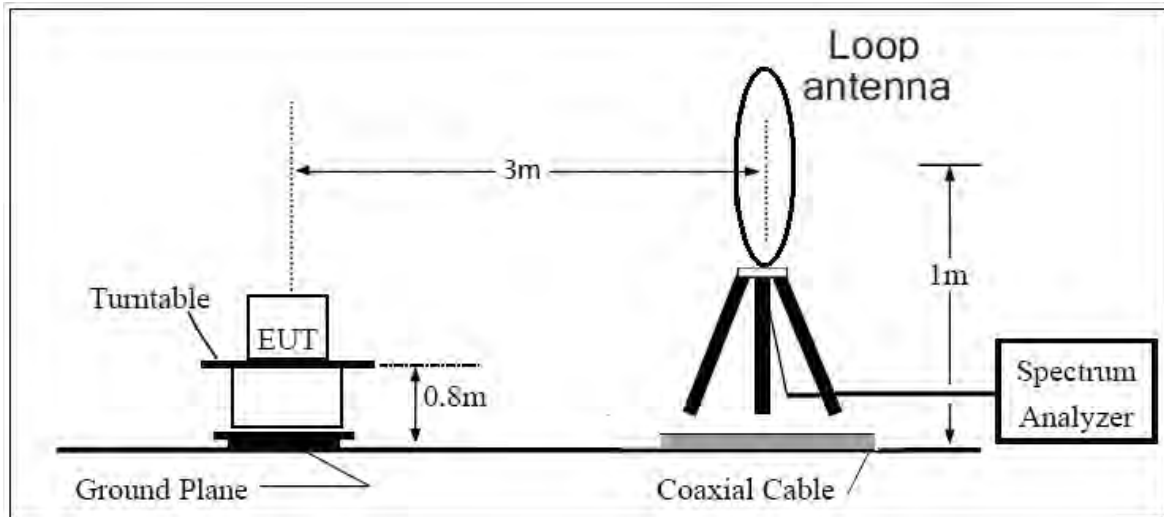

30MHz~~~ 1GHz

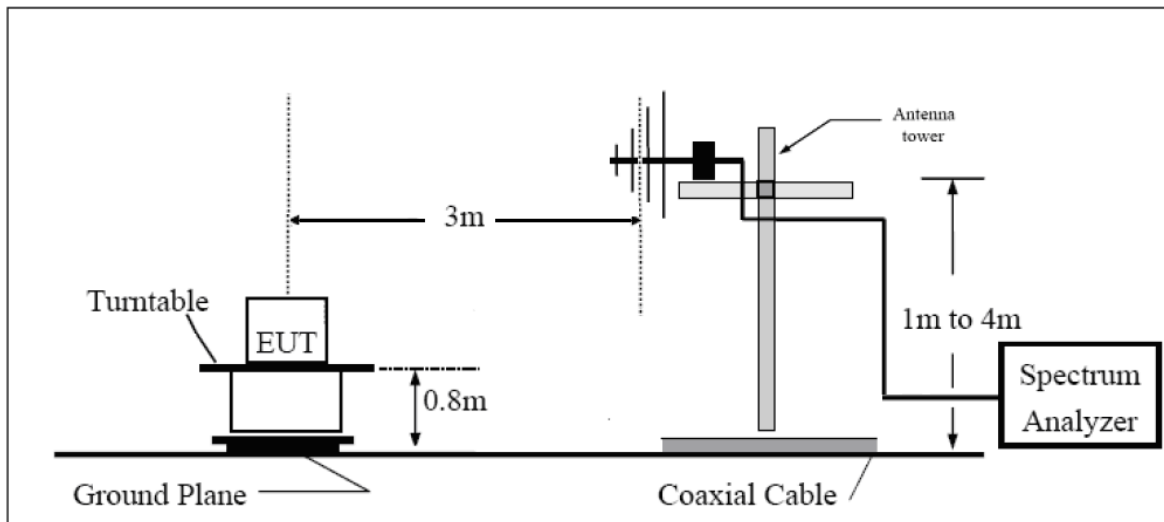

Above 1GHz

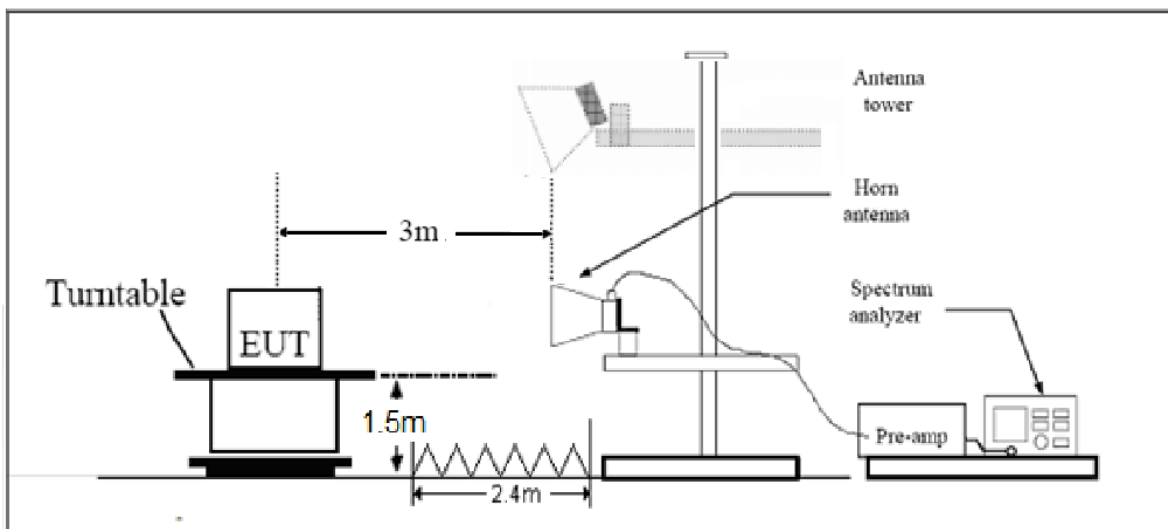

Note: Area side:2.4mX3.6m



**Limits**

- (1) For transmitters operating in the 5725-5850 MHz band: All emissions shall be limited to a level of -27 dBm/MHz at 75 MHz or more above or below the band edge increasing linearly to 10 dBm/MHz at 25 MHz above or below the band edge, and from 25 MHz above or below the band edge increasing linearly to a level of 15.6 dBm/MHz at 5 MHz above or below the band edge, and from 5 MHz above or below the band edge increasing linearly to a level of 27 dBm/MHz at the band edge.
- (2) For transmitters operating in the 5.15-5.25 GHz band: All emissions outside of the 5.15-5.35 GHz band shall not exceed an e.i.r.p. of -27 dBm/MHz(68.2dBμV/m).
- (3) For transmitters operating in the 5.25-5.35 GHz band: All emissions outside of the 5.15-5.35 GHz band shall not exceed an e.i.r.p. of -27 dBm/MHz(68.2dBμV/m).
- (4) For transmitters operating in the 5.47-5.725 GHz band: All emissions outside of the 5.47-5.725 GHz band shall not exceed an e.i.r.p. of -27 dBm/MHz(68.2dBμV/m).

Note: the following formula is used to convert the EIRP to field strength

§1、  $E[\text{dB}\mu\text{V}/\text{m}] = \text{EIRP}[\text{dBm}] - 20 \log(d[\text{meters}]) + 104.77$ , where E = field strength and

d = distance at which field strength limit is specified in the rules;

§2、  $E[\text{dB}\mu\text{V}/\text{m}] = \text{EIRP}[\text{dBm}] + 95.2$ , for d = 3 meters

- (5) Unwanted spurious emissions fallen in restricted bands per FCC Part15.205 shall comply with the general field strength limits set forth in § 15.209 as below table.

| Frequency of emission (MHz) | Field strength(uV/m) | Field strength(dBuV/m) |
|-----------------------------|----------------------|------------------------|
| 0.009–0.490                 | 2400/F(kHz)          | /                      |
| 0.490–1.705                 | 24000/F(kHz)         | /                      |
| 1.705–30.0                  | 30                   | /                      |
| 30-88                       | 100                  | 40                     |
| 88-216                      | 150                  | 43.5                   |
| 216-960                     | 200                  | 46                     |
| Above960                    | 500                  | 54                     |