



# HAC Receive Volume Control Test Report

## For

**Applicant Name:** FOXX Development Inc.  
**Address:** 3480 Preston Ridge Road, Suite500, Alpharetta, GA 30005, USA  
**EUT Name:** Smart Phone  
**Brand Name:** FOXXD  
**Model Number:** A55AM

## Issued By

**Company Name:** BTF Testing Lab (Shenzhen) Co., Ltd.  
**Address:** F101, 201 and 301, Building 1, Block 2, Tantou Industrial Park, Tantou Community, Songgang Street, Bao'an District, Shenzhen, China

**Report Number:** BTF240531R01203  
**Test Standards:** ANSI C63.19:2019 FCC 47 CFR §20.19 TIA-5050:2018  
**FCC ID:** 2AQRM-A55AM

**Test Conclusion:** Pass  
**Test Date:** 2024-07-05 to 2024-07-08  
**Date of Issue:** 2024-07-09

**Prepared By:** Zoey Zhang

Zoey Zhang / Project Engineer

**Date:** 2024-07-09

**Approved By:**

Ryan.CJ

Ryan.CJ / EMC Manager

**Date:** 2024-07-09



*Note: All the test results in this report only related to the testing samples. Which can be duplicated completely for the legal use with approval of applicant; it shall not be reproduced except in full without the written approval of BTF Testing Lab (Shenzhen) Co., Ltd., All the objections should be raised within thirty days from the date of issue. To validate the report, you can contact us.*

Revision History		
Version	Issue Date	Revisions Content
Rev_V0	2024-07-09	Original
<i>Note:</i>	<i>Once the revision has been made, then previous versions reports are replaced by the latest version.</i>	

## Table of Contents

1. Introduction .....	4
1.1 Identification of Testing Laboratory .....	4
1.2 Identification of the Responsible Testing Location .....	4
1.3 Laboratory Condition .....	4
1.4 Announcement .....	4
2. Product Information .....	5
2.1 Application Information .....	5
2.2 Manufacturer Information .....	5
2.3 Factory Information .....	5
2.4 General Description of Equipment under Test (EUT) .....	5
2.5 Equipment under Test Ancillary Equipment .....	6
2.6 Technical Information .....	6
3. Summary of Test Results .....	7
3.1 Test Standards .....	7
3.2 Air Interfaces / Bands Indicating Operating Modes .....	7
4. Test Uncertainty .....	8
5. Measurement System .....	9
5.1 MEASUREMENT SET-UP .....	9
6. Evaluation of Test .....	10
6.1 RECEIVE VOLUME CONTROL PERFORMANCE .....	10
6.2 RECEIVE DISTORTION AND NOISE PERFORMANCE .....	11
6.3 RECEIVE ACOUSTIC FREQUENCY RESPONSE PERFORMANCE .....	12
7. Test Equipment List .....	14
8. Air Interfaces / Bands used for testing .....	14
9. Test Result .....	15
9.1 Receive volume control, distortion and noise performance .....	15
9.2 Receive acoustic frequency response performance .....	17
10. EUT photograph .....	19
ANNEX A Test Data .....	20
1.1 Receive Distortion and Noise 8N NB .....	20
1.2 Receive Distortion and Noise 2N NB .....	22
1.3 Receive Frequency Response .....	25
2.1 Receive Distortion and Noise 8N NB .....	26
2.2 Receive Distortion and Noise 2N NB .....	28
2.3 Receive Frequency Response .....	31
3.1 Receive Distortion and Noise 8N NB .....	32
3.2 Receive Distortion and Noise 2N NB .....	34
3.3 Receive Frequency Response .....	37
4.1 Receive Distortion and Noise 8N NB .....	38
3.2 Receive Distortion and Noise 2N NB .....	40
3.3 Receive Frequency Response .....	43
ANNEX B Test Setup Photo .....	44
ANNEX C CALIBRATION REPORT .....	44

## 1. Introduction

### 1.1 Identification of Testing Laboratory

Company Name:	BTF Testing Lab (Shenzhen) Co., Ltd.
Address:	F101, 201 and 301, Building 1, Block 2, Tantou Industrial Park, Tantou Community, Songgang Street, Bao'an District, Shenzhen, China
Phone Number:	+86-0755-23146130
Fax Number:	+86-0755-23146130

### 1.2 Identification of the Responsible Testing Location

Test Location:	BTF Testing Lab (Shenzhen) Co., Ltd.
Address:	F101, 201 and 301, Building 1, Block 2, Tantou Industrial Park, Tantou Community, Songgang Street, Bao'an District, Shenzhen, China
Description:	All measurement facilities used to collect the measurement data are located at F101,201 and 301, Building 1, Block 2, Tantou Industrial Park, Tantou Community, Songgang Street, Bao'an District, Shenzhen, China

### 1.3 Laboratory Condition

Ambient Temperature:	18°C to 25°C
Ambient Relative Humidity:	32% to 49%
Ambient Pressure:	100 kPa to 102 kPa

### 1.4 Announcement

- (1) The test report reference to the report template version v0.
- (2) The test report is invalid if not marked with the signatures of the persons responsible for preparing, reviewing and approving the test report.
- (3) The test report is invalid if there is any evidence and/or falsification.
- (4) This document may not be altered or revised in any way unless done so by BTF and all revisions are duly noted in the revisions section.
- (5) Content of the test report, in part or in full, cannot be used for publicity and/or promotional purposes without prior written approval from the laboratory.
- (6) The laboratory is only responsible for the data released by the laboratory, except for the part provided by the applicant.

## 2. Product Information

### 2.1 Application Information

Company Name:	FOXX Development Inc.
Address:	3480 Preston Ridge Road, Suite500, Alpharetta, GA 30005, USA

### 2.2 Manufacturer Information

Company Name:	FOXX Development Inc.
Address:	3480 Preston Ridge Road, Suite500, Alpharetta, GA 30005, USA

### 2.3 Factory Information

Company Name:	FOXX Development Inc.
Address:	3480 Preston Ridge Road, Suite500, Alpharetta, GA 30005, USA

### 2.4 General Description of Equipment under Test (EUT)

EUT Name	Smart Phone
Under Test Model Name	A55AM
Series Model Name	N/A
Description of Model name differentiation	N/A
Hardware Version	N/A
Software and Firmware Version	N/A
Dimensions (Approx.)	148*71*10mm
Weight (Approx.)	162g

## 2.5 Equipment under Test Ancillary Equipment

Ancillary Equipment 1	Battery	
	Brand Name	FOXXD
	Model No.	A55AM
	Serial No.	N/A
	Capacity	Typical capacity: 2000mAh
	Rated Voltage	3.7 V

## 2.6 Technical Information

Network and Wireless connectivity	2G Network GSM/GPRS/EGPRS 850/1900 3G Network WCDMA/HSDPA/HSUPA Band 2/4/5 4G Network FDD LTE Band 2/4/5/12/25/26/66/71 TDD LTE Band 41 2.4G WIFI 802.11b, 802.11g, 802.11n(HT20/40) 5G WIFI 802.11a, 802.11n(HT20/40), 802.11ac(VHT20/40) BT (EDR+BLE)
-----------------------------------	--

### 3. Summary of Test Results

#### 3.1 Test Standards

No.	Identity	Document Title
1	ANSI C63.19-2019	American National Standard for Methods of Measurement of Compatibility between Wireless Communication Devices and Hearing Aids
2	FCC 47 CFR §20.19	Hearing Aid Compatible Mobile Headsets
3	TIA-5050:2018	Telecommunications Communications Products Receive Volume Control Requirements for Wireless (Mobile) Devices
4	KDB285076 D05v01	HACWaiverDA23-914
5	KDB285076 D04v02	Volume Control
6	KDB285076 D01v06r04	HAC Guidance

#### 3.2 Air Interfaces / Bands Indicating Operating Modes

Air Interface	Band	Type	Simultaneous Transmitter	Name of Service
GSM	850	VO	WLAN & BT	CMRS Voice
	1900	VO	WLAN & BT	CMRS Voice
	GPRS/EGPRS	DT	N/A	N/A
WCDMA	Band II	VO	WLAN & BT	CMRS Voice
	Band IV	VO	WLAN & BT	CMRS Voice
	Band V	VO	WLAN & BT	CMRS Voice
	HSPA	DT	N/A	N/A
LTE	Band 2	VD	WLAN & BT	VoLTE
	Band 4	VD	WLAN & BT	VoLTE
	Band 5	VD	WLAN & BT	VoLTE
	Band 12	VD	WLAN & BT	VoLTE
	Band 25	VD	WLAN & BT	VoLTE
	LTE Band 26 part 90	VD	WLAN & BT	VoLTE
	LTE Band 26 part 22	VD	WLAN & BT	VoLTE
	Band 41	VD	WLAN & BT	VoLTE
	Band 66	VD	WLAN & BT	VoLTE
Band 71	VD	WLAN & BT	VoLTE	
WLAN	2.4g&5g	DT	WWAN	N/A
BT	2450	DT	WWAN	N/A

NA: Not Applicable  
VO: Voice Only  
VD: CMRS and IP Voice Service over Digital Transport  
DT: Digital Transport Only

Note: The hearing aid compatibility mode of the prototype was turned on during testing, and all tests were performed in HAC mode.

## 4. Test Uncertainty

UNCERTAINTY EVALUATION FOR AUDIO HAC MEASUREMENT					
Uncertainty Component	Tol (+- %)	Prob. Dist.	Div.	Uncertainty (dB)	Uncertainty (%)
Measurement System					
RF reflections	0.1	R	$\sqrt{3}$	0.06	
Acoustic noise	0.1	R	$\sqrt{3}$	0.06	
Probe coil sensitivity	0.49	R	$\sqrt{3}$	0.28	
Reference signal level	0.25	R	$\sqrt{3}$	0.14	
Positioning accuracy	0.4	R	$\sqrt{3}$	0.23	
Cable loss	0.1	N	2	0.05	
Frequency analyzer	0.15	R	$\sqrt{3}$	0.09	
System repeatability	0.2	N	1	0.20	
Repeatability of the WD	0.4	N	1	0.40	
<b>Combined Standard Uncertainty</b>		N	1	0.61	
<b>Expanded uncertainty (confidence level of 95%,k = 2)</b>		N	K=2	1.22	15.05
<b>REPORTED Expanded uncertainty (confidence level of 95%, k = 2)</b>		N	K=2	1.20	15.00



## 5. Measurement System

### 5.1 MEASUREMENT SET-UP

The general test arrangement is shown in Figure 1. The Call Box passes the voice channel stream to the DUT without modification. There is no gain or loss in the voice channel stream due to the Call Box interface.

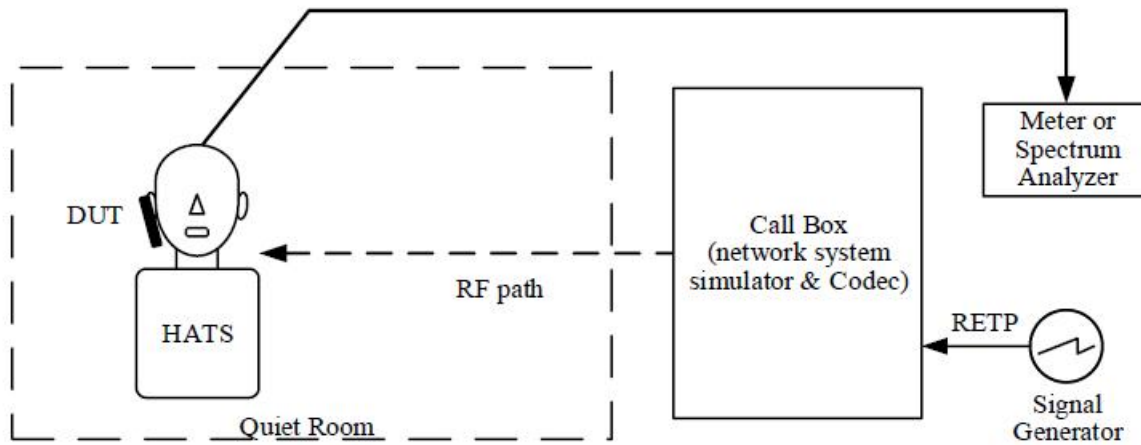

#### NOTES:

1. Additional information related to the air interface for the various RF technologies is specified in several 3GPP documents. A list of these can be found in 3GPP TS 26.132 V14.0.0 clause 4
2. Additional information related to the test setup can be found in 3GPP TS 26.132, V14.0.0 clause 5.1.
3. The RETP (receive electrical test point) is the point in the device test arrangement where signals are applied to the DUT in the receive direction.

## 6. Evaluation of Test

### 6.1 RECEIVE VOLUME CONTROL PERFORMANCE

#### 6.1.1 Requirement

1. With a mounting force of 8N, the DUT shall have at least one volume control setting that will produce a conversational gain of  $\geq 6$  dB with the output distortion and the frequency response meeting the requirements in clause 5.2.1 & 5.3.1 respectively.
2. With a mounting force of 2N, the DUT shall have at least one volume control setting that will produce a conversational gain of  $\geq 6$  dB with the output distortion and the frequency response meeting the requirements in clause 5.2.1 & 5.3.1 respectively.

*NOTE: Other acoustic receive features may be available such as additional amplification, tone control, automatic gain control, etc. ANSI/TIA-4953-B contains performance requirements for output levels and tone control operation for amplified devices.*

#### 6.1.2 Method of Measurement

1. Configure the DUT with a mounting force of 8N and test equipment as shown in Figure 1 in an active call state with the applicable codec for the transmission mode under test.
2. Set the DUT volume control to the maximum setting.
3. If the DUT has an adjustable tone control feature, a tone control setting that meets the frequency response requirements in section 5.3.1 shall be used.
4. Apply the real speech test signal at a level of -20 dBm0 at the RETP and measure the acoustic output at the Drum Reference Point (DRP) over one complete sequence of the test signal.
5. Translate the measurement made at the DRP to the Free Field (FF) using the translation data in Annex B.
6. Over the applicable frequency band, determine the ASL in dBSPL for the resulting sound pressure level in accordance with Method B of ITU-T Recommendation P.56:
  - a. Narrowband 100 Hz through 4000 Hz.
  - b. Wideband 100 Hz through 7720 Hz.
7. Calculate the Conversational Gain by subtracting 70 dB from the measured dBSPL.  
[Conversational Gain = (Measured dBSPL Level – 70 dBSPL) dB]
8. Measure the output distortion per clause 5.2. If a distortion failure occurs at the maximum volume control setting, reduce the volume control setting and repeat the measurement to determine if a setting can be found for which the conversational gain requirement is met without a distortion failure.
9. Repeat steps 2-8 with a mounting force of 2N.

#### 6.1.3 Test Result

Refer to test Annex A.

Remark: The report only reflects the test data plots of worst mode (for GSM 1900, WCDMA Band 4, LTE Band 41, 5.8G WIFI)

#### 6.1.4 Test Conclusion

PASS.

## 6.2 RECEIVE DISTORTION AND NOISE PERFORMANCE

### 6.2.1 Requirement

With a mounting force of 8N and 2N, the ratio of the stimulus signal power to the 100 Hz to 8000 Hz total A-weighted distortion and noise power shall be  $\geq 20$  dB when tested over the range of 1/3 octave band center frequencies:

1. Narrowband transmission mode: Each 1/3 octave band center frequency from 400 Hz to 3150 Hz.
2. Wideband transmission mode: Each 1/3 octave band center frequency from 250 Hz to 5000 Hz.

### 6.2.2 Method of Measurement

1. Configure the DUT with a mounting force of 8N and test equipment as shown in Figure 1 in an active call state with the applicable codec for the transmission mode under test with the volume control at the setting determined in 5.1.1.
2. Receive distortion and noise is measured using the PN-SDNR procedure as described in Annex A.
3. To ensure DUT activation, apply the real speech test signal at a level of -20 dBm0 followed immediately by the initial 1/3 octave center frequency PN test signal in Table A.1 based on the narrowband or wideband operating mode. Measure the acoustic output at the DRP over the complete sequence of the PN test signal.
4. Translate the measurement made at the DRP to the FF using the translation data in Annex B.
5. Calculate the acoustic output unweighted total signal power of the stimulus measurement band as described in A.2.
6. Calculate the notched A-weighting distortion and noise components as described in A.3.
7. Calculate the ratio of the signal power to the total A-weighted distortion and noise power using Eq A-1.
8. Repeat for each of the remaining 1/3 octave center frequencies in Table A.1 based on the narrowband or wideband operating mode.
9. Repeat steps 2-8 with a mounting force of 2N.

### 6.2.3 Test Result

Refer to test Annex A.

Remark: The report only reflects the test data plots of worst mode (for GSM 1900, WCDMA Band 4, LTE Band 41, 5.8G WIFI)

### 6.2.4 Test Conclusion

PASS.

### 6.3 RECEIVE ACOUSTIC FREQUENCY RESPONSE PERFORMANCE

#### 6.3.1 Requirement

1. Narrowband: The 1/12 octave band frequency response after translation to the FF or DF shall fall between the upper and lower limits given in Table 1 and shown in Figure below.

Table 1 – Narrowband Receive Frequency Response Limits

Lower Limit Frequency (Hz)	Lower Limit (dB)	Upper Limit Frequency (Hz)	Upper Limit (dB)
300	-6	100	+6
3400	-6	4000	+6

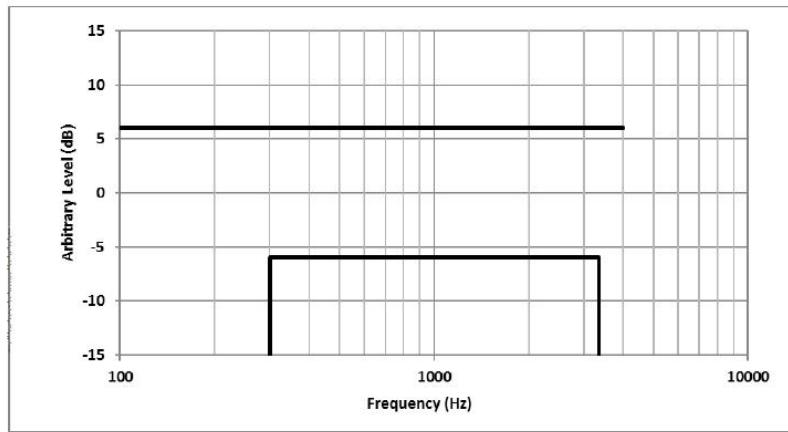

2. Wideband: The 1/12 octave band frequency response after translation to the FF or DF shall fall between the upper and lower limits given in Table 2 and shown in Figure below.

Table 2 – Wideband Receive Frequency Response Limits

Lower Limit Frequency (Hz)	Lower Limit (dB)	Upper Limit Frequency (Hz)	Upper Limit (dB)
200	-10	100	+6
300	-6	1000	+6
5000	-6	2000	+8
6300	-12	8000	+8

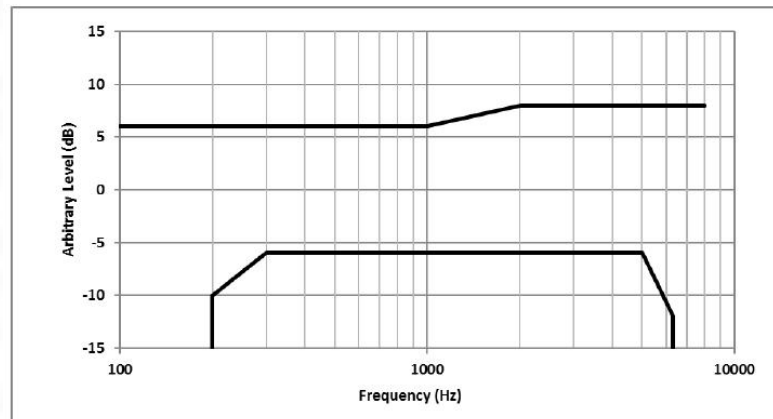

### 6.3.2 Method of Measurement

1. Configure the DUT with a mounting force of 8N and test equipment as shown in Figure 1 in an active call state with the applicable codec for the transmission mode under test with the volume control at the setting determined in 5.1.1.
2. If the DUT has an adjustable tone control feature the initial measurement is to be performed with the default tone control setting.
3. Apply the real speech test signal with a level of -20 dBm0 at the RETP.
4. Capture the frequency spectrum at the DRP of the HATS using real-time analysis with 1/12 octave bands over the frequency range from 100 Hz to 4000 Hz for narrowband measurements, or over the frequency range from 100 Hz to 8000 Hz for wideband measurements, averaged over the entire duration of the test signal.
5. Transform the DRP frequency spectrum measurement to the FF or DF (see Annex B).
6. Divide the 1/12 octave measurement data by the 1/12 octave frequency spectrum of the test signal at the RETP and present the measurement in terms of dB(Pa/V).
7. Apply the applicable frequency response limits to determine compliance.
8. If the default tone control setting does not meet the requirement, repeat the above steps for other tone control settings to determine a tone control setting that meets the requirements.
9. Repeat with a mounting force of 2N.

### 6.3.3 Test Result

Refer to test Annex A.

Remark: The report only reflects the test data plots of worst mode (for GSM 1900, WCDMA Band 4, LTE Band 41, 5.8G WIFI)

### 6.3.4 Test Conclusion

PASS.

## 7. Test Equipment List

Description	Manufacturer	Model	Internal number	Cal. Date	Cal. Due
WIDEBAND RADIO COMMUNICATION TESTER	ROHDE&SCHWARZ	CMW500	BTF-EM-023	2023/11/16	2024/11/15
Conditioning Amplifier	Brule&Kjaer	Type -2690--030	BTF-EM-146	2024/1/30	2025/1/29
Head and Torso Simulator	Brule&Kjaer	Type 4128C	BTF-EM-148	2024/1/30	2025/1/29
Sound Calibration	Brule&Kjaer	Type 4231	BTF-EM-149	2024/1/30	2025/1/29
Anechoic Test Chamber	MEC	Type 115	BTF-EM-150	N/A	N/A

## 8. Air Interfaces / Bands used for testing

Air-interface	Band	Tested Codec	Tested Rate(kbps)
GSM	850/1900	EFR	/
WCDMA(UMTS)	Band 2/4/5	AMR-NB	4.75/12.2
		AMR-WB	6.6/23.85
VoLTE	Band 2/4/5/12/25/26/41/66/71	AMR-NB	4.75/12.2
		AMR-WB	6.6/23.85
VoWIFI	2.4G/5G	AMR-NB	4.75/12.2
		AMR-WB	6.6/23.85

## 9. Test Result

### 9.1 Receive volume control, distortion and noise performance

Plot No.	Mode	Channel/Freq.	BW	Codec B itrate	Volume Level	Codec T ype	Codec B andwid th	Mountin g Force (N)	Frequ ency(H Z)	Min PN- SDNR(d B)	PN-SDN R Limb (dB)	Signal Q uality (d B)	Convers ational Gain	FCC CG Limit (d B)	CG Mar gin (dB)	Verdi ct
1	GSM850	128/824.2MHz	/	/	Max	EFR	NB	8N	3150	21.53	20.00	88.34	18.34	6.00	12.34	Pass
			/	/	Max	EFR	NB	2N	3150	21.61	20.00	88.48	18.48	6.00	12.48	
2	PCS1900	810/1909.8MHz	/	/	Max	EFR	NB	8N	3150	<b>21.40</b>	20.00	88.07	<b>18.07</b>	6.00	12.07	Pass
			/	/	Max	EFR	NB	2N	3150	<b>21.45</b>	20.00	88.23	<b>18.23</b>	6.00	12.23	
3	WCDMA Band II	9262/1852.4MHz	/	12.20	Max	AMR	NB	8N	1250	20.49	20.00	89.45	19.45	6.00	13.45	Pass
			/	12.20	Max	AMR	NB	2N	2000	20.66	20.00	89.94	19.94	6.00	13.94	
			/	23.85	Max	AMR	WB	8N	1250	20.51	20.00	89.62	19.62	6.00	13.62	
			/	23.85	Max	AMR	WB	2N	2000	20.78	20.00	90.01	20.01	6.00	14.01	
4	WCDMA Band IV	1413/1732.6MHz	/	12.20	Max	AMR	NB	8N	1250	<b>20.26</b>	20.00	89.21	<b>19.21</b>	6.00	13.21	Pass
			/	12.20	Max	AMR	NB	2N	2000	<b>20.37</b>	20.00	89.72	<b>19.72</b>	6.00	13.72	
			/	23.85	Max	AMR	WB	8N	1250	20.35	20.00	89.77	19.77	6.00	13.77	
			/	23.85	Max	AMR	WB	2N	2000	20.47	20.00	90.03	20.03	6.00	14.03	
5	WCDMA Band V	4132/826.4MHz	/	12.20	Max	AMR	NB	8N	1250	20.38	20.00	89.36	19.36	6.00	13.36	Pass
			/	12.20	Max	AMR	NB	2N	2000	20.54	20.00	89.96	19.96	6.00	13.96	
			/	23.85	Max	AMR	WB	8N	1250	20.42	20.00	89.65	19.65	6.00	13.65	
			/	23.85	Max	AMR	WB	2N	2000	20.63	20.00	90.12	20.12	6.00	14.12	
6	LTE FDD Band 2	18700/1860.0MHz	20MHz_QPSK_1_50	12.20	Max	AMR	NB	8N	2000	20.82	20.00	89.08	19.08	6.00	13.08	Pass
				12.20	Max	AMR	NB	2N	1250	20.61	20.00	89.15	19.15	6.00	13.15	
				23.85	Max	AMR	WB	8N	2000	20.77	20.00	89.20	19.20	6.00	13.20	
				23.85	Max	AMR	WB	2N	1250	20.49	20.00	89.34	19.34	6.00	13.34	
7	LTE FDD Band 4	20175/1732.5MHz	20MHz_QPSK_1_50	12.20	Max	AMR	NB	8N	3150	20.95	20.00	88.98	18.98	6.00	12.98	Pass
				12.20	Max	AMR	NB	2N	2000	20.81	20.00	89.02	19.02	6.00	13.02	
				23.85	Max	AMR	WB	8N	3150	20.86	20.00	89.10	19.10	6.00	13.10	
				23.85	Max	AMR	WB	2N	2000	20.62	20.00	89.28	19.28	6.00	13.28	
8	LTE FDD Band 5	20450/829.0MHz	10MHz_QPSK_1_0	12.20	Max	AMR	NB	8N	1250	20.78	20.00	89.16	19.16	6.00	13.16	Pass
				12.20	Max	AMR	NB	2N	3150	20.44	20.00	89.28	19.28	6.00	13.28	
				23.85	Max	AMR	WB	8N	1250	20.84	20.00	89.03	19.03	6.00	13.03	
				23.85	Max	AMR	WB	2N	3150	20.55	20.00	89.11	19.11	6.00	13.11	
9	LTE FDD Band 12	23060/704.0MHz	10MHz_QPSK_1_25	12.20	Max	AMR	NB	8N	1250	21.16	20.00	88.86	18.86	6.00	12.86	Pass
				12.20	Max	AMR	NB	2N	2500	20.92	20.00	88.99	18.99	6.00	12.99	
				23.85	Max	AMR	WB	8N	1250	21.33	20.00	89.04	19.04	6.00	13.04	
				23.85	Max	AMR	WB	2N	2500	21.08	20.00	89.27	19.27	6.00	13.27	
10	LTE FDD Band 25	26140/1860.0MHz	20MHz_QPSK_1_50	12.20	Max	AMR	NB	8N	2500	20.97	20.00	89.34	19.34	6.00	13.34	Pass
				12.20	Max	AMR	NB	2N	3150	20.75	20.00	89.16	19.16	6.00	13.16	
				23.85	Max	AMR	WB	8N	2500	21.14	20.00	89.21	19.21	6.00	13.21	
				23.85	Max	AMR	WB	2N	3150	21.03	20.00	89.45	19.45	6.00	13.45	



Plot No.	Mode	Channel/Freq.	BW	Codec B itrate	Volume Level	Codec T ype	Codec B andwidth	Mountin g Force (N)	Frequen cy(H Z)	Min PN-SDNR(d B)	PN-SDNR Limb (dB)	Signal Q uality (d B)	Convers ational Gain	FCC CG Limit (d B)	CG Mar gin (dB)	Verdi ct
11	LTE FDD Band 26 Part90	26740/819.0MHz	10MHz_QPSK_1_0	12.20	Max	AMR	NB	8N	2000	20.98	20.00	88.93	18.93	6.00	12.93	Pass
				12.20	Max	AMR	NB	2N	3150	20.59	20.00	89.06	19.06	6.00	13.06	
				23.85	Max	AMR	WB	8N	2500	21.16	20.00	89.37	19.37	6.00	13.37	
				23.85	Max	AMR	WB	2N	3150	20.87	20.00	89.48	19.48	6.00	13.48	
12	LTE FDD Band 26 Part22	26865/831.5MHz	15MHz_QPSK_1_0	12.20	Max	AMR	NB	8N	1250	20.92	20.00	88.89	18.89	6.00	12.89	Pass
				12.20	Max	AMR	NB	2N	2000	20.51	20.00	89.01	19.01	6.00	13.01	
				23.85	Max	AMR	WB	8N	1250	21.09	20.00	89.26	19.26	6.00	13.26	
				23.85	Max	AMR	WB	2N	2000	20.83	20.00	89.41	19.41	6.00	13.41	
13	LTE TDD Band 41	41490/2680.0MHz	20MHz_QPSK_1_50	12.20	Max	AMR	NB	8N	2000	<b>20.70</b>	20.00	88.79	<b>18.79</b>	6.00	12.79	Pass
				12.20	Max	AMR	NB	2N	1250	<b>20.35</b>	20.00	88.93	<b>18.93</b>	6.00	12.93	
				23.85	Max	AMR	WB	8N	2000	20.89	20.00	88.98	18.98	6.00	12.98	
				23.85	Max	AMR	WB	2N	1250	20.47	20.00	89.15	19.15	6.00	13.15	
14	LTE FDD Band 66	132322/1745.0MHz	20MHz_QPSK_1_50	12.20	Max	AMR	NB	8N	2500	21.06	20.00	89.13	19.13	6.00	13.13	Pass
				12.20	Max	AMR	NB	2N	2000	20.78	20.00	89.02	19.02	6.00	13.02	
				23.85	Max	AMR	WB	8N	2500	21.35	20.00	89.20	19.20	6.00	13.20	
				23.85	Max	AMR	WB	2N	2000	20.96	20.00	89.41	19.41	6.00	13.41	
15	LTE FDD Band 71	133222/673.0MHz	20MHz_QPSK_1_50	12.20	Max	AMR	NB	8N	3150	20.88	20.00	89.25	19.25	6.00	13.25	Pass
				12.20	Max	AMR	NB	2N	1250	20.79	20.00	89.46	19.46	6.00	13.46	
				23.85	Max	AMR	WB	8N	3150	21.02	20.00	89.84	19.84	6.00	13.84	
				23.85	Max	AMR	WB	2N	1250	20.92	20.00	89.99	19.99	6.00	13.99	
16	2.4G WIFI 802.11g	11/2462.0MHz	/	12.20	Max	AMR	NB	8N	2000	20.74	20.00	89.58	19.58	6.00	13.58	Pass
				12.20	Max	AMR	NB	2N	1250	20.53	20.00	89.74	19.74	6.00	13.74	
				23.85	Max	AMR	WB	8N	2000	20.85	20.00	89.71	19.71	6.00	13.71	
				23.85	Max	AMR	WB	2N	1250	20.66	20.00	89.87	19.87	6.00	13.87	
17	5.2G WIFI 802.11n(HT40)	38/5190.0MHz	/	12.20	Max	AMR	NB	8N	1250	20.80	20.00	89.63	19.63	6.00	13.63	Pass
				12.20	Max	AMR	NB	2N	1250	20.38	20.00	89.57	19.57	6.00	13.57	
				23.85	Max	AMR	WB	8N	1250	20.89	20.00	89.88	19.88	6.00	13.88	
				23.85	Max	AMR	WB	2N	1250	20.42	20.00	90.06	20.06	6.00	14.06	
18	5.8G WIFI 802.11ac(VHT40)	151/5755.0MHz	/	12.20	Max	AMR	NB	8N	1250	<b>20.60</b>	20.00	89.34	<b>19.34</b>	6.00	13.34	Pass
				12.20	Max	AMR	NB	2N	1250	<b>20.06</b>	20.00	89.47	<b>19.47</b>	6.00	13.47	
				23.85	Max	AMR	WB	8N	1250	20.77	20.00	89.49	19.49	6.00	13.49	
				23.85	Max	AMR	WB	2N	1250	20.25	20.00	89.62	19.62	6.00	13.62	



9.2 Receive acoustic frequency response performance

Plot No.	Mode	Channel/Freq.	BW	Volume Level	Codec Type	Codec Bandwidth	Mounting Force (N)	RFR
								Test Result
1	GSM850	128/824.2MHz	/	Max	EFR	NB	2N	Pass
				Max	EFR	NB	8N	
2	PCS1900	810/1909.8MHz	/	Max	EFR	NB	2N	Pass
				Max	EFR	NB	8N	
3	WCDMA Band II	9262/1852.4MHz	/	Max	AMR	NB	2N	Pass
				Max	AMR	NB	8N	
				Max	AMR	WB	2N	
4	WCDMA Band IV	1413/1732.6MHz	/	Max	AMR	WB	8N	Pass
				Max	AMR	NB	2N	
				Max	AMR	NB	8N	
5	WCDMA Band V	4132/826.4MHz	/	Max	AMR	NB	2N	Pass
				Max	AMR	NB	8N	
				Max	AMR	WB	2N	
6	LTE FDD Band 2	18700/1860.0MHz	20MHz_QPSK_1_50	Max	AMR	WB	8N	Pass
				Max	AMR	NB	2N	
				Max	AMR	NB	8N	
7	LTE FDD Band 4	20175/1732.5MHz	20MHz_QPSK_1_50	Max	AMR	WB	8N	Pass
				Max	AMR	NB	2N	
				Max	AMR	NB	8N	
8	LTE FDD Band 5	20450/829.0MHz	10MHz_QPSK_1_0	Max	AMR	WB	8N	Pass
				Max	AMR	NB	2N	
				Max	AMR	NB	8N	
9	LTE FDD Band 12	23060/704.0MHz	10MHz_QPSK_1_25	Max	AMR	WB	8N	Pass
				Max	AMR	NB	2N	
				Max	AMR	NB	8N	
				Max	AMR	WB	8N	
				Max	AMR	WB	2N	
				Max	AMR	WB	8N	
10	LTE FDD Band 25	26140/1860.0MHz	20MHz_QPSK_1_50	Max	AMR	NB	2N	Pass
				Max	AMR	NB	8N	
				Max	AMR	WB	2N	
				Max	AMR	WB	8N	

Plot No.	Mode	Channel/Freq.	BW	Volume Level	Codec Type	Codec Bandwidth	Mounting Force (N)	RFR
								Test Result
11	LTE FDD Band 26 Part90	26740/819.0MHz	10MHz_QPSK_1_0	Max	AMR	NB	2N	Pass
				Max	AMR	NB	8N	
				Max	AMR	WB	2N	
				Max	AMR	WB	8N	
12	LTE FDD Band 26 Part22	26865/831.5MHz	15MHz_QPSK_1_0	Max	AMR	NB	2N	Pass
				Max	AMR	NB	8N	
				Max	AMR	WB	2N	
				Max	AMR	WB	8N	
13	LTE TDD Band 41	41490/2680.0MHz	20MHz_QPSK_1_50	Max	AMR	NB	2N	Pass
				Max	AMR	NB	8N	
				Max	AMR	WB	2N	
				Max	AMR	WB	8N	
14	LTE FDD Band 66	132322/1745.0MHz	20MHz_QPSK_1_50	Max	AMR	NB	2N	Pass
				Max	AMR	NB	8N	
				Max	AMR	WB	2N	
				Max	AMR	WB	8N	
15	LTE FDD Band 71	133222/673.0MHz	20MHz_QPSK_1_50	Max	AMR	NB	2N	Pass
				Max	AMR	NB	8N	
				Max	AMR	WB	2N	
				Max	AMR	WB	8N	
16	2.4G WIFI 802.11g	11/2462.0MHz	/	Max	AMR	NB	2N	Pass
				Max	AMR	NB	8N	
				Max	AMR	WB	2N	
				Max	AMR	WB	8N	
17	5.2G WIFI 802.11n(HT40)	38/5190.0MHz	/	Max	AMR	NB	2N	Pass
				Max	AMR	NB	8N	
				Max	AMR	WB	2N	
				Max	AMR	WB	8N	
18	5.8G WIFI 802.11ac(VHT40)	151/5755.0MHz	/	Max	AMR	NB	2N	Pass
				Max	AMR	NB	8N	
				Max	AMR	WB	2N	
				Max	AMR	WB	8N	

## 10. EUT photograph

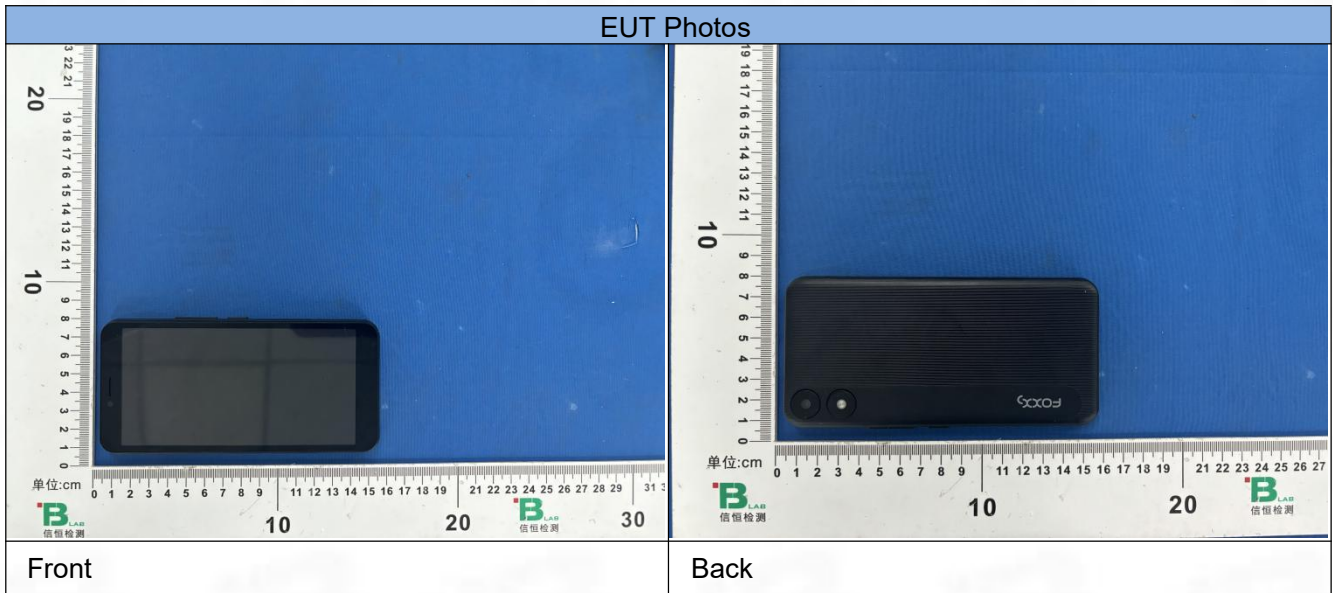

## Volume Control Verification Test Results

Date of Testing	Test Location	Air Interface Equipment	Acoustical Calibrator	HATS Sens.(dB)	Ambient Noise(dBA)
5/7/2024	Whisper 1	CMW 500	Type 4182C	97.37	32.59
5/7/2024	Whisper 1	CMW 500	Type 4182C	97.28	32.03
5/7/2024	Whisper 1	CMW 500	Type 4182C	97.33	32.10

## ANNEX A Test Data

### 1. GSM 1900 in channel 810

#### 1.1 Receive Distortion and Noise 8N NB

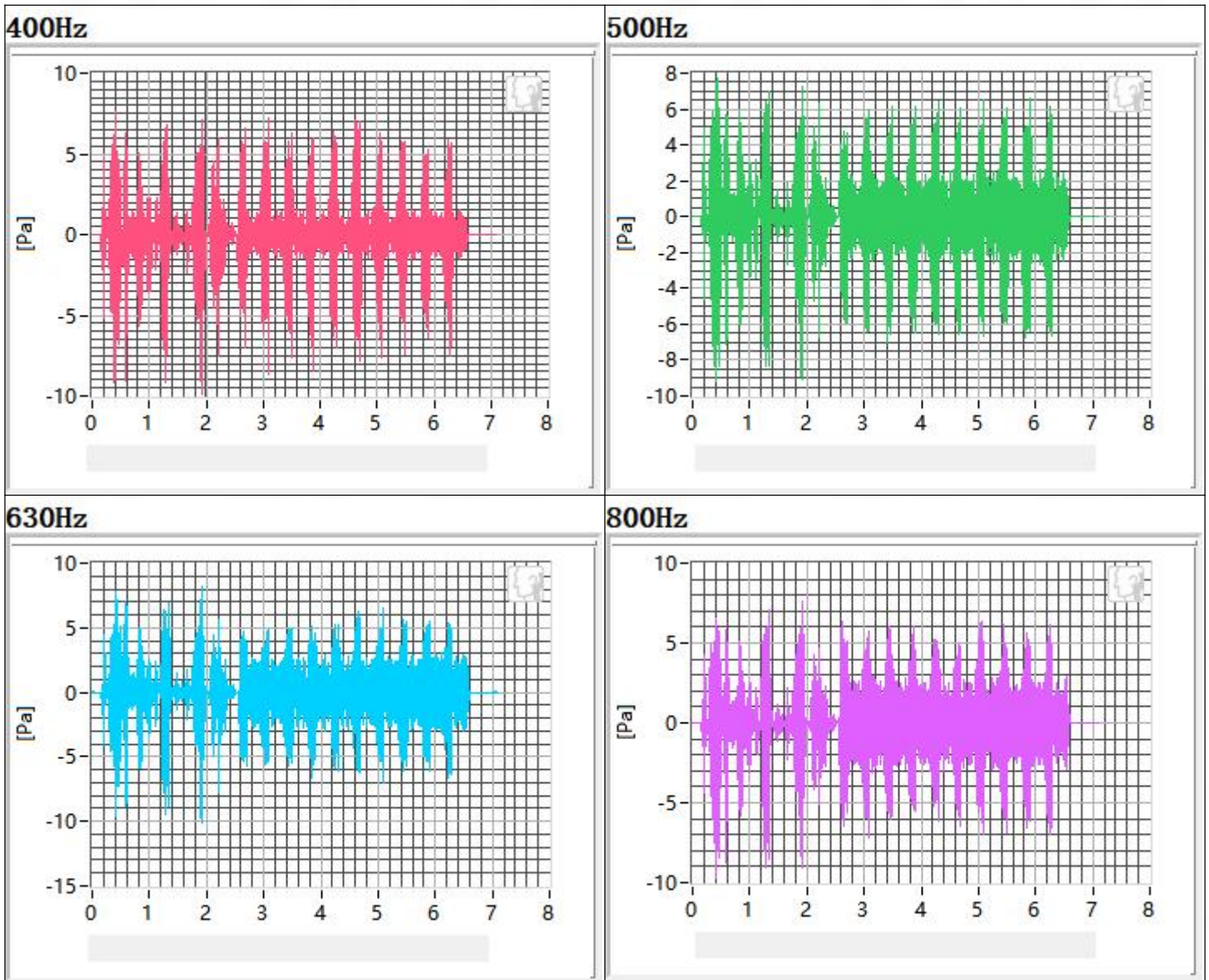

1000Hz

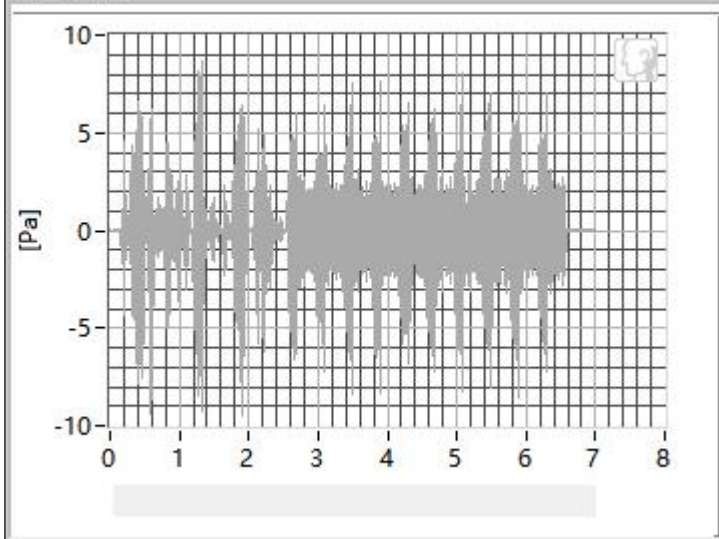

1250Hz

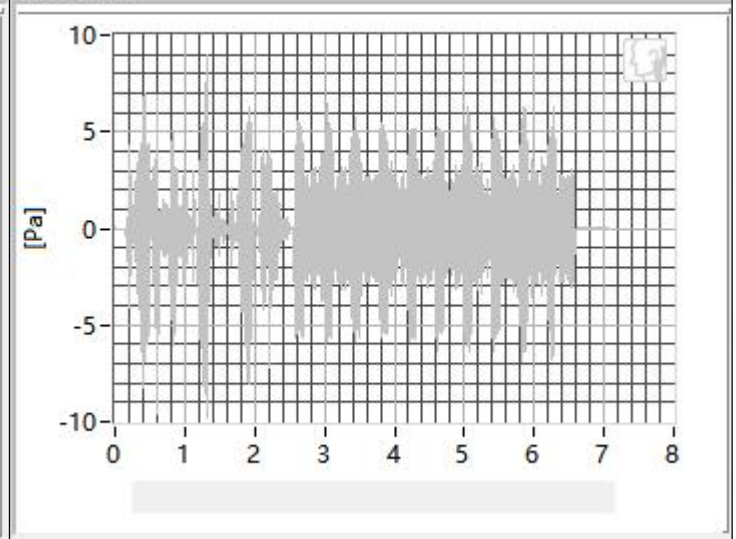

1600Hz

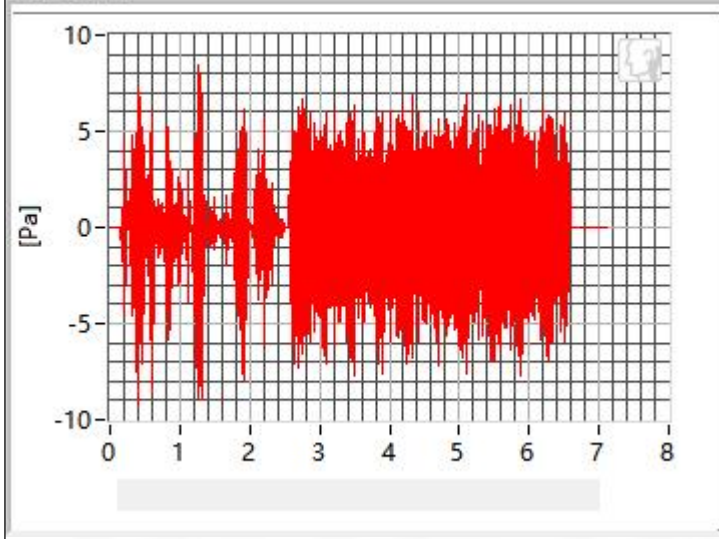

2000Hz

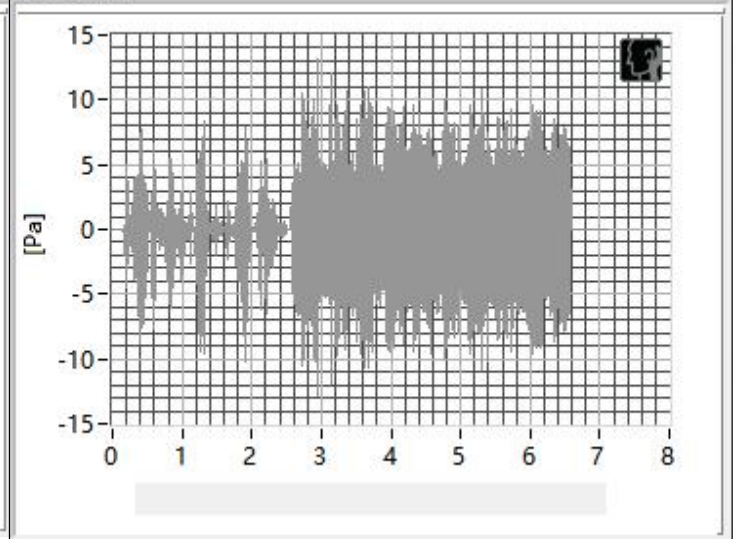

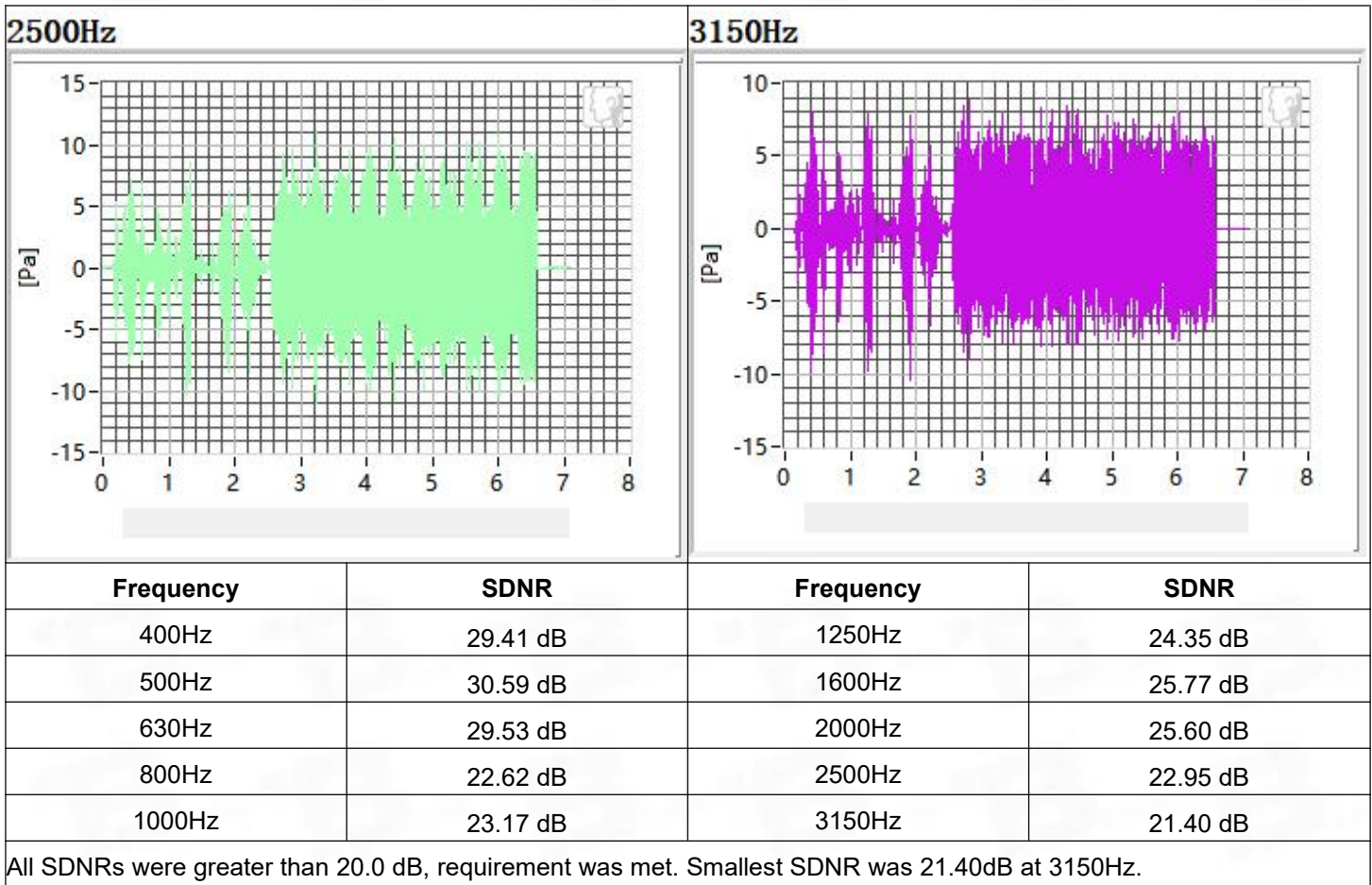

## 1.2 Receive Distortion and Noise 2N NB

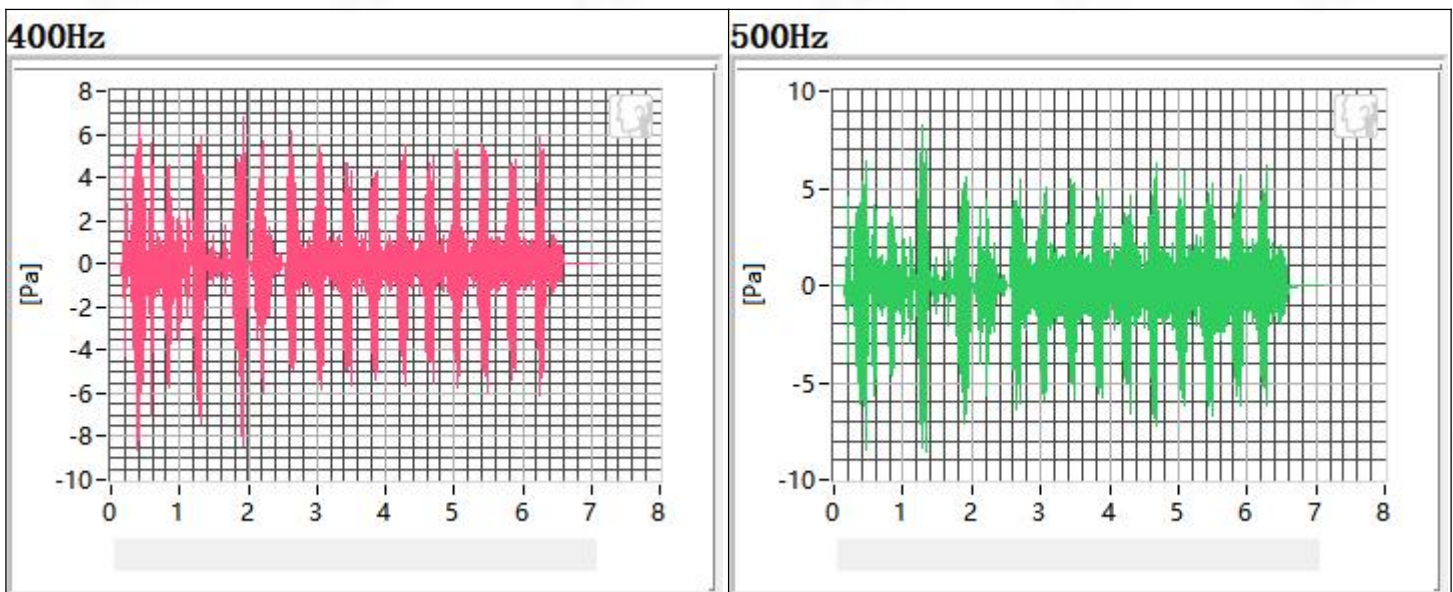

630Hz

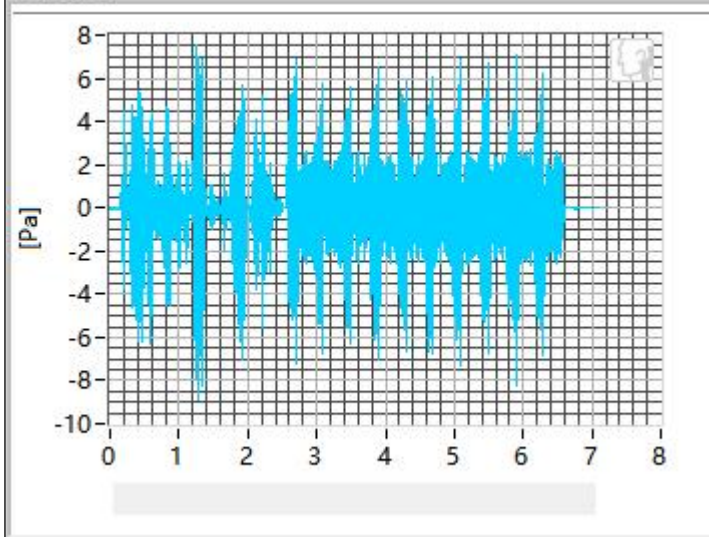

800Hz

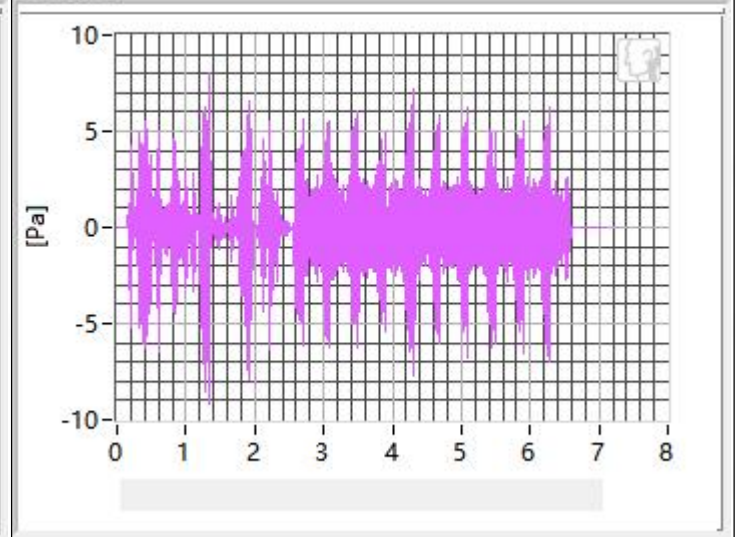

1000Hz

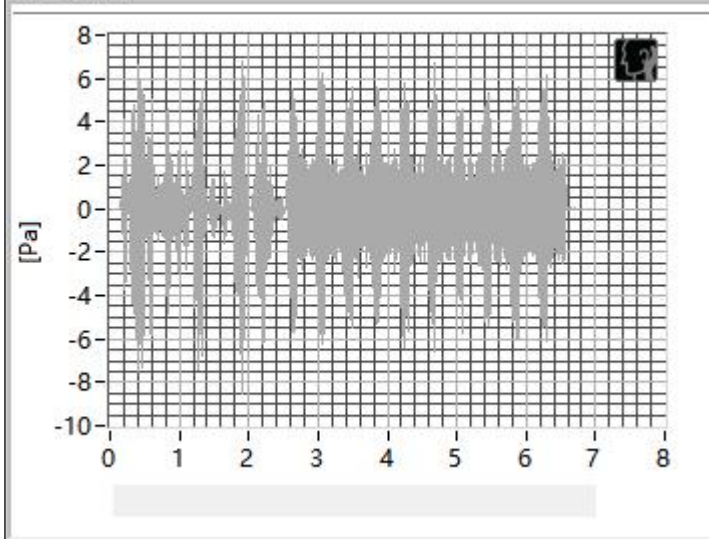

1250Hz

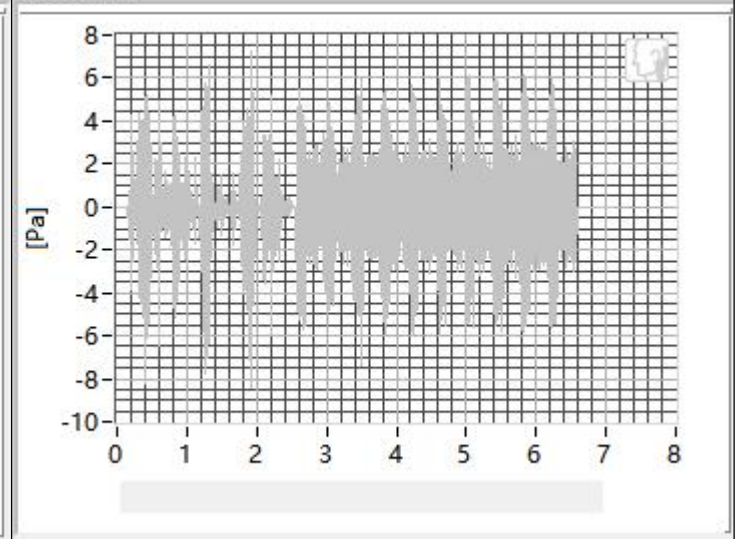

1600Hz

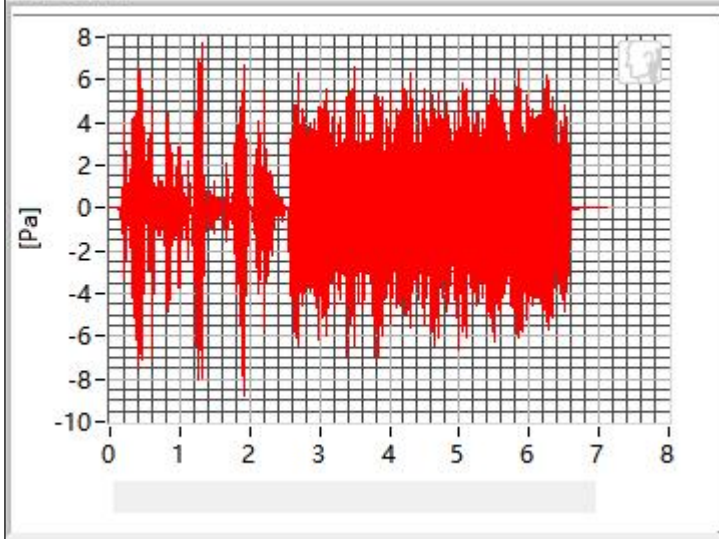

2000Hz

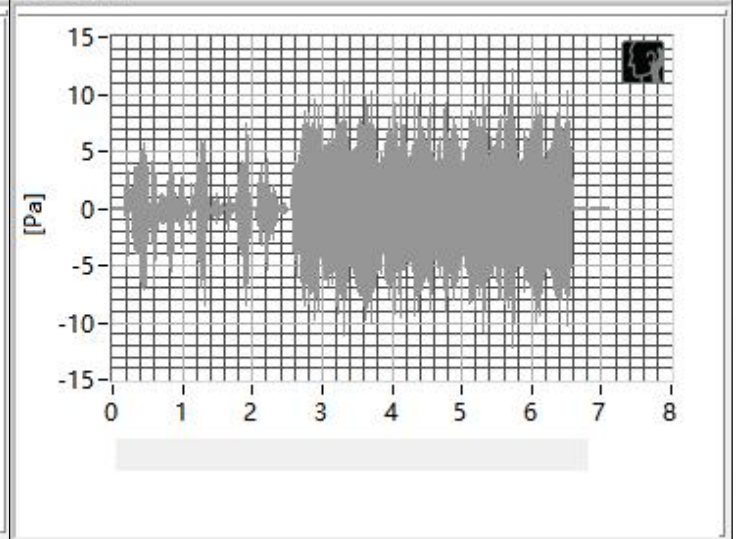

2500Hz

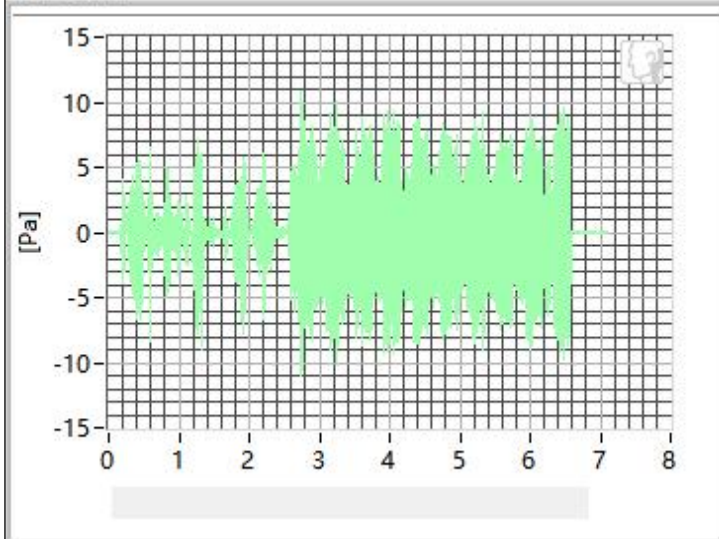

3150Hz

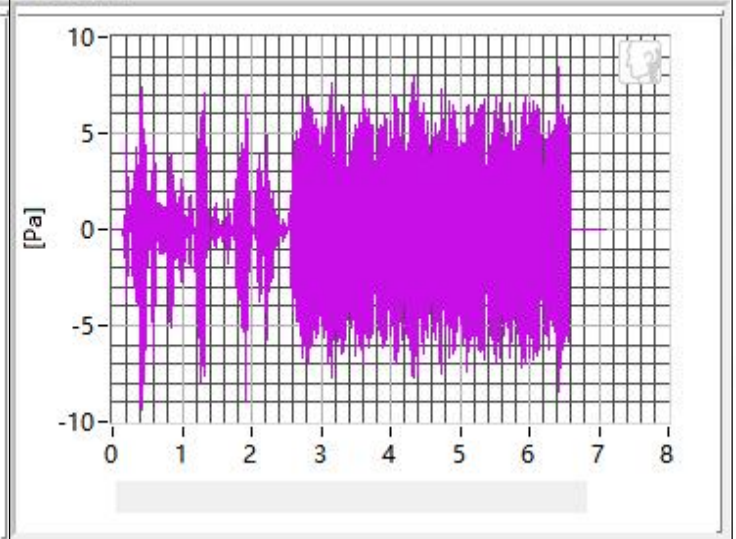

Frequency	SDNR	Frequency	SDNR
400Hz	29.59 dB	1250Hz	24.21 dB
500Hz	29.90 dB	1600Hz	25.54 dB
630Hz	28.54 dB	2000Hz	25.36 dB
800Hz	21.92 dB	2500Hz	22.04 dB
1000Hz	24.38 dB	3150Hz	21.45 dB

All SDNRs were greater than 20.0 dB, requirement was met. Smallest SDNR was 21.45dB at 3150Hz.



### 1.3 Receive Frequency Response

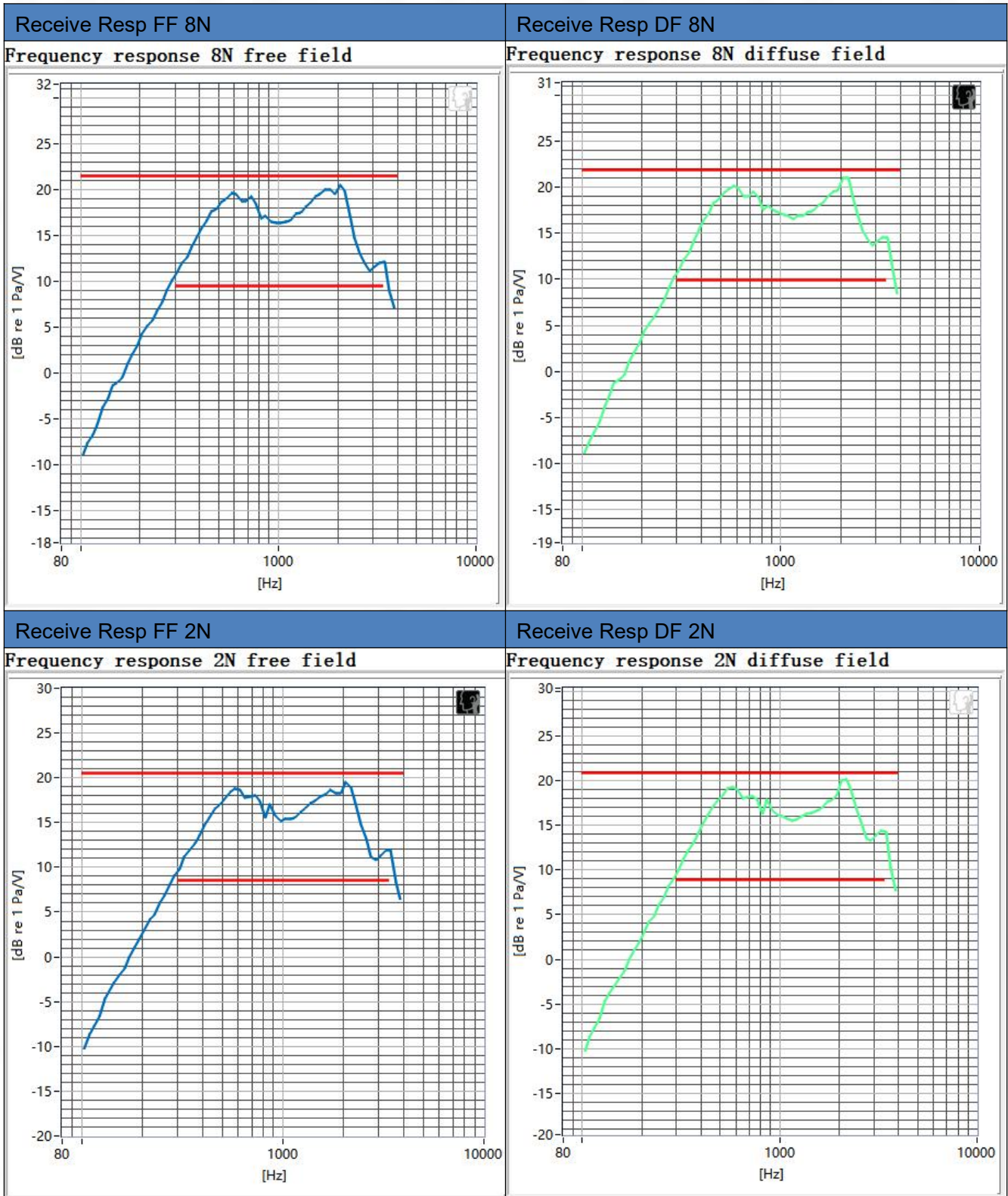

## 2. WCDMA band 4 in channel 1413

### 2.1 Receive Distortion and Noise 8N NB

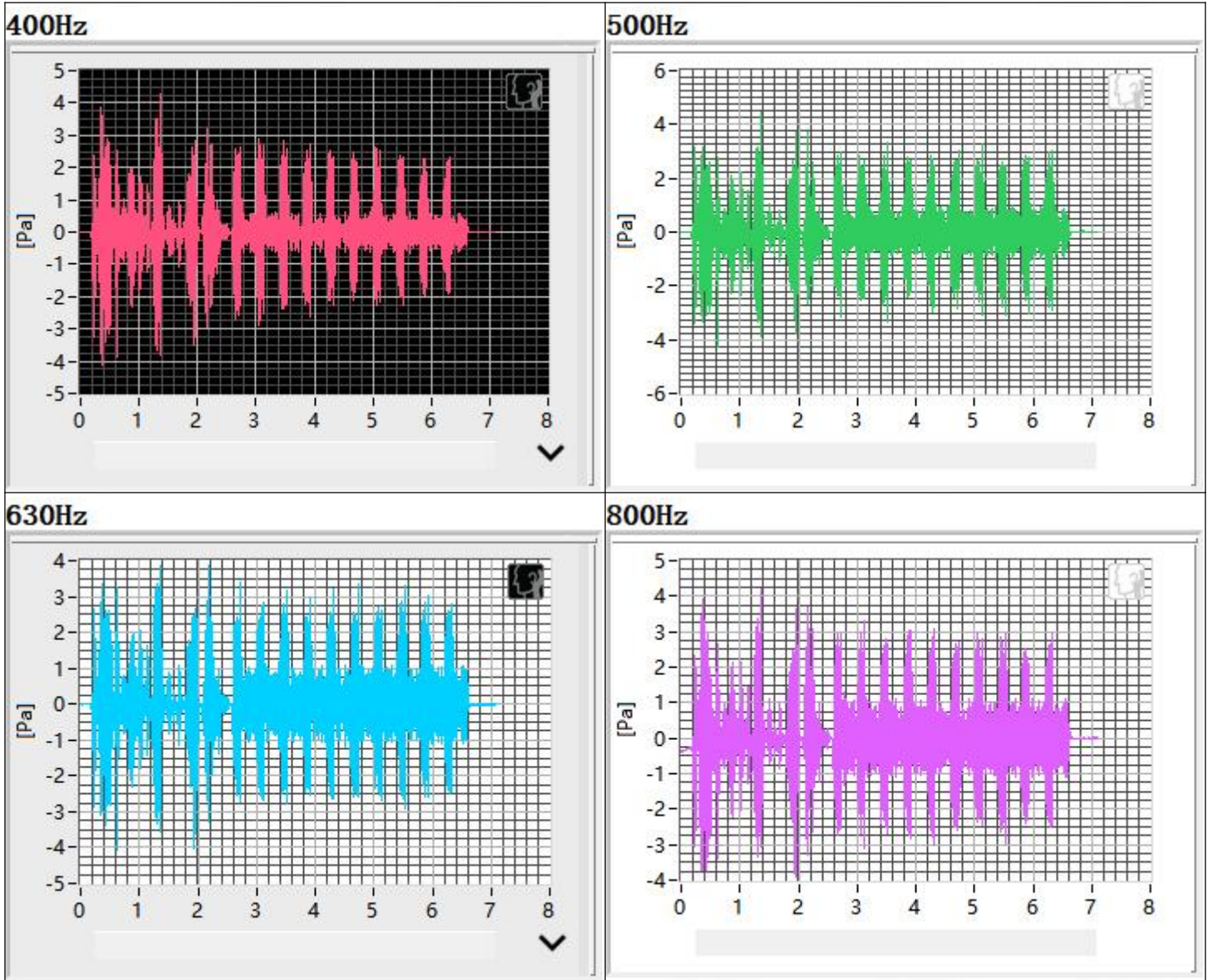

1000Hz

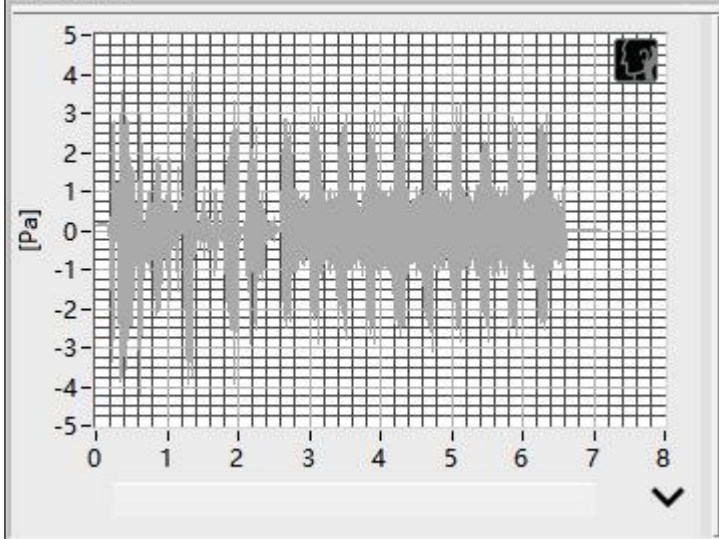

1250Hz

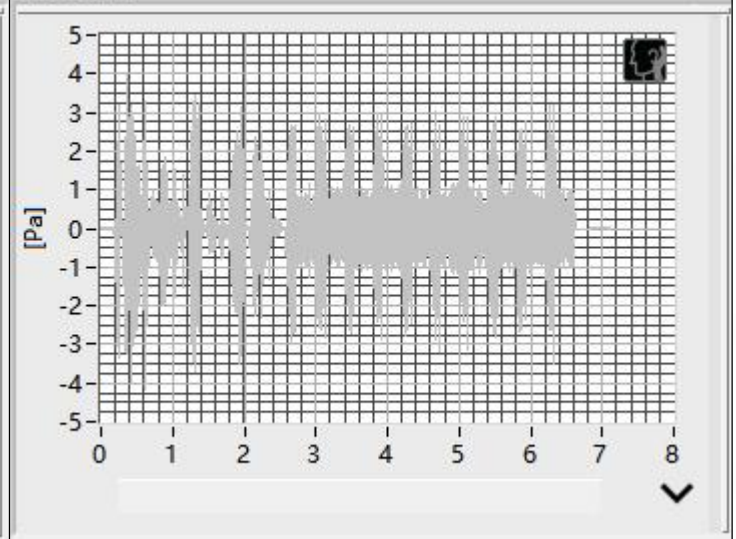

1600Hz

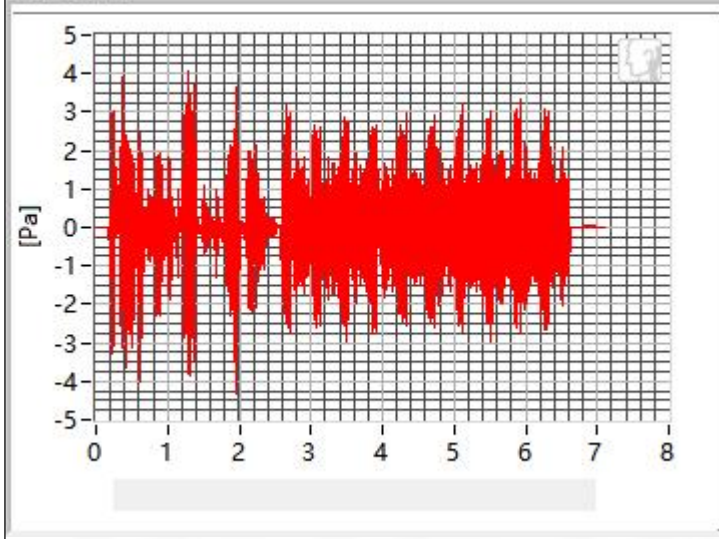

2000Hz

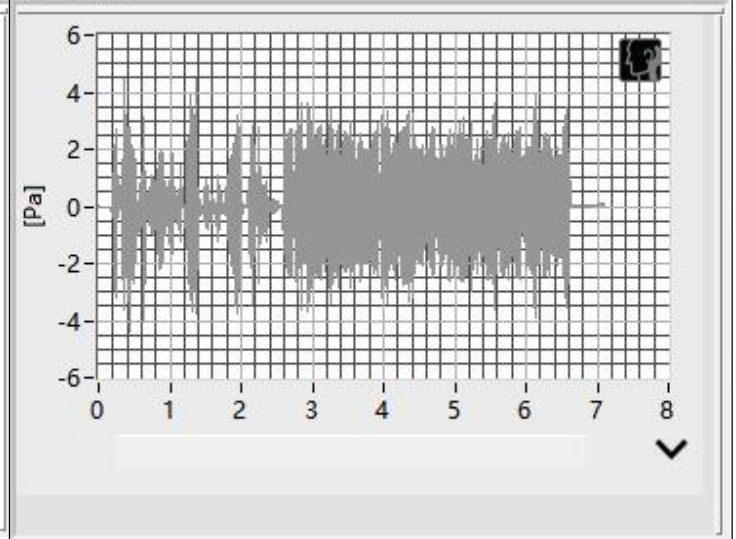

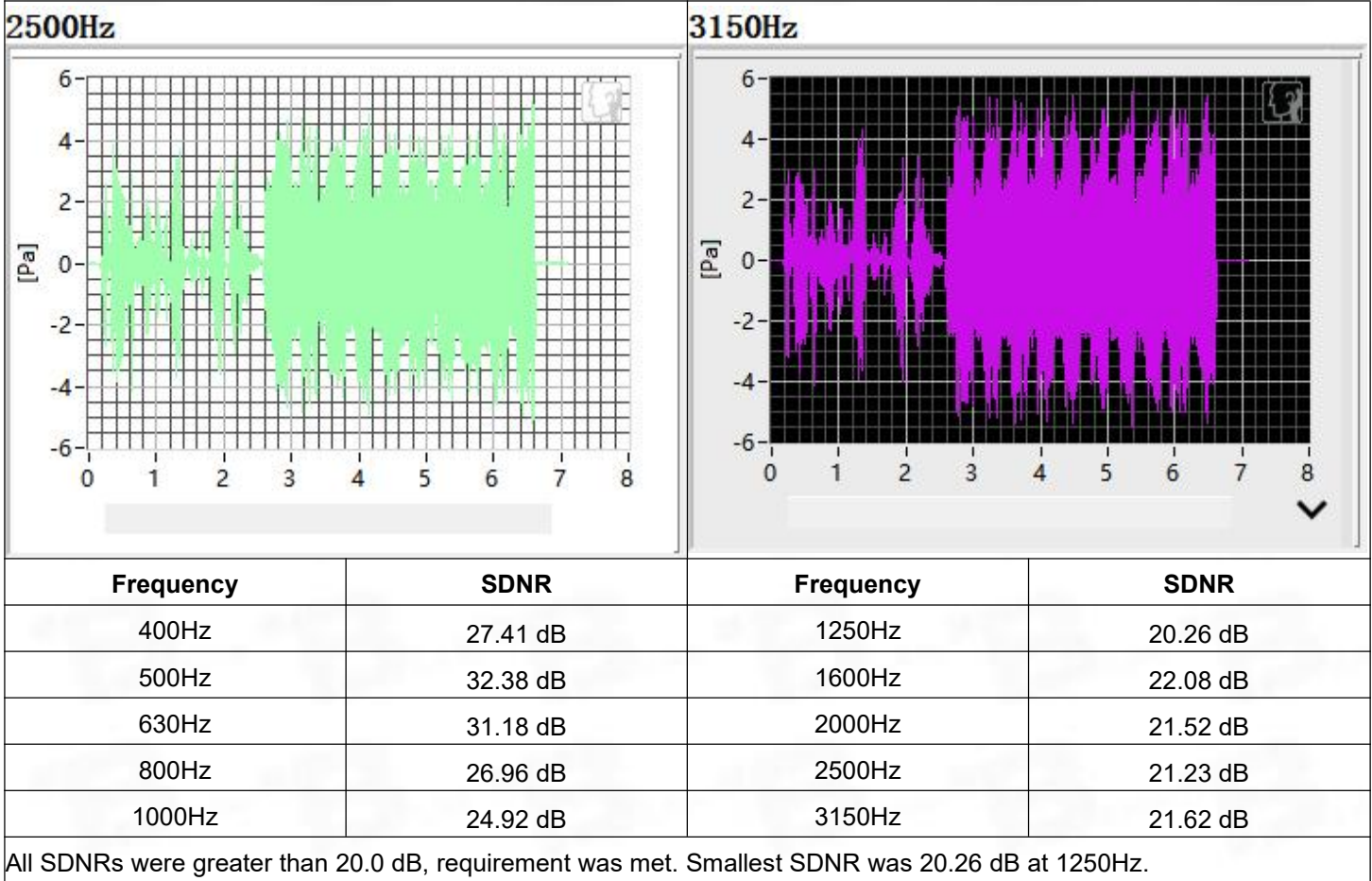

## 2.2 Receive Distortion and Noise 2N NB

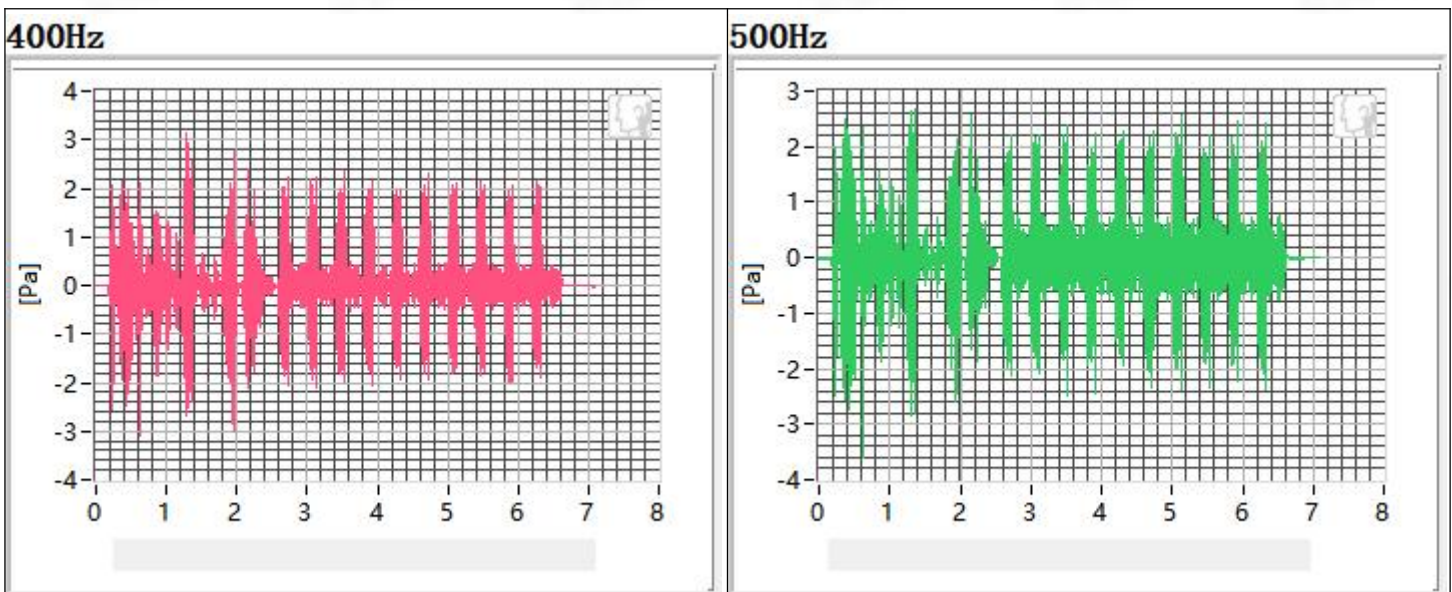

630Hz

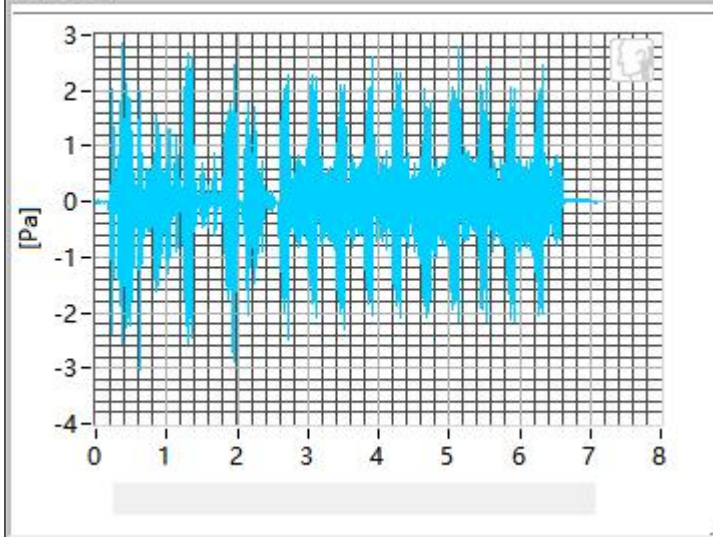

800Hz

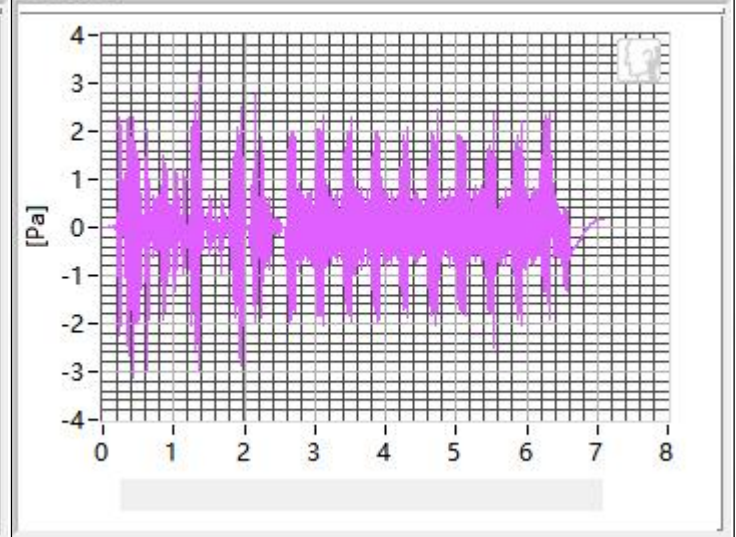

1000Hz

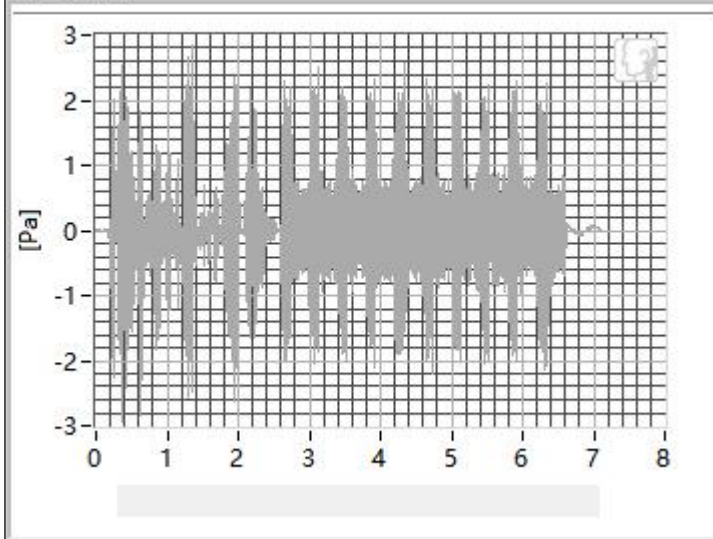

1250Hz

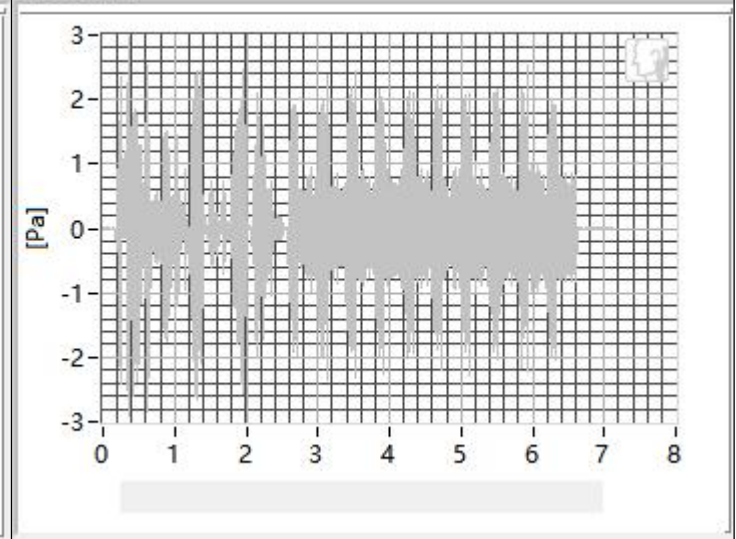

1600Hz

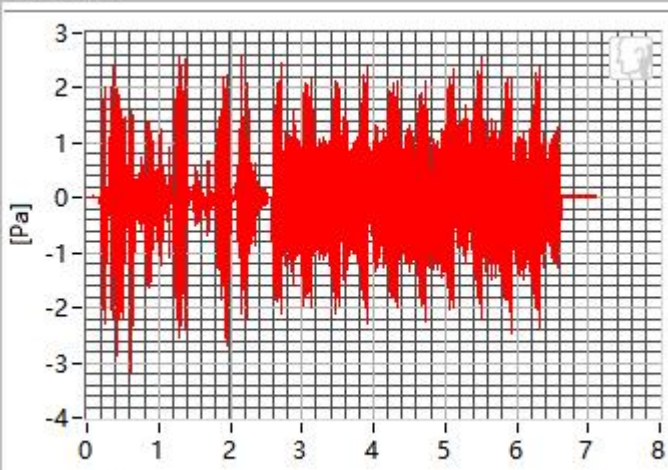

2000Hz

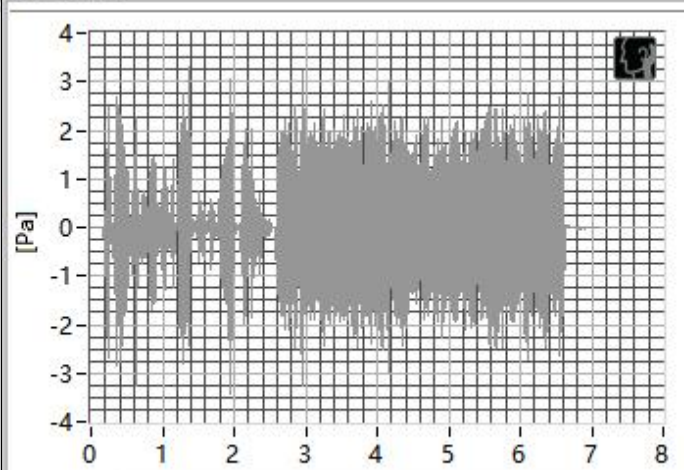

2500Hz

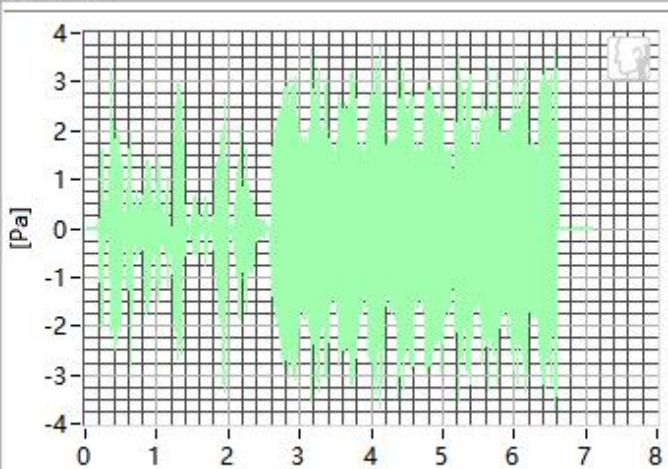

3150Hz

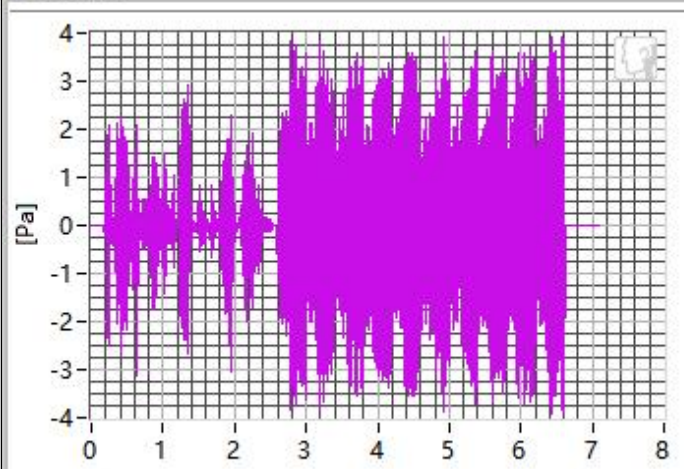

Frequency	SDNR	Frequency	SDNR
400Hz	30.19 dB	1250Hz	20.48 dB
500Hz	34.28 dB	1600Hz	21.26 dB
630Hz	31.76 dB	2000Hz	20.37 dB
800Hz	26.00 dB	2500Hz	20.55 dB
1000Hz	23.52 dB	3150Hz	21.96 dB

All SDNRs were greater than 20.0 dB, requirement was met. Smallest SDNR was 20.37 dB at 2000Hz.

### 2.3 Receive Frequency Response

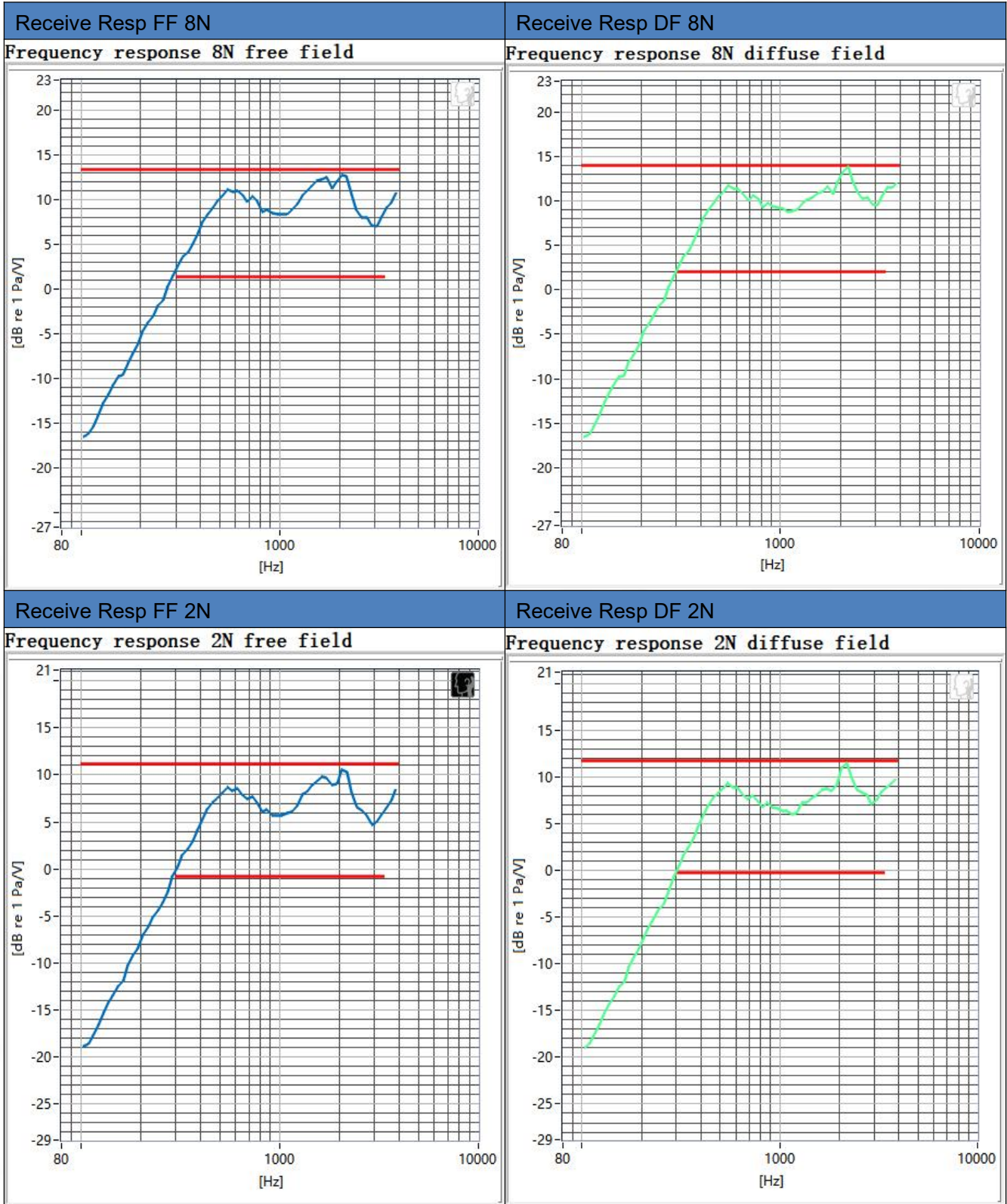

### 3. LTE band 41 in channel 41490

#### 3.1 Receive Distortion and Noise 8N NB

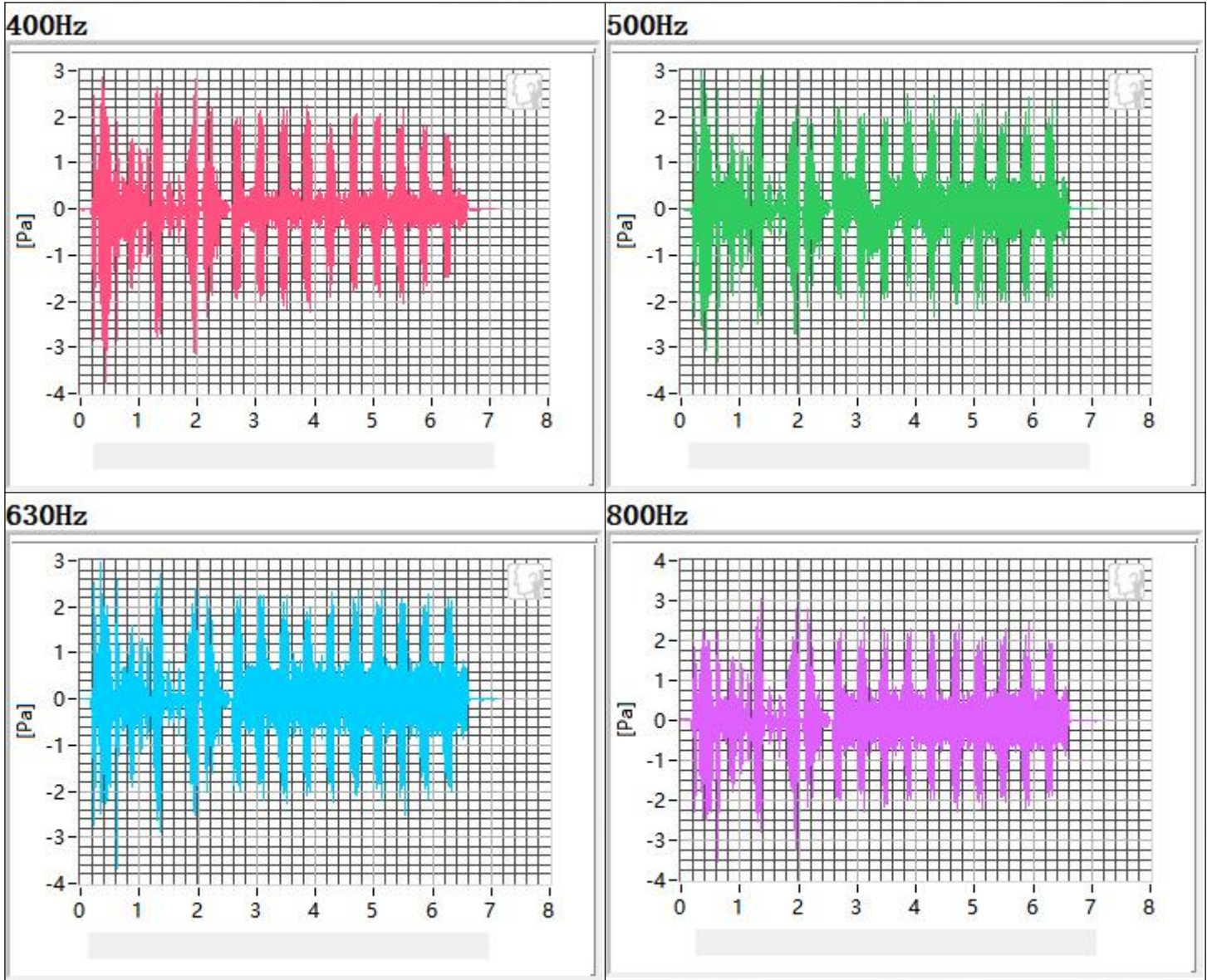



1000Hz

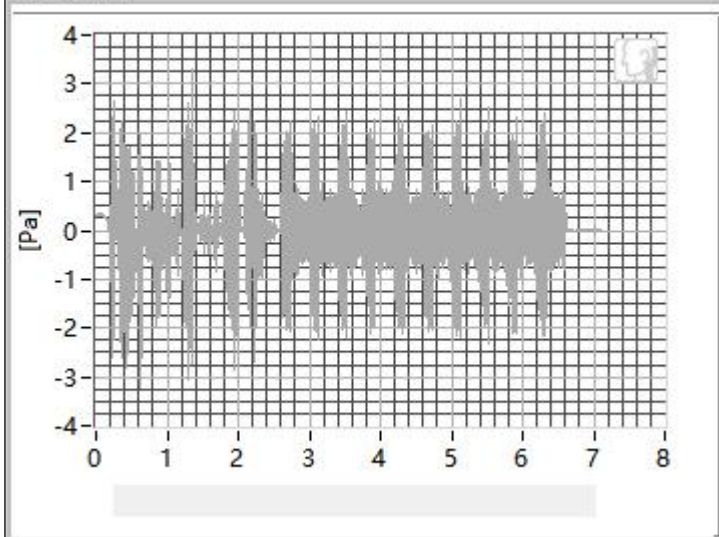

1250Hz

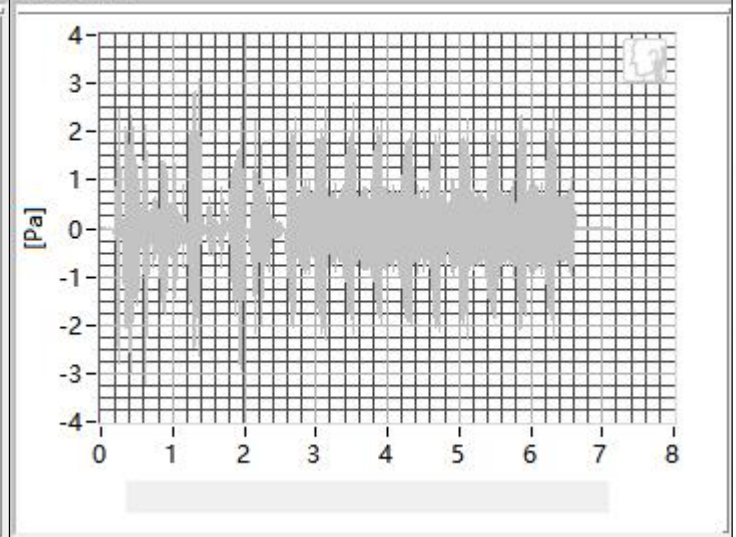

1600Hz

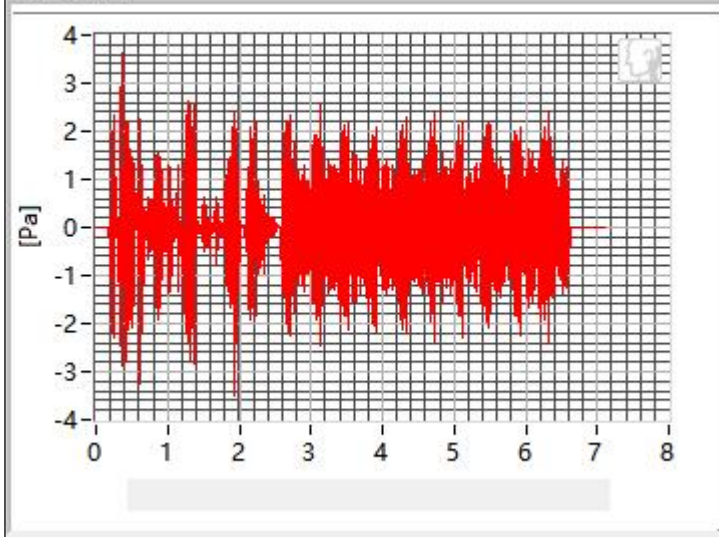

2000Hz

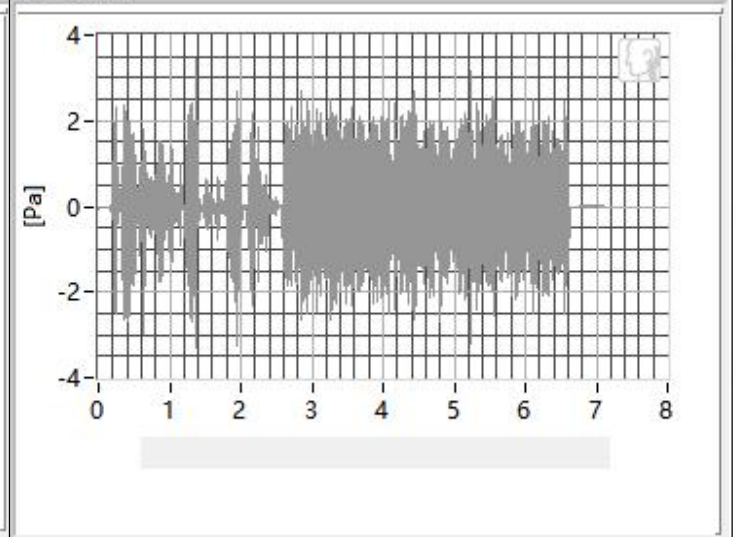

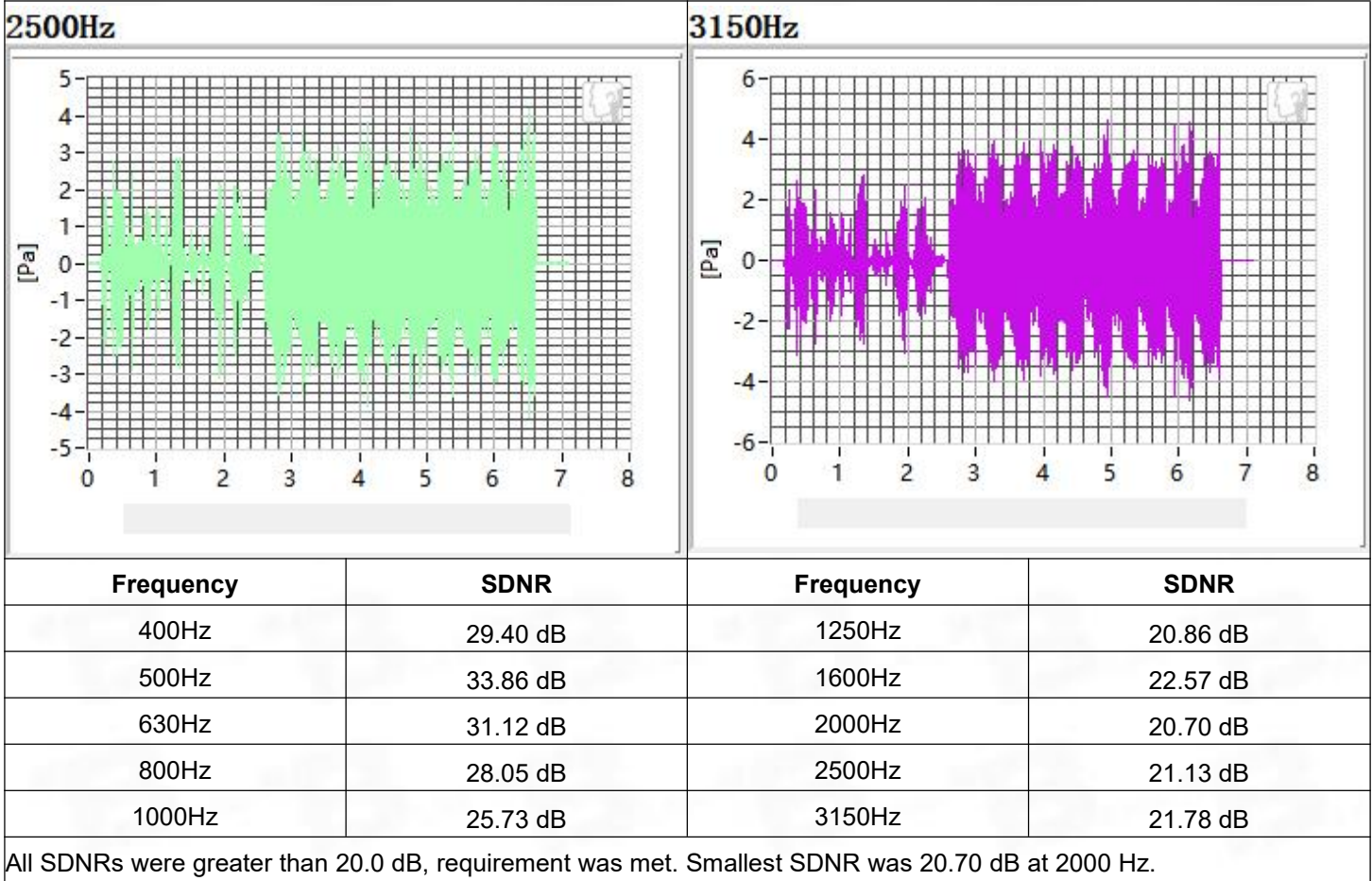

### 3.2 Receive Distortion and Noise 2N NB

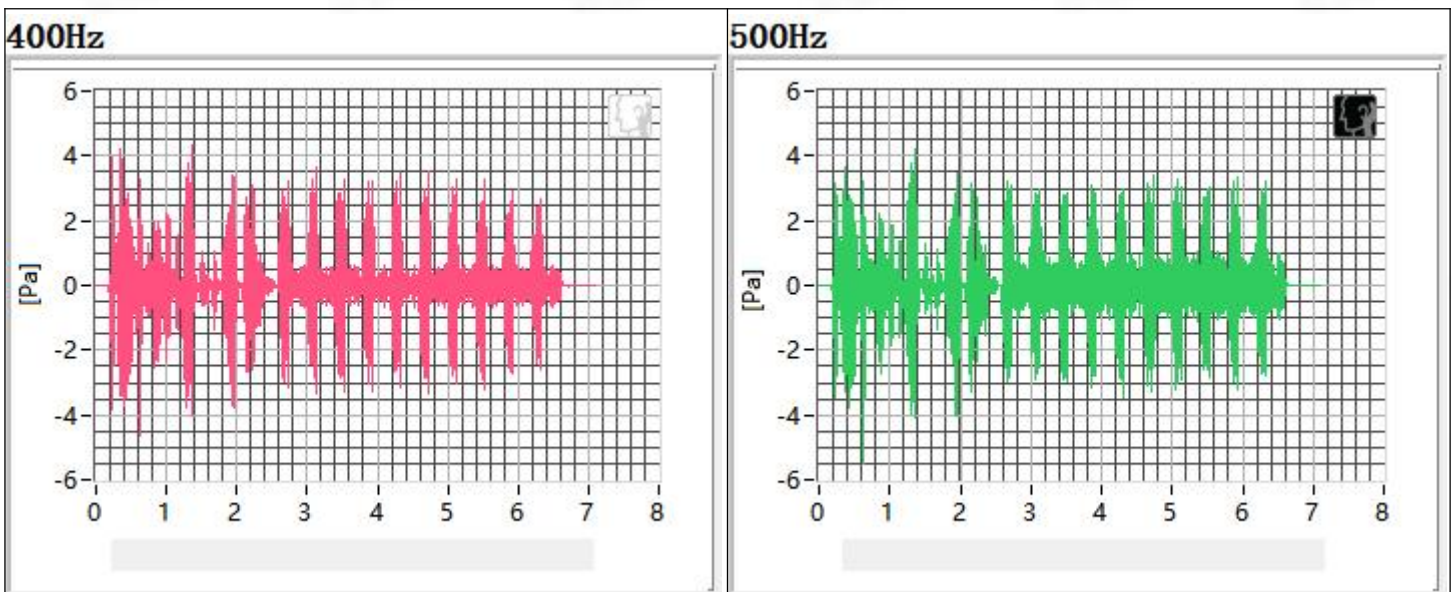

630Hz

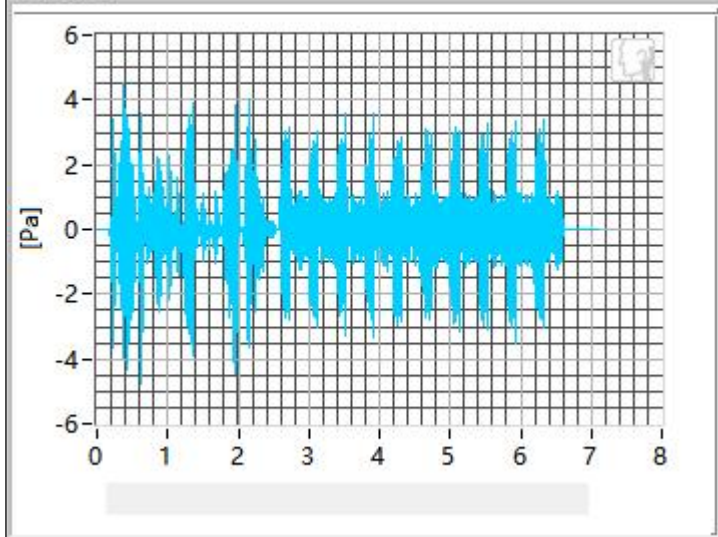

800Hz

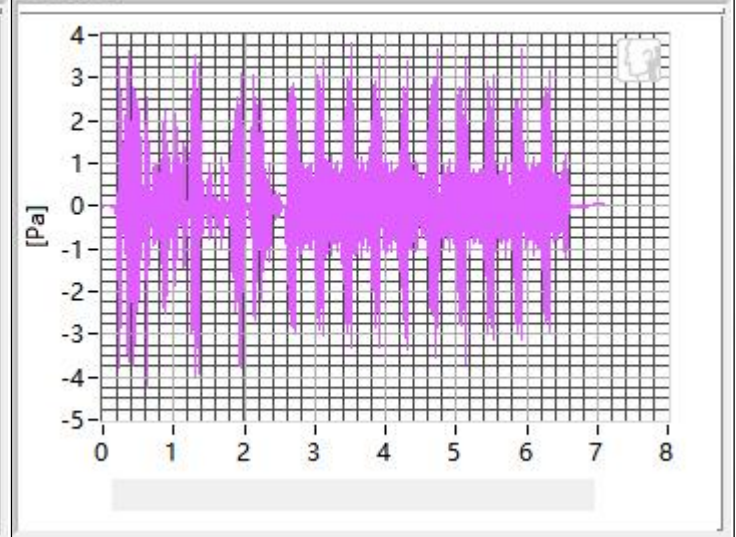

1000Hz

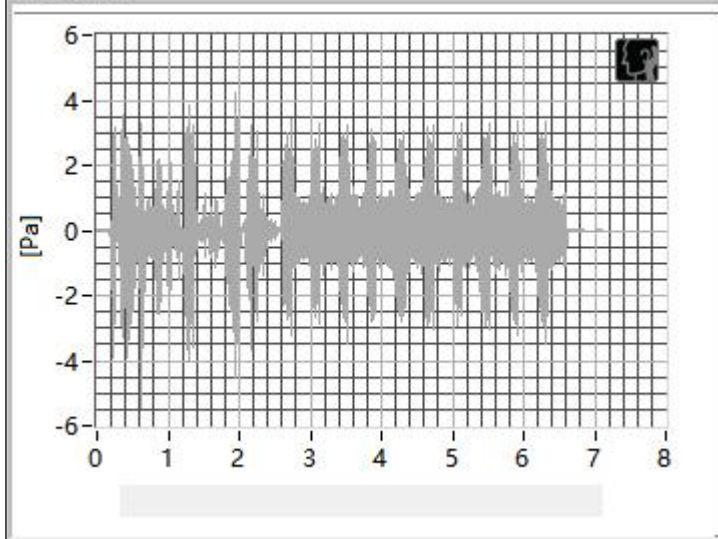

1250Hz

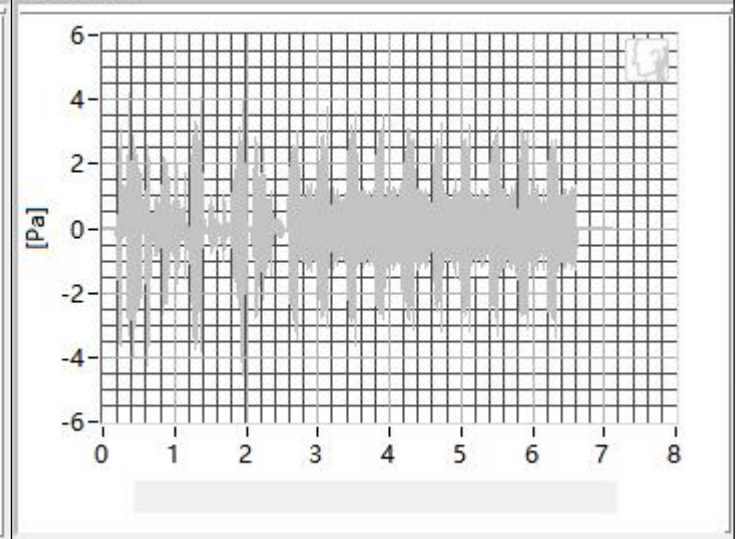

1600Hz

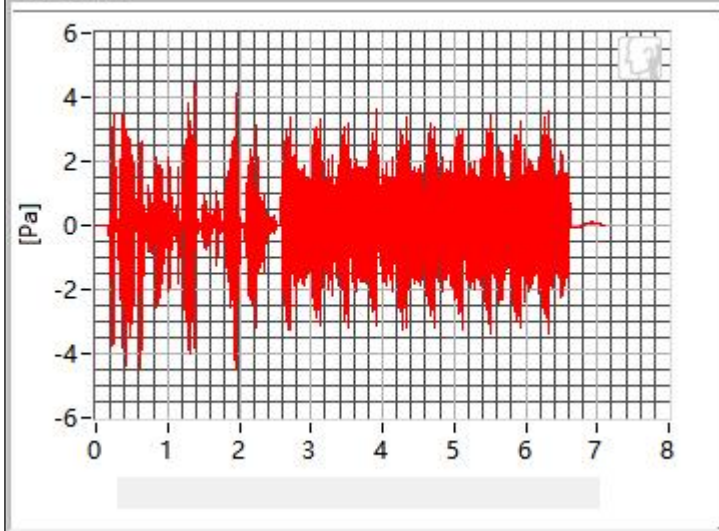

2000Hz

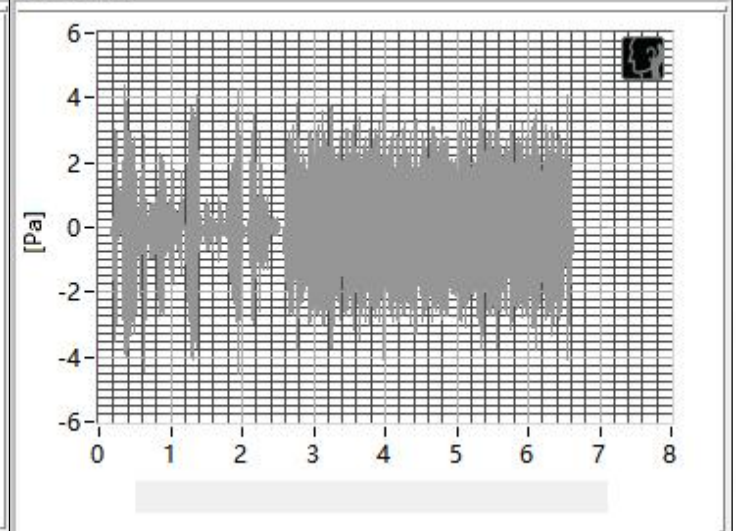

2500Hz

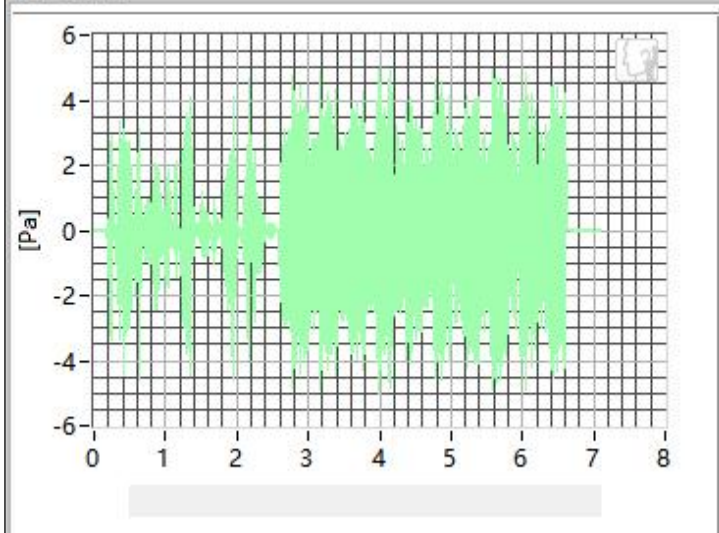

3150Hz

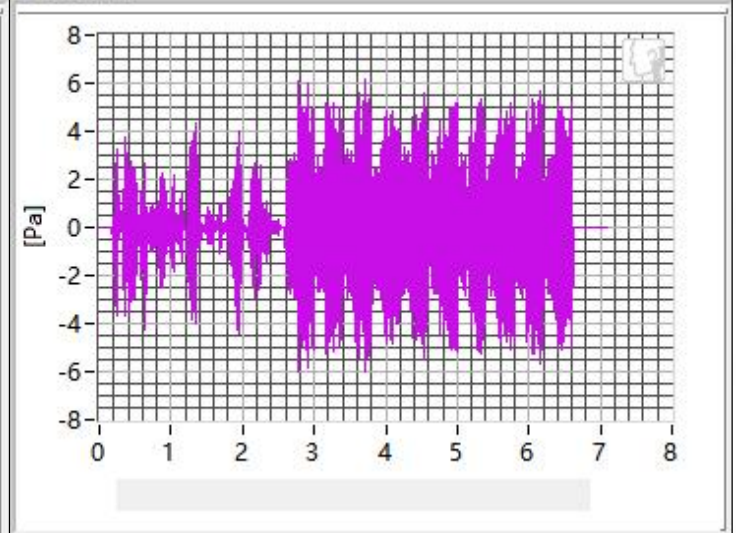

Frequency	SDNR	Frequency	SDNR
400Hz	27.47 dB	1250Hz	20.35 dB
500Hz	31.44 dB	1600Hz	21.17 dB
630Hz	33.04 dB	2000Hz	21.74 dB
800Hz	25.34 dB	2500Hz	21.51 dB
1000Hz	24.87 dB	3150Hz	21.82 dB

All SDNRs were greater than 20.0 dB, requirement was met. Smallest SDNR was 20.35 dB at 1250Hz.

### 3.3 Receive Frequency Response

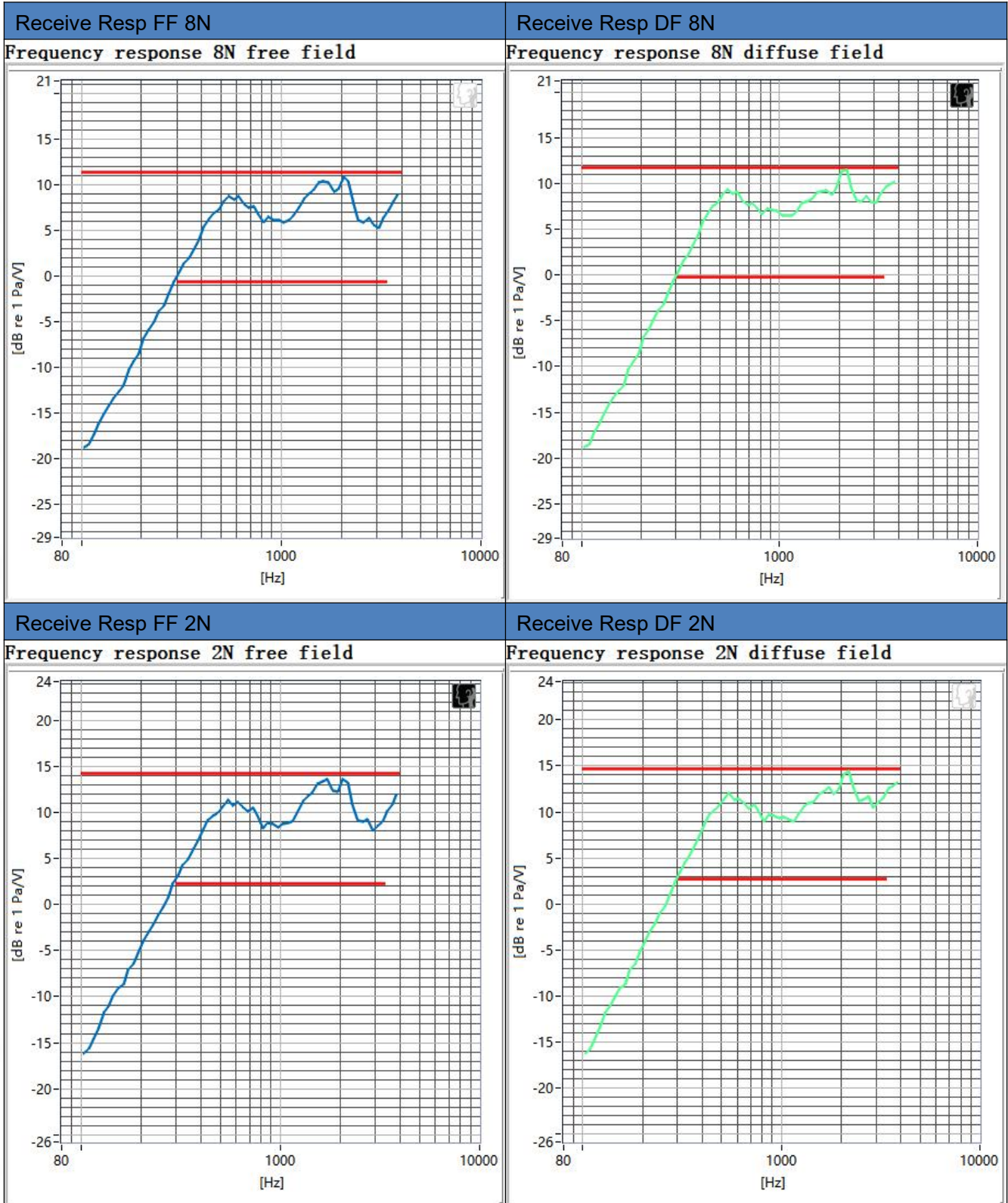

## 4. 5.8G WIFI in channel 151

### 4.1 Receive Distortion and Noise 8N NB

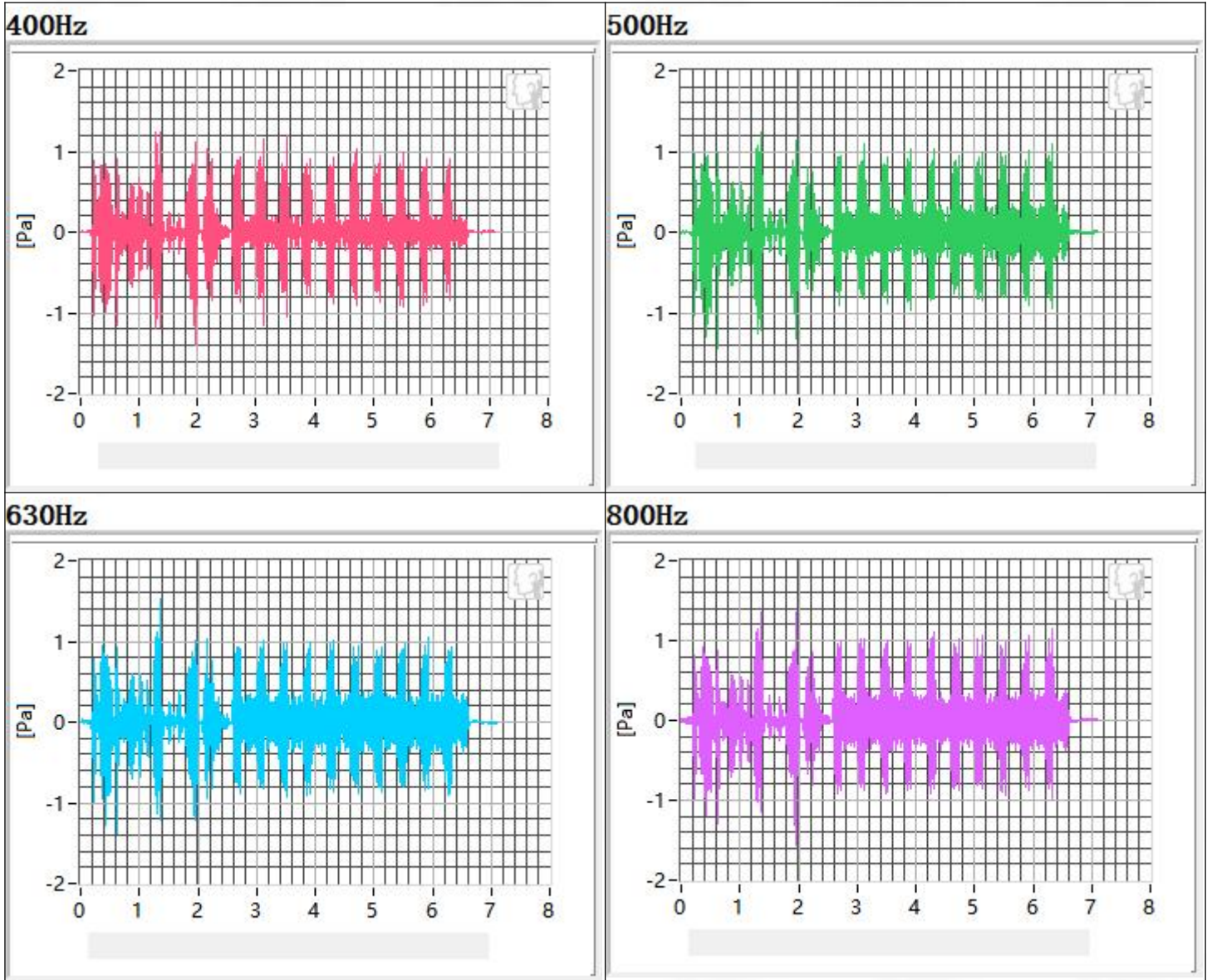

1000Hz

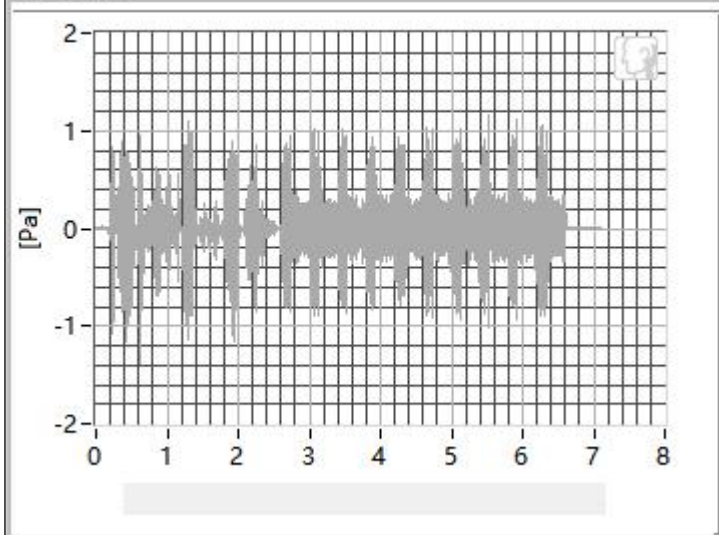

1250Hz

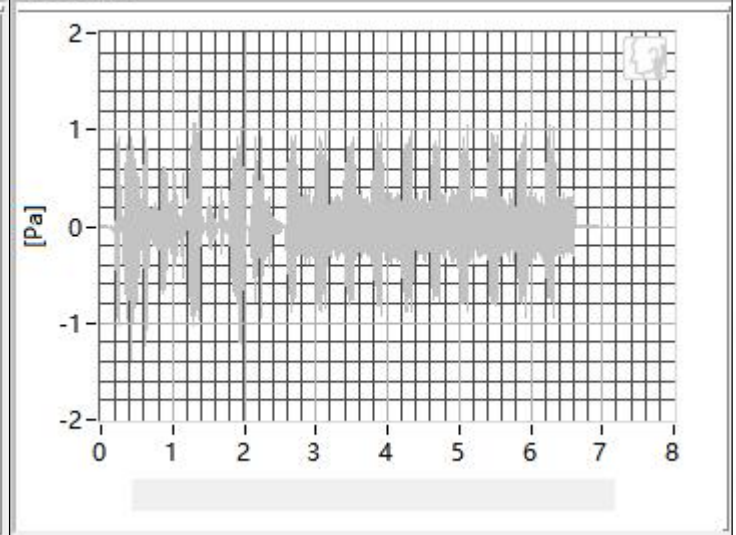

1600Hz

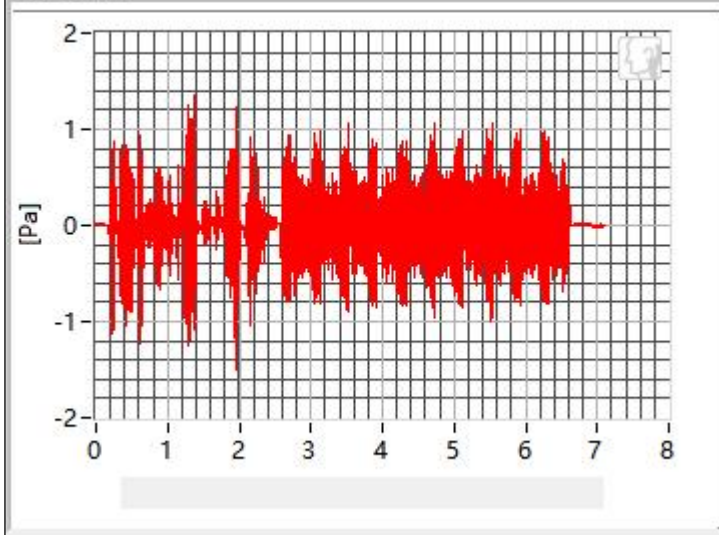

2000Hz

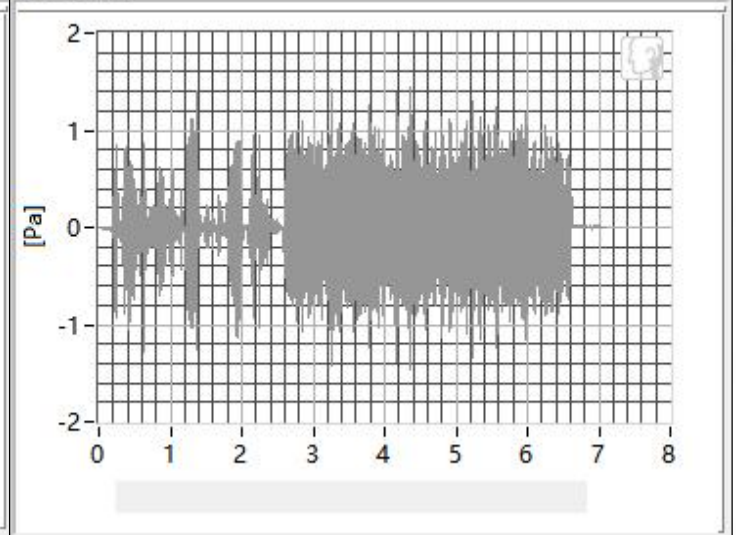

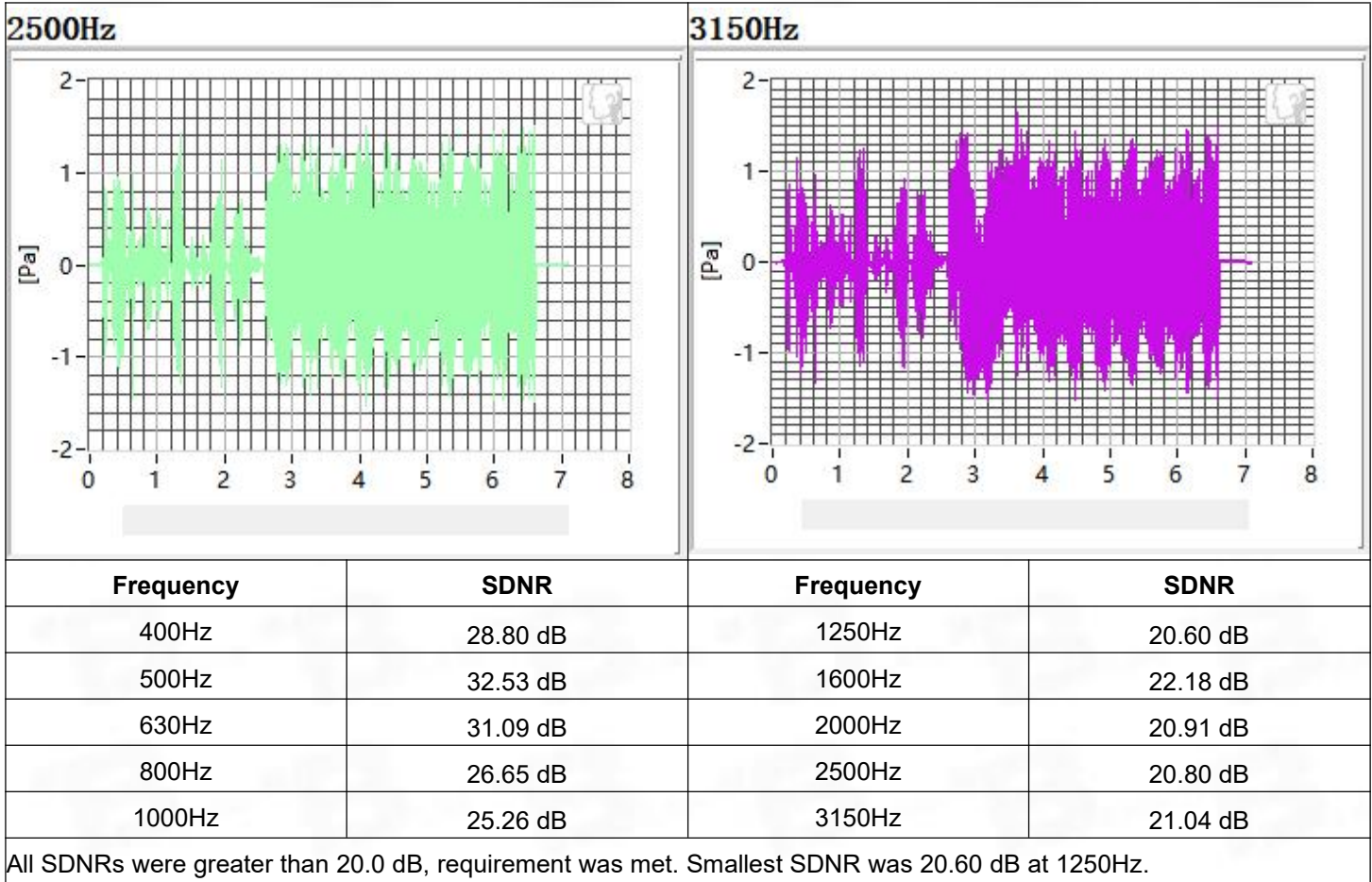

### 3.2 Receive Distortion and Noise 2N NB

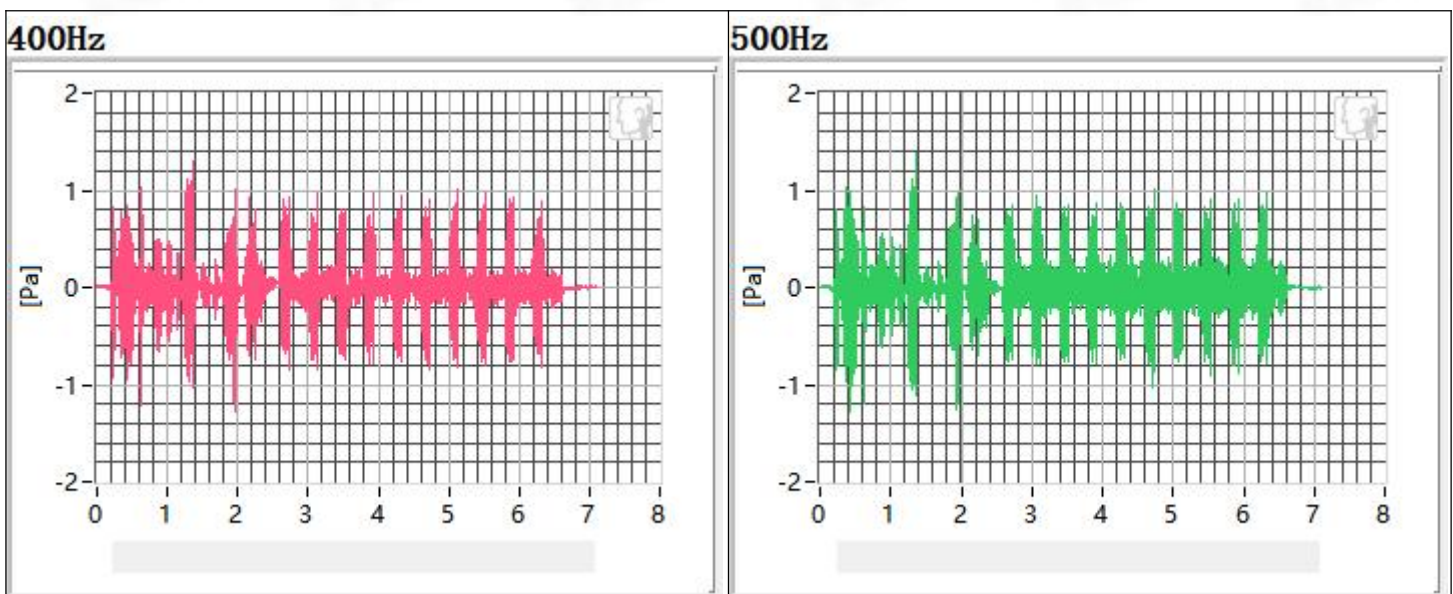



630Hz

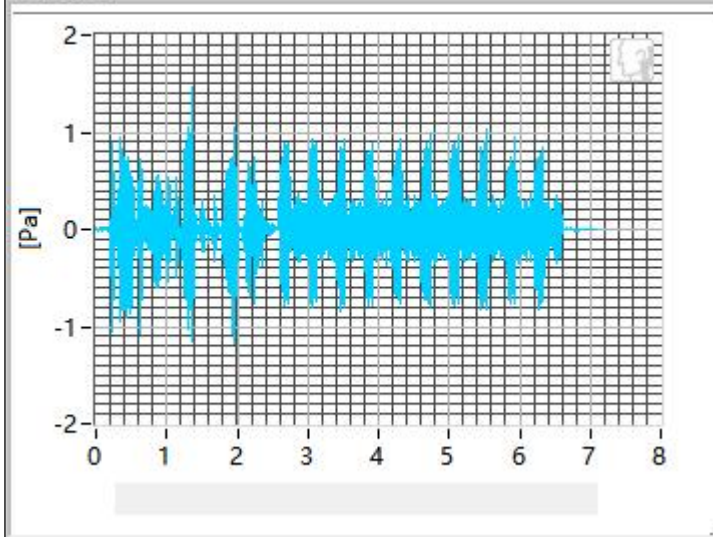

800Hz

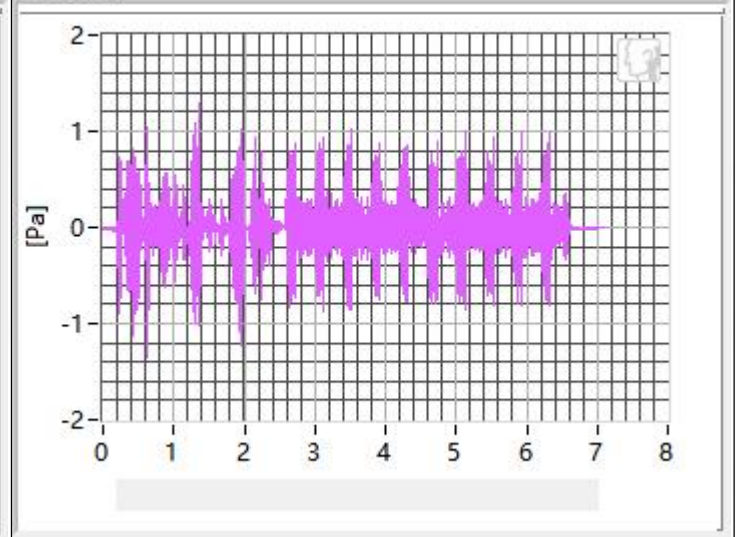

1000Hz

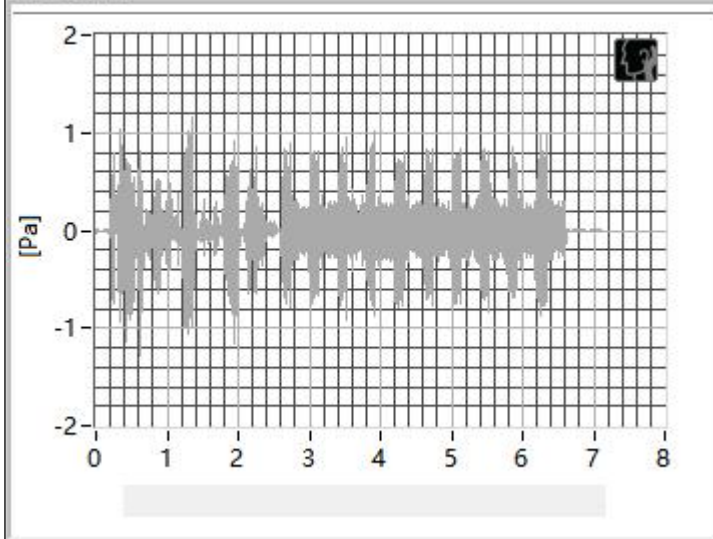

1250Hz

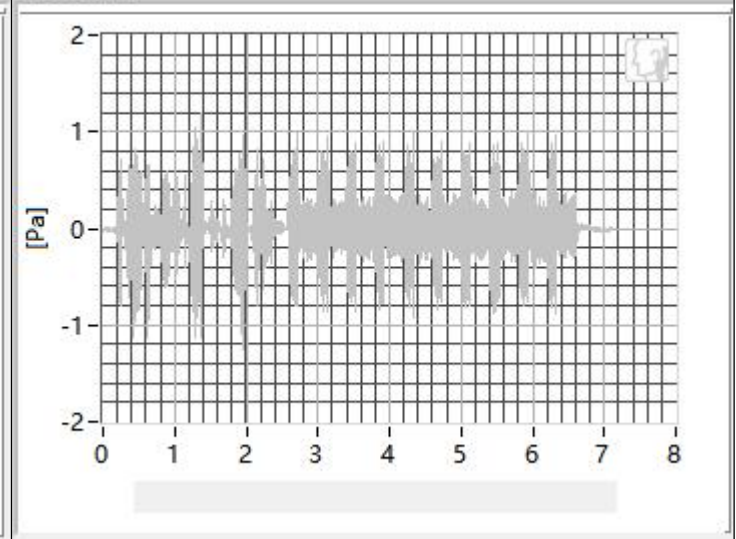

1600Hz

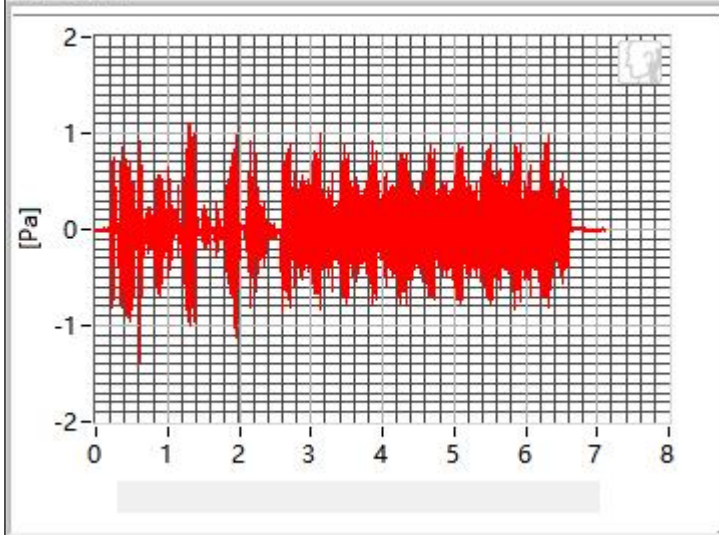

2000Hz

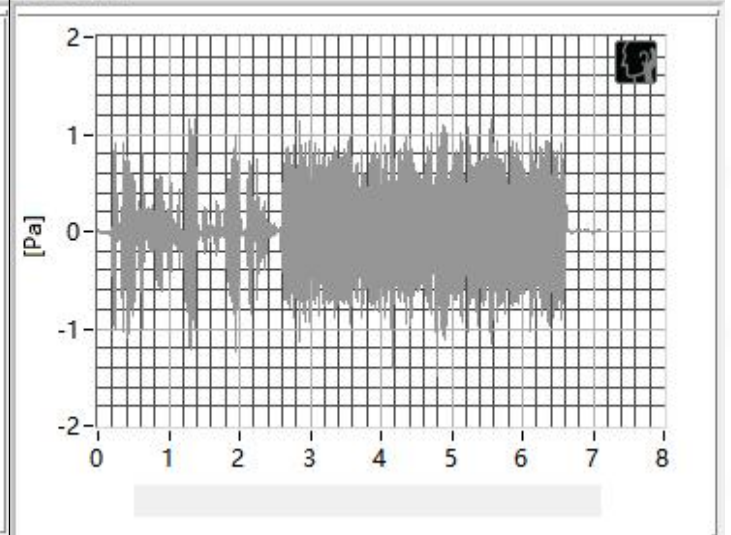

2500Hz

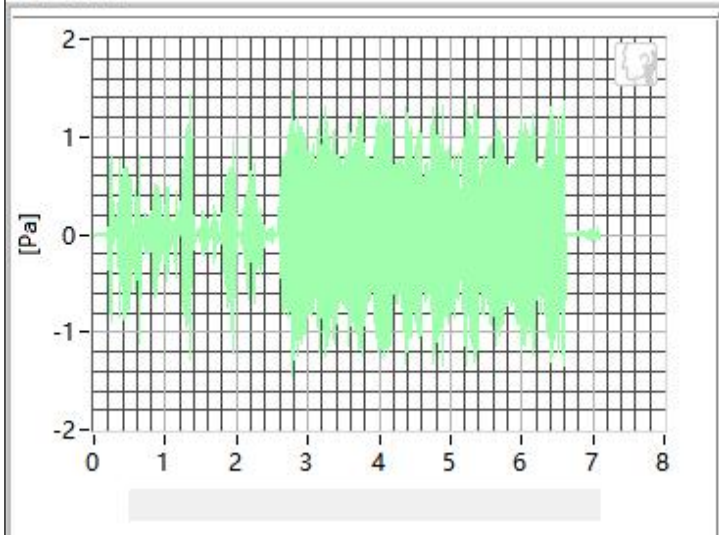

3150Hz

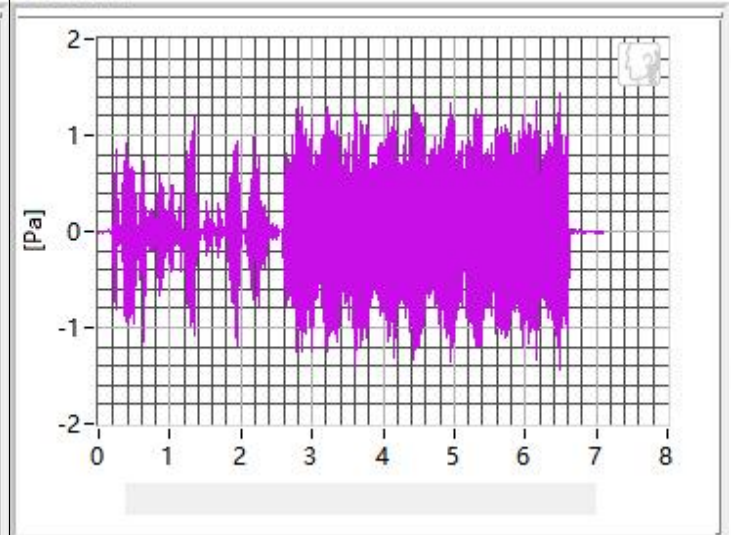

Frequency	SDNR	Frequency	SDNR
400Hz	29.34 dB	1250Hz	20.06 dB
500Hz	33.30 dB	1600Hz	22.28 dB
630Hz	29.67 dB	2000Hz	21.29 dB
800Hz	24.99 dB	2500Hz	20.70 dB
1000Hz	25.51 dB	3150Hz	21.78 dB

All SDNRs were greater than 20.0 dB, requirement was met. Smallest SDNR was 20.06 dB at 1250Hz.

### 3.3 Receive Frequency Response

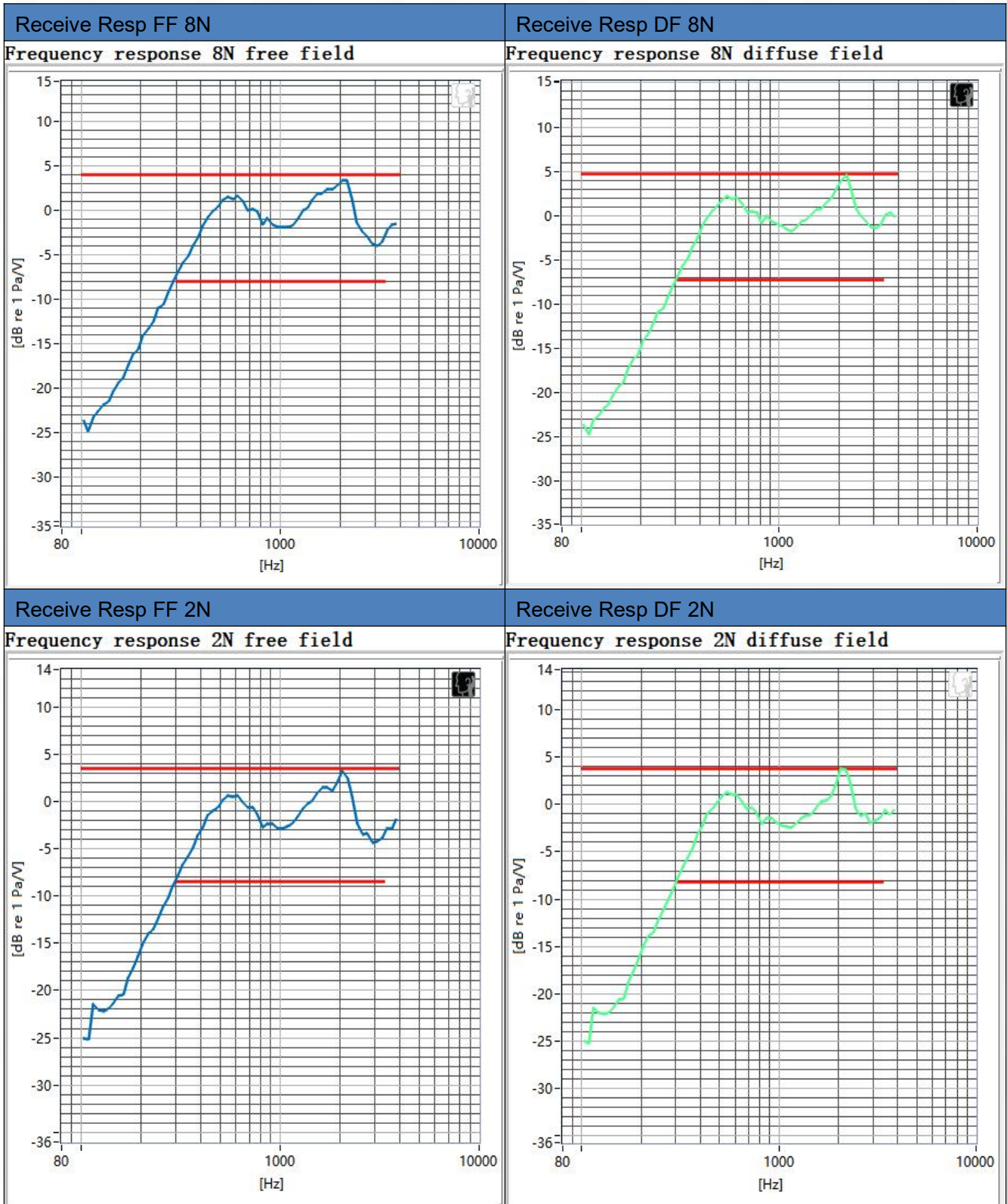

## ANNEX B Test Setup Photo



## ANNEX C CALIBRATION REPORT

Please refer the document "CALIBRATION REPORT.pdf".



BTF Testing Lab (Shenzhen) Co., Ltd.

F101, 201 and 301, Building 1, Block 2, Tantou Industrial Park, Tantou Community, Songgang Street,  
Bao'an District, Shenzhen, China

[www.btf-lab.com](http://www.btf-lab.com)

**--END OF REPORT--**