



**ELECTROMAGNETIC EMISSIONS COMPLIANCE REPORT
FCC PART 15 SUBPART C REQUIREMENT
CANADIAN RSS 210 REQUIREMENT**

OF

Carbon Monoxide alarm

Model No.: C1-R

Trademark: N/A

FCC ID: 2AK7XC1-R

IC: 30642-C1R

Report No.: E01A23040510F00701

Issue Date: May 22, 2023

Prepared for

Shenzhen Heiman Technology Co.,Ltd.

**101, No.4 Dafu Industrial Park, Kukeng Community, Guanlan Street,
Longhua District, Shenzhen, Guangdong, China**

Prepared by

Dong Guan Anci Electronic Technology Co., Ltd.

**1-2 Floor, Building A, No.11, Headquarters 2 Road, Songshan, Lake Hi-tech
Industrial Development Zone, Dongguan City, Guangdong Pr., China.**

**This report shall not be reproduced, except in full, without the written approval of
Dong Guan Anci Electronic Technology Co., Ltd.**

VERIFICATION OF COMPLIANCE

Applicant:	Shenzhen Heiman Technology Co.,Ltd. 101, No.4 Dafu Industrial Park, Kukeng Community, Guanlan Street, Longhua District, Shenzhen, Guangdong, China
Manufacturer:	Shenzhen Heiman Technology Co.,Ltd. 101, No.4 Dafu Industrial Park, Kukeng Community, Guanlan Street, Longhua District, Shenzhen, Guangdong, China
Product Description:	Carbon Monoxide alarm
Trade Mark:	N/A
Model Number:	C1-R
Sample number:	A23040510 007

We hereby certify that:

The above equipment was tested by Dong Guan Anci Electronic Technology Co., Ltd. The test data, data evaluation, test procedures, and equipment configurations shown in this report were made in accordance with the procedures given in ANSI C63.10-2013 & RSS-Gen Issue 5(April, 2018) and the energy emitted by the sample EUT tested as described in this report is in compliance with conducted and radiated emission limits of FCC Rules Part 15.249(2022) and Canadian RSS 210 Issue 10, December 2019.

Date of Test : May 04, 2023 to May 10, 2023

Prepared by : 
Duke Liu/Editor

Reviewer & Approved : 
Tiger Xu/ Supervisor



Modified Information

Version	Summary	Revision Date	Report No.
Ver.1.0	Original Report	/	E01A23040510F00701

Table of Contents

1	EUT TECHNICAL DESCRIPTION	4
2	SUMMARY OF TEST RESULT.....	5
3	TEST METHODOLOGY.....	6
3.1	GENERAL DESCRIPTION OF APPLIED STANDARDS.....	6
3.2	MEASUREMENT EQUIPMENT USED	6
3.3	DESCRIPTION OF TEST MODES	6
4	FACILITIES AND ACCREDITATIONS	7
4.1	FACILITIES.....	7
4.2	LABORATORY ACCREDITATIONS AND LISTINGS	7
5	TEST SYSTEM UNCERTAINTY	8
6	SETUP OF EQUIPMENT UNDER TEST	9
6.1	RADIO FREQUENCY TEST SETUP 1	9
6.2	RADIO FREQUENCY TEST SETUP 2	9
6.3	CONDUCTED EMISSION TEST SETUP	11
6.4	BLOCK DIAGRAM CONFIGURATION OF TEST SYSTEM.....	12
6.5	SUPPORT EQUIPMENT	12
7	TEST REQUIREMENTS	13
7.1	OCCUPIED BANDWIDTH & 99% BANDWIDTH	13
7.2	RADIATED SPURIOUS EMISSION.....	15
7.3	TRANSMISSION REQUIREMENT	23
7.4	BAND EDGE TEST.....	25
7.5	ANTENNA APPLICATION.....	28

1 EUT TECHNICAL DESCRIPTION

Characteristics	Description
Device Type:	Carbon Monoxide alarm
Modulation:	FSK
Operating Frequency Range(s):	915MHz
Number of Channels:	1 channel
Antenna Type :	Internal Antenna
Antenna Gain:	1.5dBi
Power supply:	Battery 3V CR123A
Date of Sample Received:	May 04, 2023

Note: for more details, please refer to the User's manual of the EUT.

The EUT has been associated with peripherals pursuant to ANSI C63.10-2013 and configuration operated in a manner tended to maximize its emission characteristics in a typical application. Frequency range investigated: radiation (9 KHz to the 10th harmonic of the highest fundamental frequency or to 40 GHz, whichever is lower).

For Radiated: The EUT's antenna was pre-tested under the following modes:

Test Mode	Description
Mode A	X-Y axis
Mode B	Y-Z axis
Mode C	X-Z axis

From the above modes, the worst case was found in Mode A.

All the x/y/z orientation has been investigated, and only worst case is presented in this report.

2 SUMMARY OF TEST RESULT

FCC Part Clause	Test Parameter	Verdict	Remark
15.249 RSS 210 Issue 10 Annex A.1.3	Occupied Bandwidth	PASS	
RSS-GEN issue 5 6.7	99% emission bandwidth	PASS	
15.249(a), §15.249(c) RSS 210 Issue 10 Annex A.1.2	Radiated Spurious Emissions	PASS	
RSS 210 Issue 10 Annex A.1.1	Transmission Requirement	PASS	
15.249/15.205	Band Edge	PASS	
15.203 RSS-Gen Issue 5 6.8	Antenna Requirement	PASS	
15.207(a) RSS-Gen Issue 5 8.8	Conducted Emission	N/A	See NOTE
<p>NOTE:</p> <p>1: N/A (Not Applicable) ,EUT powered by battery.</p> <p>2: All buttons of EUT were investigated. The test results shown in the following sections represent the worst case emissions</p>			

RELATED SUBMITTAL(S) / GRANT(S):

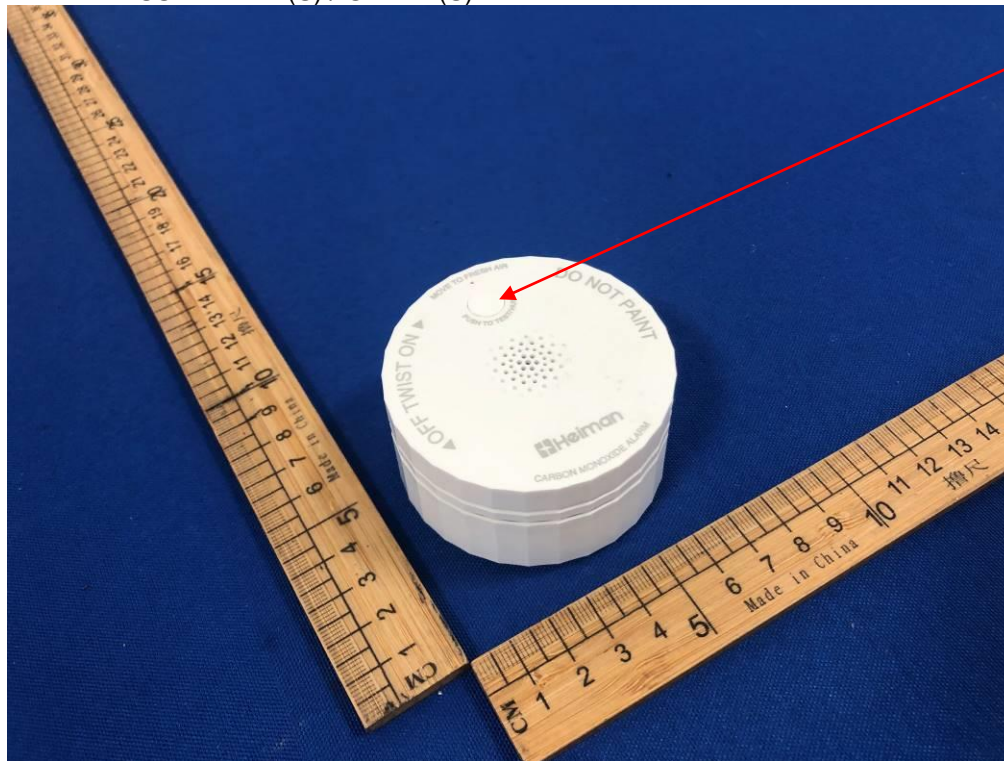

Tested button

This submittal(s) (test report) is intended for FCC ID: 2AK7XC1-R filing to comply with Section 15.249 of the FCC Part 15, Subpart C Rules.

3 TEST METHODOLOGY

3.1 GENERAL DESCRIPTION OF APPLIED STANDARDS

According to its specifications, the EUT must comply with the requirements of the following standards:

FCC 47 CFR Part 2, Subpart J

FCC 47 CFR Part 15, Subpart C

RSS-Gen Issue 5, April 2018.

RSS 210 Issue 10, December 2019.

3.2 MEASUREMENT EQUIPMENT USED

Item	Equipment	Manufacturer	Model No.	Serial No.	Calibrated until
1.	EMI Test Receiver	Rohde & Schwarz	ESPI7	100502	2023-10-07
2.	Pre-Amplifier	Anritsu	MH648A	M57886	2023-05-12
3.	Bilog Antenna	Schwarzbeck	VULB9163	VULB9163-1 290	2023-12-11
4.	RF Cable	N/A	ZT06S-NJ-NJ-11M	19060398	2023-05-12
5.	RF Cable	N/A	ZT06S-NJ-NJ-0.5M	19060400	2023-05-12
6.	RF Cable	N/A	ZT06S-NJ-NJ-2.5M	19060404	2023-05-12
7.	Spectrum Analyzer	Rohde & Schwarz	FSV40	101413	2023-10-07
8.	Low noise Amplifiers	A-INFO	LA1018N4009	J1013130524 001	2023-05-12
9.	Horn antenna	A-INFO	LB-10180-SF	J2031090612 123	2024-05-14
10.	RF Cable	N/A	ZT26-NJ-NJ-11M	19060401	2023-05-12
11.	RF Cable	N/A	ZT26-NJ-NJ-2.5M	19060402	2023-05-12
12.	RF Cable	N/A	ZT26-NJ-NJ-0.5M	19060403	2023-05-12
13.	3m Semi-anechoic Chamber	chengyu	9m*6m*6m	N/A	2024-11-12
14.	Test Software	Farad	EZ-EMC (Ver.FA-03A2 RE)	N/A	N/A

Remark: Each piece of equipment is scheduled for calibration once a year.

3.3 DESCRIPTION OF TEST MODES

The EUT has been tested under its typical operating condition.

The EUT configuration for testing is installed on RF field strength measurement to meet the Commissions requirement and operating in a manner which intends to maximize its emission characteristics in a continuous normal application.

The Transmitter was operated in the normal operating mode. The TX frequency was fixed which was for the purpose of the measurements.

Pre-defined engineering program for regulatory testing used to control the EUT for staying in continuous transmitting and receiving mode is programmed.

4 FACILITIES AND ACCREDITATIONS

4.1 FACILITIES

All measurement facilities used to collect the measurement data are located at 1-2 Floor, Building A, No.11, Headquarters 2 Road, Songshan, Lake Hi-tech Industrial Development Zone, Dongguan City, Guangdong Pr., China. The sites are constructed in conformance with the requirements of ANSI C63.7, ANSI C63.10 and CISPR Publication 22.

4.2 LABORATORY ACCREDITATIONS AND LISTINGS

Site Description

- EMC Lab. : Accredited by CNAS, 2017.06.26 The certificate is valid until 2022.10.28 The Laboratory has been assessed and proved to be in compliance with CNAS-CL01:2006 (identical to ISO/IEC 17025:2005) The Certificate Registration Number is L6214. Accredited by A2LA, 2018.03.15 The Certificate Number is 4422.01.
- Name of Firm : Dong Guan Anci Electronic Technology Co., Ltd.
- Site Location : 1-2 Floor, Building A, No.11, Headquarters 2 Road, Songshan, Lake Hi-tech Industrial Development Zone, Dongguan City, Guangdong Pr., China.

5 TEST SYSTEM UNCERTAINTY

The following measurement uncertainty levels have been estimated for tests performed on the apparatus:

Parameter	Uncertainty
Radio Frequency	$\pm 1 \times 10^{-5}$
Conducted Emissions Test	$\pm 2.0\text{dB}$
Radiated Emission Test	$\pm 2.0\text{dB}$
Occupied Bandwidth Test	$\pm 1.0\text{dB}$
Temperature	$\pm 0.5^\circ\text{C}$
Humidity	$\pm 3\%$

Measurement Uncertainty for a level of Confidence of 95%

6 SETUP OF EQUIPMENT UNDER TEST

6.1 RADIO FREQUENCY TEST SETUP 1

The component's antenna ports(s) of the EUT are connected to the measurement instrument per an appropriate attenuator. The EUT is controlled by PC/software to emit the specified signals for the purpose of measurements.

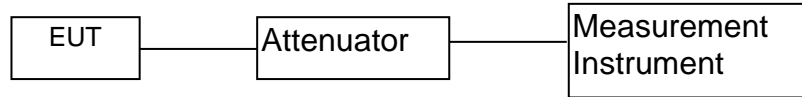

6.2 RADIO FREQUENCY TEST SETUP 2

The test site semi-anechoic chamber has met the requirement of NSA tolerance 4 dB according to the standards: ANSI C63.10. The test distance is 3m. The setup is according to the requirements in Section 13.1.4.1 of ANSI C63.10-2013 and CAN/CSA-CEI/IEC CISPR 22.

The maximal emission value is acquired by adjusting the antenna height, polarisation and turntable azimuth. Normally, the height range of antenna is 1 m to 4 m, the azimuth range of turntable is 0° to 360°, and the receive antenna has two polarizations Vertical (V) and Horizontal (H).

Below 30MHz:

The EUT is placed on a turntable 0.8 meters above the ground in the chamber, 3 meter away from the antenna (loop antenna). The Antenna should be positioned with its plane vertical at the specified distance from the EUT and rotated about its vertical axis for maximum response at each azimuth about the EUT. The center of the loop shall be 1 m above the ground. For certain applications, the loop antenna plane may also need to be positioned horizontally at the specified distance from the EUT.

Above 30MHz:

The EUT is placed on a turntable 0.8 meters above the ground in the chamber, 3 meter away from the antenna. The maximal emission value is acquired by adjusting the antenna height, polarisation and turntable azimuth. Normally, the height range of antenna is 1 m to 4 m, the azimuth range of turntable is 0° to 360°, and the receive antenna has two polarizations Vertical (V) and Horizontal (H).

(a) Radiated Emission Test Set-Up, Frequency Below 30MHz

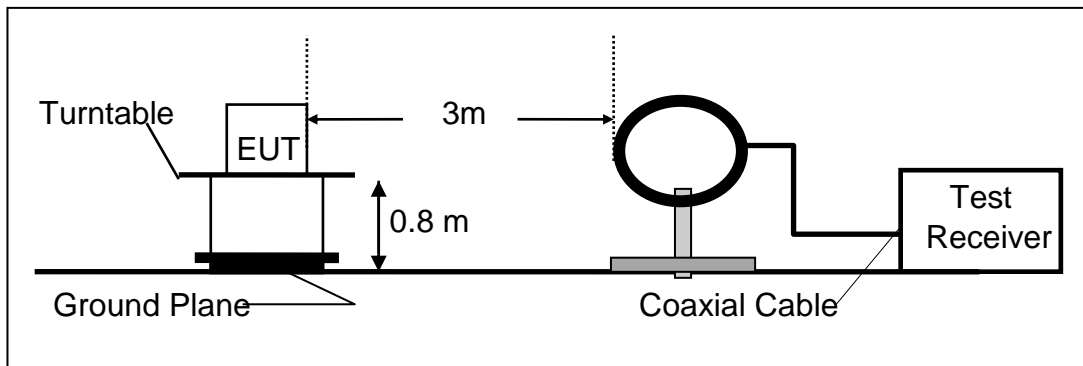

(b) Radiated Emission Test Set-Up, Frequency Below 1000MHz

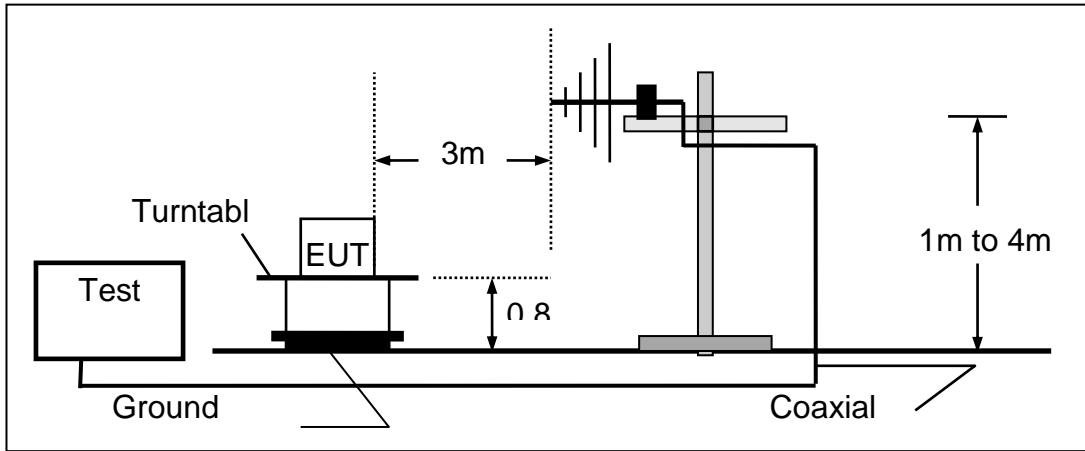

(C) Radiated Emission Test Set-Up, Frequency above 1000MHz

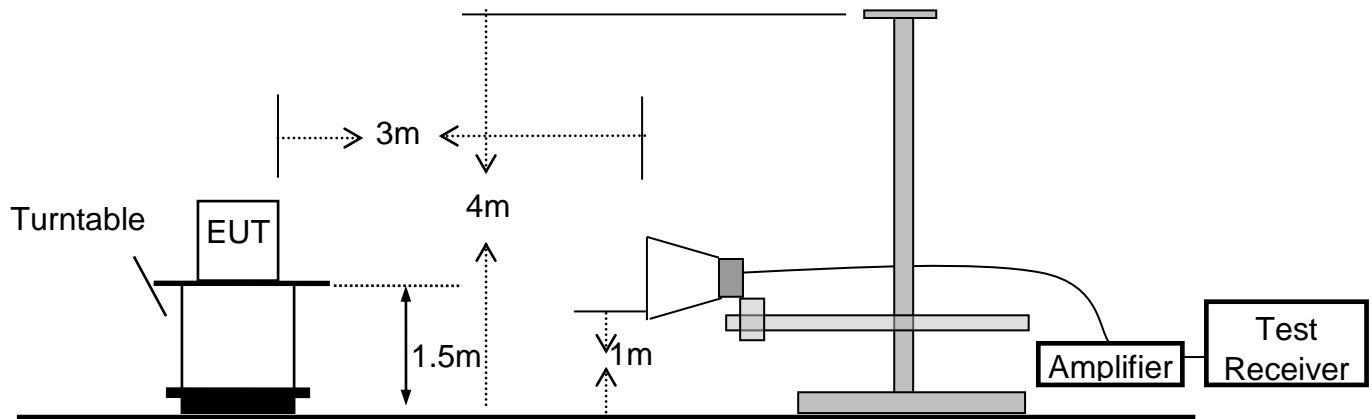

6.3 CONDUCTED EMISSION TEST SETUP

The mains cable of the EUT (maybe per AC/DC Adapter) must be connected to LISN. The LISN shall be placed 0.8 m from the boundary of EUT and bonded to a ground reference plane for LISN mounted on top of the ground reference plane. This distance is between the closest points of the LISN and the EUT. All other units of the EUT and associated equipment shall be at least 0.8m from the LISN.

Ground connections, where required for safety purposes, shall be connected to the reference ground point of the LISN and, where not otherwise provided or specified by the manufacturer, shall be of same length as the mains cable and run parallel to the mains connection at a separation distance of not more than 0.1 m.

According to the requirements in ANSI C63.10-2013 Conducted emissions from the EUT measured in the frequency range between 0.15 MHz and 30 MHz using CISPR Quasi-Peak and average detector mode.

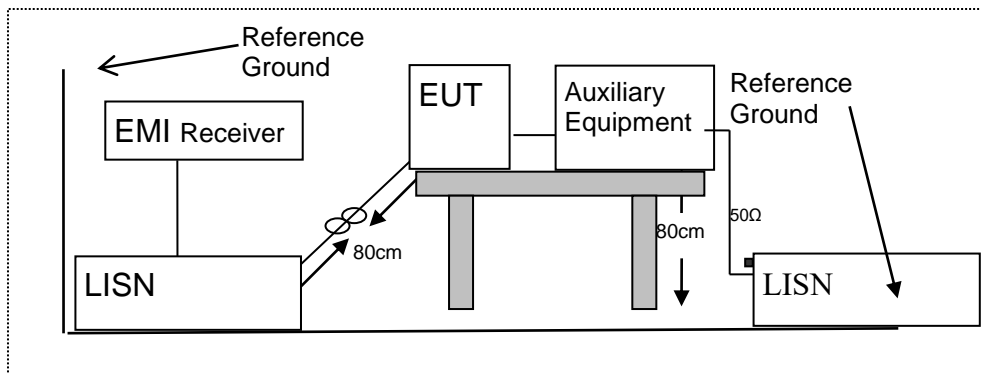

6.4 BLOCK DIAGRAM CONFIGURATION OF TEST SYSTEM

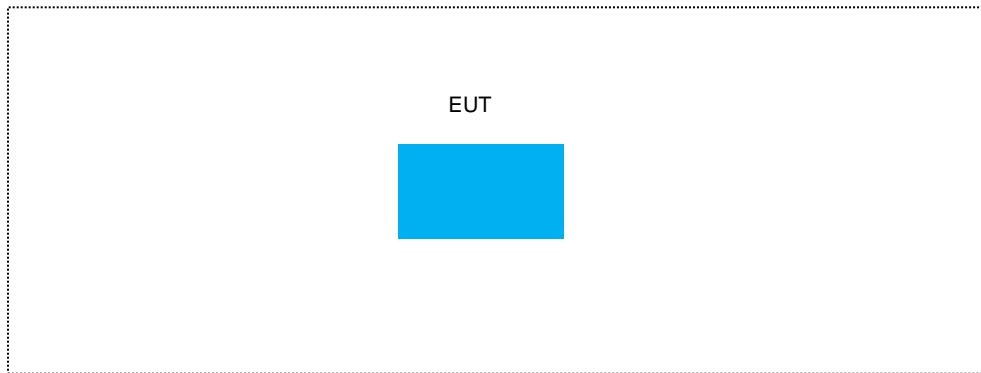

6.5 SUPPORT EQUIPMENT

Item	Equipment	Mfr/Brand	Model/Type No.	Series No.	Note
1.	N/A	N/A	N/A	N/A	

Notes:

1. All the equipment/cables were placed in the worst-case configuration to maximize the emission during the test.
2. Grounding was established in accordance with the manufacturer's requirements and conditions for the intended use.

7 TEST REQUIREMENTS

7.1 OCCUPIED BANDWIDTH & 99% Bandwidth

7.1.1 Applicable Standard

According to RSS 210 Issue 10 Annex A.1.3

7.1.2 Conformance Limit

The bandwidth of the emission shall be no wider than 0.25% of the center frequency for devices operating above 70 MHz and below 900 MHz. For devices operating above 900 MHz, the emission shall be no wider than 0.5% of the center frequency. Bandwidth is determined at the points 20 dB down from the modulated carrier.

7.1.3 Test Configuration

Test according to clause 6.1 radio frequency test setup 1

7.1.4 Test Procedure

The EUT was operating in transmit mode and controlled its channel. Printed out the test result from the spectrum by hard copy function.

The RF output of EUT was connected to the spectrum analyzer by RF cable and attenuator. The path loss was compensated to the results for each measurement.

Set to the maximum power setting and enable the EUT transmit continuously

FCC Part 2.1049: Set RBW = 1% occupied bandwidth (30KHz).

RSS 210 Issue 10 Annex A.1.3: Set RBW = 1%-5% occupied bandwidth (30KHz)

Set the video bandwidth (VBW) =100KHz.

Set Span= approximately 3 to 5 times the occupied bandwidth

Set Detector = Peak.

Set Trace mode = max hold.

Set Sweep = auto couple.

The EUT should be transmitting at its maximum data rate. Allow the trace to stabilize. Use the marker-to-peak function to set the marker to the peak of the emission. Use the marker-delta function to measure 99% down one side of the emission. Reset the markerdelta function, and move the marker to the other side of the emission, until it is (as close as possible to) even with the reference marker level. The marker-delta reading at this point is the 99% bandwidth of the emission.

If this value varies with different modes of operation (e.g., data rate, modulation format, etc.), repeat this test for each variation.

Measure and record the results in the test report.

Test Results

Temperature : 28°C Test Date : May 15, 2023
 Humidity : 65 % Test By: Jack

Modulation Mode	Channel Number	Channel Frequency (MHz)	Measurement Bandwidth (kHz)	Limit (kHz)	Verdict
FSK	0	915.014	115.77	≤1084.3KHz	PASS

Note: N/A (Not Applicable)
 BW=0.25% of the center frequency

Modulation Mode	Channel Number	Channel Frequency (MHz)	99% Bandwidth (kHz)
FSK	0	915.014	744.53

Occupied Bandwidth

Test Model

Channel 0: 915.014MHz

FSK Modulation

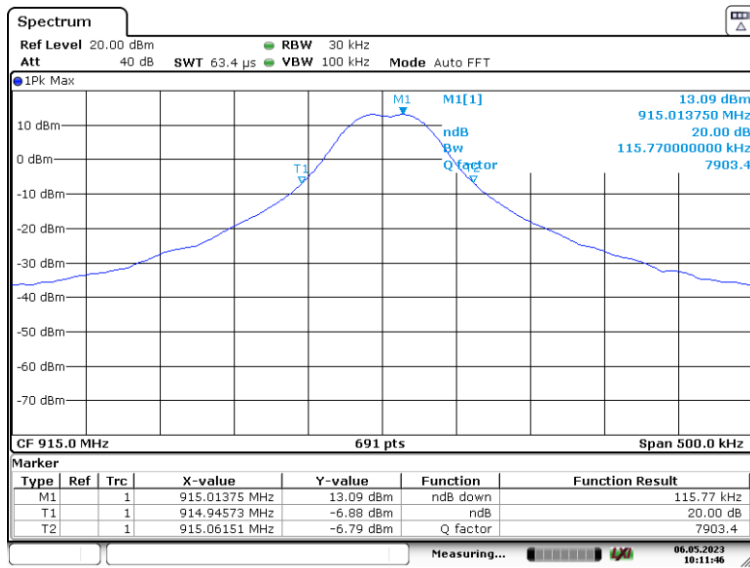

Date: 6.MAY.2023 10:11:45

Test Model

99% Bandwidth

Channel 0: 915.014MHz

FSK Modulation

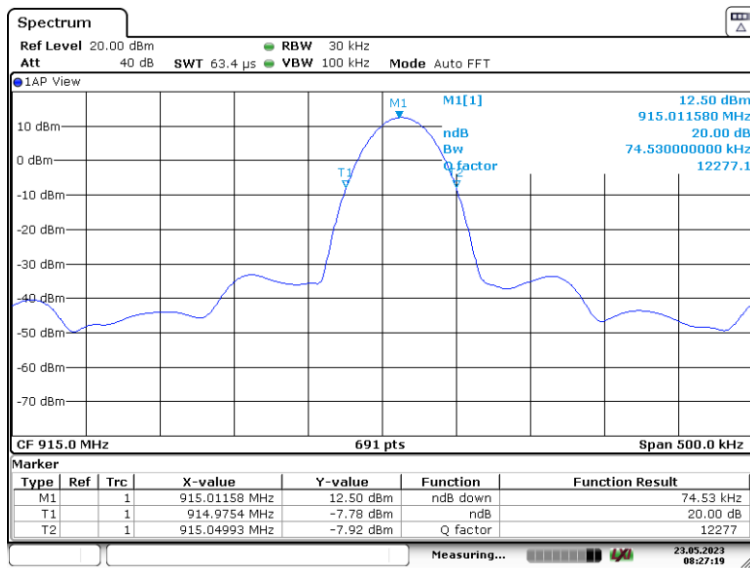

Date: 23.MAY.2023 08:27:19

7.2 RADIATED SPURIOUS EMISSION

7.2.1 Applicable Standard

According to According to RSS 210 Issue 10 Annex A.1.2

7.2.2 Conformance Limit

Intentional radiators may operate at a periodic rate exceeding that specified in paragraph (a) of this section and may be employed for any type of operation, including operation prohibited in paragraph (a) of this section, provided the intentional radiator complies with the provisions of paragraphs (b) through (d) of this section, except the field strength table in paragraph (b) of this section is replaced by the following:

Restricted frequency band

MHz	MHz	MHz	GHz
0.090 - 0.110	16.42 - 16.423	399.9 - 410	4.5 - 5.15
¹ 0.495 - 0.505	16.69475 - 16.69525	608 - 614	5.35 - 5.46
2.1735 - 2.1905	16.80425 - 16.80475	960 - 1240	7.25 - 7.75
4.125 - 4.128	25.5 - 25.67	1300 - 1427	8.025 - 8.5
4.17725 - 4.17775	37.5 - 38.25	1435 - 1626.5	9.0 - 9.2
4.20725 - 4.20775	73 - 74.6	1645.5 - 1646.5	9.3 - 9.5
6.215 - 6.218	74.8 - 75.2	1660 - 1710	10.6 - 12.7
6.26775 - 6.26825	108 - 121.94	1718.8 - 1722.2	13.25 - 13.4
6.31175 - 6.31225	123 - 138	2200 - 2300	14.47 - 14.5
8.291 - 8.294	149.9 - 150.05	2310 - 2390	15.35 - 16.2
8.362 - 8.366	156.52475 - 156.52525	2483.5 - 2500	17.7 - 21.4
8.37625 - 8.38675	156.7 - 156.9	2690 - 2900	22.01 - 23.12
8.41425 - 8.41475	162.0125 - 167.17	3260 - 3267	23.6 - 24.0
12.29 - 12.293	167.72 - 173.2	3332 - 3339	31.2 - 31.8
12.51975 - 12.52025	240 - 285	3345.8 - 3358	36.43 - 36.5
12.57675 - 12.57725	322 - 335.4	3600 - 4400	(²)

RSS-Gen Limited

Frequencies (MHz)	Field Strength (microrvolts/meter)	Measurement Distance (meters)
0.009~0.490	2400/F(KHz)	300
0.490~1.705	24000/F(KHz)	30
1.705~30.0	30	30
30~88	100	3
88~216	150	3
216~960	200	3
960~1000	500	3
Above 1GHz	74 dBuV/m (PEAK) 54 dBuV/m (AVERAGE)	

RSS 210 Issue 10 Annex A.1.2 Limited

Fundamental Frequency (MHz)	Field Strength of Fundamental (microvolts/meter)	Field Strength of Spurious Emissions (microvolts/meter)
40.66 - 40.70	2,250	225
70 - 130	1,250	125
130 - 174	1,250 to 3,750 **	125 to 375 **
174 - 260	3,750	375
260 - 470	3,750 to 12,500 **	375 to 1,250 **
Above 470	12,500	1,250

** linear interpolations

The field intensity in micro-volts per meter can then be determined by the following equation: $FI(V/m) = 10FI(dBV/m) / 20$ The FCC specified emission limits were calculated according the EUT operating frequency and obtained by following linear interpolation equations:

(a) For fundamental frequency:

$$f_{EUT} : \text{EUT Operating Frequency Emission Limit (V/m)}$$

$$= [f_{EUT}(\text{MHz}) - 260(\text{MHz})] \times \frac{12500(\text{V/m}) - 3750(\text{V/m})}{470(\text{MHz}) - 260(\text{MHz})} + 3750(\text{V/m})$$

(b) For spurious frequencies:

$$f_{EUT} : \text{EUT Operating Frequency Emission Limit (V/m)}$$

$$= [f_{EUT}(\text{MHz}) - 260(\text{MHz})] \times \frac{1250(\text{V/m}) - 375(\text{V/m})}{470(\text{MHz}) - 260(\text{MHz})} + 375(\text{V/m})$$

Other emissions radiated outside of the specified frequency bands, except for harmonics, shall be attenuated by at least 20 dB below the level of the fundamental or comply with the radiated emissions limits specified in section 1 5.209(a) limit in the table below has to be followed.

Note:

- (1) The tighter limit applies at the band edges.
- (2) Emission level (dBuV/m)=20log Emission level (uV/m).

RSS 210 Issue 10		
Fundamental Frequency	Field Strength Of Fundamental	Field Strength of Spurious Emissions
915.014MHz	AV:80.82 dBuV/m at 3m distance	AV:60.82 dBuV/m at 3m distance
	PK:100.82dBuV/m at 3m distance	PK:80.82 dBuV/m at 3m distance

Calculation of Average factor

The average correction factor is computed by analyzing the on time in 100ms over one complete pulse train. Analysis of the remote transmitter on time in one complete pulse train, therefore the average value of fundamental frequency is: Average= Peak Value+20log(Duty Cycle), where the duty factor is calculated from following formula:

The duty cycle is simply the on-time divided by the period:

The duration of one cycle= $0.75217 \times 2 + 0.74348 \times 4 = 4.47826\text{ms}$

Effective period of the cycle= 75.217ms

Duty Cycle= $(4.47826\text{ms}) / 75.217\text{ms} = 0.0595$

Therefore, the averaging factor is found by $20\log(0.0595) = -11.3$

Pulse Width(PW)= 75.217ms

$2/PW = 2/0.75217 = 2.659\text{KHz}$

$RBW = 1\text{MHz} > 2/PW (2.659\text{KHz})$

Therefore PDCF is no needed

Please see the test plot below:

pulse width:

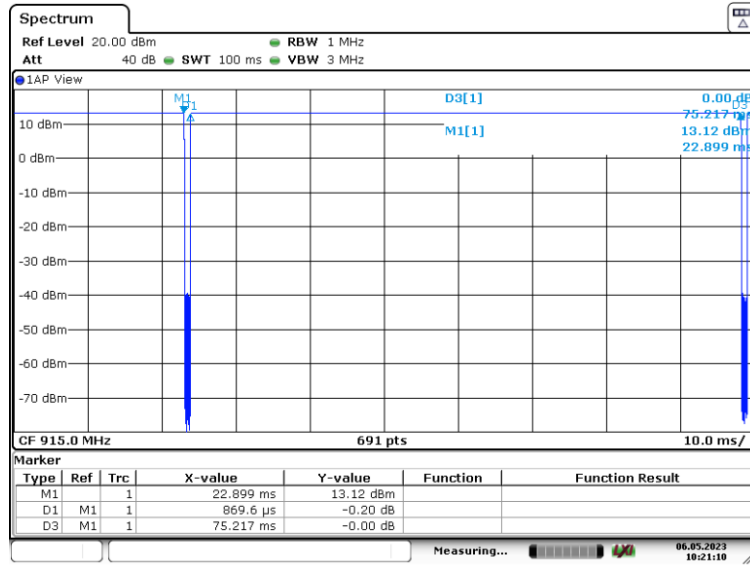

Date: 6.MAY.2023 10:21:10

pulse width of pulses:

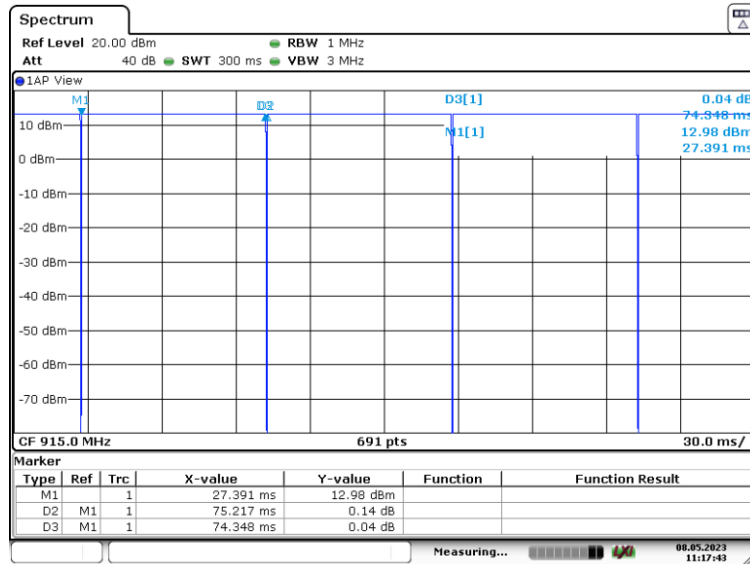

Date: 8.MAY.2023 11:17:42

7.2.3 Measurement Result

7.2.4 Spurious Emission below 30MHz (9KHz to30MHz)

Modulation:	FSK	Test Date :	May 15, 2023
Frequency Range:	9KHz-30MHz	Temperature :	25 °C
Test Result:	PASS	Humidity :	50 %
Measured Distance:	3m	Test By:	Jack

Freq. (MHz)	Ant.Pol. H/V	Emission Level (dBuV/m)	Limit 3m (dBuV/m)	Over (dB)
--	--	--	--	--

Note: the amplitude of spurious emission that is attenuated by more than 20dB below the permissible limit has no need to be reported.

Distance extrapolation factor = $40 \log(\text{Specific distance} / \text{test distance})$ (dB);

Limit line = Specific limits (dBuV) + distance extrapolation factor

7.2.5 Radiated spurious emission below 1GHz

Modulation:	FSK	Test Date :	May 15, 2023
Frequency Range:	30-1000MHz	Temperature :	25 °C
Test Result:	PASS	Humidity :	50 %
Measured Distance:	3m	Test By:	Jack

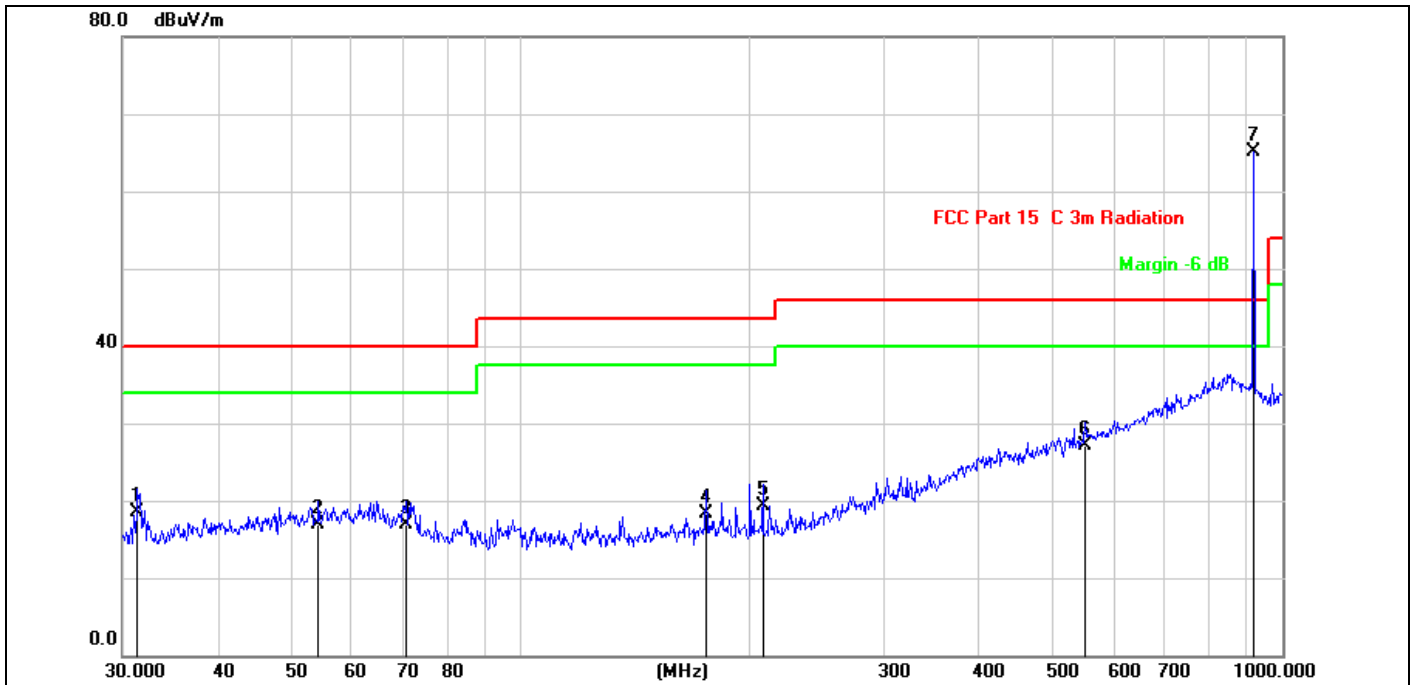

Site:	LAB	Antenna::	Vertical	Temperature(C):	26(C)
Limit:	FCC Part 15 C 3m Radiation			Humidity(%):	54%
EUT:	Carbon Monoxide alarm	Test Time:	2023-05-17		
M/N.:	C1-R	Power Rating:	DC 3V		
Mode:	TX	Test Engineer:	Jack		
Note:					

No.	Frequency (MHz)	Reading (dBuV)	Factor (dB/m)	Level (dBuV/m)	Limit (dBuV/m)	Margin (dB)	Det.	Remark
1	31.3992	30.47	-11.95	18.52	40.00	-21.48	QP	
2	54.2610	26.16	-9.27	16.89	40.00	-23.11	QP	
3	70.8315	27.39	-10.49	16.90	40.00	-23.10	QP	
4	175.0368	29.54	-11.24	18.30	43.50	-25.20	QP	
5	207.8501	30.48	-11.24	19.24	43.50	-24.26	QP	
6	550.9480	27.01	0.04	27.05	46.00	-18.95	QP	
7	915.0142	59.34	5.84	65.18	46.00	19.18	QP	

Note: 1. Result Level = Read Level+ Antenna Factor+ Cable Loss- Amp. Factor

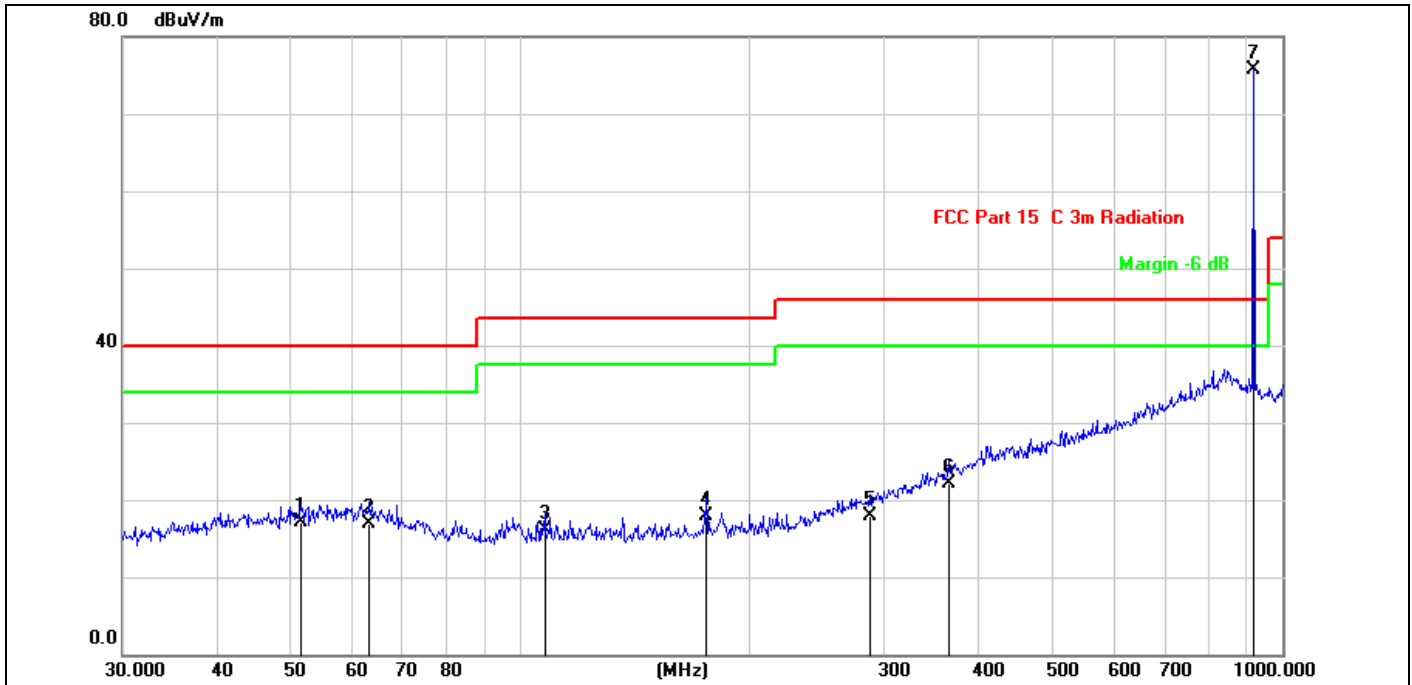

Site:	LAB	Antenna::Horizonta	Temperature(C):26(C)
Limit:	FCC Part 15 C 3m Radiation	1	Humidity(%):60%
EUT:	Carbon Monoxide alarm	Test Time:	2023-05-17
M/N.:	C1-R	Power Rating:	DC 3V
Mode:	TX	Test Engineer:	Jack
Note:			

No.	Frequency (MHz)	Reading (dBuV)	Factor (dB/m)	Level (dBuV/m)	Limit (dBuV/m)	Margin (dB)	Det.	Remark
1	51.4807	26.47	-9.35	17.12	40.00	-22.88	QP	
2	63.3132	25.82	-8.97	16.85	40.00	-23.15	QP	
3	107.5101	27.63	-11.53	16.10	43.50	-27.40	QP	
4	175.0368	29.24	-11.24	18.00	43.50	-25.50	QP	
5	286.9823	25.59	-7.69	17.90	46.00	-28.10	QP	
6	364.2595	26.76	-4.61	22.15	46.00	-23.85	QP	
7	915.0142	69.89	5.84	75.73	46.00	29.73	QP	

Note: 1. Result Level = Read Level+ Antenna Factor+ Cable Loss- Amp. Factor

7.2.6 Radiated spurious emission above 1GHz

Modulation: FSK Test Date : May 15, 2023
 Frequency Range: 1000-10000MHz Temperature : 25 °C
 Test Result: PASS Humidity : 50 %
 Measured Distance: 3m Test By: Jack

Frequency (MHz)	Pol.	Measure Result (QP, dBuV/m)	Limit (dBuV/m)	Result
915.014	H	65.18	94	Pass
915.014	V	75.73	94	Pass

The worst test result for Tx:

Freq. MHz	Reading dBuV	Ant. Fac dB/m	Pre. Fac. dB	Cab. Loss dB	Measured dBuV/m	Limit dBuV/m	Margin dB	Remark	Pol.
1830.03	50.25	33.01	35.00	3.86	52.12	74	-21.88	Peak	Horizontal
1830.03	36.65	33.01	35.00	3.86	38.52	54	-15.48	Average	Horizontal
2745.04	51.79	33.03	35.02	3.91	53.71	74	-20.29	Peak	Horizontal
2745.04	39.02	33.03	35.02	3.91	40.94	54	-13.06	Average	Horizontal
1830.03	52.22	33.01	35.00	3.86	54.09	74	-19.91	Peak	Vertical
1830.03	39.30	33.01	35.00	3.86	41.17	54	-12.83	Average	Vertical
2745.04	56.07	33.03	35.02	3.91	57.99	74	-16.01	Peak	Vertical
2745.04	39.64	33.03	35.02	3.91	41.56	54	-12.44	Average	Vertical

Notes:

1. Measuring frequencies from 9k~10th harmonic (ex. 10GHz), No emission found between lowest internal used/generated frequency to 30 MHz.
2. Radiated emissions measured in frequency range from 9k~10th harmonic (ex. 10GHz) were made with an instrument using Peak detector mode.

7.3 TRANSMISSION REQUIREMENT

7.3.1 Applicable Standard

According to RSS 210 Issue 10 Annex A.1.1

7.3.2 Conformance Limit

A manually operated transmitter shall be equipped with a push-to-operate switch and be under manual control at all times during transmission. When released, the transmitter shall cease transmission within no more than 5 seconds of being released

7.3.3 Test Configuration

Test according to clause 6.2 radio frequency test setup 2

7.3.4 Test Procedure

The following table is the setting of spectrum analyzer.

Spectrum analyzer	Setting
Attenuation	Auto
Span Frequency	0Hz
RBW	1M
VBW	3M
Detector	Peak
Trace	Max hold
Sweep Time	10S

- The transmitter output (antenna port) was connected to the spectrum analyzer.
- Set RBW of spectrum analyzer to 1MHz and VBW to 1MHz, Set Detector to Peak, Trace to Max Hold.
- Set the span to 0Hz and the sweep time to 10s and record the value.

7.3.5 Test Results

Temperature:	24°C	Test Date:	May 15, 2023
Humidity:	53 %	Test By:	Jack
Test mode:	TX Mode		

Frequency.(MHz)	Transmissions time	Limit	Verdict
915.014	0.8841S	5 seconds	PASS

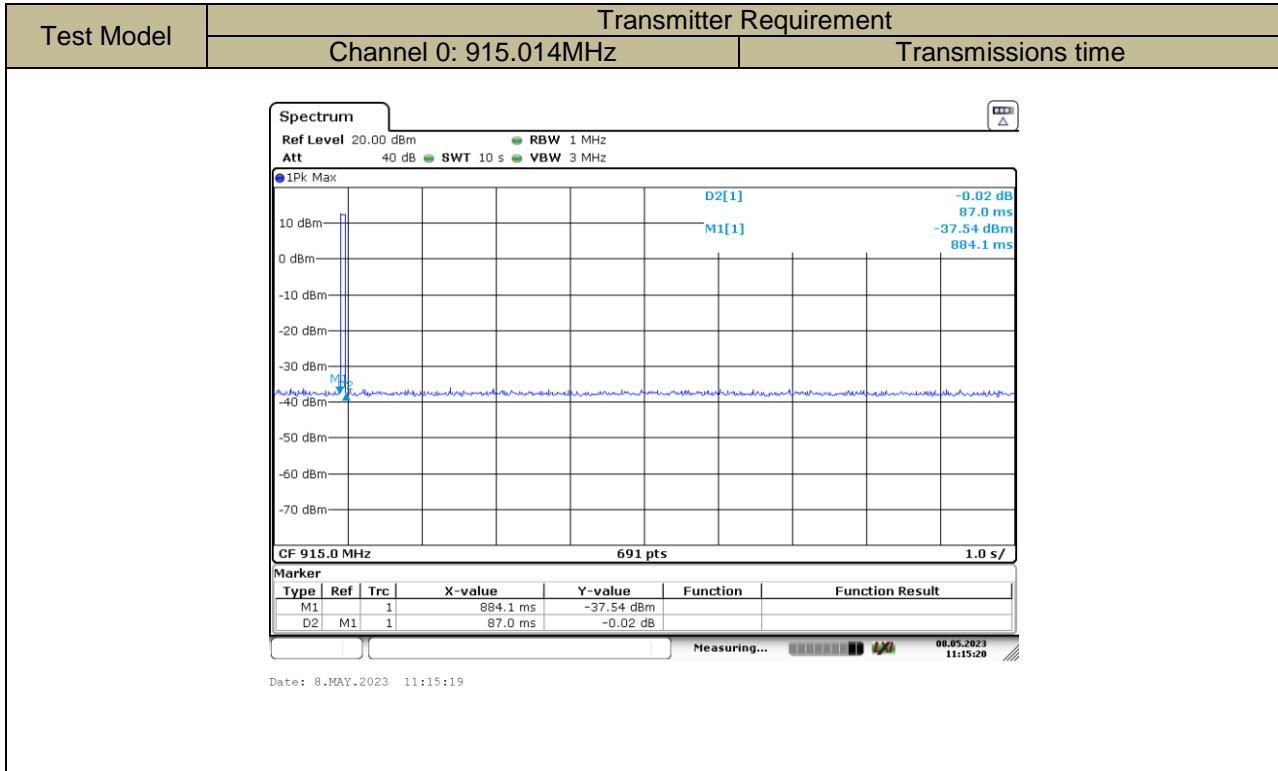

7.4 Band EDGE test

7.4.1 Standard Applicable

Emissions radiated outside of the specified frequency bands, except for harmonics, shall be attenuated by at least 50 dB below the level of the fundamental or to the general radiated emission limits in Section 15.209, whichever is the lesser attenuation.

7.4.2 Test Procedure

The EUT is placed on a turntable, which is 0.8m above the ground plane. The turntable shall be rotated for 360 degrees to determine the position of maximum emission level. EUT is set 3m away from the receiving antenna, which is varied from 1m to 4m to find out the highest emission. Set the spectrum analyzer in the following setting in order to capture the lower and upper band-edges of the emission:

Peak: RBW=120KHz, RBW=300KHz / Sweep=AUTO

Repeat the procedures until the peak versus polarization are measured.

7.4.3 Test SET-UP (Block Diagram of Configuration)

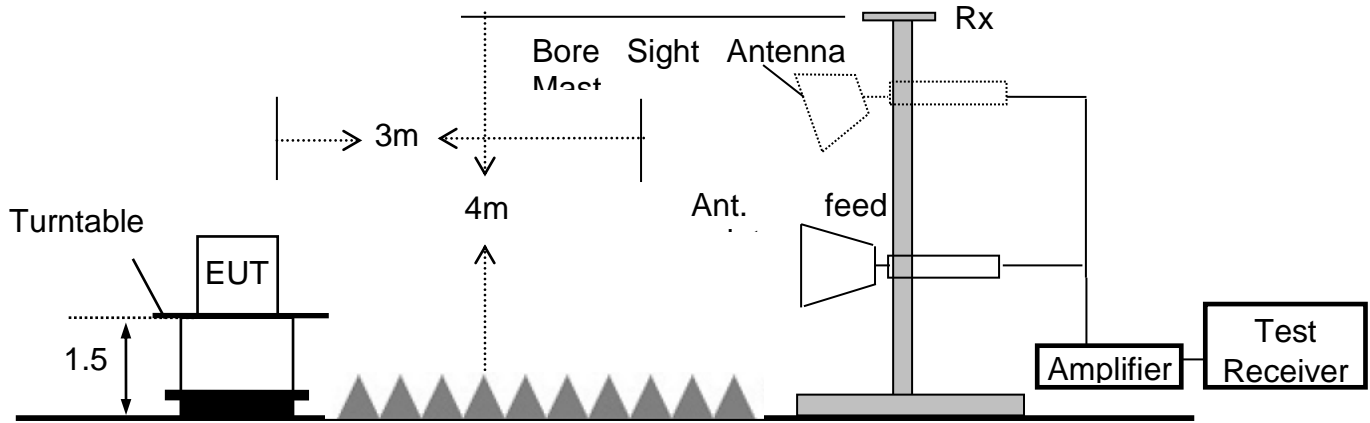

7.4.4 Measurement Equipment Used:

Item	Equipment	Manufacturer	Model No.	Serial No.	Calibrated until
1	Spectrum Analyzer	Rohde & Schwarz	FSV40	101413	2023-10-07
2	Low noise Amplifiers	A-INFO	LA1018N4009	J101313052400 1	2024-05-10
3	Horn antenna	A-INFO	LB-10180-SF	J203109061212 3	2024-05-10
4	RF Cable	Gigalink Microwave	ZT40-2.92J-2.92 J-2m	N/A	2024-05-10
5	RF Cable	Gigalink Microwave	ZT40-2.92J-2.92 J-0.3m	N/A	2024-05-10

7.4.5 Measurement Results:

Spectrum Detector:	PK	Test Date :	May 15, 2023
Test By:	Best	Temperature :	25 °C
Test Result:	PASS	Humidity :	50 %

Radiated emission Test
Test Result of Worst Case:

Test Mode	Frequency	Limit	Result
	MHz	dBuV/dBc	
Lowest	911.61	<46dBuV	Pass
Highest	923.11	<46dBuV	Pass

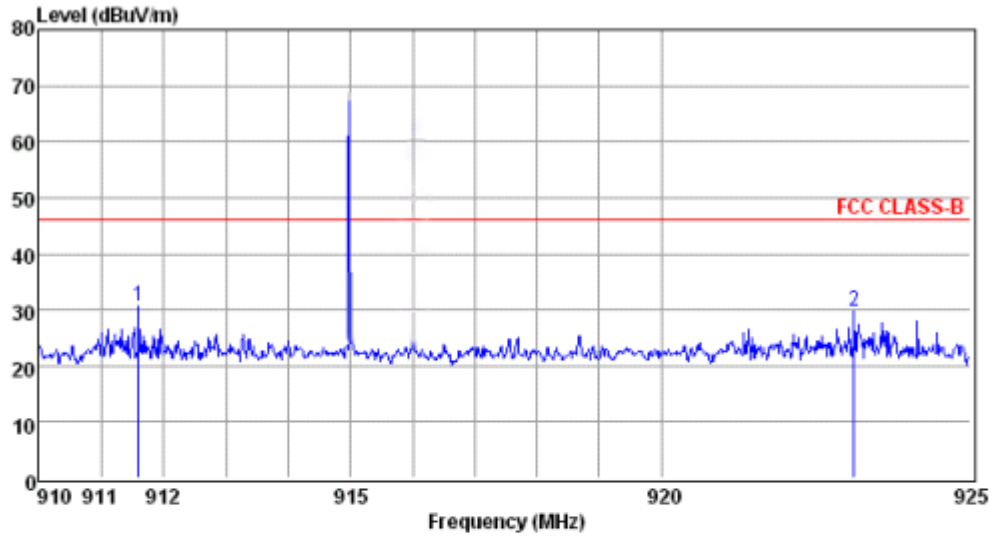

Env./Ins: 24°C/56%
pol: HORIZONTAL

	Freq	Reading	CabLos	Antfac	Measured	Limit	Over	Remark
	MHz	dBuV	dB	dB/m	dBuV/m	dBuV/m	dB	
1	911.61	7.57	1.86	21.17	30.60	46.00	-15.40	QP
2	923.11	6.56	1.99	21.24	29.79	46.00	-16.21	QP

Note: 1. All readings are Quasi-peak values.
2. Measured= Reading + Antenna Factor + Cable Loss
3. The emission that are 20db below the official limit are not reported

7.5 Antenna Application

7.5.1 Antenna Requirement

For intentional device, according to FCC 47 CFR Section 15.203, an intentional radiator shall be designed to ensure that no antenna other than that furnished by the responsible party shall be used with the device.

7.5.2 Result

The EUT's antenna is internal antenna, using an Internal Antenna which is not replaceable. The antenna's gain is -1dBi and meets the requirement.

APPENDIX I (Photos of EUT)

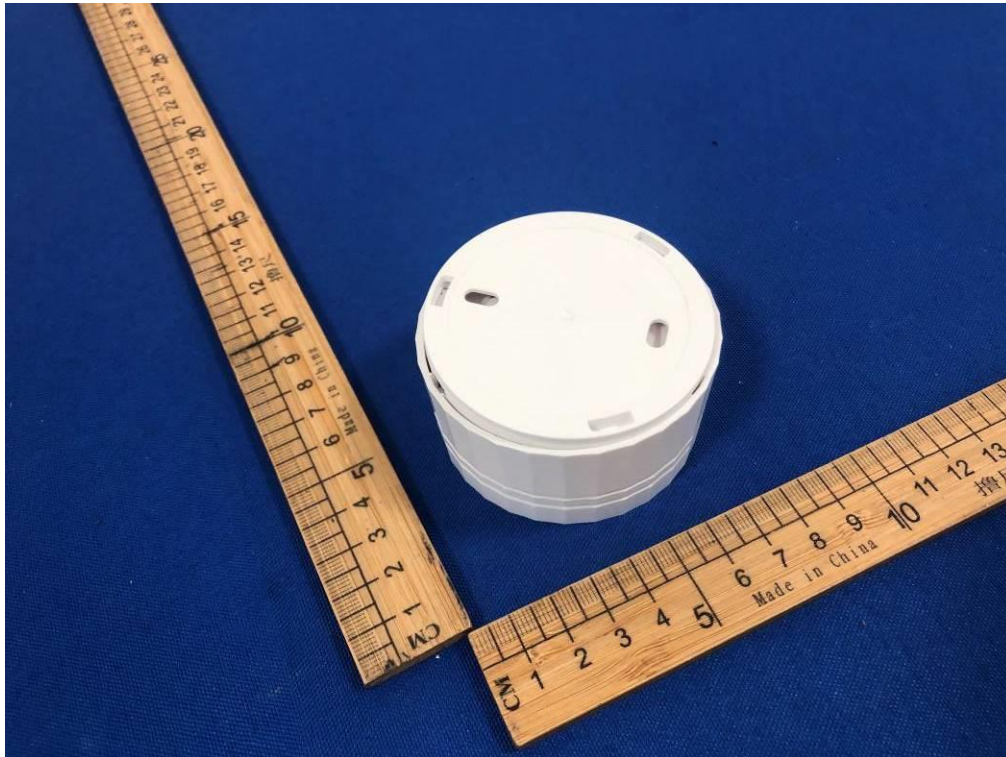

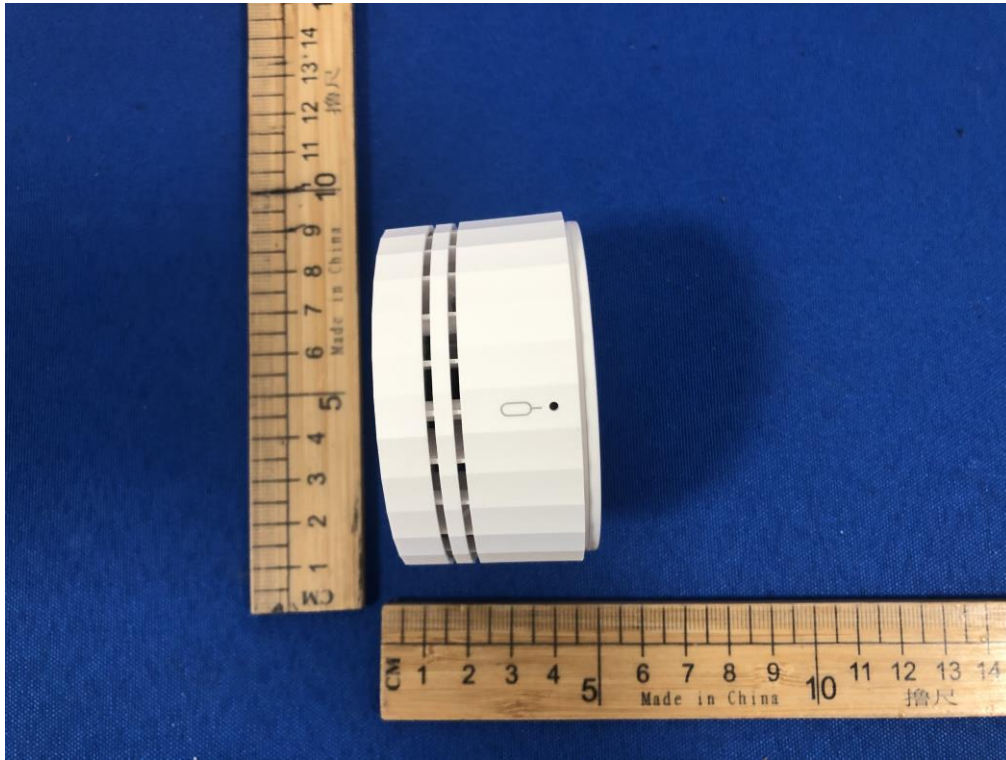

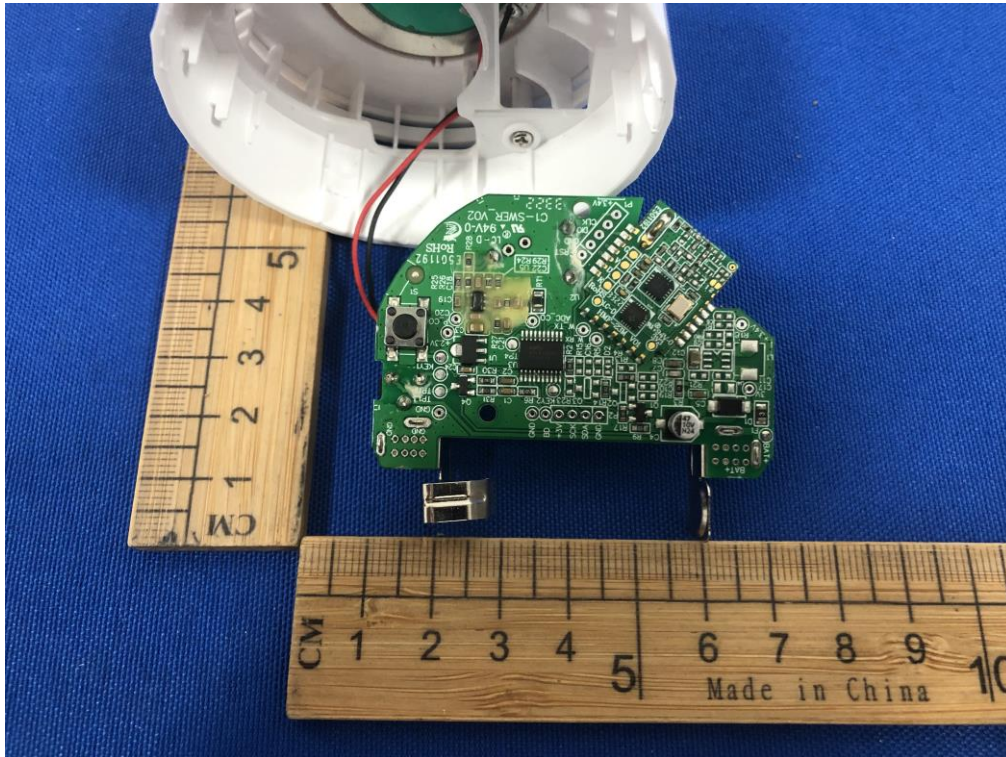
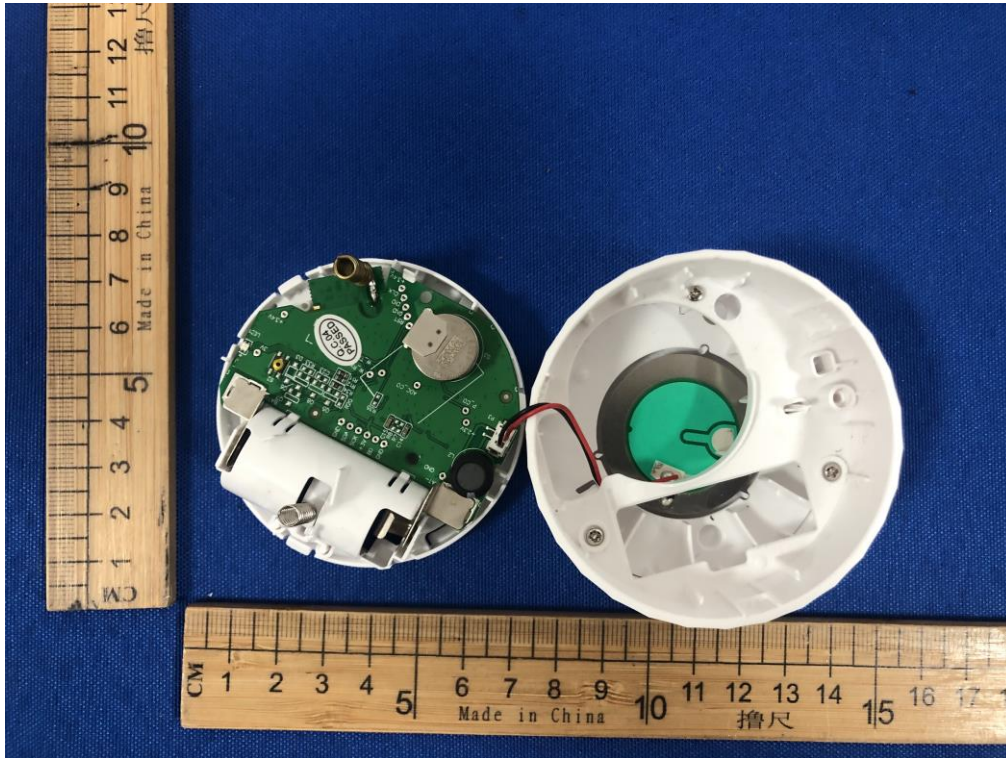

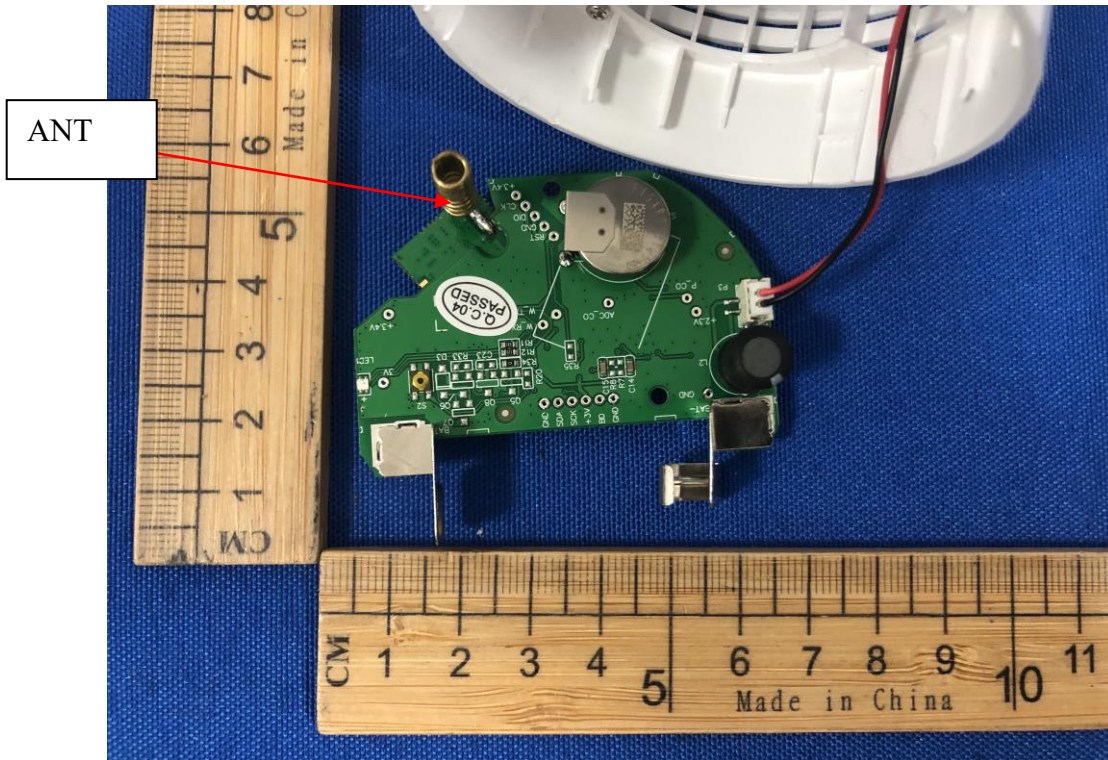

-----END OF REPORT-----