

FCC RF Test Report

(Bluetooth)

Report No.: JYTSZ-R12-2400407
Applicant: INFINIX MOBILITY LIMITED
Address of Applicant: FLAT N 16/F BLOCK B UNIVERSAL INDUSTRIAL CENTRE
19-25 SHAN MEI STREET FOTAN NT HONGKONG

Equipment Under Test (EUT)

Product Name: Mobile Phone
Model No.: X6838
Trade Mark: Infinix
FCC ID: 2AIZN-X6838
Applicable Standards: FCC CFR Title 47 Part 15C (§15.247)
Date of Sample Receipt: 11 Apr., 2024
Date of Test: 12 Apr., to 23 May, 2024
Date of Report Issued: 24 May, 2024
Test Result: PASS

Project by: Lyual Ding **Date:** 24 May, 2024
Reviewed by: Shen Zhao **Date:** 24 May, 2024
Approved by: Janet Wei **Date:** 24 May, 2024
Manager

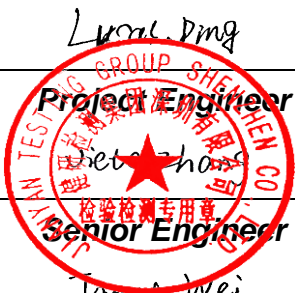

This equipment has been shown to be capable of compliance with the applicable technical standards as indicated in the measurement report and was tested in accordance with the measurement procedures specified in above the application standard version. Test results reported herein relate only to the item(s) tested.

This document cannot be reproduced except in full, without prior written approval of the Company. Any unauthorized alteration, forgery or falsification of the content or appearance of this document is unlawful and offenders may be prosecuted to the fullest extent of the law. Unless otherwise stated the results shown in this test report refer only to the sample(s) tested and such sample(s) are retained for 90 days only.

1 Version

Version No.	Date	Description
00	24 May, 2024	Original

2 Contents

Page

Cover Page	1
1 Version	2
2 Contents	3
3 General Information	4
3.1 Client Information	4
3.2 General Description of E.U.T.	4
3.3 Test Mode and Test Environment	5
3.4 Description of Test Auxiliary Equipment	5
3.5 Measurement Uncertainty	5
3.6 Additions to, Deviations, or Exclusions From the Method.....	5
3.7 Laboratory Facility	6
3.8 Laboratory Location.....	6
3.9 Test Instruments List	6
4 Measurement Setup and Procedure	9
4.1 Test Channel	9
4.2 Test Setup	9
4.3 Test Procedure	11
5 Test Results.....	12
5.1 Summary	12
5.1.1 Clause and data summary	12
5.1.2 Test Limit.....	13
5.2 Antenna Requirement	14
5.3 AC Power Line Conducted Emission	15
5.4 Emissions in Restricted Frequency Bands.....	17
5.5 Emissions in Non-restricted Frequency Bands	29

3 General Information

3.1 Client Information

Applicant:	INFINIX MOBILITY LIMITED
Address:	FLAT N 16/F BLOCK B UNIVERSAL INDUSTRIAL CENTRE 19-25 SHAN MEI STREET FOTAN NT HONGKONG
Manufacturer:	INFINIX MOBILITY LIMITED
Address:	FLAT N 16/F BLOCK B UNIVERSAL INDUSTRIAL CENTRE 19-25 SHAN MEI STREET FOTAN NT HONGKONG
Factory:	SHENZHEN TECNO TECHNOLOGY CO., LTD.
Address:	101, Building 24, Waijing Industrial Park, Fumin Community, Fucheng Street, Longhua District, Shenzhen City, P.R.China

3.2 General Description of E.U.T.

Product Name:	Mobile Phone
Model No.:	X6838
Operation Frequency:	2402 MHz - 2480 MHz
Transfer Rate:	1/2/3 Mbits/s
Number of Channel:	79
Modulation Type:	GFSK, $\pi/4$ -DQPSK, 8DPSK
Modulation Technology:	FHSS
Antenna Type:	Internal Antenna
Antenna Gain:	ANT6:1.49 dBi (declare by applicant)
Antenna transmit mode:	SISO (1TX, 1RX)
Power Supply:	Rechargeable Li-ion Polymer Battery DC3.85V, 4900mAh
AC Adapter:	Model: U180XSA Input: AC100-240V, 50/60Hz, 0.6A Output: DC 5.0V, 2.4A or 7.5V, 2.4A 18.0W MAX
Test Sample Condition:	The test samples were provided in good working order with no visible defects.

3.3 Test Mode and Test Environment

Test Modes:	
Non-hopping mode:	Keep the EUT in continuous transmitting mode.
Hopping mode:	Keep the EUT in hopping mode.
Remark:	
1. For AC power line conducted emission and radiated spurious emission, pre-scan GFSK, $\pi/4$ -DQPSK, 8DPSK modulation mode, found GFSK modulation was worse case mode. The report only reflects the test data of worst mode. 2. Channel Low, Mid and High for each type band with rated data rate were chosen for full testing. The field strength of spurious radiation emission was measured as EUT stand-up position (H mode) and lie down position (E1, E2 mode) for these modes. Just the worst case position (H mode) shown in report.	
Operating Environment:	
Temperature:	15°C ~ 35°C
Humidity:	20 % ~ 75 % RH
Atmospheric Pressure:	1008 mbar
Voltage:	Nominal: 3.85Vdc, Extreme: Low 3.00Vdc, High 4.40Vdc
Test Engineer:	Logan Li (Conducted measurement) Kiran Zeng (Radiated measurement)

3.4 Description of Test Auxiliary Equipment

The EUT has been tested as an independent unit.

3.5 Measurement Uncertainty

Parameter	Expanded Uncertainty (Confidence of 95%(U = 2Uc(y)))
Conducted Emission for LISN (9kHz ~ 150kHz)	3.57 dB
Conducted Emission for LISN (150kHz ~ 30MHz)	3.14 dB
Radiated Emission (30MHz ~ 200MHz) (3m SAC)	4.6 dB
Radiated Emission (200MHz ~ 1000MHz) (3m SAC)	5.8 dB
Radiated Emission (1GHz ~ 6GHz) (3m FAR)	4.95 dB
Radiated Emission (6GHz ~ 18GHz) (3m FAR)	5.23 dB
Radiated Emission (18GHz ~ 40GHz) (3m FAR)	5.32 dB
Note: All the measurement uncertainty value were shown with a coverage $k=2$ to indicate 95% level of confidence. The measurement data show herein meets or exceeds the CISPR measurement uncertainty values specified in CISPR 16-4-2 and can be compared directly to specified limit to determine compliance.	

3.6 Additions to, Deviations, or Exclusions From the Method

No

3.7 Laboratory Facility

The test facility is recognized, certified, or accredited by the following organizations:

● **FCC - Designation No.: CN1211**

JianYan Testing Group Shenzhen Co., Ltd. has been accredited as a testing laboratory by FCC(Federal Communications Commission). The test firm Registration No. is 727551.

● **ISED – CAB identifier.: CN0021**

The 3m Semi-anechoic chamber and 10m Semi-anechoic chamber of JianYan Testing Group Shenzhen Co., Ltd. has been Registered by Certification and Engineering Bureau of Industry Canada for radio equipment testing with Registration No.: 10106A-1.

● **CNAS - Registration No.: CNAS L15527**

JianYan Testing Group Shenzhen Co., Ltd. is accredited to ISO/IEC 17025:2017 General Requirements for the Competence of Testing and Calibration laboratories for the competence of testing. The Registration No. is CNAS L15527.

● **A2LA - Registration No.: 4346.01**

This laboratory is accredited in accordance with the recognized International Standard ISO/IEC 17025:2017 General requirements for the competence of testing and calibration laboratories. The test scope can be found as below link: <https://portal.a2la.org/scopepdf/4346-01.pdf>

3.8 Laboratory Location

JianYan Testing Group Shenzhen Co., Ltd.

Address: No.101, Building 8, Innovation Wisdom Port, No.155 Hongtian Road, Huangpu Community, Xinqiao Street, Bao'an District, Shenzhen, Guangdong, People's Republic of China.

Tel: +86-755-23118282, Fax: +86-755-23116366

Email: info-JYTee@lets.com, Website: <http://jyt.lets.com>

3.9 Test Instruments List

Radiated Emission(3m SAC):					
Test Equipment	Manufacturer	Model No.	Manage No.	Cal. Date (mm-dd-yy)	Cal. Due date (mm-dd-yy)
3m SAC	ETS	9m*6m*6m	WXJ001-1	04-14-2021	04-13-2026
Loop Antenna	Schwarzbeck	FMZB 1519 B	WXJ002-4	01-05-2024	01-04-2025
BiConiLog Antenna	Schwarzbeck	VULB9163	WXJ002	01-09-2024	01-08-2025
Horn Antenna	Schwarzbeck	BBHA9120D	WXJ002-2	01-05-2024	01-04-2025
Horn Antenna	Schwarzbeck	BBHA9170	WXJ002-5	12-28-2023	12-27-2024
Pre-amplifier (30MHz ~ 1GHz)	Schwarzbeck	BBV9743B	WXJ001-2	12-27-2023	12-26-2024
EMI Test Receiver	Rohde & Schwarz	ESRP7	WXJ003-1	12-27-2023	12-26-2024
Spectrum Analyzer	Rohde & Schwarz	FSP 30	WXJ004	12-27-2023	12-26-2024
Spectrum Analyzer	KEYSIGHT	N9010B	WXJ004-2	09-25-2023	09-24-2024
Coaxial Cable (30MHz ~ 1GHz)	JYTSZ	JYT3M-1G-NN-8M	WXG001-4	01-17-2024	01-16-2025
Coaxial Cable (1GHz ~ 18GHz)	JYTSZ	JYT3M-18G-NN-8M	WXG001-5	01-17-2024	01-16-2025
Coaxial Cable (18GHz ~ 40GHz)	JYTSZ	JYT3M-40G-SS-8M	WXG001-7	01-17-2024	01-16-2025
Band Reject Filter Group	Tonscend	JS0806-F	WXJ089	N/A	
Test Software	Tonscend	TS+	Version: 3.0.0.1		

Radiated Emission(3m FAR):					
Test Equipment	Manufacturer	Model No.	Manage No.	Cal. Date (mm-dd-yy)	Cal. Due date (mm-dd-yy)
3m FAR	YUNYI	9m*6m*6m	WXJ097	06-15-2023	06-14-2028
BiConiLog Antenna	Schwarzbeck	VULB9163	WXJ097-2	07-13-2023	07-12-2024
Biconical Antenna	Schwarzbeck	VUBA9117	WXJ002-1	07-02-2021	07-01-2024
Horn Antenna	Schwarzbeck	BBHA9120D	WXJ097-3	07-14-2023	07-13-2024
Horn Antenna	Schwarzbeck	BBHA9120D	WXJ002-3	12-28-2023	12-27-2024
Horn Antenna	Schwarzbeck	BBHA9170	WXJ002-5	12-28-2023	12-27-2024
Horn Antenna	Schwarzbeck	BBHA9170	WXJ002-6	12-28-2023	12-27-2024
Pre-amplifier (30MHz ~ 1GHz)	YUNYI	PAM-310N	WXJ097-5	05-14-2023	05-13-2024
				04-24-2024	04-23-2025
Pre-amplifier (1GHz ~ 18GHz)	YUNYI	PAM-118N	WXJ097-6	05-14-2023	05-13-2024
				04-24-2024	04-23-2025
Pre-amplifier (18GHz ~ 40GHz)	RF System	TRLA-180400G45B	WXJ002-7	12-28-2023	12-27-2024
EMI Test Receiver	Rohde & Schwarz	ESCI3	WXJ003	12-27-2023	12-26-2024
Spectrum Analyzer	Rohde & Schwarz	FSP 30	WXJ004	12-27-2023	12-26-2024
Spectrum Analyzer	KEYSIGHT	N9010B	WXJ081-1	06-13-2023	06-12-2024
Coaxial Cable (30MHz ~ 1GHz)	JYTSZ	JYT3M-1G-NN-13M	WXG097-1	08-01-2023	07-31-2024
Coaxial Cable (1GHz ~ 18GHz)	JYTSZ	JYT3M-18G-NN-8M	WXG097-2	08-01-2023	07-31-2024
Coaxial Cable (18GHz ~ 40GHz)	JYTSZ	JYT3M-40G-SS-8M	WXG097-3	08-01-2023	07-31-2024
High Band Reject Filter Group	Tonscend	JS0806-F	WXJ089	N/A	
Low Band Reject Filter Group	Tonscend	JS0806-F	WXJ097-4	N/A	
Test Software	Tonscend	TS+	Version: 5.0.0		

Conducted Emission:					
Test Equipment	Manufacturer	Model No.	Manage No.	Cal. Date (mm-dd-yy)	Cal. Due date (mm-dd-yy)
EMI Test Receiver	Rohde & Schwarz	ESR3	WXJ003-2	07-05-2023	07-04-2024
LISN	Schwarzbeck	NSLK 8127	QCJ001-13	12-27-2023	12-26-2024
LISN	Rohde & Schwarz	ESH3-Z5	WXJ005-1	12-27-2023	12-26-2024
LISN Coaxial Cable (9kHz ~ 30MHz)	JYTSZ	JYTCE-1G-NN-2M	WXG003-1	01-17-2024	01-16-2025
RF Switch	TOP PRECISION	RSU0301	WXG003	N/A	
Test Software	AUDIX	E3	Version: 6.110919b		

Conducted Method:					
Test Equipment	Manufacturer	Model No.	Manage No.	Cal. Date (mm-dd-yy)	Cal. Due date (mm-dd-yy)
Spectrum Analyzer	Keysight	N9010B	WXJ004-3	11-01-2023	10-31-2024
Temperature Humidity Chamber	ZHONG ZHI	CZ-A-80D	WXJ032-3	01-09-2023	01-08-2025
Power Detector Box	MWRFTTEST	MW100-PSB	WXJ007-4	09-25-2023	09-24-2024
DC Power Supply	Keysight	E3642A	WXJ025-2	N/A	
RF Control Unit	MWRFTTEST	MW100-RFCB	WXG006	N/A	
Test Software	MWRFTTEST	MTS 8310	Version: 2.0.0.0		

4 Measurement Setup and Procedure

4.1 Test Channel

According to ANSI C63.10-2013 chapter 5.6.1 Table 4 requirement, select lowest channel, middle channel, and highest channel in the frequency range in which device operates for testing. The detailed frequency points are as follows:

Lowest channel		Middle channel		Highest channel	
Channel No.	Frequency (MHz)	Channel No.	Frequency (MHz)	Channel No.	Frequency (MHz)
0	2402	39	2441	78	2480

4.2 Test Setup

1) Conducted emission measurement:

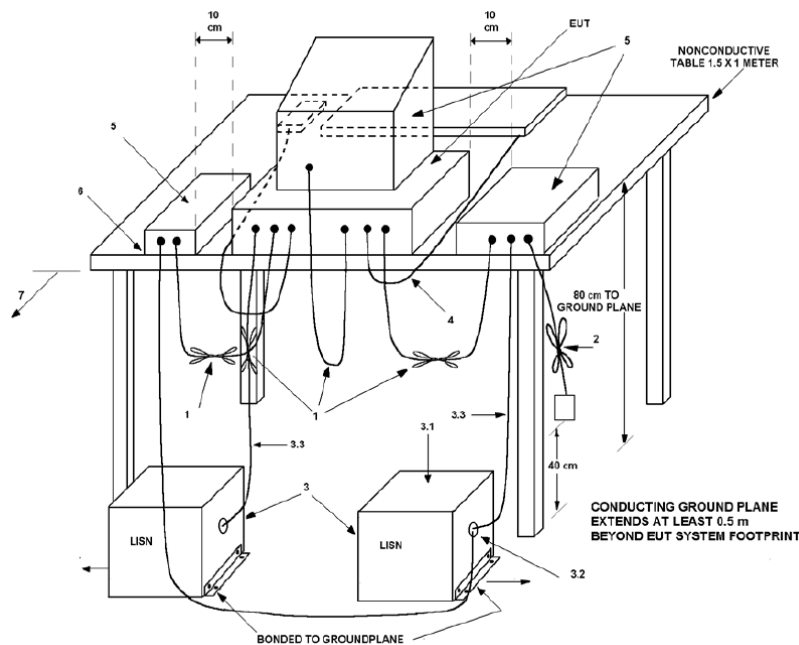

Note: The detailed descriptions please refer to Figure 8 of ANSI C63.4:2014.

2) Radiated emission measurement:

Below 1GHz (3m SAC)

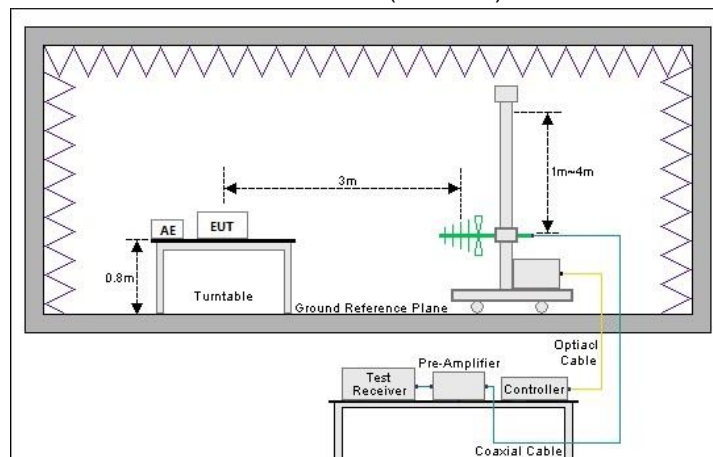

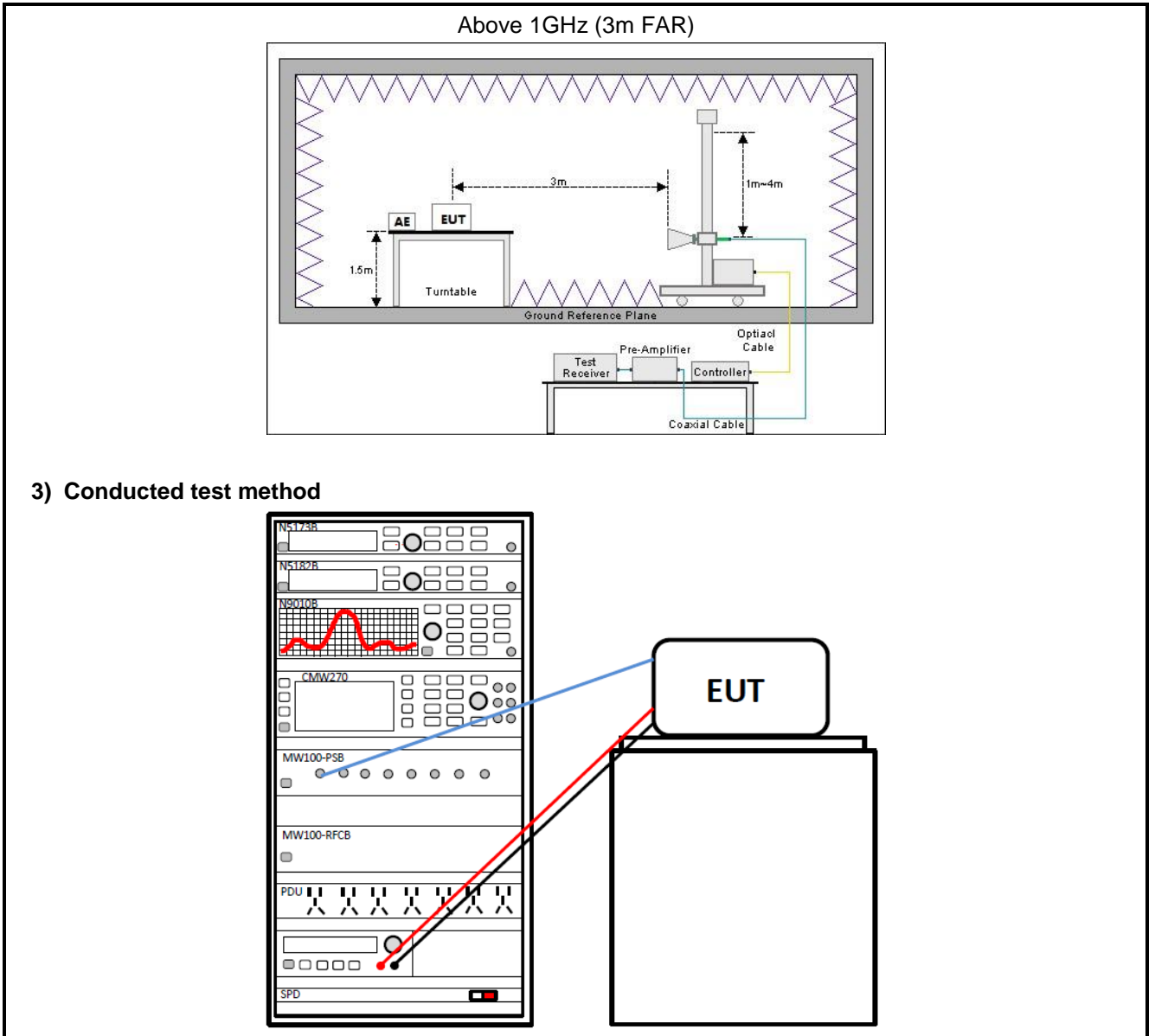

4.3 Test Procedure

Test method	Test step
Conducted emission	<ol style="list-style-type: none"> The E.U.T and simulators are connected to the main power through a line impedance stabilization network (L.I.S.N.). This provides a 50ohm/50uH coupling impedance for the measuring equipment. The peripheral devices are also connected to the main power through a LISN that provides a 50ohm/50uH coupling impedance with 50ohm termination. (Please refer to the block diagram of the test setup and photographs). Both sides of A.C. line are checked for maximum conducted interference. In order to find the maximum emission, the relative positions of equipment and all of the interface cables must be changed according to ANSI C63.10 on conducted measurement.
Radiated emission	<p>For below 1GHz:</p> <ol style="list-style-type: none"> The EUT was placed on the tabletop of a rotating table 0.8 m the ground at a 3 m semi anechoic chamber. The measurement distance from the EUT to the receiving antenna is 3 m. EUT works in each mode of operation that needs to be tested, and having the EUT continuously working, respectively on 3 axis (X, Y & Z) and considered typical configuration to obtain worst position. The highest signal levels relative to the limit shall be determined by rotating the EUT from 0° to 360° and with varying the measurement antenna height between 1 m and 4 m in vertical and horizontal polarizations. Open the test software to control the test antenna and test turntable. Perform the test, save the test results, and export the test data. <p>For above 1GHz:</p> <ol style="list-style-type: none"> The EUT was placed on the tabletop of a rotating table 1.5 m the ground at a 3 m fully anechoic room. The measurement distance from the EUT to the receiving antenna is 3 m. EUT works in each mode of operation that needs to be tested, and having the EUT continuously working, respectively on 3 axis (X, Y & Z) and considered typical configuration to obtain worst position. The highest signal levels relative to the limit shall be determined by rotating the EUT from 0° to 360° and with varying the measurement antenna height between 1 m and 4 m in vertical and horizontal polarizations. Open the test software to control the test antenna and test turntable. Perform the test, save the test results, and export the test data.
Conducted test method	<ol style="list-style-type: none"> The Bluetooth antenna port of EUT was connected to the test port of the test system through an RF cable. The EUT is keeping in continuous transmission mode and tested in all modulation modes. Open the test software, prepare a test plan, and control the system through the software. After the test is completed, the test report is exported through the test software.

5 Test Results

5.1 Summary

5.1.1 Clause and data summary

Test items	Standard clause	Test data	Result
Antenna Requirement	15.203 15.247 (b)(4)	See Section 5.2	Pass
AC Power Line Conducted Emission	15.207	See Section 5.3	Pass
Conducted Output Power	15.247 (b)(1)	Appendix – BT	Pass
20dB Occupied Bandwidth	15.247 (a)(1)	Appendix – BT	Pass
Carrier Frequencies Separation	15.247 (a)(1)	Appendix – BT	Pass
Hopping Channel Number	5.247 (a)(1)(iii)	Appendix – BT	Pass
Dwell Time	15.247 (a)(1)(iii)	Appendix – BT	Pass
Band-edge Emission Conduction Spurious Emission	15.247 (d)	Appendix – BT	Pass
Emissions in Restricted Frequency Bands	15.205 15.247 (d)	See Section 5.4	Pass
Emissions in Non-restricted Frequency Bands	15.209 15.247(d)	See Section 5.5	Pass
Remark: 1. <i>Pass: The EUT complies with the essential requirements in the standard.</i> 2. <i>N/A: Not Applicable.</i> 3. <i>The cable insertion loss used by “RF Output Power” and other conduction measurement items is 0.5dB (provided by the customer).</i>			
Test Method:	ANSI C63.10-2013 KDB 558074 D01 15.247 Meas Guidance v05r02		

5.1.2 Test Limit

Test items	Limit																														
AC Power Line Conducted Emission	<table border="1"> <thead> <tr> <th rowspan="2">Frequency (MHz)</th> <th colspan="2">Limit (dBμV)</th> </tr> <tr> <th>Quasi-Peak</th> <th>Average</th> </tr> </thead> <tbody> <tr> <td>0.15 – 0.5</td> <td>66 to 56 <small>Note 1</small></td> <td>56 to 46 <small>Note 1</small></td> </tr> <tr> <td>0.5 – 5</td> <td>56</td> <td>46</td> </tr> <tr> <td>5 – 30</td> <td>60</td> <td>50</td> </tr> </tbody> </table> <p>Note 1: The limit level in dBμV decreases linearly with the logarithm of frequency. Note 2: The more stringent limit applies at transition frequencies.</p>	Frequency (MHz)	Limit (dB μ V)		Quasi-Peak	Average	0.15 – 0.5	66 to 56 <small>Note 1</small>	56 to 46 <small>Note 1</small>	0.5 – 5	56	46	5 – 30	60	50																
Frequency (MHz)	Limit (dB μ V)																														
	Quasi-Peak	Average																													
0.15 – 0.5	66 to 56 <small>Note 1</small>	56 to 46 <small>Note 1</small>																													
0.5 – 5	56	46																													
5 – 30	60	50																													
Conducted Output Power	For frequency hopping systems operating in the 2400-2483.5 MHz band employing at least 75 non-overlapping hopping channels: 1 watt. For all other frequency hopping systems in the 2400-2483.5 MHz band: 0.125 watts.																														
20dB Occupied Bandwidth	Within authorization band																														
Carrier Frequencies Separation	a) 0.025MHz or the 20dB bandwidth (whichever is greater). b) 0.025MHz or two-thirds of the 20dB bandwidth (whichever is greater).																														
Hopping Channel Number	At least 15 channels.																														
Dwell Time	Not be greater than 0.4 seconds.																														
Band-edge Emission Conduction Spurious Emission	In any 100 kHz bandwidth outside the frequency band in which the spread spectrum or digitally modulated intentional radiator is operating, the radio frequency power that is produced by the intentional radiator shall be at least 20 dB below that in the 100 kHz bandwidth within the band that contains the highest level of the desired power, based on either an RF conducted or a radiated measurement, provided the transmitter demonstrates compliance with the peak conducted power limits. If the transmitter complies with the conducted power limits based on the use of RMS averaging over a time interval, as permitted under paragraph (b)(3) of this section, the attenuation required under this paragraph shall be 30 dB instead of 20 dB. Attenuation below the general limits specified in §15.209(a) is not required. In addition, radiated emissions which fall in the restricted bands, as defined in §15.205(a), must also comply with the radiated emission limits specified in §15.209(a) (see §15.205(c)).																														
Emissions in Restricted Frequency Bands Emissions in Non-restricted Frequency Bands	<table border="1"> <thead> <tr> <th rowspan="2">Frequency (MHz)</th> <th colspan="2">Limit (dBμV/m)</th> <th rowspan="2">Detector</th> </tr> <tr> <th>@ 3m</th> <th>@ 10m</th> </tr> </thead> <tbody> <tr> <td>30 – 88</td> <td>40.0</td> <td>30.0</td> <td>Quasi-peak</td> </tr> <tr> <td>88 – 216</td> <td>43.5</td> <td>33.5</td> <td>Quasi-peak</td> </tr> <tr> <td>216 – 960</td> <td>46.0</td> <td>36.0</td> <td>Quasi-peak</td> </tr> <tr> <td>960 – 1000</td> <td>54.0</td> <td>44.0</td> <td>Quasi-peak</td> </tr> </tbody> </table> <p>Note: The more stringent limit applies at transition frequencies.</p> <table border="1"> <thead> <tr> <th rowspan="2">Frequency</th> <th colspan="2">Limit (dBμV/m) @ 3m</th> </tr> <tr> <th>Average</th> <th>Peake</th> </tr> </thead> <tbody> <tr> <td>Above 1 GHz</td> <td>54.0</td> <td>74.0</td> </tr> </tbody> </table> <p>Note: The measurement bandwidth shall be 1 MHz or greater.</p>	Frequency (MHz)	Limit (dB μ V/m)		Detector	@ 3m	@ 10m	30 – 88	40.0	30.0	Quasi-peak	88 – 216	43.5	33.5	Quasi-peak	216 – 960	46.0	36.0	Quasi-peak	960 – 1000	54.0	44.0	Quasi-peak	Frequency	Limit (dB μ V/m) @ 3m		Average	Peake	Above 1 GHz	54.0	74.0
Frequency (MHz)	Limit (dB μ V/m)		Detector																												
	@ 3m	@ 10m																													
30 – 88	40.0	30.0	Quasi-peak																												
88 – 216	43.5	33.5	Quasi-peak																												
216 – 960	46.0	36.0	Quasi-peak																												
960 – 1000	54.0	44.0	Quasi-peak																												
Frequency	Limit (dB μ V/m) @ 3m																														
	Average	Peake																													
Above 1 GHz	54.0	74.0																													

5.2 Antenna Requirement

Standard requirement:	FCC Part 15 C Section 15.203 & 247(b)
<p>15.203 requirement: An intentional radiator shall be designed to ensure that no antenna other than that furnished by the responsible party shall be used with the device. The use of a permanently attached antenna or of an antenna that uses a unique coupling to the intentional radiator, the manufacturer may design the unit so that a broken antenna can be replaced by the user, but the use of a standard antenna jack or electrical connector is prohibited.</p> <p>15.247(b) (4) requirement: (4) The conducted output power limit specified in paragraph (b) of this section is based on the use of antennas with directional gains that do not exceed 6 dBi. Except as shown in paragraph (c) of this section, if transmitting antennas of directional gain greater than 6 dBi are used, the conducted output power from the intentional radiator shall be reduced below the stated values in paragraphs (b)(1), (b)(2), and (b)(3) of this section, as appropriate, by the amount in dB that the directional gain of the antenna exceeds 6 dBi.</p>	
E.U.T Antenna:	
<p>The Bluetooth antenna is an Internal antenna which permanently attached, and the best case gain of the antenna is 1.49 dBi. See product internal photos for details.</p>	

5.3 AC Power Line Conducted Emission

Product name:	Mobile Phone	Product model:	X6838
Test by:	Asher Zhang	Test mode:	BT Tx mode
Test frequency:	150 kHz ~ 30 MHz	Phase:	Line
Test voltage:	AC 120 V/60 Hz		

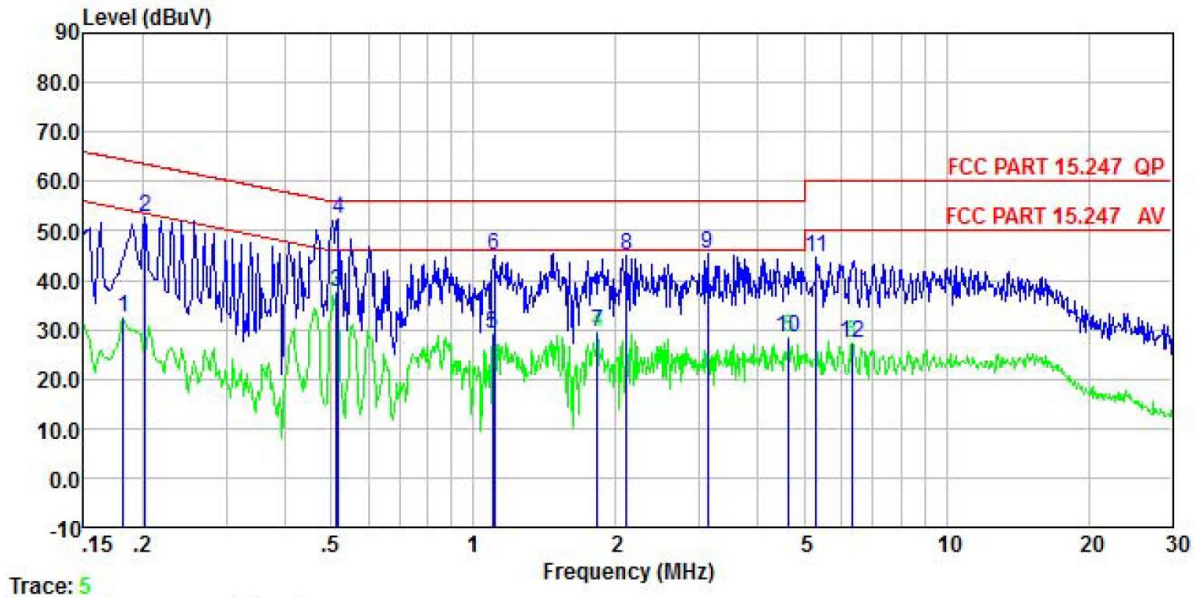

Trace: 5

	Freq	Read Level	LISN Factor	Aux Factor	Aux2 Factor	Cable Loss	Level	Limit Line	Over Limit	Remark
	MHz	dBuV	dB	dB	dB	dB	dBuV	dBuV	dB	
1	0.182	22.18	0.20	0.00	9.88	0.01	32.27	54.42	-22.15	Average
2	0.202	42.57	0.20	0.00	9.88	0.04	52.69	63.54	-10.85	QP
3	0.513	27.50	0.20	0.00	9.88	0.03	37.61	46.00	-8.39	Average
4	0.518	42.19	0.20	0.00	9.88	0.03	52.30	56.00	-3.70	QP
5	1.100	18.79	0.20	0.00	9.88	0.07	28.94	46.00	-17.06	Average
6	1.106	34.67	0.20	0.00	9.88	0.07	44.82	56.00	-11.18	QP
7	1.829	19.22	0.20	0.00	9.88	0.19	29.49	46.00	-16.51	Average
8	2.110	34.64	0.20	0.00	9.88	0.19	44.91	56.00	-11.09	QP
9	3.123	35.11	0.20	0.00	9.89	0.07	45.27	56.00	-10.73	QP
10	4.647	18.07	0.20	0.00	9.89	0.09	28.25	46.00	-17.75	Average
11	5.305	34.31	0.20	0.00	9.89	0.09	44.49	60.00	-15.51	QP
12	6.319	17.07	0.20	0.00	9.90	0.09	27.26	50.00	-22.74	Average

Remark:

1. Level = Read level + LISN Factor + Cable Loss.

Product name:	Mobile Phone	Product model:	X6838
Test by:	Asher Zhang	Test mode:	BT Tx mode
Test frequency:	150 kHz ~ 30 MHz	Phase:	Neutral
Test voltage:	AC 120 V/60 Hz		

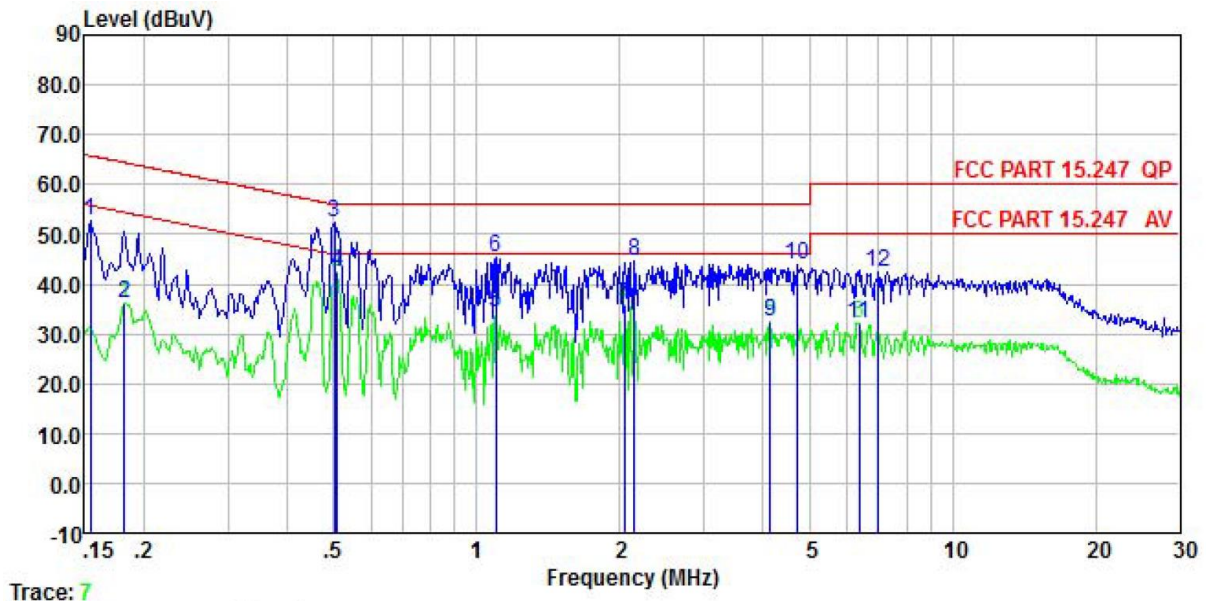

	Read Freq	Read Level	LISN Factor	Aux Factor	Aux2 Factor	Cable Loss	Level	Limit Line	Over Limit	Remark
	MHz	dBuV	dB	dB	dB	dB	dBuV	dBuV	dB	
1	0.154	42.62	0.20	0.00	9.88	0.01	52.71	65.78	-13.07	QP
2	0.182	26.09	0.20	0.00	9.88	0.01	36.18	54.42	-18.24	Average
3	0.502	42.16	0.20	0.00	9.88	0.03	52.27	56.00	-3.73	QP
4	0.510	32.24	0.20	0.00	9.88	0.03	42.35	46.00	-3.65	Average
5	1.100	23.98	0.21	0.00	9.88	0.07	34.14	46.00	-11.86	Average
6	1.100	35.03	0.21	0.00	9.88	0.07	45.19	56.00	-10.81	QP
7	2.044	25.23	0.30	0.00	9.88	0.20	35.61	46.00	-10.39	Average
8	2.144	34.21	0.30	0.00	9.88	0.18	44.57	56.00	-11.43	QP
9	4.136	22.24	0.30	0.00	9.89	0.08	32.51	46.00	-13.49	Average
10	4.696	33.63	0.30	0.00	9.89	0.09	43.91	56.00	-12.09	QP
11	6.352	21.76	0.30	0.00	9.90	0.09	32.05	50.00	-17.95	Average
12	6.988	32.12	0.30	0.00	9.90	0.10	42.42	60.00	-17.58	QP

Remark:

1. Level = Read level + LISN Factor + Cable Loss.

5.4 Emissions in Restricted Frequency Bands

Product Name:	Mobile Phone	Product Model:	X6838
Test By:	Kiran Zeng	Test mode:	DH1 Tx mode
Test Channel:	Lowest channel	Polarization:	Vertical
Test Voltage:	DC 3.85V		

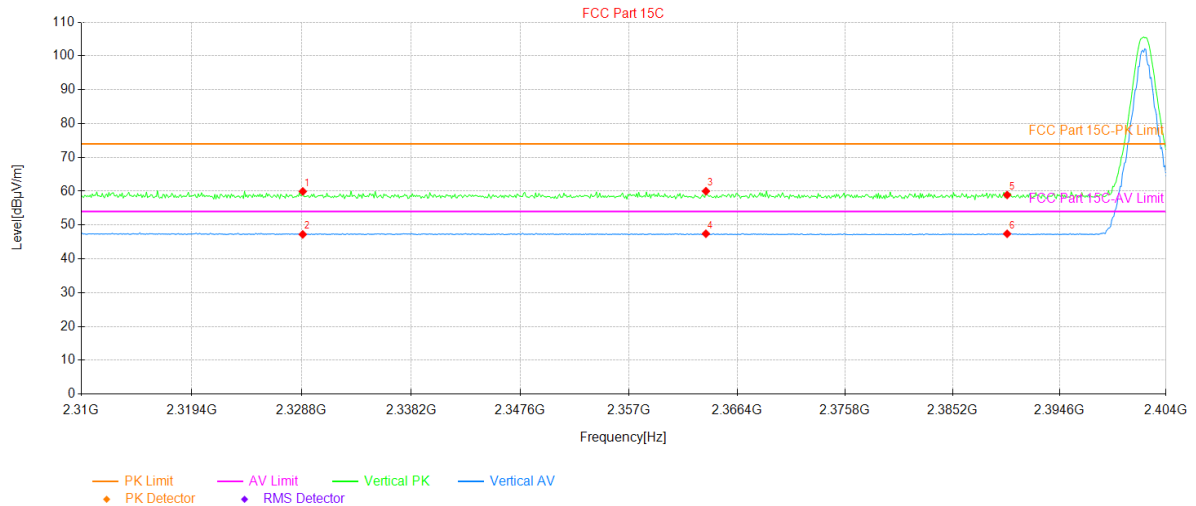

Suspected Data List										
NO.	Freq. [MHz]	Reading [dBµV]	Factor [dB/m]	Level [dBµV/m]	Limit [dBµV/m]	Margin [dB]	Angle [°]	Detector	Verdict	Polarity
1	2328.89	23.80	36.13	59.93	74.00	14.07	269	PK	PASS	Vertical
2	2328.89	11.10	36.13	47.23	54.00	6.77	6	AV	PASS	Vertical
3	2363.67	23.67	36.34	60.01	74.00	13.99	175	PK	PASS	Vertical
4	2363.67	11.09	36.34	47.43	54.00	6.57	213	AV	PASS	Vertical
5	2390.00	22.42	36.47	58.89	74.00	15.11	337	PK	PASS	Vertical
6	2390.00	10.95	36.47	47.42	54.00	6.58	104	AV	PASS	Vertical

Remark:

1. Level = Reading + Factor(Antenna Factor + Cable Loss – Preamplifier Factor).

Product Name:	Mobile Phone	Product Model:	X6838
Test By:	Kiran Zeng	Test mode:	DH1 Tx mode
Test Channel:	Lowest channel	Polarization:	Horizontal
Test Voltage:	DC 3.85V		

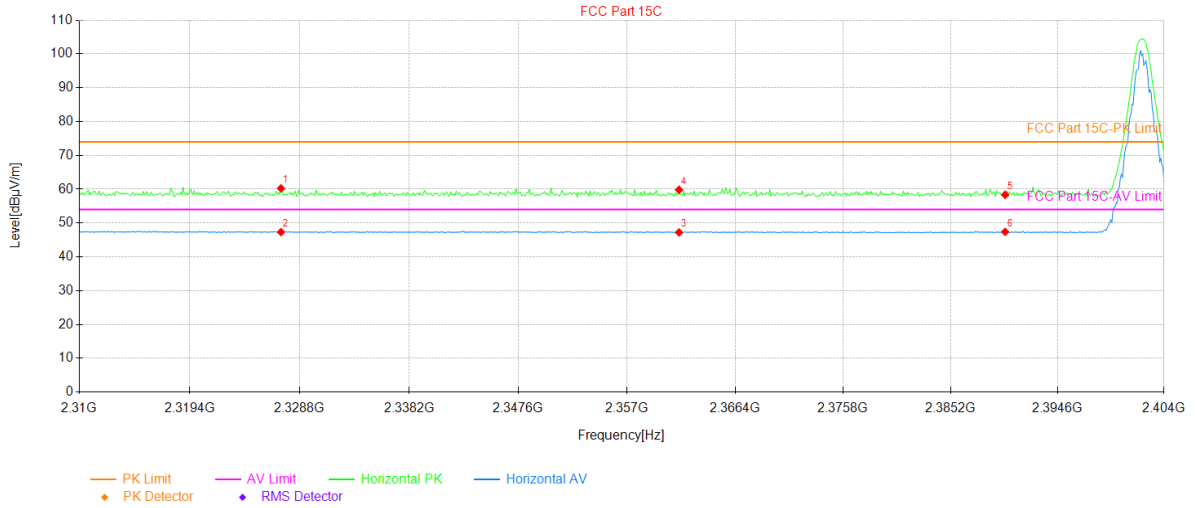

Suspected Data List										
NO.	Freq. [MHz]	Reading [dBµV]	Factor [dB/m]	Level [dBµV/m]	Limit [dBµV/m]	Margin [dB]	Angle [°]	Detector	Verdict	Polarity
1	2327.20	24.14	36.12	60.26	74.00	13.74	354	PK	PASS	Horizontal
2	2327.20	11.21	36.12	47.33	54.00	6.67	2	AV	PASS	Horizontal
3	2361.51	10.90	36.32	47.22	54.00	6.78	256	AV	PASS	Horizontal
4	2361.51	23.51	36.32	59.83	74.00	14.17	203	PK	PASS	Horizontal
5	2390.00	21.88	36.47	58.35	74.00	15.65	120	PK	PASS	Horizontal
6	2390.00	10.93	36.47	47.40	54.00	6.60	105	AV	PASS	Horizontal

Remark:

1. Level = Reading + Factor(Antenna Factor + Cable Loss – Preamplifier Factor).

Product Name:	Mobile Phone	Product Model:	X6838
Test By:	Kiran Zeng	Test mode:	DH1 Tx mode
Test Channel:	Highest channel	Polarization:	Vertical
Test Voltage:	DC 3.85V		

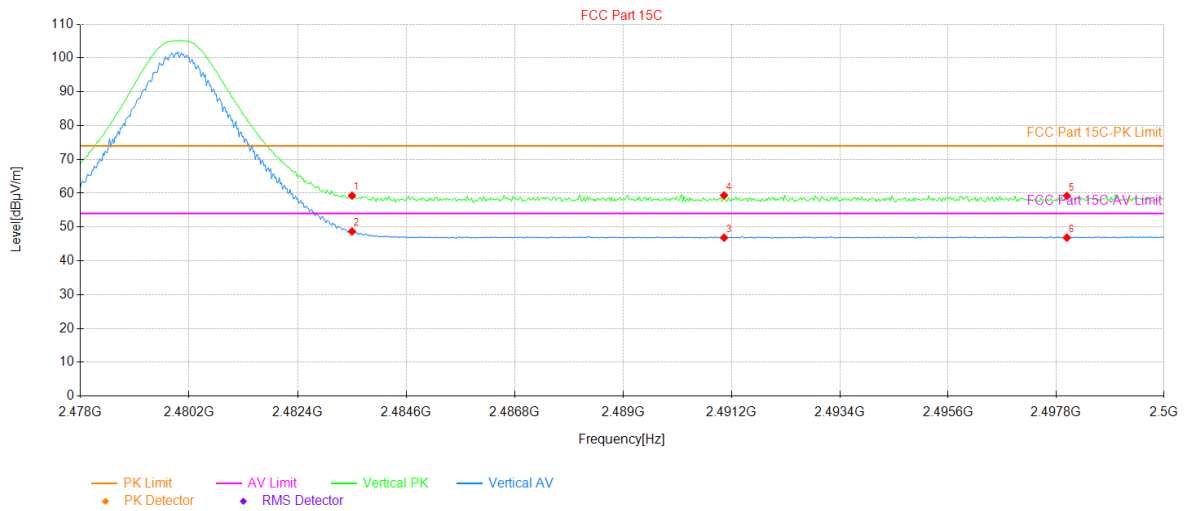

Suspected Data List										
NO.	Freq. [MHz]	Reading [dBµV]	Factor [dB/m]	Level [dBµV/m]	Limit [dBµV/m]	Margin [dB]	Angle [°]	Detector	Verdict	Polarity
1	2483.50	23.18	36.11	59.29	74.00	14.71	200	PK	PASS	Vertical
2	2483.50	12.57	36.11	48.68	54.00	5.32	83	AV	PASS	Vertical
3	2491.05	10.70	36.14	46.84	54.00	7.16	237	AV	PASS	Vertical
4	2491.05	23.22	36.14	59.36	74.00	14.64	287	PK	PASS	Vertical
5	2498.02	23.03	36.17	59.20	74.00	14.80	241	PK	PASS	Vertical
6	2498.02	10.69	36.17	46.86	54.00	7.14	110	AV	PASS	Vertical

Remark:

1. Level = Reading + Factor(Antenna Factor + Cable Loss – Preamplifier Factor).

Product Name:	Mobile Phone	Product Model:	X6838
Test By:	Kiran Zeng	Test mode:	DH1 Tx mode
Test Channel:	Highest channel	Polarization:	Horizontal
Test Voltage:	DC 3.85V		

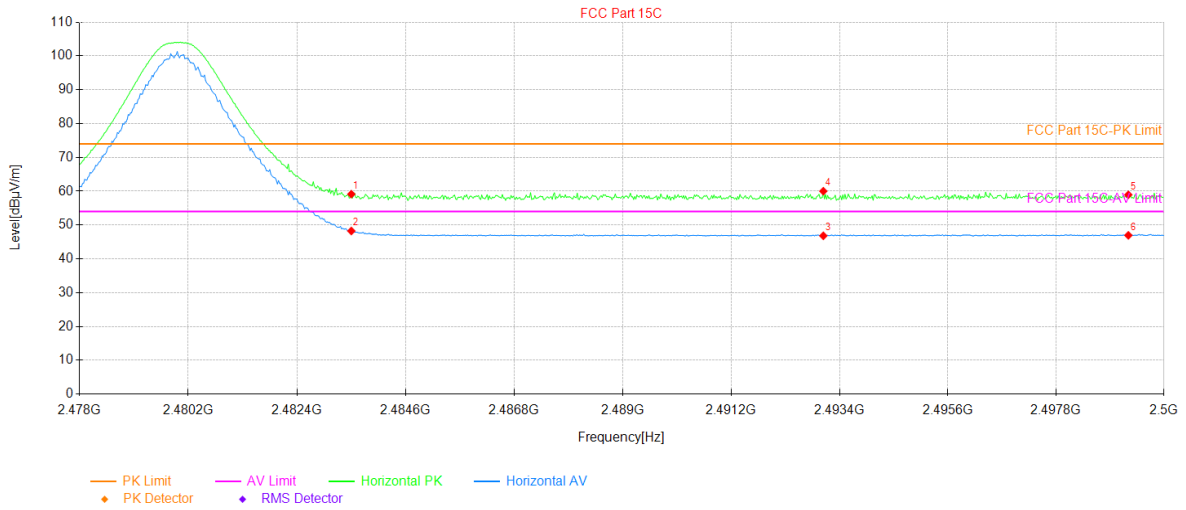

Suspected Data List										
NO.	Freq. [MHz]	Reading [dBµV]	Factor [dB/m]	Level [dBµV/m]	Limit [dBµV/m]	Margin [dB]	Angle [°]	Detector	Verdict	Polarity
1	2483.50	23.03	36.11	59.14	74.00	14.86	187	PK	PASS	Horizontal
2	2483.50	12.13	36.11	48.24	54.00	5.76	22	AV	PASS	Horizontal
3	2493.07	10.66	36.15	46.81	54.00	7.19	199	AV	PASS	Horizontal
4	2493.07	23.86	36.15	60.01	74.00	13.99	8	PK	PASS	Horizontal
5	2499.27	22.77	36.18	58.95	74.00	15.05	251	PK	PASS	Horizontal
6	2499.27	10.77	36.18	46.95	54.00	7.05	218	AV	PASS	Horizontal

Remark:

1. Level = Reading + Factor(Antenna Factor + Cable Loss – Preamplifier Factor).

π/4-DQPSK mode

Product Name:	Mobile Phone	Product Model:	X6838
Test By:	Kiran Zeng	Test mode:	2DH1 Tx mode
Test Channel:	Lowest channel	Polarization:	Vertical
Test Voltage:	DC 3.85V		

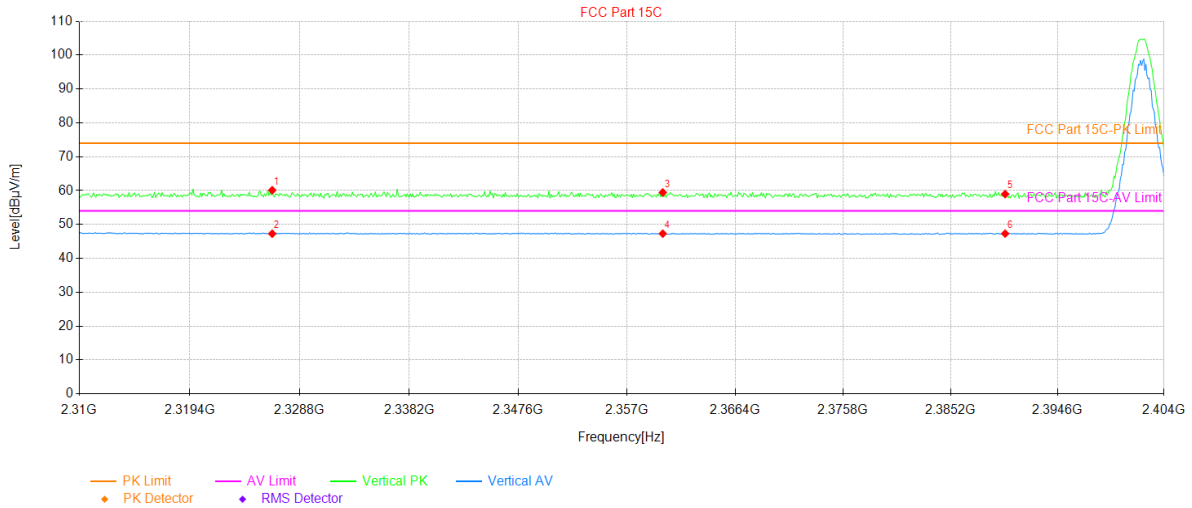

Suspected Data List											
NO.	Freq. [MHz]	Reading [dBμV]	Factor [dB/m]	Level [dBμV/m]	Limit [dBμV/m]	Margin [dB]	Angle [°]	Detector	Verdict	Polarity	
1	2326.45	23.99	36.12	60.11	74.00	13.89	69	PK	PASS	Vertical	
2	2326.45	11.16	36.12	47.28	54.00	6.72	246	AV	PASS	Vertical	
3	2360.10	23.13	36.32	59.45	74.00	14.55	133	PK	PASS	Vertical	
4	2360.10	10.97	36.32	47.29	54.00	6.71	50	AV	PASS	Vertical	
5	2390.00	22.50	36.47	58.97	74.00	15.03	1	PK	PASS	Vertical	
6	2390.00	10.84	36.47	47.31	54.00	6.69	273	AV	PASS	Vertical	

Remark:

1. Level = Reading + Factor(Antenna Factor + Cable Loss – Preamplifier Factor).

Product Name:	Mobile Phone	Product Model:	X6838
Test By:	Kiran Zeng	Test mode:	2DH1 Tx mode
Test Channel:	Lowest channel	Polarization:	Horizontal
Test Voltage:	DC 3.85V		

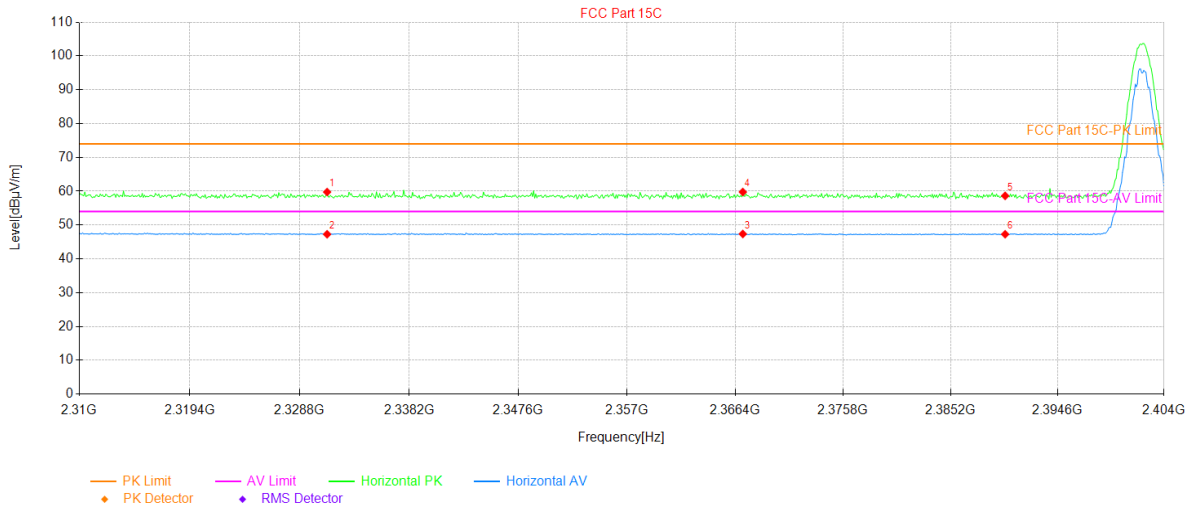

Suspected Data List										
NO.	Freq. [MHz]	Reading [dBµV]	Factor [dB/m]	Level [dBµV/m]	Limit [dBµV/m]	Margin [dB]	Angle [°]	Detector	Verdict	Polarity
1	2331.15	23.63	36.13	59.76	74.00	14.24	190	PK	PASS	Horizontal
2	2331.15	11.14	36.13	47.27	54.00	6.73	266	AV	PASS	Horizontal
3	2367.06	11.01	36.35	47.36	54.00	6.64	314	AV	PASS	Horizontal
4	2367.06	23.42	36.35	59.77	74.00	14.23	4	PK	PASS	Horizontal
5	2390.00	22.16	36.47	58.63	74.00	15.37	142	PK	PASS	Horizontal
6	2390.00	10.80	36.47	47.27	54.00	6.73	101	AV	PASS	Horizontal

Remark:

1. Level = Reading + Factor(Antenna Factor + Cable Loss – Preamplifier Factor).

Product Name:	Mobile Phone	Product Model:	X6838
Test By:	Kiran Zeng	Test mode:	2DH1 Tx mode
Test Channel:	Highest channel	Polarization:	Vertical
Test Voltage:	DC 3.85V		

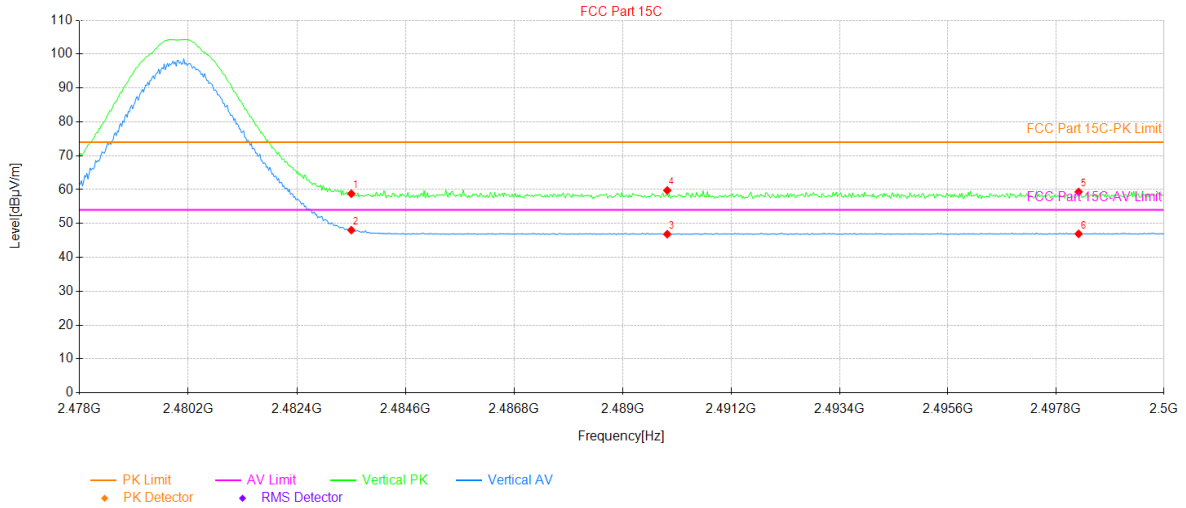

Suspected Data List										
NO.	Freq. [MHz]	Reading [dBµV]	Factor [dB/m]	Level [dBµV/m]	Limit [dBµV/m]	Margin [dB]	Angle [°]	Detector	Verdict	Polarity
1	2483.50	22.68	36.11	58.79	74.00	15.21	190	PK	PASS	Vertical
2	2483.50	11.94	36.11	48.05	54.00	5.95	91	AV	PASS	Vertical
3	2489.90	10.70	36.14	46.84	54.00	7.16	280	AV	PASS	Vertical
4	2489.90	23.61	36.14	59.75	74.00	14.25	239	PK	PASS	Vertical
5	2498.26	23.16	36.17	59.33	74.00	14.67	337	PK	PASS	Vertical
6	2498.26	10.77	36.17	46.94	54.00	7.06	140	AV	PASS	Vertical

Remark:

1. Level = Reading + Factor(Antenna Factor + Cable Loss – Preamplifier Factor).

Product Name:	Mobile Phone	Product Model:	X6838
Test By:	Kiran Zeng	Test mode:	2DH1 Tx mode
Test Channel:	Highest channel	Polarization:	Horizontal
Test Voltage:	DC 3.85V		

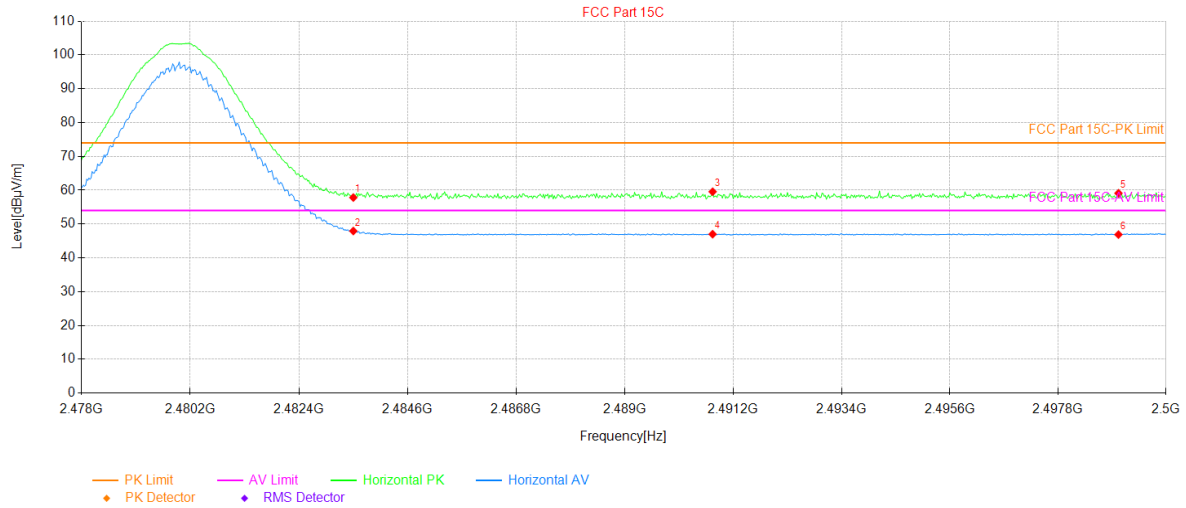

Suspected Data List										
NO.	Freq. [MHz]	Reading [dBµV]	Factor [dB/m]	Level [dBµV/m]	Limit [dBµV/m]	Margin [dB]	Angle [°]	Detector	Verdict	Polarity
1	2483.50	21.73	36.11	57.84	74.00	16.16	113	PK	PASS	Horizontal
2	2483.50	11.82	36.11	47.93	54.00	6.07	155	AV	PASS	Horizontal
3	2490.78	23.42	36.14	59.56	74.00	14.44	56	PK	PASS	Horizontal
4	2490.78	10.86	36.14	47.00	54.00	7.00	178	AV	PASS	Horizontal
5	2499.03	22.93	36.17	59.10	74.00	14.90	64	PK	PASS	Horizontal
6	2499.03	10.72	36.17	46.89	54.00	7.11	249	AV	PASS	Horizontal

Remark:

1. Level = Reading + Factor(Antenna Factor + Cable Loss – Preamplifier Factor).

8DPSK mode

Product Name:	Mobile Phone	Product Model:	X6838
Test By:	Kiran Zeng	Test mode:	3DH1 Tx mode
Test Channel:	Lowest channel	Polarization:	Vertical
Test Voltage:	DC 3.85V		

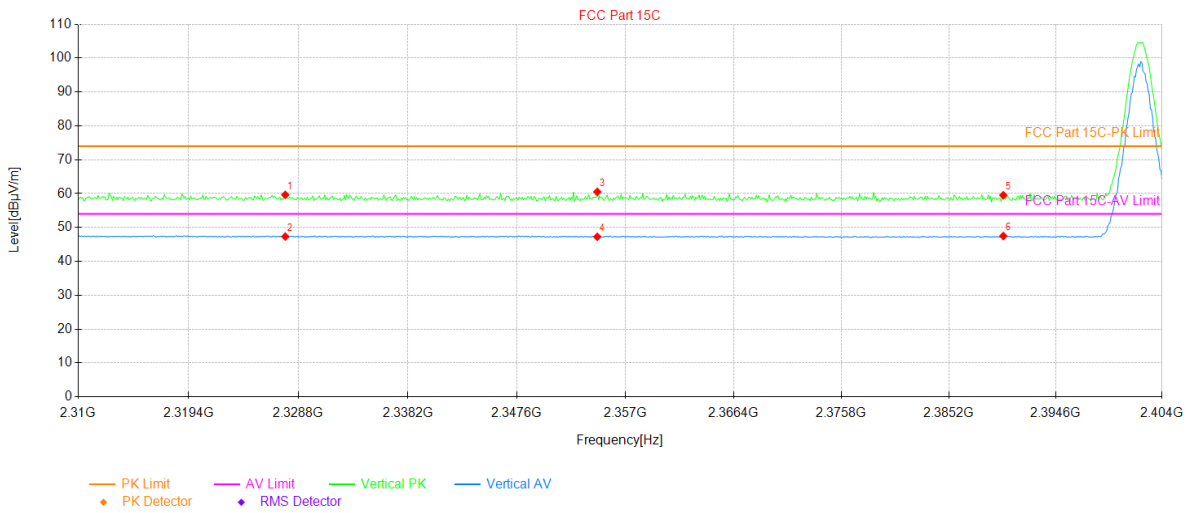

Suspected Data List										
NO.	Freq. [MHz]	Reading [dBµV]	Factor [dB/m]	Level [dBµV/m]	Limit [dBµV/m]	Margin [dB]	Angle [°]	Detector	Verdict	Polarity
1	2327.67	23.53	36.12	59.65	74.00	14.35	277	PK	PASS	Vertical
2	2327.67	11.20	36.12	47.32	54.00	6.68	51	AV	PASS	Vertical
3	2354.56	24.23	36.29	60.52	74.00	13.48	114	PK	PASS	Vertical
4	2354.56	10.96	36.29	47.25	54.00	6.75	288	AV	PASS	Vertical
5	2390.00	23.05	36.47	59.52	74.00	14.48	20	PK	PASS	Vertical
6	2390.00	11.01	36.47	47.48	54.00	6.52	356	AV	PASS	Vertical

Remark:

1. Level = Reading + Factor(Antenna Factor + Cable Loss – Pre-amplifier Factor).

Product Name:	Mobile Phone	Product Model:	X6838
Test By:	Kiran Zeng	Test mode:	3DH1 Tx mode
Test Channel:	Lowest channel	Polarization:	Horizontal
Test Voltage:	DC 3.85V		

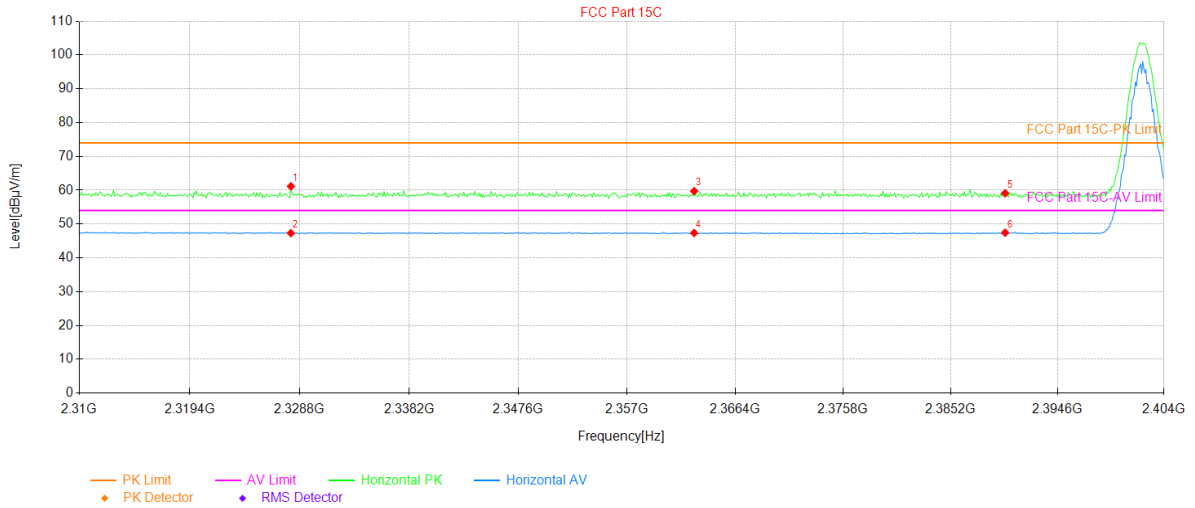

Suspected Data List										
NO.	Freq. [MHz]	Reading [dBµV]	Factor [dB/m]	Level [dBµV/m]	Limit [dBµV/m]	Margin [dB]	Angle [°]	Detector	Verdict	Polarity
1	2328.05	25.05	36.12	61.17	74.00	12.83	360	PK	PASS	Horizontal
2	2328.05	11.19	36.12	47.31	54.00	6.69	360	AV	PASS	Horizontal
3	2362.83	23.39	36.34	59.73	74.00	14.27	109	PK	PASS	Horizontal
4	2362.83	11.01	36.34	47.35	54.00	6.65	242	AV	PASS	Horizontal
5	2390.00	22.62	36.47	59.09	74.00	14.91	90	PK	PASS	Horizontal
6	2390.00	10.97	36.47	47.44	54.00	6.56	2	AV	PASS	Horizontal

Remark:

1. Level = Reading + Factor(Antenna Factor + Cable Loss – Preamplifier Factor).

Product Name:	Mobile Phone	Product Model:	X6838
Test By:	Kiran Zeng	Test mode:	3DH1 Tx mode
Test Channel:	Highest channel	Polarization:	Vertical
Test Voltage:	DC 3.85V		

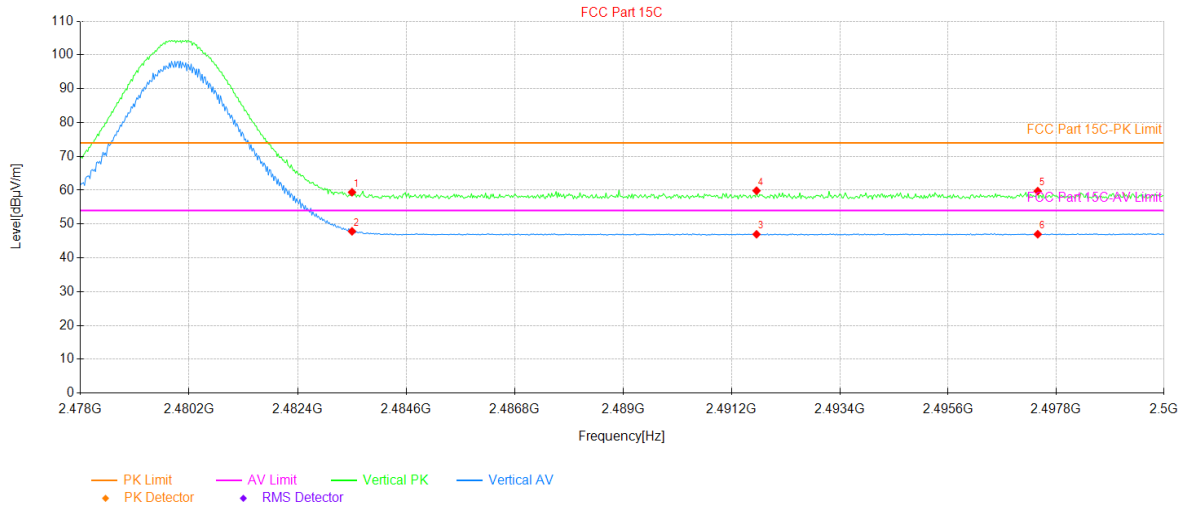

Suspected Data List										
NO.	Freq. [MHz]	Reading [dBµV]	Factor [dB/m]	Level [dBµV/m]	Limit [dBµV/m]	Margin [dB]	Angle [°]	Detector	Verdict	Polarity
1	2483.50	23.28	36.11	59.39	74.00	14.61	57	PK	PASS	Vertical
2	2483.50	11.74	36.11	47.85	54.00	6.15	94	AV	PASS	Vertical
3	2491.71	10.83	36.14	46.97	54.00	7.03	0	AV	PASS	Vertical
4	2491.71	23.71	36.14	59.85	74.00	14.15	303	PK	PASS	Vertical
5	2497.43	23.56	36.17	59.73	74.00	14.27	2	PK	PASS	Vertical
6	2497.43	10.82	36.17	46.99	54.00	7.01	30	AV	PASS	Vertical

Remark:

1. Level = Reading + Factor(Antenna Factor + Cable Loss – Preamplifier Factor).

Product Name:	Mobile Phone	Product Model:	X6838
Test By:	Kiran Zeng	Test mode:	3DH1 Tx mode
Test Channel:	Highest channel	Polarization:	Horizontal
Test Voltage:	DC 3.85V		

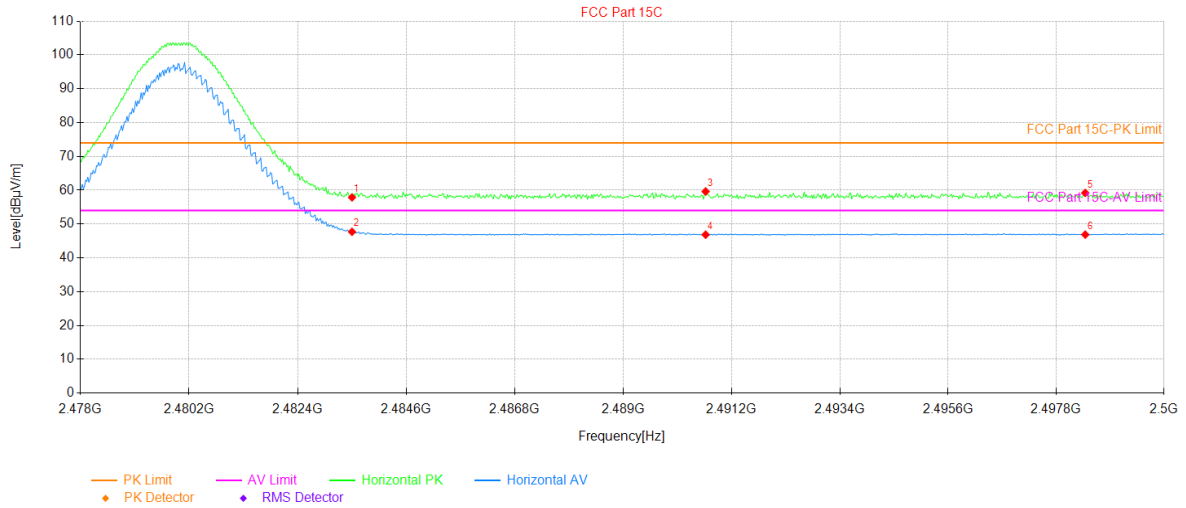

Suspected Data List										
NO.	Freq. [MHz]	Reading [dBµV]	Factor [dB/m]	Level [dBµV/m]	Limit [dBµV/m]	Margin [dB]	Angle [°]	Detector	Verdict	Polarity
1	2483.50	21.77	36.11	57.88	74.00	16.12	311	PK	PASS	Horizontal
2	2483.50	11.59	36.11	47.70	54.00	6.30	143	AV	PASS	Horizontal
3	2490.67	23.49	36.14	59.63	74.00	14.37	38	PK	PASS	Horizontal
4	2490.67	10.71	36.14	46.85	54.00	7.15	54	AV	PASS	Horizontal
5	2498.39	23.03	36.17	59.20	74.00	14.80	296	PK	PASS	Horizontal
6	2498.39	10.70	36.17	46.87	54.00	7.13	334	AV	PASS	Horizontal

Remark:

1. Level = Reading + Factor(Antenna Factor + Cable Loss – Preamplifier Factor).

5.5 Emissions in Non-restricted Frequency Bands

Below 1GHz:

Product Name:	Mobile Phone	Product Model:	X6838
Test By:	Kiran Zeng	Test mode:	BT Tx mode
Test Frequency:	30 MHz ~ 1 GHz	Polarization:	Vertical
Test Voltage:	DC 3.85V		

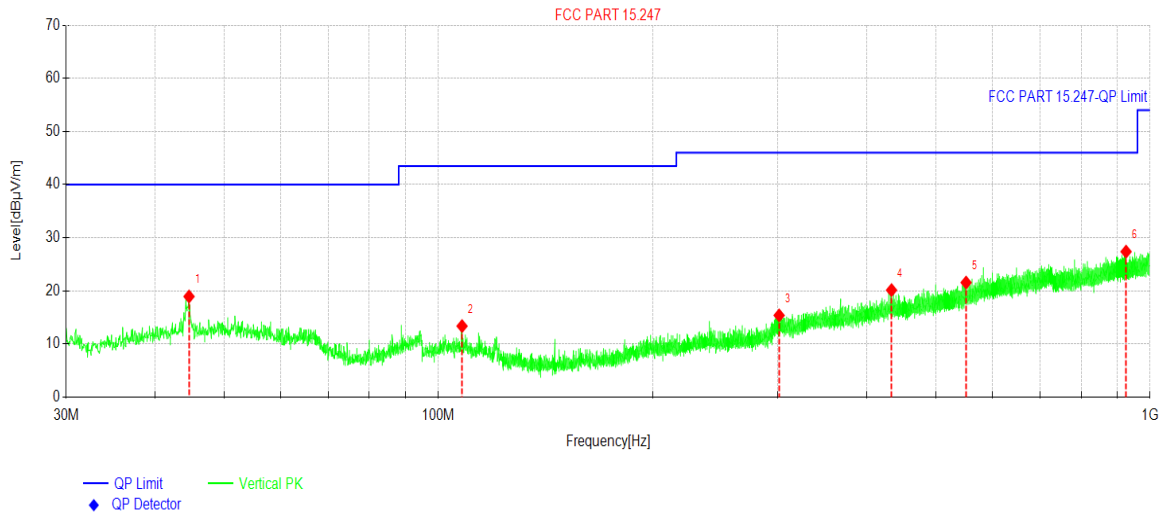

Suspected Data List								
NO.	Freq. [MHz]	Reading [dBµV/m]	Factor [dB]	Level [dBµV/m]	Limit [dBµV/m]	Margin [dB]	Trace	Polarity
1	44.6477	31.78	-12.84	18.94	40.00	21.06	PK	Vertical
2	107.9919	27.99	-14.62	13.37	43.50	30.13	PK	Vertical
3	301.2256	28.38	-13.00	15.38	46.00	30.62	PK	Vertical
4	433.2977	30.24	-10.10	20.14	46.00	25.86	PK	Vertical
5	551.5466	29.63	-8.07	21.56	46.00	24.44	PK	Vertical
6	925.2578	29.80	-2.42	27.38	46.00	18.62	PK	Vertical

Remark:

1. Level = Reading + Factor(Antenna Factor + Cable Loss – Pre-amplifier Factor).

Product Name:	Mobile Phone	Product Model:	X6838
Test By:	Kiran Zeng	Test mode:	BT Tx mode
Test Frequency:	30 MHz ~ 1 GHz	Polarization:	Horizontal
Test Voltage:	DC 3.85V		

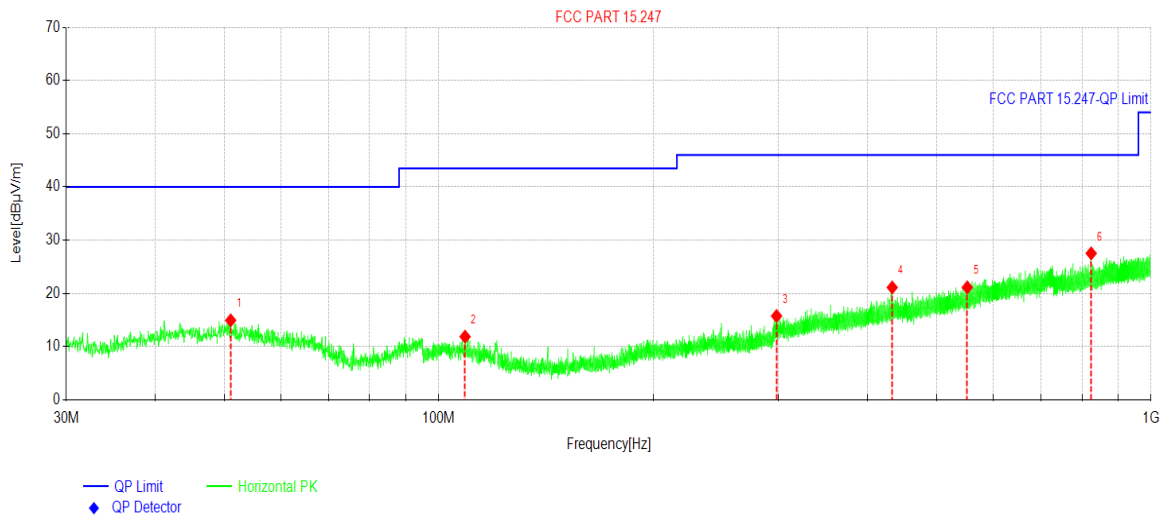

Suspected Data List								
NO.	Freq. [MHz]	Reading [dBµV/m]	Factor [dB]	Level [dBµV/m]	Limit [dBµV/m]	Margin [dB]	Trace	Polarity
1	51.0501	27.66	-12.72	14.94	40.00	25.06	PK	Horizontal
2	108.9134	26.58	-14.71	11.87	43.50	31.63	PK	Horizontal
3	298.0729	28.79	-13.04	15.75	46.00	30.25	PK	Horizontal
4	433.2492	31.22	-10.10	21.12	46.00	24.88	PK	Horizontal
5	552.2741	29.20	-8.06	21.14	46.00	24.86	PK	Horizontal
6	824.2757	31.19	-3.67	27.52	46.00	18.48	PK	Horizontal

Remark:

1. Level = Reading + Factor(Antenna Factor + Cable Loss – Preamplifier Factor).

Above 1GHz:

Test channel: Lowest channel						
Detector: Peak Value						
Frequency (MHz)	Read Level (dBuV)	Factor(dB)	Level (dBuV/m)	Limit (dBuV/m)	Margin (dB)	Polarization
4804.00	51.01	-8.00	43.01	74.00	30.99	Vertical
4804.00	55.19	-8.00	47.19	74.00	26.81	Horizontal
Detector: Average Value						
Frequency (MHz)	Read Level (dBuV)	Factor(dB)	Level (dBuV/m)	Limit (dBuV/m)	Margin (dB)	Polarization
4804.00	43.99	-8.00	35.99	54.00	18.01	Vertical
4804.00	49.67	-8.00	41.67	54.00	12.33	Horizontal
Test channel: Middle channel						
Detector: Peak Value						
Frequency (MHz)	Read Level (dBuV)	Factor(dB)	Level (dBuV/m)	Limit (dBuV/m)	Margin (dB)	Polarization
4882.00	51.46	-7.47	43.99	74.00	30.01	Vertical
4882.00	55.55	-7.47	48.08	74.00	25.92	Horizontal
Detector: Average Value						
Frequency (MHz)	Read Level (dBuV)	Factor(dB)	Level (dBuV/m)	Limit (dBuV/m)	Margin (dB)	Polarization
4882.00	43.74	-7.47	36.27	54.00	17.73	Vertical
4882.00	50.08	-7.47	42.61	54.00	11.39	Horizontal
Test channel: Highest channel						
Detector: Peak Value						
Frequency (MHz)	Read Level (dBuV)	Factor(dB)	Level (dBuV/m)	Limit (dBuV/m)	Margin (dB)	Polarization
4960.00	51.14	-7.08	44.06	74.00	29.94	Vertical
4960.00	55.05	-7.08	47.97	74.00	26.03	Horizontal
Detector: Average Value						
Frequency (MHz)	Read Level (dBuV)	Factor(dB)	Level (dBuV/m)	Limit (dBuV/m)	Margin (dB)	Polarization
4960.00	44.12	-7.08	37.04	54.00	16.96	Vertical
4960.00	49.79	-7.08	42.71	54.00	11.29	Horizontal
Remark:						
1. Level = Reading + Factor.						
2. Test Frequency up to 25GHz, and the emission levels of other frequencies are lower than the limit 20dB, not show in test report.						

-----End of report-----