

Operators Manual

SmartSystem SITE L Datalogger



Berlinger & Co. AG

Mitteldorfstrasse 2
9608 Ganterschwil
Switzerland

Tel. +41 71 982 88 11
info@berlinger.com
www.berlinger.com

Table of Contents

1	Safety instructions	4
2	Quick Guide	5
2.1	Quick Start if configuration is already loaded on the device.....	5
2.2	Quick Start if configuration needs first loaded to the device.....	6
3	Device view and description	7
4	Display.....	8
4.1	7-digit display.....	9
5	Multifunctional button	9
6	Confirmation LED.....	10
7	Light sensor.....	10
8	Humidity and pressure sensor.....	11
9	Tilt / Shock / Vibration.....	11
10	Configuration	12
11	Start/Stop	13
11.1	Start	13
11.2	Stop.....	14
12	Start delay.....	14
12.1	Start SmartMonitor SITE L with start delay	14
12.2	Start SmartMonitor SITE L with scheduled start	15
13	Usage Process	16
13.1	Preparation	16
13.1.1	Display check	16
13.1.2	Housing check.....	16
13.2	Setup.....	16
13.2.1	WIFI reset.....	17
13.2.2	Download Configuration.....	17
13.2.3	Review/Check configuration.....	17
13.3	Start	17
13.3.1	Start delay.....	17
13.3.2	Scheduler Start.....	17
13.4	Recording.....	17
13.4.1	Assess state of goods and information.....	18
13.5	Stop.....	18
13.5.1	Read out.....	18

13.5.2	Upload data manually of read out data to Berlinger SmartView software (version 6.0 and higher).....	18
13.5.3	Return device.....	18
14	Where to place SmartMonitor SITE L	19
15	External Sensor	20
15.1	Connect an external sensor to SmartMonitor SITE L device	21
15.2	Multi Sensor Adapter.....	22
16	Troubleshooting.....	23
17	Disposal.....	25
18	Certification	25
18.1	Specific Information for North America (FCC/ISED)	25
19	Standards	26

1 Safety instructions

Intended use

Temperature

- Temperatures outside the operating range may damage the battery. For the operating range, see the information in the technical data sheet.

IP Protection

- Limited protection against dust ingress and protection against splashing water from all directions.

Air Pressure

- Excess pressure or vacuum can damage the device. Do not vacuum when used for air cargo.

Mechanical force

- Avoid violent shocks and impacts.

Microwave

- Do not expose the device to microwave radiation (risk of battery explosion).

X-rays

- Avoid long-term exposure to X-rays (risk of damage to the device).

Battery

- The battery cannot be removed or replaced. SmartMonitor SITE L device has a rechargeable Non–lithium NiMH battery.
- Risk of fire or explosion if the battery is replaced by an incorrect type
- Risk of explosion if the battery is disposed of in a fire or hot oven
- Leaving the battery in an extremely high temperature surrounding environment can result in an explosion or leakage
- Do not subject battery to extremely low air pressure that may result in an explosion or the leakage of flammable liquid or gas

Safe use

- Ordinary persons can install and operate the unit without taking any other safety precautions.

Radio Equipment



- Cellular (LTE M1, NB–IoT, 2G), BLE

2 Quick Guide

2.1 Quick Start if configuration is already loaded on the device



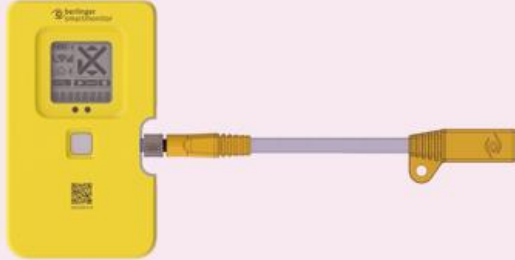

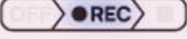

Quick Start SITE L (if configuration is already on the device)

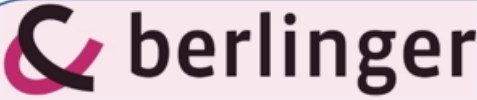
<p style="text-align: center;">1 . Place External Sensor</p> <p>Install the external temperature sensor in the designated place and wait 20 minutes for it to acclimatize.</p> 	<p style="text-align: center;">2 . Connect External Sensor</p> <p>Connect the external sensor to the SmartMonitor SITE L device according to manual chapter 15.1 Connect an external sensor to SmartMonitor SITE L.</p> 
<p style="text-align: center;">3 . Start Device</p>  <p style="color: red; margin-left: 150px;">Long press > 5 seconds</p> <p>Press long (>5 second) till  is shown on the display. → Device starts recording</p>	<p style="text-align: center;">Troubleshooting</p> <p>If the SmartMonitor SITE L does not connect to the WIFI</p>  <p>Press the multifunctional button 5 times shortly to reset WIFI. Start device again, according step 3 Start Device</p>

2.2 Quick Start if configuration needs first loaded to the device

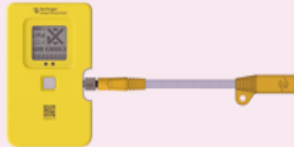

Quick Start SITE L (if configuration **needs first loaded** to the device)

<p style="text-align: center;">1 . Place External Sensor</p> <p>Install the external temperature sensor in the designated place and wait 20 minutes for it to acclimatize.</p> 	<p style="text-align: center;">2 . Connect External Sensor</p> <p>Connect the external sensor to the SmartMonitor SITE L device according to manual chapter 15.1 Connect an external sensor to SmartMonitor SITE L.</p> 
<p style="text-align: center;">3 . Start Device</p>  <p style="color: red; text-align: center;">Press quickly 3 times</p> <p>Press quickly 3 times to start the device → Device starts to download the configuration</p>	<p style="text-align: center;">4 . Download Configuration</p> <p>Device display shows following sequences on the display</p>  <p>Device is ready to use as soon as 7-segment display shows shipment name.</p>
<p style="text-align: center;">3 . Start Device</p>  <p style="color: red; text-align: center;">Long press > 5 seconds</p> <p>Press long (>5 second) till OFF REC is shown on the display. → Device starts recording</p>	<p style="text-align: center;">Troubleshooting</p> <p>If SmartMonitor SITE L does not connect to the WIFI.</p>  <p>Press the multifunctional button 5 times shortly to reset WIFI. Start device again, according step 3 Start Device.</p>

3 Device view and description

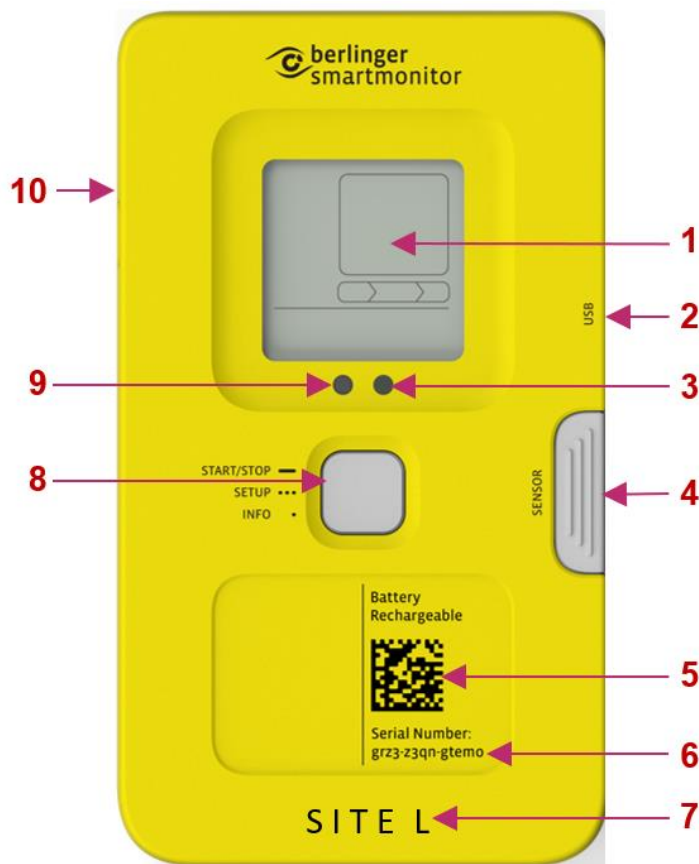

No.	Name	Description
1	Display	Multi-information display
2	USB-connector	To charge the battery or download the data manually
3	Confirmation/Status LED	LED (small lamp) indicates if use of multifunctional button was successful or not
4	Cover for ext. sensor	Protect plug for external sensor
5	QR Code	Contains the serial number for M2M (Machine to Machine)
6	Serial number	Serial number of the device
7	Device Type	Indicates which type of device you have
8	Multifunctional button	1 x long press → Start the device 1 x short press → Info 3 x short press → loading profile
9	Light sensor	Measure the light sensitivity
10	Humidity and atmospheric pressure sensor	Measure humidity and atmospheric pressure

4 Display

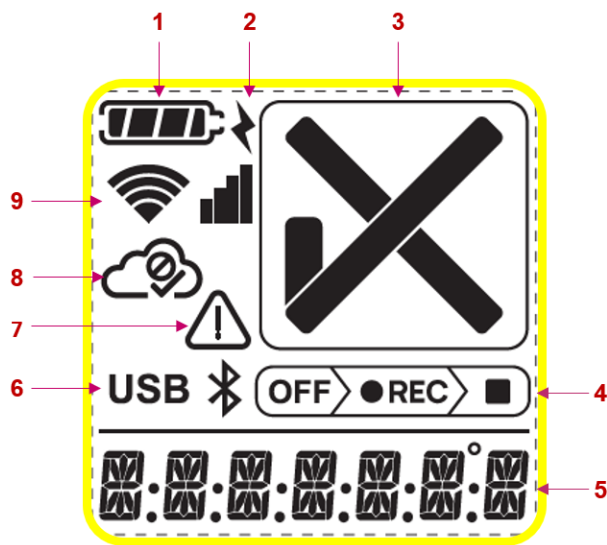

Icon	Name	Description
1	Battery status	Indicates the battery status
2	Battery charging	Indicates whether external power has been plugged in
3	Alarm status	<ul style="list-style-type: none"> ✓ Device indicates that there is no alarm violation ✗ Device indicates that there is one or more alarm violation
4	Logging Modus	<ul style="list-style-type: none"> OFF → SmartMonitor SITE L is ready to start ● REC → SmartMonitor SITE L is logging ■ → SmartMonitor SITE L has stopped
5	7-digit display	Information line (see more in section 7-digit display)
6	External readout	Device ready for readout via USB or Bluetooth
7	Warning Symbol	Additional warning for function
8	Cloud status	<ul style="list-style-type: none"> ☁ Upload successful ☁⊗ Upload not possible
9	Signal strength	<p>Cellular connection</p> <ul style="list-style-type: none"> 📶 Cellular signal available 📶 No cellular signal available <p>WLAN connectivity</p> <ul style="list-style-type: none"> 📶 WLAN signal available 📶 No WLAN signal available

4.1 7-digit display

The 7-digit display gives additional information about the status or other data.

In normal logging operation it displays the temperature.

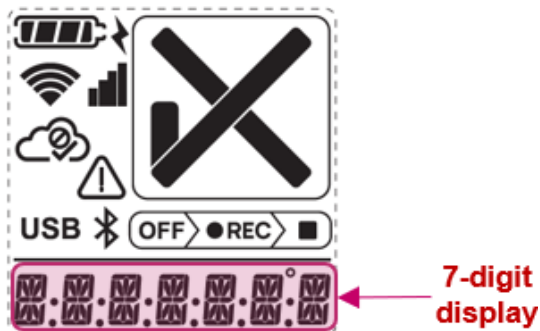

5 Multifunctional button

SmartMonitor SITE L device has one multifunctional button to operate.



- 1 x long press → Start / Stop the device
- 3 x short press → Setup – Load configuration
- 1 x short press → Information

- **Long press to multifunctional button**
One long press (> 5 sec.) to multifunctional button will start or stop the device.
- **3 short press to multifunctional button**
Three short press to the multifunctional button will start setup process
- **1 short press to multifunctional button**
One short press to the multifunctional button, device will show information on the display or skip to the next information.

6 Confirmation LED

Device has an LED which gives an indication if the use of multifunctional button was successful or if a task has been terminated.





 1 x short white flash → Confirmation of an action or task

 1 sec. **green** flash → “Cancel Message”
Short press has released too early.

 **Green** blinking → when longpress is going on

 1 x long **green** flash → Longpress was successful, multifunctional button can be released

 1 x long **blue** flash → Information about a BLE connection

 1 x long **red** flash → Information about cancelling a status

7 Light sensor

SmartMonitor SITE L device has a built-in light sensor to monitor to detect whether the environment is light or dark. That sensor can be enabled or disabled in the Berlinger SmartView software (version 6.0 and higher).

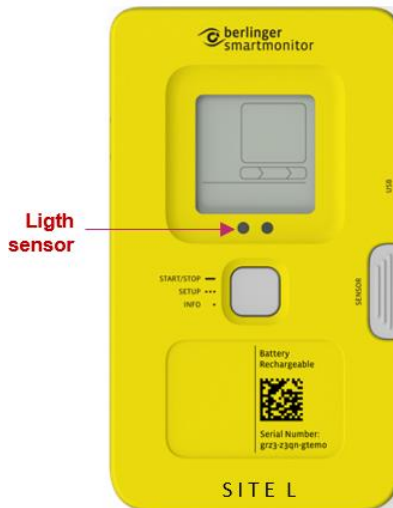

Important:

Do not stick any label or tape over the light sensor.

8 Humidity and pressure sensor

SmartMonitor SITE L has a built-in humidity and atmospheric pressure sensor which can be enabled or disabled in the Berlinger SmartView software (version 6.0 and higher) configuration. The sensor is located on the left side of the device.



Important:

Keep the white sensor protector clean

Do not remove the grey sensor protection

Do not press on the grey sensor protection

Do not stick any label or tape over the light sensor

The sensor shall not get in close contact with volatile chemicals such as solvents or other organic compounds. Especially high concentration and long exposure must be avoided. Ketenes, Acetone, Ethanol, Isopropyl Alcohol, Toluene, etc. are known to cause drift of the humidity reading.

9 Tilt / Shock / Vibration

SmartMonitor SITE L has a built-in motion sensor to record tilt, shock and vibration. The sensor is positioned inside the device and is not visible from the outside.

Tilt, shock and vibration can be enabled or disabled in the Berlinger SmartView software (version 6.0 and higher) configuration.

No maintenance or service is required for this built sensor.

10 Configuration

The configuration for the SmartMonitor SITE L device can be defined via the Berlinger SmartView software (version 6.0 and later).

SmartMonitor SITE L can be ordered pre-configured with a customer desired configuration or with a standard configuration.

If a new configuration is to be loaded, it is configured in the Berlinger SmartView software (version 6.0 and higher) and then assigned to the device.

To load a defined and assigned configuration, the multifunctional button on the SmartMonitor SITE L device must be pressed 3 times in quick succession.



The display starts showing after press quickly 3 times following screen

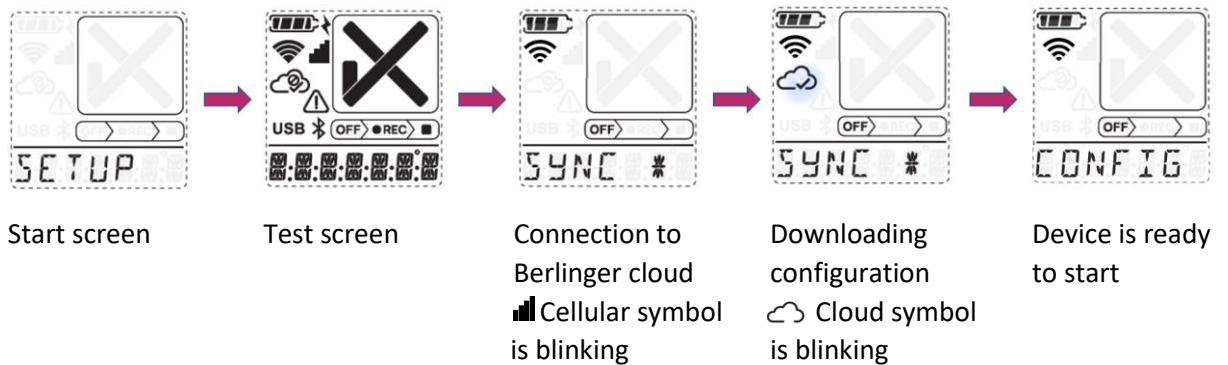

11 Start/Stop

11.1 Start

To start the device, press the multifunctional button once >5 seconds or as long till display shows “SETUP” or the green LED lights for at least 2 sec.



The following information will be displayed on the screen. While the information “***START***” will be displayed **as a ticker**, keep pressed the multifunctional button and hold the multifunctional button for at least 5 seconds.



As confirmation the green LED will flash for at least 2 sec.



If no start delay is configured, the device goes directly into the Record modus and shows ●REC on the display as confirmation that the device is recording.

The large indicator on the screen ✓ or ✗ shows directly if the device is in good or alarm situation. The 7-segment displays the “CURRENT” temperature.

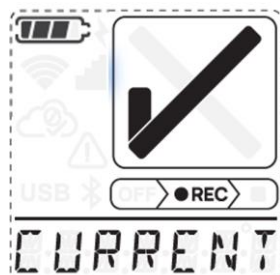

11.2 Stop

SmartMonitor SITE L device can only be stopped via Berlinger SmartView software (version 6.0 and later).

As soon as the stop command has been entered via SmartView, the device will be stopped during the next synchronization between SmartView and SITE L and the information DONE will be displayed on the 7-segment display on the device.



12 Start delay

For SmartMonitor SITE L device you have the possibility to configure in Berlinger SmartView software (version 6.0 and higher) with a start delay or with a scheduled start.

12.1 Start SmartMonitor SITE L with start delay

If a start delay is configured a counter in minutes:seconds will start counting down to 00:00, after that, the device starts and goes to the Record modus.

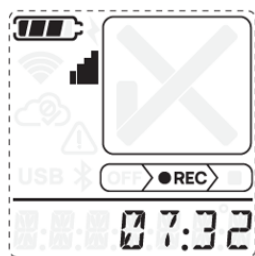

12.2 Start SmartMonitor SITE L with scheduled start

If a scheduled start is configured a counter in days:hours:minutes (e.g., 01d14:32 = start in 1 day 14 hours and 32 sec) will be displayed on the 7-segment display.



By a short press to the multifunctional button, the information *SCHEDULED START* will show as ticker on the display with above information about the time till the device will start recording.

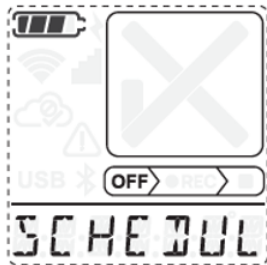

13 Usage Process

SmartMonitor SITE L is mainly used for monitoring the storage of temperature-sensitive products. The device has various configuration options. The device states are visualized below and described in more detail in the following chapters. The usage process may vary depending on the configuration.

13.1 Preparation

13.1.1 Display check

To check the display, press once short the multifunctional button, the display will show the status of the device.

13.1.2 Housing check

Check if the housing is not damaged and no label is attached over the light and humidity sensor.

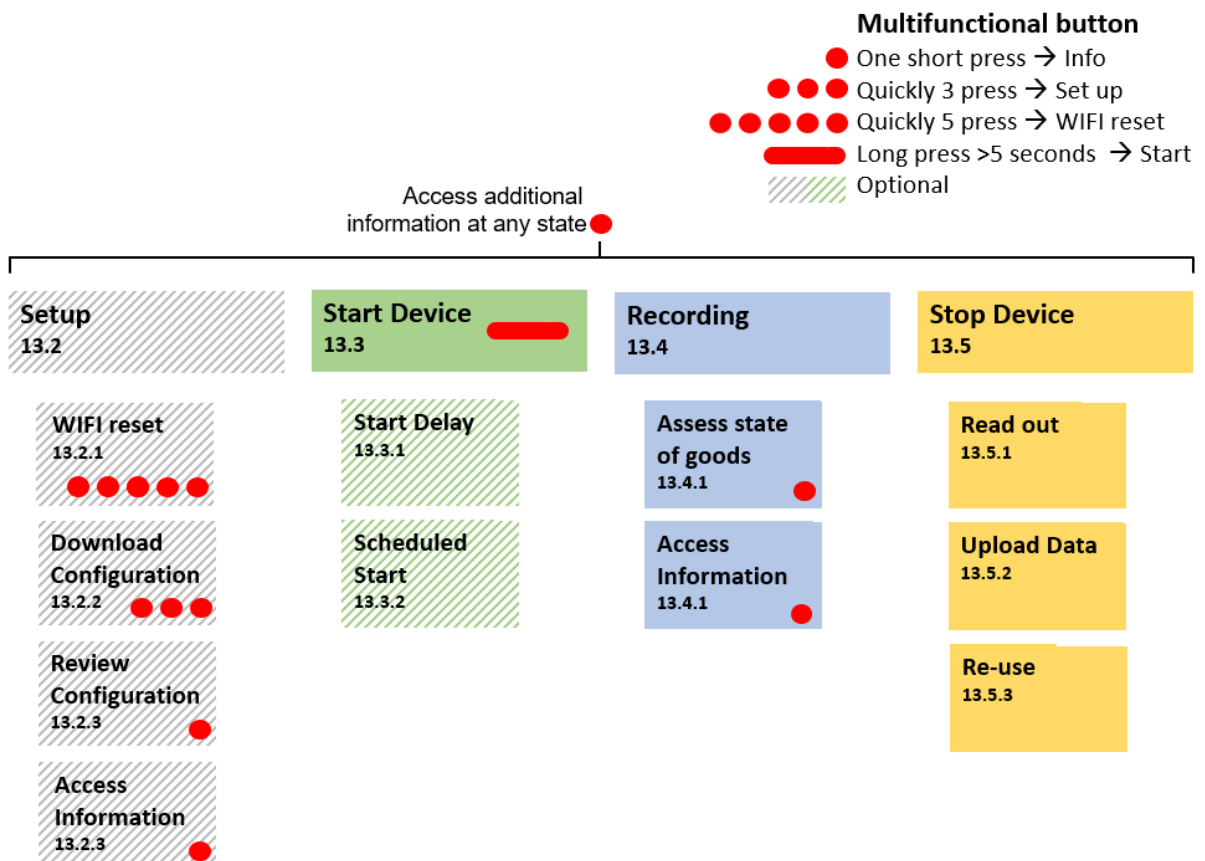

13.2 Setup

To operate the SmartMonitor SITE L, a configuration on the device is needed.

It is also possible that a configuration is already loaded on the device.

13.2.1 WIFI reset

If device has no WIFI connection, press the multifunctional button quickly 5 times to reset the connection ●●●●●.

13.2.2 Download Configuration

If no configuration is already loaded on the device, press the multifunctional button quickly 3 times ●●●.

The configuration will be loaded. See chapter 5 multifunctional button

Configuration of device can be done with Berlinger SmartView software (version 6.0 and higher).

13.2.3 Review/Check configuration

To confirm that the loaded configuration is correct, check the configuration on the display by pressing the multifunctional button once ●.

13.3 Start

To start the device, press the multifunctional button once (long press)  for more than 5 seconds.

After that, the device will go to record mode and the display will show  REC accordingly. See chapter 5 multifunctional button

13.3.1 Start delay

If a start delay is configured, the device waits with start recording until start delay has expired. This is indicated by a countdown in the display.

The device cannot be stopped during start delay phase. This is a safety feature to prevent the device from being stopped by mistake.

13.3.2 Scheduler Start

Device has the possibility to configure it with a scheduled start via Berlinger SmartView software (version 6.0 and higher).

13.4 Recording

As long as the device is not stopped, it records the temperature (and other parameters, if set) and transmits the data via WIFI to the Berlinger SmartView software (version 6.0 and higher) at a predefined interval.

The display shows the current temperature and informs via the hook ✓ or cross ✗ whether the alarm parameters have been violated.

13.4.1 Assess state of goods and information

User has the possibility to assess state of the monitoring and get information on the device display by pressing the multifunctional button once ●.

13.5 Stop

SmartMonitor SITE L device can only be stopped via Berlinger SmartView software (version 6.0 and later).

As soon as the stop command has been entered via SmartView, the device will be stopped during the next synchronization between SmartView and SITE L and the information DONE will be shown on the 7-segment display on the device.

13.5.1 Read out

As soon as the device becomes the stop command via SmartView, it automatically sends the remaining data to Berlinger SmartView software (version 6.0 and higher).

If an automatic upload is not possible, the two icons Bluetooth and USB flash. In this case, the readout of the measurement data can be done manually via USB.

- **Reading out via USB:**

Connect the device to a computer via USB-C connector, the device will immediately start downloading the data to your computer.

- **Readout via Bluetooth:**

Reading out via Bluetooth will only be possible with a later version.

13.5.2 Upload data manually of read out data to Berlinger SmartView software (version 6.0 and higher).

To upload the manually read out data to Berlinger SmartView software (version 6.0 and higher) you have two possibilities:

- Direct upload to Berlinger SmartView software (version 6.0 and higher):
Open Berlinger SmartView software (version 6.0 and higher), chose Device → Upload Data File → Select the datafile to upload → confirm it by pressing Upload File(s)
- Via e-mail:
Send the read out datafile via e-mail to qtag-upload@smartview.berlinger.com

13.5.3 Return device

If monitoring is complete and the data are uploaded to Berlinger SmartView software (version 6.0 and higher), the device can be used for the next operation.

Before the device will be used for the next operation, follow the instruction at **chapter Maintenance.**

If the unit was rented from Berlinger, return it to Berlinger in accordance with the RMA process.

14 Where to place SmartMonitor SITE L

Berlinger recommends placing the SmartMonitor SITE L as close as possible to the product to be monitored so that the temperature can be recorded as accurately as possible.

If the temperature is to be measured in a refrigerator or freezer, it is recommended to do this with an external sensor. This allows the temperature to be read from the outside on the display. Furthermore, the WIFI connection inside a fridge is poor or not possible at all.

If the temperature monitoring is done with an external sensor, the external sensor should be placed as close as possible to the product to be monitored.

Important!

The cable of the external sensor should be placed in such a way that it does not interfere with the daily handling of the personnel or the cable can be disconnected.

15 External Sensor

Use only original Berlinger external sensors for SmartMonitor SITE L.

Make sure that the sensor is properly connected to the device and the connector is secured (tightened by hand). Do not tighten the connector with pliers or any other tool, otherwise the connector may be damaged.

The cable of the external sensor should be placed in such a way that it does not interfere with the daily handling of the personnel or the cable can be disconnected.

Berlinger offers several types of external sensor as:

1.5 Meter Temperature Sensor



1.5 Meter Temperature/Humidity Sensor



15.1 Connect an external sensor to SmartMonitor SITE L device

To connect an external Berlinger probe to a SmartMonitor SITE L remove the grey cover at the right site from device.

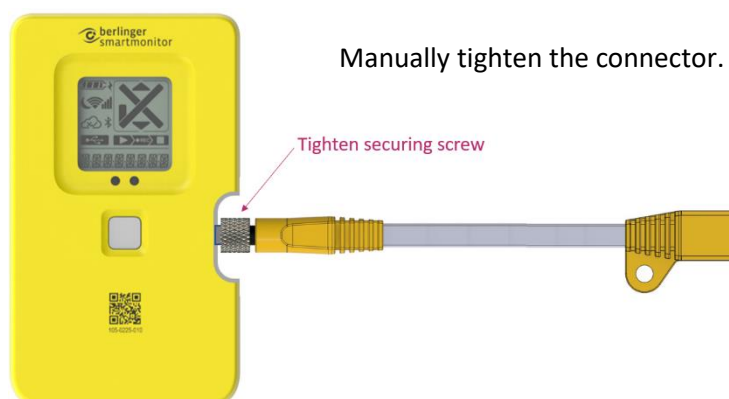
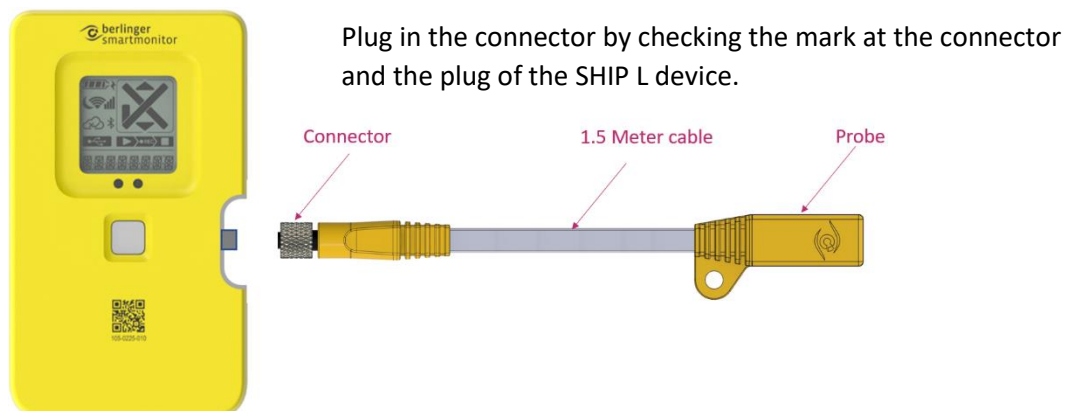
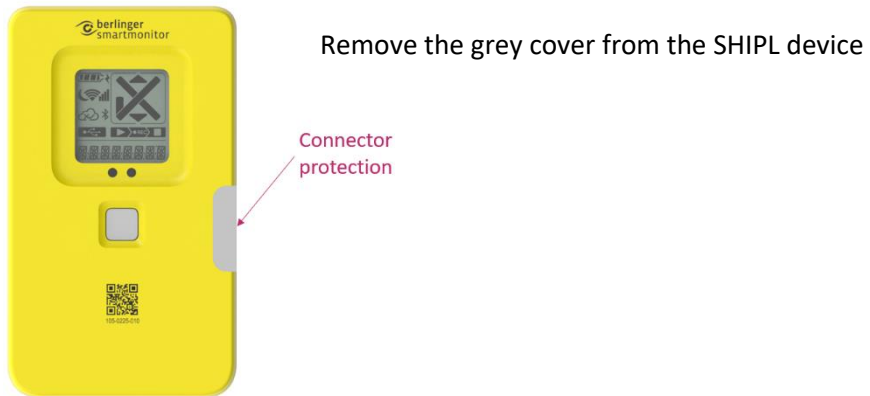

15.2 Multi Sensor Adapter



With SITE L device it is possible to connect a total of 4 external sensors with the help of the Multi Sensor Adapter.

For this, connect the Multi Sensor Adapter to the SITE L device and make sure that the connector makes contact in a secure way.

The configuration for this Multi Sensor Adapter is done by Berlinger SmartView (version 6.0 and higher).

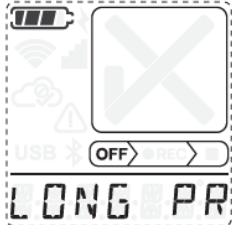
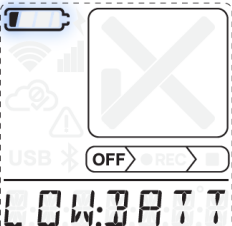
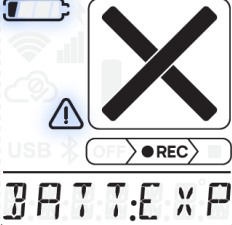
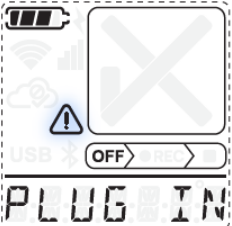
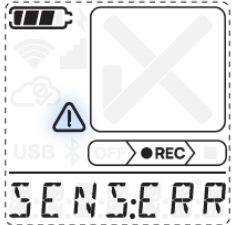
16 Troubleshooting

Problem	Effect	Solution
Blank display	No information visible	Connect the device to USB charger to charge the battery.
	Device cannot be started Display shows LONG PRESS	Press the multifunctional button at least 5 second.
	LOW BATTERY LOW:BATT will be shown on the 7-segment display and battery symbol is blinking	Connect the device to power to charge the battery.
	BATTERY EXPIRED BAT:EXPIRED will be shown on the 7-segment display and the battery symbol is blinking. Exclamation mark ⚠ is blinking. Use of device is no longer possible due to safety reason.	Replace device.
	PLUG IN PLUG IN will be shown on the 7-segment display and the exclamation mark ⚠ is blinking. Device is configured for an external sensor but no external sensor is detected.	Connect an external sensor or check if sensor is correctly connected.
	SENSOR ERROR SENS:ERR will be shown on the 7-segment display and the exclamation mark ⚠ is blinking. Connected sensor is defective.	Replace external sensor.

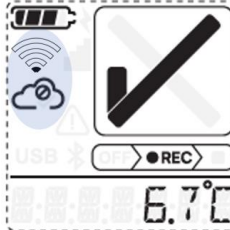
	<p>MANUAL SYNC MANUAL SYNC will be shown on the 7-segment display, the cloud symbol crossed out circle is displayed ☁️ and USB and Bluetooth sign 📶 is blinking. Configuration is needed.</p>	<p>Load configuration. Press quickly 3 times the multifunctional button Or check if a configuration is available for that device in Berlinger SmartView software (version 6.0 and higher). if no communication to SmartView Cloud is possible, configuration needs to be loaded manually</p>
	<p>Manual SYNC 📶 Manual SYNC 📶 will be shown on the 7-segment display as a ticker information and at the cloud symbol crossed out circle is displayed ☁️. Manual upload of data is needed.</p>	<p>Manual upload with USB or Bluetooth is needed. Upload the data manually to Berlinger SmartView software (version 6.0 and higher). Upload via Bluetooth will be available in a later version.</p>
	<p>LOW --°C LOW --°C will be shown on the 7-segment display and the exclamation mark ⚠️ is blinking.</p>	<p>The measured temperature is out of specified temperature range of SmartMonitor SITE L device.</p>
	<p>No WIFI connection No connection to Berlinger SmartView software.</p>	<p>Press the multifunctional button 5 times shortly to reset WIFI connection.</p>

On the back of the device is a 3D-code which links to the Berlinger website where more information about this device is available.

If more help is needed, contact Berlinger support at support@berlinger.com

17 Disposal

Electronic devices are recyclable and do not belong in household waste. At the end of its lifetime, dispose of the product in accordance with the law according to your country or return it to Berlinger according Berlinger RMA process.

18 Certification

SmartMonitor SITE L device has following certifications:

- CE / RED
- RTCA DO-160
- FCC / ISSED

18.1 Specific Information for North America (FCC/ISED)

This device contains licence-exempt transmitter(s)/receiver(s) that comply with Innovation, Science and Economic Development Canada's licence-exempt RSS(s) and complies with part 15 of the FCC Rules. Operation is subject to the following two conditions:

1. This device may not cause harmful interference.
2. This device must accept any interference received, including interference that may cause undesired operation of the device.

L'émetteur/récepteur exempt de licence contenu dans le présent appareil est conforme aux CNR d'Innovation, Sciences et Développement économique Canada applicables aux appareils radio exempts de licence. L'exploitation est autorisée aux deux conditions suivantes :

1. L'appareil ne doit pas produire de brouillage.
2. L'appareil doit accepter tout brouillage radioélectrique subi, même si le brouillage est susceptible d'en compromettre le fonctionnement.

Changes or modifications made to this equipment not expressly approved by Berlinger & Co. AG may void the FCC authorization to operate this equipment.

Note: This equipment has been tested and found to comply with the limits for a Class B digital device, pursuant to part 15 of the FCC Rules. These limits are designed to provide reasonable protection against harmful interference in a residential installation. This equipment generates, uses and can radiate radio frequency energy and, if not installed and used in accordance with the instructions, may cause harmful interference to radio communications. However, there is no guarantee that interference will not occur in a particular installation. If this equipment does cause harmful interference to radio or television reception, which can be determined by turning the equipment off and on, the user is encouraged to try to correct the interference by one or more of the following measures:

- Reorient or relocate the receiving antenna.
- Increase the separation between the equipment and receiver.
- Connect the equipment into an outlet on a circuit different from that to which the receiver is connected.
- Consult the dealer or an experienced radio/TV technician for help.

Radiofrequency radiation exposure Information:

This equipment complies with FCC and ISED radiation exposure limits set forth for an uncontrolled environment. This equipment should be installed and operated with minimum distance of 20 cm between the radiator and your body.

This transmitter must not be co-located or operating in conjunction with any other antenna or transmitter.

Cet équipement est conforme aux limites d'exposition aux rayonnements ISED établies pour un environnement non contrôlé. Cet équipement doit être installé et utilisé avec un minimum de 20 cm de distance entre la source de rayonnement et votre corps.

Ce transmetteur ne doit pas être placé au même endroit ou utilisé simultanément avec un autre transmetteur ou antenne.

19 Standards

This equipment has been tested and found to comply with the limits for:

- IEC 62368-1
- EN 12830
- GAMP5
- FDA 21 CFR Part 11