

Product Name: LTE Cat-M1 Tracker	Report No: FCC022022-05738RF12(c)
Product Model: ATD521	Security Classification: Open
Version: V1.0	Total Page: 130

Testing Report



Prepared By:	Checked By:	Approved By:	
Stone Tang	Randy Lv	Daniel Chen	
<i>Stone Tang</i>	<i>Randy Lv</i>	<i>Daniel Chen</i>	

FCC Radio Test Report

FCC ID: 2AH4HATD521

This report concerns: Original Grant

Project No. : 2022-05738
Equipment : LTE Cat-M1 Tracker
Brand Name : Mobilogix
Test Model : ATD521
Series Model : NA
Applicant : Mobilogix, Inc.
Address : 5500 Trabuco Rd Suite 150 Irvine, CA, USA
Manufacturer : Mobilogix, Inc.
Address : 5500 Trabuco Rd Suite 150 Irvine, CA, USA
Factory : Suga Electronics (Dongguan) Co., Ltd.
Address : No.8 Fulong Road, Qingxi Town, Dongguan City
Date of Receipt : Aug. 05, 2022
Date of Test : Aug. 09, 2022 ~ Aug. 25, 2022
Issued Date : Nov. 04, 2022
Report Version : V1.0
Test Sample : Engineering Sample No.: 20221103019315
Standard(s) : 47 CFR FCC Part 27 Subpart L
47 CFR FCC Part 27 Subpart H
47 CFR FCC Part 27 Subpart F
47 CFR FCC Part 2
ANSI C63.26-2015
ANSI/TIA/EIA-603-E-2016
FCC KDB 971168 D01 Power Meas License Digital Systems v03r01

- The test result referred exclusively to the presented test model /sample.
- Without written approval of TIRT Inc. the test report shall not reproduced except in full.

Lab: Beijing TIRT Technology Service Co.,Ltd Shenzhen

Add: 101, 3 # Factory Building, Gongjin Electronics Shatin Community, Kengzi Street,
Pingshan District, Shenzhen, China

TEL: +86-0755-27087573

Table of Contents	Page
REPORT ISSUED HISTORY	5
1 . SUMMARY OF TEST RESULTS	6
1.1 TEST FACILITY	7
1.2 MEASUREMENT UNCERTAINTY	7
1.3 TEST ENVIRONMENT CONDITIONS	7
2 . GENERAL INFORMATION	8
2.1 GENERAL DESCRIPTION OF EUT	8
2.2 DESCRIPTION OF TEST MODES	11
2.3 BLOCK DIGRAM SHOWING THECONFIGURATIONOFSYSTEMTESTED	15
2.4 DESCRIPTION OF SUPPORT UNITS	15
3 . TEST RESULT	16
3.1 OUTPUT POWER MEASUREMENT	16
3.1.1 LIMIT	16
3.1.2 TEST PROCEDURE	16
3.1.3 TEST SETUP LAYOUT	16
3.1.4 TEST DEVIATION	16
3.1.5 TEST RESULTS	16
3.2 OCCUPIED BANDWIDTH MEASUREMENT	17
3.2.1 TEST PROCEDURE	17
3.2.2 TEST SETUP LAYOUT	17
3.2.3 TEST DEVIATION	17
3.2.4 TEST RESULTS	17
3.3 CONDUCTED SPURIOUS EMISSIONS MEASUREMENT	18
3.3.1 LIMIT	18
3.3.2 TEST PROCEDURES	18
3.3.3 TEST SETUP LAYOUT	18
3.3.4 TEST DEVIATION	18
3.3.5 TEST RESULTS	18
3.4 RADIATED SPURIOUS EMISSIONS MEASUREMENT	19
3.4.1 LIMIT	19
3.4.2 TEST PROCEDURES	19
3.4.3 TEST SETUP LAYOUT	20
3.4.4 TEST RESULTS (9KHZ TO 30MHZ)	21
3.4.5 TEST RESULTS (30MHZ TO 1000MHZ)	21
3.4.6 TEST RESULTS (ABOVE 1000MHZ)	21
3.5 BAND EDGE MEASUREMENT	22
3.5.1 LIMIT	22
3.5.2 TEST PROCEDURES	22
3.5.3 TEST SETUP LAYOUT	22
3.5.4 TEST DEVIATION	22

Table of Contents	Page
3.5.5 TEST RESULTS	22
3.6 PEAK TO AVERAGE RATIO MEASUREMENT	23
3.6.1 LIMIT	23
3.6.2 TEST PROCEDURES	23
3.6.3 TEST SETUP LAYOUT	23
3.6.4 TEST DEVIATION	23
3.6.5 TEST RESULTS	23
3.7 FREQUENCY STABILITY MEASUREMENT	24
3.7.1 LIMIT	24
3.7.2 TEST PROCEDURES	24
3.7.3 TEST SETUP LAYOUT	24
3.7.4 TEST DEVIATION	24
3.7.5 TEST RESULTS	24
4. LIST OF MEASUREMENT EQUIPMENTS	25
APPENDIX A - OUTPUT POWER	26
APPENDIX B - OCCUPIED BANDWIDTH	35
APPENDIX C - CONDUCTED SPURIOUS EMISSIONS	56
APPENDIX D - RADIATED SPURIOUS EMISSIONS (9KHZ TO 30MHZ)	62
APPENDIX E - RADIATED SPURIOUS EMISSIONS (30MHZ TO 1GHZ)	64
APPENDIX F - RADIATED SPURIOUS EMISSIONS (ABOVE 1GHZ)	72
APPENDIX G - BAND EDGE	83
APPENDIX H - PEAK TO AVERAGE RATIO	104
APPENDIX I - FREQUENCY STABILITY	125

REPORT ISSUED HISTORY

Report No.	Version	Description	Issued Date	Note
FCC022022-05738RF12(c)	V1.0	Original Report.	2022.11.04	Valid

1. SUMMARY OF TEST RESULTS

Test procedures according to the technical standard(s):

FCC Part 27 Subpart L, H, F & Part 2			
Standard(s) Section	Test Item	Judgment	Remark
2.1046 27.50(d)(4) 27.50(c)(10) 27.50(b)(10)	Output Power & Equivalent Isotropic Radiated Power & Equivalent Radiated Power	PASS	-----
2.1049	Occupied Bandwidth	PASS	-----
2.1051 27.53(h) 27.53(g) 27.53(c)(2)(f)	Conducted Spurious Emissions	PASS	-----
2.1053 27.53(h) 27.53(g) 27.53(c)(2)(f)	Radiated Spurious Emissions	PASS	-----
2.1051 27.53(h) 27.53(g) 27.53(c)(2)(f)	Band Edge Measurements	PASS	-----
27.50(d)(5)	Peak To Average Ratio	PASS	-----
2.1055 27.54	Frequency Stability	PASS	-----

Note:

(1) "N/A" denotes test is not applicable in this test report.

1.1 TEST FACILITY

Company:	Beijing TIRT Technology Service Co.,Ltd Shenzhen
Address:	101, 3 # Factory Building, Gongjin Electronics Shatin Community, Kengzi Street, Pingshan District, Shenzhen, China
CNAS Registration Number:	CNAS L14158
A2LA Registration Number:	6049.01
FCC Accredited Lab. Designation Number:	CN1309
FCC Test Firm Registration Number:	825524
Telephone:	+86-0755-27087573

1.2 MEASUREMENT UNCERTAINTY

ISO/IEC 17025 requires that an estimate of the measurement uncertainties associated with the emissions test results be included in the report. The measurement uncertainties given below are based on a 95% confidence level (based on a coverage factor (k=2))
 The TIRT measurement uncertainty as below table:

Parameter	Uncertainty
Occupied Channel Bandwidth	±142.12 KHz
RF power conducted	±0.74 dB
RF power radiated	±3.25dB
Spurious emissions, conducted	±1.78dB
Spurious emissions, radiated (30MHz~1GHz)	±4.6dB
Spurious emissions, radiated (1G z ~ 18GHz)	±4.9dB
Conduction Emissions(150kHz~30MHz)	±3.1 dB
Humidity	±4.6%
Temprature	±0.7°C
Time	±1.25%

Note: Unless specifically mentioned, the uncertainty of measurement has not been taken into account to declare the compliance or non-compliance to the specification.

1.3 TEST ENVIRONMENT CONDITIONS

Test Item	Temperature	Humidity	Test Voltage	Tested By
Output Power & ERP & EIRP	23°C	41%	DC 3.7V	Stone Tang
Occupied Bandwidth	23°C	41%	DC 3.7V	Stone Tang
Conducted Spurious Emissions	23°C	41%	DC 3.7V	Stone Tang
Radiated Spurious Emissions (9 kHz to 30 MHz)	25°C	55%	AC 120V/60Hz	Stone Tang
Radiated Spurious Emissions (30 MHz to 1000 MHz)	24°C	50~51%	AC 120V/60Hz	Stone Tang
Radiated Spurious Emissions (Above 1000 MHz)	24°C	50~51%	AC 120V/60Hz	Stone Tang
Band Edge	23°C	41%	DC 3.7V	Stone Tang
Peak to Average Ratio	23°C	41%	DC 3.7V	Stone Tang
Frequency Stability	Normal & Extreme	41%	Normal & Extreme	Stone Tang

2. GENERAL INFORMATION

2.1 GENERAL DESCRIPTION OF EUT

Equipment	LTE Cat-M1 Tracker			
Brand Name	Mobilogix			
Test Model	ATD521			
Series Model	NA			
Model Difference(s)	There are 3 types of this product: 1. Type L: MCU model: EFR32BG12P232F512GM68-CR. 2. Type S: MCU model: EFR32BG12P232F1024GM68-CR. Compared to the Type L, only the memory is different. 3. Type D: The same as Type L, but the labels are different, the customer are different. The difference does not affect RF characteristics, and type L is the main test model.			
Power Source	1# DC Voltage supplied from AC adapter. Model: ADS-10LA-06 05010EPCU 2# Supplied from battery.			
Power Rating	1# I/P: 100-240V ~ 50/60Hz MAX 0.3A O/P: 5V \equiv 2.0A 2# DC 3.7V / 3000mAh			
IMEI No.	Radiated	864351051515882		
	Conducted	864351051515635		
LTE Category	M1			
Modulation Type	LTE		UL: QPSK, 16QAM DL: QPSK, 16QAM	
Max. EIRP	LTE	Channel Bandwidth (MHz)	QPSK (dBm)	16QAM (dBm)
	Band 4	1.4	24.29	23.21
		3	23.76	22.81
		5	24.61	24.59
		10	24.16	24.20
		15	24.32	24.18
		20	24.15	24.01
	Band 66	1.4	24.62	23.66
		3	24.57	23.61
		5	25.08	24.71
		10	24.47	24.28
		15	24.56	24.36
		20	24.43	24.37
	Max. ERP	Band 12	1.4	20.43
3			20.33	18.86
5			20.45	20.55
10			20.32	20.21
Band 13		5	20.81	20.65
		10	20.34	20.19
Band 85		5	20.11	20.38
		10	20.09	20.33

Note:

1. For a more detailed features description, please refer to the manufacturer's specifications or the user's manual.

2. Channel List:

LTE Band 4					
Test Frequency ID	Bandwidth (MHz)	N _{UL}	Frequency of Uplink (MHz)	N _{DL}	Frequency of Downlink (MHz)
Low Range	1.4	19957	1710.7	1957	2110.7
	3	19965	1711.5	1965	2111.5
	5	19975	1712.5	1975	2112.5
	10	20000	1715	2000	2115
	15	20025	1717.5	2025	2117.5
	20	20050	1720	2050	2120
Mid Range	1.4/3/5/10/15/20	20175	1732.5	2175	2132.5
High Range	1.4	20393	1754.3	2393	2154.3
	3	20385	1753.5	2385	2153.5
	5	20375	1752.5	2375	2152.5
	10	20350	1750	2350	2150
	15	20325	1747.5	2325	2147.5
	20	20300	1740	2300	2145

LTE Band 12					
Test Frequency ID	Bandwidth (MHz)	N _{UL}	Frequency of Uplink (MHz)	N _{DL}	Frequency of Downlink (MHz)
Low Range	1.4	23017	699.7	5017	729.7
	3	23025	700.5	5025	730.5
	5	23035	701.5	5035	731.5
	10	23060	704.0	5060	734
Mid Range	1.4/3/5/10	23095	707.5	5095	737.5
High Range	1.4	23173	715.3	5173	745.3
	3	23165	714.5	5165	744.5
	5	23155	713.5	5155	743.5
	10	23130	711.0	5130	741

LTE Band 13					
Test Frequency ID	Bandwidth (MHz)	N _{UL}	Frequency of Uplink (MHz)	N _{DL}	Frequency of Downlink (MHz)
Low Range	5	23205	779.5	5205	748.5
Mid Range	5/10	23230	782.0	5230	751
High Range	5	23255	784.5	5255	753.5

LTE Band 66					
Test Frequency ID	Bandwidth (MHz)	N _{UL}	Frequency of Uplink (MHz)	N _{DL}	Frequency of Downlink (MHz)
Low Range	1.4	131979	1710.7	66443	2110.7
	3	131987	1711.5	66451	2111.5
	5	131997	1712.5	66461	2112.5
	10	132022	1715	66486	2115
	15	132047	1717.5	66511	2117.5
	20	132072	1720	66536	2120
Mid Range	1.4/3/5/10/15/20	132322	1745	66786	2145
High Range	1.4	132665	1779.3	67129	2179.3
	3	132657	1778.5	67121	2178.5
	5	132647	1777.5	67111	2177.5
	10	132622	1775	67086	2175
	15	132597	1772.5	67061	2172.5
	20	132572	1770	67036	2170

LTE Band 85					
Test Frequency ID	Bandwidth (MHz)	N _{UL}	Frequency of Uplink (MHz)	N _{DL}	Frequency of Downlink (MHz)
Low Range	5	134027	700.5	70391	730.5
	10	134052	703	70416	733
Mid Range	5/10	134092	707	70456	737
High Range	5	134157	713.5	70521	743.5
	10	134132	711	70496	741

3. Table for Filed Antenna:

Brand	P/N	Antenna Type	Connector	Gain (dBi)	Note
ethertronics	1004795	Internal	N/A	3.1	LTE Band 4
				1.6	LTE Band 12
				1.6	LTE Band 13
				3.1	LTE Band 66
				1.6	LTE Band 85

Note: The antenna gain is provided by the manufacturer.

2.2 DESCRIPTION OF TEST MODES

Following mode(s) is (were) found to be the worst case(s) and selected for the final test.

LTE BAND 4 MODE					
Test Item	Available Channel	Tested Channel	Channel Bandwidth	Modulation	Mode
Output Power & EIRP	19957 to 20393	19957, 20175, 20393	1.4MHz	QPSK, 16QAM	1RB/5RB/6RB
	19965 to 20385	19965, 20175, 20385	3MHz	QPSK, 16QAM	1RB/5RB/6RB
	19975 to 20375	19975, 20175, 20375	5MHz	QPSK, 16QAM	1RB/5RB/6RB
	20000 to 20350	20000, 20175, 20350	10MHz	QPSK, 16QAM	1RB/5RB/6RB
	20025 to 20325	20025, 20175, 20325	15MHz	QPSK, 16QAM	1RB/5RB/6RB
	20050 to 20300	20050, 20175, 20300	20MHz	QPSK, 16QAM	1RB/5RB/6RB
Occupied Bandwidth	19957 to 20393	19957, 20175, 20393	1.4MHz	QPSK, 16QAM	5RB/6RB
	19965 to 20385	19965, 20175, 20385	3MHz	QPSK, 16QAM	5RB/6RB
	19975 to 20375	19975, 20175, 20375	5MHz	QPSK, 16QAM	5RB/6RB
	20000 to 20350	20000, 20175, 20350	10MHz	QPSK, 16QAM	5RB/6RB
	20025 to 20325	20025, 20175, 20325	15MHz	QPSK, 16QAM	5RB/6RB
	20050 to 20300	20050, 20175, 20300	20MHz	QPSK, 16QAM	5RB/6RB
Conducted Spurious Emissions	19957 to 20393	20175	1.4MHz	QPSK	1RB
	19975 to 20375	20175	5MHz	QPSK	1RB
	20050 to 20300	20175	20MHz	QPSK	1RB
Radiated Spurious Emissions	19957 to 20393	20175	1.4MHz	QPSK	1RB
	19975 to 20375	20175	5MHz	QPSK	1RB
	20050 to 20300	20175	20MHz	QPSK	1RB
Band Edge	19957 to 20393	19957, 20393	1.4MHz	QPSK	1RB/6RB
	19965 to 20385	19965, 20385	3MHz	QPSK	1RB/6RB
	19975 to 20375	19975, 20375	5MHz	QPSK	1RB/6RB
	20000 to 20350	20000, 20350	10MHz	QPSK	1RB/6RB
	20025 to 20325	20025, 20325	15MHz	QPSK	1RB/6RB
	20050 to 20300	20050, 20300	20MHz	QPSK	1RB/6RB
Peak To Average Ratio	19957 to 20393	19957, 20175, 20393	1.4MHz	QPSK, 16QAM	1RB
	19965 to 20385	19965, 20175, 20385	3MHz	QPSK, 16QAM	1RB
	19975 to 20375	19975, 20175, 20375	5MHz	QPSK, 16QAM	1RB
	20000 to 20350	20000, 20175, 20350	10MHz	QPSK, 16QAM	1RB
	20025 to 20325	20025, 20175, 20325	15MHz	QPSK, 16QAM	1RB
	20050 to 20300	20050, 20175, 20300	20MHz	QPSK, 16QAM	1RB
Frequency Stability	20050 to 20300	20050, 20300	20MHz	QPSK	6RB

LTE BAND 12 MODE					
Test Item	Available Channel	Tested Channel	Channel Bandwidth	Modulation	Mode
Output Power & ERP	23017 to 23173	23017, 23095, 23173	1.4MHz	QPSK, 16QAM	1RB/5RB/6RB
	23025 to 23165	23025, 23095, 23165	3MHz	QPSK, 16QAM	1RB/5RB/6RB
	23035 to 23155	23035, 23095, 23155	5MHz	QPSK, 16QAM	1RB/5RB/6RB
	23060 to 23130	23060, 23095, 23130	10MHz	QPSK, 16QAM	1RB/5RB/6RB
Frequency Stability	23060 to 23130	23060,23130	10MHz	QPSK	6RB
Occupied Bandwidth	23017 to 23173	23017, 23095, 23173	1.4MHz	QPSK, 16QAM	5RB/6RB
	23025 to 23165	23025, 23095, 23165	3MHz	QPSK, 16QAM	5RB/6RB
	23035 to 23155	23035, 23095, 23155	5MHz	QPSK, 16QAM	5RB/6RB
	23060 to 23130	23060, 23095, 23130	10MHz	QPSK, 16QAM	5RB/6RB
Peak to Average Ratio	23017 to 23173	23017, 23095, 23173	1.4MHz	QPSK, 16QAM	1RB
	23025 to 23165	23025, 23095, 23165	3MHz	QPSK, 16QAM	1RB
	23035 to 23155	23035, 23095, 23155	5MHz	QPSK, 16QAM	1RB
	23060 to 23130	23060, 23095, 23130	10MHz	QPSK, 16QAM	1RB
Band Edge	23017 to 23173	23017, 23173	1.4MHz	QPSK	1RB/6RB
	23025 to 23165	23025, 23165	3MHz	QPSK	1RB/6RB
	23035 to 23155	23035, 23155	5MHz	QPSK	1RB/6RB
	23060 to 23130	23060, 23130	10MHz	QPSK	1RB/6RB
Conducted Emission	23017 to 23173	23095	1.4MHz	QPSK	1RB
	23025 to 23165	23095	3MHz	QPSK	1RB
	23035 to 23155	23095	5MHz	QPSK	1RB
	23060 to 23130	23095	10MHz	QPSK	1RB
Radiated Emission	23017 to 23173	23095	1.4MHz	QPSK	1RB
	23017 to 23173	23095	5MHz	QPSK	1RB
	23060 to 23130	23095	10MHz	QPSK	1RB

LTE BAND 13 MODE					
Test Item	Available Channel	Tested Channel	Channel Bandwidth	Modulation	Mode
Output Power & ERP	23205 to 23255	23205, 23230, 23255	5MHz	QPSK, 16QAM	1RB/5RB/6RB
	23230	23230	10MHz	QPSK, 16QAM	1RB/5RB/6RB
Occupied Bandwidth	23205 to 23255	23205, 23230, 23255	5MHz	QPSK, 16QAM	5RB/6RB
	23230	23230	10MHz	QPSK, 16QAM	5RB/6RB
Band Edge	23205 to 23255	23205, 23255	5MHz	QPSK	1RB/6RB
	23230	23230	10MHz	QPSK	1RB/6RB
Conducted Emission	23205 to 23255	23230	5MHz	QPSK	1RB
	23230	23230	10MHz	QPSK	1RB
Radiated Emission	23205 to 23255	23230	5MHz	QPSK	1RB
	23230	23230	10MHz	QPSK	1RB
Peak to Average Ratio	23205 to 23255	23205, 23230, 23255	5MHz	QPSK, 16QAM	1RB
	23230	23230	10MHz	QPSK, 16QAM	1RB
Frequency Stability	23230	23230	10MHz	QPSK	6RB

LTE BAND 66 MODE					
Test Item	Available Channel	Tested Channel	Channel Bandwidth	Modulation	Mode
Output Power & EIRP	131979 to 132665	131979, 132322, 132665	1.4MHz	QPSK, 16QAM	1RB/5RB/6RB
	131987 to 132657	131987, 132322, 132657	3MHz	QPSK, 16QAM	1RB/5RB/6RB
	131997 to 132647	131997, 132322, 132647	5MHz	QPSK, 16QAM	1RB/5RB/6RB
	132022 to 132622	132022, 132322, 132622	10MHz	QPSK, 16QAM	1RB/5RB/6RB
	132047 to 132597	132047, 132322, 132597	15MHz	QPSK, 16QAM	1RB/5RB/6RB
	132072 to 132572	132072, 132322, 132572	20MHz	QPSK, 16QAM	1RB/5RB/6RB
Occupied Bandwidth	131979 to 132665	131979, 132322, 132665	1.4MHz	QPSK, 16QAM	5RB/6RB
	131987 to 132657	131987, 132322, 132657	3MHz	QPSK, 16QAM	5RB/6RB
	131997 to 132647	131997, 132322, 132647	5MHz	QPSK, 16QAM	5RB/6RB
	132022 to 132622	132022, 132322, 132622	10MHz	QPSK, 16QAM	5RB/6RB
	132047 to 132597	132047, 132322, 132597	15MHz	QPSK, 16QAM	5RB/6RB
	132072 to 132572	132072, 132322, 132572	20MHz	QPSK, 16QAM	5RB/6RB
Conducted Spurious Emissions	131979 to 132665	132322	1.4MHz	QPSK	1RB
	131997 to 132647	132322	5MHz	QPSK	1RB
	132072 to 132572	132322	20MHz	QPSK	1RB
Radiated Spurious Emissions	131979 to 132665	132322	1.4MHz	QPSK	1RB
	131997 to 132647	132322	5MHz	QPSK	1RB
	132072 to 132572	132322	20MHz	QPSK	1RB
Band Edge	131979 to 132665	131979, 132665	1.4MHz	QPSK	1RB/6RB
	131987 to 132657	131987, 132657	3MHz	QPSK	1RB/6RB
	131997 to 132647	131997, 132647	5MHz	QPSK	1RB/6RB
	132022 to 132622	132022, 132622	10MHz	QPSK	1RB/6RB
	132047 to 132597	132047, 132597	15MHz	QPSK	1RB/6RB
	132072 to 132572	132072, 132572	20MHz	QPSK	1RB/6RB
Peak to Average Ratio	131979 to 132665	131979, 132322, 132665	1.4MHz	QPSK, 16QAM	1RB
	131987 to 132657	131987, 132322, 132657	3MHz	QPSK, 16QAM	1RB
	131997 to 132647	131997, 132322, 132647	5MHz	QPSK, 16QAM	1RB
	132022 to 132622	132022, 132322, 132622	10MHz	QPSK, 16QAM	1RB
	132047 to 132597	132047, 132322, 132597	15MHz	QPSK, 16QAM	1RB
	132072 to 132572	132072, 132322, 132572	20MHz	QPSK, 16QAM	1RB
Frequency Stability	132072 to 132572	132072, 132572	20MHz	QPSK	6RB

LTE BAND 85 MODE					
Test Item	Available Channel	Tested Channel	Channel Bandwidth	Modulation	Mode
Output Power & ERP	134027 to 134157	134027, 134092, 134157	5MHz	QPSK, 16QAM	1RB/5RB/6RB
	134052 to 134132	134052, 134092, 134132	10MHz	QPSK, 16QAM	1RB/5RB/6RB
Occupied Bandwidth	39675 to 41565	134027, 134092, 134157	5MHz	QPSK, 16QAM	5RB/6RB
	39700 to 41540	134052, 134092, 134132	10MHz	QPSK, 16QAM	5RB/6RB
Conducted Spurious Emissions	39675 to 41565	134092	5MHz	QPSK	1RB
	39750 to 41490	134092	10MHz	QPSK	1RB
Radiated Spurious Emissions	39675 to 41565	134092	5MHz	QPSK	1RB
	39750 to 41490	134092	10MHz	QPSK	1RB
Band Edge	39675 to 41565	134027, 134157	5MHz	QPSK	1RB/6RB
	40090 to 41540	134052, 134132	10MHz	QPSK	1RB/6RB
Peak to Average Ratio	39675 to 41565	134027, 134092, 134157	5MHz	QPSK, 16QAM	1RB
	40090 to 41540	134052, 134092, 134132	10MHz	QPSK, 16QAM	1RB
Frequency Stability	39675 to 41565	134092	5MHz	QPSK	1RB
	40090 to 41540	134092	10MHz	QPSK	1RB

Note:

1. QPSK modulation mode supports the highest RB size up to 6RB and 16QAM modulation mode supports the highest RB size up to 5RB.

2.3 BLOCK DIGRAM SHOWING THE CONFIGURATION OF SYSTEM TESTED

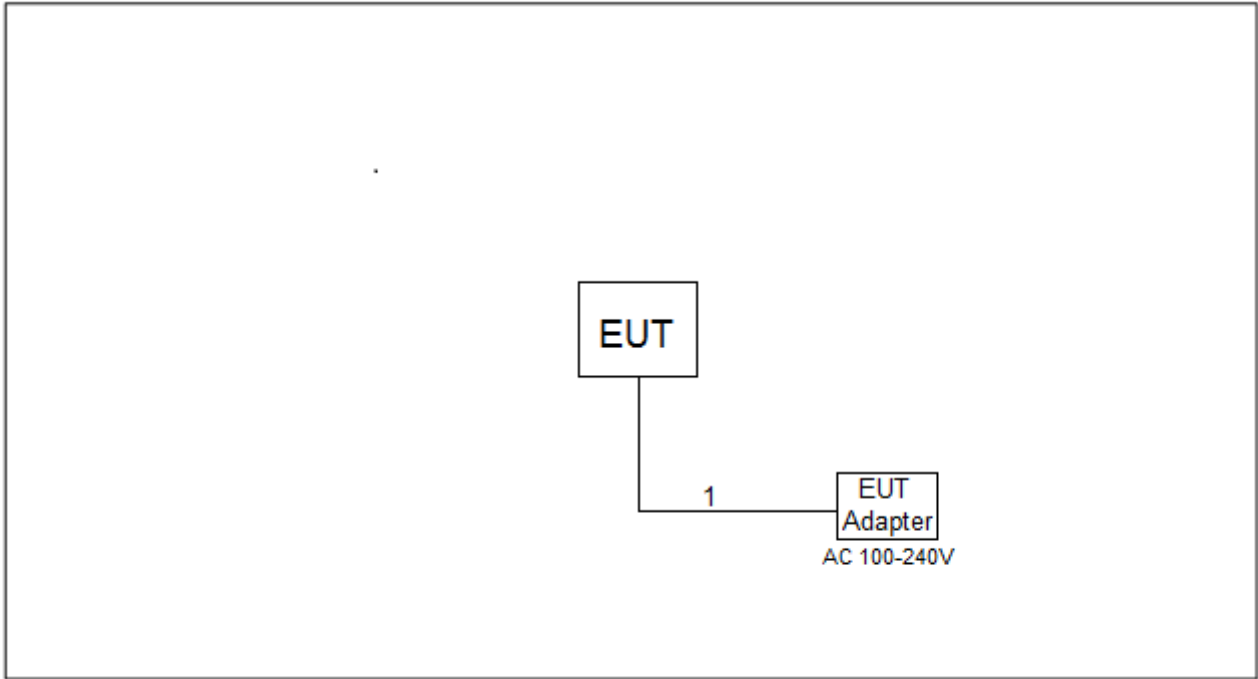

2.4 DESCRIPTION OF SUPPORT UNITS

The EUT has been tested as an independent unit together with other necessary accessories or support units. The following support units or accessories were used to form a representative test configuration during the tests.

Item	Equipment	Brand	Model No.	Series No.
-	-	-	-	-

Item	Cable Type	Shielded Type	Ferrite Core	Length
1	USB Cable	NO	NO	1m

3. TEST RESULT

3.1 OUTPUT POWER MEASUREMENT

3.1.1 LIMIT

Mobile / Portable station are limited to 1 watts e.i.r.p. (Part 27 Subpart L)

Mobile / Portable station are limited to 3 watts e.r.p (Part 27 Subpart H, F)

3.1.2 TEST PROCEDURE

The testing follows FCC KDB 971168 v03r01 Section 5.

EIRP:

$EIRP = \text{Output Power} + \text{Antenan gain}$

ERP:

$ERP = EIRP - 2.15$

Output Power:

The EUT was set up for the maximum power with WCDMA and LTE link data modulation and link up with simulator. Set the EUT to transmit under low, middle and high channel and record the power level shown on simulator.

3.1.3 TEST SETUP LAYOUT

Output Power Measurement

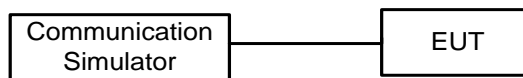

3.1.4 TEST DEVIATION

No deviation.

3.1.5 TEST RESULTS

Please refer to the APPENDIX A.

3.2 OCCUPIED BANDWIDTH MEASUREMENT

3.2.1 TEST PROCEDURE

The testing follows FCC KDB 971168 v03r01 Section 4.

1. The EUT makes a call to the communication simulator. All measurements were done at low, middle and high operational frequency range. The communication simulator station system controlled a EUT to export maximum output power under transmission mode and specific channel frequency. Use OBW measurement function of Spectrum analyzer to measure 99 % occupied bandwidth and 26dB bandwidth.
2. The EUT was connected to spectrum analyzer and system simulator via a power divider.
3. $RBW=(1\% \sim 5\%)*EBW$
 $VBW \geq 3* RBW$
4. Set spectrum analyzer with Peak detector.

3.2.2 TEST SETUP LAYOUT

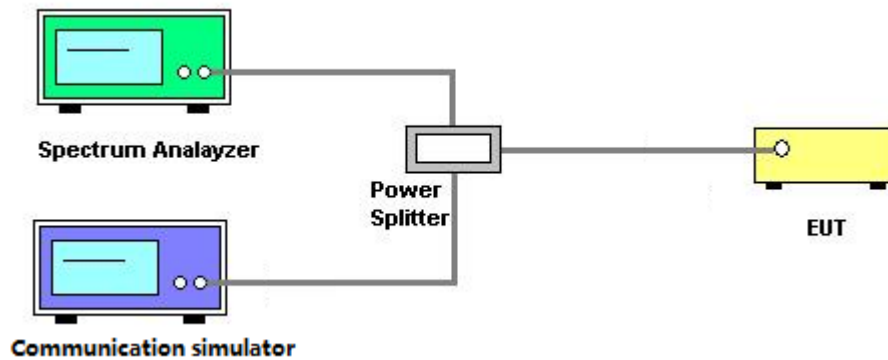

3.2.3 TEST DEVIATION

No deviation.

3.2.4 TEST RESULTS

Please refer to the APPENDIX B.

3.3 CONDUCTED SPURIOUS EMISSIONS MEASUREMENT

3.3.1 LIMIT

The power of any emission outside of the authorized operating frequency ranges must be attenuated below the transmitting power (P) by a factor of at least $43 + 10 \log(P)$ dB. The emission limit equal to -13dBm.

The power of any emission outside of the authorized operating frequency ranges must be attenuated below the transmitting power (P) by a factor of at least $55 + 10 \log(P)$ dB. The emission limit equal to -25dBm.

3.3.2 TEST PROCEDURES

The testing follows FCC KDB 971168 v03r01 Section 6.

1. The EUT was connected to spectrum analyzer and system simulator via a power divider.
2. The band edges of low and high channels for the highest RF powers were measured. Set $RBW \geq 1\% EBW$ in the 1MHz band immediately outside and adjacent to the band edge.
3. Set spectrum analyzer with Peak detector.
4. The RF fundamental frequency should be excluded against the limit line in the operating frequency band.

3.3.3 TEST SETUP LAYOUT

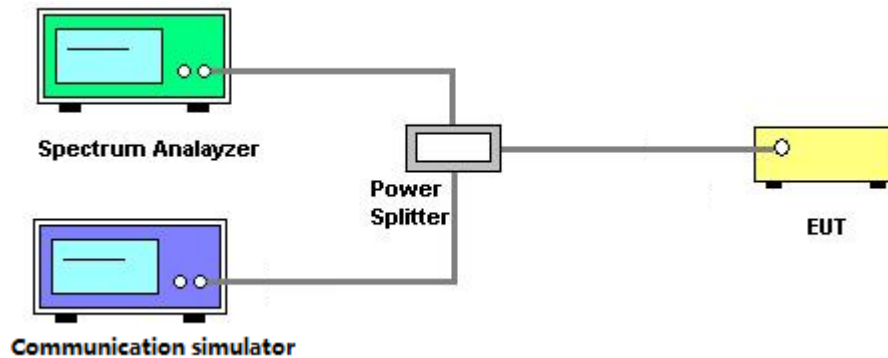

3.3.4 TEST DEVIATION

No deviation.

3.3.5 TEST RESULTS

Please refer to the APPENDIX C.

3.4 RADIATED SPURIOUS EMISSIONS MEASUREMENT

3.4.1 LIMIT

The power of any emission outside of the authorized operating frequency ranges must be attenuated below the transmitting power (P) by a factor of at least $43 + 10 \log(P)$ dB. The emission limit equal to -13dBm.

The power of any emission outside of the authorized operating frequency ranges must be attenuated below the transmitting power (P) by a factor of at least $55 + 10 \log(P)$ dB. The emission limit equal to -25dBm.

3.4.2 TEST PROCEDURES

The testing follows FCC KDB 971168 v03r01 Section 6.2.

1. In the semi-anechoic chamber, EUT placed on the 0.8m height of Turn Table, rotated the table around 360 degrees to search the maximum radiation power and receiver antenna shall be rotated vertical and horizontal polarization and moved height from 1m to 4m to find the maximum polar radiated power. The "Read Value" is the spectrum reading the maximum power value.
2. The substitution horn antenna is substituted for EUT at the same position and signals generator export the CW signal to the substitution antenna via a TX cable. Rotated the Turn Table and moved receiving antenna to find the maximum radiation power. Adjust output power level of S.G to get a Value of spectrum reading equal to "Read Value " of step a. Record the power level of S.G
3. $EIRP = \text{Output power level of S.G} - \text{TX cable loss} + \text{Antenna gain of substitution horn.}$
4. ERP can be calculated form EIRP by subtracting the gain of dipole, $ERP = EIPR - 2.15\text{dBi.}$
5. The resolution bandwidth and video bandwidth of test receiver/spectrum analyzer is 1MHz/3MHz.

3.4.3 TEST SETUP LAYOUT

Below 30MHz

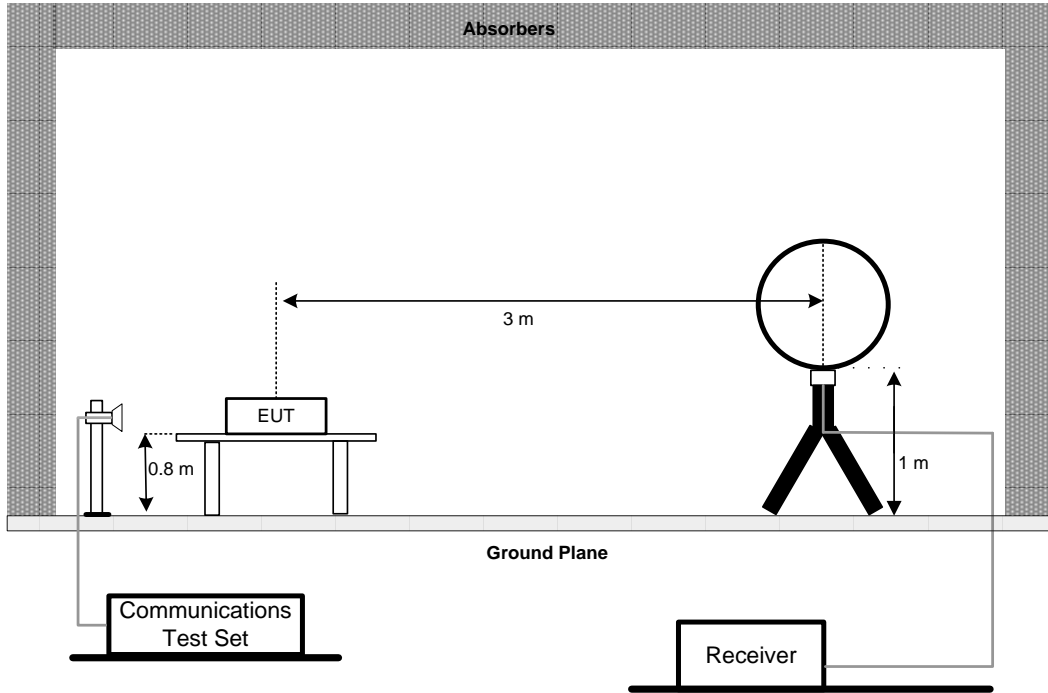

30MHz to 1GHz

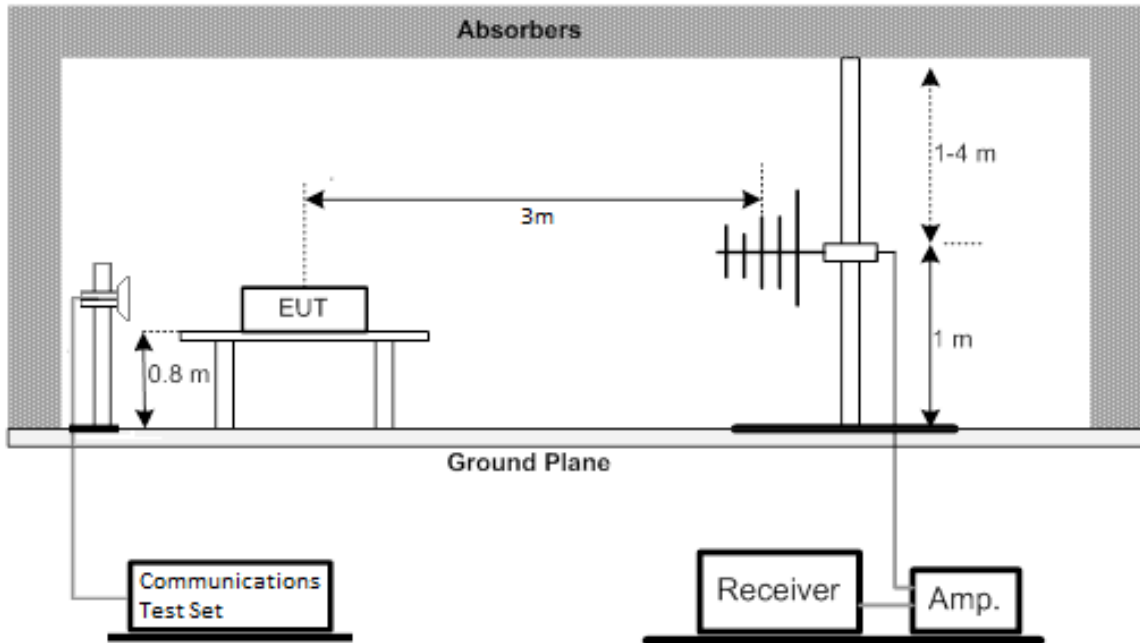

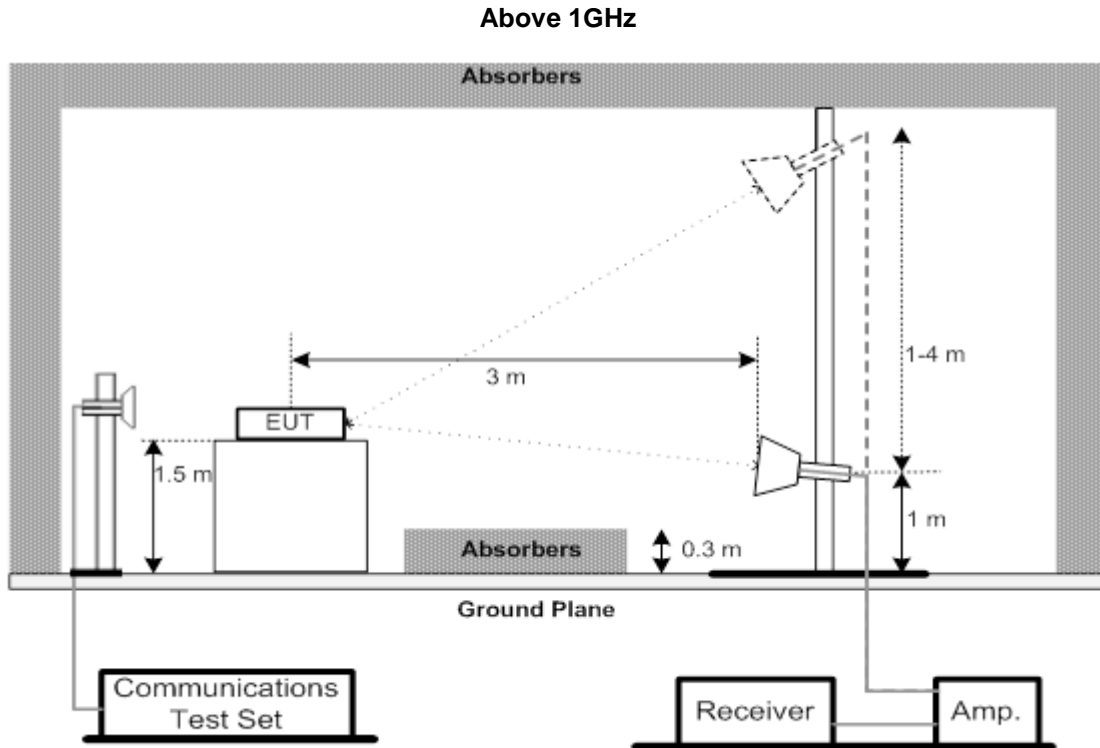

3.4.4 TEST RESULTS (9KHZ TO 30MHZ)

Please refer to the APPENDIX D.

3.4.5 TEST RESULTS (30MHZ TO 1000MHZ)

Please refer to the APPENDIX E.

3.4.6 TEST RESULTS (ABOVE 1000MHZ)

Please refer to the APPENDIX F.

3.5 BAND EDGE MEASUREMENT

3.5.1 LIMIT

The power of any emission outside a licensee's frequency band(s) of operation shall be attenuated below the transmitter power (P) within the licensed band(s) of operation, measured in watts, by at least $43 + 10 \log (P)$ dB. Compliance with this provision is based on the use of measurement instrumentation employing a resolution bandwidth of 100 kilohertz or greater. However, in the 100 kilohertz bands immediately outside and adjacent to a licensee's frequency block, a resolution bandwidth of at least 30 kHz may be employed.

For mobile digital stations, the attenuation factor shall be not less than $40 + 10 \log (P)$ dB on all frequencies between the channel edge and 5 megahertz from the channel edge, $43 + 10 \log (P)$ dB on all frequencies between 5 megahertz and X megahertz from the channel edge, and $55 + 10 \log (P)$ dB on all frequencies more than X megahertz from the channel edge, where X is the greater of 6 megahertz or the actual emission bandwidth as defined in paragraph (m)(6) of this section. In addition, the attenuation factor shall not be less that $43 + 10 \log (P)$ dB on all frequencies between 2490.5 MHz and 2496 MHz and $55 + 10 \log (P)$ dB at or below 2490.5 MHz. Mobile Satellite Service licensees operating on frequencies below 2495 MHz may also submit a documented interference complaint against BRS licensees operating on channel BRS Channel 1 on the same terms and conditions as adjacent channel BRS or EBS licensees.

3.5.2 TEST PROCEDURES

The testing follows FCC KDB 971168 v03r01 Section 6.

1. All measurements were done at low and high operational frequency range.
2. Record the max trace plot into the test report.

3.5.3 TEST SETUP LAYOUT

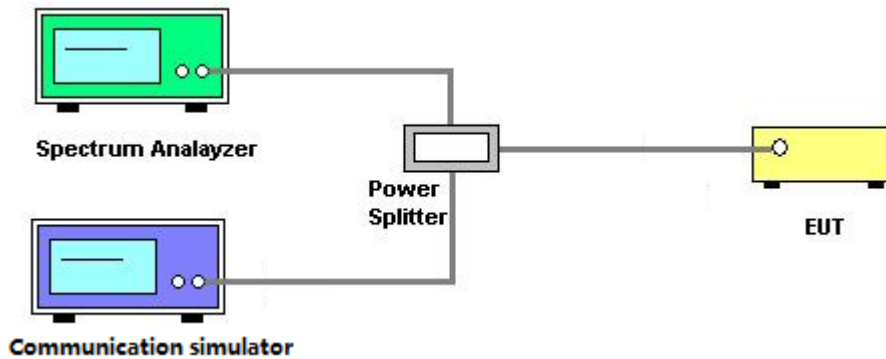

3.5.4 TEST DEVIATION

No deviation.

3.5.5 TEST RESULTS

Please refer to the APPENDIX G.

3.6 PEAK TO AVERAGE RATIO MEASUREMENT

3.6.1 LIMIT

In measuring transmissions in this band using an average power technique, the peak to-average ratio (PAR) of the transmission may not exceed 13 dB.

3.6.2 TEST PROCEDURES

The testing follows FCC KDB 971168 v03r01 Section 5.7.

1. Set resolution/measurement bandwidth \geq signal's occupied bandwidth;
2. Set the number of counts to a value that stabilizes the measured CCDF curve;
3. Record the maximum PAPR level associated with a probability of 0.1%.

3.6.3 TEST SETUP LAYOUT

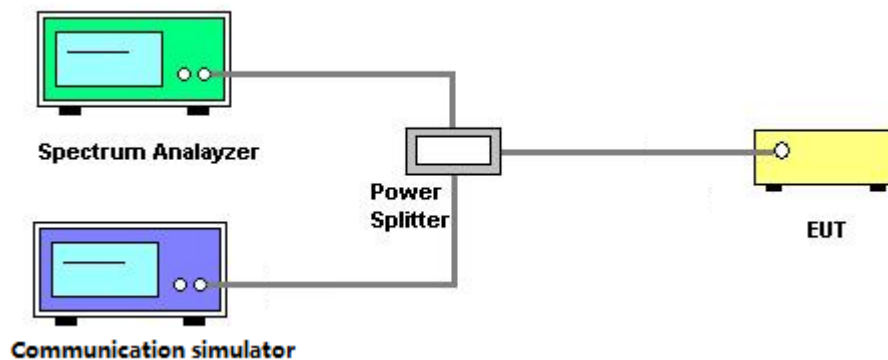

3.6.4 TEST DEVIATION

No deviation.

3.6.5 TEST RESULTS

Please refer to the APPENDIX H.

3.7 FREQUENCY STABILITY MEASUREMENT

3.7.1 LIMIT

The frequency stability shall be sufficient to ensure that the fundamental emission stays within the authorized frequency block.

3.7.2 TEST PROCEDURES

The testing follows ANSI C63.26-2015 Section 5.6.

1. A reference point shall be established at the applicable unwanted emissions limit using a RBW equal to the RBW required by the unwanted emissions specification of the applicable regulatory standard. These reference points measured using the lowest and highest channel of operation shall be identified as f_L and f_H respectively. The worst-case frequency offset determined in the above methods shall be added or subtracted from the values of f_L and f_H and the resulting frequencies must remain within the band.
2. The EUT was set up in the thermal chamber and connected with the system simulator.
3. With power OFF, the temperature was decreased to -30°C and the EUT was stabilized before testing. Power was applied and the maximum change in frequency was recorded within one minute.
4. With power OFF, the temperature was raised in 10°C step up to 50°C . The EUT was stabilized at each step for at least half an hour. Power was applied and the maximum frequency change was recorded within one minute.

3.7.3 TEST SETUP LAYOUT

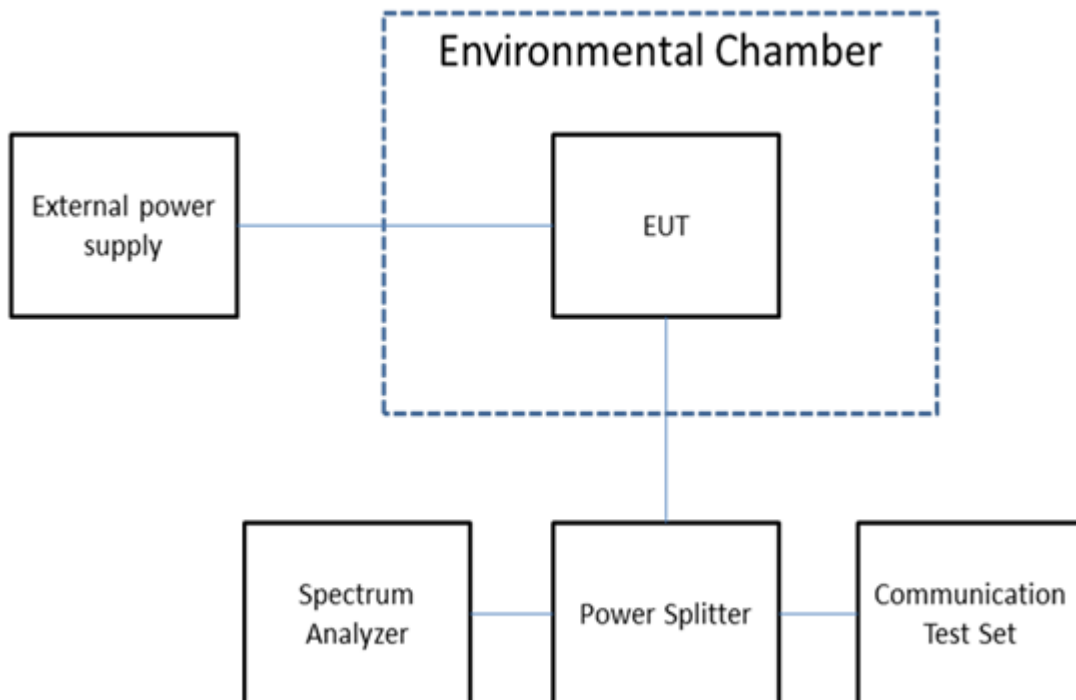

3.7.4 TEST DEVIATION

No deviation.

3.7.5 TEST RESULTS

Please refer to the APPENDIX I.

4. LIST OF MEASUREMENT EQUIPMENTS

Main Test Equipment					
No.	Equipment Name	Manufacturer	Model	Calibrated date	Calibrated until
1	DC Power Supply	Keysight	E3642A	2021/11/10	2022/11/09
2	Wideband Radio Communication Tester	R & S	CMW 500	2021/11/03	2022/11/02
3	MXA Signal Analyzer	Keysight	N9020B	2021/11/10	2022/11/09
4	Programmable Temperature & Humidity Chamber	ETMOA	NTH1100-30A	2021/11/10	2022/11/09
5	Temperature&Humidity Recorder	Anymetre	JR900	2021/11/10	2022/11/09
6	Integral Antenna	SCHWARZBECK	VULB9163	2021/11/10	2022/11/09
7	Loop Antenna	SCHWARZBECK	FMZB1519B	2021/11/10	2022/11/09
8	Horn Antenna	SCHWARZBECK	BBHA 9170	2021/11/10	2022/11/09
9	Double Ridged Broadband Horn Antenna	SCHWARZBECK	BBHA 9120D	2021/11/10	2022/11/09
10	Spectrum Analyzer	R & S	FSV30	2021/11/10	2022/11/09
11	EMI Receiver	R & S	ESR	2021/11/10	2022/11/09
12	Broadband amplifier	SCHWARZBECK	BBV9718	2021/11/10	2022/11/09
13	Broadband amplifier	SCHWARZBECK	BBV9721	2021/11/10	2022/11/09
14	Anechoic Chamber	ZHONGSHUO	FSAC318	2021/07/17	2024/07/16
15	RF Cable	Top Precision	BLU18A-Sm-2m	2021/11/10	2022/11/09
16	RF Cable	Top Precision	BLU18A-Sm-2m	2021/11/10	2022/11/09
17	RF Cable	ZDECL	ZT40-2.92J-6M	2021/11/10	2022/11/09
18	Band Reject Filter Group	Tonscend	JS0806-F	NA	NA

Software Information			
Test Item	Software Name	Manufacturer	Version
RSE	EZ-EMC	EZ-EMC	TW-03A2
Conducted RF	JS1120 RF Test System	Shenzhen JS tonskend co., Ltd	2.6.9.0826

Remark: "N/A" denotes no model name, serial no. or calibration specified.
 Except * item, all calibration period of equipment list is one year.
 "*" calibration period of equipment list is three year.

APPENDIX A - OUTPUT POWER

Output Power(dBm)

LTE Band / BW	Channel / Frequency (MHz)	RB Size	RB Offset	Index	Conducted Power (dBm)	RB Size	RB Offset	Index	Conducted Power (dBm)
					QPSK				16QAM
4 / 1.4MHz	19957 / 1710.7	1	0	0	21.19	1	0	0	20.11
		6	0	0	18.91	5	0	0	19.00
	20175 / 1732.5	1	0	0	20.17	1	0	0	19.98
		6	0	0	18.79	5	0	0	18.64
	20393 / 1754.3	1	5	0	19.72	1	5	0	19.64
		6	0	0	19.28	5	0	0	19.25
4 / 3MHz	19965 / 1711.5	1	0	0	20.29	1	0	0	19.71
		6	0	0	18.60	5	0	0	18.38
	20175 / 1732.5	1	0	0	20.66	1	0	0	19.61
		6	0	0	18.43	5	0	0	18.26
	20385 / 1753.5	1	5	1	20.25	1	5	1	19.39
		6	0	1	18.74	5	0	1	18.87
4 / 5MHz	19975 / 1712.5	1	0	0	21.14	1	0	0	20.82
		6	0	0	19.79	5	0	0	19.78
	20175 / 1732.5	1	0	0	21.13	1	0	0	20.85
		6	0	0	19.68	5	0	0	19.63
	20375 / 1752.5	1	5	0	21.51	1	5	0	21.49
		6	0	3	19.60	5	0	3	19.56
4 / 10MHz	20000 / 1715	1	0	3	20.40	1	0	3	20.38
		4	0	0	21.06	5	0	0	21.10
	20175 / 1732.5	1	0	0	21.03	1	0	0	21.01
		4	0	0	20.95	5	0	0	20.73
	20350 / 1750	1	5	7	20.46	1	5	7	20.41
		4	2	7	20.55	4	2	7	20.30
4 / 15MHz	20025 / 1717.5	1	0	0	21.22	1	0	0	21.01
		6	0	0	20.95	6	0	0	21.08
	20175 / 1732.5	1	0	0	21.08	1	0	0	20.89
		6	0	0	20.87	6	0	0	20.92
	20325 / 1747.5	1	5	11	20.48	1	5	11	20.25
		6	0	11	20.51	6	0	11	20.49
4 / 20MHz	20050 / 1720	1	0	0	20.67	1	0	0	20.78
		6	0	0	20.93	6	0	0	20.87
	20175 / 1732.5	1	0	0	21.05	1	0	0	20.91
		6	0	0	20.95	6	0	0	20.83
	20300 / 1745	1	5	15	20.46	1	5	15	20.21
		6	0	15	20.42	6	0	15	20.41

LTE Band / BW	Channel / Frequency (MHz)	RB Size	RB Offset	Index	Conducted Power (dBm)	RB Size	RB Offset	Index	Conducted Power (dBm)
					QPSK				16QAM
12 / 1.4MHz	23017 / 699.7	1	0	0	20.98	1	0	0	19.76
		6	0	0	18.62	5	0	0	18.57
	23095 / 707.5	1	0	0	20.24	1	0	0	19.54
		6	0	0	18.43	5	0	0	18.35
	23173 / 715.3	1	5	0	20.69	1	5	0	19.53
		6	0	0	18.69	5	0	0	19.75
12 / 3MHz	23025 / 700.5	1	0	0	20.61	1	0	0	19.37
		6	0	0	18.55	5	0	0	18.49
	23095 / 707.5	1	0	0	20.47	1	0	0	19.13
		6	0	0	18.39	5	0	0	18.25
	23165 / 714.5	1	5	1	20.88	1	5	1	19.41
		6	0	1	18.61	5	0	1	18.57
12 / 5MHz	23035 / 701.5	1	0	3	20.54	1	0	3	20.41
		6	0	0	19.59	5	0	0	19.65
	23095 / 707.5	1	0	0	20.69	1	0	0	21.10
		6	0	0	19.28	5	0	0	19.53
	23155 / 713.5	1	5	0	21.00	1	5	0	20.75
		6	0	3	19.14	5	0	3	19.09
12 / 10MHz	23060 / 704	1	0	3	20.48	1	0	3	20.33
		4	0	0	20.65	5	0	0	20.30
	23095 / 707.5	1	0	0	20.87	1	0	0	20.76
		4	0	0	20.56	5	0	0	20.18
	23130 / 711	1	5	4	20.21	1	5	4	19.97
		4	2	7	19.85	4	2	7	19.81

LTE Band / BW	Channel / Frequency (MHz)	RB Size	RB Offset	Index	Conducted Power (dBm)	RB Size	RB Offset	Index	Conducted Power (dBm)
					QPSK				16QAM
13 / 5MHz	23205 / 779.5	1	0	0	21.36	1	0	0	21.20
		6	0	0	20.08	5	0	0	20.21
	23230 / 782	1	0	0	21.35	1	0	0	21.05
		6	0	0	20.00	5	0	0	20.13
	23255 / 784.5	1	5	3	20.63	1	5	3	20.25
		6	0	3	19.38	5	0	3	19.35
13 / 10MHz	23230 / 782	1	0	0	20.89	1	0	0	20.74
		4	0	0	20.53	5	0	0	20.03

LTE Band / BW	Channel / Frequency (MHz)	RB Size	RB Offset	Index	Conducted Power (dBm)	RB Size	RB Offset	Index	Conducted Power (dBm)
					QPSK				16QAM
66 / 1.4MHz	131979 / 1710.7	1	0	0	21.36	1	0	0	20.56
		6	0	0	19.07	5	0	0	19.12
	132322 / 1745	1	0	0	21.10	1	0	0	20.08
		6	0	0	19.16	5	0	0	18.79
	132665 / 1779.3	1	5	0	21.52	1	5	0	20.46
		6	0	0	19.63	5	0	0	19.39
66 / 3MHz	131987 / 1711.5	1	0	0	21.29	1	0	0	19.94
		6	0	0	19.14	5	0	0	19.29
	132322 / 1745	1	0	0	21.10	1	0	0	19.98
		6	0	0	19.22	5	0	0	19.30
	132657 / 1778.5	1	5	1	21.47	1	5	1	20.51
		6	0	1	19.68	5	0	1	19.38
66 / 5MHz	131997 / 1712.5	1	0	3	20.38	1	0	3	20.24
		6	0	0	20.21	5	0	0	20.20
	132322 / 1745	1	0	0	21.44	1	0	0	21.23
		6	0	0	20.23	5	0	0	20.21
	132647 / 1777.5	1	5	0	21.98	1	5	0	21.61
		6	0	3	19.61	5	0	3	19.78
66 / 10MHz	132022 / 1715	1	0	3	20.31	1	0	3	20.27
		4	0	0	21.23	5	0	0	20.78
	132322 / 1745	1	0	0	21.37	1	0	0	21.18
		4	0	0	21.17	5	0	0	20.82
	132622 / 1775	1	5	4	20.34	1	5	4	20.07
		4	2	7	20.33	4	2	7	19.81
66 / 15MHz	132047 / 1717.5	1	0	3	20.49	1	0	3	20.18
		6	0	0	21.21	6	0	0	21.26
	132322 / 1745	1	0	0	21.46	1	0	0	21.19
		6	0	0	21.11	6	0	0	21.23
	132597 / 1772.5	1	5	8	20.44	1	5	8	19.97
		6	0	11	20.32	6	0	11	20.30
66 / 20MHz	132072 / 1720	1	0	3	20.45	1	0	3	20.27
		6	0	0	21.18	6	0	0	21.27
	132322 / 1745	1	0	0	21.33	1	0	0	21.10
		6	0	0	21.09	6	0	0	21.21
	132572 / 1770	1	5	12	20.11	1	5	12	20.03
		6	0	15	20.14	6	0	15	20.11

LTE Band / BW	Channel / Frequency (MHz)	RB Size	RB Offset	Index	Conducted Power (dBm)	RB Size	RB Offset	Index	Conducted Power (dBm)
					QPSK				16QAM
85 / 5MHz	134027 / 700.5	1	0	0	20.65	1	0	0	20.93
		6	0	0	19.29	5	0	0	19.37
	134092 / 707	1	0	0	20.51	1	0	0	20.81
		6	0	0	19.23	5	0	0	19.47
	134157 / 713.5	1	5	3	20.66	1	5	3	20.60
		6	0	3	19.57	5	0	3	19.56
85 / 10MHz	132052 / 703	1	0	0	20.64	1	0	0	20.88
		4	0	0	20.52	5	0	0	20.66
	134092 / 707	1	0	0	20.57	1	0	0	20.79
		4	0	0	20.35	5	0	0	20.58
	134132 / 711	1	5	0	20.45	1	5	0	20.60
		4	2	0	20.23	4	2	0	20.34

EIRP (dBm)

LTE Band / BW	Channel / Frequency (MHz)	RB Size	RB Offset	Index	EIRP (dBm)	RB Size	RB Offset	Index	EIRP (dBm)
					QPSK				16QAM
4 / 1.4MHz	19957 / 1710.7	1	0	0	24.29	1	0	0	23.21
		6	0	0	22.01	5	0	0	22.10
	20175 / 1732.5	1	0	0	23.27	1	0	0	23.08
		6	0	0	21.89	5	0	0	21.74
	20393 / 1754.3	1	5	0	22.82	1	5	0	22.74
		6	0	0	22.38	5	0	0	22.35
4 / 3MHz	19965 / 1711.5	1	0	0	23.39	1	0	0	22.81
		6	0	0	21.70	5	0	0	21.48
	20175 / 1732.5	1	0	0	23.76	1	0	0	22.71
		6	0	0	21.53	5	0	0	21.36
	20385 / 1753.5	1	5	1	23.35	1	5	1	22.49
		6	0	1	21.84	5	0	1	21.97
4 / 5MHz	19975 / 1712.5	1	0	0	24.24	1	0	0	23.92
		6	0	0	22.89	5	0	0	22.88
	20175 / 1732.5	1	0	0	24.23	1	0	0	23.95
		6	0	0	22.78	5	0	0	22.73
	20375 / 1752.5	1	5	0	24.61	1	5	0	24.59
		6	0	3	22.70	5	0	3	22.66
4 / 10MHz	20000 / 1715	1	0	3	23.50	1	0	3	23.48
		4	0	0	24.16	5	0	0	24.20
	20175 / 1732.5	1	0	0	24.13	1	0	0	24.11
		4	0	0	24.05	5	0	0	23.83
	20350 / 1750	1	5	7	23.56	1	5	7	23.51
		4	2	7	23.65	4	2	7	23.40
4 / 15MHz	20025 / 1717.5	1	0	0	24.32	1	0	0	24.11
		6	0	0	24.05	6	0	0	24.18
	20175 / 1732.5	1	0	0	24.18	1	0	0	23.99
		6	0	0	23.97	6	0	0	24.02
	20325 / 1747.5	1	5	11	23.58	1	5	11	23.35
		6	0	11	23.61	6	0	11	23.59
4 / 20MHz	20050 / 1720	1	0	0	23.77	1	0	0	23.88
		6	0	0	24.03	6	0	0	23.97
	20175 / 1732.5	1	0	0	24.15	1	0	0	24.01
		6	0	0	24.05	6	0	0	23.93
	20300 / 1745	1	5	15	23.56	1	5	15	23.31
		6	0	15	23.52	6	0	15	23.51

LTE Band / BW	Channel / Frequency (MHz)	RB Size	RB Offset	Index	EIRP (dBm)	RB Size	RB Offset	Index	EIRP (dBm)
					QPSK				16QAM
66 / 1.4MHz	131979 / 1710.7	1	0	0	24.46	1	0	0	23.66
		6	0	0	22.17	5	0	0	22.22
	132322 / 1745	1	0	0	24.20	1	0	0	23.18
		6	0	0	22.26	5	0	0	21.89
	132665 / 1779.3	1	5	0	24.62	1	5	0	23.56
		6	0	0	22.73	5	0	0	22.49
66 / 3MHz	131987 / 1711.5	1	0	0	24.39	1	0	0	23.04
		6	0	0	22.24	5	0	0	22.39
	132322 / 1745	1	0	0	24.20	1	0	0	23.08
		6	0	0	22.32	5	0	0	22.40
	132657 / 1778.5	1	5	1	24.57	1	5	1	23.61
		6	0	1	22.78	5	0	1	22.48
66 / 5MHz	131997 / 1712.5	1	0	3	23.48	1	0	3	23.34
		6	0	0	23.31	5	0	0	23.30
	132322 / 1745	1	0	0	24.54	1	0	0	24.33
		6	0	0	23.33	5	0	0	23.31
	132647 / 1777.5	1	5	0	25.08	1	5	0	24.71
		6	0	3	22.71	5	0	3	22.88
66 / 10MHz	132022 / 1715	1	0	3	23.41	1	0	3	23.37
		4	0	0	24.33	5	0	0	23.88
	132322 / 1745	1	0	0	24.47	1	0	0	24.28
		4	0	0	24.27	5	0	0	23.92
	132622 / 1775	1	5	4	23.44	1	5	4	23.17
		4	2	7	23.43	4	2	7	22.91
66 / 15MHz	132047 / 1717.5	1	0	3	23.59	1	0	3	23.28
		6	0	0	24.31	6	0	0	24.36
	132322 / 1745	1	0	0	24.56	1	0	0	24.29
		6	0	0	24.21	6	0	0	24.33
	132597 / 1772.5	1	5	8	23.54	1	5	8	23.07
		6	0	11	23.42	6	0	11	23.40
66 / 20MHz	132072 / 1720	1	0	3	23.55	1	0	3	23.37
		6	0	0	24.28	6	0	0	24.37
	132322 / 1745	1	0	0	24.43	1	0	0	24.20
		6	0	0	24.19	6	0	0	24.31
	132572 / 1770	1	5	12	23.21	1	5	12	23.13
		6	0	15	23.24	6	0	15	23.21

ERP (dBm)

LTE Band / BW	Channel / Frequency (MHz)	RB Size	RB Offset	Index	ERP (dBm)	RB Size	RB Offset	Index	ERP (dBm)
					QPSK				16QAM
12 / 1.4MHz	23017 / 699.7	1	0	0	20.43	1	0	0	19.21
		6	0	0	18.07	5	0	0	18.02
	23095 / 707.5	1	0	0	19.69	1	0	0	18.99
		6	0	0	17.88	5	0	0	17.80
	23173 / 715.3	1	5	0	20.14	1	5	0	18.98
		6	0	0	18.14	5	0	0	19.20
12 / 3MHz	23025 / 700.5	1	0	0	20.06	1	0	0	18.82
		6	0	0	18.00	5	0	0	17.94
	23095 / 707.5	1	0	0	19.92	1	0	0	18.58
		6	0	0	17.84	5	0	0	17.70
	23165 / 714.5	1	5	1	20.33	1	5	1	18.86
		6	0	1	18.06	5	0	1	18.02
12 / 5MHz	23035 / 701.5	1	0	3	19.99	1	0	3	19.86
		6	0	0	19.04	5	0	0	19.10
	23095 / 707.5	1	0	0	20.14	1	0	0	20.55
		6	0	0	18.73	5	0	0	18.98
	23155 / 713.5	1	5	0	20.45	1	5	0	20.20
		6	0	3	18.59	5	0	3	18.54
12 / 10MHz	23060 / 704	1	0	3	19.93	1	0	3	19.78
		4	0	0	20.10	5	0	0	19.75
	23095 / 707.5	1	0	0	20.32	1	0	0	20.21
		4	0	0	20.01	5	0	0	19.63
	23130 / 711	1	5	4	19.66	1	5	4	19.42
		4	2	7	19.30	4	2	7	19.26

LTE Band / BW	Channel / Frequency (MHz)	RB Size	RB Offset	Index	ERP (dBm)	RB Size	RB Offset	Index	ERP (dBm)
					QPSK				16QAM
13 / 5MHz	23205 / 779.5	1	0	0	20.81	1	0	0	20.65
		6	0	0	19.53	5	0	0	19.66
	23230 / 782	1	0	0	20.80	1	0	0	20.50
		6	0	0	19.45	5	0	0	19.58
	23255 / 784.5	1	5	3	20.08	1	5	3	19.70
		6	0	3	18.83	5	0	3	18.80
13 / 10MHz	23230 / 782	1	0	0	20.34	1	0	0	20.19
		4	0	0	19.98	5	0	0	19.48

LTE Band / BW	Channel / Frequency (MHz)	RB Size	RB Offset	Index	ERP (dBm)	RB Size	RB Offset	Index	ERP (dBm)
					QPSK				16QAM
85 / 5MHz	134027 / 700.5	1	0	0	20.10	1	0	0	20.38
		6	0	0	18.74	5	0	0	18.82
	134092 / 707	1	0	0	19.96	1	0	0	20.26
		6	0	0	18.68	5	0	0	18.92
	134157 / 713.5	1	5	3	20.11	1	5	3	20.05
		6	0	3	19.02	5	0	3	19.01
85 / 10MHz	132052 / 703	1	0	0	20.09	1	0	0	20.33
		4	0	0	19.97	5	0	0	20.11
	134092 / 707	1	0	0	20.02	1	0	0	20.24
		4	0	0	19.80	5	0	0	20.03
	134132 / 711	1	5	0	19.90	1	5	0	20.05
		4	2	0	19.68	4	2	0	19.79

APPENDIX B - OCCUPIED BANDWIDTH

LTE Band 4_1.4MHz					
Channel	Frequency (MHz)	99% Occupied Bandwidth (MHz)		26dB Bandwidth (MHz)	
		QPSK	16QAM	QPSK	16QAM
19957	1710.7	1.0958	0.9303	1.316	1.242
20175	1732.5	1.0911	0.9218	1.260	1.109
20393	1754.3	1.0828	0.9210	1.242	1.218

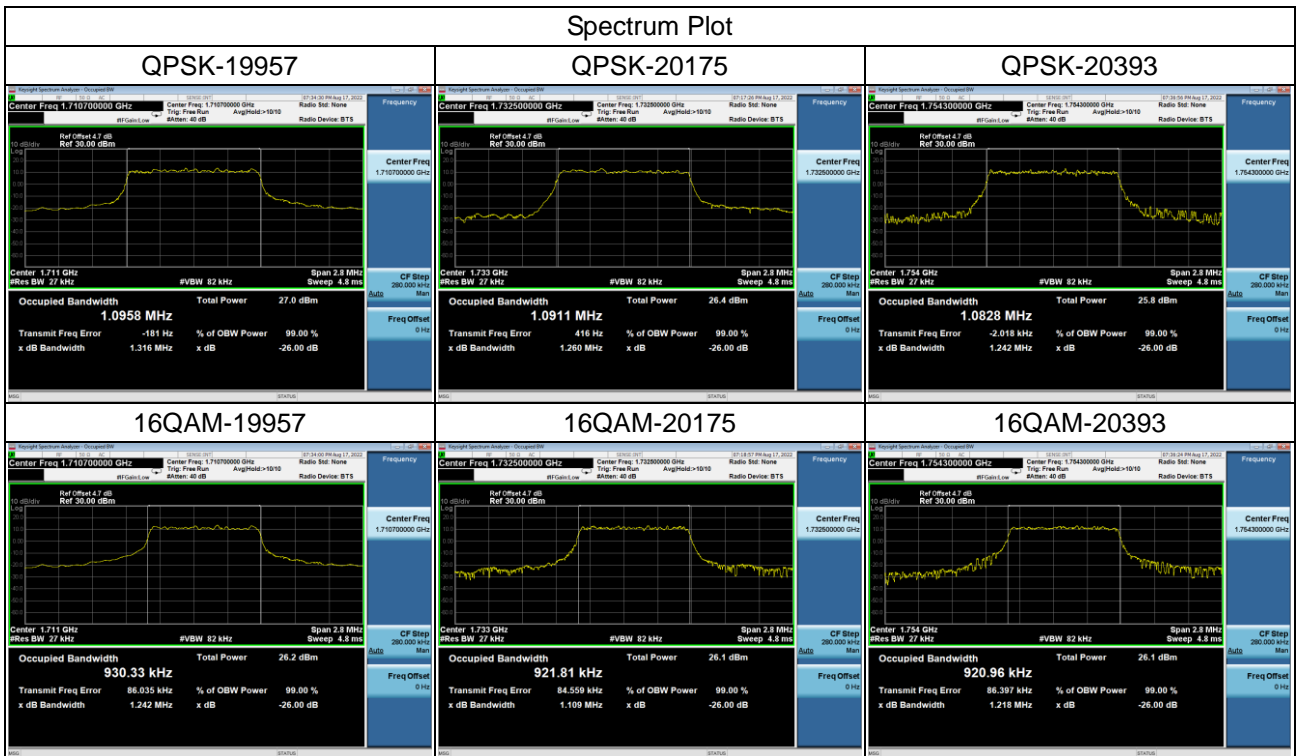

LTE Band 4_3MHz					
Channel	Frequency (MHz)	99% Occupied Bandwidth (MHz)		26dB Bandwidth (MHz)	
		QPSK	16QAM	QPSK	16QAM
19965	1711.5	1.0948	0.9297	1.267	1.220
20175	1732.5	1.0955	0.9273	1.270	1.301
20385	1753.5	1.0927	0.9280	1.272	1.204

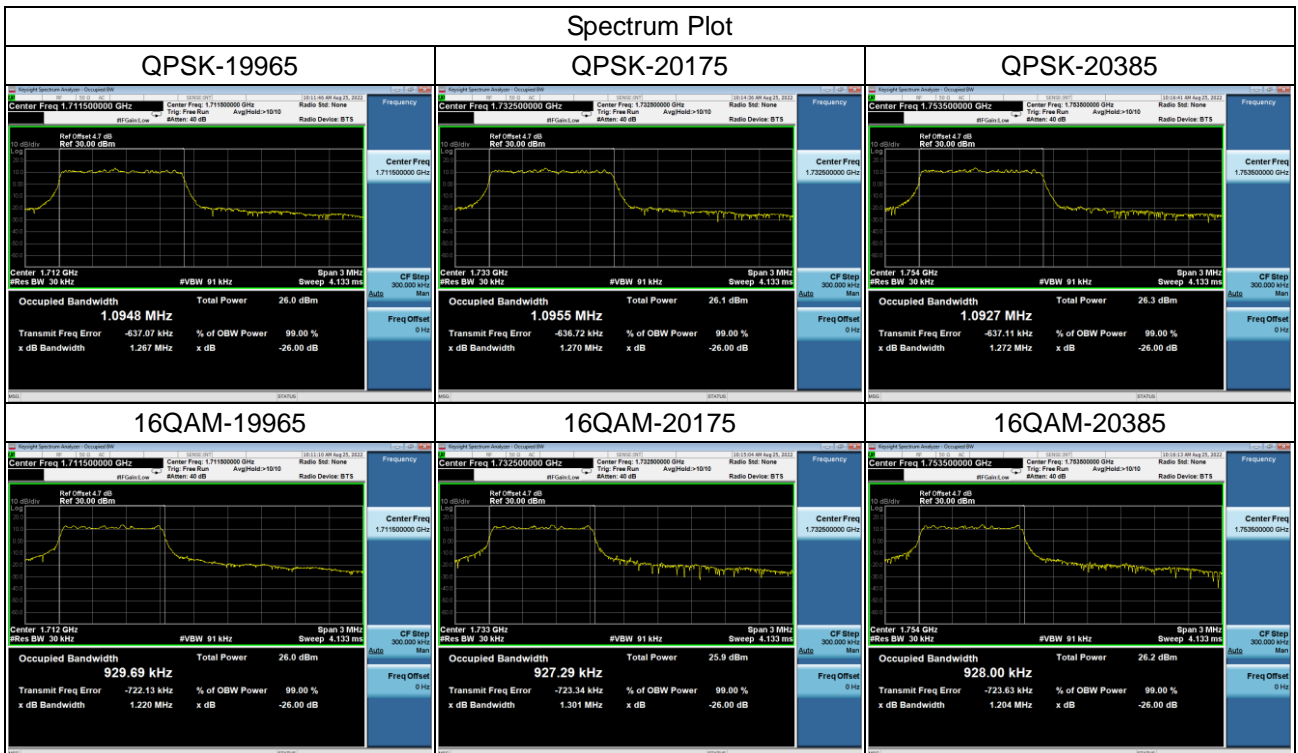

LTE Band 4_5MHz					
Channel	Frequency (MHz)	99% Occupied Bandwidth (MHz)		26dB Bandwidth (MHz)	
		QPSK	16QAM	QPSK	16QAM
19975	1712.5	1.1008	0.9234	1.326	1.144
20175	1732.5	1.0993	0.9219	1.337	1.147
20375	1752.5	1.0999	0.9217	1.319	1.146

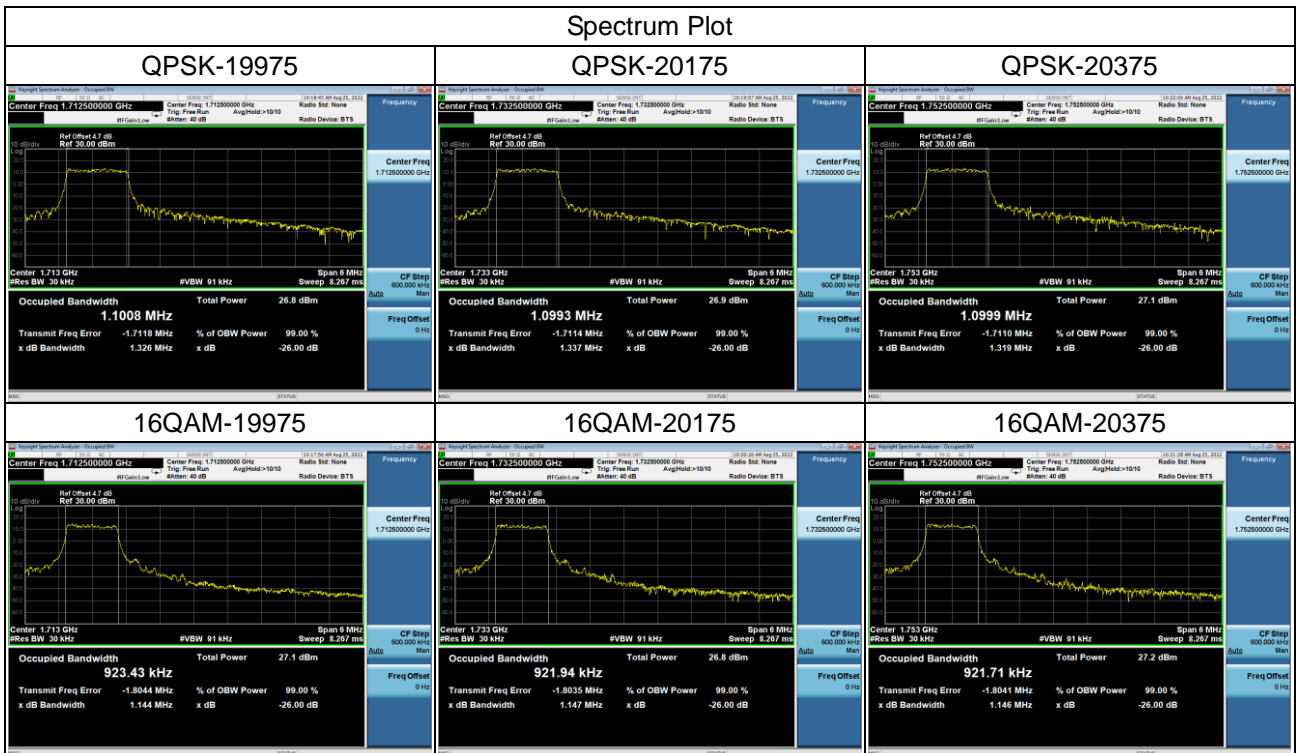

LTE Band 4_10MHz					
Channel	Frequency (MHz)	99% Occupied Bandwidth (MHz)		26dB Bandwidth (MHz)	
		QPSK	16QAM	QPSK	16QAM
20000	1715	1.0980	0.9398	1.313	1.201
20175	1732.5	1.0975	0.9352	1.317	1.194
20350	1715	1.0969	0.9379	1.328	1.187

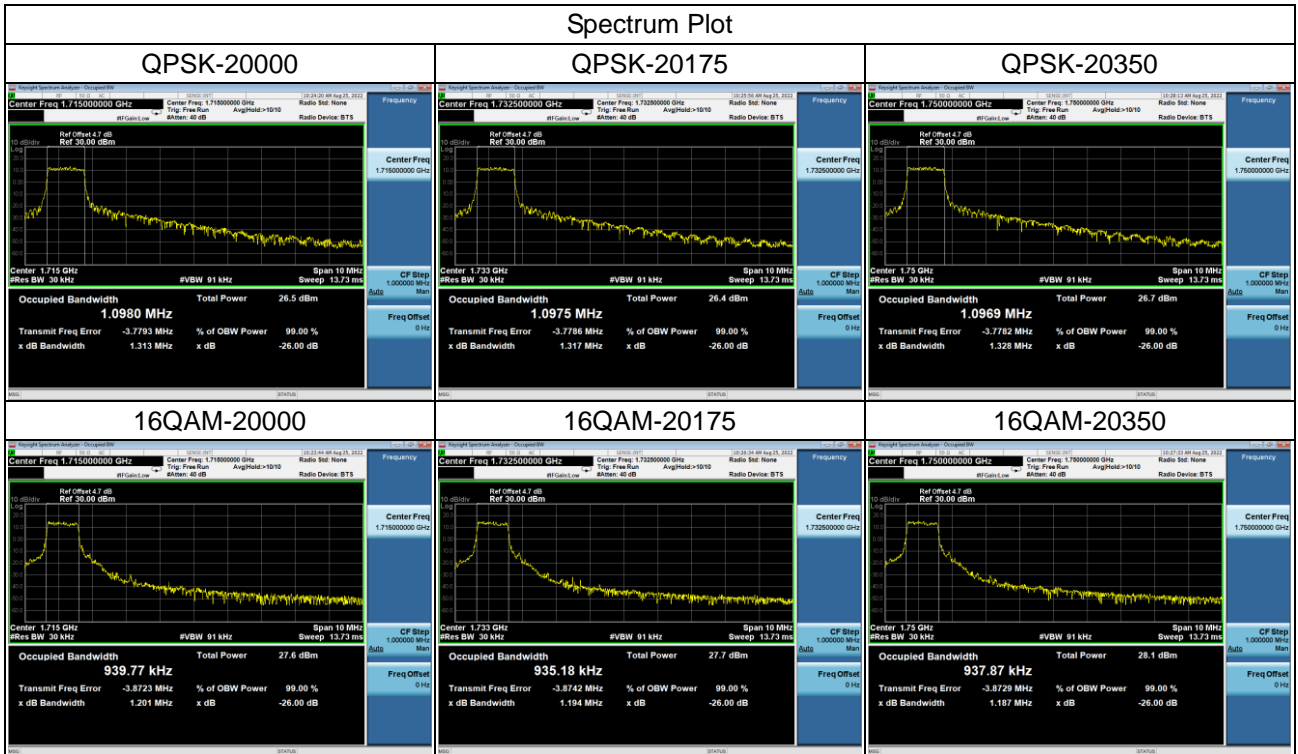

LTE Band 4_15MHz					
Channel	Frequency (MHz)	99% Occupied Bandwidth (MHz)		26dB Bandwidth (MHz)	
		QPSK	16QAM	QPSK	16QAM
20025	1717.5	1.1067	0.9342	1.290	1.175
20175	1732.5	1.0921	0.9355	1.307	1.201
20325	1747.5	1.0996	0.9306	1.317	1.226

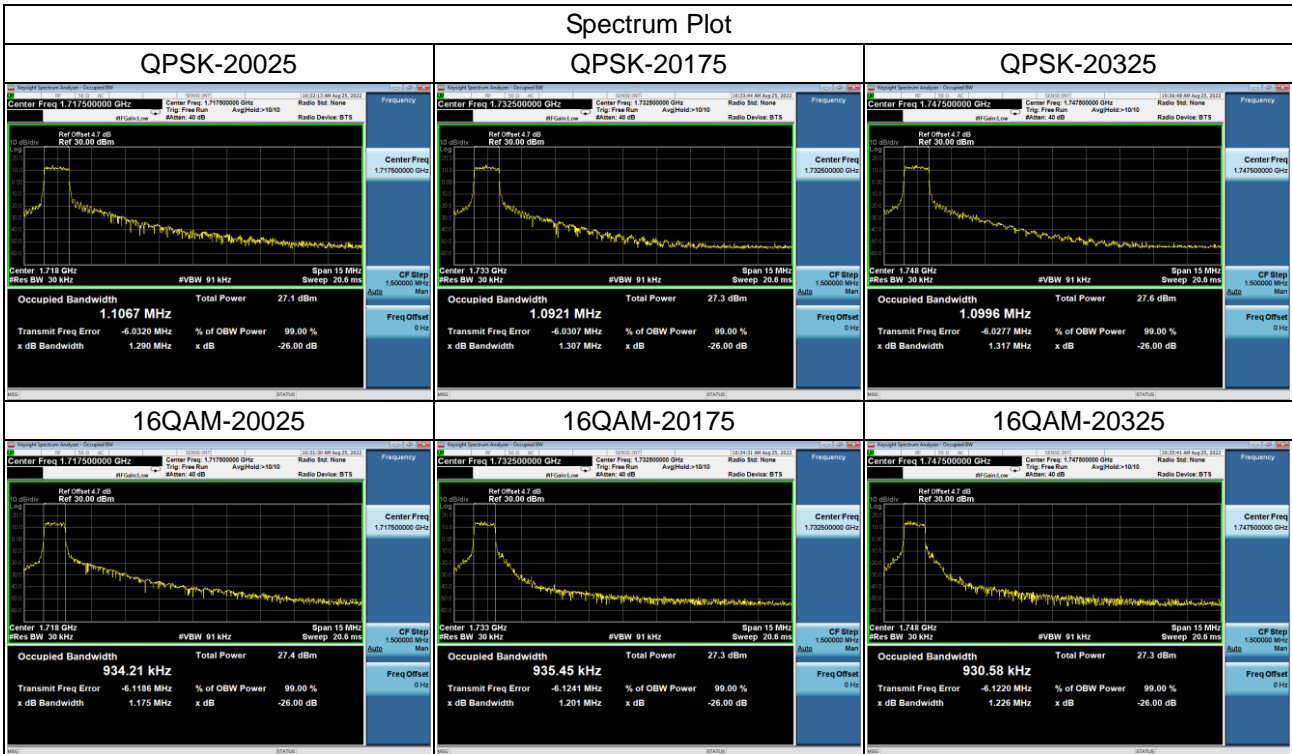

LTE Band 4_20MHz					
Channel	Frequency (MHz)	99% Occupied Bandwidth (MHz)		26dB Bandwidth (MHz)	
		QPSK	16QAM	QPSK	16QAM
20050	1720	1.1020	0.9292	1.328	1.183
20175	1732.5	1.0913	0.9304	1.277	1.184
20300	1740	1.1001	0.9286	1.306	1.189

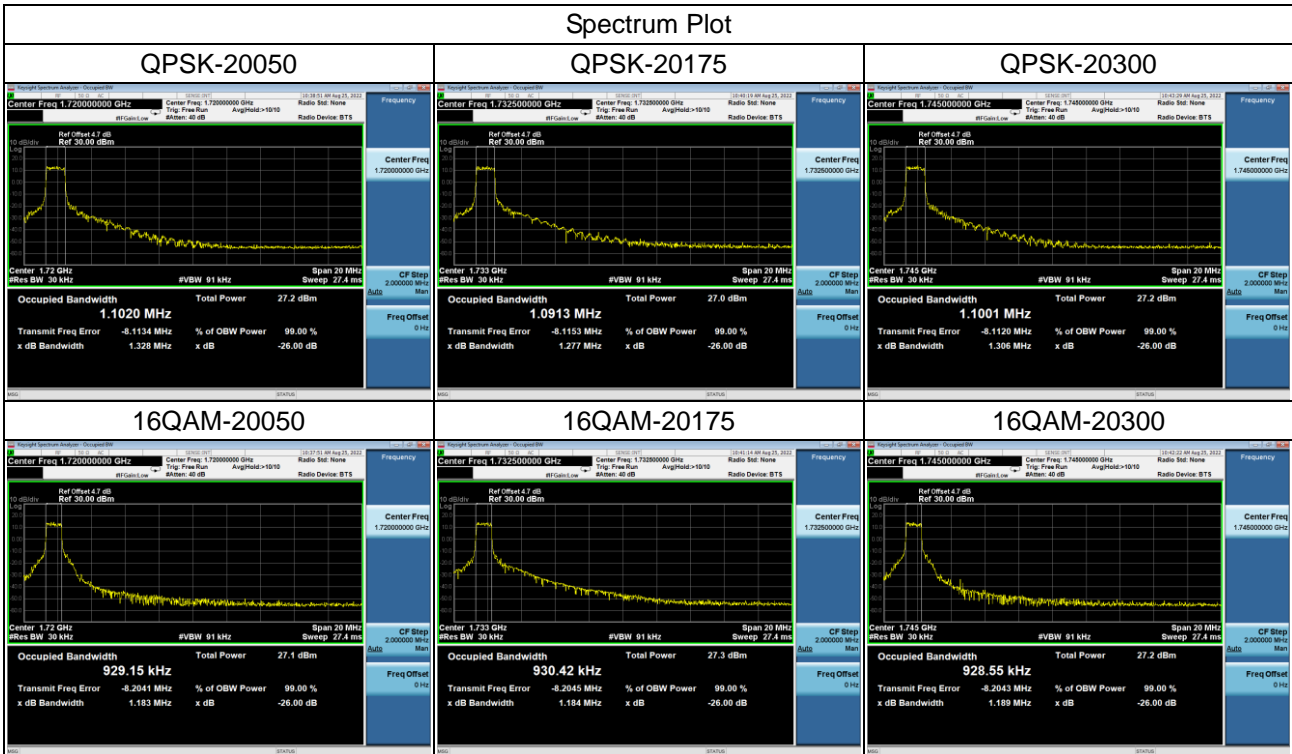

LTE Band 12_1.4MHz					
Channel	Frequency (MHz)	99% Occupied Bandwidth (MHz)		26dB Bandwidth (MHz)	
		QPSK	16QAM	QPSK	16QAM
23017	699.7	1.0926	0.9231	1.272	1.205
23095	707.5	1.0910	0.9229	1.246	1.215
23173	715.3	1.0938	0.9252	1.284	1.232

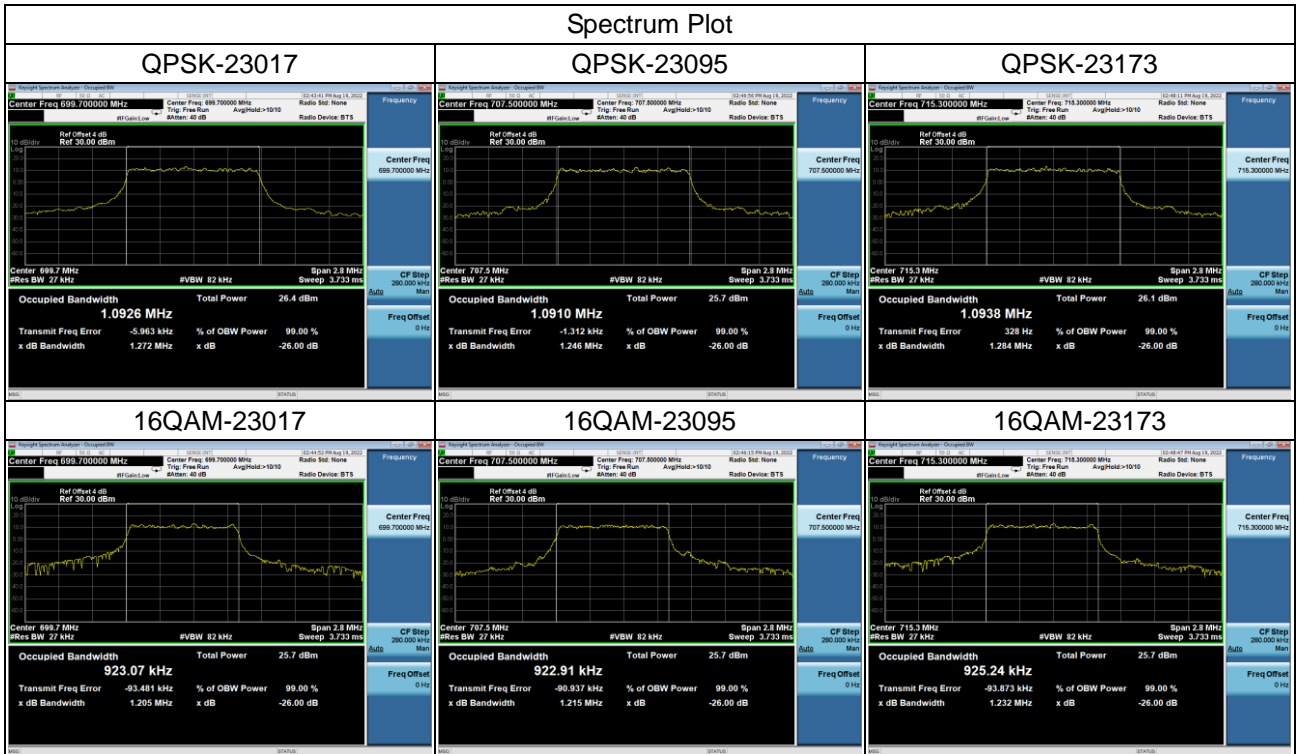

LTE Band 12_3MHz					
Channel	Frequency (MHz)	99% Occupied Bandwidth (MHz)		26dB Bandwidth (MHz)	
		QPSK	16QAM	QPSK	16QAM
23025	700.5	1.0938	0.9268	1.278	1.125
23095	707.5	1.1029	0.9259	1.282	1.263
23165	714.5	1.0970	0.9272	1.306	1.238

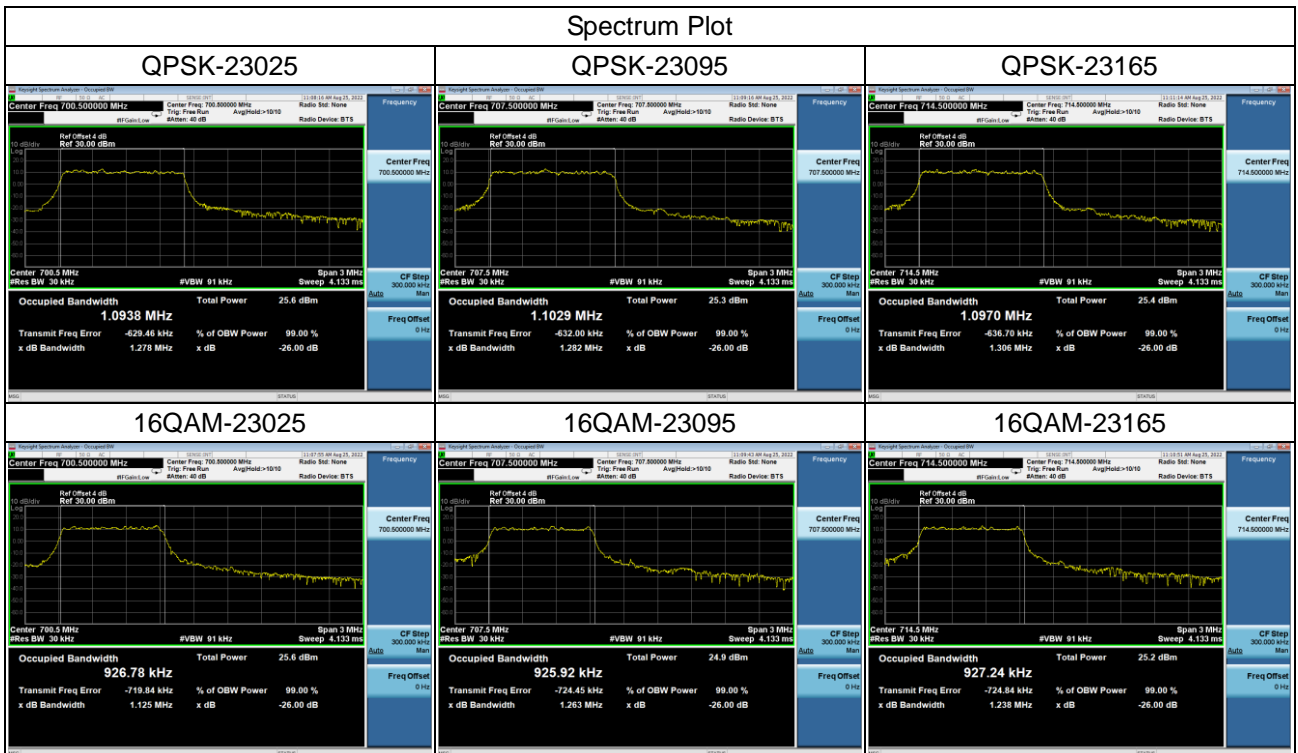

LTE Band 12_5MHz					
Channel	Frequency (MHz)	99% Occupied Bandwidth (MHz)		26dB Bandwidth (MHz)	
		QPSK	16QAM	QPSK	16QAM
23035	701.5	1.0970	0.9236	1.307	1.135
23095	707.5	1.0970	0.9234	1.319	1.132
23155	713.5	1.0970	0.9261	1.308	1.133

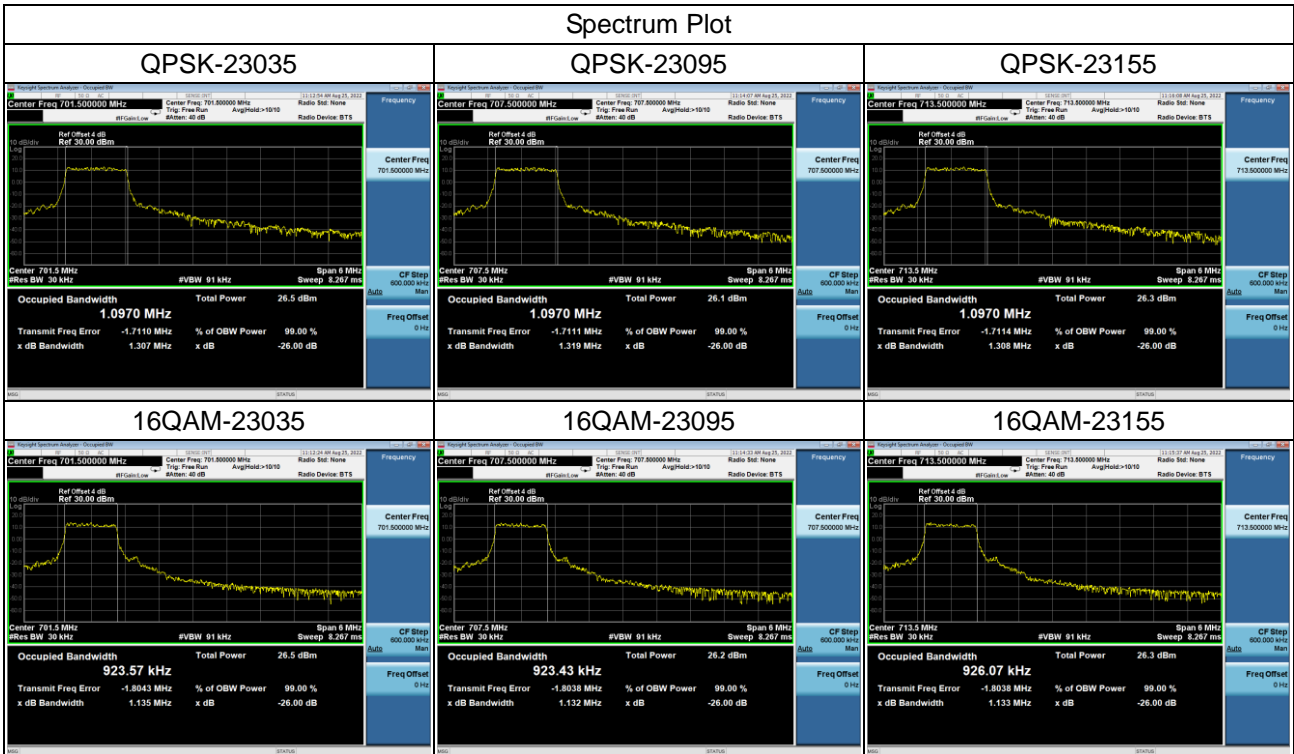

LTE Band 12_10MHz					
Channel	Frequency (MHz)	99% Occupied Bandwidth (MHz)		26dB Bandwidth (MHz)	
		QPSK	16QAM	QPSK	16QAM
23060	704.0	1.0931	0.9369	1.344	1.169
23095	707.5	1.0994	0.9404	1.321	1.176
23130	711.0	1.0969	0.9407	1.332	1.184

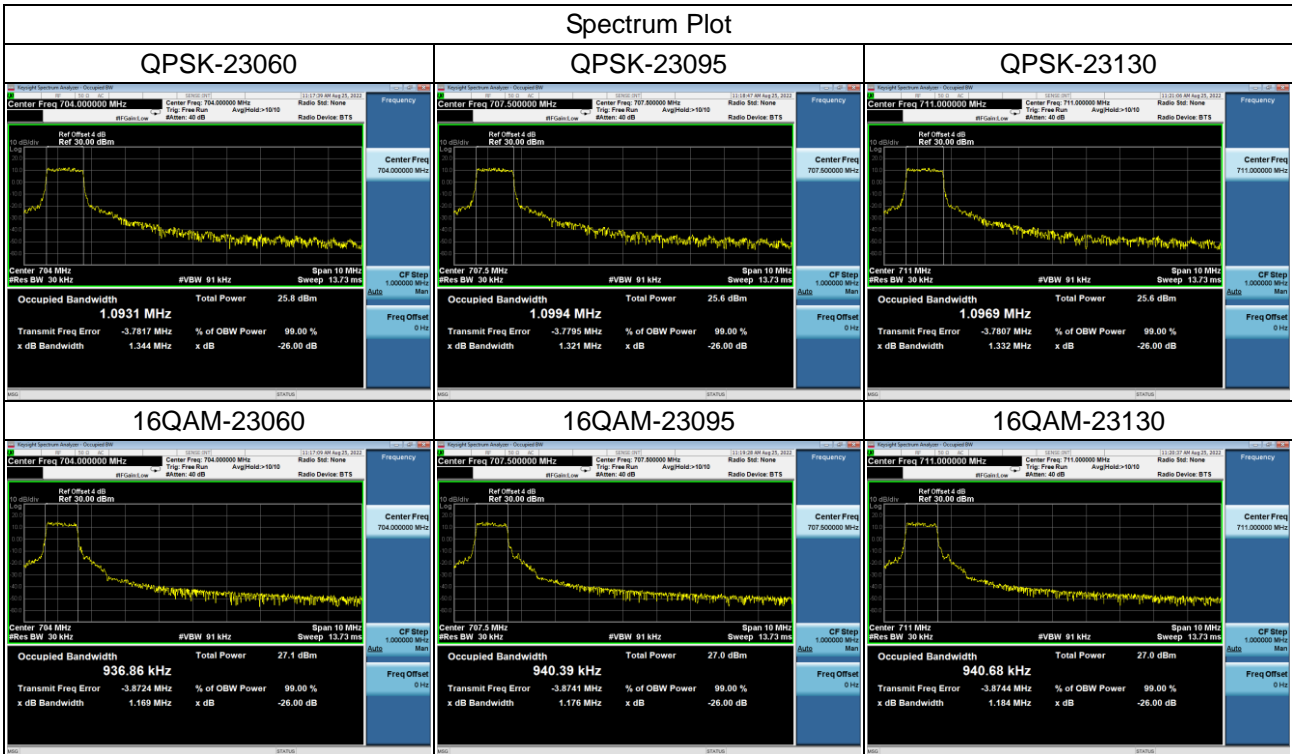

LTE Band 13_5MHz					
Channel	Frequency (MHz)	99% Occupied Bandwidth (MHz)		26dB Bandwidth (MHz)	
		QPSK	16QAM	QPSK	16QAM
23205	779.5	1.0994	0.9229	1.319	1.133
23230	782.0	1.0980	0.9217	1.312	1.131
23255	784.5	1.0995	0.9237	1.320	1.140

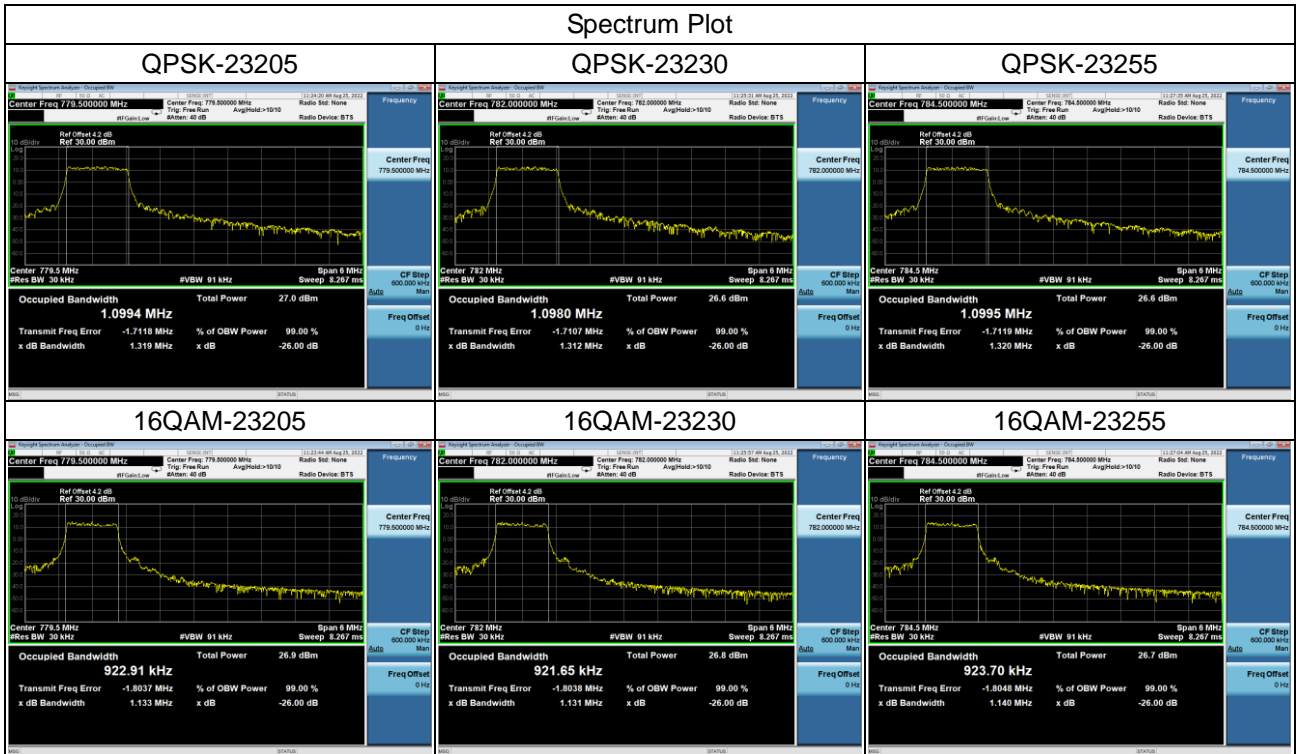

LTE Band 13_10MHz					
Channel	Frequency (MHz)	99% Occupied Bandwidth (MHz)		26dB Bandwidth (MHz)	
		QPSK	16QAM	QPSK	16QAM
23230	782.0	1.0982	0.9365	1.285	1.177

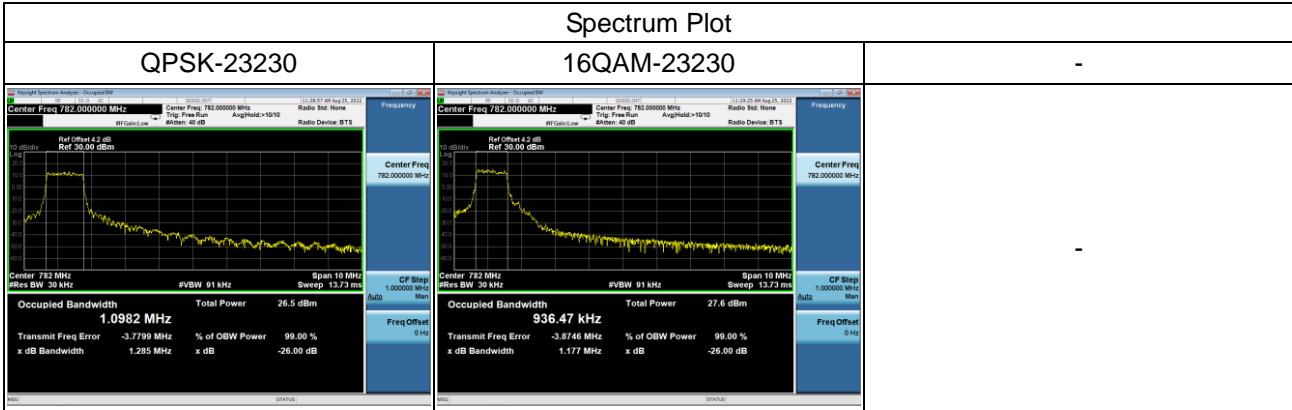

LTE Band 66_1.4MHz					
Channel	Frequency (MHz)	99% Occupied Bandwidth (MHz)		26dB Bandwidth (MHz)	
		QPSK	16QAM	QPSK	16QAM
131979	1710.7	1.0947	0.9203	1.263	1.178
132322	1745	1.0881	0.9236	1.260	1.216
132665	1779.3	1.0902	0.9238	1.264	1.134

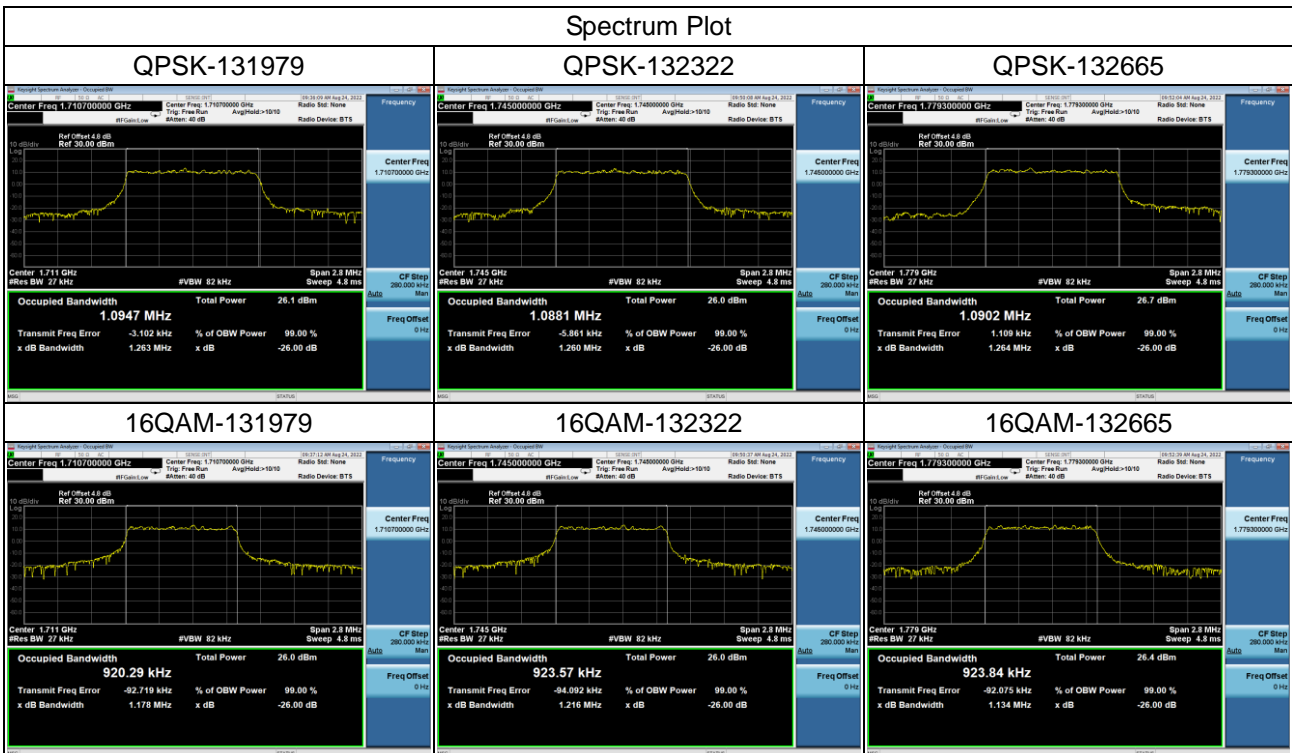

LTE Band 66_3MHz					
Channel	Frequency (MHz)	99% Occupied Bandwidth (MHz)		26dB Bandwidth (MHz)	
		QPSK	16QAM	QPSK	16QAM
131987	1711.5	1.0946	0.9260	1.269	1.217
132322	1745	1.0977	0.9307	1.266	1.220
132657	1778.5	1.0955	0.9313	1.271	1.230

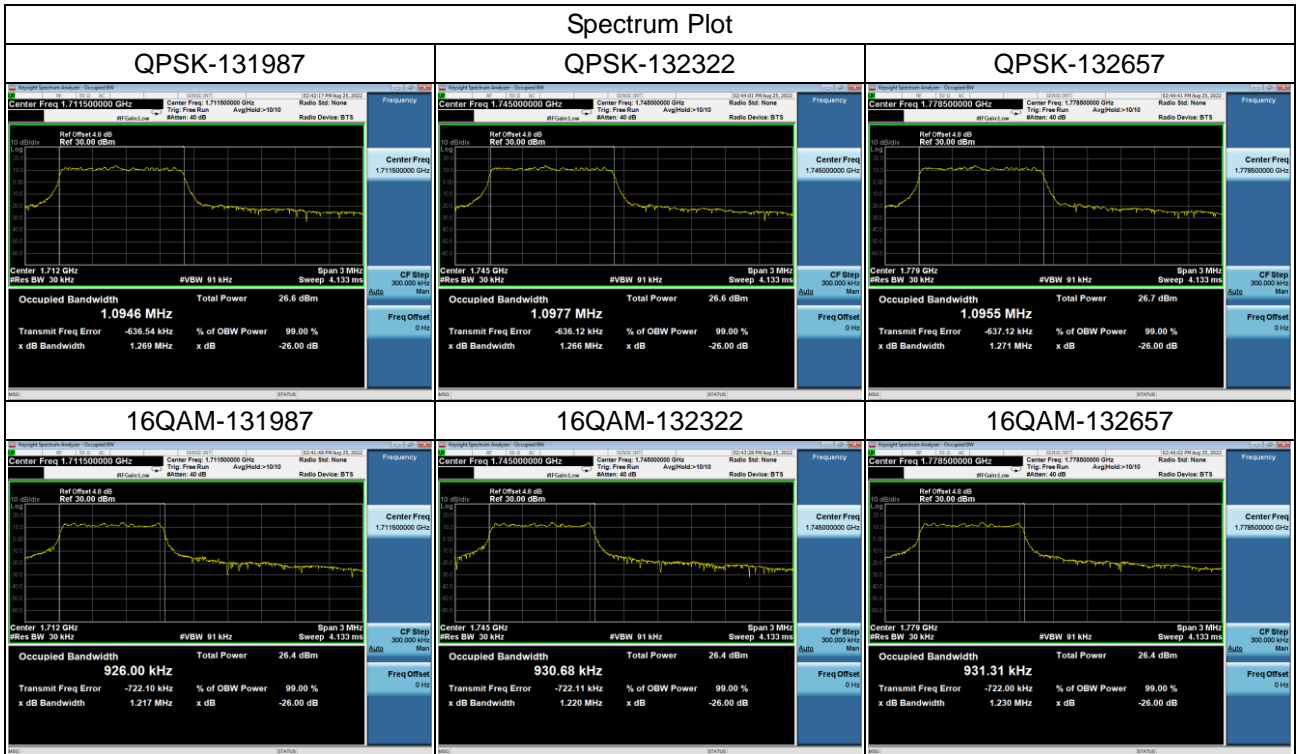

LTE Band 66_5MHz					
Channel	Frequency (MHz)	99% Occupied Bandwidth (MHz)		26dB Bandwidth (MHz)	
		QPSK	16QAM	QPSK	16QAM
131997	1712.5	1.0996	0.9226	1.324	1.153
132322	1745	1.0980	0.9238	1.324	1.131
132647	1777.5	1.0994	0.9240	1.325	1.148

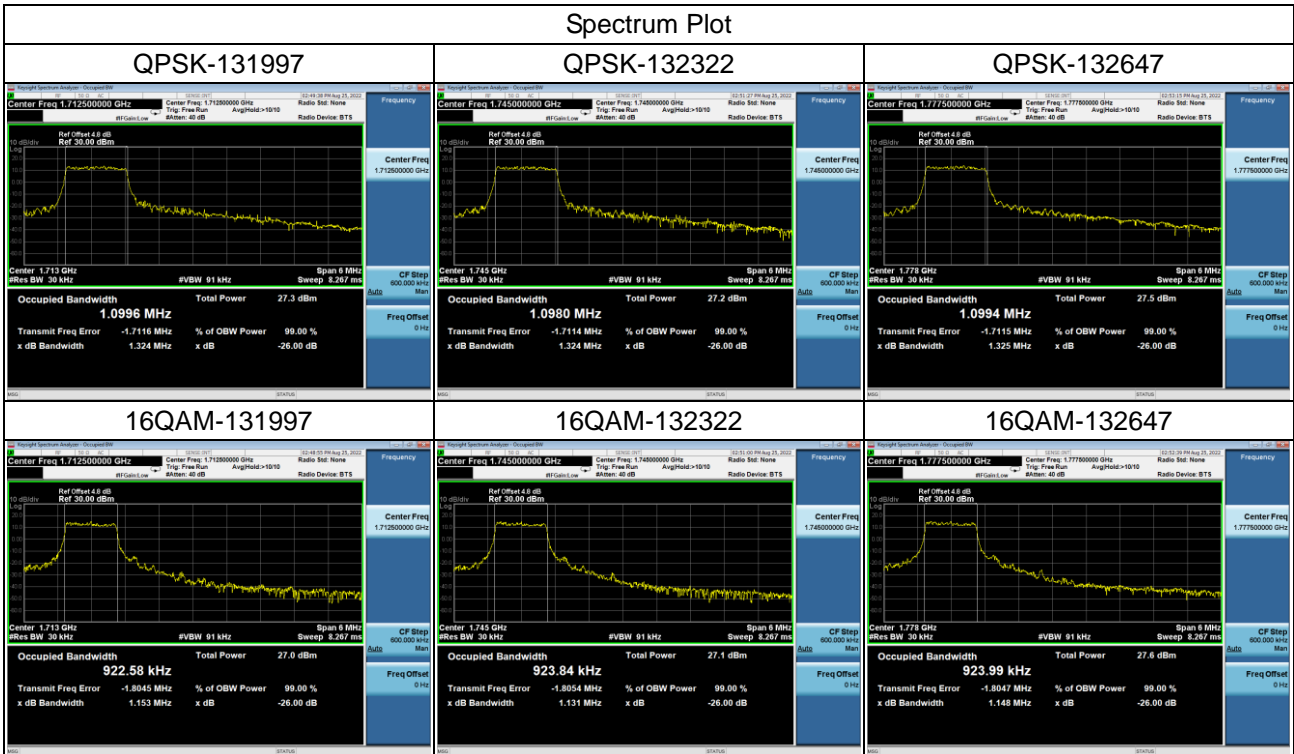

LTE Band 66_10MHz					
Channel	Frequency (MHz)	99% Occupied Bandwidth (MHz)		26dB Bandwidth (MHz)	
		QPSK	16QAM	QPSK	16QAM
132022	1715	1.0943	0.9416	1.269	1.178
132322	1745	1.0996	0.9242	1.282	1.134
132622	1775	1.0966	0.9383	1.304	1.185

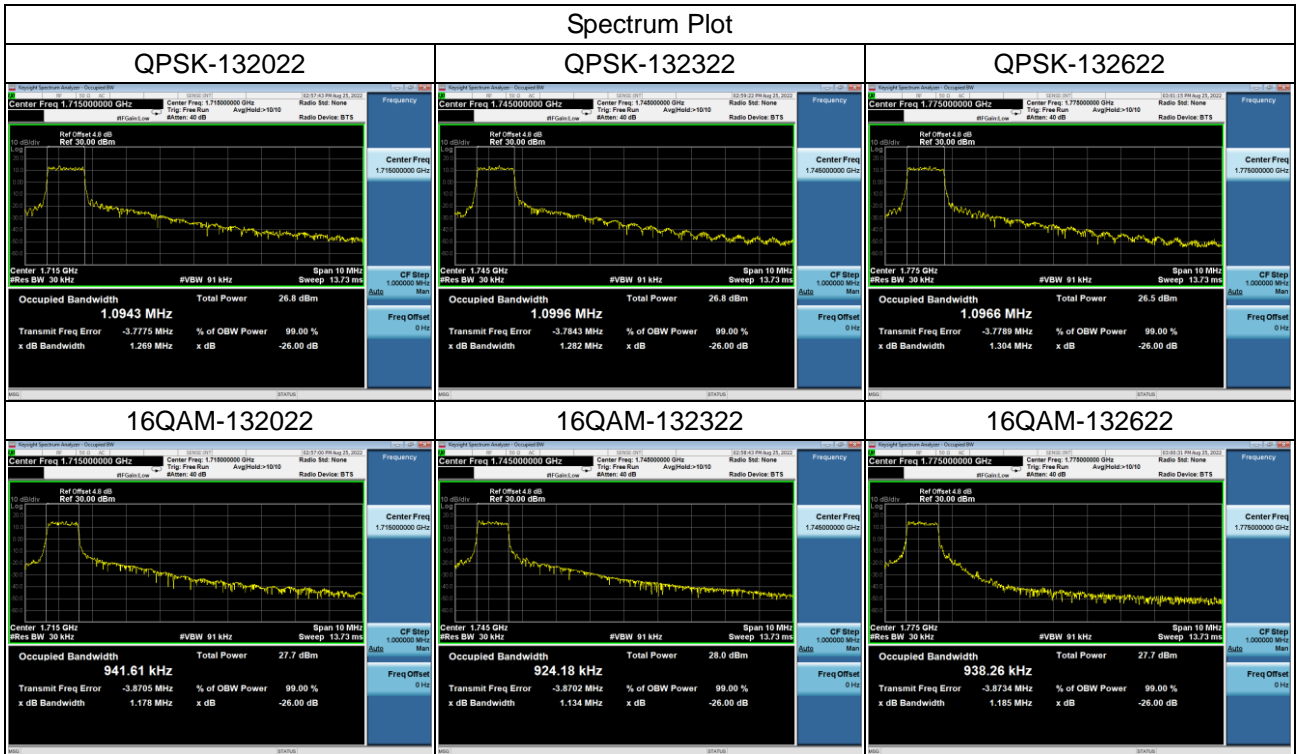

LTE Band 66_15MHz					
Channel	Frequency (MHz)	99% Occupied Bandwidth (MHz)		26dB Bandwidth (MHz)	
		QPSK	16QAM	QPSK	16QAM
132047	1717.5	1.0997	0.9343	1.316	1.332
132322	1745	1.0989	0.9313	1.309	1.154
132597	1772.5	1.1005	0.9285	1.316	1.143

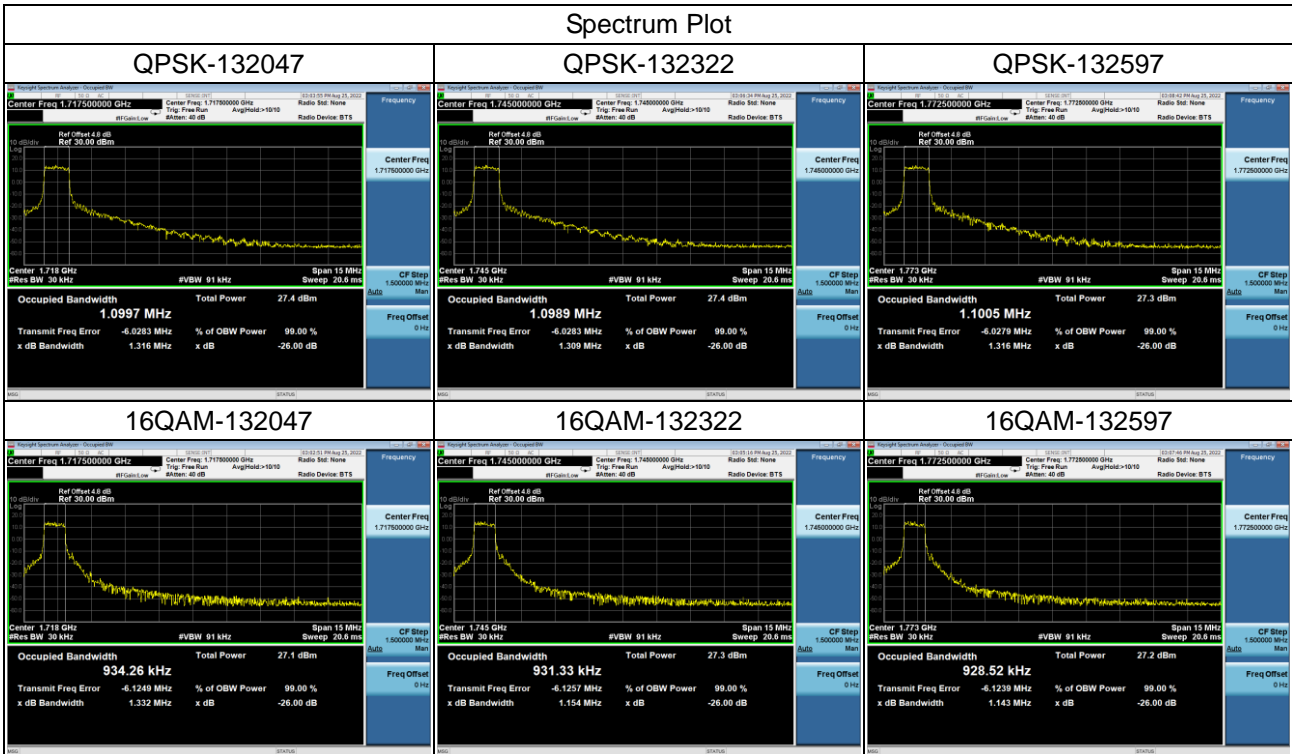

LTE Band 66_20MHz					
Channel	Frequency (MHz)	99% Occupied Bandwidth (MHz)		26dB Bandwidth (MHz)	
		QPSK	16QAM	QPSK	16QAM
132072	1720	1.1025	0.9289	1.311	1.200
132322	1745	1.1017	0.9319	1.296	1.198
132572	1770	1.1011	0.9269	1.310	1.132

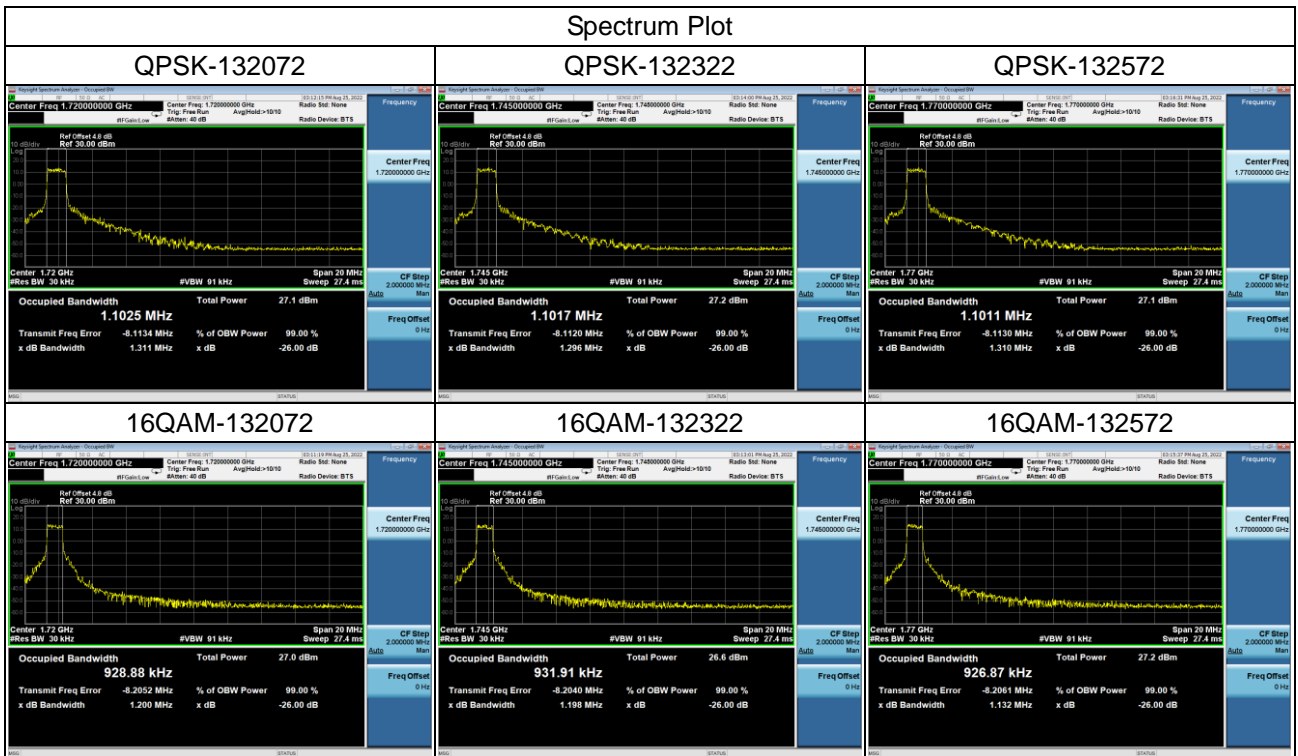

LTE Band 85_5MHz					
Channel	Frequency (MHz)	99% Occupied Bandwidth (MHz)		26dB Bandwidth (MHz)	
		QPSK	16QAM	QPSK	16QAM
134027	700.5	1.0956	0.9247	1.317	1.136
134092	707	1.0978	0.9233	1.309	1.137
134157	713.5	1.0969	0.9261	1.317	1.142

