



ELECTROMAGNETIC EMISSIONS COMPLIANCE REPORT

INTENTIONAL RADIATOR CERTIFICATION TO FCC PART 15 SUBPART C AND INDUSTRY CANADA RSS 247 REQUIREMENT

OF

Product Name: Here One
Brand Name: HERE01011
Model No.: HERE01011L
Model Difference: N/A
FCC ID: 2AF9A01011L
IC: 20747-01011L
Report No.: ER/2016/C0075
Issue Date: Jan. 11, 2017
FCC Rule Part: §15.247, Cat: DSS
IC Rule: RSS-247 issue 1 May 2015
Prepared for: Doppler Labs Inc.
 611 Broadway, Suite 523, New York, NY
 USA 10012
 SGS Taiwan Ltd.
Prepared by: Electronics & Communication Laboratory
 No.134, Wu Kung Road, New Taipei Industrial
 Park, Wuku District, New Taipei City,
 Taiwan 24803

		<p><i>Note: This report shall not be reproduced except in full, without the written approval of SGS Taiwan Ltd. This document may be altered or revised by SGS Taiwan Ltd. Personnel only, and shall be noted in the revision section of the document.</i></p>
---	---	---

Unless otherwise stated the results shown in this test report refer only to the sample(s) tested and such sample(s) are retained for 90 days only.

除非另有說明，此報告結果僅對測試之樣品負責，同時此樣品僅保留90天。本報告未經本公司書面許可，不可部份複製。

This document is issued by the Company subject to its General Conditions of Service printed overleaf, available on request or accessible at www.sgs.com/terms_and_conditions.htm and, for electronic format documents, subject to Terms and Conditions for Electronic Documents at www.sgs.com/terms_e-document.htm. Attention is drawn to the limitation of liability, indemnification and jurisdiction issues defined therein. Any holder of this document is advised that information contained hereon reflects the Company's findings at the time of its intervention only and within the limits of Client's instructions, if any. The Company's sole responsibility is to its Client and this document does not exonerate parties to a transaction from exercising all their rights and obligations under the transaction documents. This document cannot be reproduced except in full, without prior written approval of the Company. Any unauthorized alteration, forgery or falsification of the content or appearance of this document is unlawful and offenders may be prosecuted to the fullest extent of the law.

SGS Taiwan Ltd.

No.134,WuKungRoad,NewTaipeiIndustrialPark,WukuDistrict,NewTaipeiCity,Taiwan24803/新北市五股區新北產業園區五工路 134 號

台灣檢驗科技股份有限公司

t (886-2) 2299-3279

f (886-2) 2298-0488

www.tw.sgs.com

Member of SGS Group

VERIFICATION OF COMPLIANCE

Applicant: Doppler Labs Inc.
611 Broadway, Suite 523, New York, NY USA 10012

Product Name: Here One

Brand Name: HERE01011

Model No.: HERE01011L

Model Difference: N/A

FCC ID: 2AF9A01011L

IC : 20747-01011L

Report Number: ER/2016/C0075

Date of test: Dec. 20, 2016 ~ Jan. 04, 2017

Date of EUT Received: Dec. 20, 2016

We hereby certify that:

The above equipment was tested by SGS Taiwan Ltd. Electronics & Communication Laboratory The test data, data evaluation, test procedures, and equipment configurations shown in this report were made in accordance with the procedures given in ANSI C63.10:2013 and the energy emitted by the sample EUT tested as described in this report is in compliance with conducted and radiated emission limits.

The test results of this report relate only to the tested sample identified in this report.

Test By:  **Date:** Jan. 11, 2017

Marcus Tseng / Engineer

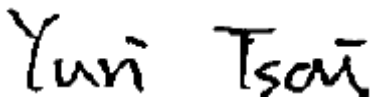
Prepared By:  **Date:** Jan. 11, 2017

Yuri Tsai / Clerk

Approved By:  **Date:** Jan. 11, 2017

Jim Chang / Asst. Manager

Unless otherwise stated the results shown in this test report refer only to the sample(s) tested and such sample(s) are retained for 90 days only.

除非另有說明，此報告結果僅對測試之樣品負責，同時此樣品僅保留90天。本報告未經本公司書面許可，不可部份複製。

This document is issued by the Company subject to its General Conditions of Service printed overleaf, available on request or accessible at www.sgs.com/terms_and_conditions.htm and, for electronic format documents, subject to Terms and Conditions for Electronic Documents at www.sgs.com/terms_e-document.htm. Attention is drawn to the limitation of liability, indemnification and jurisdiction issues defined therein. Any holder of this document is advised that information contained hereon reflects the Company's findings at the time of its intervention only and within the limits of Client's instructions, if any. The Company's sole responsibility is to its Client and this document does not exonerate parties to a transaction from exercising all their rights and obligations under the transaction documents. This document cannot be reproduced except in full, without prior written approval of the Company. Any unauthorized alteration, forgery or falsification of the content or appearance of this document is unlawful and offenders may be prosecuted to the fullest extent of the law.

SGS Taiwan Ltd.

No.134,WuKungRoad,NewTaipeiIndustrialPark,WukuDistrict,NewTaipeiCity,Taiwan24803/新北市五股區新北產業園區五工路 134 號

台灣檢驗科技股份有限公司

t (886-2) 2299-3279

f (886-2) 2298-0488

www.tw.sgs.com

Member of SGS Group

Revision History

Report Number	Revision	Description	Issue Date
ER/2016/C0075	Rev.00	Initial creation of document	Jan. 11, 2017

Unless otherwise stated the results shown in this test report refer only to the sample(s) tested and such sample(s) are retained for 90 days only.

除非另有說明，此報告結果僅對測試之樣品負責，同時此樣品僅保留90天。本報告未經本公司書面許可，不可部份複製。

This document is issued by the Company subject to its General Conditions of Service printed overleaf, available on request or accessible at www.sgs.com/terms_and_conditions.htm and, for electronic format documents, subject to Terms and Conditions for Electronic Documents at www.sgs.com/terms_e-document.htm. Attention is drawn to the limitation of liability, indemnification and jurisdiction issues defined therein. Any holder of this document is advised that information contained hereon reflects the Company's findings at the time of its intervention only and within the limits of Client's instructions, if any. The Company's sole responsibility is to its Client and this document does not exonerate parties to a transaction from exercising all their rights and obligations under the transaction documents. This document cannot be reproduced except in full, without prior written approval of the Company. Any unauthorized alteration, forgery or falsification of the content or appearance of this document is unlawful and offenders may be prosecuted to the fullest extent of the law.

SGS Taiwan Ltd.

No.134,WuKungRoad,NewTaipeiIndustrialPark,WukuDistrict,NewTaipeiCity,Taiwan24803/新北市五股區新北產業園區五工路 134 號

台灣檢驗科技股份有限公司

t (886-2) 2299-3279

f (886-2) 2298-0488

www.tw.sgs.com

Member of SGS Group

Contents

1	GENERAL INFORMATION.....	5
2	SYSTEM TEST CONFIGURATION	8
3	SUMMARY OF TEST RESULTS	10
4	DESCRIPTION OF TEST MODES.....	11
5	MEASUREMENT UNCERTAINTY.....	14
6	CONDUCTED EMISSION TEST	15
7	PEAK OUTPUT POWER MEASUREMENT	19
8	20dB & 99% BANDWIDTH MEASUREMENT	23
9	CONDUCTED BAND EDGES AND SPURIOUS EMISSION MEASUREMENT	35
10	RADIATED BANDEDGE AND SPURIOUS EMISSION MEASUREMENT	47
11	FREQUENCY SEPARATION	80
12	NUMBER OF HOPPING FREQUENCY.....	83
13	TIME OF OCCUPANCY (DWELL TIME).....	86
14	ANTENNA REQUIREMENT	100

Unless otherwise stated the results shown in this test report refer only to the sample(s) tested and such sample(s) are retained for 90 days only.

除非另有說明，此報告結果僅對測試之樣品負責，同時此樣品僅保留90天。本報告未經本公司書面許可，不可部份複製。

This document is issued by the Company subject to its General Conditions of Service printed overleaf, available on request or accessible at www.sgs.com/terms_and_conditions.htm and, for electronic format documents, subject to Terms and Conditions for Electronic Documents at www.sgs.com/terms_e-document.htm. Attention is drawn to the limitation of liability, indemnification and jurisdiction issues defined therein. Any holder of this document is advised that information contained hereon reflects the Company's findings at the time of its intervention only and within the limits of Client's instructions, if any. The Company's sole responsibility is to its Client and this document does not exonerate parties to a transaction from exercising all their rights and obligations under the transaction documents. This document cannot be reproduced except in full, without prior written approval of the Company. Any unauthorized alteration, forgery or falsification of the content or appearance of this document is unlawful and offenders may be prosecuted to the fullest extent of the law.

SGS Taiwan Ltd.

No.134,WuKungRoad,NewTaipeiIndustrialPark,WukuDistrict,NewTaipeiCity,Taiwan24803/新北市五股區新北產業園區五工路 134 號

台灣檢驗科技股份有限公司

t (886-2) 2299-3279

f (886-2) 2298-0488

www.tw.sgs.com

Member of SGS Group

1 GENERAL INFORMATION

1.1 Product description

General:

Product Name:	Here One	
Brand Name:	HERE01011	
Model No.:	HERE01011L	
Model Difference:	N/A	
Product SW/HW version:	1.0 / 102	
Radio SW/HW version:	N/A / N/A	
Test SW Version:	N/A	
RF power setting in TEST SW:	N/A	
USB Cable:	Model No.: C712 10M008 266 6, Supplier: Amphenol Mobile Connector Solution	
Charging Case:	Model No.: P0788-LF (842326 1S1P), Supplier: EVE	
Power Supply:	3.7Vdc from Rechargeable Li-Ion Battery or 5V from USB Cable	
	Battery:	Model No.: CP1254 A3, Supplier: Varta

Bluetooth_BR+EDR:

Bluetooth Version	BT V4.1 (dual mode)
Channel number:	79 channels
Modulation type:	GFSK + $\pi/4$ DQPSK + 8DPSK
Transmit Power:	9.49dBm
Frequency Range:	2.402GHz – 2.480GHz
Antenna Designation:	PIFA Antenna, Gain: -3.62dBi

Unless otherwise stated the results shown in this test report refer only to the sample(s) tested and such sample(s) are retained for 90 days only.

除非另有說明，此報告結果僅對測試之樣品負責，同時此樣品僅保留90天。本報告未經本公司書面許可，不可部份複製。

This document is issued by the Company subject to its General Conditions of Service printed overleaf, available on request or accessible at www.sgs.com/terms_and_conditions.htm and, for electronic format documents, subject to Terms and Conditions for Electronic Documents at www.sgs.com/terms_e-document.htm. Attention is drawn to the limitation of liability, indemnification and jurisdiction issues defined therein. Any holder of this document is advised that information contained hereon reflects the Company's findings at the time of its intervention only and within the limits of Client's instructions, if any. The Company's sole responsibility is to its Client and this document does not exonerate parties to a transaction from exercising all their rights and obligations under the transaction documents. This document cannot be reproduced except in full, without prior written approval of the Company. Any unauthorized alteration, forgery or falsification of the content or appearance of this document is unlawful and offenders may be prosecuted to the fullest extent of the law.

SGS Taiwan Ltd.

No.134,WuKungRoad,NewTaipeiIndustrialPark,WukuDistrict,NewTaipeiCity,Taiwan24803/新北市五股區新北產業園區五工路 134 號

台灣檢驗科技股份有限公司

t (886-2) 2299-3279

f (886-2) 2298-0488

www.tw.sgs.com

Member of SGS Group

1.2 Product Feature of Equipment Under Test

The equipment under Test (Hereafter Called: EUT) is supporting Bluetooth, NFMI features, and below is details of information.

Product Feature	
Product Name:	Here One
Brand Name:	HERE01011
Model No.:	HERE01011L
Model Difference:	N/A
FCC ID:	2AF9A01011L
IC :	20747-01011L
Bluetooth Version	V4.1 dual mode
NFMI	10.6MHz

Note: The above EUT information was declared by manufacturer. Please refer to the specifications or user's manual for more detailed description.

Unless otherwise stated the results shown in this test report refer only to the sample(s) tested and such sample(s) are retained for 90 days only.

除非另有說明，此報告結果僅對測試之樣品負責，同時此樣品僅保留90天。本報告未經本公司書面許可，不可部份複製。

This document is issued by the Company subject to its General Conditions of Service printed overleaf, available on request or accessible at www.sgs.com/terms_and_conditions.htm and, for electronic format documents, subject to Terms and Conditions for Electronic Documents at www.sgs.com/terms_e-document.htm. Attention is drawn to the limitation of liability, indemnification and jurisdiction issues defined therein. Any holder of this document is advised that information contained hereon reflects the Company's findings at the time of its intervention only and within the limits of Client's instructions, if any. The Company's sole responsibility is to its Client and this document does not exonerate parties to a transaction from exercising all their rights and obligations under the transaction documents. This document cannot be reproduced except in full, without prior written approval of the Company. Any unauthorized alteration, forgery or falsification of the content or appearance of this document is unlawful and offenders may be prosecuted to the fullest extent of the law.

SGS Taiwan Ltd.

No.134,WuKungRoad,NewTaipeiIndustrialPark,WukuDistrict,NewTaipeiCity,Taiwan24803/新北市五股區新北產業園區五工路 134 號

台灣檢驗科技股份有限公司

t (886-2) 2299-3279

f (886-2) 2298-0488

www.tw.sgs.com

Member of SGS Group

1.3 Test Methodology of Applied Standards

Canada RSS-247 issue 1: 2015

RSS-Gen Issue 4:2014

FCC Part 15, Subpart C §15.247

FCC Public Notice DA 00-705 Measurement Guidelines

ANSI C63.10:2013

Note:

All test items have been performed and record as per the above standards.

1.4 Test Facility

SGS Taiwan Ltd. Electronics & Communication Laboratory No.134, Wu Kung Road, New Taipei Industrial Park, Wuku District, New Taipei City, Taiwan 24803 (TAF code 0513)

FCC Registration Numbers are: 735305

Canada Registration Number: 4620A-5.

1.5 Special Accessories

There is no special accessory used while test was conducted.

1.6 Equipment Modifications

There was no modification incorporated into the EUT.

Unless otherwise stated the results shown in this test report refer only to the sample(s) tested and such sample(s) are retained for 90 days only.

除非另有說明，此報告結果僅對測試之樣品負責，同時此樣品僅保留90天。本報告未經本公司書面許可，不可部份複製。

This document is issued by the Company subject to its General Conditions of Service printed overleaf, available on request or accessible at www.sgs.com/terms_and_conditions.htm and, for electronic format documents, subject to Terms and Conditions for Electronic Documents at www.sgs.com/terms_e-document.htm. Attention is drawn to the limitation of liability, indemnification and jurisdiction issues defined therein. Any holder of this document is advised that information contained hereon reflects the Company's findings at the time of its intervention only and within the limits of Client's instructions, if any. The Company's sole responsibility is to its Client and this document does not exonerate parties to a transaction from exercising all their rights and obligations under the transaction documents. This document cannot be reproduced except in full, without prior written approval of the Company. Any unauthorized alteration, forgery or falsification of the content or appearance of this document is unlawful and offenders may be prosecuted to the fullest extent of the law.

SGS Taiwan Ltd.

No.134,WuKungRoad,NewTaipeiIndustrialPark,WukuDistrict,NewTaipeiCity,Taiwan24803/新北市五股區新北產業園區五工路 134 號

台灣檢驗科技股份有限公司

t (886-2) 2299-3279

f (886-2) 2298-0488

www.tw.sgs.com

Member of SGS Group

2 SYSTEM TEST CONFIGURATION

2.1 EUT Configuration

The EUT configuration for testing is installed on RF field strength measurement to meet the Commissions requirement and operating in a manner which intends to maximize its emission characteristics in a continuous normal application.

2.2 EUT Exercise

An engineering test mode (software/firmware) that applicant provided was utilized to manipulate the EUT into transmit, selection of the test channel, and modulation scheme.

2.3 Test Procedure

2.3.1 Conducted Emissions

The EUT is a placed on as turn table which is 0.8 m above ground plan. Conducted emissions from the EUT measured in the frequency range between 0.15 MHz and 30MHz,. The CISPR Quasi-Peak and Average detector mode is employed according to §15.207. The two LISNs provide 50 ohm/ 50uH of coupling impedance for the measuring instrument. Both lines of the power mains connected to the EUT were checked for maximum conducted interference.

2.3.2 Radiated Emissions

The EUT is a placed on as turn table. For emissions testing at or below 1 GHz, the table height shall be 0.8 m above the reference ground plan. For emission measurements above 1 GHz, the table height shall be 1.5 m. The turn table shall rotate 360 degrees to determine the position of maximum emission level. EUT is set 3m away from the receiving antenna which varied from 1m to 4m to find out the highest emission. And also, each emission was to be maximized by changing the polarization of receiving antenna both horizontal and vertical. In order to find out the max. emission, the relative positions of this hand-held transmitter (EUT) was rotated through three orthogonal axes and measurement procedures for electric field radiated emissions above 1 GHz the EUT measurement is to be made “while keeping the antenna in the ‘cone of radiation’ from that area and pointed at the area both in azimuth and elevation, with polarization oriented for maximum response.” is still within the 3dB illumination BW of the measurement antenna.

2.4 Measurement Results Explanation Example

For all conducted test items:

The offset level is set in the spectrum analyzer to compensate the RF cable loss and attenuation factor between EUT conducted port and spectrum analyzer. With the offset compensation, the spectrum analyzer reading level is exactly EUT RF output level.

Note:

The spectrum analyzer offset is derived from RF cable loss 0.5dB.

Unless otherwise stated the results shown in this test report refer only to the sample(s) tested and such sample(s) are retained for 90 days only.

除非另有說明，此報告結果僅對測試之樣品負責，同時此樣品僅保留90天。本報告未經本公司書面許可，不可部份複製。

This document is issued by the Company subject to its General Conditions of Service printed overleaf, available on request or accessible at www.sgs.com/terms_and_conditions.htm and, for electronic format documents, subject to Terms and Conditions for Electronic Documents at www.sgs.com/terms_e-document.htm. Attention is drawn to the limitation of liability, indemnification and jurisdiction issues defined therein. Any holder of this document is advised that information contained hereon reflects the Company's findings at the time of its intervention only and within the limits of Client's instructions, if any. The Company's sole responsibility is to its Client and this document does not exonerate parties to a transaction from exercising all their rights and obligations under the transaction documents. This document cannot be reproduced except in full, without prior written approval of the Company. Any unauthorized alteration, forgery or falsification of the content or appearance of this document is unlawful and offenders may be prosecuted to the fullest extent of the law.

SGS Taiwan Ltd.

台灣檢驗科技股份有限公司

No.134,WuKungRoad,NewTaipeiIndustrialPark,WukuDistrict,NewTaipeiCity,Taiwan24803/新北市五股區新北產業園區五工路 134 號

t (886-2) 2299-3279

f (886-2) 2298-0488

www.tw.sgs.com

Member of SGS Group

2.5 Configuration of Tested System

Fig. 2-1 Radiated Emission



Fig. 2-2 Conducted (Antenna Port) Emission & AC Power Line Conducted Emission



Table 2-1 Equipment Used in Tested System

Item	Equipment	Mfr/Brand	Model/Type No.	Series No.	Data Cable	Power Cord
1	Bluetooth Test Software	N/A	N/A	N/A	N/A	N/A
2.	Notebook	Lenovo	L420	LR-7HXZA	N/A	N/A

Unless otherwise stated the results shown in this test report refer only to the sample(s) tested and such sample(s) are retained for 90 days only.

除非另有說明，此報告結果僅對測試之樣品負責，同時此樣品僅保留90天。本報告未經本公司書面許可，不可部份複製。

This document is issued by the Company subject to its General Conditions of Service printed overleaf, available on request or accessible at www.sgs.com/terms_and_conditions.htm and, for electronic format documents, subject to Terms and Conditions for Electronic Documents at www.sgs.com/terms_e-document.htm. Attention is drawn to the limitation of liability, indemnification and jurisdiction issues defined therein. Any holder of this document is advised that information contained hereon reflects the Company's findings at the time of its intervention only and within the limits of Client's instructions, if any. The Company's sole responsibility is to its Client and this document does not exonerate parties to a transaction from exercising all their rights and obligations under the transaction documents. This document cannot be reproduced except in full, without prior written approval of the Company. Any unauthorized alteration, forgery or falsification of the content or appearance of this document is unlawful and offenders may be prosecuted to the fullest extent of the law.

SGS Taiwan Ltd.

No.134,WuKungRoad,NewTaipeiIndustrialPark,WukuDistrict,NewTaipeiCity,Taiwan24803/新北市五股區新北產業園區五工路 134 號

台灣檢驗科技股份有限公司

t (886-2) 2299-3279

f (886-2) 2298-0488

www.tw.sgs.com

Member of SGS Group

3 SUMMARY OF TEST RESULTS

FCC Rules	IC Rules	Description Of Test	Result
§15.207(a)	RSS-Gen §8.8	AC Power Line Conducted Emission	Compliant
§15.247(b)(1)	RSS-247 §5.4 (2)	Peak Output Power	Compliant
§15.247(a)(1)	RSS-247 §5.1 (1) RSS-Gen §6.6	20dB & 99% Bandwidth	Compliant
§15.247(d)	RSS-247 §5.5	Conducted Band Edge and Spurious Emission	Compliant
§15.247(d)	RSS-247 §5.5	Radiated Band Edge and Spurious Emission	Compliant
§15.247(a)(1)	RSS-247 §5.1 (2)	Frequency Separation	Compliant
§15.247(a)(1)(iii)	RSS-247 §5.1 (4)	Number of hopping frequency	Compliant
§15.247(a)(1)(iii)	RSS-247 §5.1 (4)	Time of Occupancy	Compliant
§15.203 §15.247(b)	RSS- Gen §8.3	Antenna Requirement	Compliant

Unless otherwise stated the results shown in this test report refer only to the sample(s) tested and such sample(s) are retained for 90 days only.

除非另有說明，此報告結果僅對測試之樣品負責，同時此樣品僅保留90天。本報告未經本公司書面許可，不可部份複製。

This document is issued by the Company subject to its General Conditions of Service printed overleaf, available on request or accessible at www.sgs.com/terms_and_conditions.htm and, for electronic format documents, subject to Terms and Conditions for Electronic Documents at www.sgs.com/terms_e-document.htm. Attention is drawn to the limitation of liability, indemnification and jurisdiction issues defined therein. Any holder of this document is advised that information contained hereon reflects the Company's findings at the time of its intervention only and within the limits of Client's instructions, if any. The Company's sole responsibility is to its Client and this document does not exonerate parties to a transaction from exercising all their rights and obligations under the transaction documents. This document cannot be reproduced except in full, without prior written approval of the Company. Any unauthorized alteration, forgery or falsification of the content or appearance of this document is unlawful and offenders may be prosecuted to the fullest extent of the law.

SGS Taiwan Ltd.

No.134,WuKungRoad,NewTaipeiIndustrialPark,WukuDistrict,NewTaipeiCity,Taiwan24803/新北市五股區新北產業園區五工路 134 號

台灣檢驗科技股份有限公司

t (886-2) 2299-3279

f (886-2) 2298-0488

www.tw.sgs.com

Member of SGS Group

4 DESCRIPTION OF TEST MODES

4.1 Operated in 2400 ~ 2483.5MHz Band

79 channels are provided for Bluetooth

CH	FREQUENCY	CH	FREQUENCY	CH	FREQUENCY	CH	FREQUENCY
0	2402 MHz	20	2422 MHz	40	2442 MHz	70	2462 MHz
1	2403 MHz	21	2423 MHz	41	2443 MHz	71	2463 MHz
2	2404 MHz	22	2424 MHz	42	2444 MHz	72	2464 MHz
3	2405 MHz	23	2425 MHz	43	2445 MHz	73	2465 MHz
4	2406 MHz	24	2426 MHz	44	2446 MHz	74	2466 MHz
5	2407 MHz	25	2427 MHz	45	2447 MHz	75	2467 MHz
6	2408 MHz	26	2428 MHz	46	2448 MHz	76	2468 MHz
7	2409 MHz	27	2429 MHz	47	2449 MHz	77	2469 MHz
8	2410 MHz	28	2430 MHz	48	2450 MHz	78	2470 MHz
9	2411 MHz	29	2431 MHz	49	2451 MHz	79	2471 MHz
10	2412 MHz	30	2432 MHz	50	2452 MHz	70	2472 MHz
11	2413 MHz	31	2433 MHz	51	2453 MHz	71	2473 MHz
12	2414 MHz	32	2434 MHz	52	2454 MHz	72	2474 MHz
13	2415 MHz	33	2435 MHz	53	2455 MHz	73	2475 MHz
14	2416 MHz	34	2436 MHz	54	2456 MHz	74	2476 MHz
15	2417 MHz	35	2437 MHz	55	2457 MHz	75	2477 MHz
16	2418 MHz	36	2438 MHz	56	2458 MHz	76	2478 MHz
17	2419 MHz	37	2439 MHz	57	2459 MHz	77	2479 MHz
18	2420 MHz	38	2440 MHz	58	2460 MHz	78	2480 MHz
19	2421 MHz	39	2441 MHz	59	2461 MHz		

Unless otherwise stated the results shown in this test report refer only to the sample(s) tested and such sample(s) are retained for 90 days only.

除非另有說明，此報告結果僅對測試之樣品負責，同時此樣品僅保留90天。本報告未經本公司書面許可，不可部份複製。

This document is issued by the Company subject to its General Conditions of Service printed overleaf, available on request or accessible at www.sgs.com/terms_and_conditions.htm and, for electronic format documents, subject to Terms and Conditions for Electronic Documents at www.sgs.com/terms_e-document.htm. Attention is drawn to the limitation of liability, indemnification and jurisdiction issues defined therein. Any holder of this document is advised that information contained hereon reflects the Company's findings at the time of its intervention only and within the limits of Client's instructions, if any. The Company's sole responsibility is to its Client and this document does not exonerate parties to a transaction from exercising all their rights and obligations under the transaction documents. This document cannot be reproduced except in full, without prior written approval of the Company. Any unauthorized alteration, forgery or falsification of the content or appearance of this document is unlawful and offenders may be prosecuted to the fullest extent of the law.

SGS Taiwan Ltd.

No.134,WuKungRoad,NewTaipeiIndustrialPark,WukuDistrict,NewTaipeiCity,Taiwan24803/新北市五股區新北產業園區五工路 134 號

台灣檢驗科技股份有限公司

t (886-2) 2299-3279

f (886-2) 2298-0488

www.tw.sgs.com

Member of SGS Group

4.2 The Worst Test Modes and Channel Details

- 1 The EUT has been tested under operating condition.
- 2 Test program used to control the EUT for staying in continuous transmitting and receiving mode is programmed.
- 3 Investigation has been done on all the possible configurations for searching the worst case.

RADIATED TEST				
Radiated Emission Test (BELOW 1 GHz) (Worst case)				
MODE	AVAILABLE CHANNEL	TESTED CHANNEL	MODULATION	PACKET TYPE
Bluetooth	0 to 78	39	GFSK	DH5
Radiated Emission Test (ABOVE 1 GHz) (Worst case)				
MODE	AVAILABLE CHANNEL	TESTED CHANNEL	MODULATION	PACKET TYPE
Bluetooth	0 to 78	0,39,78	GFSK	DH5
Band Edge				
Bluetooth	0 to 78	0,78	GFSK	DH5
Bluetooth	0 to 78	0,78	8-DPSK	3DH5

Note: The field strength of radiation emission was measured as EUT stand-up position (H mode) and lie down position (E1, E2 mode) for Bluetooth BR+EDR Transmitter for channel Low, Mid and High, the worst case E2 position was reported.

Unless otherwise stated the results shown in this test report refer only to the sample(s) tested and such sample(s) are retained for 90 days only.

除非另有說明，此報告結果僅對測試之樣品負責，同時此樣品僅保留90天。本報告未經本公司書面許可，不可部份複製。

This document is issued by the Company subject to its General Conditions of Service printed overleaf, available on request or accessible at www.sgs.com/terms_and_conditions.htm and, for electronic format documents, subject to Terms and Conditions for Electronic Documents at www.sgs.com/terms_e-document.htm. Attention is drawn to the limitation of liability, indemnification and jurisdiction issues defined therein. Any holder of this document is advised that information contained hereon reflects the Company's findings at the time of its intervention only and within the limits of Client's instructions, if any. The Company's sole responsibility is to its Client and this document does not exonerate parties to a transaction from exercising all their rights and obligations under the transaction documents. This document cannot be reproduced except in full, without prior written approval of the Company. Any unauthorized alteration, forgery or falsification of the content or appearance of this document is unlawful and offenders may be prosecuted to the fullest extent of the law.

SGS Taiwan Ltd.

No.134,WuKungRoad,NewTaipeiIndustrialPark,WukuDistrict,NewTaipeiCity,Taiwan24803/新北市五股區新北產業園區五工路 134 號

台灣檢驗科技股份有限公司

t (886-2) 2299-3279

f (886-2) 2298-0488

www.tw.sgs.com

Member of SGS Group

ANTENNA PORT CONDUCTED TEST				
Peak Output Power, 20dB Band Width				
MODE	AVAILABLE CHANNEL	TESTED CHANNEL	MODULATION	PACKET TYPE
Bluetooth	0 to 78	0,39,78	GFSK	DH5
	0 to 78	0,39,78	$\pi/4$ -DQPSK	DH5
	0 to 78	0,39,78	8-DPSK	DH5
Band Edge & Conducted Emission				
Bluetooth	0 to 78	0,78	GFSK	DH5
Bluetooth	0 to 78	0,78	8-DPSK	3DH5
Frequency Separation				
Bluetooth	0 to 78	0,1,2	GFSK	DH5
Number of hopping frequency				
Bluetooth	0 to 78	0 to 78	GFSK	DH5
Time of Occupancy (Dwell time)				
Bluetooth	0 to 78	0,39,78	GFSK	DH1/DH3/DH5
Bluetooth	0 to 78	39	$\pi/4$ -DQPSK	DH1/DH3/DH5
Bluetooth	0 to 78	39	8-DPSK	DH1/DH3/DH5

Unless otherwise stated the results shown in this test report refer only to the sample(s) tested and such sample(s) are retained for 90 days only.

除非另有說明，此報告結果僅對測試之樣品負責，同時此樣品僅保留90天。本報告未經本公司書面許可，不可部份複製。

This document is issued by the Company subject to its General Conditions of Service printed overleaf, available on request or accessible at www.sgs.com/terms_and_conditions.htm and, for electronic format documents, subject to Terms and Conditions for Electronic Documents at www.sgs.com/terms_e-document.htm. Attention is drawn to the limitation of liability, indemnification and jurisdiction issues defined therein. Any holder of this document is advised that information contained hereon reflects the Company's findings at the time of its intervention only and within the limits of Client's instructions, if any. The Company's sole responsibility is to its Client and this document does not exonerate parties to a transaction from exercising all their rights and obligations under the transaction documents. This document cannot be reproduced except in full, without prior written approval of the Company. Any unauthorized alteration, forgery or falsification of the content or appearance of this document is unlawful and offenders may be prosecuted to the fullest extent of the law.

SGS Taiwan Ltd.

No.134,WuKungRoad,NewTaipeiIndustrialPark,WukuDistrict,NewTaipeiCity,Taiwan24803/新北市五股區新北產業園區五工路 134 號

台灣檢驗科技股份有限公司

t (886-2) 2299-3279

f (886-2) 2298-0488

www.tw.sgs.com

Member of SGS Group

5 MEASUREMENT UNCERTAINTY

Test Items	Uncertainty
AC Power Line Conducted Emission	+/- 2.586 dB
Peak Output Power	+/- 0.84 dB
20dB Bandwidth	+/- 51.33 Hz
100 KHz Bandwidth Of Frequency Band Edges	+/- 0.84 dB
Frequency Separation	+/- 51.33 Hz
Number of hopping frequency	+/- 51.33 Hz
Time of Occupancy	+/- 51.33 Hz
Temperature	+/- 0.65 °C
Humidity	+/- 4.6 %
DC / AC Power Source	DC= +/- 0.13%, AC= +/- 0.2%

Radiated Spurious Emission:

Measurement uncertainty (Polarization : Vertical)	9kHz – 30MHz: +/- 2.87 dB
	30MHz - 180MHz: +/- 3.37dB
	180MHz -417MHz: +/- 3.19dB
	0.417GHz-1GHz: +/- 3.19dB
	1GHz - 18GHz: +/- 4.04dB
	18GHz - 40GHz: +/- 4.04dB

Measurement uncertainty (Polarization : Horizontal)	9kHz – 30MHz: +/- 2.87 dB
	30MHz - 167MHz: +/- 4.22dB
	167MHz -500MHz: +/- 3.44dB
	0.5GHz-1GHz: +/- 3.39dB
	1GHz - 18GHz: +/- 4.08dB
	18GHz - 40GHz: +/- 4.08dB

This uncertainty represents an expanded uncertainty expressed at approximately the 95% confidence level using a coverage factor of k=2.

Unless otherwise stated the results shown in this test report refer only to the sample(s) tested and such sample(s) are retained for 90 days only.

除非另有說明，此報告結果僅對測試之樣品負責，同時此樣品僅保留90天。本報告未經本公司書面許可，不可部份複製。

This document is issued by the Company subject to its General Conditions of Service printed overleaf, available on request or accessible at www.sgs.com/terms_and_conditions.htm and, for electronic format documents, subject to Terms and Conditions for Electronic Documents at www.sgs.com/terms_e-document.htm. Attention is drawn to the limitation of liability, indemnification and jurisdiction issues defined therein. Any holder of this document is advised that information contained hereon reflects the Company's findings at the time of its intervention only and within the limits of Client's instructions, if any. The Company's sole responsibility is to its Client and this document does not exonerate parties to a transaction from exercising all their rights and obligations under the transaction documents. This document cannot be reproduced except in full, without prior written approval of the Company. Any unauthorized alteration, forgery or falsification of the content or appearance of this document is unlawful and offenders may be prosecuted to the fullest extent of the law.

SGS Taiwan Ltd.

No.134,WuKungRoad,NewTaipeiIndustrialPark,WukuDistrict,NewTaipeiCity,Taiwan24803/新北市五股區新北產業園區五工路 134 號

台灣檢驗科技股份有限公司

t (886-2) 2299-3279

f (886-2) 2298-0488

www.tw.sgs.com

Member of SGS Group

6 CONDUCTED EMISSION TEST

6.1 Standard Applicable

Frequency within 150 kHz to 30MHz shall not exceed the limit table as below.

Frequency range MHz	Limits dB(uV)	
	Quasi-peak	Average
0.15 to 0.50	66 to 56	56 to 46
0.50 to 5	56	46
5 to 30	60	50

Note

- The lower limit shall apply at the transition frequencies
- The limit decreases linearly with the logarithm of the frequency in the range 0.15 MHz to 0.50 MHz.

6.2 Measurement Equipment Used

Conducted Emission Test Site					
EQUIPMENT TYPE	MFR	MODEL NUMBER	SERIAL NUMBER	LAST CAL.	CAL DUE.
EMI Test	R&S	ESCI 7	100760	05/10/2016	05/09/2017
Coaxial Cables	N/A	N30N30-1042-15 0cm	N/A	02/07/2016	02/06/2017
LISN	Schwarzbeck	NSLK 8127	8127-648	03/11/2016	03/10/2017
Test Software	Farad	EZ-EMC	Ver. SGS-03A2	N.C.R.	N.C.R.

6.3 EUT Setup

- The conducted emission tests were performed in the test site, using the setup in accordance with the ANSI 63.10:2013.
- The AC/DC Power adaptor of EUT was plug-in LISN. The EUT was placed flushed with the rear of the table.
- The LISN was connected with 120Vac/60Hz power source.

Unless otherwise stated the results shown in this test report refer only to the sample(s) tested and such sample(s) are retained for 90 days only.

除非另有說明，此報告結果僅對測試之樣品負責，同時此樣品僅保留90天。本報告未經本公司書面許可，不可部份複製。

This document is issued by the Company subject to its General Conditions of Service printed overleaf, available on request or accessible at www.sgs.com/terms_and_conditions.htm and, for electronic format documents, subject to Terms and Conditions for Electronic Documents at www.sgs.com/terms_e-document.htm. Attention is drawn to the limitation of liability, indemnification and jurisdiction issues defined therein. Any holder of this document is advised that information contained hereon reflects the Company's findings at the time of its intervention only and within the limits of Client's instructions, if any. The Company's sole responsibility is to its Client and this document does not exonerate parties to a transaction from exercising all their rights and obligations under the transaction documents. This document cannot be reproduced except in full, without prior written approval of the Company. Any unauthorized alteration, forgery or falsification of the content or appearance of this document is unlawful and offenders may be prosecuted to the fullest extent of the law.

SGS Taiwan Ltd.

No.134,WuKungRoad,NewTaipeiIndustrialPark,WukuDistrict,NewTaipeiCity,Taiwan24803/新北市五股區新北產業園區五工路 134 號

台灣檢驗科技股份有限公司

t (886-2) 2299-3279

f (886-2) 2298-0488

www.tw.sgs.com

Member of SGS Group

6.4 Test SET-UP (Block Diagram of Configuration)

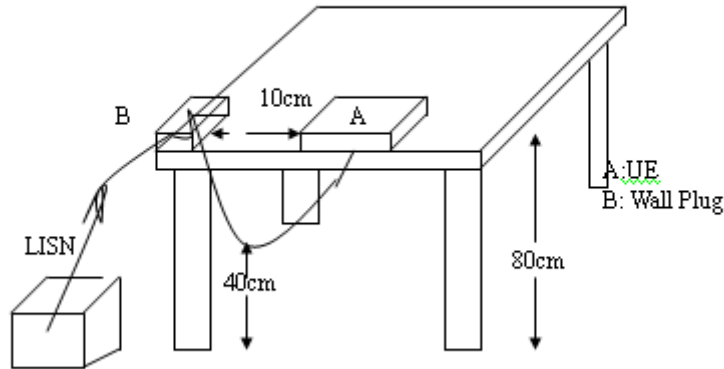

6.5 Measurement Procedure

1. The EUT was placed on a table which is 0.8m above ground plan.
2. Maximum procedure was performed on the six highest emissions to ensure EUT compliance.
3. Repeat above procedures until all frequency measured were complete.

6.6 Measurement Result

Note: Refer to next page for measurement data and plots.

Note2: The * reveals the worst-case results that closet to the limit

Unless otherwise stated the results shown in this test report refer only to the sample(s) tested and such sample(s) are retained for 90 days only.

除非另有說明，此報告結果僅對測試之樣品負責，同時此樣品僅保留90天。本報告未經本公司書面許可，不可部份複製。

This document is issued by the Company subject to its General Conditions of Service printed overleaf, available on request or accessible at www.sgs.com/terms_and_conditions.htm and, for electronic format documents, subject to Terms and Conditions for Electronic Documents at www.sgs.com/terms_e-document.htm. Attention is drawn to the limitation of liability, indemnification and jurisdiction issues defined therein. Any holder of this document is advised that information contained hereon reflects the Company's findings at the time of its intervention only and within the limits of Client's instructions, if any. The Company's sole responsibility is to its Client and this document does not exonerate parties to a transaction from exercising all their rights and obligations under the transaction documents. This document cannot be reproduced except in full, without prior written approval of the Company. Any unauthorized alteration, forgery or falsification of the content or appearance of this document is unlawful and offenders may be prosecuted to the fullest extent of the law.

SGS Taiwan Ltd.

No.134,WuKungRoad,NewTaipeiIndustrialPark,WukuDistrict,NewTaipeiCity,Taiwan24803/新北市五股區新北產業園區五工路 134 號

台灣檢驗科技股份有限公司

t (886-2) 2299-3279

f (886-2) 2298-0488

www.tw.sgs.com

Member of SGS Group

AC POWER LINE CONDUCTED EMISSION TEST DATA

Operation Mode:	Operation mode	Test By:	Nick
Temperature:	20		

Unless otherwise stated the results shown in this test report refer only to the sample(s) tested and such sample(s) are retained for 90 days only.

除非另有說明，此報告結果僅對測試之樣品負責，同時此樣品僅保留90天。本報告未經本公司書面許可，不可部份複製。

This document is issued by the Company subject to its General Conditions of Service printed overleaf, available on request or accessible at www.sgs.com/terms_and_conditions.htm and, for electronic format documents, subject to Terms and Conditions for Electronic Documents at www.sgs.com/terms_e-document.htm. Attention is drawn to the limitation of liability, indemnification and jurisdiction issues defined therein. Any holder of this document is advised that information contained hereon reflects the Company's findings at the time of its intervention only and within the limits of Client's instructions, if any. The Company's sole responsibility is to its Client and this document does not exonerate parties to a transaction from exercising all their rights and obligations under the transaction documents. This document cannot be reproduced except in full, without prior written approval of the Company. Any unauthorized alteration, forgery or falsification of the content or appearance of this document is unlawful and offenders may be prosecuted to the fullest extent of the law.

SGS Taiwan Ltd.

No.134,WuKungRoad,NewTaipeiIndustrialPark,WukuDistrict,NewTaipeiCity,Taiwan24803/新北市五股區新北產業園區五工路 134 號

台灣檢驗科技股份有限公司

t (886-2) 2299-3279

f (886-2) 2298-0488

www.tw.sgs.com

Member of SGS Group

Site: ConductionRoom	Phase: N	Temperature: 25 °C
Limit: FCC Class B Conduction(QP)	Power: AC 120V/60Hz	Humidity: 60%
Mode: Operationmode		
Note:		

Conducted Emission

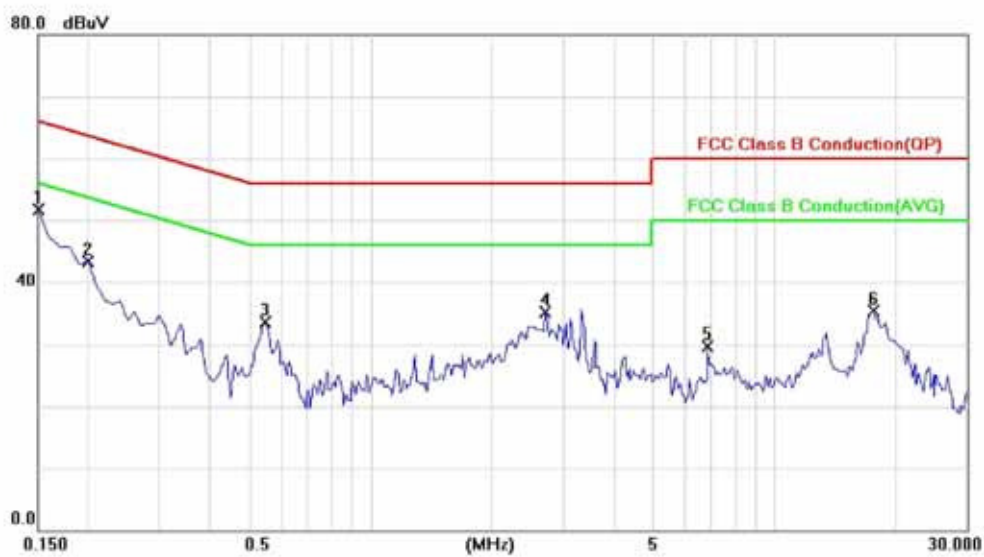

No.	Mk.	Freq. MHz	Reading Level dBuV	Correct Factor dB	Measure- ment dBuV	Limit dBuV	Over dB	Detector	Comment
1	*	0.1500	51.58	0.18	51.76	66.00	-14.24	peak	
2		0.2000	43.19	0.19	43.38	63.61	-20.23	peak	
3		0.5500	33.39	0.21	33.60	56.00	-22.40	peak	
4		2.7200	34.87	0.27	35.14	56.00	-20.86	peak	
5		6.8600	29.43	0.36	29.79	60.00	-30.21	peak	
6		17.6400	34.82	0.53	35.35	60.00	-24.65	peak	

Unless otherwise stated the results shown in this test report refer only to the sample(s) tested and such sample(s) are retained for 90 days only.

除非另有說明，此報告結果僅對測試之樣品負責，同時此樣品僅保留90天。本報告未經本公司書面許可，不可部份複製。

This document is issued by the Company subject to its General Conditions of Service printed overleaf, available on request or accessible at www.sgs.com/terms_and_conditions.htm and, for electronic format documents, subject to Terms and Conditions for Electronic Documents at www.sgs.com/terms_e-document.htm. Attention is drawn to the limitation of liability, indemnification and jurisdiction issues defined therein. Any holder of this document is advised that information contained hereon reflects the Company's findings at the time of its intervention only and within the limits of Client's instructions, if any. The Company's sole responsibility is to its Client and this document does not exonerate parties to a transaction from exercising all their rights and obligations under the transaction documents. This document cannot be reproduced except in full, without prior written approval of the Company. Any unauthorized alteration, forgery or falsification of the content or appearance of this document is unlawful and offenders may be prosecuted to the fullest extent of the law.

SGS Taiwan Ltd.

No.134,WuKungRoad,NewTaipeiIndustrialPark,WukuDistrict,NewTaipeiCity,Taiwan24803/新北市五股區新北產業園區五工路 134 號

台灣檢驗科技股份有限公司

t (886-2) 2299-3279

f (886-2) 2298-0488

www.tw.sgs.com

Member of SGS Group

7 PEAK OUTPUT POWER MEASUREMENT

7.1 Standard Applicable

For frequency hopping systems operating in the 2400-2483.5 MHz band employing at least 75 hopping channels, The Limit: 1Watt. For all other frequency hopping systems in the 2400 – 2483.5MHz band: The Limit: 0.125 Watts. The power limit for 1Mbps is 1watt, and 2Mbps, 3Mbps and AFH mode are 0.125 watts.

7.2 Measurement Equipment Used

Conducted Emission Test Site					
EQUIPMENT TYPE	MFR	MODEL NUMBER	SERIAL NUMBER	LAST CAL.	CAL DUE.
Power Meter	Anritsu	ML2495A	1005007	12/15/2016	12/14/2017
Power Sensor	Anritsu	MA2411B	917032	12/15/2016	12/14/2017
EXA Spectrum Analyzer	Agilent	N9030A	MY53120760	02/26/2016	02/25/2017
DC Block	Mini-Circuits	BLK-18-S+	1	01/02/2016	01/01/2017
Coaxial Cable	HUBER+SUHNER	SUCOFLEX 102	23670/2	01/02/2016	01/01/2017
Attenuator	Mini-Circuit	BW-S10W2+	2	01/02/2016	01/01/2017
Splitter	Agilent	11636B	N/A	01/02/2016	01/01/2017
DC Power Supply	Agilent	E3640A	MY52410006	11/21/2016	11/20/2017
Temperature Chamber	TERCHY	MHG-120LF	911009	05/17/2016	05/16/2017

EQUIPMENT TYPE	MFR	MODEL NUMBER	SERIAL NUMBER	LAST CAL.	CAL DUE.
DC Block	Mini-Circuits	BLK-18-S+	1	01/02/2017	01/01/2018
Coaxial Cable	HUBER+SUHNER	SUCOFLEX 102	23670/2	01/02/2017	01/01/2018
Attenuator	Mini-Circuit	BW-S10W2+	2	01/02/2017	01/01/2018
Splitter	Agilent	11636B	N/A	01/02/2017	01/01/2018

Note: The measurement was taken place with the long duration of the time, and additional equipment list as shown above indicate those equipment of which has been subject to undertake the calibration in intermediate period of time of the measurement.

Unless otherwise stated the results shown in this test report refer only to the sample(s) tested and such sample(s) are retained for 90 days only.

除非另有說明，此報告結果僅對測試之樣品負責，同時此樣品僅保留90天。本報告未經本公司書面許可，不可部份複製。

This document is issued by the Company subject to its General Conditions of Service printed overleaf, available on request or accessible at www.sgs.com/terms_and_conditions.htm and, for electronic format documents, subject to Terms and Conditions for Electronic Documents at www.sgs.com/terms_e-document.htm. Attention is drawn to the limitation of liability, indemnification and jurisdiction issues defined therein. Any holder of this document is advised that information contained hereon reflects the Company's findings at the time of its intervention only and within the limits of Client's instructions, if any. The Company's sole responsibility is to its Client and this document does not exonerate parties to a transaction from exercising all their rights and obligations under the transaction documents. This document cannot be reproduced except in full, without prior written approval of the Company. Any unauthorized alteration, forgery or falsification of the content or appearance of this document is unlawful and offenders may be prosecuted to the fullest extent of the law.

SGS Taiwan Ltd.

No.134,WuKungRoad,NewTaipeiIndustrialPark,WukuDistrict,NewTaipeiCity,Taiwan24803/新北市五股區新北產業園區五工路 134 號

台灣檢驗科技股份有限公司

t (886-2) 2299-3279

f (886-2) 2298-0488

www.tw.sgs.com

Member of SGS Group

7.3 Test Set-up:

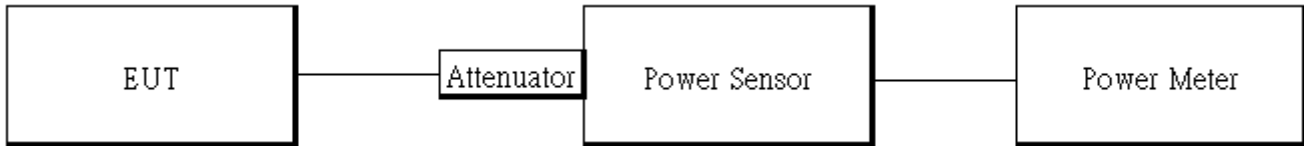

7.4 Measurement Procedure:

1. Place the EUT on the table and set it in transmitting mode.
2. The testing follows FCC Public Notice DA 00-705 Measurement Guidelines.
3. Remove the antenna from the EUT and then connect a low loss RF cable from the antenna port to the power meter or spectrum. (Max Hold, Detector = Peak, RBW \geq 20dB bandwidth)
4. Record the max. reading.
5. Repeat above procedures until all default test channel is completed.

Unless otherwise stated the results shown in this test report refer only to the sample(s) tested and such sample(s) are retained for 90 days only.

除非另有說明，此報告結果僅對測試之樣品負責，同時此樣品僅保留90天。本報告未經本公司書面許可，不可部份複製。

This document is issued by the Company subject to its General Conditions of Service printed overleaf, available on request or accessible at www.sgs.com/terms_and_conditions.htm and, for electronic format documents, subject to Terms and Conditions for Electronic Documents at www.sgs.com/terms_e-document.htm. Attention is drawn to the limitation of liability, indemnification and jurisdiction issues defined therein. Any holder of this document is advised that information contained hereon reflects the Company's findings at the time of its intervention only and within the limits of Client's instructions, if any. The Company's sole responsibility is to its Client and this document does not exonerate parties to a transaction from exercising all their rights and obligations under the transaction documents. This document cannot be reproduced except in full, without prior written approval of the Company. Any unauthorized alteration, forgery or falsification of the content or appearance of this document is unlawful and offenders may be prosecuted to the fullest extent of the law.

SGS Taiwan Ltd.

No.134,WuKungRoad,NewTaipeiIndustrialPark,WukuDistrict,NewTaipeiCity,Taiwan24803/新北市五股區新北產業園區五工路 134 號

台灣檢驗科技股份有限公司

t (886-2) 2299-3279

f (886-2) 2298-0488

www.tw.sgs.com

Member of SGS Group

7.5 Measurement Result

1M BR mode (Peak):

CH	Freq. (MHz)	Peak Output Power (dBm)	Output Power (mW)	Limit (mW)
0	2402	6.79	4.775	125
39	2441	9.49	8.892	125
78	2480	5.29	3.381	125

1M BR mode (Average):

CH	Freq. (MHz)	Max. Output include tune up tolerance Power (dBm)	Output Power (mW)	Limit (mW)
0	2402	5.53	3.573	125
39	2441	8.21	6.622	125
78	2480	4.07	2.553	125

2M EDR mode (Peak):

CH	Freq. (MHz)	Peak Output Power (dBm)	Output Power (mW)	Limit (mW)
0	2402	5.75	3.758	125
39	2441	8.72	7.447	125
78	2480	4.93	3.112	125

2M EDR mode (Average):

CH	Freq. (MHz)	Max. Output include tune up tolerance Power (dBm)	Output Power (mW)	Limit (mW)
0	2402	2.78	1.897	125
39	2441	6.02	3.999	125
78	2480	2.96	1.977	125

3M EDR mode (Peak):

CH	Freq. (MHz)	Peak Output Power (dBm)	Output Power (mW)	Limit (mW)
0	2402	5.98	3.963	125
39	2441	8.90	7.762	125
78	2480	5.00	3.162	125

3M EDR mode (Average):

CH	Freq. (MHz)	Max. Output include tune up tolerance Power (dBm)	Output Power (mW)	Limit (mW)
0	2402	2.63	1.832	125
39	2441	6.02	3.999	125
78	2480	2.95	1.972	125

Unless otherwise stated the results shown in this test report refer only to the sample(s) tested and such sample(s) are retained for 90 days only.

除非另有說明，此報告結果僅對測試之樣品負責，同時此樣品僅保留90天。本報告未經本公司書面許可，不可部份複製。

This document is issued by the Company subject to its General Conditions of Service printed overleaf, available on request or accessible at www.sgs.com/terms_and_conditions.htm and, for electronic format documents, subject to Terms and Conditions for Electronic Documents at www.sgs.com/terms_e-document.htm. Attention is drawn to the limitation of liability, indemnification and jurisdiction issues defined therein. Any holder of this document is advised that information contained hereon reflects the Company's findings at the time of its intervention only and within the limits of Client's instructions, if any. The Company's sole responsibility is to its Client and this document does not exonerate parties to a transaction from exercising all their rights and obligations under the transaction documents. This document cannot be reproduced except in full, without prior written approval of the Company. Any unauthorized alteration, forgery or falsification of the content or appearance of this document is unlawful and offenders may be prosecuted to the fullest extent of the law.

EIRP:

1M BR mode EIRP

Channel	Frequency (MHz)	Max. Output include tune up tolerance Power (dBm)	Antenna Gain (dBi)	EIRP (mW)	Limit (mW)
0	2402	5.53	-3.62	1.552	500
39	2441	8.21	-3.62	2.877	500
78	2480	4.07	-3.62	1.109	500

2M EDR mode EIRP

Channel	Frequency (MHz)	Max. Output include tune up tolerance Power (dBm)	Antenna Gain (dBi)	EIRP (mW)	Limit (mW)
0	2402	2.78	-3.62	0.824	500
39	2441	6.02	-3.62	1.738	500
78	2480	2.96	-3.62	0.859	500

3M EDR mode EIRP

Channel	Frequency (MHz)	Max. Output include tune up tolerance Power (dBm)	Antenna Gain (dBi)	EIRP (mW)	Limit (mW)
0	2402	2.63	-3.62	0.796	500
39	2441	6.02	-3.62	1.738	500
78	2480	2.95	-3.62	0.857	500

* **Note:** EIRP = Average Power + Gain

Unless otherwise stated the results shown in this test report refer only to the sample(s) tested and such sample(s) are retained for 90 days only. 除非另有說明，此報告結果僅對測試之樣品負責，同時此樣品僅保留90天。本報告未經本公司書面許可，不可部份複製。

This document is issued by the Company subject to its General Conditions of Service printed overleaf, available on request or accessible at www.sgs.com/terms_and_conditions.htm and, for electronic format documents, subject to Terms and Conditions for Electronic Documents at www.sgs.com/terms_e-document.htm. Attention is drawn to the limitation of liability, indemnification and jurisdiction issues defined therein. Any holder of this document is advised that information contained hereon reflects the Company's findings at the time of its intervention only and within the limits of Client's instructions, if any. The Company's sole responsibility is to its Client and this document does not exonerate parties to a transaction from exercising all their rights and obligations under the transaction documents. This document cannot be reproduced except in full, without prior written approval of the Company. Any unauthorized alteration, forgery or falsification of the content or appearance of this document is unlawful and offenders may be prosecuted to the fullest extent of the law.

8 20DB & 99% BANDWIDTH MEASUREMENT

8.1 Standard Applicable

For frequency hopping systems operating in the 2400MHz-2483.5 MHz no limit for 20dB bandwidth.

8.2 Measurement Equipment Used

Conducted Emission Test Site					
EQUIPMENT TYPE	MFR	MODEL NUMBER	SERIAL NUMBER	LAST CAL.	CAL DUE.
EXA Spectrum Analyzer	Agilent	N9030A	MY53120760	02/26/2016	02/25/2017
DC Block	Mini-Circuits	BLK-18-S+	1	01/02/2016	01/01/2017
Attenuator	Mini-Circuit	BW-S10W2+	2	01/02/2016	01/01/2017
Splitter	Agilent	11636B	N/A	01/02/2016	01/01/2017

EQUIPMENT TYPE	MFR	MODEL NUMBER	SERIAL NUMBER	LAST CAL.	CAL DUE.
DC Block	Mini-Circuits	BLK-18-S+	1	01/02/2017	01/01/2018
Attenuator	Mini-Circuit	BW-S10W2+	2	01/02/2017	01/01/2018
Splitter	Agilent	11636B	N/A	01/02/2017	01/01/2018

Note: The measurement was taken place with the long duration of the time, and additional equipment list as shown above indicate those equipment of which has been subject to undertake the calibration in intermediate period of time of the measurement.

8.3 Test Set-up

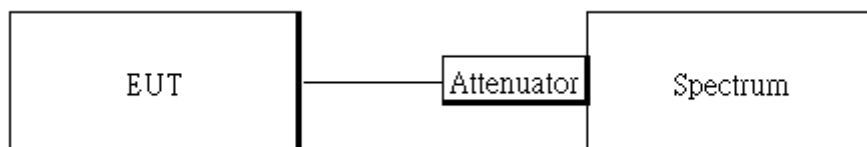

Unless otherwise stated the results shown in this test report refer only to the sample(s) tested and such sample(s) are retained for 90 days only.

除非另有說明，此報告結果僅對測試之樣品負責，同時此樣品僅保留90天。本報告未經本公司書面許可，不可部份複製。

This document is issued by the Company subject to its General Conditions of Service printed overleaf, available on request or accessible at www.sgs.com/terms_and_conditions.htm and, for electronic format documents, subject to Terms and Conditions for Electronic Documents at www.sgs.com/terms_e-document.htm. Attention is drawn to the limitation of liability, indemnification and jurisdiction issues defined therein. Any holder of this document is advised that information contained hereon reflects the Company's findings at the time of its intervention only and within the limits of Client's instructions, if any. The Company's sole responsibility is to its Client and this document does not exonerate parties to a transaction from exercising all their rights and obligations under the transaction documents. This document cannot be reproduced except in full, without prior written approval of the Company. Any unauthorized alteration, forgery or falsification of the content or appearance of this document is unlawful and offenders may be prosecuted to the fullest extent of the law.

SGS Taiwan Ltd.

No.134,WuKungRoad,NewTaipeiIndustrialPark,WukuDistrict,NewTaipeiCity,Taiwan24803/新北市五股區新北產業園區五工路 134 號

台灣檢驗科技股份有限公司

t (886-2) 2299-3279

f (886-2) 2298-0488

www.tw.sgs.com

Member of SGS Group

8.4 Measurement Procedure

1. Place the EUT on the table and set it in transmitting mode.
2. The testing follows FCC Public Notice DA 00-705 Measurement Guidelines.
3. Remove the antenna from the EUT and then connect a low loss RF cable from the antenna port to the spectrum analyzer.
4. Set the spectrum analyzer as RBW=10 kHz (1 % of 20 dB Bandwidth.), VBW = 30 kHz, Span= 3MHz, Sweep=auto, Detector = Peak, and Max hold for 20dB Bandwidth test.
5. Mark the peak frequency and -20dB (upper and lower) frequency
6. Turn on the 99% bandwidth function, max reading.
7. Repeat above procedures until all test default channel is completed

NOTE:

1. For the plot of bandwidth measurement, the marker of the 20dB BW is arrow-mark.

8.5 Measurement Result

GFSK

CH	20 dB BW (MHz)	2/3 BW (MHz)
Low	0.9224	0.61
Mid	0.9224	0.61
High	0.9233	0.62

$\pi/4$ -DQPSK

CH	20 dB BW (MHz)	2/3 BW (MHz)
Low	1.314	0.88
Mid	1.318	0.88
High	1.338	0.89

8-DPSK

CH	20 dB BW (MHz)	2/3 BW (MHz)
Low	1.264	0.84
Mid	1.286	0.86
High	1.335	0.89

GFSK

CH	99% Bandwidth (MHz)
Low	0.86716
Mid	0.8596
High	0.86138

$\pi/4$ -DQPSK

CH	99% Bandwidth (MHz)
Low	1.1878
Mid	1.2078
High	1.2783

8-DPSK

CH	99% Bandwidth (MHz)
Low	1.1869
Mid	1.2076
High	1.2481

Unless otherwise stated the results shown in this test report refer only to the sample(s) tested and such sample(s) are retained for 90 days only.

除非另有說明，此報告結果僅對測試之樣品負責，同時此樣品僅保留90天。本報告未經本公司書面許可，不可部份複製。

This document is issued by the Company subject to its General Conditions of Service printed overleaf, available on request or accessible at www.sgs.com/terms_and_conditions.htm and, for electronic format documents, subject to Terms and Conditions for Electronic Documents at www.sgs.com/terms_e-document.htm. Attention is drawn to the limitation of liability, indemnification and jurisdiction issues defined therein. Any holder of this document is advised that information contained hereon reflects the Company's findings at the time of its intervention only and within the limits of Client's instructions, if any. The Company's sole responsibility is to its Client and this document does not exonerate parties to a transaction from exercising all their rights and obligations under the transaction documents. This document cannot be reproduced except in full, without prior written approval of the Company. Any unauthorized alteration, forgery or falsification of the content or appearance of this document is unlawful and offenders may be prosecuted to the fullest extent of the law.

20dB Band Width Test Data CH-Low (GFSK mode)

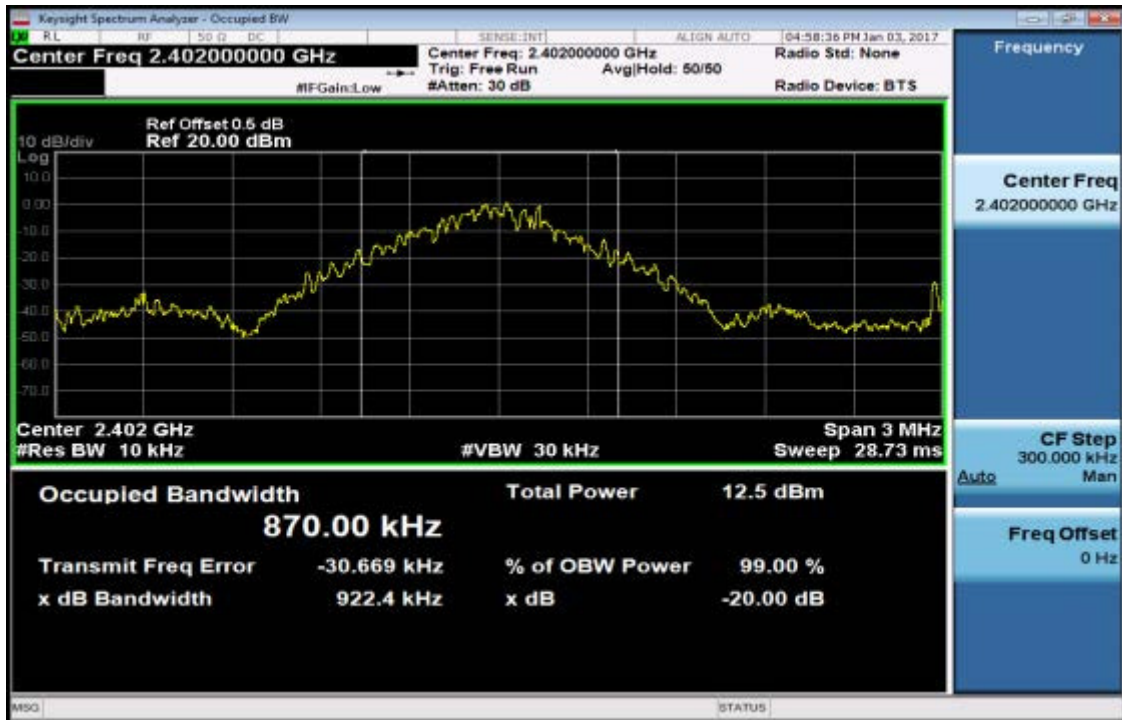

20dB Band Width Test Data CH-Mid (GFSK mode)

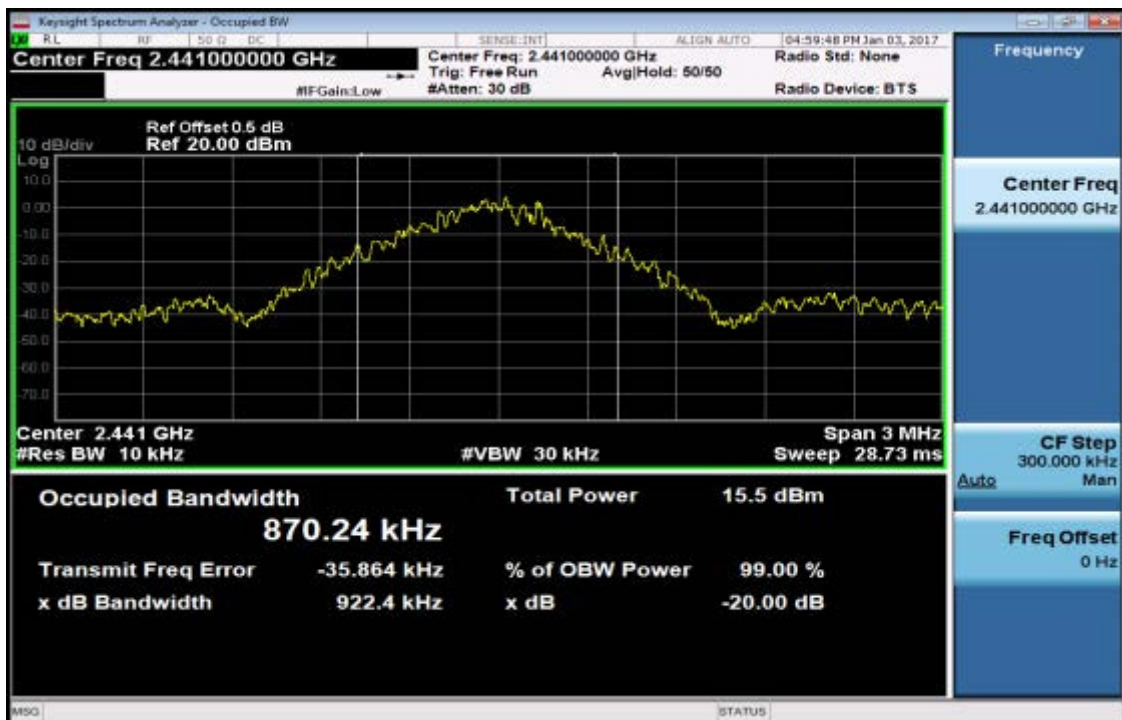

Unless otherwise stated the results shown in this test report refer only to the sample(s) tested and such sample(s) are retained for 90 days only.

除非另有說明，此報告結果僅對測試之樣品負責，同時此樣品僅保留90天。本報告未經本公司書面許可，不可部份複製。

This document is issued by the Company subject to its General Conditions of Service printed overleaf, available on request or accessible at www.sgs.com/terms_and_conditions.htm and, for electronic format documents, subject to Terms and Conditions for Electronic Documents at www.sgs.com/terms_e-document.htm. Attention is drawn to the limitation of liability, indemnification and jurisdiction issues defined therein. Any holder of this document is advised that information contained hereon reflects the Company's findings at the time of its intervention only and within the limits of Client's instructions, if any. The Company's sole responsibility is to its Client and this document does not exonerate parties to a transaction from exercising all their rights and obligations under the transaction documents. This document cannot be reproduced except in full, without prior written approval of the Company. Any unauthorized alteration, forgery or falsification of the content or appearance of this document is unlawful and offenders may be prosecuted to the fullest extent of the law.

SGS Taiwan Ltd.

No. 134, WuKungRoad, NewTaipeiIndustrialPark, WukuDistrict, NewTaipeiCity, Taiwan24803/新北市五股區新北產業園區五工路 134 號

台灣檢驗科技股份有限公司

t (886-2) 2299-3279

f (886-2) 2298-0488

www.tw.sgs.com

Member of SGS Group

20dB Band Width Test Data CH-High (GFSK mode)

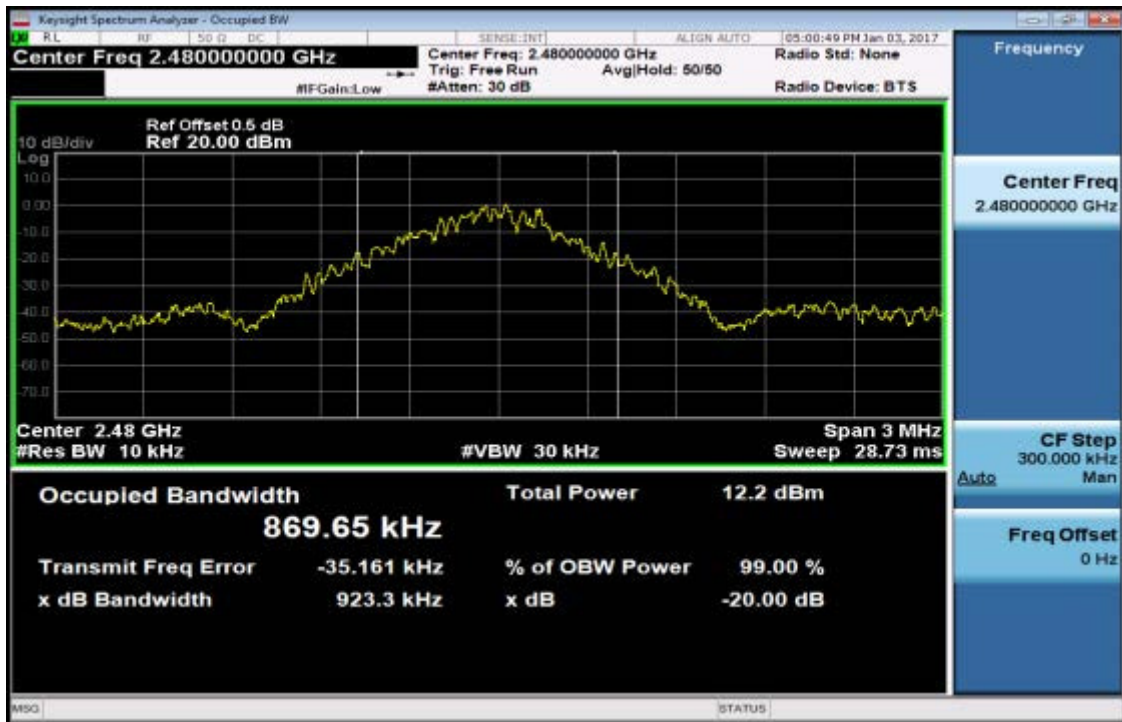

20dB Band Width Test Data CH-Low ($\pi/4$ -DQPSK mode)

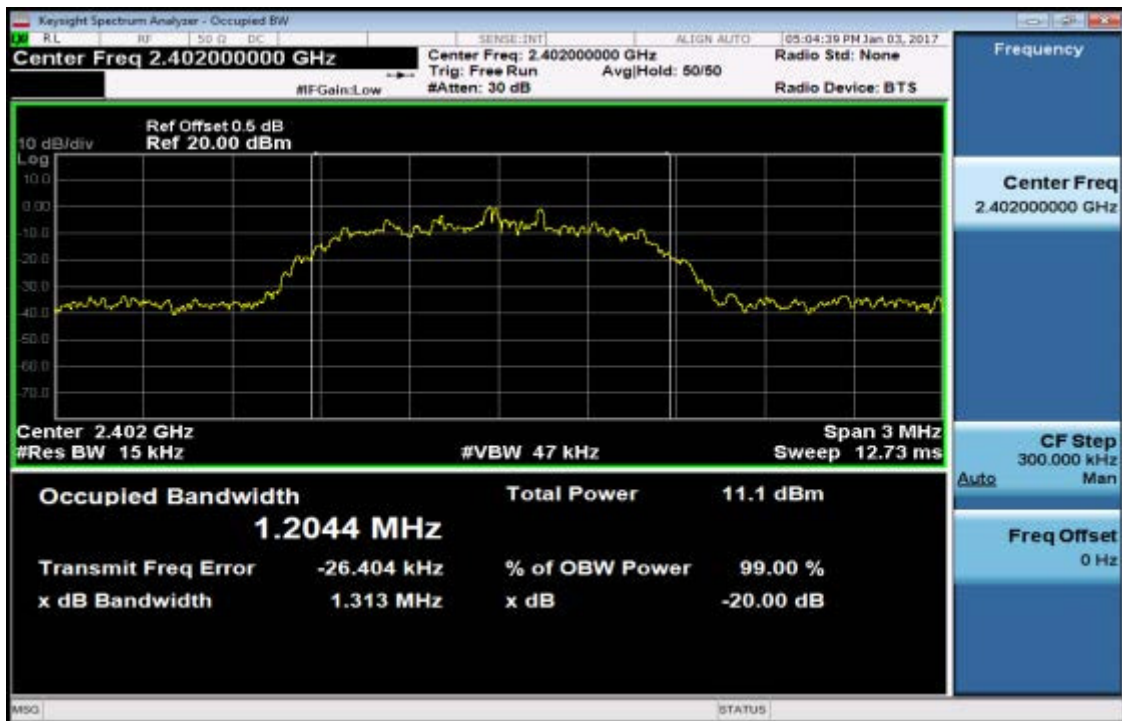

Unless otherwise stated the results shown in this test report refer only to the sample(s) tested and such sample(s) are retained for 90 days only.

除非另有說明，此報告結果僅對測試之樣品負責，同時此樣品僅保留90天。本報告未經本公司書面許可，不可部份複製。

This document is issued by the Company subject to its General Conditions of Service printed overleaf, available on request or accessible at www.sgs.com/terms_and_conditions.htm and, for electronic format documents, subject to Terms and Conditions for Electronic Documents at www.sgs.com/terms_e-document.htm. Attention is drawn to the limitation of liability, indemnification and jurisdiction issues defined therein. Any holder of this document is advised that information contained hereon reflects the Company's findings at the time of its intervention only and within the limits of Client's instructions, if any. The Company's sole responsibility is to its Client and this document does not exonerate parties to a transaction from exercising all their rights and obligations under the transaction documents. This document cannot be reproduced except in full, without prior written approval of the Company. Any unauthorized alteration, forgery or falsification of the content or appearance of this document is unlawful and offenders may be prosecuted to the fullest extent of the law.

SGS Taiwan Ltd.

No. 134, WuKungRoad, NewTaipeiIndustrialPark, WukuDistrict, NewTaipeiCity, Taiwan24803/新北市五股區新北產業園區五工路 134 號

台灣檢驗科技股份有限公司

t (886-2) 2299-3279

f (886-2) 2298-0488

www.tw.sgs.com

Member of SGS Group

20dB Band Width Test Data CH-Mid ($\pi/4$ -DQPSK mode)

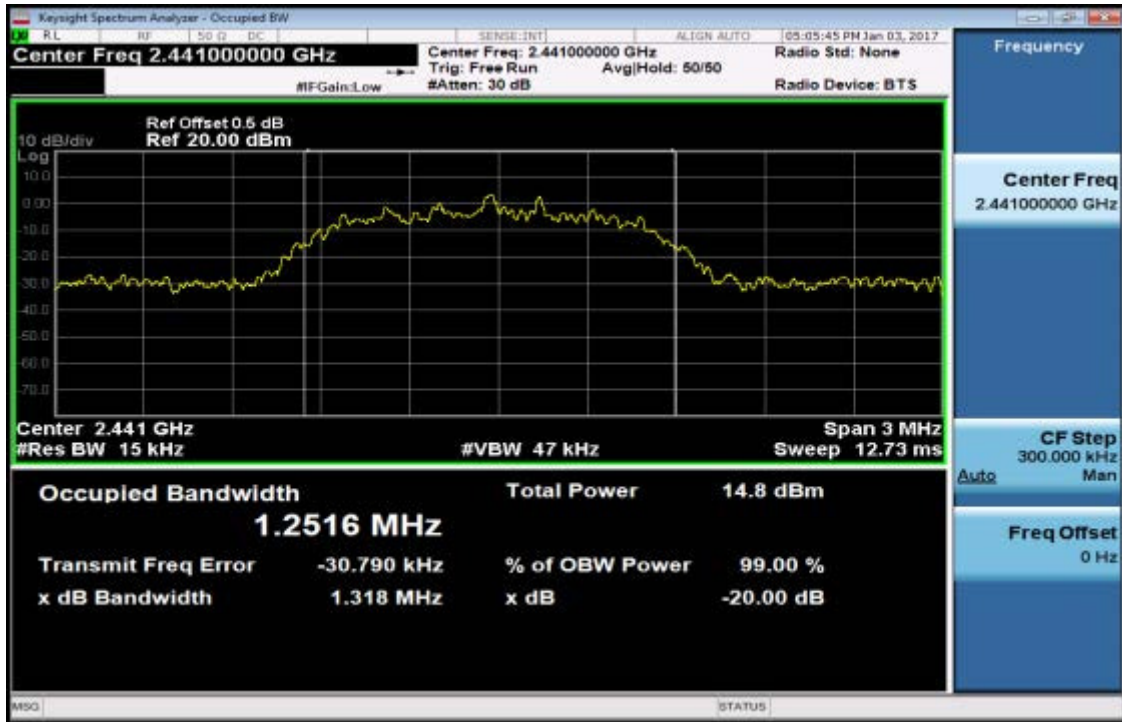

20dB Band Width Test Data CH-High ($\pi/4$ -DQPSK mode)

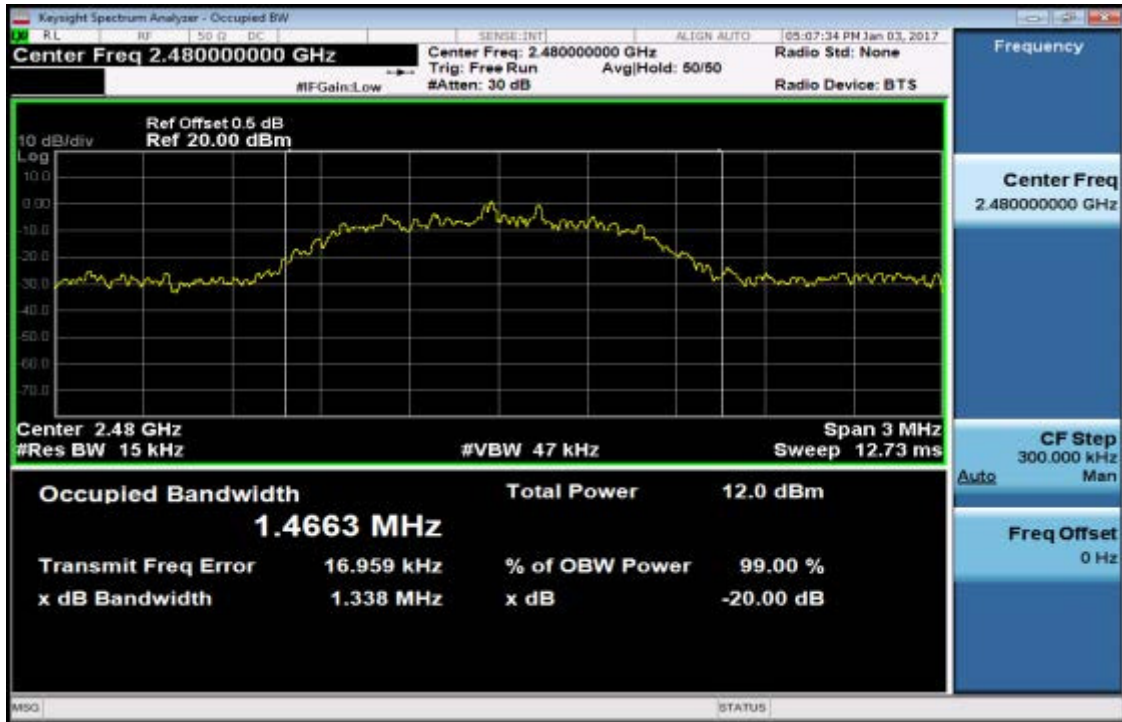

Unless otherwise stated the results shown in this test report refer only to the sample(s) tested and such sample(s) are retained for 90 days only.

除非另有說明，此報告結果僅對測試之樣品負責，同時此樣品僅保留90天。本報告未經本公司書面許可，不可部份複製。

This document is issued by the Company subject to its General Conditions of Service printed overleaf, available on request or accessible at www.sgs.com/terms_and_conditions.htm and, for electronic format documents, subject to Terms and Conditions for Electronic Documents at www.sgs.com/terms_e-document.htm. Attention is drawn to the limitation of liability, indemnification and jurisdiction issues defined therein. Any holder of this document is advised that information contained hereon reflects the Company's findings at the time of its intervention only and within the limits of Client's instructions, if any. The Company's sole responsibility is to its Client and this document does not exonerate parties to a transaction from exercising all their rights and obligations under the transaction documents. This document cannot be reproduced except in full, without prior written approval of the Company. Any unauthorized alteration, forgery or falsification of the content or appearance of this document is unlawful and offenders may be prosecuted to the fullest extent of the law.

SGS Taiwan Ltd.

No. 134, WuKungRoad, NewTaipeiIndustrialPark, WukuDistrict, NewTaipeiCity, Taiwan24803/新北市五股區新北產業園區五工路 134 號

台灣檢驗科技股份有限公司

t (886-2) 2299-3279

f (886-2) 2298-0488

www.tw.sgs.com

Member of SGS Group

20dB Band Width Test Data CH-Low (8-DPSK mode)

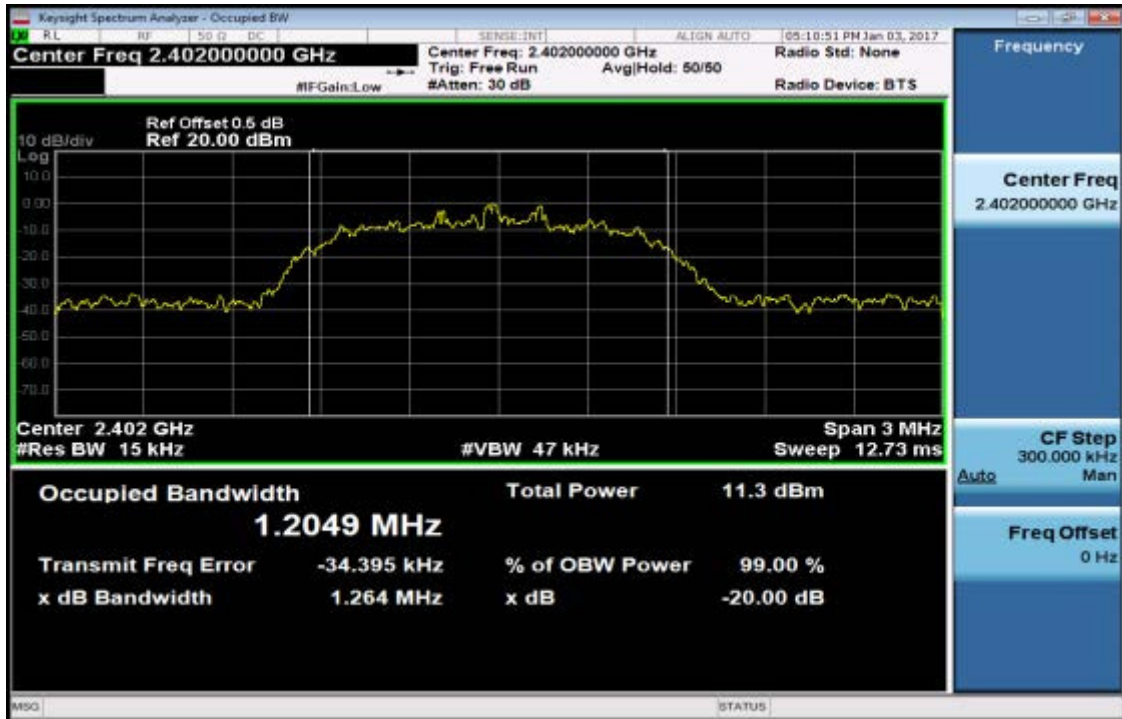

20dB Band Width Test Data CH-Mid (8-DPSK mode)

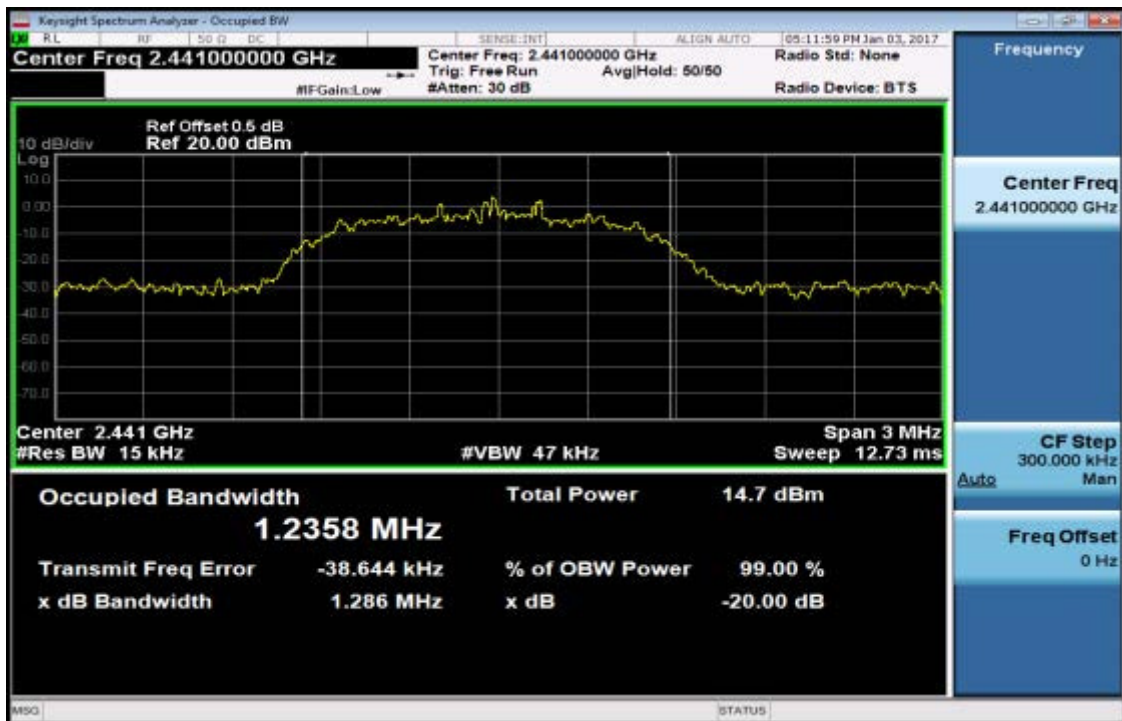

Unless otherwise stated the results shown in this test report refer only to the sample(s) tested and such sample(s) are retained for 90 days only.

除非另有說明，此報告結果僅對測試之樣品負責，同時此樣品僅保留90天。本報告未經本公司書面許可，不可部份複製。

This document is issued by the Company subject to its General Conditions of Service printed overleaf, available on request or accessible at www.sgs.com/terms_and_conditions.htm and, for electronic format documents, subject to Terms and Conditions for Electronic Documents at www.sgs.com/terms_e-document.htm. Attention is drawn to the limitation of liability, indemnification and jurisdiction issues defined therein. Any holder of this document is advised that information contained hereon reflects the Company's findings at the time of its intervention only and within the limits of Client's instructions, if any. The Company's sole responsibility is to its Client and this document does not exonerate parties to a transaction from exercising all their rights and obligations under the transaction documents. This document cannot be reproduced except in full, without prior written approval of the Company. Any unauthorized alteration, forgery or falsification of the content or appearance of this document is unlawful and offenders may be prosecuted to the fullest extent of the law.

SGS Taiwan Ltd.

No. 134, WuKungRoad, NewTaipeiIndustrialPark, WukuDistrict, NewTaipeiCity, Taiwan24803/新北市五股區新北產業園區五工路 134 號

台灣檢驗科技股份有限公司

t (886-2) 2299-3279

f (886-2) 2298-0488

www.tw.sgs.com

Member of SGS Group

20dB Band Width Test Data CH-High (8-DPSK mode)

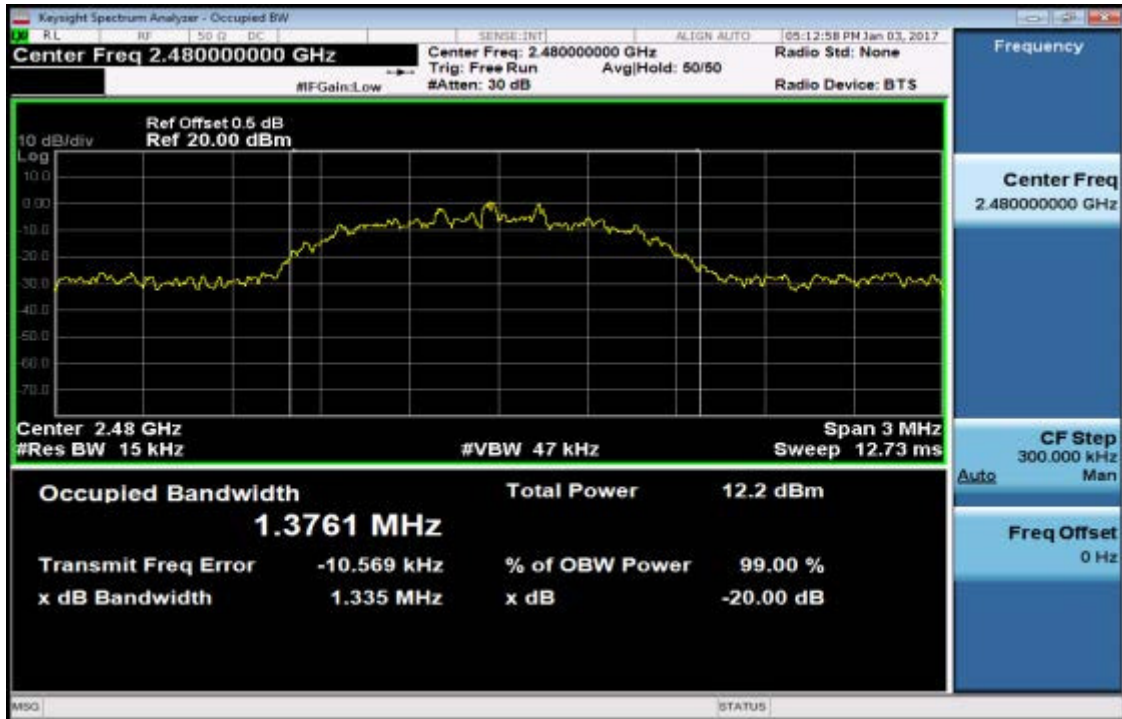

Unless otherwise stated the results shown in this test report refer only to the sample(s) tested and such sample(s) are retained for 90 days only.

除非另有說明，此報告結果僅對測試之樣品負責，同時此樣品僅保留90天。本報告未經本公司書面許可，不可部份複製。

This document is issued by the Company subject to its General Conditions of Service printed overleaf, available on request or accessible at www.sgs.com/terms_and_conditions.htm and, for electronic format documents, subject to Terms and Conditions for Electronic Documents at www.sgs.com/terms_e-document.htm. Attention is drawn to the limitation of liability, indemnification and jurisdiction issues defined therein. Any holder of this document is advised that information contained hereon reflects the Company's findings at the time of its intervention only and within the limits of Client's instructions, if any. The Company's sole responsibility is to its Client and this document does not exonerate parties to a transaction from exercising all their rights and obligations under the transaction documents. This document cannot be reproduced except in full, without prior written approval of the Company. Any unauthorized alteration, forgery or falsification of the content or appearance of this document is unlawful and offenders may be prosecuted to the fullest extent of the law.

SGS Taiwan Ltd.

No. 134, WuKungRoad, NewTaipeiIndustrialPark, WukuDistrict, NewTaipeiCity, Taiwan24803/新北市五股區新北產業園區五工路 134 號

台灣檢驗科技股份有限公司

t (886-2) 2299-3279

f (886-2) 2298-0488

www.tw.sgs.com

Member of SGS Group

99% Band Width Test Data CH-Low (GFSK mode)

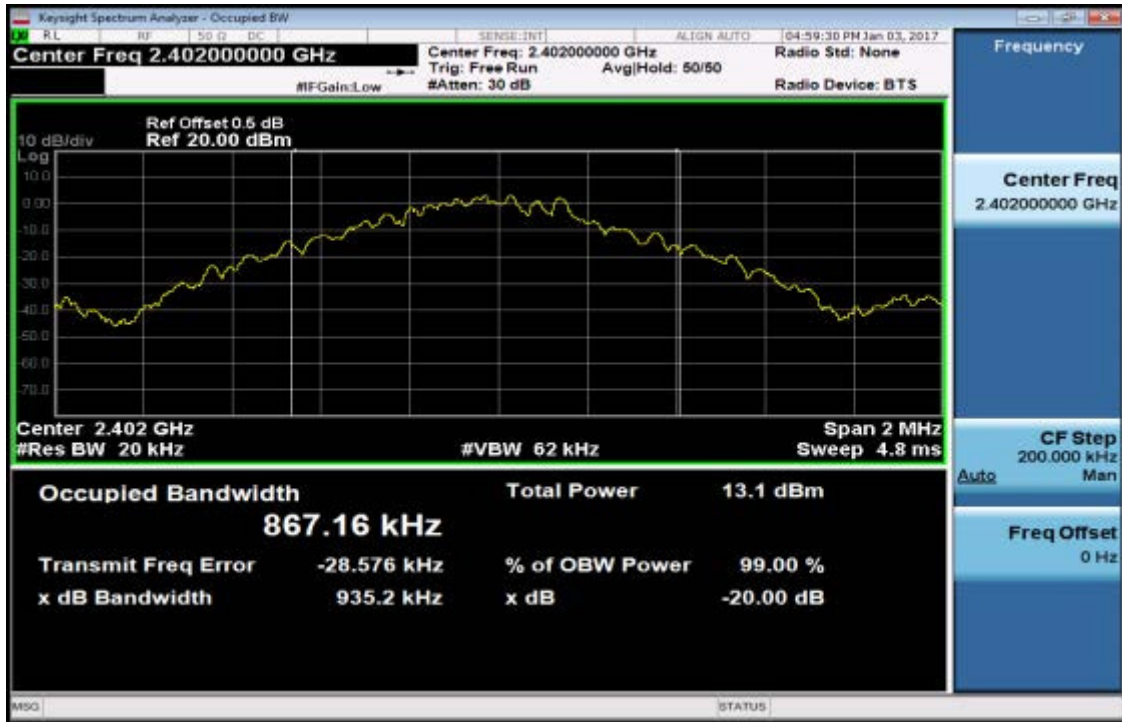

99% Band Width Test Data CH-Mid (GFSK mode)

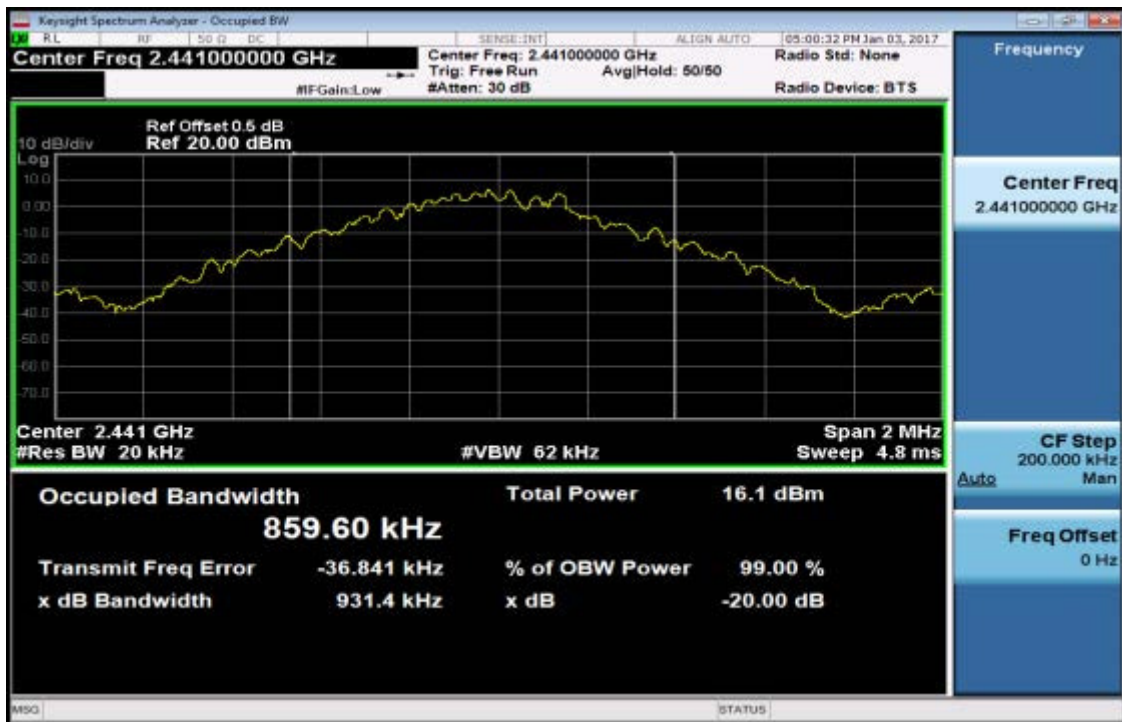

Unless otherwise stated the results shown in this test report refer only to the sample(s) tested and such sample(s) are retained for 90 days only.

除非另有說明，此報告結果僅對測試之樣品負責，同時此樣品僅保留90天。本報告未經本公司書面許可，不可部份複製。

This document is issued by the Company subject to its General Conditions of Service printed overleaf, available on request or accessible at www.sgs.com/terms_and_conditions.htm and, for electronic format documents, subject to Terms and Conditions for Electronic Documents at www.sgs.com/terms_e-document.htm. Attention is drawn to the limitation of liability, indemnification and jurisdiction issues defined therein. Any holder of this document is advised that information contained hereon reflects the Company's findings at the time of its intervention only and within the limits of Client's instructions, if any. The Company's sole responsibility is to its Client and this document does not exonerate parties to a transaction from exercising all their rights and obligations under the transaction documents. This document cannot be reproduced except in full, without prior written approval of the Company. Any unauthorized alteration, forgery or falsification of the content or appearance of this document is unlawful and offenders may be prosecuted to the fullest extent of the law.

SGS Taiwan Ltd.

No. 134, WuKung Road, New Taipei Industrial Park, Wuku District, New Taipei City, Taiwan 24803 / 新北市五股區新北產業園區五工路 134 號

台灣檢驗科技股份有限公司

t (886-2) 2299-3279

f (886-2) 2298-0488

www.tw.sgs.com

Member of SGS Group

99% Band Width Test Data CH-High (GFSK mode)

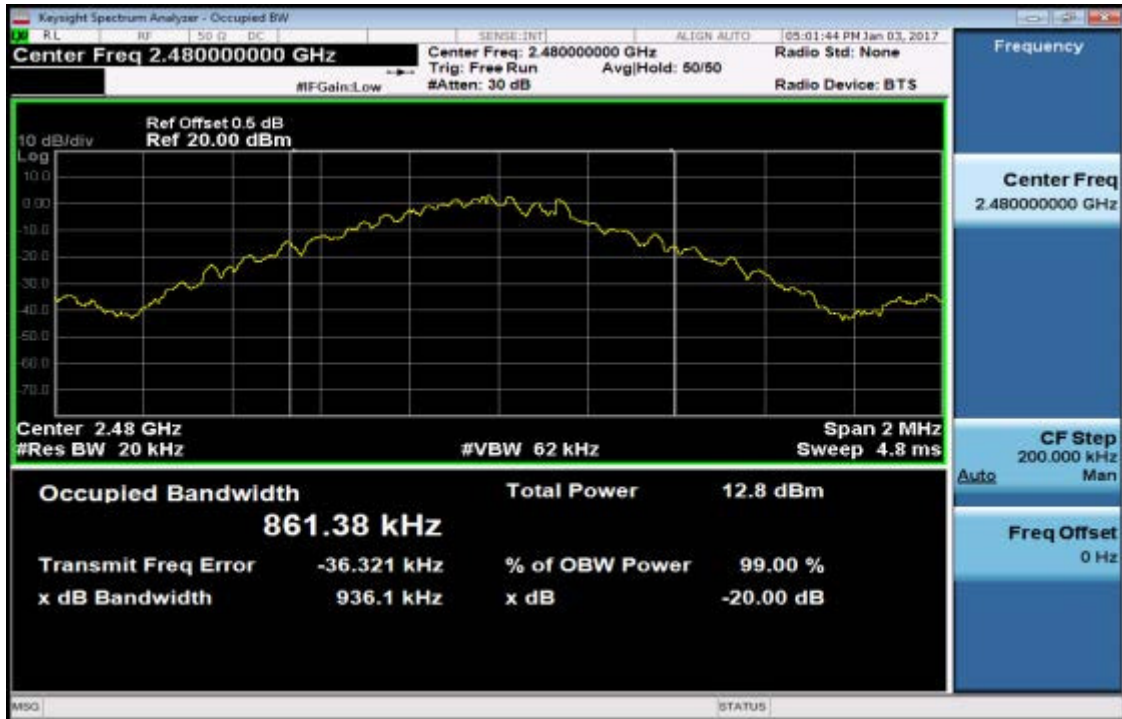

99% Band Width Test Data CH-Low ($\pi/4$ -DQPSK mode)

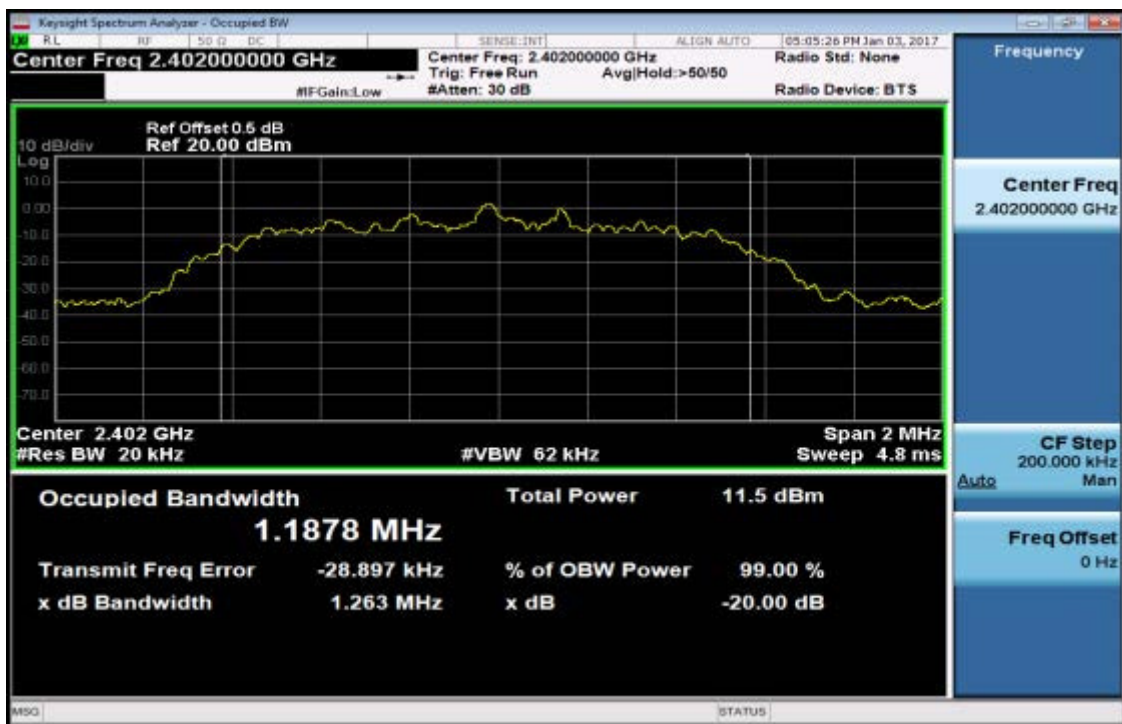

Unless otherwise stated the results shown in this test report refer only to the sample(s) tested and such sample(s) are retained for 90 days only.

除非另有說明，此報告結果僅對測試之樣品負責，同時此樣品僅保留90天。本報告未經本公司書面許可，不可部份複製。

This document is issued by the Company subject to its General Conditions of Service printed overleaf, available on request or accessible at www.sgs.com/terms_and_conditions.htm and, for electronic format documents, subject to Terms and Conditions for Electronic Documents at www.sgs.com/terms_e-document.htm. Attention is drawn to the limitation of liability, indemnification and jurisdiction issues defined therein. Any holder of this document is advised that information contained hereon reflects the Company's findings at the time of its intervention only and within the limits of Client's instructions, if any. The Company's sole responsibility is to its Client and this document does not exonerate parties to a transaction from exercising all their rights and obligations under the transaction documents. This document cannot be reproduced except in full, without prior written approval of the Company. Any unauthorized alteration, forgery or falsification of the content or appearance of this document is unlawful and offenders may be prosecuted to the fullest extent of the law.

SGS Taiwan Ltd.

No. 134, WuKungRoad, NewTaipeiIndustrialPark, WukuDistrict, NewTaipeiCity, Taiwan24803/新北市五股區新北產業園區五工路 134 號

台灣檢驗科技股份有限公司

t (886-2) 2299-3279

f (886-2) 2298-0488

www.tw.sgs.com

Member of SGS Group

99% Band Width Test Data CH-Mid ($\pi/4$ -DQPSK mode)

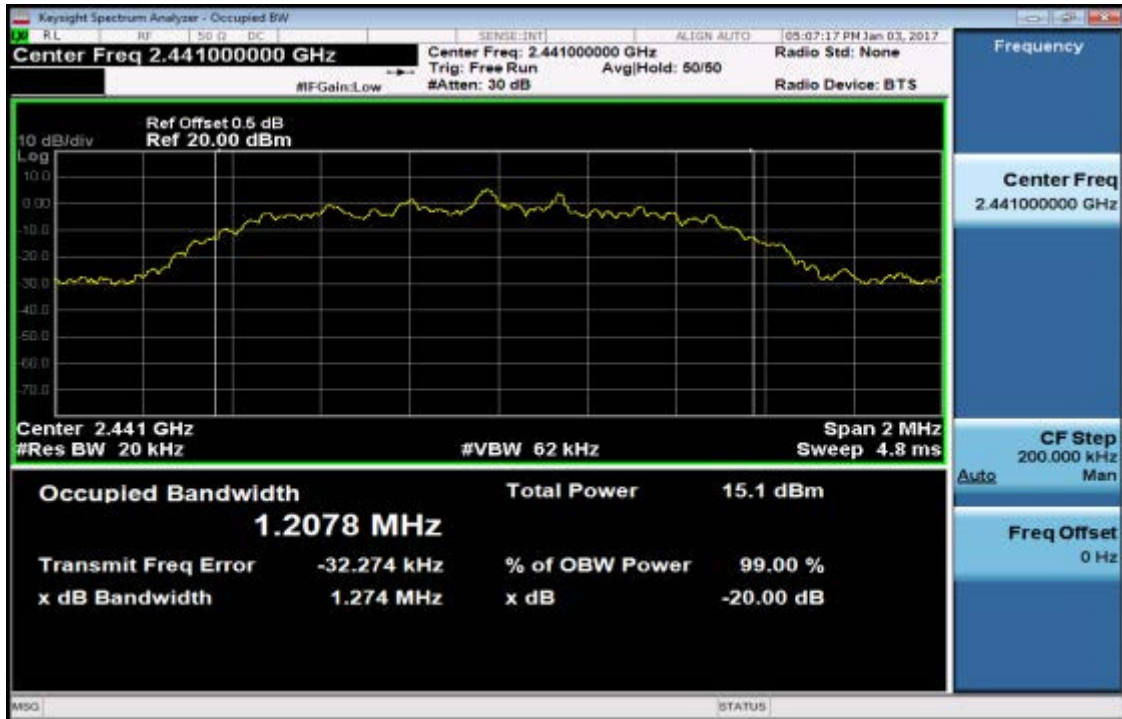

99% Band Width Test Data CH-High ($\pi/4$ -DQPSK mode)

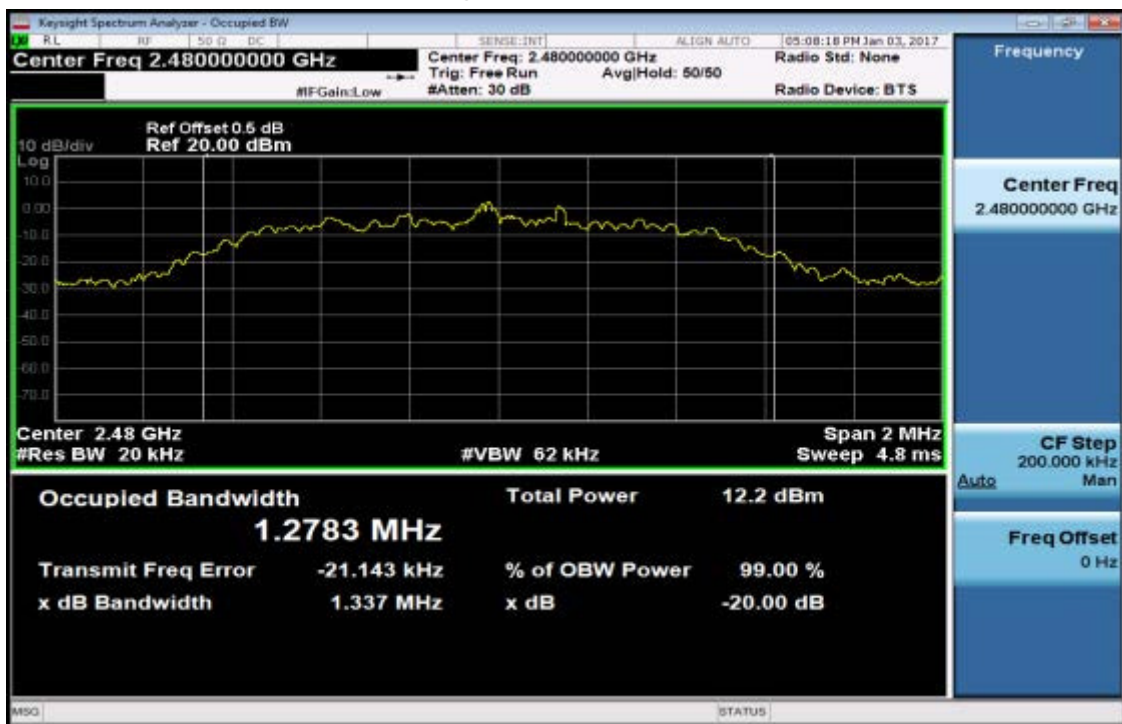

Unless otherwise stated the results shown in this test report refer only to the sample(s) tested and such sample(s) are retained for 90 days only.

除非另有說明，此報告結果僅對測試之樣品負責，同時此樣品僅保留90天。本報告未經本公司書面許可，不可部份複製。

This document is issued by the Company subject to its General Conditions of Service printed overleaf, available on request or accessible at www.sgs.com/terms_and_conditions.htm and, for electronic format documents, subject to Terms and Conditions for Electronic Documents at www.sgs.com/terms_e-document.htm. Attention is drawn to the limitation of liability, indemnification and jurisdiction issues defined therein. Any holder of this document is advised that information contained hereon reflects the Company's findings at the time of its intervention only and within the limits of Client's instructions, if any. The Company's sole responsibility is to its Client and this document does not exonerate parties to a transaction from exercising all their rights and obligations under the transaction documents. This document cannot be reproduced except in full, without prior written approval of the Company. Any unauthorized alteration, forgery or falsification of the content or appearance of this document is unlawful and offenders may be prosecuted to the fullest extent of the law.

SGS Taiwan Ltd.

No. 134, WuKung Road, New Taipei Industrial Park, Wuku District, New Taipei City, Taiwan 24803 / 新北市五股區新北產業園區五工路 134 號

台灣檢驗科技股份有限公司

t (886-2) 2299-3279

f (886-2) 2298-0488

www.tw.sgs.com

Member of SGS Group

99% Band Width Test Data CH-Low (8-DPSK mode)

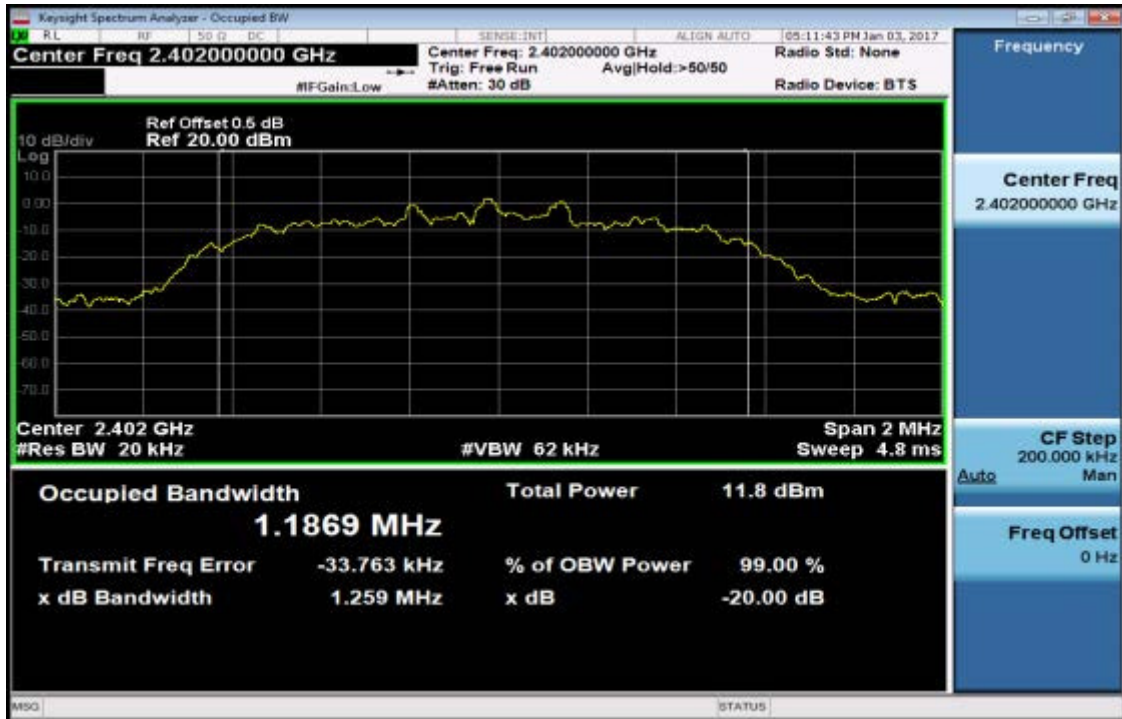

99% Band Width Test Data CH-Mid (8-DPSK mode)

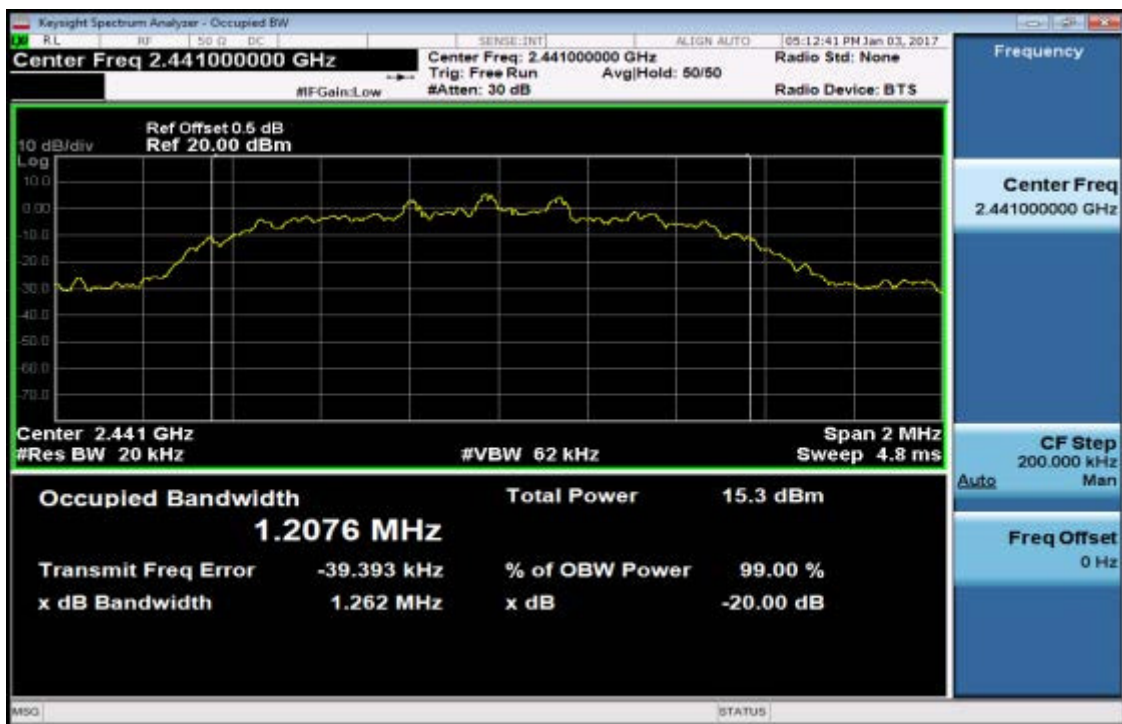

Unless otherwise stated the results shown in this test report refer only to the sample(s) tested and such sample(s) are retained for 90 days only.

除非另有說明，此報告結果僅對測試之樣品負責，同時此樣品僅保留90天。本報告未經本公司書面許可，不可部份複製。

This document is issued by the Company subject to its General Conditions of Service printed overleaf, available on request or accessible at www.sgs.com/terms_and_conditions.htm and, for electronic format documents, subject to Terms and Conditions for Electronic Documents at www.sgs.com/terms_e-document.htm. Attention is drawn to the limitation of liability, indemnification and jurisdiction issues defined therein. Any holder of this document is advised that information contained hereon reflects the Company's findings at the time of its intervention only and within the limits of Client's instructions, if any. The Company's sole responsibility is to its Client and this document does not exonerate parties to a transaction from exercising all their rights and obligations under the transaction documents. This document cannot be reproduced except in full, without prior written approval of the Company. Any unauthorized alteration, forgery or falsification of the content or appearance of this document is unlawful and offenders may be prosecuted to the fullest extent of the law.

SGS Taiwan Ltd.

No. 134, WuKung Road, New Taipei Industrial Park, Wuku District, New Taipei City, Taiwan 24803 / 新北市五股區新北產業園區五工路 134 號

台灣檢驗科技股份有限公司

t (886-2) 2299-3279

f (886-2) 2298-0488

www.tw.sgs.com

Member of SGS Group

99% Band Width Test Data CH-High (8-DPSK mode)

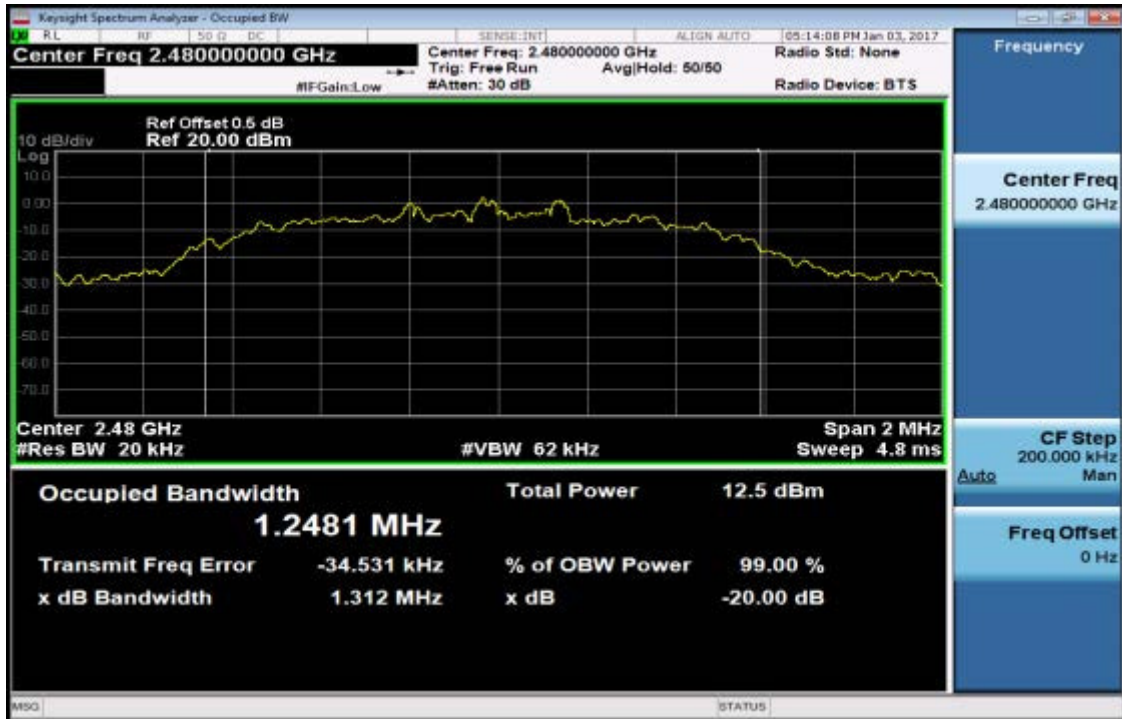

Unless otherwise stated the results shown in this test report refer only to the sample(s) tested and such sample(s) are retained for 90 days only.

除非另有說明，此報告結果僅對測試之樣品負責，同時此樣品僅保留90天。本報告未經本公司書面許可，不可部份複製。

This document is issued by the Company subject to its General Conditions of Service printed overleaf, available on request or accessible at www.sgs.com/terms_and_conditions.htm and, for electronic format documents, subject to Terms and Conditions for Electronic Documents at www.sgs.com/terms_e-document.htm. Attention is drawn to the limitation of liability, indemnification and jurisdiction issues defined therein. Any holder of this document is advised that information contained hereon reflects the Company's findings at the time of its intervention only and within the limits of Client's instructions, if any. The Company's sole responsibility is to its Client and this document does not exonerate parties to a transaction from exercising all their rights and obligations under the transaction documents. This document cannot be reproduced except in full, without prior written approval of the Company. Any unauthorized alteration, forgery or falsification of the content or appearance of this document is unlawful and offenders may be prosecuted to the fullest extent of the law.

SGS Taiwan Ltd.

No. 134, WuKungRoad, NewTaipeiIndustrialPark, WukuDistrict, NewTaipeiCity, Taiwan24803/新北市五股區新北產業園區五工路 134 號

台灣檢驗科技股份有限公司

t (886-2) 2299-3279

f (886-2) 2298-0488

www.tw.sgs.com

Member of SGS Group

9 CONDUCTED BAND EDGES AND SPURIOUS EMISSION MEASUREMENT

9.1 Standard Applicable

In any 100 kHz bandwidth outside the frequency band in which the spread spectrum or digitally modulated intentional radiator is operating, the radio frequency power that is produced by the intentional radiator shall be at least 20 dB below that in the 100 kHz bandwidth within the band that contains the highest level of the desired power, based on either an RF conducted or a radiated measurement, provided the transmitter demonstrates compliance with the peak conducted power limits. In addition, radiated emissions which fall in the restricted bands, as defined in §15.205(a), must also comply with the radiated emission limits specified in §15.209(a).

9.2 Measurement Equipment Used

Conducted Emission Test Site					
EQUIPMENT TYPE	MFR	MODEL NUMBER	SERIAL NUMBER	LAST CAL.	CAL DUE.
EXA Spectrum Analyzer	Agilent	N9030A	MY53120760	02/26/2016	02/25/2017
DC Block	Mini-Circuits	BLK-18-S+	1	01/02/2016	01/01/2017
Attenuator	Mini-Circuit	BW-S10W2+	2	01/02/2016	01/01/2017
Splitter	Agilent	11636B	N/A	01/02/2016	01/01/2017

EQUIPMENT TYPE	MFR	MODEL NUMBER	SERIAL NUMBER	LAST CAL.	CAL DUE.
DC Block	Mini-Circuits	BLK-18-S+	1	01/02/2017	01/01/2018
Attenuator	Mini-Circuit	BW-S10W2+	2	01/02/2017	01/01/2018
Splitter	Agilent	11636B	N/A	01/02/2017	01/01/2018

Note: The measurement was taken place with the long duration of the time, and additional equipment list as shown above indicate those equipment of which has been subject to undertake the calibration in intermediate period of time of the measurement.

9.3 Test SET-UP

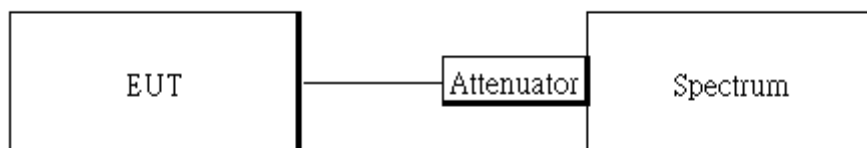

Unless otherwise stated the results shown in this test report refer only to the sample(s) tested and such sample(s) are retained for 90 days only.

除非另有說明，此報告結果僅對測試之樣品負責，同時此樣品僅保留90天。本報告未經本公司書面許可，不可部份複製。

This document is issued by the Company subject to its General Conditions of Service printed overleaf, available on request or accessible at www.sgs.com/terms_and_conditions.htm and, for electronic format documents, subject to Terms and Conditions for Electronic Documents at www.sgs.com/terms_e-document.htm. Attention is drawn to the limitation of liability, indemnification and jurisdiction issues defined therein. Any holder of this document is advised that information contained hereon reflects the Company's findings at the time of its intervention only and within the limits of Client's instructions, if any. The Company's sole responsibility is to its Client and this document does not exonerate parties to a transaction from exercising all their rights and obligations under the transaction documents. This document cannot be reproduced except in full, without prior written approval of the Company. Any unauthorized alteration, forgery or falsification of the content or appearance of this document is unlawful and offenders may be prosecuted to the fullest extent of the law.

SGS Taiwan Ltd.

No.134,WuKungRoad,NewTaipeiIndustrialPark,WukuDistrict,NewTaipeiCity,Taiwan24803/新北市五股區新北產業園區五工路 134 號

台灣檢驗科技股份有限公司

t (886-2) 2299-3279

f (886-2) 2298-0488

www.tw.sgs.com

Member of SGS Group

9.4 Measurement Procedure

Conducted Band Edge:

1. Place the EUT on the table and set it in transmitting mode.
2. The testing follows FCC Public Notice DA 00-705 Measurement Guidelines.
3. Remove the antenna from the EUT and then connect a low loss RF cable from the antenna port to the spectrum analyzer.
4. Set center frequency of spectrum analyzer = operating frequency.
5. Set the spectrum analyzer as RBW=100 kHz, VBW=300 kHz, Sweep = auto
6. Mark Peak, 2.3999GHz and 2.4836GHz and record the max. level.
7. Repeat above procedures until all frequency measured were complete.

Conducted Spurious Emission:

1. To connect Antenna Port of EUT to Spectrum.
2. The testing follows FCC Public Notice DA 00-705 Measurement Guidelines.
3. Set RBW = 100 kHz & VBW = 300 kHz, Detector =Peak, Sweep = Auto
4. Allow trace to fully stabilize.
5. Use the peak marker function to determine the maximum power level in any 100 kHz band segment within the fundamental EBW.
6. Repeat above procedures until all default test channel measured were complete.

The field strength is calculated by adding the Antenna Factor and Cable Factor and subtracting the Amplifier Gain and Duty Cycle Correction Factor (if any) from the measured reading. The basic equation with a sample calculation is as follows:

$$FS = RA + AF + CL - AG$$

Where	FS = Field Strength	CL = Cable Attenuation Factor (Cable Loss)
	RA = Reading Amplitude	AG = Amplifier Gain
	AF = Antenna Factor	

9.5 Measurement Result

Note: Refer to next page spectrum analyzer data chart and tabular data sheets.

1. The occurrence of the spike on the conducted emission is the signal of the fundamental emission.

Unless otherwise stated the results shown in this test report refer only to the sample(s) tested and such sample(s) are retained for 90 days only.

除非另有說明，此報告結果僅對測試之樣品負責，同時此樣品僅保留90天。本報告未經本公司書面許可，不可部份複製。

This document is issued by the Company subject to its General Conditions of Service printed overleaf, available on request or accessible at www.sgs.com/terms_and_conditions.htm and, for electronic format documents, subject to Terms and Conditions for Electronic Documents at www.sgs.com/terms_e-document.htm. Attention is drawn to the limitation of liability, indemnification and jurisdiction issues defined therein. Any holder of this document is advised that information contained hereon reflects the Company's findings at the time of its intervention only and within the limits of Client's instructions, if any. The Company's sole responsibility is to its Client and this document does not exonerate parties to a transaction from exercising all their rights and obligations under the transaction documents. This document cannot be reproduced except in full, without prior written approval of the Company. Any unauthorized alteration, forgery or falsification of the content or appearance of this document is unlawful and offenders may be prosecuted to the fullest extent of the law.

SGS Taiwan Ltd.

No.134,WuKungRoad,NewTaipeiIndustrialPark,WukuDistrict,NewTaipeiCity,Taiwan24803/新北市五股區新北產業園區五工路 134 號

台灣檢驗科技股份有限公司

t (886-2) 2299-3279

f (886-2) 2298-0488

www.tw.sgs.com

Member of SGS Group

Band Edges Test Data CH-Low (Hopping mode) (GFSK mode)

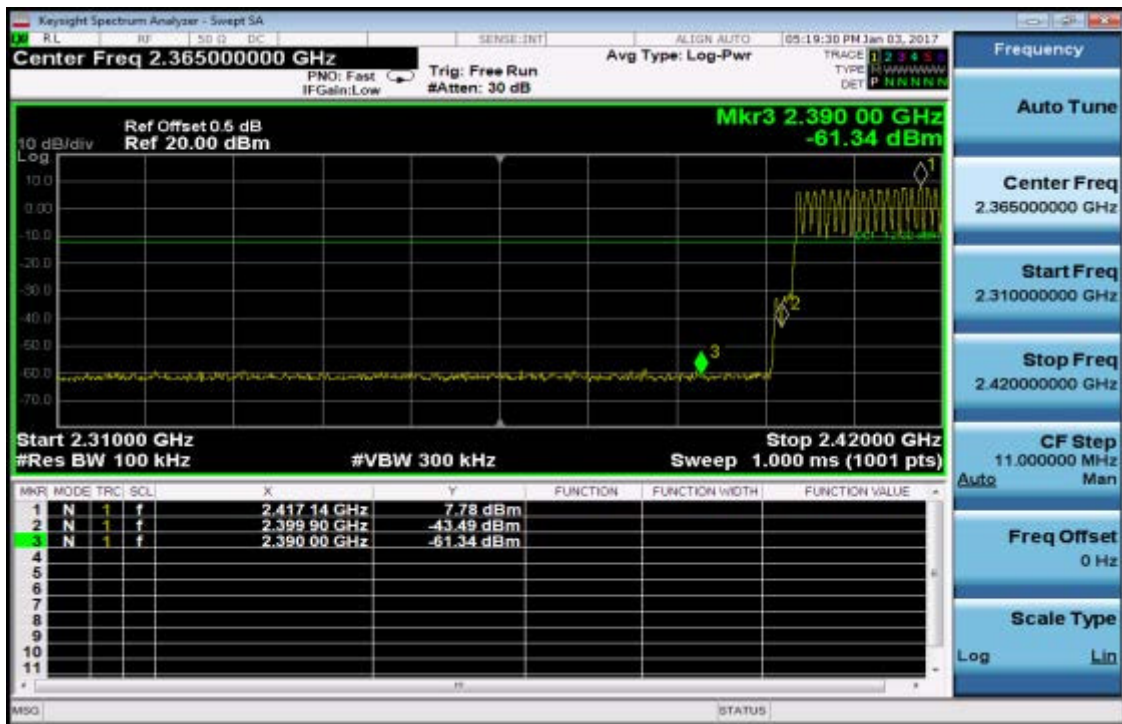

Band Edges Test Data CH-High



Unless otherwise stated the results shown in this test report refer only to the sample(s) tested and such sample(s) are retained for 90 days only.

除非另有說明，此報告結果僅對測試之樣品負責，同時此樣品僅保留90天。本報告未經本公司書面許可，不可部份複製。

This document is issued by the Company subject to its General Conditions of Service printed overleaf, available on request or accessible at www.sgs.com/terms_and_conditions.htm and, for electronic format documents, subject to Terms and Conditions for Electronic Documents at www.sgs.com/terms_e-document.htm. Attention is drawn to the limitation of liability, indemnification and jurisdiction issues defined therein. Any holder of this document is advised that information contained hereon reflects the Company's findings at the time of its intervention only and within the limits of Client's instructions, if any. The Company's sole responsibility is to its Client and this document does not exonerate parties to a transaction from exercising all their rights and obligations under the transaction documents. This document cannot be reproduced except in full, without prior written approval of the Company. Any unauthorized alteration, forgery or falsification of the content or appearance of this document is unlawful and offenders may be prosecuted to the fullest extent of the law.

SGS Taiwan Ltd.

No. 134, WuKungRoad, NewTaipeiIndustrialPark, WukuDistrict, NewTaipeiCity, Taiwan24803/新北市五股區新北產業園區五工路 134 號

台灣檢驗科技股份有限公司

t (886-2) 2299-3279

f (886-2) 2298-0488

www.tw.sgs.com

Member of SGS Group

Band Edges Test Data CH-Low (Non-Hopping mode) (GFSK mode)

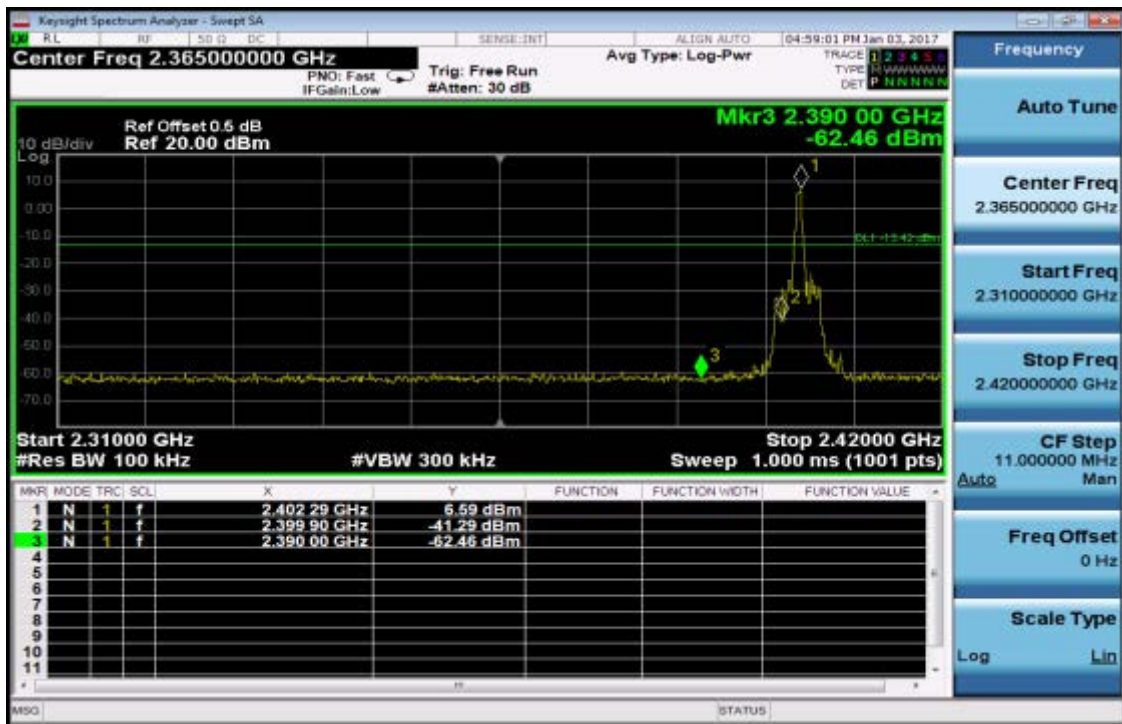

Band Edges Test Data CH-High



Unless otherwise stated the results shown in this test report refer only to the sample(s) tested and such sample(s) are retained for 90 days only.

除非另有說明，此報告結果僅對測試之樣品負責，同時此樣品僅保留90天。本報告未經本公司書面許可，不可部份複製。

This document is issued by the Company subject to its General Conditions of Service printed overleaf, available on request or accessible at www.sgs.com/terms_and_conditions.htm and, for electronic format documents, subject to Terms and Conditions for Electronic Documents at www.sgs.com/terms_e-document.htm. Attention is drawn to the limitation of liability, indemnification and jurisdiction issues defined therein. Any holder of this document is advised that information contained hereon reflects the Company's findings at the time of its intervention only and within the limits of Client's instructions, if any. The Company's sole responsibility is to its Client and this document does not exonerate parties to a transaction from exercising all their rights and obligations under the transaction documents. This document cannot be reproduced except in full, without prior written approval of the Company. Any unauthorized alteration, forgery or falsification of the content or appearance of this document is unlawful and offenders may be prosecuted to the fullest extent of the law.

SGS Taiwan Ltd.

No.134,WuKungRoad,NewTaipeiIndustrialPark,WukuDistrict,NewTaipeiCity,Taiwan24803/新北市五股區新北產業園區五工路 134 號

台灣檢驗科技股份有限公司

t (886-2) 2299-3279

f (886-2) 2298-0488

www.tw.sgs.com

Member of SGS Group

Band Edges Test Data CH-Low (Hopping mode) (8-DPSK mode)



Band Edges Test Data CH-High



Unless otherwise stated the results shown in this test report refer only to the sample(s) tested and such sample(s) are retained for 90 days only.

除非另有說明，此報告結果僅對測試之樣品負責，同時此樣品僅保留90天。本報告未經本公司書面許可，不可部份複製。

This document is issued by the Company subject to its General Conditions of Service printed overleaf, available on request or accessible at www.sgs.com/terms_and_conditions.htm and, for electronic format documents, subject to Terms and Conditions for Electronic Documents at www.sgs.com/terms_e-document.htm. Attention is drawn to the limitation of liability, indemnification and jurisdiction issues defined therein. Any holder of this document is advised that information contained hereon reflects the Company's findings at the time of its intervention only and within the limits of Client's instructions, if any. The Company's sole responsibility is to its Client and this document does not exonerate parties to a transaction from exercising all their rights and obligations under the transaction documents. This document cannot be reproduced except in full, without prior written approval of the Company. Any unauthorized alteration, forgery or falsification of the content or appearance of this document is unlawful and offenders may be prosecuted to the fullest extent of the law.

SGS Taiwan Ltd.

No.134,WuKungRoad,NewTaipeiIndustrialPark,WukuDistrict,NewTaipeiCity,Taiwan24803/新北市五股區新北產業園區五工路 134 號

台灣檢驗科技股份有限公司

t (886-2) 2299-3279

f (886-2) 2298-0488

www.tw.sgs.com

Member of SGS Group

Band Edges Test Data CH-Low (Non-Hopping mode) (8-DPSK mode)

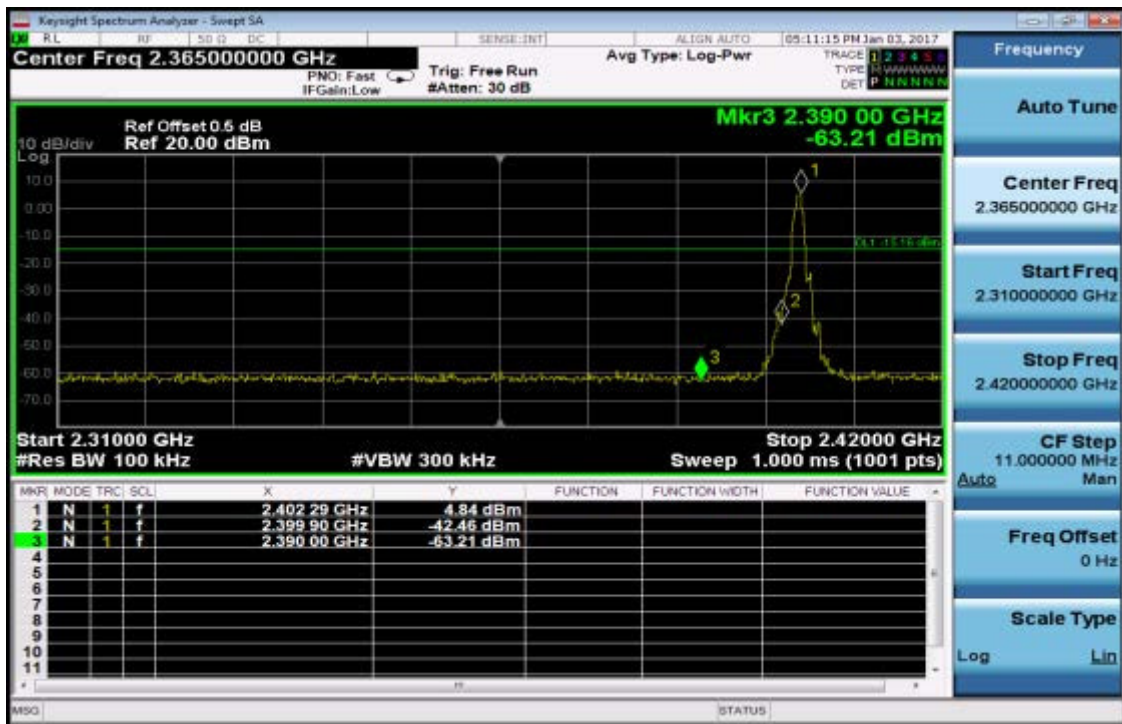

Band Edges Test Data CH-High



Unless otherwise stated the results shown in this test report refer only to the sample(s) tested and such sample(s) are retained for 90 days only.

除非另有說明，此報告結果僅對測試之樣品負責，同時此樣品僅保留90天。本報告未經本公司書面許可，不可部份複製。

This document is issued by the Company subject to its General Conditions of Service printed overleaf, available on request or accessible at www.sgs.com/terms_and_conditions.htm and, for electronic format documents, subject to Terms and Conditions for Electronic Documents at www.sgs.com/terms_e-document.htm. Attention is drawn to the limitation of liability, indemnification and jurisdiction issues defined therein. Any holder of this document is advised that information contained hereon reflects the Company's findings at the time of its intervention only and within the limits of Client's instructions, if any. The Company's sole responsibility is to its Client and this document does not exonerate parties to a transaction from exercising all their rights and obligations under the transaction documents. This document cannot be reproduced except in full, without prior written approval of the Company. Any unauthorized alteration, forgery or falsification of the content or appearance of this document is unlawful and offenders may be prosecuted to the fullest extent of the law.

SGS Taiwan Ltd.

No.134,WuKungRoad,NewTaipeiIndustrialPark,WukuDistrict,NewTaipeiCity,Taiwan24803/新北市五股區新北產業園區五工路 134 號

台灣檢驗科技股份有限公司

t (886-2) 2299-3279

f (886-2) 2298-0488

www.tw.sgs.com

Member of SGS Group

Conducted Spurious Emission Measurement Result (GFSK mode) Ch Low 30MHz – 3GHz

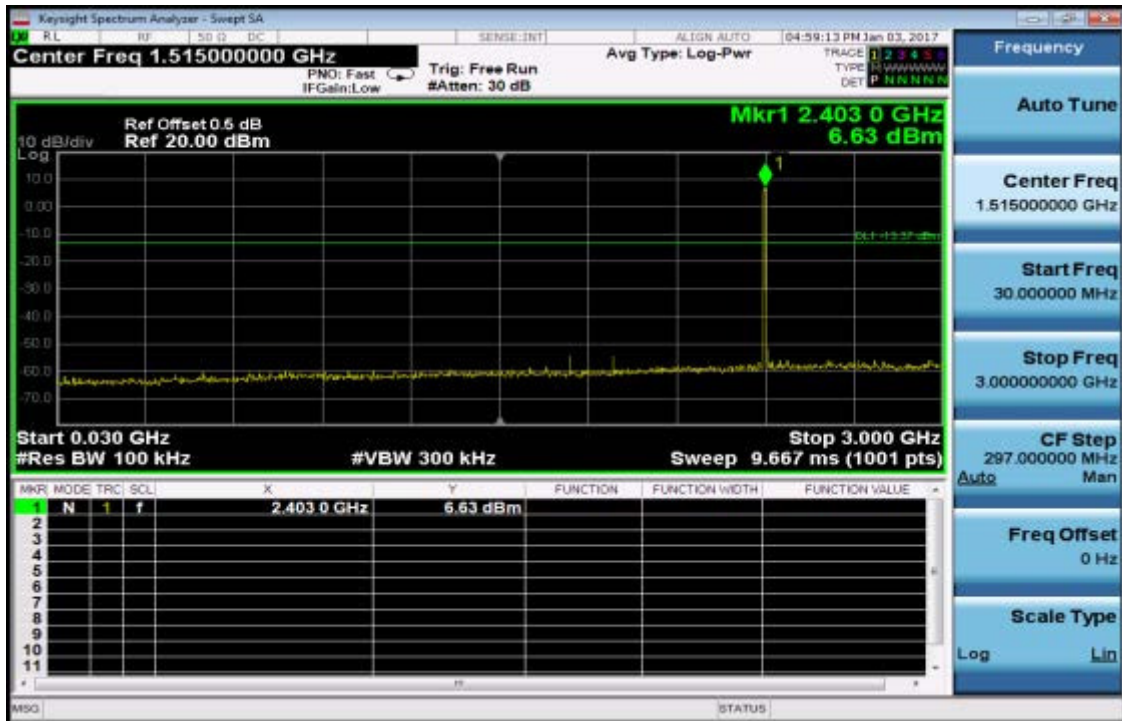

Ch Low 3GHz – 26.5GHz

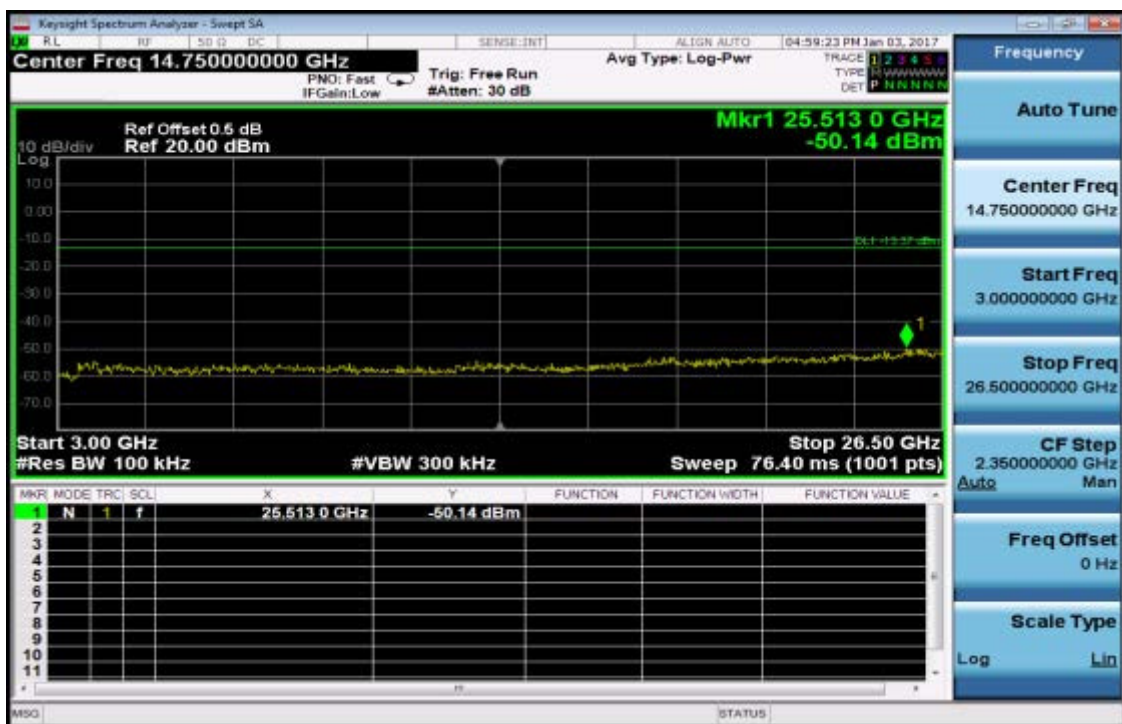

Unless otherwise stated the results shown in this test report refer only to the sample(s) tested and such sample(s) are retained for 90 days only.

除非另有說明，此報告結果僅對測試之樣品負責，同時此樣品僅保留90天。本報告未經本公司書面許可，不可部份複製。

This document is issued by the Company subject to its General Conditions of Service printed overleaf, available on request or accessible at www.sgs.com/terms_and_conditions.htm and, for electronic format documents, subject to Terms and Conditions for Electronic Documents at www.sgs.com/terms_e-document.htm. Attention is drawn to the limitation of liability, indemnification and jurisdiction issues defined therein. Any holder of this document is advised that information contained hereon reflects the Company's findings at the time of its intervention only and within the limits of Client's instructions, if any. The Company's sole responsibility is to its Client and this document does not exonerate parties to a transaction from exercising all their rights and obligations under the transaction documents. This document cannot be reproduced except in full, without prior written approval of the Company. Any unauthorized alteration, forgery or falsification of the content or appearance of this document is unlawful and offenders may be prosecuted to the fullest extent of the law.

SGS Taiwan Ltd.

No. 134, WuKungRoad, NewTaipeiIndustrialPark, WukuDistrict, NewTaipeiCity, Taiwan24803/新北市五股區新北產業園區五工路 134 號

台灣檢驗科技股份有限公司

t (886-2) 2299-3279

f (886-2) 2298-0488

www.tw.sgs.com

Member of SGS Group

Ch Mid 30MHz – 3GHz

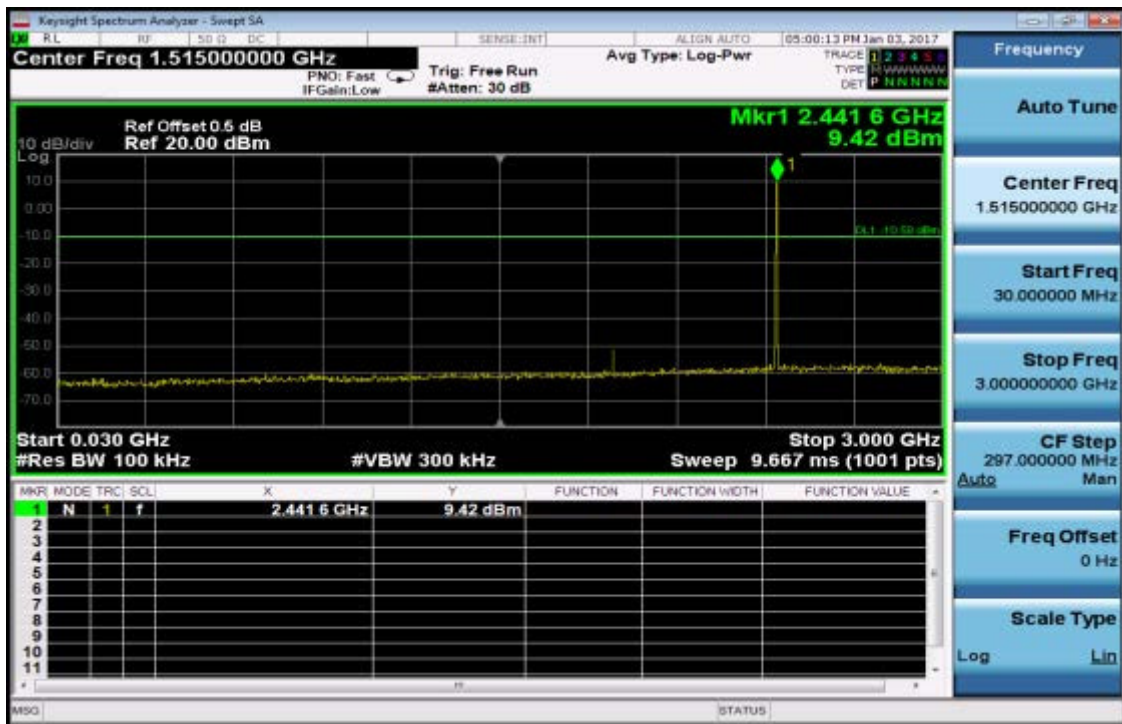

Ch Mid 3GHz – 26.5GHz

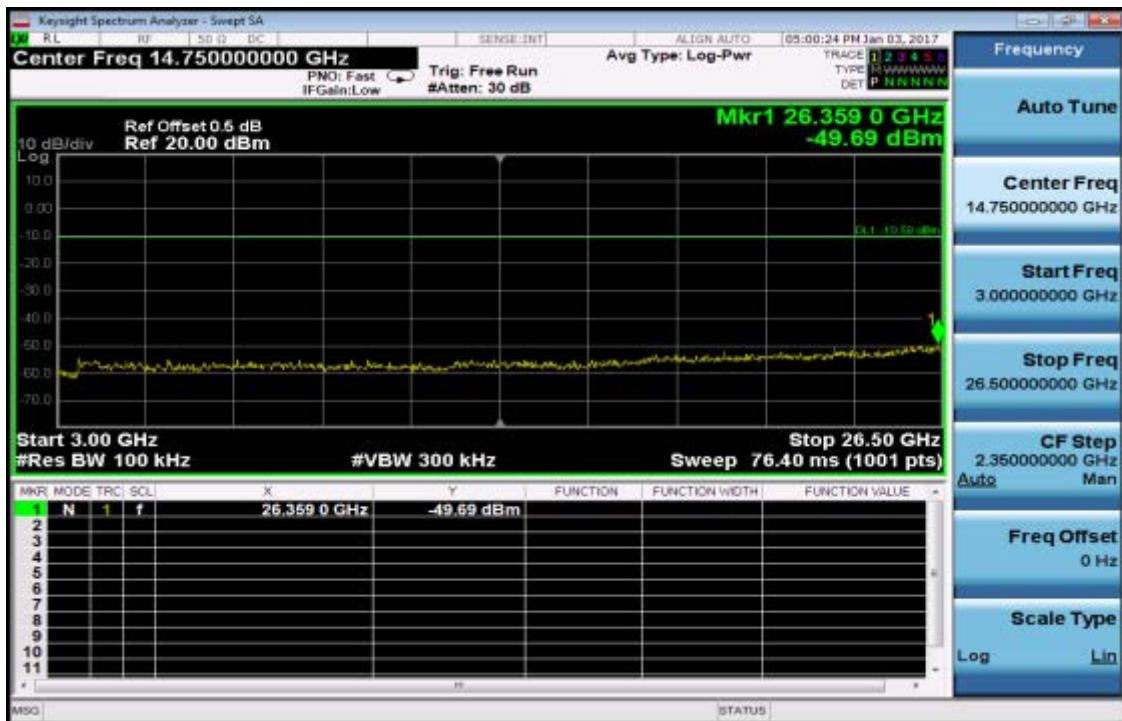

Unless otherwise stated the results shown in this test report refer only to the sample(s) tested and such sample(s) are retained for 90 days only.

除非另有說明，此報告結果僅對測試之樣品負責，同時此樣品僅保留90天。本報告未經本公司書面許可，不可部份複製。

This document is issued by the Company subject to its General Conditions of Service printed overleaf, available on request or accessible at www.sgs.com/terms_and_conditions.htm and, for electronic format documents, subject to Terms and Conditions for Electronic Documents at www.sgs.com/terms_e-document.htm. Attention is drawn to the limitation of liability, indemnification and jurisdiction issues defined therein. Any holder of this document is advised that information contained hereon reflects the Company's findings at the time of its intervention only and within the limits of Client's instructions, if any. The Company's sole responsibility is to its Client and this document does not exonerate parties to a transaction from exercising all their rights and obligations under the transaction documents. This document cannot be reproduced except in full, without prior written approval of the Company. Any unauthorized alteration, forgery or falsification of the content or appearance of this document is unlawful and offenders may be prosecuted to the fullest extent of the law.

SGS Taiwan Ltd.

No.134,WuKungRoad,NewTaipeiIndustrialPark,WukuDistrict,NewTaipeiCity,Taiwan24803/新北市五股區新北產業園區五工路 134 號

台灣檢驗科技股份有限公司

t (886-2) 2299-3279

f (886-2) 2298-0488

www.tw.sgs.com

Member of SGS Group

Ch High 30MHz – 3GHz

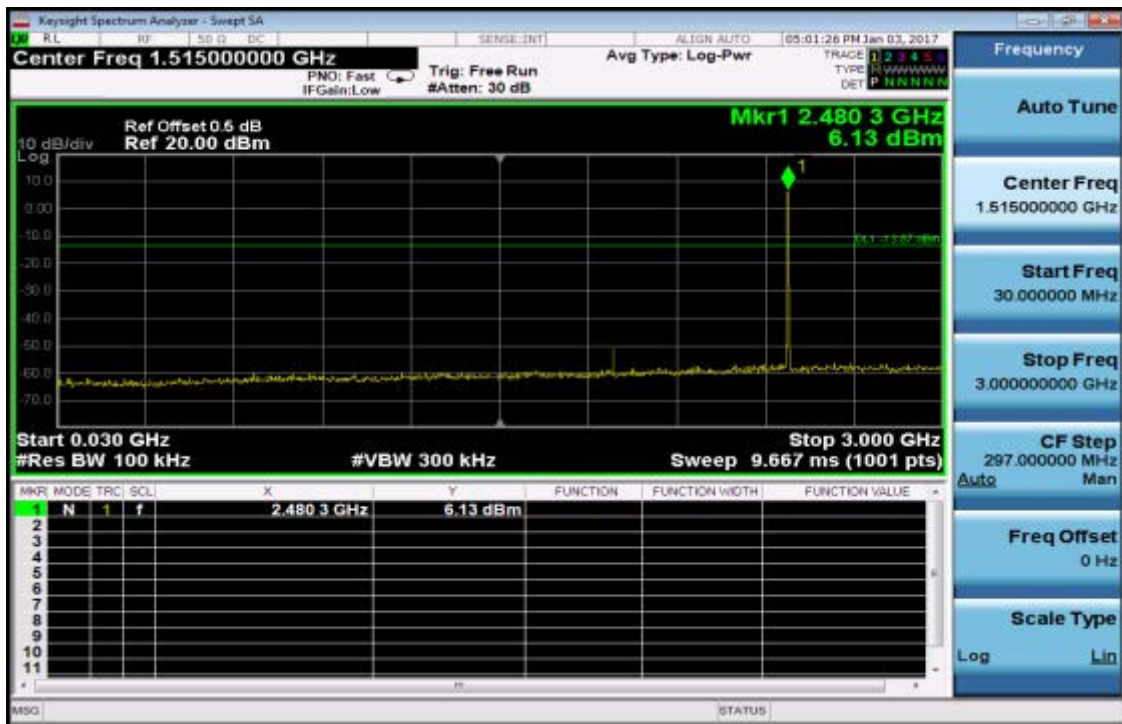

Ch High 3GHz – 26.5GHz

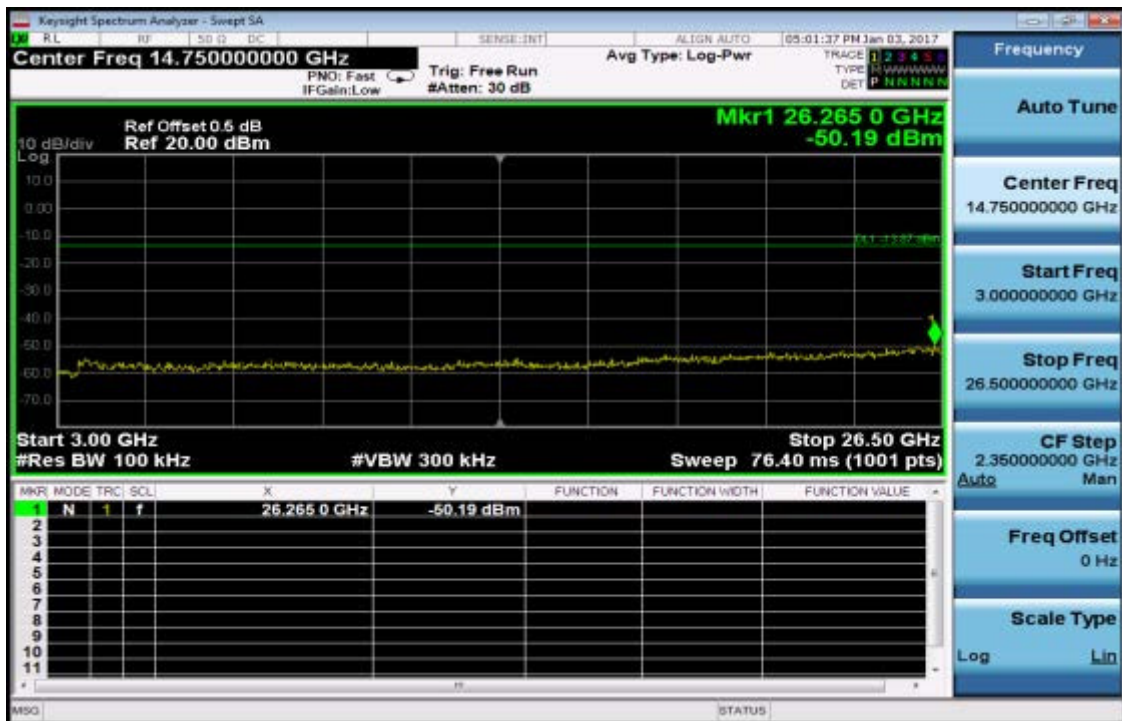

Unless otherwise stated the results shown in this test report refer only to the sample(s) tested and such sample(s) are retained for 90 days only.

除非另有說明，此報告結果僅對測試之樣品負責，同時此樣品僅保留90天。本報告未經本公司書面許可，不可部份複製。

This document is issued by the Company subject to its General Conditions of Service printed overleaf, available on request or accessible at www.sgs.com/terms_and_conditions.htm and, for electronic format documents, subject to Terms and Conditions for Electronic Documents at www.sgs.com/terms_e-document.htm. Attention is drawn to the limitation of liability, indemnification and jurisdiction issues defined therein. Any holder of this document is advised that information contained hereon reflects the Company's findings at the time of its intervention only and within the limits of Client's instructions, if any. The Company's sole responsibility is to its Client and this document does not exonerate parties to a transaction from exercising all their rights and obligations under the transaction documents. This document cannot be reproduced except in full, without prior written approval of the Company. Any unauthorized alteration, forgery or falsification of the content or appearance of this document is unlawful and offenders may be prosecuted to the fullest extent of the law.

SGS Taiwan Ltd.

No.134,WuKungRoad,NewTaipeiIndustrialPark,WukuDistrict,NewTaipeiCity,Taiwan24803/新北市五股區新北產業園區五工路 134 號

台灣檢驗科技股份有限公司

t (886-2) 2299-3279

f (886-2) 2298-0488

www.tw.sgs.com

Member of SGS Group

Conducted Spurious Emission Measurement Result (8DPSK mode) Ch Low 30MHz – 3GHz

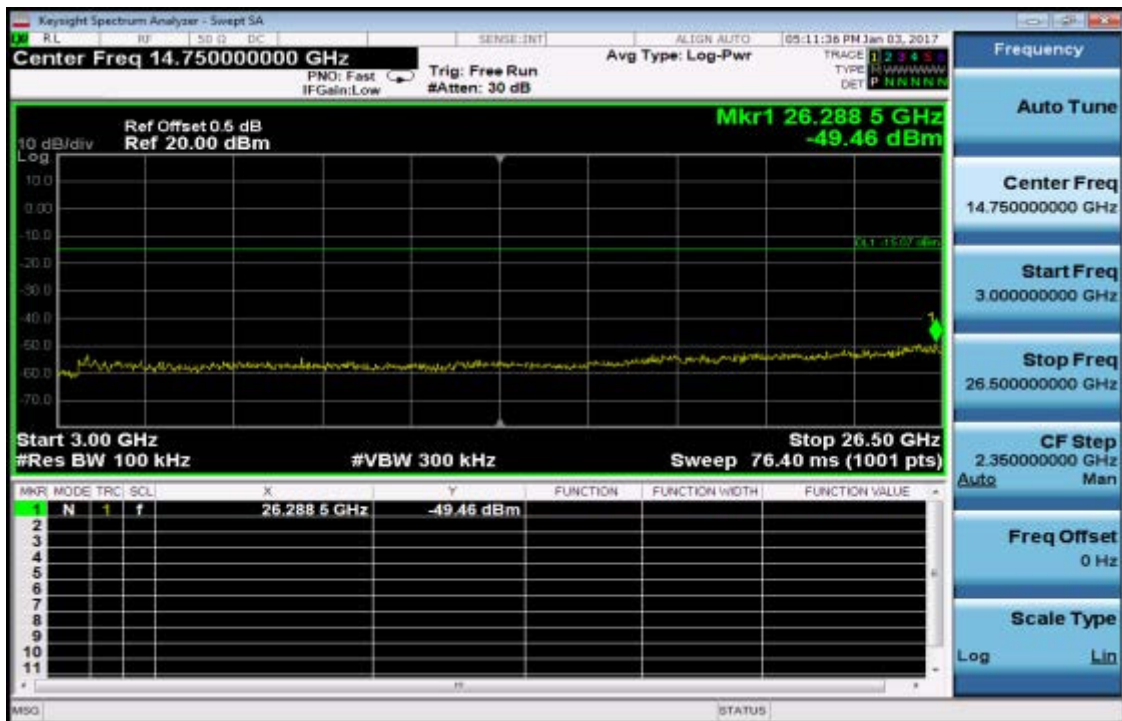
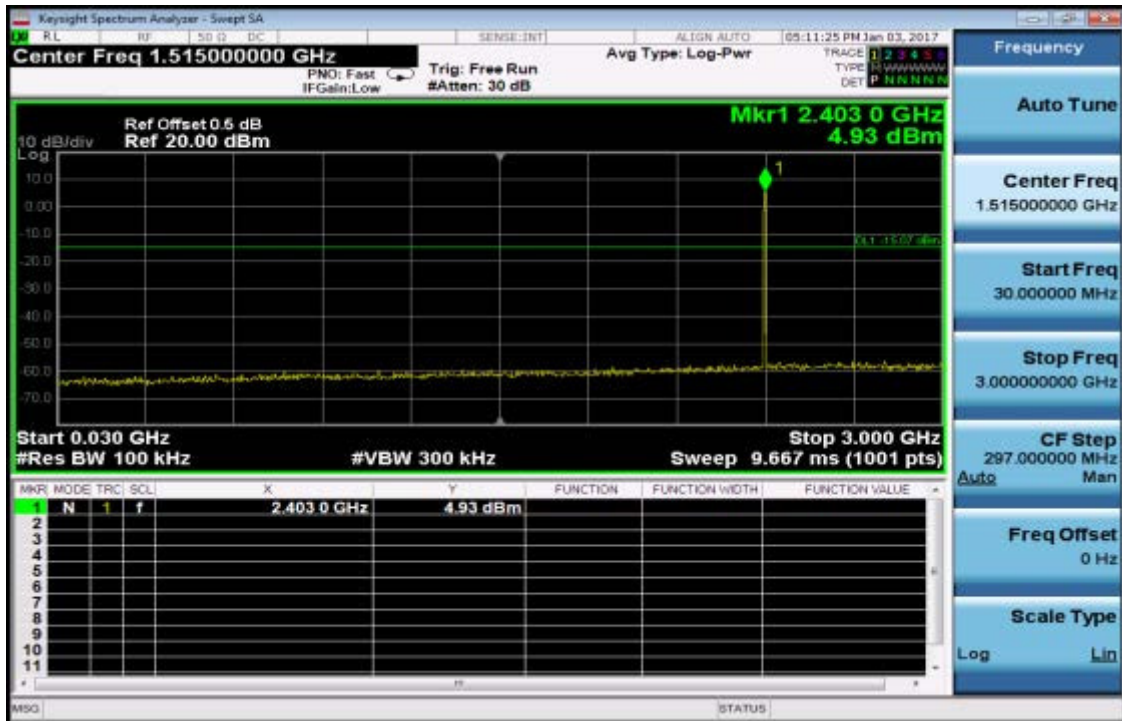

Unless otherwise stated the results shown in this test report refer only to the sample(s) tested and such sample(s) are retained for 90 days only.

除非另有說明，此報告結果僅對測試之樣品負責，同時此樣品僅保留90天。本報告未經本公司書面許可，不可部份複製。

This document is issued by the Company subject to its General Conditions of Service printed overleaf, available on request or accessible at www.sgs.com/terms_and_conditions.htm and, for electronic format documents, subject to Terms and Conditions for Electronic Documents at www.sgs.com/terms_e-document.htm. Attention is drawn to the limitation of liability, indemnification and jurisdiction issues defined therein. Any holder of this document is advised that information contained hereon reflects the Company's findings at the time of its intervention only and within the limits of Client's instructions, if any. The Company's sole responsibility is to its Client and this document does not exonerate parties to a transaction from exercising all their rights and obligations under the transaction documents. This document cannot be reproduced except in full, without prior written approval of the Company. Any unauthorized alteration, forgery or falsification of the content or appearance of this document is unlawful and offenders may be prosecuted to the fullest extent of the law.

SGS Taiwan Ltd.

No. 134, WuKungRoad, NewTaipeiIndustrialPark, WukuDistrict, NewTaipeiCity, Taiwan24803/新北市五股區新北產業園區五工路 134 號

台灣檢驗科技股份有限公司

t (886-2) 2299-3279

f (886-2) 2298-0488

www.tw.sgs.com

Member of SGS Group

Ch Mid 30MHz – 3GHz

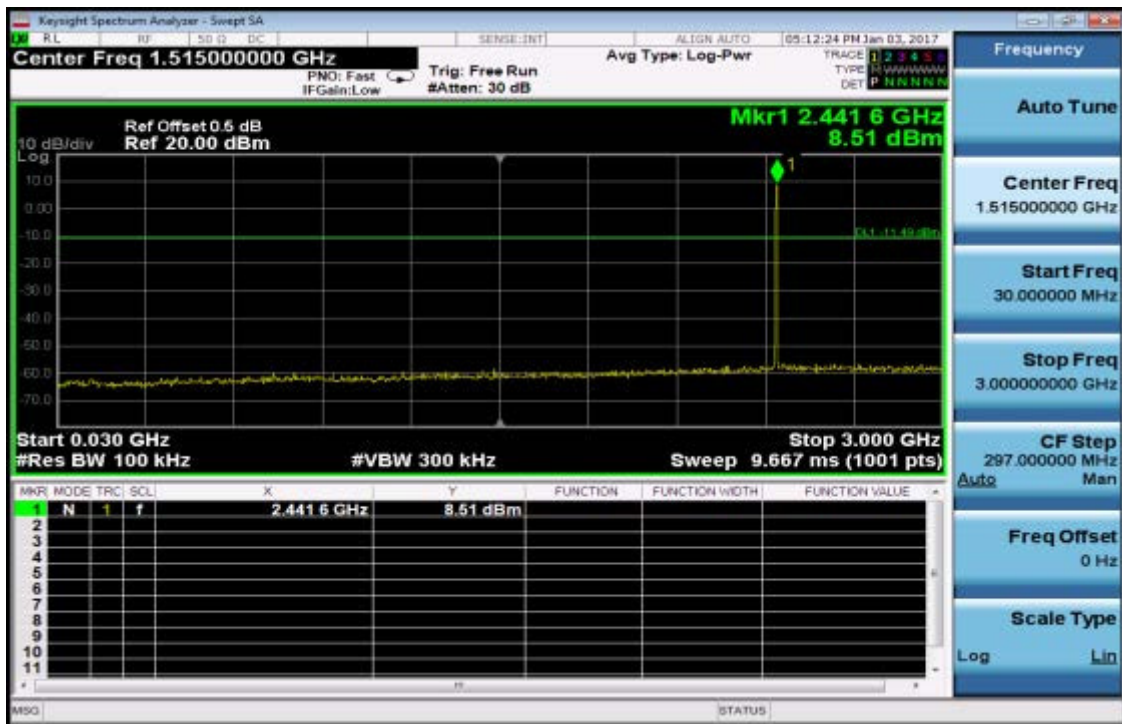

Ch Mid 3GHz – 26.5GHz

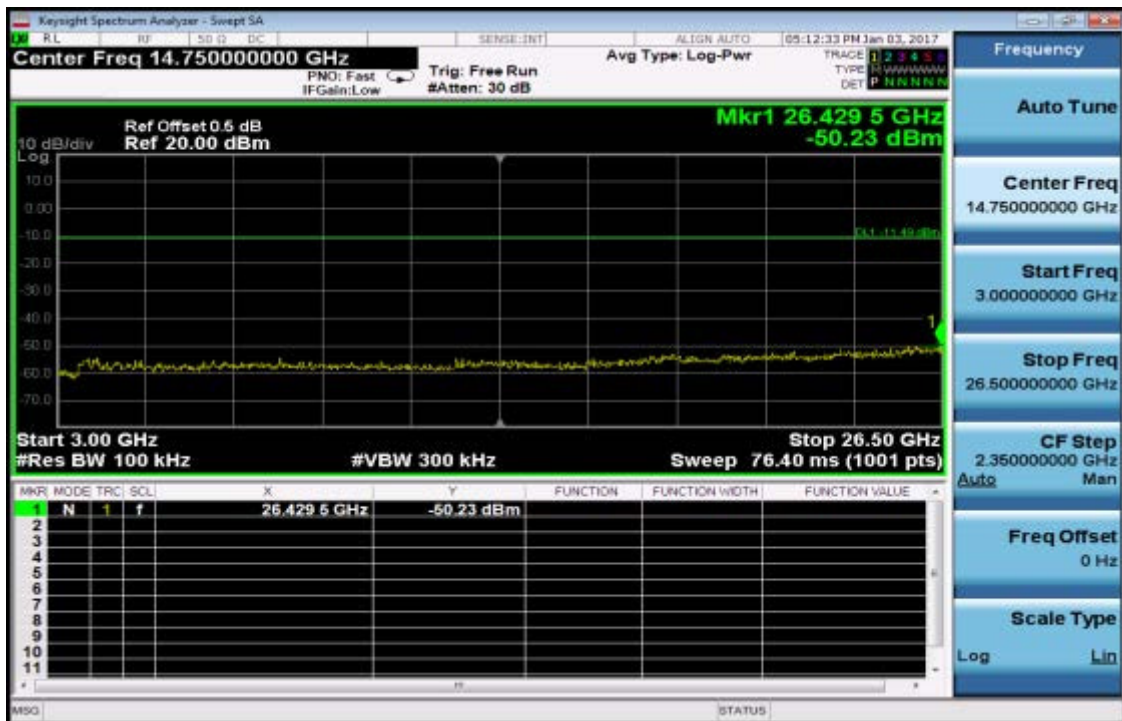

Unless otherwise stated the results shown in this test report refer only to the sample(s) tested and such sample(s) are retained for 90 days only.

除非另有說明，此報告結果僅對測試之樣品負責，同時此樣品僅保留90天。本報告未經本公司書面許可，不可部份複製。

This document is issued by the Company subject to its General Conditions of Service printed overleaf, available on request or accessible at www.sgs.com/terms_and_conditions.htm and, for electronic format documents, subject to Terms and Conditions for Electronic Documents at www.sgs.com/terms_e-document.htm. Attention is drawn to the limitation of liability, indemnification and jurisdiction issues defined therein. Any holder of this document is advised that information contained hereon reflects the Company's findings at the time of its intervention only and within the limits of Client's instructions, if any. The Company's sole responsibility is to its Client and this document does not exonerate parties to a transaction from exercising all their rights and obligations under the transaction documents. This document cannot be reproduced except in full, without prior written approval of the Company. Any unauthorized alteration, forgery or falsification of the content or appearance of this document is unlawful and offenders may be prosecuted to the fullest extent of the law.

SGS Taiwan Ltd.

No.134,WuKungRoad,NewTaipeiIndustrialPark,WukuDistrict,NewTaipeiCity,Taiwan24803/新北市五股區新北產業園區五工路 134 號

台灣檢驗科技股份有限公司

t (886-2) 2299-3279

f (886-2) 2298-0488

www.tw.sgs.com

Member of SGS Group

Ch High 30MHz – 3GHz

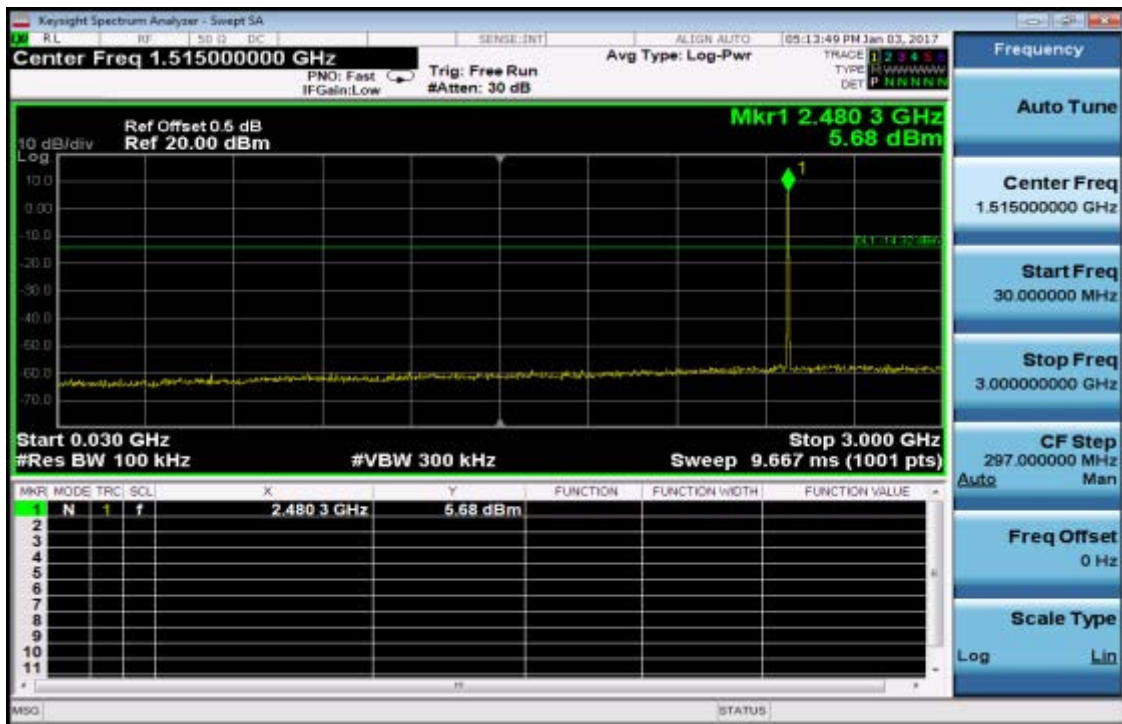

Ch High 3GHz – 26.5GHz

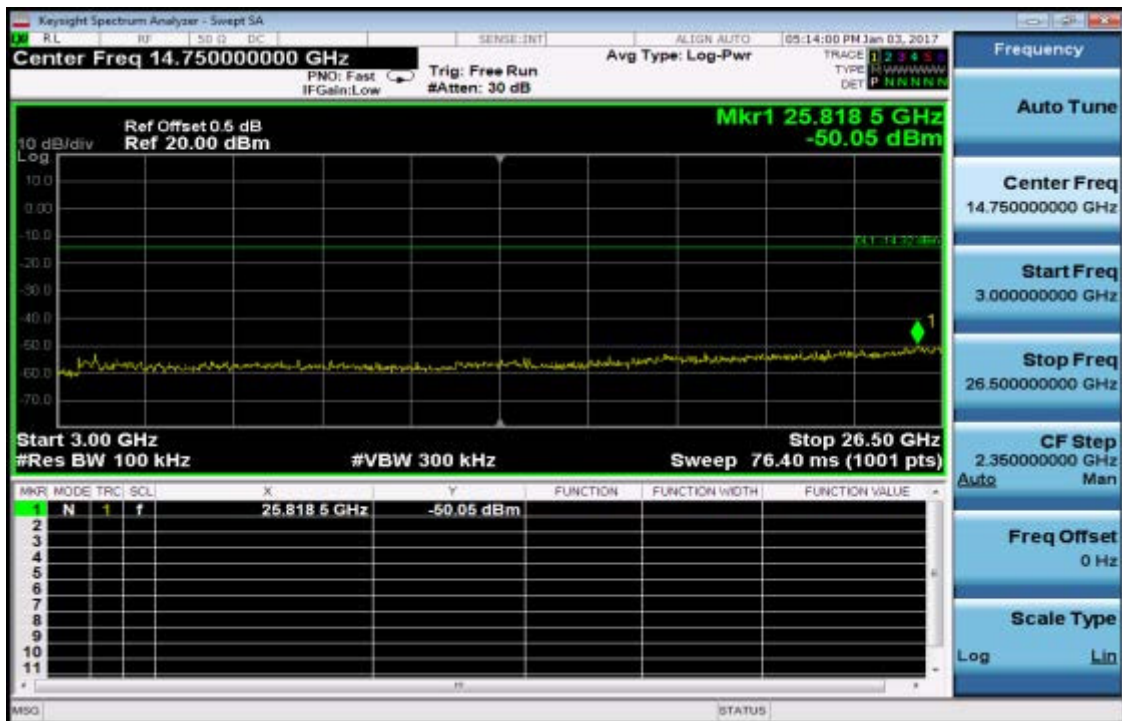

Unless otherwise stated the results shown in this test report refer only to the sample(s) tested and such sample(s) are retained for 90 days only.

除非另有說明，此報告結果僅對測試之樣品負責，同時此樣品僅保留90天。本報告未經本公司書面許可，不可部份複製。

This document is issued by the Company subject to its General Conditions of Service printed overleaf, available on request or accessible at www.sgs.com/terms_and_conditions.htm and, for electronic format documents, subject to Terms and Conditions for Electronic Documents at www.sgs.com/terms_e-document.htm. Attention is drawn to the limitation of liability, indemnification and jurisdiction issues defined therein. Any holder of this document is advised that information contained hereon reflects the Company's findings at the time of its intervention only and within the limits of Client's instructions, if any. The Company's sole responsibility is to its Client and this document does not exonerate parties to a transaction from exercising all their rights and obligations under the transaction documents. This document cannot be reproduced except in full, without prior written approval of the Company. Any unauthorized alteration, forgery or falsification of the content or appearance of this document is unlawful and offenders may be prosecuted to the fullest extent of the law.

SGS Taiwan Ltd.

No. 134, WuKungRoad, NewTaipeiIndustrialPark, WukuDistrict, NewTaipeiCity, Taiwan24803/新北市五股區新北產業園區五工路 134 號

台灣檢驗科技股份有限公司

t (886-2) 2299-3279

f (886-2) 2298-0488

www.tw.sgs.com

Member of SGS Group

10 RADIATED BANDEDGE AND SPURIOUS EMISSION MEASUREMENT

10.1 Standard Applicable

In any 100 kHz bandwidth outside the frequency band in which the spread spectrum or digitally modulated intentional radiator is operating, the radio frequency power that is produced by the intentional radiator shall be at least 20 dB below that in the 100 kHz bandwidth within the band that contains the highest level of the desired power, based on either an RF conducted or a radiated measurement, provided the transmitter demonstrates compliance with the peak conducted power limits. In addition, radiated emissions which fall in the restricted bands must also comply with the §15.209 limit as below.

And according to §15.33(a) (1), for an intentional radiator operates below 10GHz, the frequency range of measurements: to the tenth harmonic of the highest fundamental frequency or to 40GHz, whichever is lower.

Frequency (MHz)	Field strength (microvolts/meter)	Distance (meters)
0.009-0.490	2400/F(kHz)	300
0.490-1.705	24000/F(kHz)	30
1.705-30	30	30
30-88	100	3
88-216	150	3
216-960	200	3
Above 960	500	3

Note:

1. The lower limit shall apply at the transition frequencies.
2. Emission level (dBμV/m) = 20 log Emission level (dBμV/m)

Unless otherwise stated the results shown in this test report refer only to the sample(s) tested and such sample(s) are retained for 90 days only.

除非另有說明，此報告結果僅對測試之樣品負責，同時此樣品僅保留90天。本報告未經本公司書面許可，不可部份複製。

This document is issued by the Company subject to its General Conditions of Service printed overleaf, available on request or accessible at www.sgs.com/terms_and_conditions.htm and, for electronic format documents, subject to Terms and Conditions for Electronic Documents at www.sgs.com/terms_e-document.htm. Attention is drawn to the limitation of liability, indemnification and jurisdiction issues defined therein. Any holder of this document is advised that information contained hereon reflects the Company's findings at the time of its intervention only and within the limits of Client's instructions, if any. The Company's sole responsibility is to its Client and this document does not exonerate parties to a transaction from exercising all their rights and obligations under the transaction documents. This document cannot be reproduced except in full, without prior written approval of the Company. Any unauthorized alteration, forgery or falsification of the content or appearance of this document is unlawful and offenders may be prosecuted to the fullest extent of the law.

SGS Taiwan Ltd.

No.134,WuKungRoad,NewTaipeiIndustrialPark,WukuDistrict,NewTaipeiCity,Taiwan24803/新北市五股區新北產業園區五工路 134 號

台灣檢驗科技股份有限公司

t (886-2) 2299-3279

f (886-2) 2298-0488

www.tw.sgs.com

Member of SGS Group

10.2 Measurement Equipment Used

966 Chamber					
EQUIPMENT TYPE	MFR	MODEL NUMBER	SERIAL NUMBER	LAST CAL.	CAL DUE.
EMI Test Receiver	R&S	ESC17	100760	05/10/2016	05/09/2017
Spectrum Analyzer	Agilent	E4446A	MY51100003	01/29/2016	01/28/2017
Loop Antenna	ETS.LINDGREN	6502	148045	09/20/2016	09/19/2017
Bilog Antenna	SCHWAZBECK	VULB9168	378	12/19/2016	12/18/2017
Horn Antenna	Schwarzbeck	BBHA9120D	1441	08/01/2016	07/31/2017
Pre-Amplifier	Agilent	8447D	2944A07676	01/02/2016	01/01/2017
Pre-Amplifier	EMC Instruments Corp.	EMC0126530	980038	01/02/2016	01/01/2017
Turn Table	HD	DT420	N/A	N.C.R	N.C.R
Antenna Tower	ChamPro	AM-BS-4500-B	060776-ABS	N.C.R	N.C.R
Controller	ChamPro	EM1000	60776	N.C.R	N.C.R
Low Loss Cable	Huber Suhner	966_RX	9	01/02/2016	01/01/2017
3m Site NSA	SGS	966 chamber	N/A	07/01/2016	06/30/2017
Low Loss Cable	Huber Suhner	966 TX	1	01/02/2016	01/01/2017

Note: N.C.R refers to Not Calibrated Required.

Unless otherwise stated the results shown in this test report refer only to the sample(s) tested and such sample(s) are retained for 90 days only.

除非另有說明，此報告結果僅對測試之樣品負責，同時此樣品僅保留90天。本報告未經本公司書面許可，不可部份複製。

This document is issued by the Company subject to its General Conditions of Service printed overleaf, available on request or accessible at www.sgs.com/terms_and_conditions.htm and, for electronic format documents, subject to Terms and Conditions for Electronic Documents at www.sgs.com/terms_e-document.htm. Attention is drawn to the limitation of liability, indemnification and jurisdiction issues defined therein. Any holder of this document is advised that information contained hereon reflects the Company's findings at the time of its intervention only and within the limits of Client's instructions, if any. The Company's sole responsibility is to its Client and this document does not exonerate parties to a transaction from exercising all their rights and obligations under the transaction documents. This document cannot be reproduced except in full, without prior written approval of the Company. Any unauthorized alteration, forgery or falsification of the content or appearance of this document is unlawful and offenders may be prosecuted to the fullest extent of the law.

SGS Taiwan Ltd.

No.134,WuKungRoad,NewTaipeiIndustrialPark,WukuDistrict,NewTaipeiCity,Taiwan24803/新北市五股區新北產業園區五工路 134 號

台灣檢驗科技股份有限公司

t (886-2) 2299-3279

f (886-2) 2298-0488

www.tw.sgs.com

Member of SGS Group

10.3 Test SET-UP

(A) Radiated Emission Test Set-UP Frequency Below 30MHz.

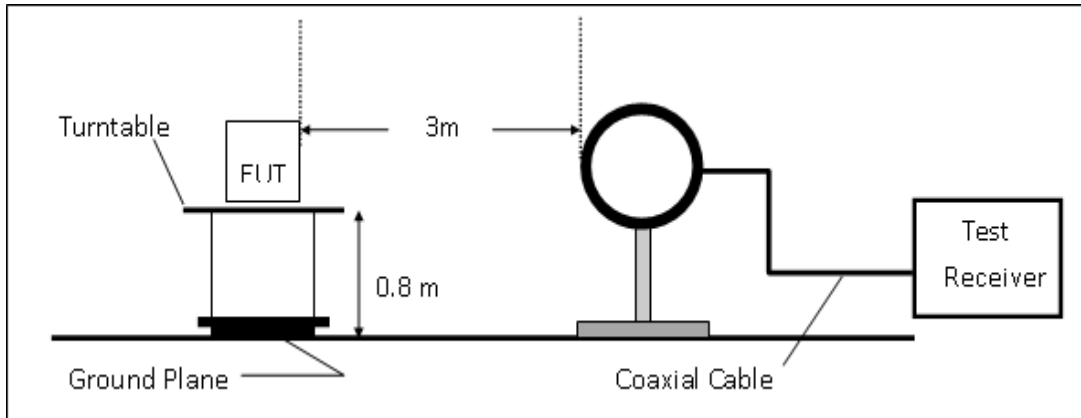

(B) Radiated Emission Test Set-UP, Frequency form 30MHz to 1000MHz

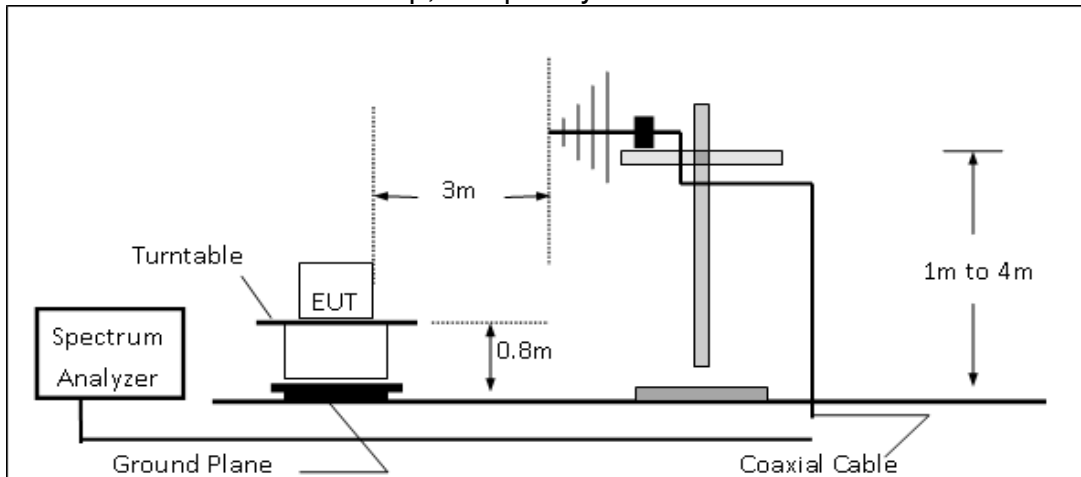

(C) Radiated Emission Test Set-UP Frequency Over 1 GHz

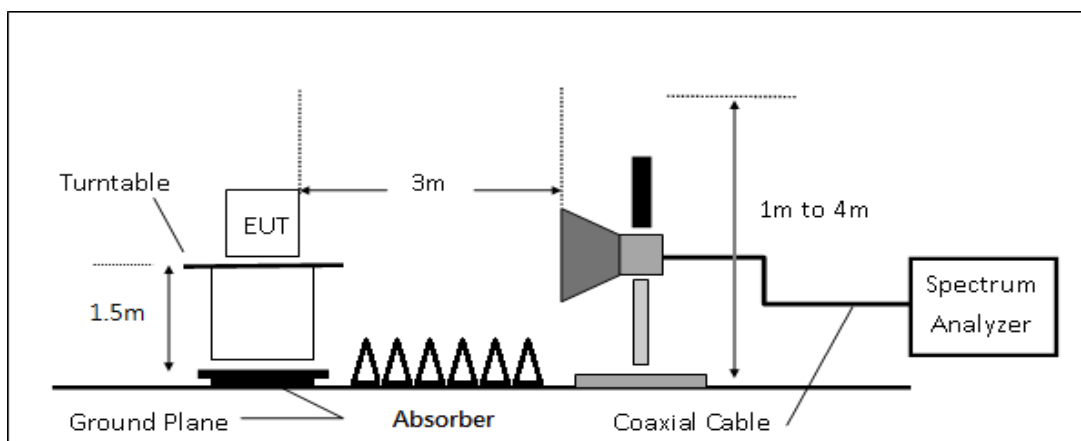

Unless otherwise stated the results shown in this test report refer only to the sample(s) tested and such sample(s) are retained for 90 days only.

除非另有說明，此報告結果僅對測試之樣品負責，同時此樣品僅保留90天。本報告未經本公司書面許可，不可部份複製。

This document is issued by the Company subject to its General Conditions of Service printed overleaf, available on request or accessible at www.sgs.com/terms_and_conditions.htm and, for electronic format documents, subject to Terms and Conditions for Electronic Documents at www.sgs.com/terms_e-document.htm. Attention is drawn to the limitation of liability, indemnification and jurisdiction issues defined therein. Any holder of this document is advised that information contained hereon reflects the Company's findings at the time of its intervention only and within the limits of Client's instructions, if any. The Company's sole responsibility is to its Client and this document does not exonerate parties to a transaction from exercising all their rights and obligations under the transaction documents. This document cannot be reproduced except in full, without prior written approval of the Company. Any unauthorized alteration, forgery or falsification of the content or appearance of this document is unlawful and offenders may be prosecuted to the fullest extent of the law.

10.4 Measurement Procedure

Radiated Emission

1. The testing follows FCC Public Notice DA 00-705 Measurement Guidelines.
2. The EUT was placed on a turn table with 0.8m for frequency < 1GHz and 0.8m for frequency > 1GHz above ground plan.
3. The turn table shall rotate 360 degrees to determine the position of maximum emission level.
4. EUT is set 3m away from the receiving antenna which varied from 1m to 4m to find out the highest emissions.
5. Use the follow spectrum analyzer setting:
 - (1) Span = wide enough to fully capture the emission being measured
 - (2) RBW = 1 MHz for $f \geq 1$ GHz, 100 kHz for $f < 1$ GHz, VBW \geq RBW, Sweep = auto, Detector function = peak, Trace = max hold
 - (3) For average measurement: use duty cycle correction factor method per 15.35(c)
 Duty Cycle = On time/100 milliseconds
 On time = $N1 * L1 = N2 * L2 + \dots + N(n-1) * LN(n-1) + N(n) * L(n)$
 Where N1 is number of type 1 pulses, L1 is length of type 1 pulses, etc.
 Average Emission Level = Peak Emission Level + $20 * \log$ (duty Cycle)
6. When measurement procedures for electric field radiated emissions above 1 GHz the EUT measurement is to be made "while keeping the antenna in the 'cone of radiation' from that area and pointed at the area both in azimuth and elevation, with polarization oriented for maximum response." is still within the 3dB illumination BW of the measurement antenna.
7. Maximum procedure was performed on the six highest emissions to ensure EUT compliance.
8. And also, each emission was to be maximized by changing the polarization of receiving antenna both horizontal and vertical.
9. Repeat above procedures until all frequency of the interest measured were complete.

Unless otherwise stated the results shown in this test report refer only to the sample(s) tested and such sample(s) are retained for 90 days only.

除非另有說明，此報告結果僅對測試之樣品負責，同時此樣品僅保留90天。本報告未經本公司書面許可，不可部份複製。

This document is issued by the Company subject to its General Conditions of Service printed overleaf, available on request or accessible at www.sgs.com/terms_and_conditions.htm and, for electronic format documents, subject to Terms and Conditions for Electronic Documents at www.sgs.com/terms_e-document.htm. Attention is drawn to the limitation of liability, indemnification and jurisdiction issues defined therein. Any holder of this document is advised that information contained hereon reflects the Company's findings at the time of its intervention only and within the limits of Client's instructions, if any. The Company's sole responsibility is to its Client and this document does not exonerate parties to a transaction from exercising all their rights and obligations under the transaction documents. This document cannot be reproduced except in full, without prior written approval of the Company. Any unauthorized alteration, forgery or falsification of the content or appearance of this document is unlawful and offenders may be prosecuted to the fullest extent of the law.

SGS Taiwan Ltd.

No.134,WuKungRoad,NewTaipeiIndustrialPark,WukuDistrict,NewTaipeiCity,Taiwan24803/新北市五股區新北產業園區五工路 134 號

台灣檢驗科技股份有限公司

t (886-2) 2299-3279

f (886-2) 2298-0488

www.tw.sgs.com

Member of SGS Group

10.5 Field Strength Calculation

The field strength is calculated by adding the Antenna Factor and Cable Factor and subtracting the Amplifier Gain and Duty Cycle Correction Factor (if any) from the measured reading. The basic equation with a sample calculation is as follows:

$$FS = RA + AF + CL - AG$$

Where FS = Field Strength	CL = Cable Attenuation Factor (Cable Loss)
RA = Reading Amplitude	AG = Amplifier Gain
AF = Antenna Factor	

The limit of the emission level is expressed in dBuV/m, which converts $20 \cdot \log(\mu\text{V}/\text{m})$

Actual FS(dB μ V/m) = SPA. Reading level(dB μ V) + Factor(dB)

Factor(dB) = Antenna Factor(dB μ V/m) + Cable Loss(dB) – Pre_Amplifier Gain(dB)

Note :

“F” : denotes Fundamental Frequency. ; “H” : denotes Harmonic Frequency.

“E” : denotes Band Edge Frequency. ; “S” : denotes Spurious Frequency.

10.6 Test Results of Radiated Spurious Emissions form 9 KHz to 30 MHz

The low frequency, which started from 9 kHz to 30MHz, was pre-scanned and the result which was 20dB lower than the limit per 15.31(o) was not reported.

10.7 Measurement Result

Note: Refer to next page spectrum analyzer data chart and tabular data sheets.

Unless otherwise stated the results shown in this test report refer only to the sample(s) tested and such sample(s) are retained for 90 days only.

除非另有說明，此報告結果僅對測試之樣品負責，同時此樣品僅保留90天。本報告未經本公司書面許可，不可部份複製。

This document is issued by the Company subject to its General Conditions of Service printed overleaf, available on request or accessible at www.sgs.com/terms_and_conditions.htm and, for electronic format documents, subject to Terms and Conditions for Electronic Documents at www.sgs.com/terms_e-document.htm. Attention is drawn to the limitation of liability, indemnification and jurisdiction issues defined therein. Any holder of this document is advised that information contained hereon reflects the Company's findings at the time of its intervention only and within the limits of Client's instructions, if any. The Company's sole responsibility is to its Client and this document does not exonerate parties to a transaction from exercising all their rights and obligations under the transaction documents. This document cannot be reproduced except in full, without prior written approval of the Company. Any unauthorized alteration, forgery or falsification of the content or appearance of this document is unlawful and offenders may be prosecuted to the fullest extent of the law.

Radiated Band Edge Measurement Result: (Hopping Mode)

Operation Mode : BR Hopping Test Date : 12/27/2016
 Fundamental Frequency : 2402 MHz Temp. / Humi. : 22 deg_C / 61 RH
 Operation Band : Bandedge CH LOW Test Engineer : Kane
 EUT Pol. : E2 Plane Measurement Antenna Pol. : VERTICAL

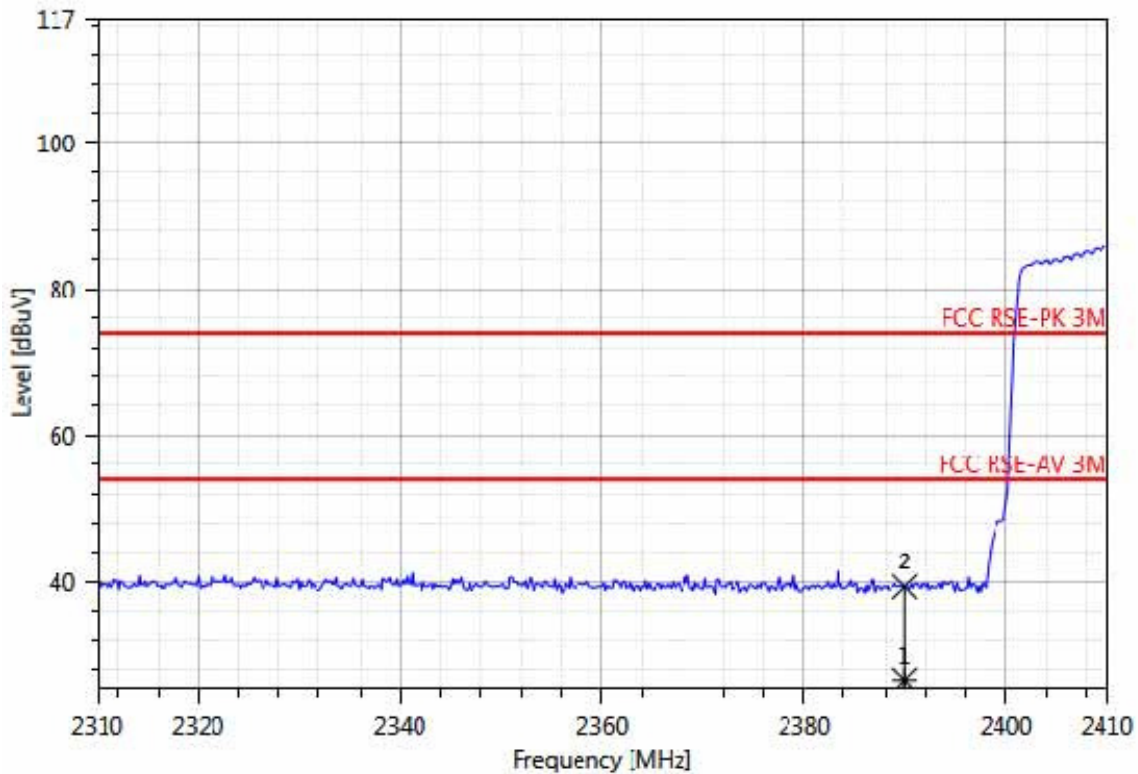

Freq. MHz	Note F/H/E/S	Decetor Mode QP/AV/PK	Actual Reading Level dB μ V/m	Spectrum FS dB μ V/m	Factor dB	Limit @3m dBuV/m	Margin dB
2390.00	E	Average	26.47	28.21	-1.74	54.00	-27.53
2390.00	E	Peak	39.35	41.09	-1.74	74.00	-34.65

Unless otherwise stated the results shown in this test report refer only to the sample(s) tested and such sample(s) are retained for 90 days only.

除非另有說明，此報告結果僅對測試之樣品負責，同時此樣品僅保留90天。本報告未經本公司書面許可，不可部份複製。

This document is issued by the Company subject to its General Conditions of Service printed overleaf, available on request or accessible at www.sgs.com/terms_and_conditions.htm and, for electronic format documents, subject to Terms and Conditions for Electronic Documents at www.sgs.com/terms_e-document.htm. Attention is drawn to the limitation of liability, indemnification and jurisdiction issues defined therein. Any holder of this document is advised that information contained hereon reflects the Company's findings at the time of its intervention only and within the limits of Client's instructions, if any. The Company's sole responsibility is to its Client and this document does not exonerate parties to a transaction from exercising all their rights and obligations under the transaction documents. This document cannot be reproduced except in full, without prior written approval of the Company. Any unauthorized alteration, forgery or falsification of the content or appearance of this document is unlawful and offenders may be prosecuted to the fullest extent of the law.

SGS Taiwan Ltd.

No.134,WuKungRoad,NewTaipeiIndustrialPark,WukuDistrict,NewTaipeiCity,Taiwan24803/新北市五股區新北產業園區五工路 134 號

台灣檢驗科技股份有限公司

t (886-2) 2299-3279

f (886-2) 2298-0488

www.tw.sgs.com

Member of SGS Group

Operation Mode : BR Hopping Test Date : 12/27/2016
 Fundamental Frequency : 2402 MHz Temp. / Humi. : 22 deg_C / 61 RH
 Operation Band : Bandedge CH LOW Test Engineer : Kane
 EUT Pol. : E2 Plane Measurement Antenna Pol. : HORIZONTAL

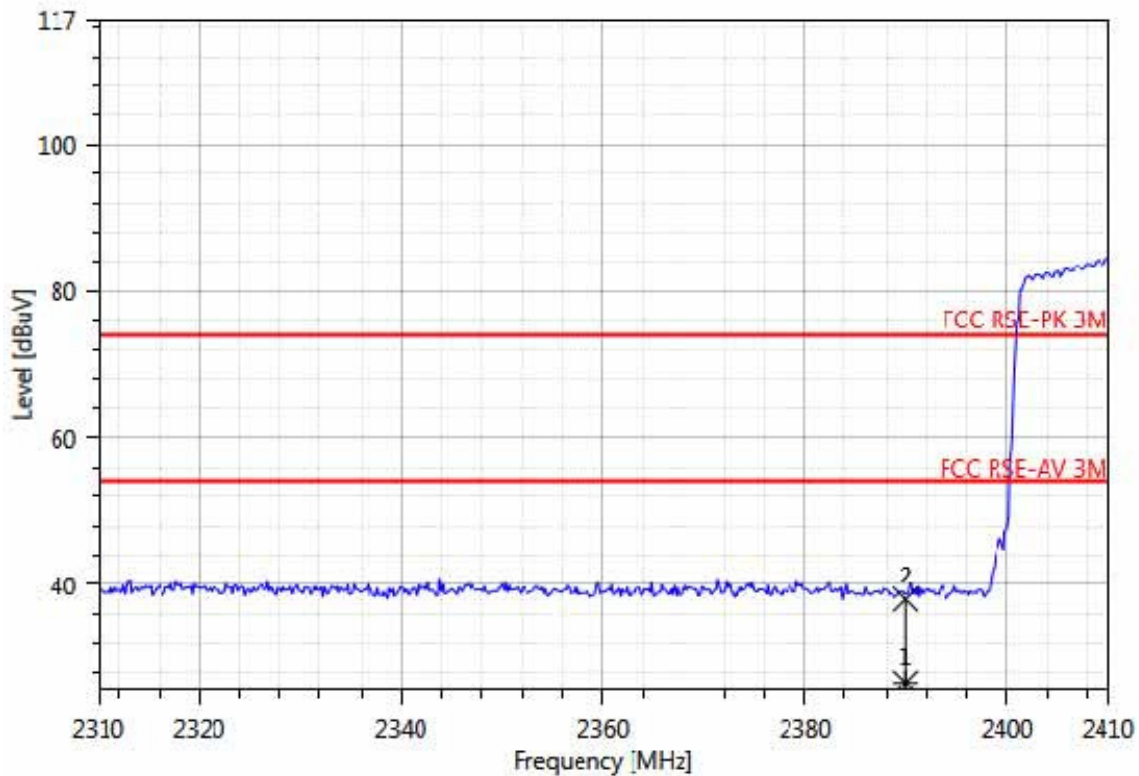

Freq. MHz	Note F/H/E/S	Decetor Mode QP/AV/PK	Actual Reading Level dBμV/m	Spectrum FS dBμV/m	Factor dB	Limit @3m dBuV/m	Margin dB
2390.00	E	Average	26.64	28.38	-1.74	54.00	-27.36
2390.00	E	Peak	37.99	39.73	-1.74	74.00	-36.01

Unless otherwise stated the results shown in this test report refer only to the sample(s) tested and such sample(s) are retained for 90 days only.

除非另有說明，此報告結果僅對測試之樣品負責，同時此樣品僅保留90天。本報告未經本公司書面許可，不可部份複製。

This document is issued by the Company subject to its General Conditions of Service printed overleaf, available on request or accessible at www.sgs.com/terms_and_conditions.htm and, for electronic format documents, subject to Terms and Conditions for Electronic Documents at www.sgs.com/terms_e-document.htm. Attention is drawn to the limitation of liability, indemnification and jurisdiction issues defined therein. Any holder of this document is advised that information contained hereon reflects the Company's findings at the time of its intervention only and within the limits of Client's instructions, if any. The Company's sole responsibility is to its Client and this document does not exonerate parties to a transaction from exercising all their rights and obligations under the transaction documents. This document cannot be reproduced except in full, without prior written approval of the Company. Any unauthorized alteration, forgery or falsification of the content or appearance of this document is unlawful and offenders may be prosecuted to the fullest extent of the law.

SGS Taiwan Ltd.

No.134,WuKungRoad,NewTaipeiIndustrialPark,WukuDistrict,NewTaipeiCity,Taiwan24803/新北市五股區新北產業園區五工路 134 號

台灣檢驗科技股份有限公司

t (886-2) 2299-3279

f (886-2) 2298-0488

www.tw.sgs.com

Member of SGS Group

Operation Mode : BR Hopping Test Date : 12/27/2016
 Fundamental Frequency : 2480 MHz Temp. / Humi. : 22 deg_C / 61 RH
 Operation Band : Bandedge CH HIGH Test Engineer : Kane
 EUT Pol. : E2 Plane Measurement Antenna Pol. : VERTICAL

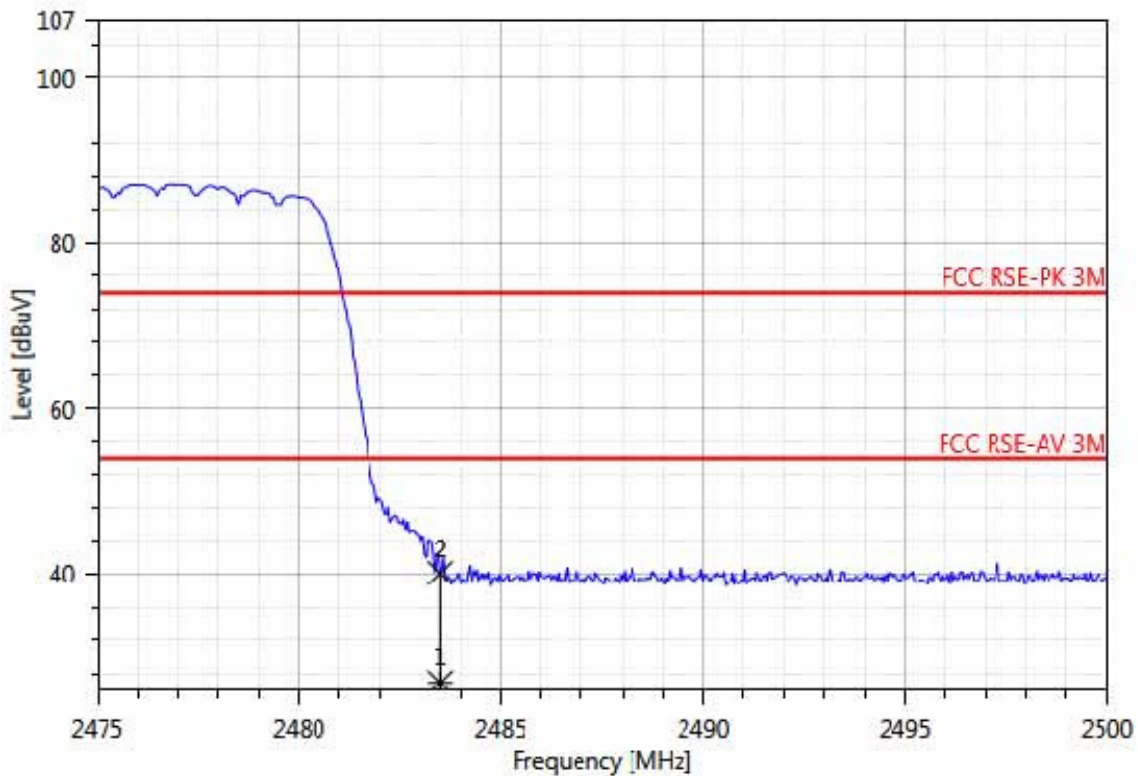

Freq. MHz	Note F/H/E/S	Decetor Mode QP/AV/PK	Actual Reading Level dB μ V/m	Spectrum FS dB μ V/m	Factor dB	Limit @3m dBuV/m	Margin dB
2483.50	E	Average	26.87	28.49	-1.62	54.00	-27.13
2483.50	E	Peak	40.11	41.73	-1.62	74.00	-33.89

Unless otherwise stated the results shown in this test report refer only to the sample(s) tested and such sample(s) are retained for 90 days only.

除非另有說明，此報告結果僅對測試之樣品負責，同時此樣品僅保留90天。本報告未經本公司書面許可，不可部份複製。

This document is issued by the Company subject to its General Conditions of Service printed overleaf, available on request or accessible at www.sgs.com/terms_and_conditions.htm and, for electronic format documents, subject to Terms and Conditions for Electronic Documents at www.sgs.com/terms_e-document.htm. Attention is drawn to the limitation of liability, indemnification and jurisdiction issues defined therein. Any holder of this document is advised that information contained hereon reflects the Company's findings at the time of its intervention only and within the limits of Client's instructions, if any. The Company's sole responsibility is to its Client and this document does not exonerate parties to a transaction from exercising all their rights and obligations under the transaction documents. This document cannot be reproduced except in full, without prior written approval of the Company. Any unauthorized alteration, forgery or falsification of the content or appearance of this document is unlawful and offenders may be prosecuted to the fullest extent of the law.

SGS Taiwan Ltd.

No.134,WuKungRoad,NewTaipeiIndustrialPark,WukuDistrict,NewTaipeiCity,Taiwan24803/新北市五股區新北產業園區五工路 134 號

台灣檢驗科技股份有限公司

t (886-2) 2299-3279

f (886-2) 2298-0488

www.tw.sgs.com

Member of SGS Group

Operation Mode : BR Hopping Test Date : 12/27/2016
 Fundamental Frequency : 2480 MHz Temp. / Humi. : 22 deg_C / 61 RH
 Operation Band : Bandedge CH HIGH Test Engineer : Kane
 EUT Pol. : E2 Plane Measurement Antenna Pol. : HORIZONTAL

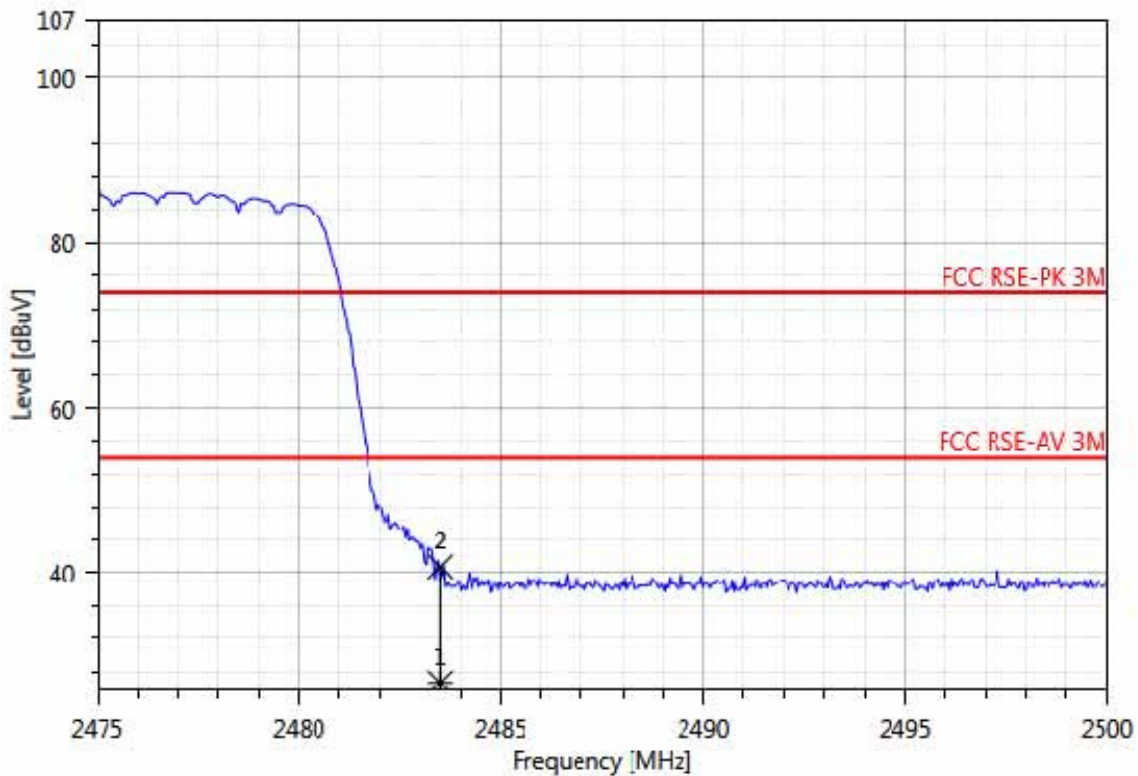

Freq. MHz	Note F/H/E/S	Decetor Mode QP/AV/PK	Actual Reading Level dBμV/m	Spectrum FS dBμV/m	Factor dB	Limit @3m dBuV/m	Margin dB
2483.50	E	Average	26.71	28.33	-1.62	54.00	-27.29
2483.50	E	Peak	40.76	42.38	-1.62	74.00	-33.24

Unless otherwise stated the results shown in this test report refer only to the sample(s) tested and such sample(s) are retained for 90 days only.

除非另有說明，此報告結果僅對測試之樣品負責，同時此樣品僅保留90天。本報告未經本公司書面許可，不可部份複製。

This document is issued by the Company subject to its General Conditions of Service printed overleaf, available on request or accessible at www.sgs.com/terms_and_conditions.htm and, for electronic format documents, subject to Terms and Conditions for Electronic Documents at www.sgs.com/terms_e-document.htm. Attention is drawn to the limitation of liability, indemnification and jurisdiction issues defined therein. Any holder of this document is advised that information contained hereon reflects the Company's findings at the time of its intervention only and within the limits of Client's instructions, if any. The Company's sole responsibility is to its Client and this document does not exonerate parties to a transaction from exercising all their rights and obligations under the transaction documents. This document cannot be reproduced except in full, without prior written approval of the Company. Any unauthorized alteration, forgery or falsification of the content or appearance of this document is unlawful and offenders may be prosecuted to the fullest extent of the law.

SGS Taiwan Ltd.

No.134,WuKungRoad,NewTaipeiIndustrialPark,WukuDistrict,NewTaipeiCity,Taiwan24803/新北市五股區新北產業園區五工路 134 號

台灣檢驗科技股份有限公司

t (886-2) 2299-3279

f (886-2) 2298-0488

www.tw.sgs.com

Member of SGS Group

Operation Mode : EDR Hopping Test Date : 12/27/2016
 Fundamental Frequency : 2402 MHz Temp. / Humi. : 22 deg_C / 61 RH
 Operation Band : Bandedge CH LOW Test Engineer : Kane
 EUT Pol. : E2 Plane Measurement Antenna Pol. : VERTICAL

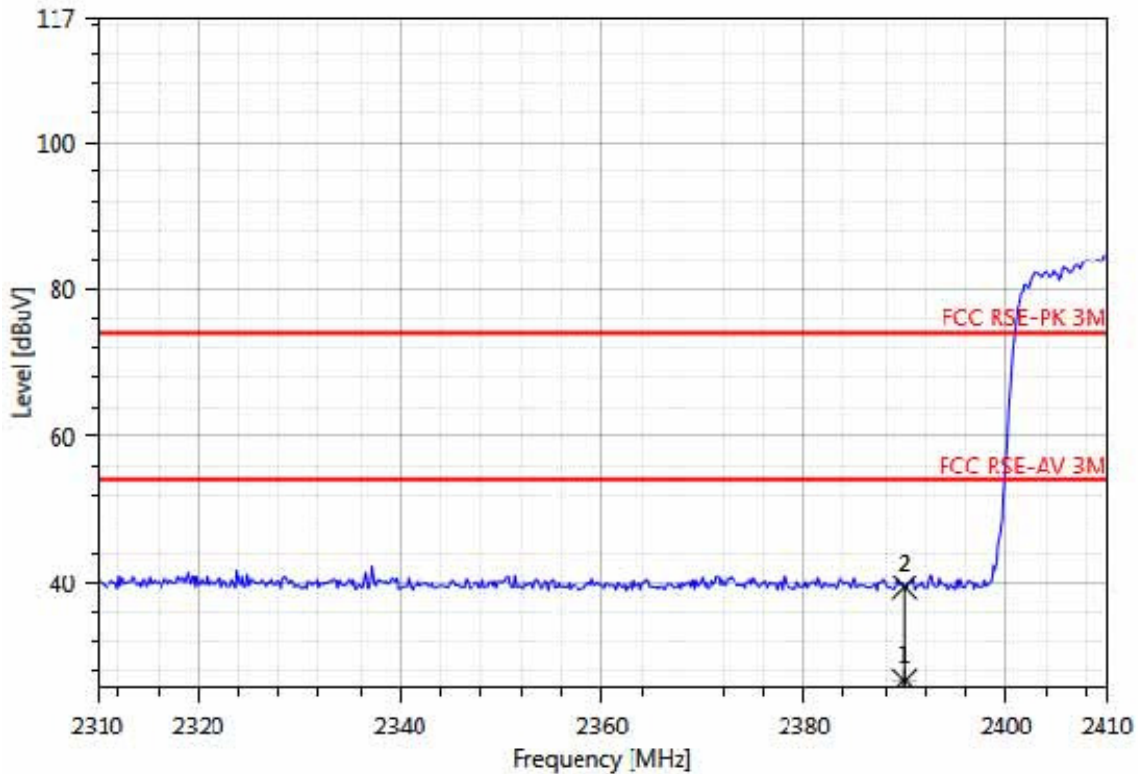

Freq.	Note	Decetor Mode	Actual Reading Level	Spectrum FS	Factor	Limit @3m	Margin
MHz	F/H/E/S	QP/AV/PK	dBμV/m	dBμV/m	dB	dBuV/m	dB
2390.00	E	Average	26.72	28.46	-1.74	54.00	-27.28
2390.00	E	Peak	39.37	41.11	-1.74	74.00	-34.63

Unless otherwise stated the results shown in this test report refer only to the sample(s) tested and such sample(s) are retained for 90 days only.

除非另有說明，此報告結果僅對測試之樣品負責，同時此樣品僅保留90天。本報告未經本公司書面許可，不可部份複製。

This document is issued by the Company subject to its General Conditions of Service printed overleaf, available on request or accessible at www.sgs.com/terms_and_conditions.htm and, for electronic format documents, subject to Terms and Conditions for Electronic Documents at www.sgs.com/terms_e-document.htm. Attention is drawn to the limitation of liability, indemnification and jurisdiction issues defined therein. Any holder of this document is advised that information contained hereon reflects the Company's findings at the time of its intervention only and within the limits of Client's instructions, if any. The Company's sole responsibility is to its Client and this document does not exonerate parties to a transaction from exercising all their rights and obligations under the transaction documents. This document cannot be reproduced except in full, without prior written approval of the Company. Any unauthorized alteration, forgery or falsification of the content or appearance of this document is unlawful and offenders may be prosecuted to the fullest extent of the law.

SGS Taiwan Ltd.

No.134,WuKungRoad,NewTaipeiIndustrialPark,WukuDistrict,NewTaipeiCity,Taiwan24803/新北市五股區新北產業園區五工路 134 號

台灣檢驗科技股份有限公司

t (886-2) 2299-3279

f (886-2) 2298-0488

www.tw.sgs.com

Member of SGS Group

Operation Mode : EDR Hopping Test Date : 12/27/2016
 Fundamental Frequency : 2402 MHz Temp. / Humi. : 22 deg_C / 61 RH
 Operation Band : Bandedge CH LOW Test Engineer : Kane
 EUT Pol. : E2 Plane Measurement Antenna Pol. : HORIZONTAL

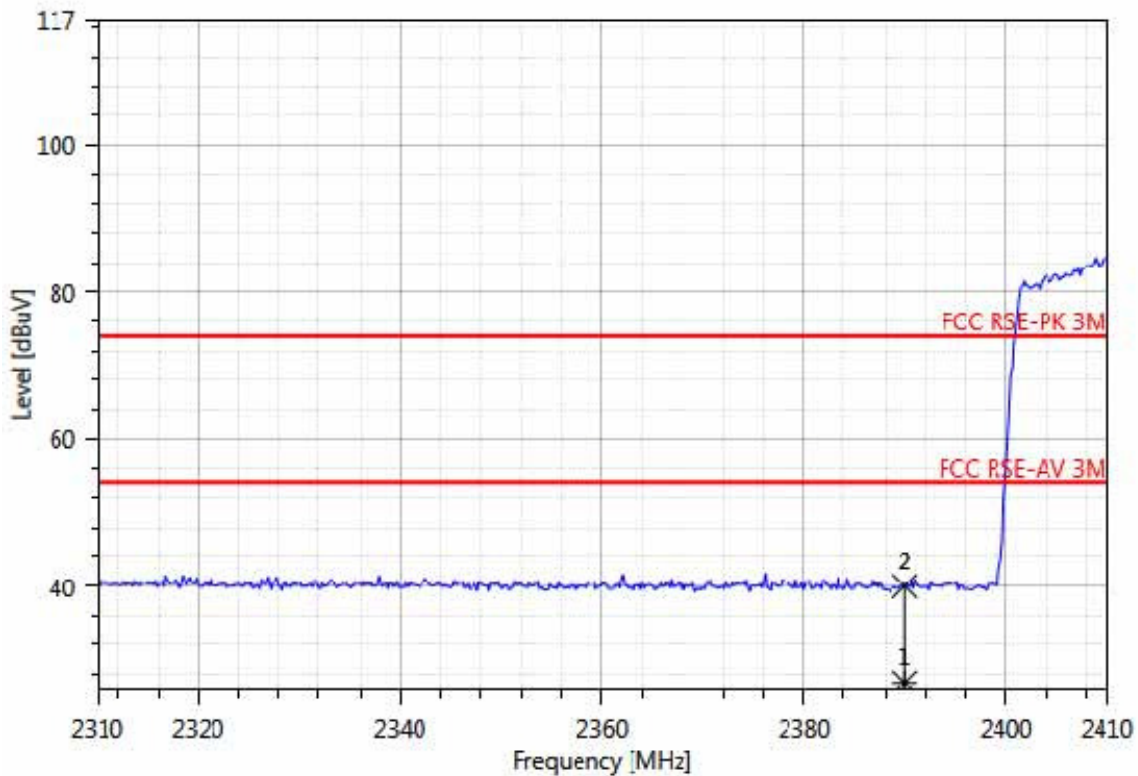

Freq. MHz	Note F/H/E/S	Decetor Mode QP/AV/PK	Actual Reading Level dBμV/m	Spectrum FS dBμV/m	Factor dB	Limit @3m dBuV/m	Margin dB
2390.00	E	Average	26.90	28.64	-1.74	54.00	-27.10
2390.00	E	Peak	40.00	41.74	-1.74	74.00	-34.00

Unless otherwise stated the results shown in this test report refer only to the sample(s) tested and such sample(s) are retained for 90 days only.

除非另有說明，此報告結果僅對測試之樣品負責，同時此樣品僅保留90天。本報告未經本公司書面許可，不可部份複製。

This document is issued by the Company subject to its General Conditions of Service printed overleaf, available on request or accessible at www.sgs.com/terms_and_conditions.htm and, for electronic format documents, subject to Terms and Conditions for Electronic Documents at www.sgs.com/terms_e-document.htm. Attention is drawn to the limitation of liability, indemnification and jurisdiction issues defined therein. Any holder of this document is advised that information contained hereon reflects the Company's findings at the time of its intervention only and within the limits of Client's instructions, if any. The Company's sole responsibility is to its Client and this document does not exonerate parties to a transaction from exercising all their rights and obligations under the transaction documents. This document cannot be reproduced except in full, without prior written approval of the Company. Any unauthorized alteration, forgery or falsification of the content or appearance of this document is unlawful and offenders may be prosecuted to the fullest extent of the law.

SGS Taiwan Ltd.

No.134,WuKungRoad,NewTaipeiIndustrialPark,WukuDistrict,NewTaipeiCity,Taiwan24803/新北市五股區新北產業園區五工路 134 號

台灣檢驗科技股份有限公司

t (886-2) 2299-3279

f (886-2) 2298-0488

www.tw.sgs.com

Member of SGS Group

Operation Mode : EDR Hopping Test Date : 12/27/2016
 Fundamental Frequency : 2480 MHz Temp. / Humi. : 22 deg_C / 61 RH
 Operation Band : Bandedge CH HIGH Test Engineer : Kane
 EUT Pol. : E2 Plane Measurement Antenna Pol. : VERTICAL

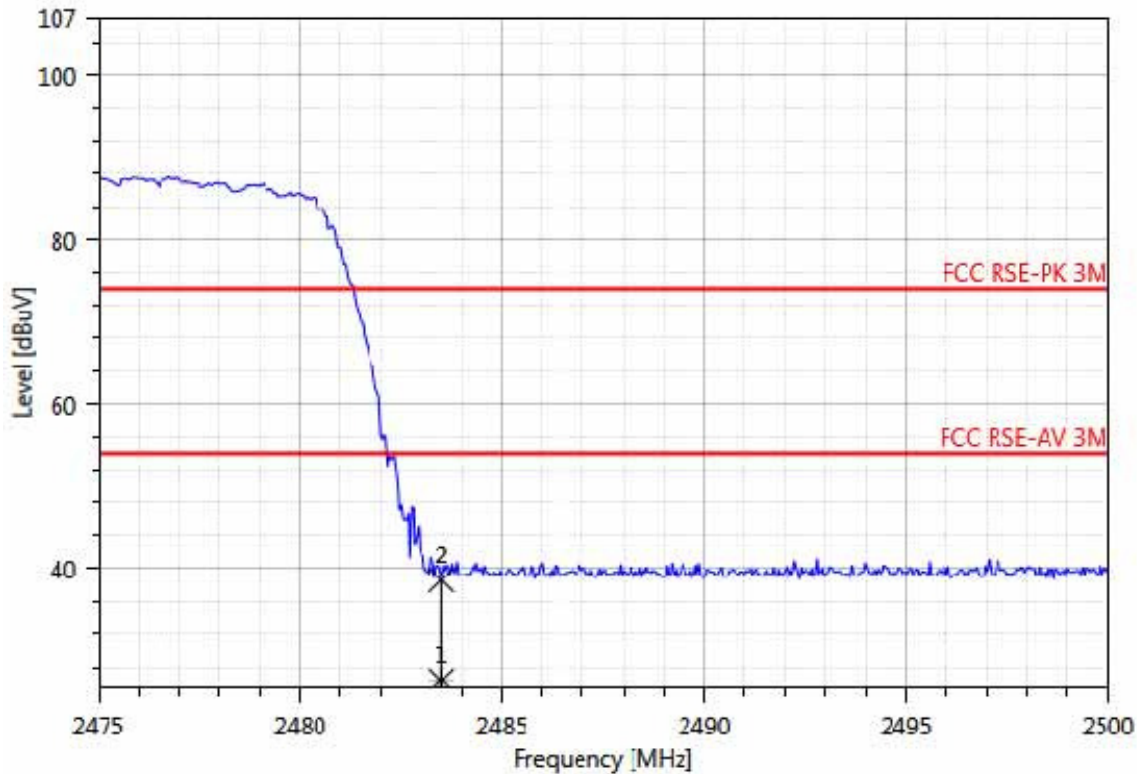

Freq. MHz	Note F/H/E/S	Decetor Mode QP/AV/PK	Actual Reading Level dB μ V/m	Spectrum FS dB μ V/m	Factor dB	Limit @3m dBuV/m	Margin dB
2483.50	E	Average	26.37	27.99	-1.62	54.00	-27.63
2483.50	E	Peak	38.55	40.17	-1.62	74.00	-35.45

Unless otherwise stated the results shown in this test report refer only to the sample(s) tested and such sample(s) are retained for 90 days only.

除非另有說明，此報告結果僅對測試之樣品負責，同時此樣品僅保留90天。本報告未經本公司書面許可，不可部份複製。

This document is issued by the Company subject to its General Conditions of Service printed overleaf, available on request or accessible at www.sgs.com/terms_and_conditions.htm and, for electronic format documents, subject to Terms and Conditions for Electronic Documents at www.sgs.com/terms_e-document.htm. Attention is drawn to the limitation of liability, indemnification and jurisdiction issues defined therein. Any holder of this document is advised that information contained hereon reflects the Company's findings at the time of its intervention only and within the limits of Client's instructions, if any. The Company's sole responsibility is to its Client and this document does not exonerate parties to a transaction from exercising all their rights and obligations under the transaction documents. This document cannot be reproduced except in full, without prior written approval of the Company. Any unauthorized alteration, forgery or falsification of the content or appearance of this document is unlawful and offenders may be prosecuted to the fullest extent of the law.

SGS Taiwan Ltd.

No.134,WuKungRoad,NewTaipeiIndustrialPark,WukuDistrict,NewTaipeiCity,Taiwan24803/新北市五股區新北產業園區五工路 134 號

台灣檢驗科技股份有限公司

t (886-2) 2299-3279

f (886-2) 2298-0488

www.tw.sgs.com

Member of SGS Group

Operation Mode : EDR Hopping Test Date : 12/27/2016
 Fundamental Frequency : 2480 MHz Temp. / Humi. : 22 deg_C / 61 RH
 Operation Band : Bandedge CH HIGH Test Engineer : Kane
 EUT Pol. : E2 Plane Measurement Antenna Pol. : HORIZONTAL

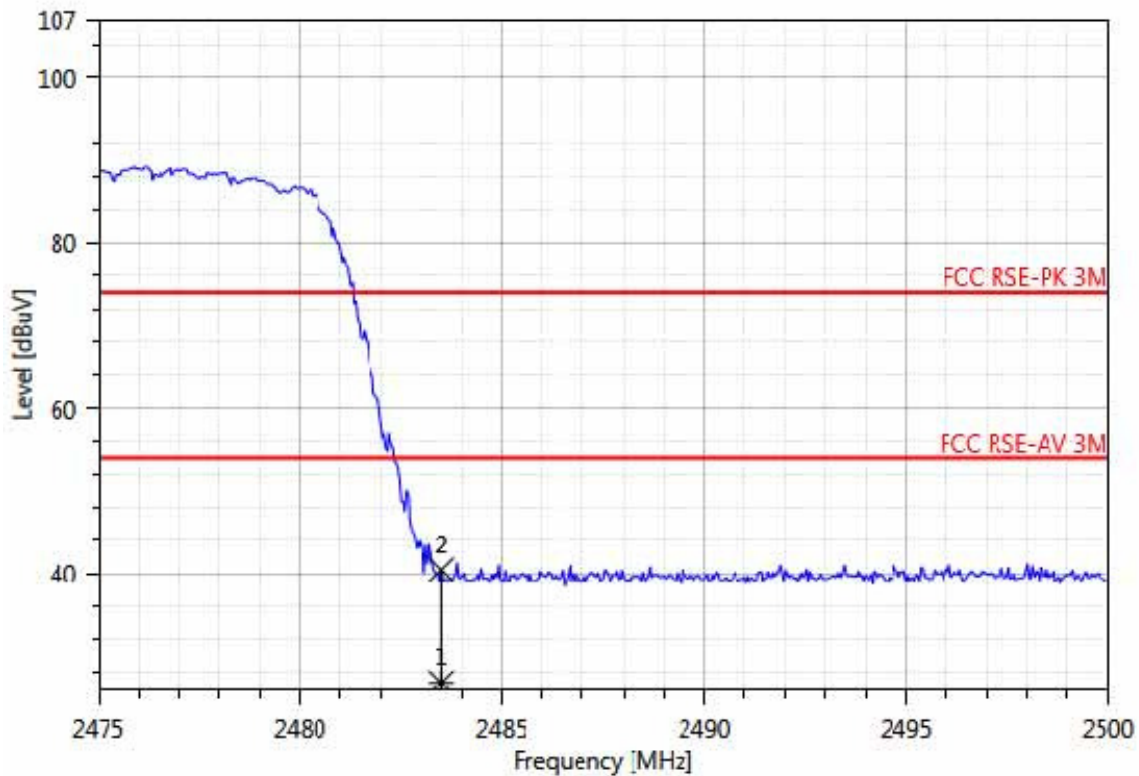

Freq. MHz	Note F/H/E/S	Decetor Mode QP/AV/PK	Actual Reading Level dB μ V/m	Spectrum FS dB μ V/m	Factor dB	Limit @3m dBuV/m	Margin dB
2483.50	E	Average	26.79	28.41	-1.62	54.00	-27.21
2483.50	E	Peak	40.47	42.09	-1.62	74.00	-33.53

Unless otherwise stated the results shown in this test report refer only to the sample(s) tested and such sample(s) are retained for 90 days only.

除非另有說明，此報告結果僅對測試之樣品負責，同時此樣品僅保留90天。本報告未經本公司書面許可，不可部份複製。

This document is issued by the Company subject to its General Conditions of Service printed overleaf, available on request or accessible at www.sgs.com/terms_and_conditions.htm and, for electronic format documents, subject to Terms and Conditions for Electronic Documents at www.sgs.com/terms_e-document.htm. Attention is drawn to the limitation of liability, indemnification and jurisdiction issues defined therein. Any holder of this document is advised that information contained hereon reflects the Company's findings at the time of its intervention only and within the limits of Client's instructions, if any. The Company's sole responsibility is to its Client and this document does not exonerate parties to a transaction from exercising all their rights and obligations under the transaction documents. This document cannot be reproduced except in full, without prior written approval of the Company. Any unauthorized alteration, forgery or falsification of the content or appearance of this document is unlawful and offenders may be prosecuted to the fullest extent of the law.

SGS Taiwan Ltd.

No.134,WuKungRoad,NewTaipeiIndustrialPark,WukuDistrict,NewTaipeiCity,Taiwan24803/新北市五股區新北產業園區五工路 134 號

台灣檢驗科技股份有限公司

t (886-2) 2299-3279

f (886-2) 2298-0488

www.tw.sgs.com

Member of SGS Group

Radiated Band Edge Measurement Result: (Non-Hopping Mode)

Operation Mode :	BR(1M)	Test Date :	12/27/2016
Fundamental Frequency :	2402 MHz	Temp. / Humi. :	22 deg_C / 61 RH
Operation Band :	Bandedge CH LOW	Test Engineer :	Kane
EUT Pol. :	E2 Plane	Measurement Antenna Pol. :	VERTICAL

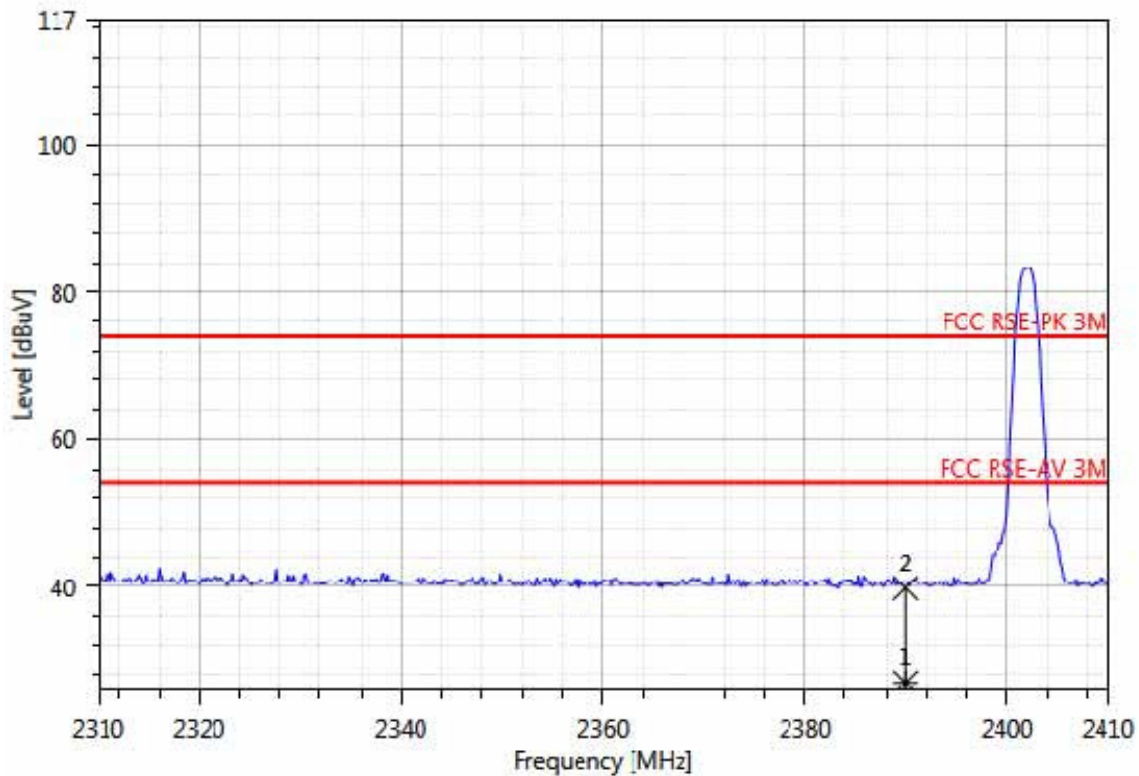

Freq. MHz	Note F/H/E/S	Decetor Mode QP/AV/PK	Actual Reading Level dB μ V/m	Spectrum FS dB μ V/m	Factor dB	Limit @3m dBuV/m	Margin dB
2390.00	E	Average	26.97	28.71	-1.74	54.00	-27.03
2390.00	E	Peak	39.79	41.54	-1.74	74.00	-34.21

Unless otherwise stated the results shown in this test report refer only to the sample(s) tested and such sample(s) are retained for 90 days only.

除非另有說明，此報告結果僅對測試之樣品負責，同時此樣品僅保留90天。本報告未經本公司書面許可，不可部份複製。

This document is issued by the Company subject to its General Conditions of Service printed overleaf, available on request or accessible at www.sgs.com/terms_and_conditions.htm and, for electronic format documents, subject to Terms and Conditions for Electronic Documents at www.sgs.com/terms_e-document.htm. Attention is drawn to the limitation of liability, indemnification and jurisdiction issues defined therein. Any holder of this document is advised that information contained hereon reflects the Company's findings at the time of its intervention only and within the limits of Client's instructions, if any. The Company's sole responsibility is to its Client and this document does not exonerate parties to a transaction from exercising all their rights and obligations under the transaction documents. This document cannot be reproduced except in full, without prior written approval of the Company. Any unauthorized alteration, forgery or falsification of the content or appearance of this document is unlawful and offenders may be prosecuted to the fullest extent of the law.

SGS Taiwan Ltd.

No.134,WuKungRoad,NewTaipeiIndustrialPark,WukuDistrict,NewTaipeiCity,Taiwan24803/新北市五股區新北產業園區五工路 134 號

台灣檢驗科技股份有限公司

t (886-2) 2299-3279

f (886-2) 2298-0488

www.tw.sgs.com

Member of SGS Group

Operation Mode : BR(1M) Test Date : 12/27/2016
 Fundamental Frequency : 2402 MHz Temp. / Humi. : 22 deg_C / 61 RH
 Operation Band : Bandedge CH LOW Test Engineer : Kane
 EUT Pol. : E2 Plane Measurement Antenna Pol. : HORIZONTAL

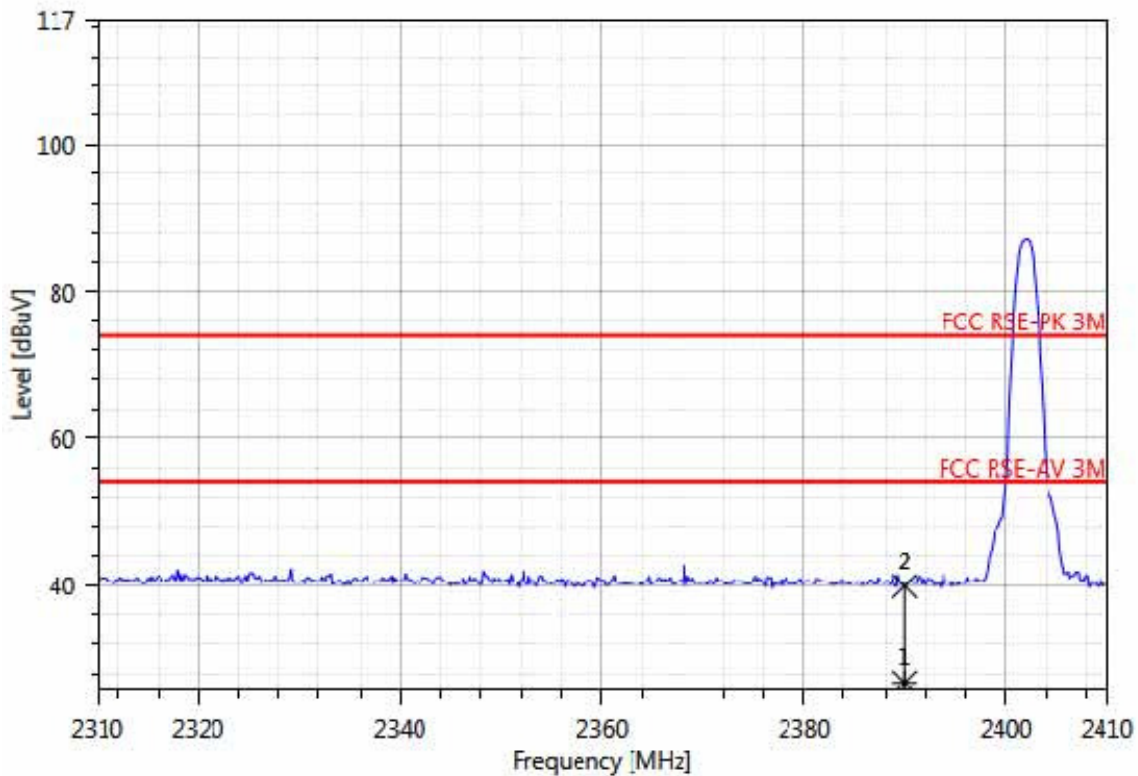

Freq. MHz	Note F/H/E/S	Decetor Mode QP/AV/PK	Actual Reading Level dB μ V/m	Spectrum FS dB μ V/m	Factor dB	Limit @3m dBuV/m	Margin dB
2390.00	E	Average	26.77	28.51	-1.74	54.00	-27.23
2390.00	E	Peak	39.90	41.64	-1.74	74.00	-34.10

Unless otherwise stated the results shown in this test report refer only to the sample(s) tested and such sample(s) are retained for 90 days only.

除非另有說明，此報告結果僅對測試之樣品負責，同時此樣品僅保留90天。本報告未經本公司書面許可，不可部份複製。

This document is issued by the Company subject to its General Conditions of Service printed overleaf, available on request or accessible at www.sgs.com/terms_and_conditions.htm and, for electronic format documents, subject to Terms and Conditions for Electronic Documents at www.sgs.com/terms_e-document.htm. Attention is drawn to the limitation of liability, indemnification and jurisdiction issues defined therein. Any holder of this document is advised that information contained hereon reflects the Company's findings at the time of its intervention only and within the limits of Client's instructions, if any. The Company's sole responsibility is to its Client and this document does not exonerate parties to a transaction from exercising all their rights and obligations under the transaction documents. This document cannot be reproduced except in full, without prior written approval of the Company. Any unauthorized alteration, forgery or falsification of the content or appearance of this document is unlawful and offenders may be prosecuted to the fullest extent of the law.

SGS Taiwan Ltd.

No.134,WuKungRoad,NewTaipeiIndustrialPark,WukuDistrict,NewTaipeiCity,Taiwan24803/新北市五股區新北產業園區五工路 134 號

台灣檢驗科技股份有限公司

t (886-2) 2299-3279

f (886-2) 2298-0488

www.tw.sgs.com

Member of SGS Group

Operation Mode : BR(1M) Test Date : 12/27/2016
 Fundamental Frequency : 2480 MHz Temp. / Humi. : 22 deg_C / 61 RH
 Operation Band : Bandedge CH HIGH Test Engineer : Kane
 EUT Pol. : E2 Plane Measurement Antenna Pol. : VERTICAL

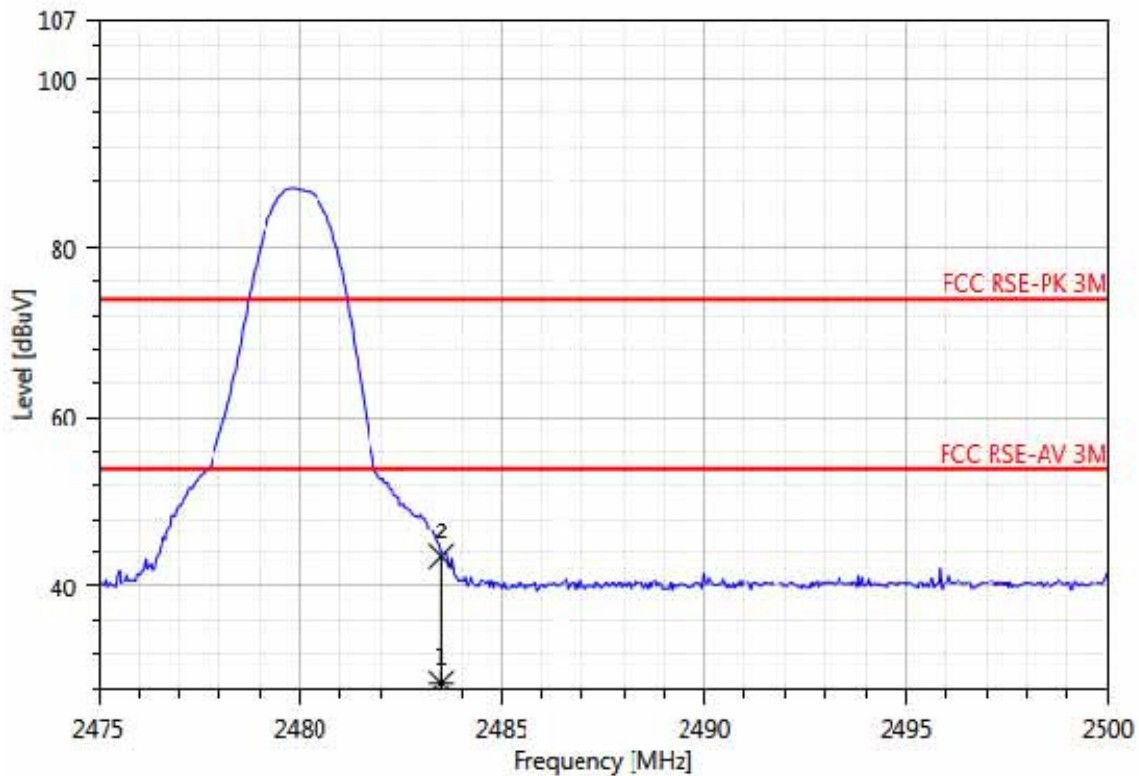

Freq. MHz	Note F/H/E/S	Decetor Mode QP/AV/PK	Actual Reading Level dB μ V/m	Spectrum FS dB μ V/m	Factor dB	Limit @3m dBuV/m	Margin dB
2483.50	E	Average	28.67	30.29	-1.62	54.00	-25.33
2483.50	E	Peak	43.60	45.22	-1.62	74.00	-30.40

Unless otherwise stated the results shown in this test report refer only to the sample(s) tested and such sample(s) are retained for 90 days only.

除非另有說明，此報告結果僅對測試之樣品負責，同時此樣品僅保留90天。本報告未經本公司書面許可，不可部份複製。

This document is issued by the Company subject to its General Conditions of Service printed overleaf, available on request or accessible at www.sgs.com/terms_and_conditions.htm and, for electronic format documents, subject to Terms and Conditions for Electronic Documents at www.sgs.com/terms_e-document.htm. Attention is drawn to the limitation of liability, indemnification and jurisdiction issues defined therein. Any holder of this document is advised that information contained hereon reflects the Company's findings at the time of its intervention only and within the limits of Client's instructions, if any. The Company's sole responsibility is to its Client and this document does not exonerate parties to a transaction from exercising all their rights and obligations under the transaction documents. This document cannot be reproduced except in full, without prior written approval of the Company. Any unauthorized alteration, forgery or falsification of the content or appearance of this document is unlawful and offenders may be prosecuted to the fullest extent of the law.

SGS Taiwan Ltd.

No.134,WuKungRoad,NewTaipeiIndustrialPark,WukuDistrict,NewTaipeiCity,Taiwan24803/新北市五股區新北產業園區五工路 134 號

台灣檢驗科技股份有限公司

t (886-2) 2299-3279

f (886-2) 2298-0488

www.tw.sgs.com

Member of SGS Group

Operation Mode : BR(1M) Test Date : 12/27/2016
 Fundamental Frequency : 2480 MHz Temp. / Humi. : 22 deg_C / 61 RH
 Operation Band : Bandedge CH HIGH Test Engineer : Kane
 EUT Pol. : E2 Plane Measurement Antenna Pol. : HORIZONTAL

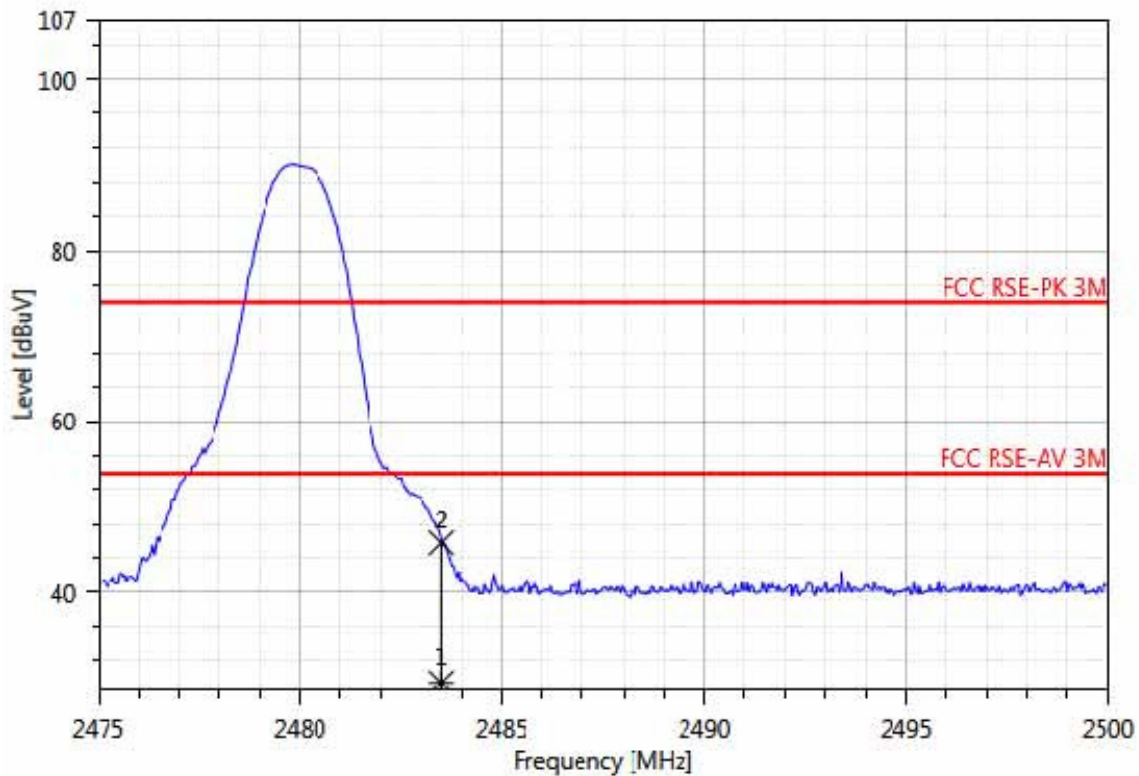

Freq. MHz	Note F/H/E/S	Decetor Mode QP/AV/PK	Actual Reading Level dB μ V/m	Spectrum FS dB μ V/m	Factor dB	Limit @3m dBuV/m	Margin dB
2483.50	E	Average	29.47	31.09	-1.62	54.00	-24.53
2483.50	E	Peak	45.77	47.39	-1.62	74.00	-28.23

Unless otherwise stated the results shown in this test report refer only to the sample(s) tested and such sample(s) are retained for 90 days only.

除非另有說明，此報告結果僅對測試之樣品負責，同時此樣品僅保留90天。本報告未經本公司書面許可，不可部份複製。

This document is issued by the Company subject to its General Conditions of Service printed overleaf, available on request or accessible at www.sgs.com/terms_and_conditions.htm and, for electronic format documents, subject to Terms and Conditions for Electronic Documents at www.sgs.com/terms_e-document.htm. Attention is drawn to the limitation of liability, indemnification and jurisdiction issues defined therein. Any holder of this document is advised that information contained hereon reflects the Company's findings at the time of its intervention only and within the limits of Client's instructions, if any. The Company's sole responsibility is to its Client and this document does not exonerate parties to a transaction from exercising all their rights and obligations under the transaction documents. This document cannot be reproduced except in full, without prior written approval of the Company. Any unauthorized alteration, forgery or falsification of the content or appearance of this document is unlawful and offenders may be prosecuted to the fullest extent of the law.

SGS Taiwan Ltd.

No.134,WuKungRoad,NewTaipeiIndustrialPark,WukuDistrict,NewTaipeiCity,Taiwan24803/新北市五股區新北產業園區五工路 134 號

台灣檢驗科技股份有限公司

t (886-2) 2299-3279

f (886-2) 2298-0488

www.tw.sgs.com

Member of SGS Group

Operation Mode : EDR(3M) Test Date : 12/27/2016
 Fundamental Frequency : 2402 MHz Temp. / Humi. : 22 deg_C / 61 RH
 Operation Band : Bandedge CH LOW Test Engineer : Kane
 EUT Pol. : E2 Plane Measurement Antenna Pol. : VERTICAL

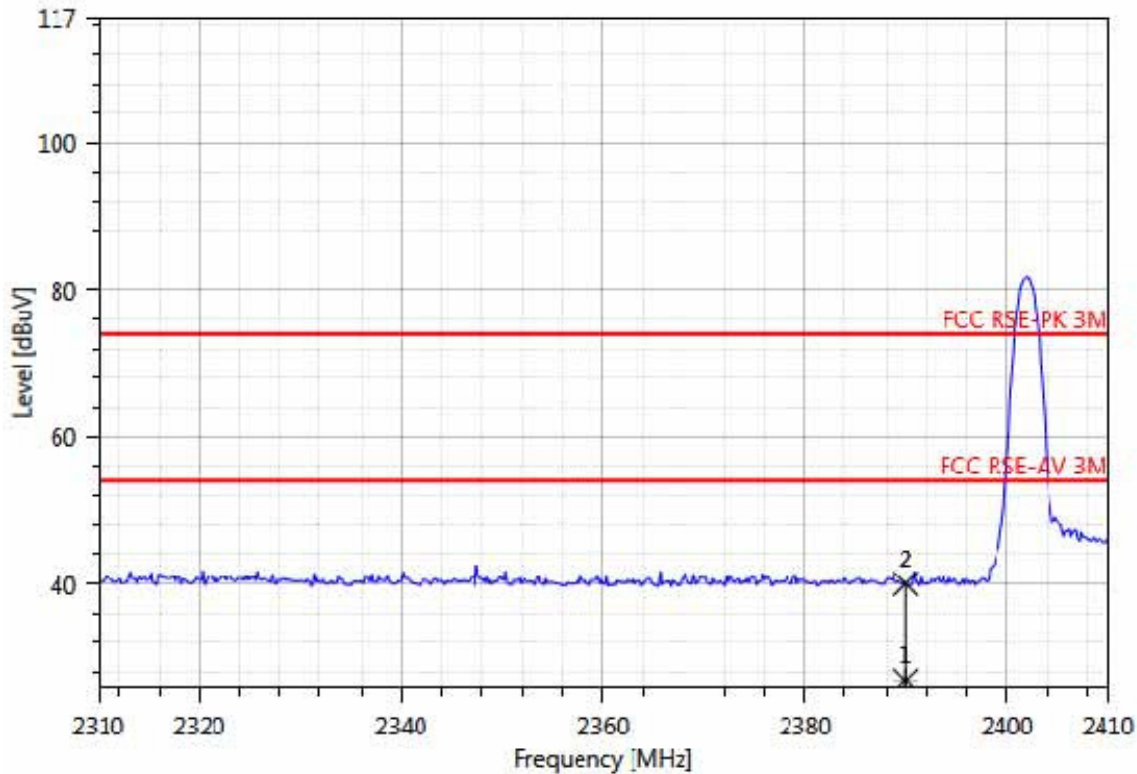

Freq.	Note	Decetor Mode	Actual Reading Level	Spectrum FS	Factor	Limit @3m	Margin
MHz	F/H/E/S	QP/AV/PK	dB μ V/m	dB μ V/m	dB	dBuV/m	dB
2390.00	E	Average	26.90	28.64	-1.74	54.00	-27.10
2390.00	E	Peak	40.03	41.77	-1.74	74.00	-33.97

Unless otherwise stated the results shown in this test report refer only to the sample(s) tested and such sample(s) are retained for 90 days only.

除非另有說明，此報告結果僅對測試之樣品負責，同時此樣品僅保留90天。本報告未經本公司書面許可，不可部份複製。

This document is issued by the Company subject to its General Conditions of Service printed overleaf, available on request or accessible at www.sgs.com/terms_and_conditions.htm and, for electronic format documents, subject to Terms and Conditions for Electronic Documents at www.sgs.com/terms_e-document.htm. Attention is drawn to the limitation of liability, indemnification and jurisdiction issues defined therein. Any holder of this document is advised that information contained hereon reflects the Company's findings at the time of its intervention only and within the limits of Client's instructions, if any. The Company's sole responsibility is to its Client and this document does not exonerate parties to a transaction from exercising all their rights and obligations under the transaction documents. This document cannot be reproduced except in full, without prior written approval of the Company. Any unauthorized alteration, forgery or falsification of the content or appearance of this document is unlawful and offenders may be prosecuted to the fullest extent of the law.

SGS Taiwan Ltd.

No.134,WuKungRoad,NewTaipeiIndustrialPark,WukuDistrict,NewTaipeiCity,Taiwan24803/新北市五股區新北產業園區五工路 134 號

台灣檢驗科技股份有限公司

t (886-2) 2299-3279

f (886-2) 2298-0488

www.tw.sgs.com

Member of SGS Group

Operation Mode : EDR(3M) Test Date : 12/27/2016
 Fundamental Frequency : 2402 MHz Temp. / Humi. : 22 deg_C / 61 RH
 Operation Band : Bandedge CH LOW Test Engineer : Kane
 EUT Pol. : E2 Plane Measurement Antenna Pol. : HORIZONTAL

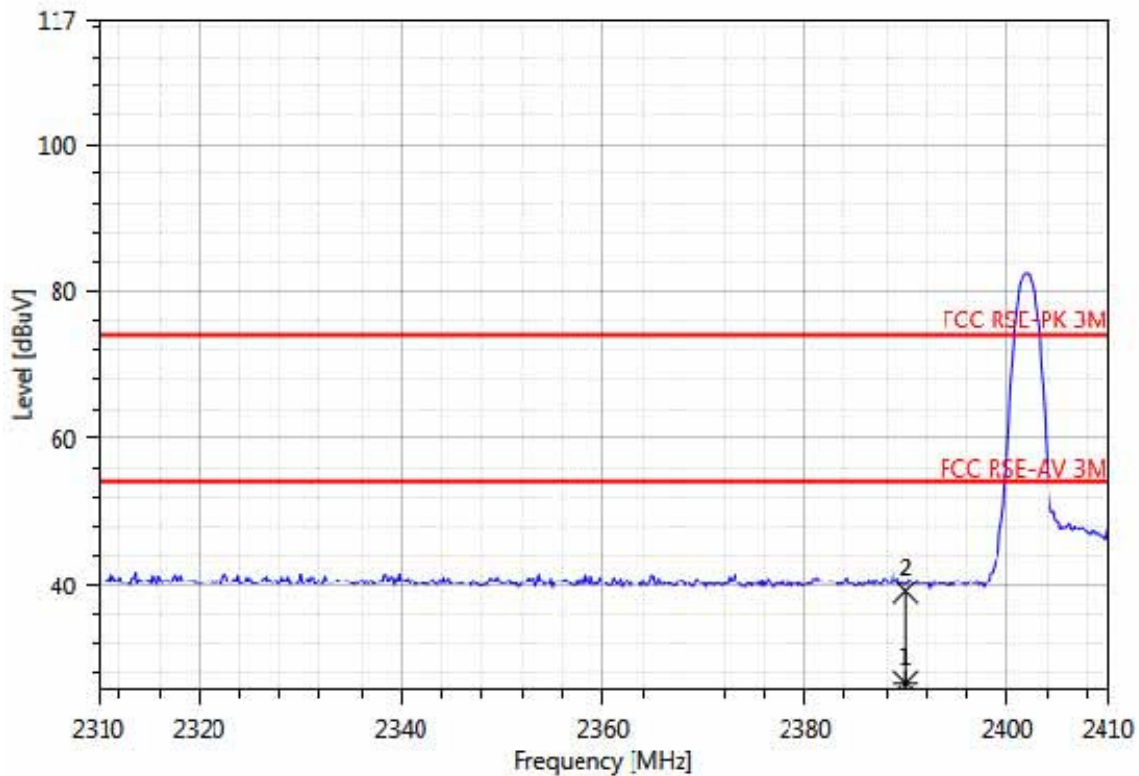

Freq. MHz	Note F/H/E/S	Decetor Mode QP/AV/PK	Actual Reading Level dB μ V/m	Spectrum FS dB μ V/m	Factor dB	Limit @3m dBuV/m	Margin dB
2390.00	E	Average	26.72	28.46	-1.74	54.00	-27.28
2390.00	E	Peak	39.10	40.84	-1.74	74.00	-34.90

Unless otherwise stated the results shown in this test report refer only to the sample(s) tested and such sample(s) are retained for 90 days only.

除非另有說明，此報告結果僅對測試之樣品負責，同時此樣品僅保留90天。本報告未經本公司書面許可，不可部份複製。

This document is issued by the Company subject to its General Conditions of Service printed overleaf, available on request or accessible at www.sgs.com/terms_and_conditions.htm and, for electronic format documents, subject to Terms and Conditions for Electronic Documents at www.sgs.com/terms_e-document.htm. Attention is drawn to the limitation of liability, indemnification and jurisdiction issues defined therein. Any holder of this document is advised that information contained hereon reflects the Company's findings at the time of its intervention only and within the limits of Client's instructions, if any. The Company's sole responsibility is to its Client and this document does not exonerate parties to a transaction from exercising all their rights and obligations under the transaction documents. This document cannot be reproduced except in full, without prior written approval of the Company. Any unauthorized alteration, forgery or falsification of the content or appearance of this document is unlawful and offenders may be prosecuted to the fullest extent of the law.

SGS Taiwan Ltd.

No.134,WuKungRoad,NewTaipeiIndustrialPark,WukuDistrict,NewTaipeiCity,Taiwan24803/新北市五股區新北產業園區五工路 134 號

台灣檢驗科技股份有限公司

t (886-2) 2299-3279

f (886-2) 2298-0488

www.tw.sgs.com

Member of SGS Group

Operation Mode : EDR(3M) Test Date : 12/27/2016
 Fundamental Frequency : 2480 MHz Temp. / Humi. : 22 deg_C / 61 RH
 Operation Band : Bandedge CH HIGH Test Engineer : Kane
 EUT Pol. : E2 Plane Measurement Antenna Pol. : VERTICAL

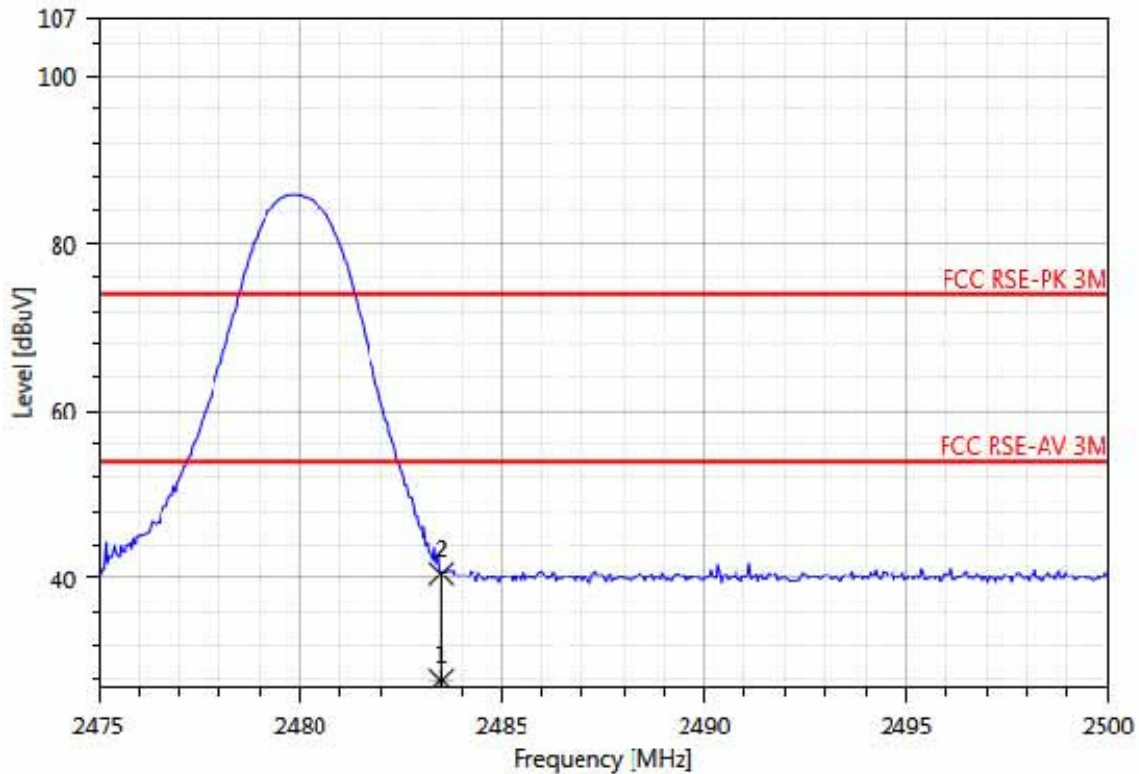

Freq. MHz	Note F/H/E/S	Decetor Mode QP/AV/PK	Actual Reading Level dB μ V/m	Spectrum FS dB μ V/m	Factor dB	Limit @3m dBuV/m	Margin dB
2483.50	E	Average	27.79	29.41	-1.62	54.00	-26.21
2483.50	E	Peak	40.51	42.13	-1.62	74.00	-33.49

Unless otherwise stated the results shown in this test report refer only to the sample(s) tested and such sample(s) are retained for 90 days only.

除非另有說明，此報告結果僅對測試之樣品負責，同時此樣品僅保留90天。本報告未經本公司書面許可，不可部份複製。

This document is issued by the Company subject to its General Conditions of Service printed overleaf, available on request or accessible at www.sgs.com/terms_and_conditions.htm and, for electronic format documents, subject to Terms and Conditions for Electronic Documents at www.sgs.com/terms_e-document.htm. Attention is drawn to the limitation of liability, indemnification and jurisdiction issues defined therein. Any holder of this document is advised that information contained hereon reflects the Company's findings at the time of its intervention only and within the limits of Client's instructions, if any. The Company's sole responsibility is to its Client and this document does not exonerate parties to a transaction from exercising all their rights and obligations under the transaction documents. This document cannot be reproduced except in full, without prior written approval of the Company. Any unauthorized alteration, forgery or falsification of the content or appearance of this document is unlawful and offenders may be prosecuted to the fullest extent of the law.

SGS Taiwan Ltd.

No.134,WuKungRoad,NewTaipeiIndustrialPark,WukuDistrict,NewTaipeiCity,Taiwan24803/新北市五股區新北產業園區五工路 134 號

台灣檢驗科技股份有限公司

t (886-2) 2299-3279

f (886-2) 2298-0488

www.tw.sgs.com

Member of SGS Group

Operation Mode : EDR(3M) Test Date : 12/27/2016
 Fundamental Frequency : 2480 MHz Temp. / Humi. : 22 deg_C / 61 RH
 Operation Band : Bandedge CH HIGH Test Engineer : Kane
 EUT Pol. : E2 Plane Measurement Antenna Pol. : HORIZONTAL

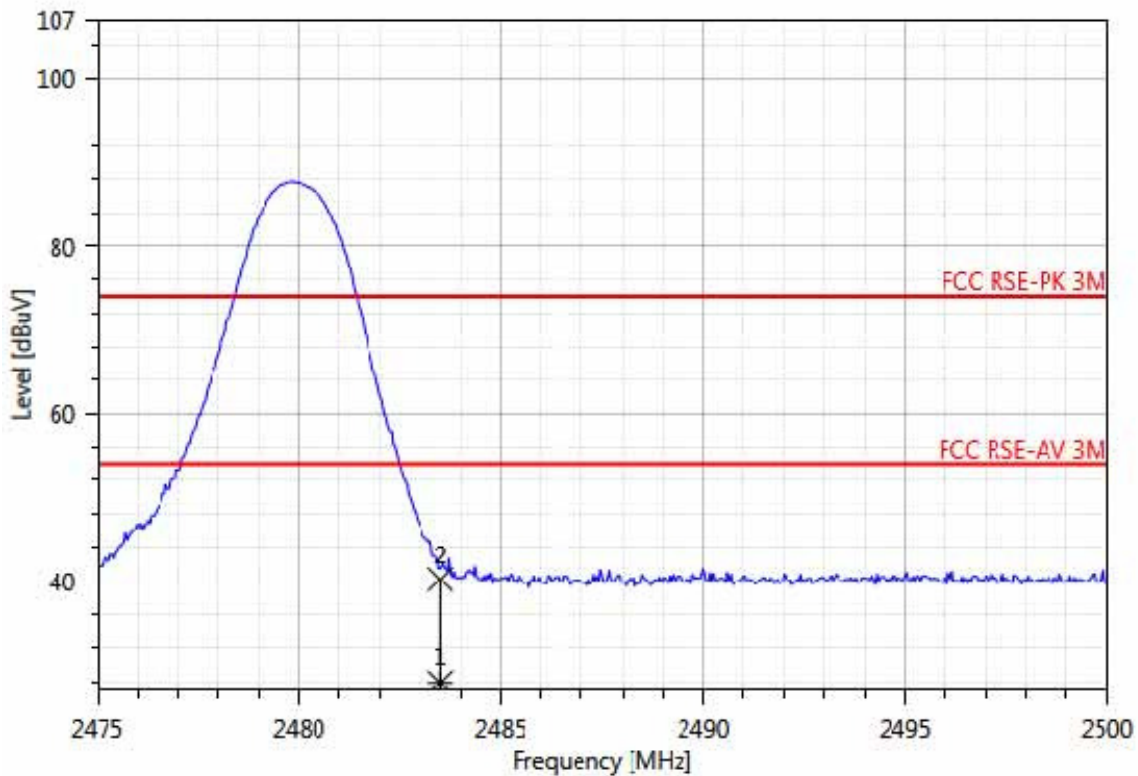

Freq. MHz	Note F/H/E/S	Decetor Mode QP/AV/PK	Actual Reading Level dB μ V/m	Spectrum FS dB μ V/m	Factor dB	Limit @3m dBuV/m	Margin dB
2483.50	E	Average	27.88	29.50	-1.62	54.00	-26.12
2483.50	E	Peak	40.21	41.83	-1.62	74.00	-33.79

Unless otherwise stated the results shown in this test report refer only to the sample(s) tested and such sample(s) are retained for 90 days only.

除非另有說明，此報告結果僅對測試之樣品負責，同時此樣品僅保留90天。本報告未經本公司書面許可，不可部份複製。

This document is issued by the Company subject to its General Conditions of Service printed overleaf, available on request or accessible at www.sgs.com/terms_and_conditions.htm and, for electronic format documents, subject to Terms and Conditions for Electronic Documents at www.sgs.com/terms_e-document.htm. Attention is drawn to the limitation of liability, indemnification and jurisdiction issues defined therein. Any holder of this document is advised that information contained hereon reflects the Company's findings at the time of its intervention only and within the limits of Client's instructions, if any. The Company's sole responsibility is to its Client and this document does not exonerate parties to a transaction from exercising all their rights and obligations under the transaction documents. This document cannot be reproduced except in full, without prior written approval of the Company. Any unauthorized alteration, forgery or falsification of the content or appearance of this document is unlawful and offenders may be prosecuted to the fullest extent of the law.

SGS Taiwan Ltd.

No.134,WuKungRoad,NewTaipeiIndustrialPark,WukuDistrict,NewTaipeiCity,Taiwan24803/新北市五股區新北產業園區五工路 134 號

台灣檢驗科技股份有限公司

t (886-2) 2299-3279

f (886-2) 2298-0488

www.tw.sgs.com

Member of SGS Group

Radiated Spurious Emission Measurement Result:

Operation Mode :	BR(1M)	Test Date :	12/27/2016
Fundamental Frequency :	2402 MHz	Temp. / Humi. :	22 deg_C / 61 RH
Operation Band :	Tx CH LOW	Test Engineer :	Kane
EUT Pol. :	E2 Plane	Measurement Antenna Pol. :	VERTICAL

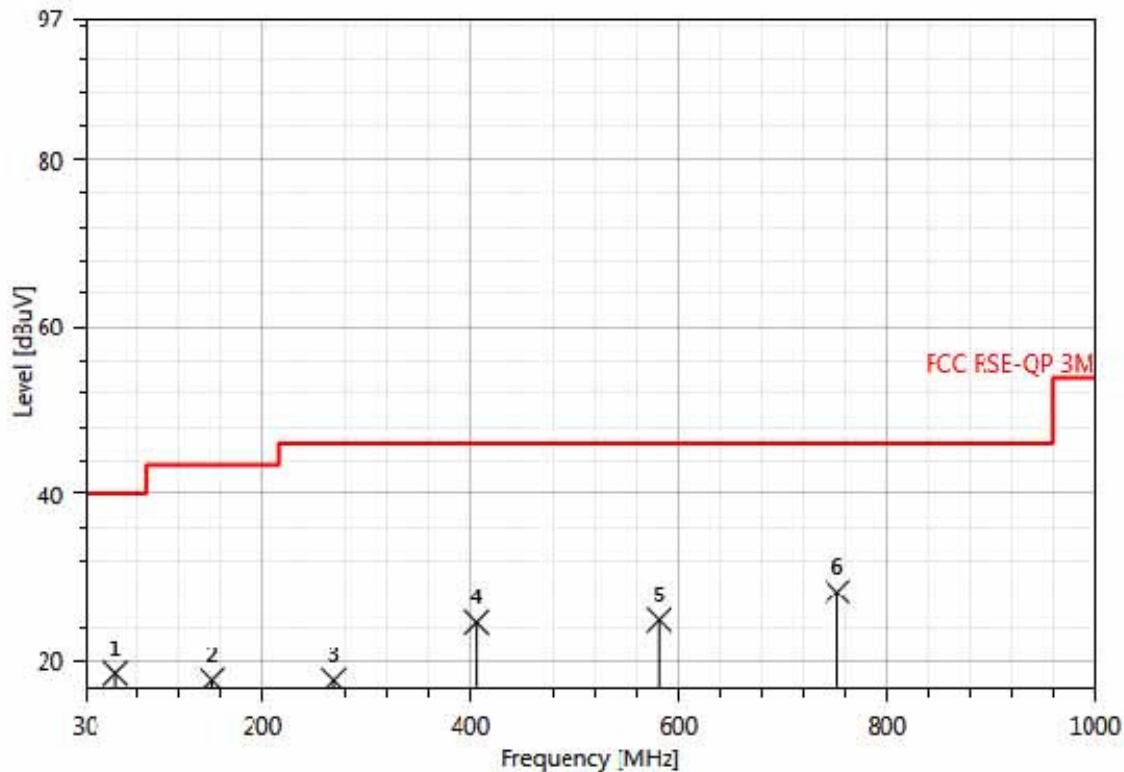

Freq. MHz	Note F/H/E/S	Decetor Mode QP/AV/PK	Actual Reading Level dBμV/m	Spectrum FS dBμV/m	Factor dB	Limit @3m dBuV/m	Margin dB
59.10	S	Peak	18.62	26.64	-8.03	40.00	-21.38
152.22	S	Peak	17.81	25.52	-7.70	43.50	-25.69
268.62	S	Peak	17.79	24.73	-6.94	46.00	-28.21
406.36	S	Peak	24.71	28.30	-3.59	46.00	-21.29
580.96	S	Peak	24.99	25.37	-0.38	46.00	-21.01
752.65	S	Peak	28.34	25.68	2.66	46.00	-17.66

Unless otherwise stated the results shown in this test report refer only to the sample(s) tested and such sample(s) are retained for 90 days only.
除非另有說明，此報告結果僅對測試之樣品負責，同時此樣品僅保留90天。本報告未經本公司書面許可，不可部份複製。

This document is issued by the Company subject to its General Conditions of Service printed overleaf, available on request or accessible at www.sgs.com/terms_and_conditions.htm and, for electronic format documents, subject to Terms and Conditions for Electronic Documents at www.sgs.com/terms_e-document.htm. Attention is drawn to the limitation of liability, indemnification and jurisdiction issues defined therein. Any holder of this document is advised that information contained hereon reflects the Company's findings at the time of its intervention only and within the limits of Client's instructions, if any. The Company's sole responsibility is to its Client and this document does not exonerate parties to a transaction from exercising all their rights and obligations under the transaction documents. This document cannot be reproduced except in full, without prior written approval of the Company. Any unauthorized alteration, forgery or falsification of the content or appearance of this document is unlawful and offenders may be prosecuted to the fullest extent of the law.

Operation Mode :	BR(1M)	Test Date :	12/27/2016
Fundamental Frequency :	2402 MHz	Temp. / Humi. :	22 deg_C / 61 RH
Operation Band :	Tx CH LOW	Test Engineer :	Kane
EUT Pol. :	E2 Plane	Measurement Antenna Pol. :	HORIZONTAL

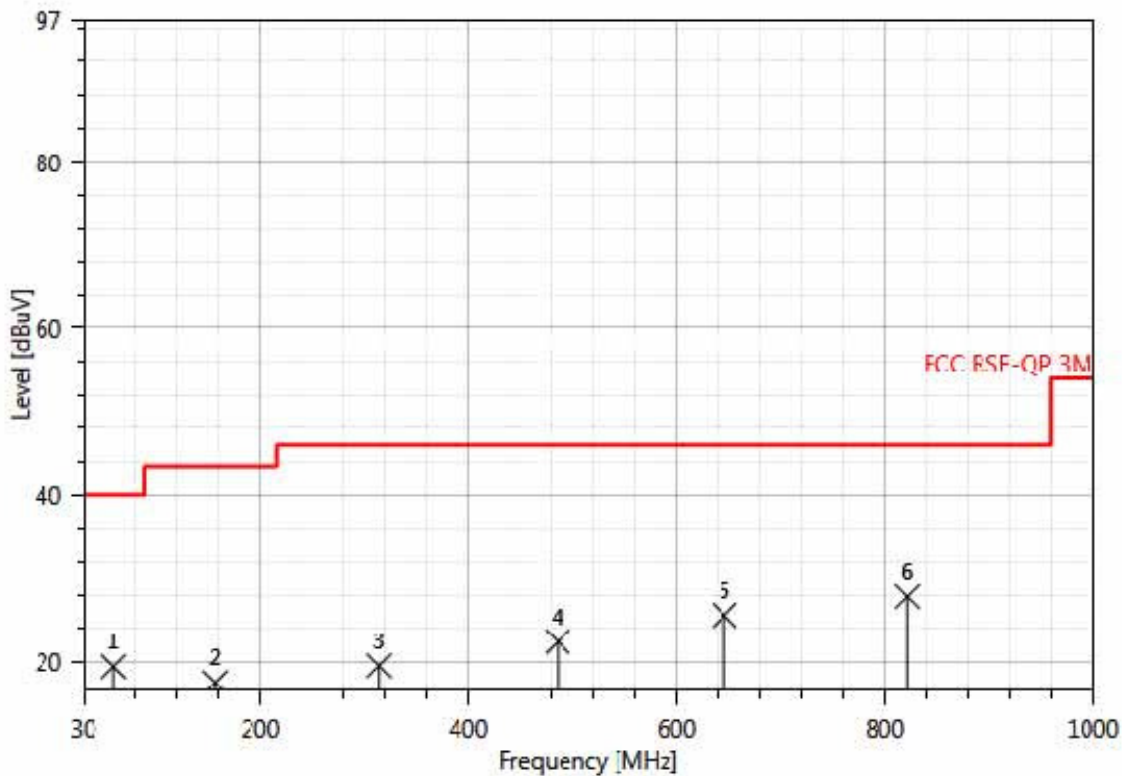

Freq. MHz	Note F/H/E/S	Decetor Mode QP/AV/PK	Actual Reading Level dB μ V/m	Spectrum FS dB μ V/m	Factor dB	Limit @3m dBuV/m	Margin dB
59.10	S	Peak	19.47	27.49	-8.03	40.00	-20.53
157.07	S	Peak	17.53	25.05	-7.52	43.50	-25.97
314.21	S	Peak	19.56	25.05	-5.49	46.00	-26.44
485.90	S	Peak	22.43	24.76	-2.33	46.00	-23.57
645.95	S	Peak	25.58	25.05	0.53	46.00	-20.42
821.52	S	Peak	27.80	24.41	3.39	46.00	-18.20

Unless otherwise stated the results shown in this test report refer only to the sample(s) tested and such sample(s) are retained for 90 days only.

除非另有說明，此報告結果僅對測試之樣品負責，同時此樣品僅保留90天。本報告未經本公司書面許可，不可部份複製。

This document is issued by the Company subject to its General Conditions of Service printed overleaf, available on request or accessible at www.sgs.com/terms_and_conditions.htm and, for electronic format documents, subject to Terms and Conditions for Electronic Documents at www.sgs.com/terms_e-document.htm. Attention is drawn to the limitation of liability, indemnification and jurisdiction issues defined therein. Any holder of this document is advised that information contained hereon reflects the Company's findings at the time of its intervention only and within the limits of Client's instructions, if any. The Company's sole responsibility is to its Client and this document does not exonerate parties to a transaction from exercising all their rights and obligations under the transaction documents. This document cannot be reproduced except in full, without prior written approval of the Company. Any unauthorized alteration, forgery or falsification of the content or appearance of this document is unlawful and offenders may be prosecuted to the fullest extent of the law.

SGS Taiwan Ltd.

No.134,WuKungRoad,NewTaipeiIndustrialPark,WukuDistrict,NewTaipeiCity,Taiwan24803/新北市五股區新北產業園區五工路 134 號

台灣檢驗科技股份有限公司

t (886-2) 2299-3279

f (886-2) 2298-0488

www.tw.sgs.com

Member of SGS Group

Operation Mode :	BR(1M)	Test Date :	12/27/2016
Fundamental Frequency :	2441 MHz	Temp. / Humi. :	22 deg_C / 61 RH
Operation Band :	Tx CH MID	Test Engineer :	Kane
EUT Pol. :	E2 Plane	Measurement Antenna Pol. :	VERTICAL

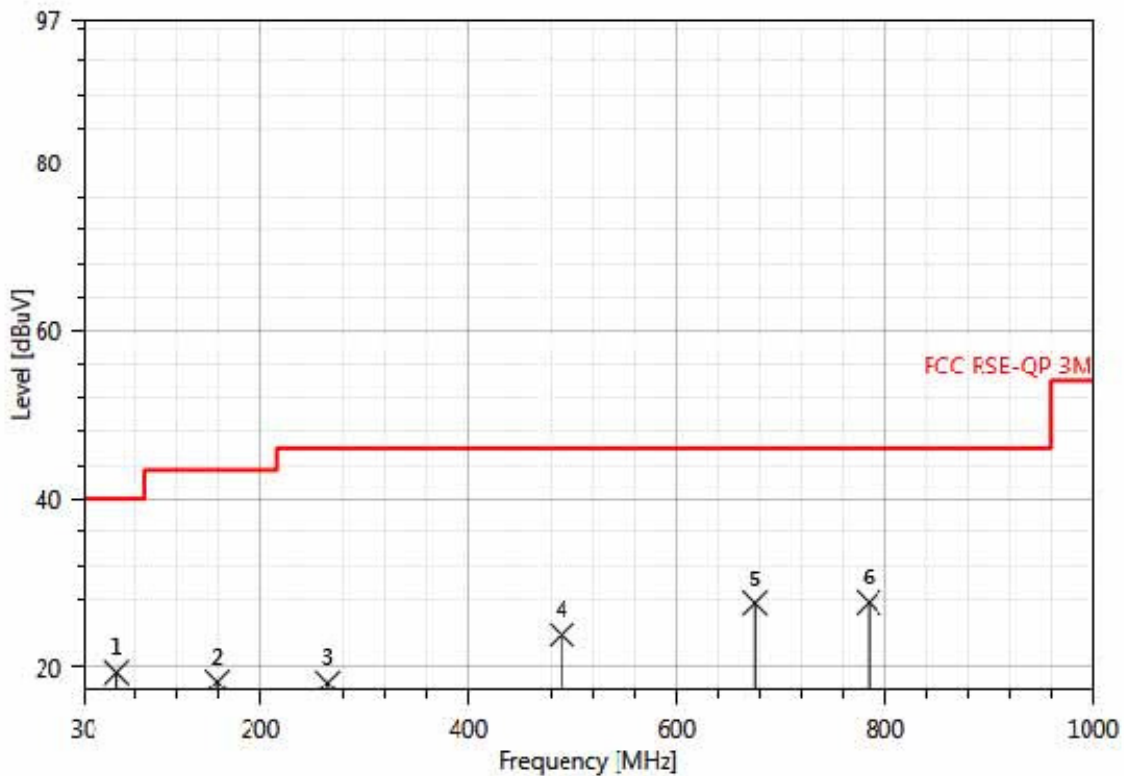

Freq. MHz	Note F/H/E/S	Decetor Mode QP/AV/PK	Actual Reading Level dB μ V/m	Spectrum FS dB μ V/m	Factor dB	Limit @3m dBuV/m	Margin dB
62.01	S	Peak	19.38	27.85	-8.47	40.00	-20.62
159.01	S	Peak	18.28	25.66	-7.38	43.50	-25.22
264.74	S	Peak	18.15	25.20	-7.06	46.00	-27.85
489.78	S	Peak	23.82	26.26	-2.44	46.00	-22.18
675.05	S	Peak	27.59	26.90	0.69	46.00	-18.41
784.66	S	Peak	27.65	24.99	2.66	46.00	-18.35

Unless otherwise stated the results shown in this test report refer only to the sample(s) tested and such sample(s) are retained for 90 days only.

除非另有說明，此報告結果僅對測試之樣品負責，同時此樣品僅保留90天。本報告未經本公司書面許可，不可部份複製。

This document is issued by the Company subject to its General Conditions of Service printed overleaf, available on request or accessible at www.sgs.com/terms_and_conditions.htm and, for electronic format documents, subject to Terms and Conditions for Electronic Documents at www.sgs.com/terms_e-document.htm. Attention is drawn to the limitation of liability, indemnification and jurisdiction issues defined therein. Any holder of this document is advised that information contained hereon reflects the Company's findings at the time of its intervention only and within the limits of Client's instructions, if any. The Company's sole responsibility is to its Client and this document does not exonerate parties to a transaction from exercising all their rights and obligations under the transaction documents. This document cannot be reproduced except in full, without prior written approval of the Company. Any unauthorized alteration, forgery or falsification of the content or appearance of this document is unlawful and offenders may be prosecuted to the fullest extent of the law.

SGS Taiwan Ltd.

No.134,WuKungRoad,NewTaipeiIndustrialPark,WukuDistrict,NewTaipeiCity,Taiwan24803/新北市五股區新北產業園區五工路 134 號

台灣檢驗科技股份有限公司

t (886-2) 2299-3279

f (886-2) 2298-0488

www.tw.sgs.com

Member of SGS Group

Operation Mode :	BR(1M)	Test Date :	12/27/2016
Fundamental Frequency :	2441 MHz	Temp. / Humi. :	22 deg_C / 61 RH
Operation Band :	Tx CH MID	Test Engineer :	Kane
EUT Pol. :	E2 Plane	Measurement Antenna Pol. :	HORIZONTAL

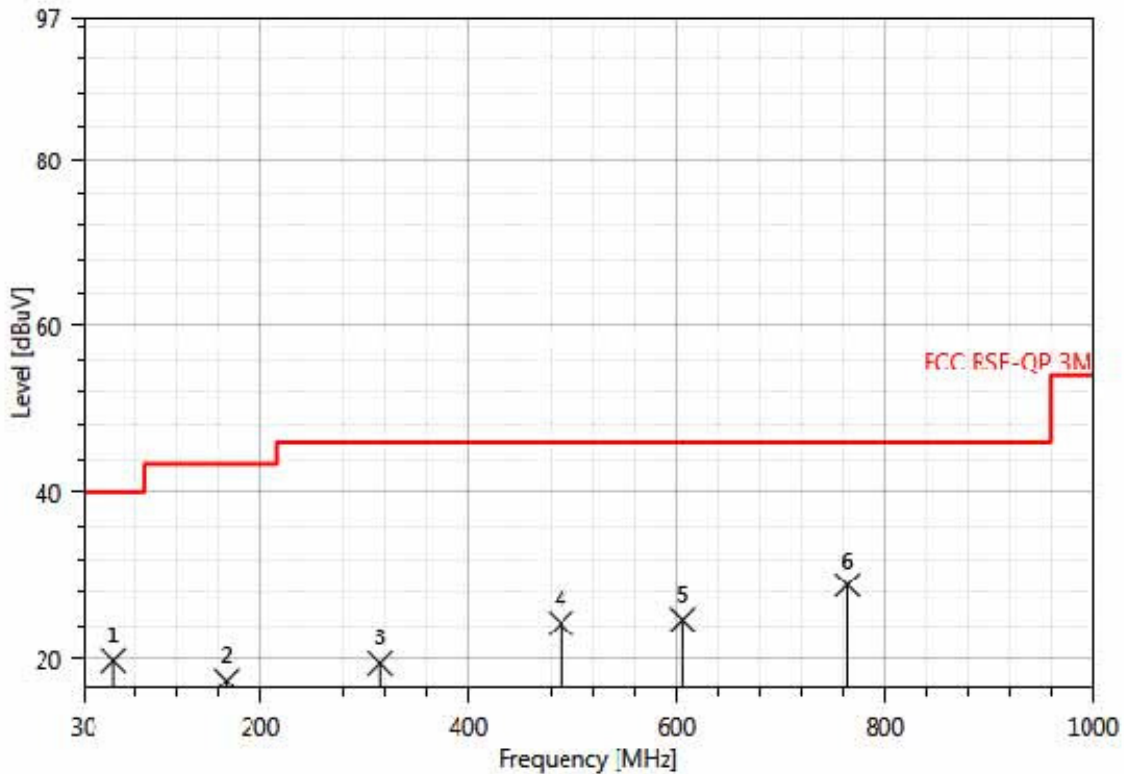

Freq. MHz	Note F/H/E/S	Decetor Mode QP/AV/PK	Actual Reading Level dB μ V/m	Spectrum FS dB μ V/m	Factor dB	Limit @3m dBuV/m	Margin dB
59.10	S	Peak	19.82	27.84	-8.03	40.00	-20.18
167.74	S	Peak	17.41	24.88	-7.46	43.50	-26.09
315.18	S	Peak	19.50	24.93	-5.43	46.00	-26.50
488.81	S	Peak	24.28	26.66	-2.38	46.00	-21.72
606.18	S	Peak	24.72	25.10	-0.37	46.00	-21.28
764.29	S	Peak	28.87	25.91	2.97	46.00	-17.13

Unless otherwise stated the results shown in this test report refer only to the sample(s) tested and such sample(s) are retained for 90 days only.
除非另有說明，此報告結果僅對測試之樣品負責，同時此樣品僅保留90天。本報告未經本公司書面許可，不可部份複製。

This document is issued by the Company subject to its General Conditions of Service printed overleaf, available on request or accessible at www.sgs.com/terms_and_conditions.htm and, for electronic format documents, subject to Terms and Conditions for Electronic Documents at www.sgs.com/terms_e-document.htm. Attention is drawn to the limitation of liability, indemnification and jurisdiction issues defined therein. Any holder of this document is advised that information contained hereon reflects the Company's findings at the time of its intervention only and within the limits of Client's instructions, if any. The Company's sole responsibility is to its Client and this document does not exonerate parties to a transaction from exercising all their rights and obligations under the transaction documents. This document cannot be reproduced except in full, without prior written approval of the Company. Any unauthorized alteration, forgery or falsification of the content or appearance of this document is unlawful and offenders may be prosecuted to the fullest extent of the law.

Operation Mode :	BR(1M)	Test Date :	12/27/2016
Fundamental Frequency :	2480 MHz	Temp. / Humi. :	22 deg_C / 61 RH
Operation Band :	Tx CH HIGH	Test Engineer :	Kane
EUT Pol. :	E2 Plane	Measurement Antenna Pol. :	VERTICAL

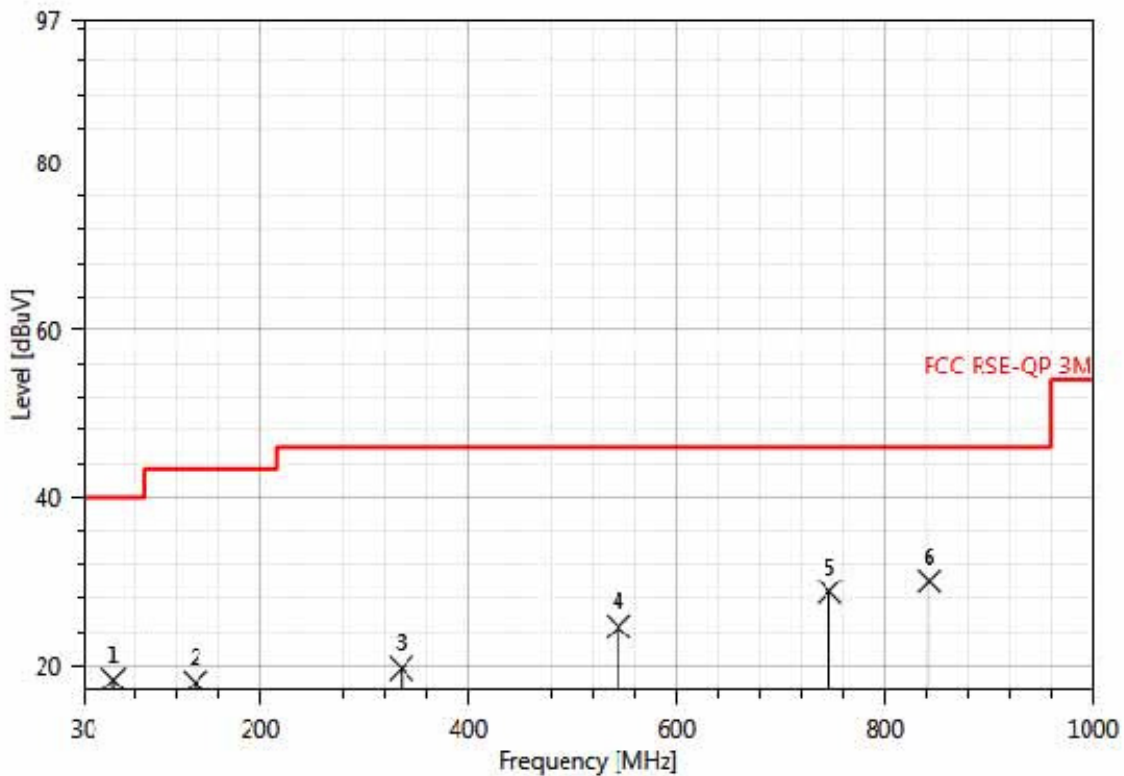

Freq. MHz	Note F/H/E/S	Decetor Mode QP/AV/PK	Actual Reading Level dB μ V/m	Spectrum FS dB μ V/m	Factor dB	Limit @3m dBuV/m	Margin dB
59.10	S	Peak	18.29	26.31	-8.03	40.00	-21.71
137.67	S	Peak	17.95	26.50	-8.55	43.50	-25.55
335.55	S	Peak	19.67	25.00	-5.32	46.00	-26.33
544.10	S	Peak	24.60	26.20	-1.60	46.00	-21.40
746.83	S	Peak	28.78	26.41	2.37	46.00	-17.22
842.86	S	Peak	30.04	26.64	3.40	46.00	-15.96

Unless otherwise stated the results shown in this test report refer only to the sample(s) tested and such sample(s) are retained for 90 days only.

除非另有說明，此報告結果僅對測試之樣品負責，同時此樣品僅保留90天。本報告未經本公司書面許可，不可部份複製。

This document is issued by the Company subject to its General Conditions of Service printed overleaf, available on request or accessible at www.sgs.com/terms_and_conditions.htm and, for electronic format documents, subject to Terms and Conditions for Electronic Documents at www.sgs.com/terms_e-document.htm. Attention is drawn to the limitation of liability, indemnification and jurisdiction issues defined therein. Any holder of this document is advised that information contained hereon reflects the Company's findings at the time of its intervention only and within the limits of Client's instructions, if any. The Company's sole responsibility is to its Client and this document does not exonerate parties to a transaction from exercising all their rights and obligations under the transaction documents. This document cannot be reproduced except in full, without prior written approval of the Company. Any unauthorized alteration, forgery or falsification of the content or appearance of this document is unlawful and offenders may be prosecuted to the fullest extent of the law.

SGS Taiwan Ltd.

No.134,WuKungRoad,NewTaipeiIndustrialPark,WukuDistrict,NewTaipeiCity,Taiwan24803/新北市五股區新北產業園區五工路 134 號

台灣檢驗科技股份有限公司

t (886-2) 2299-3279

f (886-2) 2298-0488

www.tw.sgs.com

Member of SGS Group

Operation Mode :	BR(1M)	Test Date :	12/27/2016
Fundamental Frequency :	2480 MHz	Temp. / Humi. :	22 deg_C / 61 RH
Operation Band :	Tx CH HIGH	Test Engineer :	Kane
EUT Pol. :	E2 Plane	Measurement Antenna Pol. :	HORIZONTAL

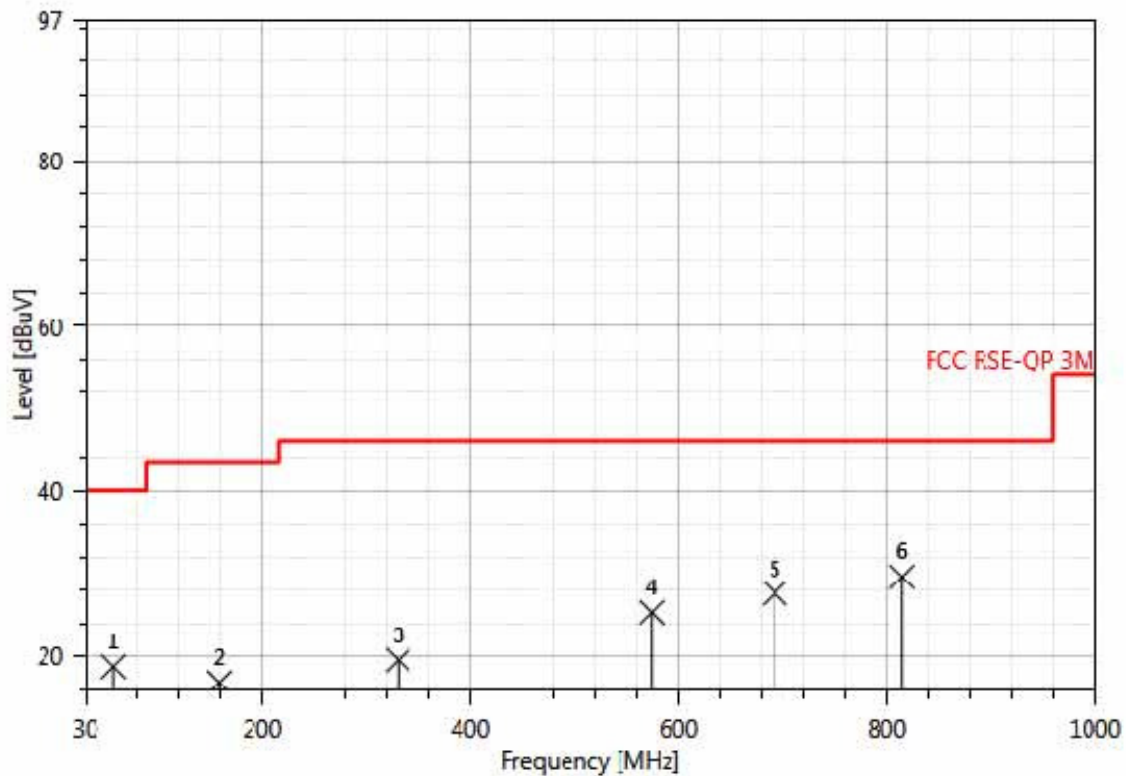

Freq. MHz	Note F/H/E/S	Decetor Mode QP/AV/PK	Actual Reading Level dB μ V/m	Spectrum FS dB μ V/m	Factor dB	Limit @3m dBuV/m	Margin dB
57.16	S	Peak	18.73	26.71	-7.97	40.00	-21.27
159.01	S	Peak	16.80	24.18	-7.38	43.50	-26.70
330.70	S	Peak	19.54	24.97	-5.42	46.00	-26.46
574.17	S	Peak	25.30	26.10	-0.80	46.00	-20.70
692.51	S	Peak	27.62	26.15	1.47	46.00	-18.38
814.73	S	Peak	29.59	26.23	3.36	46.00	-16.41

Unless otherwise stated the results shown in this test report refer only to the sample(s) tested and such sample(s) are retained for 90 days only.

除非另有說明，此報告結果僅對測試之樣品負責，同時此樣品僅保留90天。本報告未經本公司書面許可，不可部份複製。

This document is issued by the Company subject to its General Conditions of Service printed overleaf, available on request or accessible at www.sgs.com/terms_and_conditions.htm and, for electronic format documents, subject to Terms and Conditions for Electronic Documents at www.sgs.com/terms_e-document.htm. Attention is drawn to the limitation of liability, indemnification and jurisdiction issues defined therein. Any holder of this document is advised that information contained hereon reflects the Company's findings at the time of its intervention only and within the limits of Client's instructions, if any. The Company's sole responsibility is to its Client and this document does not exonerate parties to a transaction from exercising all their rights and obligations under the transaction documents. This document cannot be reproduced except in full, without prior written approval of the Company. Any unauthorized alteration, forgery or falsification of the content or appearance of this document is unlawful and offenders may be prosecuted to the fullest extent of the law.

SGS Taiwan Ltd.

No.134,WuKungRoad,NewTaipeiIndustrialPark,WukuDistrict,NewTaipeiCity,Taiwan24803/新北市五股區新北產業園區五工路 134 號

台灣檢驗科技股份有限公司

t (886-2) 2299-3279

f (886-2) 2298-0488

www.tw.sgs.com

Member of SGS Group

**Radiated Spurious Emission Measurement Result:
For Frequency above 1 GHz**

Operation Mode :	BR(1M)	Test Date :	12/27/2016
Fundamental Frequency :	2402 MHz	Temp. / Humi. :	22 deg_C / 61 RH
Operation Band :	Tx CH LOW	Test Engineer :	Kane
EUT Pol. :	E2 Plane	Measurement Antenna Pol. :	VERTICAL

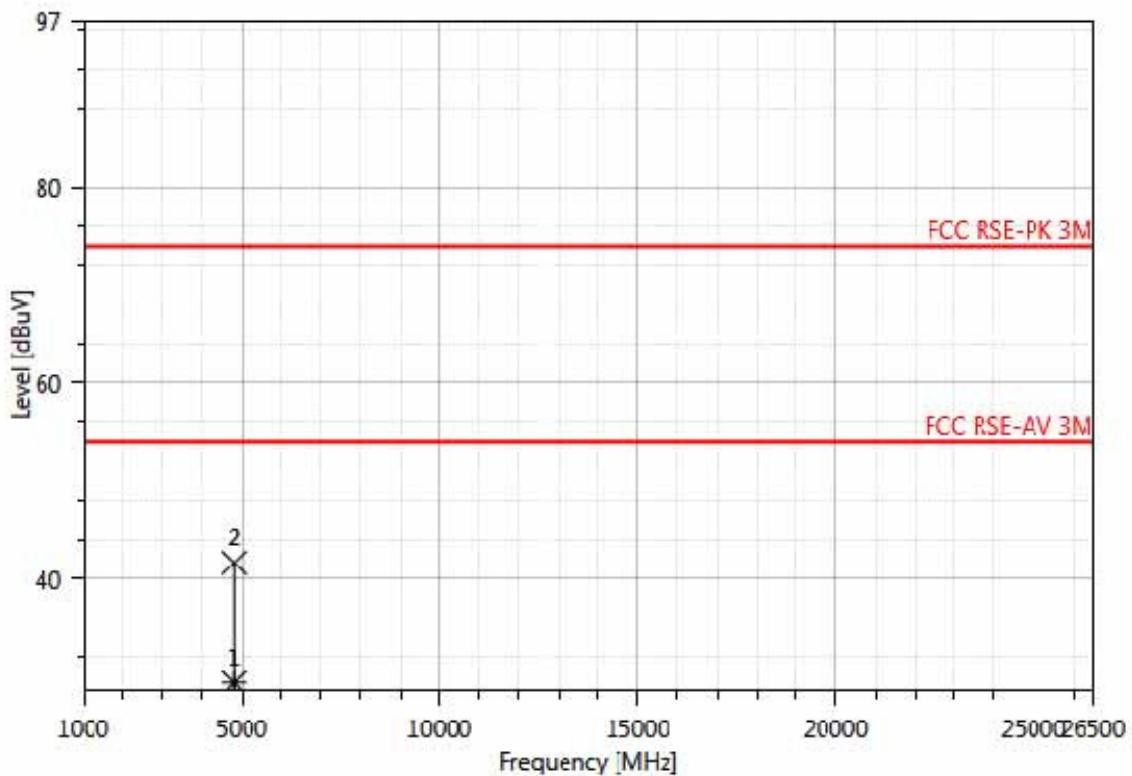

Freq. MHz	Note F/H/E/S	Decetor Mode QP/AV/PK	Actual Reading Level dBuV/m	Spectrum FS dBuV/m	Factor dB	Limit @3m dBuV/m	Margin dB
4804.00	H	Average	29.36	24.44	4.92	54.00	-24.64
4804.00	H	Peak	41.63	36.71	4.92	74.00	-32.37

Unless otherwise stated the results shown in this test report refer only to the sample(s) tested and such sample(s) are retained for 90 days only.
除非另有說明，此報告結果僅對測試之樣品負責，同時此樣品僅保留90天。本報告未經本公司書面許可，不可部份複製。

This document is issued by the Company subject to its General Conditions of Service printed overleaf, available on request or accessible at www.sgs.com/terms_and_conditions.htm and, for electronic format documents, subject to Terms and Conditions for Electronic Documents at www.sgs.com/terms_e-document.htm. Attention is drawn to the limitation of liability, indemnification and jurisdiction issues defined therein. Any holder of this document is advised that information contained hereon reflects the Company's findings at the time of its intervention only and within the limits of Client's instructions, if any. The Company's sole responsibility is to its Client and this document does not exonerate parties to a transaction from exercising all their rights and obligations under the transaction documents. This document cannot be reproduced except in full, without prior written approval of the Company. Any unauthorized alteration, forgery or falsification of the content or appearance of this document is unlawful and offenders may be prosecuted to the fullest extent of the law.

Operation Mode :	BR(1M)	Test Date :	12/27/2016
Fundamental Frequency :	2402 MHz	Temp. / Humi. :	22 deg_C / 61 RH
Operation Band :	Tx CH LOW	Test Engineer :	Kane
EUT Pol. :	E2 Plane	Measurement Antenna Pol. :	HORIZONTAL

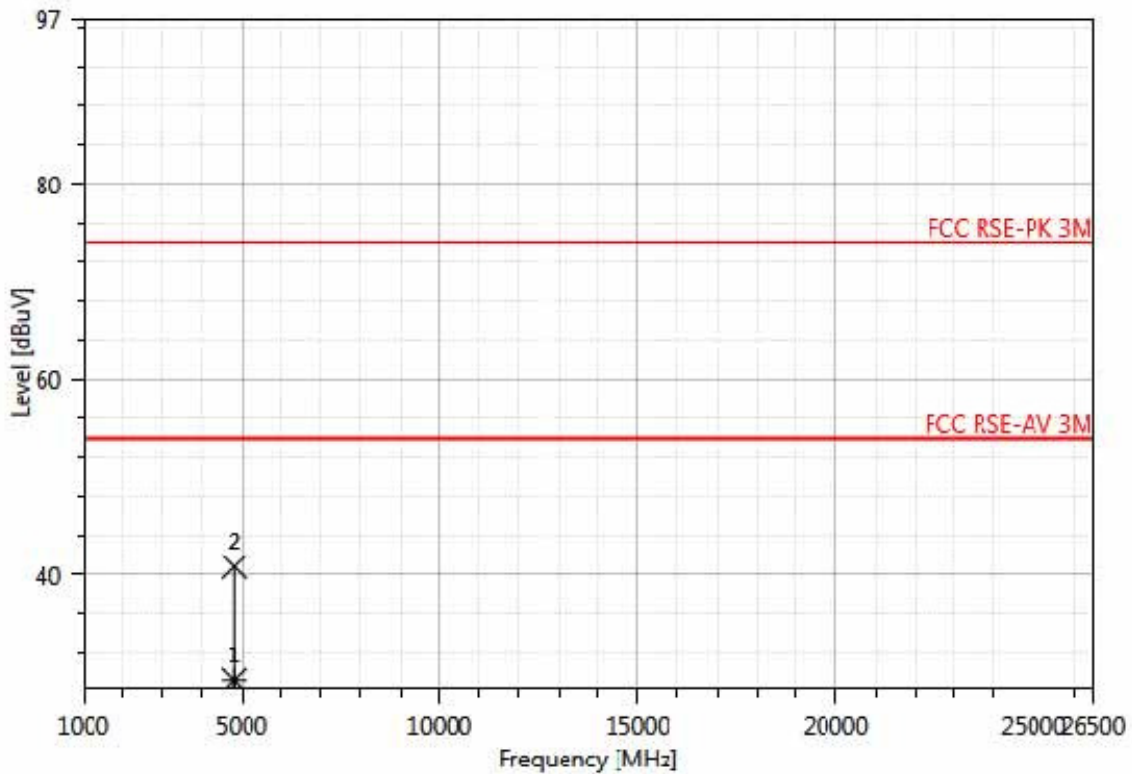

Freq. MHz	Note F/H/E/S	Decetor Mode QP/AV/PK	Actual Reading Level dB μ V/m	Spectrum FS dB μ V/m	Factor dB	Limit @3m dBuV/m	Margin dB
4804.00	H	Average	29.14	24.22	4.92	54.00	-24.86
4804.00	H	Peak	40.80	35.88	4.92	74.00	-33.20

Unless otherwise stated the results shown in this test report refer only to the sample(s) tested and such sample(s) are retained for 90 days only.

除非另有說明，此報告結果僅對測試之樣品負責，同時此樣品僅保留90天。本報告未經本公司書面許可，不可部份複製。

This document is issued by the Company subject to its General Conditions of Service printed overleaf, available on request or accessible at www.sgs.com/terms_and_conditions.htm and, for electronic format documents, subject to Terms and Conditions for Electronic Documents at www.sgs.com/terms_e-document.htm. Attention is drawn to the limitation of liability, indemnification and jurisdiction issues defined therein. Any holder of this document is advised that information contained hereon reflects the Company's findings at the time of its intervention only and within the limits of Client's instructions, if any. The Company's sole responsibility is to its Client and this document does not exonerate parties to a transaction from exercising all their rights and obligations under the transaction documents. This document cannot be reproduced except in full, without prior written approval of the Company. Any unauthorized alteration, forgery or falsification of the content or appearance of this document is unlawful and offenders may be prosecuted to the fullest extent of the law.

SGS Taiwan Ltd.

No. 134, WuKung Road, New Taipei Industrial Park, Wuku District, New Taipei City, Taiwan 24803 / 新北市五股區新北產業園區五工路 134 號

台灣檢驗科技股份有限公司

t (886-2) 2299-3279

f (886-2) 2298-0488

www.tw.sgs.com

Member of SGS Group

Operation Mode :	BR(1M)	Test Date :	12/27/2016
Fundamental Frequency :	2441 MHz	Temp. / Humi. :	22 deg_C / 61 RH
Operation Band :	Tx CH MID	Test Engineer :	Kane
EUT Pol. :	E2 Plane	Measurement Antenna Pol. :	VERTICAL

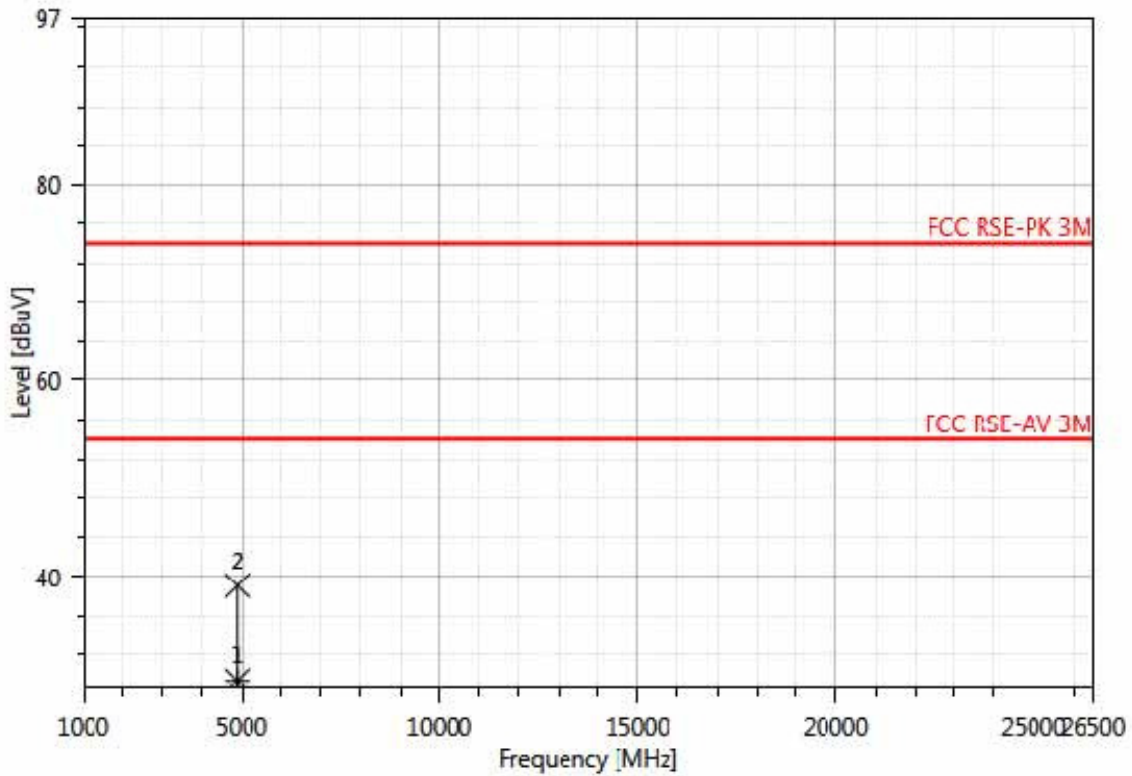

Freq. MHz	Note F/H/E/S	Decetor Mode QP/AV/PK	Actual Reading Level dB μ V/m	Spectrum FS dB μ V/m	Factor dB	Limit @3m dBuV/m	Margin dB
4882.00	H	Average	29.37	24.19	5.18	54.00	-24.63
4882.00	H	Peak	39.07	33.89	5.18	74.00	-34.93

Unless otherwise stated the results shown in this test report refer only to the sample(s) tested and such sample(s) are retained for 90 days only.

除非另有說明，此報告結果僅對測試之樣品負責，同時此樣品僅保留90天。本報告未經本公司書面許可，不可部份複製。

This document is issued by the Company subject to its General Conditions of Service printed overleaf, available on request or accessible at www.sgs.com/terms_and_conditions.htm and, for electronic format documents, subject to Terms and Conditions for Electronic Documents at www.sgs.com/terms_e-document.htm. Attention is drawn to the limitation of liability, indemnification and jurisdiction issues defined therein. Any holder of this document is advised that information contained hereon reflects the Company's findings at the time of its intervention only and within the limits of Client's instructions, if any. The Company's sole responsibility is to its Client and this document does not exonerate parties to a transaction from exercising all their rights and obligations under the transaction documents. This document cannot be reproduced except in full, without prior written approval of the Company. Any unauthorized alteration, forgery or falsification of the content or appearance of this document is unlawful and offenders may be prosecuted to the fullest extent of the law.

SGS Taiwan Ltd.

No.134,WuKungRoad,NewTaipeiIndustrialPark,WukuDistrict,NewTaipeiCity,Taiwan24803/新北市五股區新北產業園區五工路 134 號

台灣檢驗科技股份有限公司

t (886-2) 2299-3279

f (886-2) 2298-0488

www.tw.sgs.com

Member of SGS Group

Operation Mode :	BR(1M)	Test Date :	12/27/2016
Fundamental Frequency :	2441 MHz	Temp. / Humi. :	22 deg_C / 61 RH
Operation Band :	Tx CH MID	Test Engineer :	Kane
EUT Pol. :	E2 Plane	Measurement Antenna Pol. :	HORIZONTAL

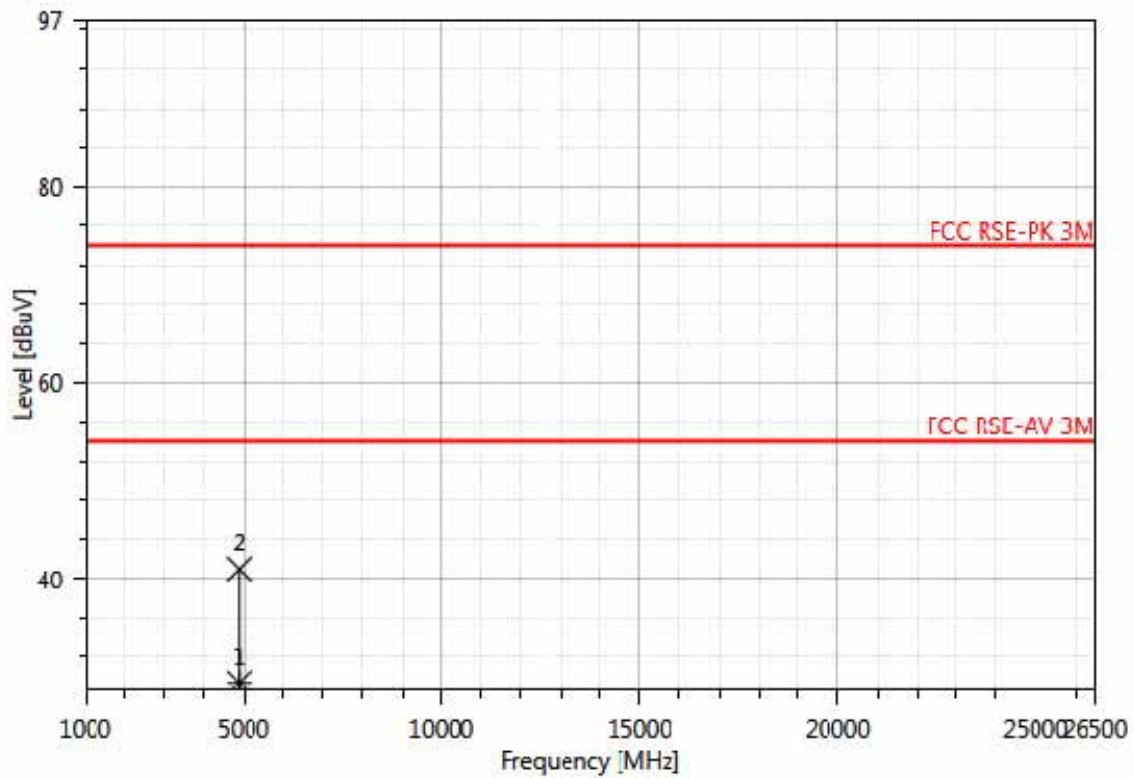

Freq. MHz	Note F/H/E/S	Decetor Mode QP/AV/PK	Actual Reading Level dB μ V/m	Spectrum FS dB μ V/m	Factor dB	Limit @3m dBuV/m	Margin dB
4882.00	H	Average	29.40	24.22	5.18	54.00	-24.60
4882.00	H	Peak	40.99	35.81	5.18	74.00	-33.01

Unless otherwise stated the results shown in this test report refer only to the sample(s) tested and such sample(s) are retained for 90 days only.

除非另有說明，此報告結果僅對測試之樣品負責，同時此樣品僅保留90天。本報告未經本公司書面許可，不可部份複製。

This document is issued by the Company subject to its General Conditions of Service printed overleaf, available on request or accessible at www.sgs.com/terms_and_conditions.htm and, for electronic format documents, subject to Terms and Conditions for Electronic Documents at www.sgs.com/terms_e-document.htm. Attention is drawn to the limitation of liability, indemnification and jurisdiction issues defined therein. Any holder of this document is advised that information contained hereon reflects the Company's findings at the time of its intervention only and within the limits of Client's instructions, if any. The Company's sole responsibility is to its Client and this document does not exonerate parties to a transaction from exercising all their rights and obligations under the transaction documents. This document cannot be reproduced except in full, without prior written approval of the Company. Any unauthorized alteration, forgery or falsification of the content or appearance of this document is unlawful and offenders may be prosecuted to the fullest extent of the law.

SGS Taiwan Ltd.

No.134,WuKungRoad,NewTaipeiIndustrialPark,WukuDistrict,NewTaipeiCity,Taiwan24803/新北市五股區新北產業園區五工路 134 號

台灣檢驗科技股份有限公司

t (886-2) 2299-3279

f (886-2) 2298-0488

www.tw.sgs.com

Member of SGS Group

Operation Mode :	BR(1M)	Test Date :	12/27/2016
Fundamental Frequency :	2480 MHz	Temp. / Humi. :	22 deg_C / 61 RH
Operation Band :	Tx CH HIGH	Test Engineer :	Kane
EUT Pol. :	E2 Plane	Measurement Antenna Pol. :	VERTICAL

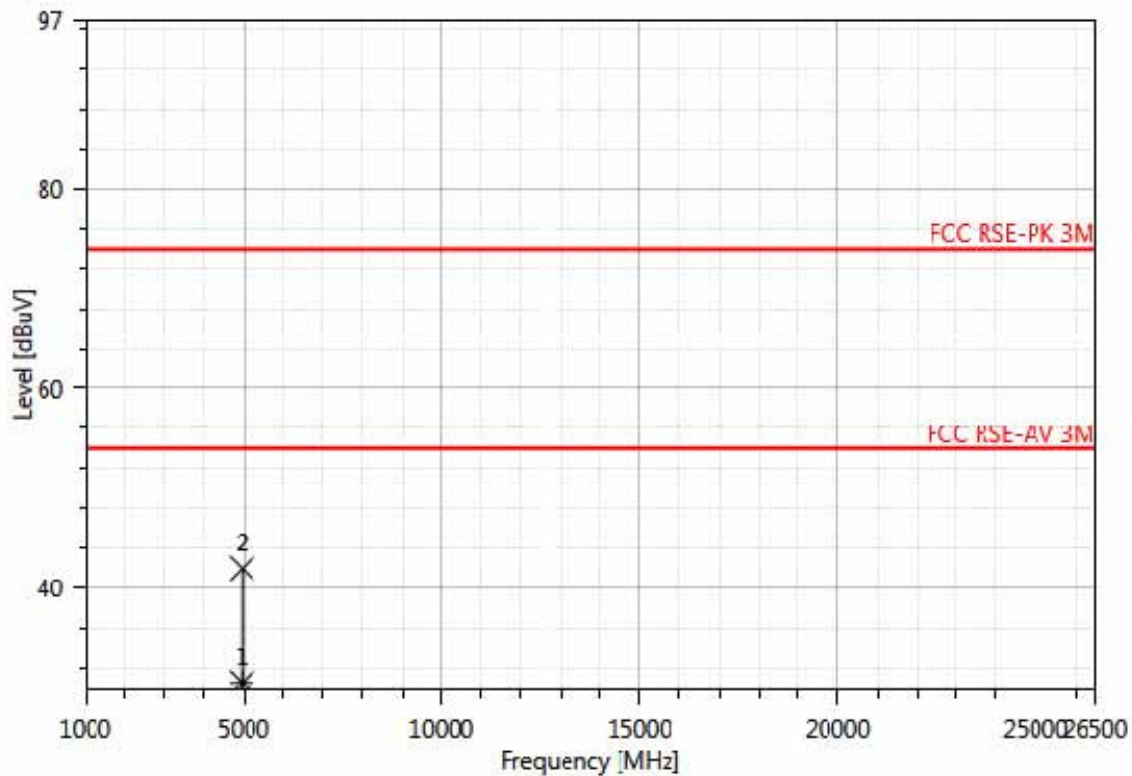

Freq. MHz	Note F/H/E/S	Decetor Mode QP/AV/PK	Actual Reading Level dB μ V/m	Spectrum FS dB μ V/m	Factor dB	Limit @3m dBuV/m	Margin dB
4960.00	H	Average	30.47	25.18	5.29	54.00	-23.53
4960.00	H	Peak	41.96	36.67	5.29	74.00	-32.04

Unless otherwise stated the results shown in this test report refer only to the sample(s) tested and such sample(s) are retained for 90 days only.

除非另有說明，此報告結果僅對測試之樣品負責，同時此樣品僅保留90天。本報告未經本公司書面許可，不可部份複製。

This document is issued by the Company subject to its General Conditions of Service printed overleaf, available on request or accessible at www.sgs.com/terms_and_conditions.htm and, for electronic format documents, subject to Terms and Conditions for Electronic Documents at www.sgs.com/terms_e-document.htm. Attention is drawn to the limitation of liability, indemnification and jurisdiction issues defined therein. Any holder of this document is advised that information contained hereon reflects the Company's findings at the time of its intervention only and within the limits of Client's instructions, if any. The Company's sole responsibility is to its Client and this document does not exonerate parties to a transaction from exercising all their rights and obligations under the transaction documents. This document cannot be reproduced except in full, without prior written approval of the Company. Any unauthorized alteration, forgery or falsification of the content or appearance of this document is unlawful and offenders may be prosecuted to the fullest extent of the law.

SGS Taiwan Ltd.

No. 134, WuKungRoad, NewTaipeiIndustrialPark, WukuDistrict, NewTaipeiCity, Taiwan24803/新北市五股區新北產業園區五工路 134 號

台灣檢驗科技股份有限公司

t (886-2) 2299-3279

f (886-2) 2298-0488

www.tw.sgs.com

Member of SGS Group

Operation Mode :	BR(1M)	Test Date :	12/27/2016
Fundamental Frequency :	2480 MHz	Temp. / Humi. :	22 deg_C / 61 RH
Operation Band :	Tx CH HIGH	Test Engineer :	Kane
EUT Pol. :	E2 Plane	Measurement Antenna Pol. :	HORIZONTAL

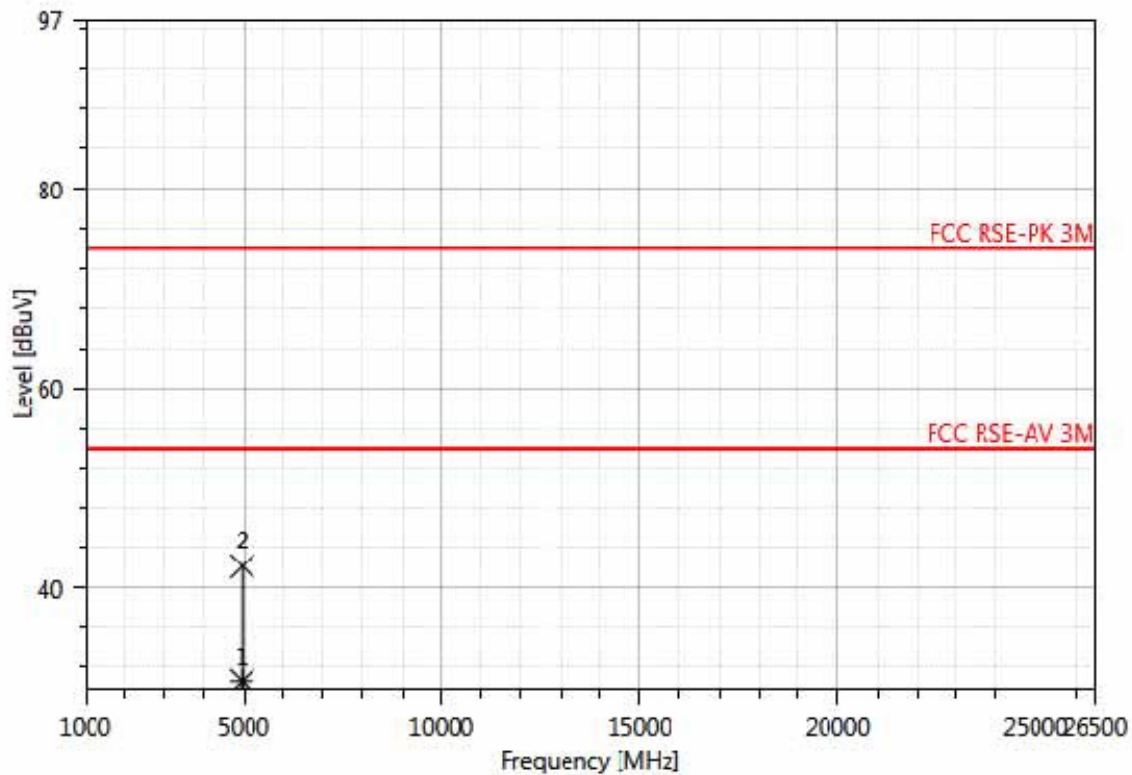

Freq. MHz	Note F/H/E/S	Decetor Mode QP/AV/PK	Actual Reading Level dB μ V/m	Spectrum FS dB μ V/m	Factor dB	Limit @3m dBuV/m	Margin dB
4960.00	H	Average	30.58	25.29	5.29	54.00	-23.42
4960.00	H	Peak	42.17	36.88	5.29	74.00	-31.83

Unless otherwise stated the results shown in this test report refer only to the sample(s) tested and such sample(s) are retained for 90 days only.

除非另有說明，此報告結果僅對測試之樣品負責，同時此樣品僅保留90天。本報告未經本公司書面許可，不可部份複製。

This document is issued by the Company subject to its General Conditions of Service printed overleaf, available on request or accessible at www.sgs.com/terms_and_conditions.htm and, for electronic format documents, subject to Terms and Conditions for Electronic Documents at www.sgs.com/terms_e-document.htm. Attention is drawn to the limitation of liability, indemnification and jurisdiction issues defined therein. Any holder of this document is advised that information contained hereon reflects the Company's findings at the time of its intervention only and within the limits of Client's instructions, if any. The Company's sole responsibility is to its Client and this document does not exonerate parties to a transaction from exercising all their rights and obligations under the transaction documents. This document cannot be reproduced except in full, without prior written approval of the Company. Any unauthorized alteration, forgery or falsification of the content or appearance of this document is unlawful and offenders may be prosecuted to the fullest extent of the law.

SGS Taiwan Ltd.

No.134,WuKungRoad,NewTaipeiIndustrialPark,WukuDistrict,NewTaipeiCity,Taiwan24803/新北市五股區新北產業園區五工路 134 號

台灣檢驗科技股份有限公司

t (886-2) 2299-3279

f (886-2) 2298-0488

www.tw.sgs.com

Member of SGS Group

11 FREQUENCY SEPARATION

11.1 Standard Applicable

Frequency hopping systems shall have hopping channel carrier frequencies separated by minimum of 25 kHz or the $2/3 \times 20\text{dB}$ bandwidth of the hopping channel, whichever is greater.

11.2 Measurement Equipment Used

Conducted Emission Test Site					
EQUIPMENT TYPE	MFR	MODEL NUMBER	SERIAL NUMBER	LAST CAL.	CAL DUE.
EXA Spectrum Analyzer	Agilent	N9030A	MY53120760	02/26/2016	02/25/2017
DC Block	Mini-Circuits	BLK-18-S+	1	01/02/2016	01/01/2017
Attenuator	Mini-Circuit	BW-S10W2+	2	01/02/2016	01/01/2017
Splitter	Agilent	11636B	N/A	01/02/2016	01/01/2017

EQUIPMENT TYPE	MFR	MODEL NUMBER	SERIAL NUMBER	LAST CAL.	CAL DUE.
DC Block	Mini-Circuits	BLK-18-S+	1	01/02/2017	01/01/2018
Attenuator	Mini-Circuit	BW-S10W2+	2	01/02/2017	01/01/2018
Splitter	Agilent	11636B	N/A	01/02/2017	01/01/2018

Note: The measurement was taken place with the long duration of the time, and additional equipment list as shown above indicate those equipment of which has been subject to undertake the calibration in intermediate period of time of the measurement.

Unless otherwise stated the results shown in this test report refer only to the sample(s) tested and such sample(s) are retained for 90 days only.

除非另有說明，此報告結果僅對測試之樣品負責，同時此樣品僅保留90天。本報告未經本公司書面許可，不可部份複製。

This document is issued by the Company subject to its General Conditions of Service printed overleaf, available on request or accessible at www.sgs.com/terms_and_conditions.htm and, for electronic format documents, subject to Terms and Conditions for Electronic Documents at www.sgs.com/terms_e-document.htm. Attention is drawn to the limitation of liability, indemnification and jurisdiction issues defined therein. Any holder of this document is advised that information contained hereon reflects the Company's findings at the time of its intervention only and within the limits of Client's instructions, if any. The Company's sole responsibility is to its Client and this document does not exonerate parties to a transaction from exercising all their rights and obligations under the transaction documents. This document cannot be reproduced except in full, without prior written approval of the Company. Any unauthorized alteration, forgery or falsification of the content or appearance of this document is unlawful and offenders may be prosecuted to the fullest extent of the law.

SGS Taiwan Ltd.

No.134,WuKungRoad,NewTaipeiIndustrialPark,WukuDistrict,NewTaipeiCity,Taiwan24803/新北市五股區新北產業園區五工路 134 號

台灣檢驗科技股份有限公司

t (886-2) 2299-3279

f (886-2) 2298-0488

www.tw.sgs.com

Member of SGS Group

11.3 Test Set-up

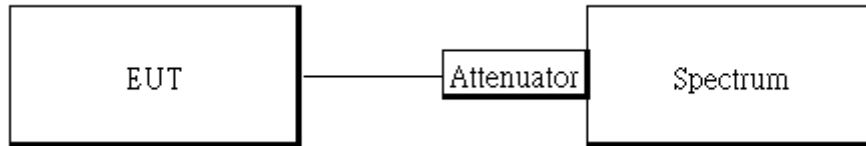

11.4 Measurement Procedure

1. Place the EUT on the table and set it in transmitting mode.
2. The testing follows FCC Public Notice DA 00-705 Measurement Guidelines.
3. Remove the antenna from the EUT and then connect a low loss RF cable from the antenna port to the spectrum analyzer.
4. Set center frequency of spectrum analyzer = middle of hopping channel.
5. Set the spectrum analyzer as RBW, VBW=100 kHz, Adjust Span to 5MHz, Sweep = auto.
6. Max hold. Mark 3 Peaks of hopping channel and record the 3 peaks frequency.

Unless otherwise stated the results shown in this test report refer only to the sample(s) tested and such sample(s) are retained for 90 days only.

除非另有說明，此報告結果僅對測試之樣品負責，同時此樣品僅保留90天。本報告未經本公司書面許可，不可部份複製。

This document is issued by the Company subject to its General Conditions of Service printed overleaf, available on request or accessible at www.sgs.com/terms_and_conditions.htm and, for electronic format documents, subject to Terms and Conditions for Electronic Documents at www.sgs.com/terms_e-document.htm. Attention is drawn to the limitation of liability, indemnification and jurisdiction issues defined therein. Any holder of this document is advised that information contained hereon reflects the Company's findings at the time of its intervention only and within the limits of Client's instructions, if any. The Company's sole responsibility is to its Client and this document does not exonerate parties to a transaction from exercising all their rights and obligations under the transaction documents. This document cannot be reproduced except in full, without prior written approval of the Company. Any unauthorized alteration, forgery or falsification of the content or appearance of this document is unlawful and offenders may be prosecuted to the fullest extent of the law.

SGS Taiwan Ltd.

No.134,WuKungRoad,NewTaipeiIndustrialPark,WukuDistrict,NewTaipeiCity,Taiwan24803/新北市五股區新北產業園區五工路 134 號

台灣檢驗科技股份有限公司

t (886-2) 2299-3279

f (886-2) 2298-0488

www.tw.sgs.com

Member of SGS Group

11.5 Measurement Result

Channel separation (MHz)	Limit	Result
1	≥ 25 kHz or 2/3 times 20dB bandwidth	PASS

Frequency Separation Test Data



Unless otherwise stated the results shown in this test report refer only to the sample(s) tested and such sample(s) are retained for 90 days only.

除非另有說明，此報告結果僅對測試之樣品負責，同時此樣品僅保留90天。本報告未經本公司書面許可，不可部份複製。

This document is issued by the Company subject to its General Conditions of Service printed overleaf, available on request or accessible at www.sgs.com/terms_and_conditions.htm and, for electronic format documents, subject to Terms and Conditions for Electronic Documents at www.sgs.com/terms_e-document.htm. Attention is drawn to the limitation of liability, indemnification and jurisdiction issues defined therein. Any holder of this document is advised that information contained hereon reflects the Company's findings at the time of its intervention only and within the limits of Client's instructions, if any. The Company's sole responsibility is to its Client and this document does not exonerate parties to a transaction from exercising all their rights and obligations under the transaction documents. This document cannot be reproduced except in full, without prior written approval of the Company. Any unauthorized alteration, forgery or falsification of the content or appearance of this document is unlawful and offenders may be prosecuted to the fullest extent of the law.

SGS Taiwan Ltd.

No.134,WuKungRoad,NewTaipeiIndustrialPark,WukuDistrict,NewTaipeiCity,Taiwan24803/新北市五股區新北產業園區五工路 134 號

台灣檢驗科技股份有限公司

t (886-2) 2299-3279

f (886-2) 2298-0488

www.tw.sgs.com

Member of SGS Group

12 NUMBER OF HOPPING FREQUENCY

12.1 Standard Applicable

Frequency hopping systems operating in the 2400MHz-2483.5 MHz bands shall use at least 15 hopping frequencies.

12.2 Measurement Equipment Used

Conducted Emission Test Site					
EQUIPMENT TYPE	MFR	MODEL NUMBER	SERIAL NUMBER	LAST CAL.	CAL DUE.
EXA Spectrum Analyzer	Agilent	N9030A	MY53120760	02/26/2016	02/25/2017
DC Block	Mini-Circuits	BLK-18-S+	1	01/02/2016	01/01/2017
Attenuator	Mini-Circuit	BW-S10W2+	2	01/02/2016	01/01/2017
Splitter	Agilent	11636B	N/A	01/02/2016	01/01/2017

EQUIPMENT TYPE	MFR	MODEL NUMBER	SERIAL NUMBER	LAST CAL.	CAL DUE.
DC Block	Mini-Circuits	BLK-18-S+	1	01/02/2017	01/01/2018
Attenuator	Mini-Circuit	BW-S10W2+	2	01/02/2017	01/01/2018
Splitter	Agilent	11636B	N/A	01/02/2017	01/01/2018

Note: The measurement was taken place with the long duration of the time, and additional equipment list as shown above indicate those equipment of which has been subject to undertake the calibration in intermediate period of time of the measurement.

Unless otherwise stated the results shown in this test report refer only to the sample(s) tested and such sample(s) are retained for 90 days only.

除非另有說明，此報告結果僅對測試之樣品負責，同時此樣品僅保留90天。本報告未經本公司書面許可，不可部份複製。

This document is issued by the Company subject to its General Conditions of Service printed overleaf, available on request or accessible at www.sgs.com/terms_and_conditions.htm and, for electronic format documents, subject to Terms and Conditions for Electronic Documents at www.sgs.com/terms_e-document.htm. Attention is drawn to the limitation of liability, indemnification and jurisdiction issues defined therein. Any holder of this document is advised that information contained hereon reflects the Company's findings at the time of its intervention only and within the limits of Client's instructions, if any. The Company's sole responsibility is to its Client and this document does not exonerate parties to a transaction from exercising all their rights and obligations under the transaction documents. This document cannot be reproduced except in full, without prior written approval of the Company. Any unauthorized alteration, forgery or falsification of the content or appearance of this document is unlawful and offenders may be prosecuted to the fullest extent of the law.

SGS Taiwan Ltd.

No.134,WuKungRoad,NewTaipeiIndustrialPark,WukuDistrict,NewTaipeiCity,Taiwan24803/新北市五股區新北產業園區五工路 134 號

台灣檢驗科技股份有限公司

t (886-2) 2299-3279

f (886-2) 2298-0488

www.tw.sgs.com

Member of SGS Group

12.3 Test Set-up

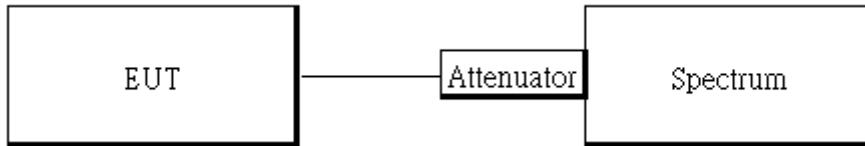

12.4 Measurement Procedure

1. Place the EUT on the table and set it in transmitting mode.
2. The testing follows FCC Public Notice DA 00-705 Measurement Guidelines.
3. Remove the antenna from the EUT and then connect a low loss RF cable from the antenna port to the spectrum analyzer.
4. Set spectrum analyzer Start=2400MHz, Stop = 2483.5MHz, Sweep = auto.
5. Set the spectrum analyzer as RBW=430 kHz, VBW=1.5MHz., Detector = Peak
6. Max hold, view and count how many channel in the band.

12.5 Measurement Result

Tabular Data of Total Channel Number

	<i>Channel Number</i>	<i>Limit</i>
2.4 GHz – 2.441GHz	40	>15
2.441 GHz – 2.4835GHz	39	
2.4GHz ~2.4835GHz	(40+39) = 79	

Unless otherwise stated the results shown in this test report refer only to the sample(s) tested and such sample(s) are retained for 90 days only.

除非另有說明，此報告結果僅對測試之樣品負責，同時此樣品僅保留90天。本報告未經本公司書面許可，不可部份複製。

This document is issued by the Company subject to its General Conditions of Service printed overleaf, available on request or accessible at www.sgs.com/terms_and_conditions.htm and, for electronic format documents, subject to Terms and Conditions for Electronic Documents at www.sgs.com/terms_e-document.htm. Attention is drawn to the limitation of liability, indemnification and jurisdiction issues defined therein. Any holder of this document is advised that information contained hereon reflects the Company's findings at the time of its intervention only and within the limits of Client's instructions, if any. The Company's sole responsibility is to its Client and this document does not exonerate parties to a transaction from exercising all their rights and obligations under the transaction documents. This document cannot be reproduced except in full, without prior written approval of the Company. Any unauthorized alteration, forgery or falsification of the content or appearance of this document is unlawful and offenders may be prosecuted to the fullest extent of the law.

SGS Taiwan Ltd.

No.134,WuKungRoad,NewTaipeiIndustrialPark,WukuDistrict,NewTaipeiCity,Taiwan24803/新北市五股區新北產業園區五工路 134 號

台灣檢驗科技股份有限公司

t (886-2) 2299-3279

f (886-2) 2298-0488

www.tw.sgs.com

Member of SGS Group

Channel Number

2.4 GHz – 2.441GHz

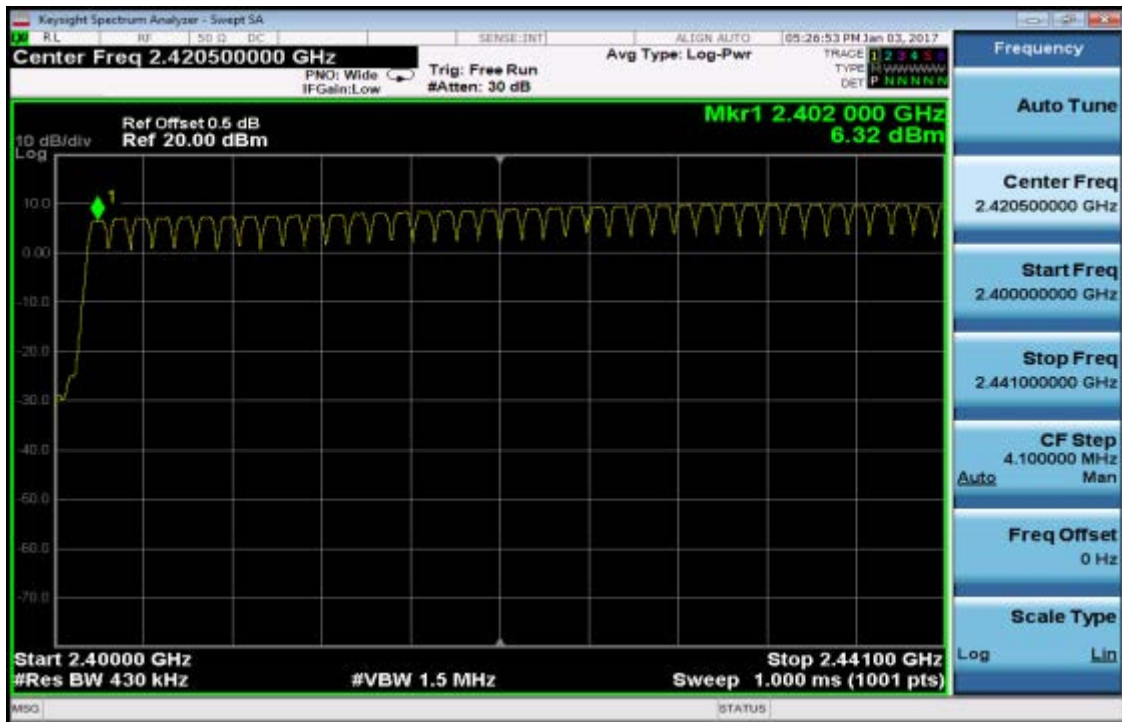

2.441 GHz – 2.4835GHz

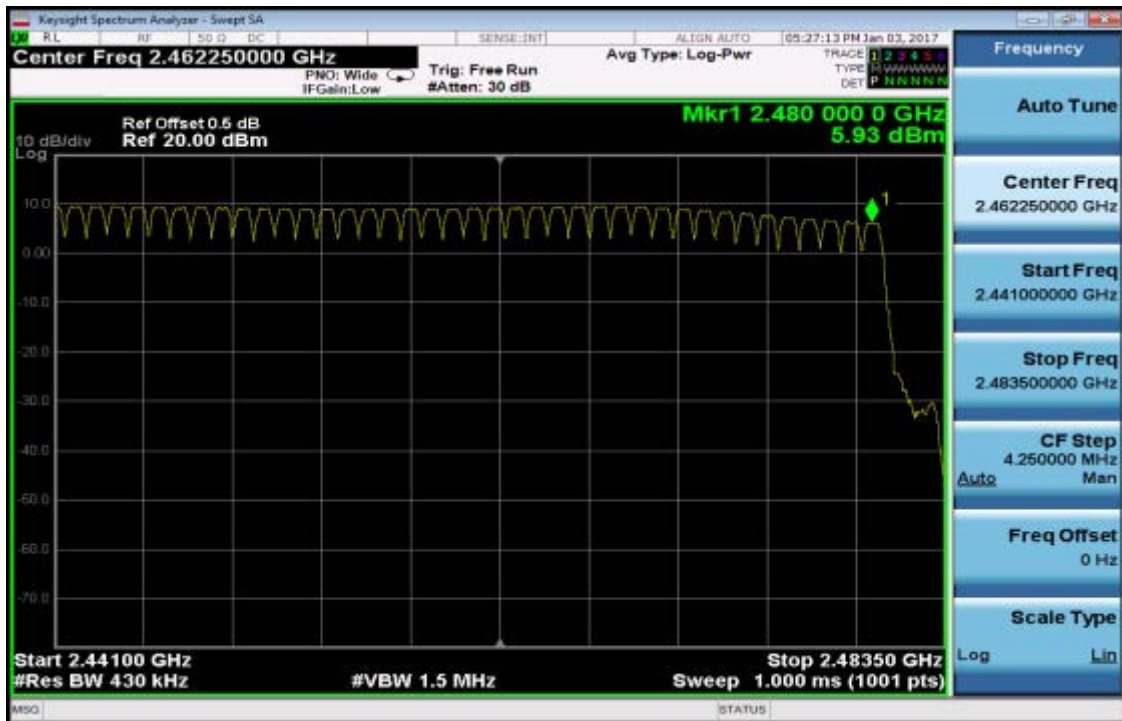

Unless otherwise stated the results shown in this test report refer only to the sample(s) tested and such sample(s) are retained for 90 days only.

除非另有說明，此報告結果僅對測試之樣品負責，同時此樣品僅保留90天。本報告未經本公司書面許可，不可部份複製。

This document is issued by the Company subject to its General Conditions of Service printed overleaf, available on request or accessible at www.sgs.com/terms_and_conditions.htm and, for electronic format documents, subject to Terms and Conditions for Electronic Documents at www.sgs.com/terms_e-document.htm. Attention is drawn to the limitation of liability, indemnification and jurisdiction issues defined therein. Any holder of this document is advised that information contained hereon reflects the Company's findings at the time of its intervention only and within the limits of Client's instructions, if any. The Company's sole responsibility is to its Client and this document does not exonerate parties to a transaction from exercising all their rights and obligations under the transaction documents. This document cannot be reproduced except in full, without prior written approval of the Company. Any unauthorized alteration, forgery or falsification of the content or appearance of this document is unlawful and offenders may be prosecuted to the fullest extent of the law.

SGS Taiwan Ltd.

No. 134, WuKungRoad, NewTaipeiIndustrialPark, WukuDistrict, NewTaipeiCity, Taiwan24803/新北市五股區新北產業園區五工路 134 號

台灣檢驗科技股份有限公司

t (886-2) 2299-3279

f (886-2) 2298-0488

www.tw.sgs.com

Member of SGS Group

13 TIME OF OCCUPANCY (DWELL TIME)

13.1 Standard Applicable

Frequency hopping systems operating in the 2400MHz-2483.5MHz. The average time of occupancy on any frequency shall not greater than 0.4 s within period of 0.4 seconds multiplied by the number of hopping channel employed.

13.2 Measurement Equipment Used

Conducted Emission Test Site					
EQUIPMENT TYPE	MFR	MODEL NUMBER	SERIAL NUMBER	LAST CAL.	CAL DUE.
EXA Spectrum Analyzer	Agilent	N9030A	MY53120760	02/26/2016	02/25/2017
DC Block	Mini-Circuits	BLK-18-S+	1	01/02/2016	01/01/2017
Attenuator	Mini-Circuit	BW-S10W2+	2	01/02/2016	01/01/2017
Splitter	Agilent	11636B	N/A	01/02/2016	01/01/2017

EQUIPMENT TYPE	MFR	MODEL NUMBER	SERIAL NUMBER	LAST CAL.	CAL DUE.
DC Block	Mini-Circuits	BLK-18-S+	1	01/02/2017	01/01/2018
Attenuator	Mini-Circuit	BW-S10W2+	2	01/02/2017	01/01/2018
Splitter	Agilent	11636B	N/A	01/02/2017	01/01/2018

Note: The measurement was taken place with the long duration of the time, and additional equipment list as shown above indicate those equipment of which has been subject to undertake the calibration in intermediate period of time of the measurement.

13.3 Test Set-up

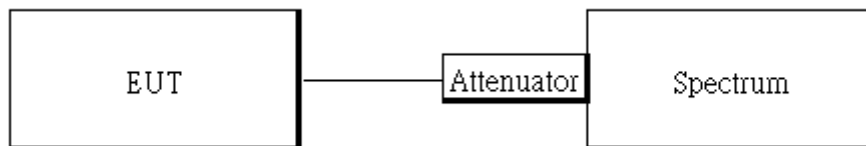

Unless otherwise stated the results shown in this test report refer only to the sample(s) tested and such sample(s) are retained for 90 days only.

除非另有說明，此報告結果僅對測試之樣品負責，同時此樣品僅保留90天。本報告未經本公司書面許可，不可部份複製。

This document is issued by the Company subject to its General Conditions of Service printed overleaf, available on request or accessible at www.sgs.com/terms_and_conditions.htm and, for electronic format documents, subject to Terms and Conditions for Electronic Documents at www.sgs.com/terms_e-document.htm. Attention is drawn to the limitation of liability, indemnification and jurisdiction issues defined therein. Any holder of this document is advised that information contained hereon reflects the Company's findings at the time of its intervention only and within the limits of Client's instructions, if any. The Company's sole responsibility is to its Client and this document does not exonerate parties to a transaction from exercising all their rights and obligations under the transaction documents. This document cannot be reproduced except in full, without prior written approval of the Company. Any unauthorized alteration, forgery or falsification of the content or appearance of this document is unlawful and offenders may be prosecuted to the fullest extent of the law.

SGS Taiwan Ltd.

No.134,WuKungRoad,NewTaipeiIndustrialPark,WukuDistrict,NewTaipeiCity,Taiwan24803/新北市五股區新北產業園區五工路 134 號

台灣檢驗科技股份有限公司

t (886-2) 2299-3279

f (886-2) 2298-0488

www.tw.sgs.com

Member of SGS Group

13.4 Measurement Procedure

1. Place the EUT on the table and set it in transmitting mode.
2. The testing follows FCC Public Notice DA 00-705 Measurement Guidelines.
3. Remove the antenna from the EUT and then connect a low loss RF cable from the antenna port to the spectrum analyzer.
4. Set center frequency of spectrum analyzer = operating frequency.
5. Set the spectrum analyzer as RBW, VBW=1MHz, 3MHz, Span = 0Hz , Detector = Peak, Adjust Sweep = 2~8ms.
6. Repeat above procedures until all frequency of the interest measured were complete.

Formula Deduced: time occupancy of one time slot X Hopping rate / total slot in one channel / total channel that hops X period of working channels.

Where, standard hopping rate is 1600 hops/s, slot in one channel for DH1, DH3, and DH5 is 2, 4, and 6, respectively.

DH1 consists of single time slot of the uplink, and one slot of the downlink Total Slot: 2

DH3 consists of three time slot of the uplink, and one slot of the downlink. Total Slot: 4

DH5 consists of five time slot of the uplink, and one slot of the downlink. Total Slot: 6

In AFH mode, hopping rate is 800 hop/s with 6 slots in 20 hopping channels with channel hopping rate (800 / 6 / 20) in Occupancy Time Limit (0.4 * 20) (S), Hop Over Occupancy Time comes to (800 / 6 / 20) * (0.4 * 20) = 53.33

Note: the result of the complete test default channel at 1Mbps is recorded on the test report, 2Mbps, and 3Mbps only records the measurement result at middle channel that reveals no much deviation.

Unless otherwise stated the results shown in this test report refer only to the sample(s) tested and such sample(s) are retained for 90 days only.

除非另有說明，此報告結果僅對測試之樣品負責，同時此樣品僅保留90天。本報告未經本公司書面許可，不可部份複製。

This document is issued by the Company subject to its General Conditions of Service printed overleaf, available on request or accessible at www.sgs.com/terms_and_conditions.htm and, for electronic format documents, subject to Terms and Conditions for Electronic Documents at www.sgs.com/terms_e-document.htm. Attention is drawn to the limitation of liability, indemnification and jurisdiction issues defined therein. Any holder of this document is advised that information contained hereon reflects the Company's findings at the time of its intervention only and within the limits of Client's instructions, if any. The Company's sole responsibility is to its Client and this document does not exonerate parties to a transaction from exercising all their rights and obligations under the transaction documents. This document cannot be reproduced except in full, without prior written approval of the Company. Any unauthorized alteration, forgery or falsification of the content or appearance of this document is unlawful and offenders may be prosecuted to the fullest extent of the law.

SGS Taiwan Ltd.

No.134,WuKungRoad,NewTaipeiIndustrialPark,WukuDistrict,NewTaipeiCity,Taiwan24803/新北市五股區新北產業園區五工路 134 號

台灣檢驗科技股份有限公司

t (886-2) 2299-3279

f (886-2) 2298-0488

www.tw.sgs.com

Member of SGS Group

13.5 Tabular Result of the Measurement

GFSK (1Mbps)

Channel	PACKET TYPE	Measurement Result (ms)	Limit (ms)
0	DH1	118.40	400ms
	DH3	259.20	400ms
	DH5	306.13	400ms
39	DH1	115.20	400ms
	DH3	259.20	400ms
	DH5	306.13	400ms
78	DH1	115.20	400ms
	DH3	259.20	400ms
	DH5	306.13	400ms

$\pi/4$ DQPSK (2Mbps)

Channel	PACKET TYPE	Measurement Result (ms)	Limit (ms)
39	DH1	121.60	400ms
	DH3	196.80	400ms
	DH5	307.20	400ms

8-DPSK (3Mbps)

Channel	PACKET TYPE	Measurement Result (ms)	Limit (ms)
39	DH1	121.60	400ms
	DH3	260.80	400ms
	DH5	307.20	400ms

Unless otherwise stated the results shown in this test report refer only to the sample(s) tested and such sample(s) are retained for 90 days only.

除非另有說明，此報告結果僅對測試之樣品負責，同時此樣品僅保留90天。本報告未經本公司書面許可，不可部份複製。

This document is issued by the Company subject to its General Conditions of Service printed overleaf, available on request or accessible at www.sgs.com/terms_and_conditions.htm and, for electronic format documents, subject to Terms and Conditions for Electronic Documents at www.sgs.com/terms_e-document.htm. Attention is drawn to the limitation of liability, indemnification and jurisdiction issues defined therein. Any holder of this document is advised that information contained hereon reflects the Company's findings at the time of its intervention only and within the limits of Client's instructions, if any. The Company's sole responsibility is to its Client and this document does not exonerate parties to a transaction from exercising all their rights and obligations under the transaction documents. This document cannot be reproduced except in full, without prior written approval of the Company. Any unauthorized alteration, forgery or falsification of the content or appearance of this document is unlawful and offenders may be prosecuted to the fullest extent of the law.

SGS Taiwan Ltd.

No.134,WuKungRoad,NewTaipeiIndustrialPark,WukuDistrict,NewTaipeiCity,Taiwan24803/新北市五股區新北產業園區五工路 134 號

台灣檢驗科技股份有限公司

t (886-2) 2299-3279

f (886-2) 2298-0488

www.tw.sgs.com

Member of SGS Group

A period time = 0.4 (s) * 79 = 31.6 (s)

GFSK (1Mbps):

CH Low	DH1 time slot =	0.370 *	(1600/2/79) *	31.6 =	118.40 (ms)
	DH3 time slot =	1.620 *	(1600/4/79) *	31.6 =	259.20 (ms)
	DH5 time slot =	2.870 *	(1600/6/79) *	31.6 =	306.13 (ms)
CH Mid	DH1 time slot =	0.360 *	(1600/2/79) *	31.6 =	115.20 (ms)
	DH3 time slot =	1.620 *	(1600/4/79) *	31.6 =	259.20 (ms)
	DH5 time slot =	2.870 *	(1600/6/79) *	31.6 =	306.13 (ms)
CH High	DH1 time slot =	0.360 *	(1600/2/79) *	31.6 =	115.20 (ms)
	DH3 time slot =	1.620 *	(1600/4/79) *	31.6 =	259.20 (ms)
	DH5 time slot =	2.870 *	(1600/6/79) *	31.6 =	306.13 (ms)

$\pi/4$ -DQPSK (2Mbps):

CH Mid	2DH1 time slot=	0.380 *	(1600/2/79) *	31.6 =	121.60 (ms)
	2DH3 time slot=	1.230 *	(1600/4/79) *	31.6 =	196.80 (ms)
	2DH5 time slot=	2.880 *	(1600/6/79) *	31.6 =	307.20 (ms)

8-DPSK (3Mbps):

CH Mid	3DH1 time slot=	0.380 *	(1600/2/79) *	31.6 =	121.60 (ms)
	3DH3 time slot=	1.630 *	(1600/4/79) *	31.6 =	260.80 (ms)
	3DH5 time slot=	2.880 *	(1600/6/79) *	31.6 =	307.20 (ms)

Unless otherwise stated the results shown in this test report refer only to the sample(s) tested and such sample(s) are retained for 90 days only.

除非另有說明，此報告結果僅對測試之樣品負責，同時此樣品僅保留90天。本報告未經本公司書面許可，不可部份複製。

This document is issued by the Company subject to its General Conditions of Service printed overleaf, available on request or accessible at www.sgs.com/terms_and_conditions.htm and, for electronic format documents, subject to Terms and Conditions for Electronic Documents at www.sgs.com/terms_e-document.htm. Attention is drawn to the limitation of liability, indemnification and jurisdiction issues defined therein. Any holder of this document is advised that information contained hereon reflects the Company's findings at the time of its intervention only and within the limits of Client's instructions, if any. The Company's sole responsibility is to its Client and this document does not exonerate parties to a transaction from exercising all their rights and obligations under the transaction documents. This document cannot be reproduced except in full, without prior written approval of the Company. Any unauthorized alteration, forgery or falsification of the content or appearance of this document is unlawful and offenders may be prosecuted to the fullest extent of the law.

SGS Taiwan Ltd.

No.134,WuKungRoad,NewTaipeiIndustrialPark,WukuDistrict,NewTaipeiCity,Taiwan24803/新北市五股區新北產業園區五工路 134 號

台灣檢驗科技股份有限公司

t (886-2) 2299-3279

f (886-2) 2298-0488

www.tw.sgs.com

Member of SGS Group

GFSK (1Mbps) for AFH Mode			
Hopping Channel Number	PACKET TYPE	Measurement Result (ms)	Limit (ms)
20	DH5	153.07	400ms
π/4 DQPSK (2Mbps) for Mode			
Hopping Channel Number	PACKET TYPE	Measurement Result (ms)	Limit (ms)
20	DH5	153.60	400ms
8-DPSK (3Mbps) for AFH Mode			
Hopping Channel Number	PACKET TYPE	Measurement Result (ms)	Limit (ms)
20	DH5	153.60	400ms

GFSK (1Mbps):

$$DH5 \text{ time sl} = 2.870 \text{ (ms)} * (800/6/20) * 8 = 153.07 \text{ (ms)}$$

π/4 -DQPSK (2Mbps)

$$2DH5 \text{ time} := 2.880 \text{ (ms)} * (800/6/20) * 8 = 153.60 \text{ (ms)}$$

8-DPSK (3Mbps):

$$3DH5 \text{ time} := 2.880 \text{ (ms)} * (800/6/20) * 8 = 153.60 \text{ (ms)}$$

13.6 Measurement Result

Note: Refer to next page for plots.

Unless otherwise stated the results shown in this test report refer only to the sample(s) tested and such sample(s) are retained for 90 days only.

除非另有說明，此報告結果僅對測試之樣品負責，同時此樣品僅保留90天。本報告未經本公司書面許可，不可部份複製。

This document is issued by the Company subject to its General Conditions of Service printed overleaf, available on request or accessible at www.sgs.com/terms_and_conditions.htm and, for electronic format documents, subject to Terms and Conditions for Electronic Documents at www.sgs.com/terms_e-document.htm. Attention is drawn to the limitation of liability, indemnification and jurisdiction issues defined therein. Any holder of this document is advised that information contained hereon reflects the Company's findings at the time of its intervention only and within the limits of Client's instructions, if any. The Company's sole responsibility is to its Client and this document does not exonerate parties to a transaction from exercising all their rights and obligations under the transaction documents. This document cannot be reproduced except in full, without prior written approval of the Company. Any unauthorized alteration, forgery or falsification of the content or appearance of this document is unlawful and offenders may be prosecuted to the fullest extent of the law.

CH-Low
DH1

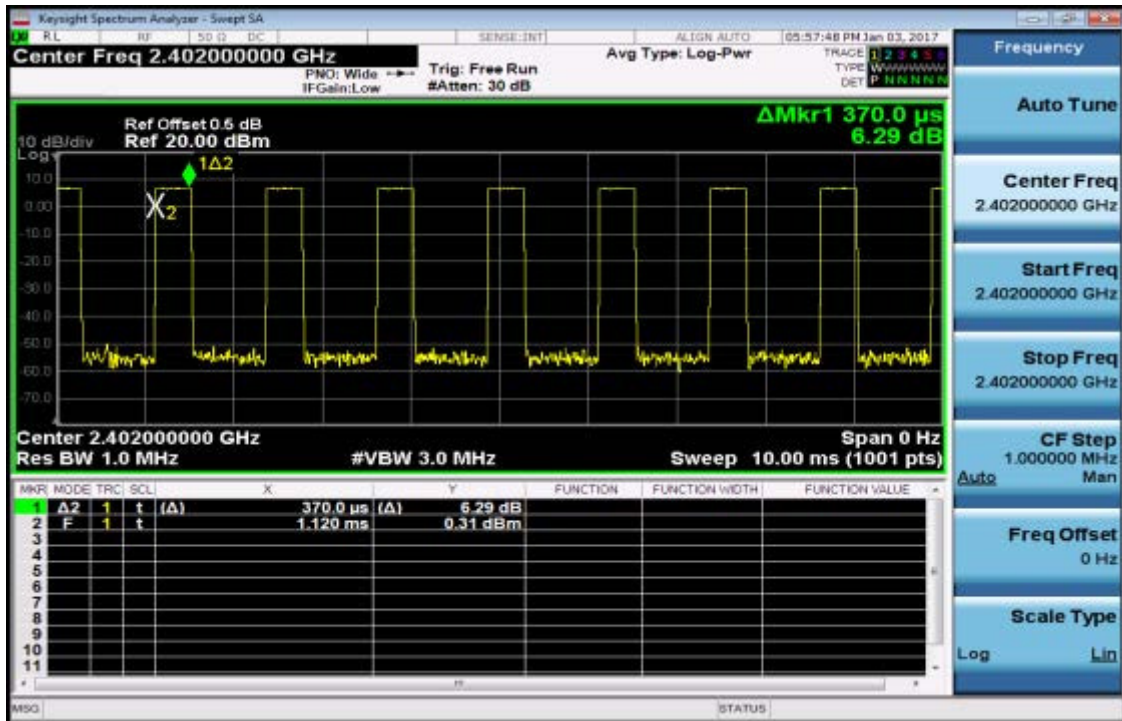

DH3

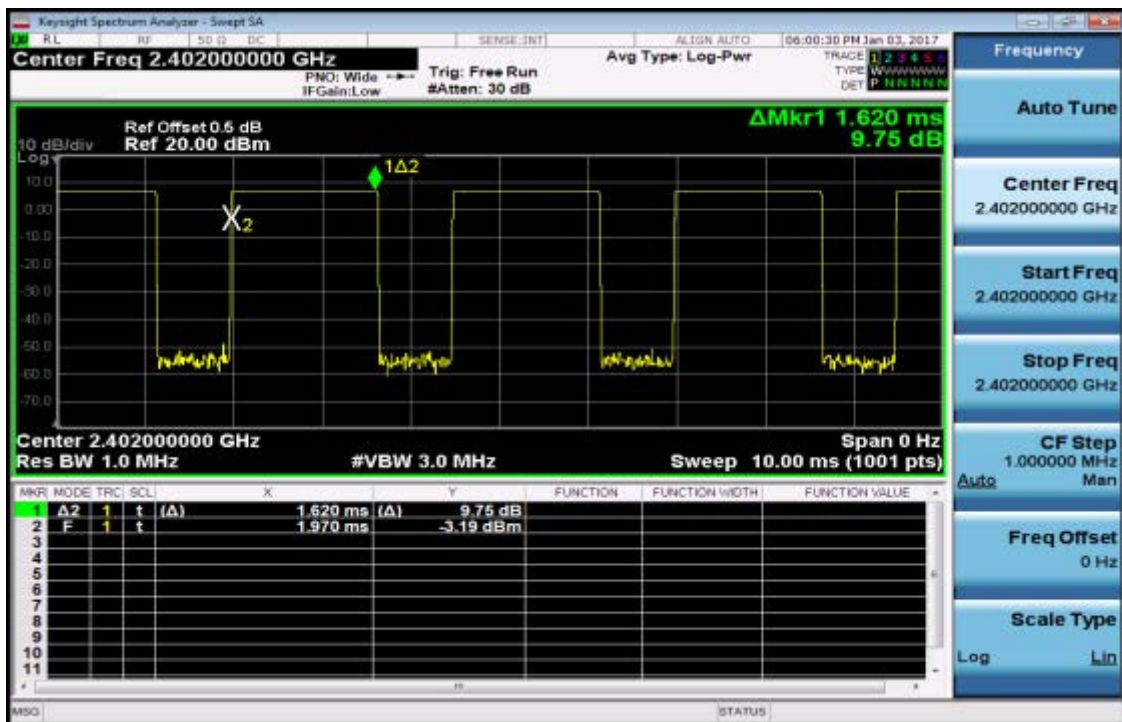

Unless otherwise stated the results shown in this test report refer only to the sample(s) tested and such sample(s) are retained for 90 days only.

除非另有說明，此報告結果僅對測試之樣品負責，同時此樣品僅保留90天。本報告未經本公司書面許可，不可部份複製。

This document is issued by the Company subject to its General Conditions of Service printed overleaf, available on request or accessible at www.sgs.com/terms_and_conditions.htm and, for electronic format documents, subject to Terms and Conditions for Electronic Documents at www.sgs.com/terms_e-document.htm. Attention is drawn to the limitation of liability, indemnification and jurisdiction issues defined therein. Any holder of this document is advised that information contained hereon reflects the Company's findings at the time of its intervention only and within the limits of Client's instructions, if any. The Company's sole responsibility is to its Client and this document does not exonerate parties to a transaction from exercising all their rights and obligations under the transaction documents. This document cannot be reproduced except in full, without prior written approval of the Company. Any unauthorized alteration, forgery or falsification of the content or appearance of this document is unlawful and offenders may be prosecuted to the fullest extent of the law.

SGS Taiwan Ltd.

No. 134, WuKung Road, New Taipei Industrial Park, Wuku District, New Taipei City, Taiwan 24803 / 新北市五股區新北產業園區五工路 134 號

台灣檢驗科技股份有限公司

t (886-2) 2299-3279

f (886-2) 2298-0488

www.tw.sgs.com

Member of SGS Group

DH5

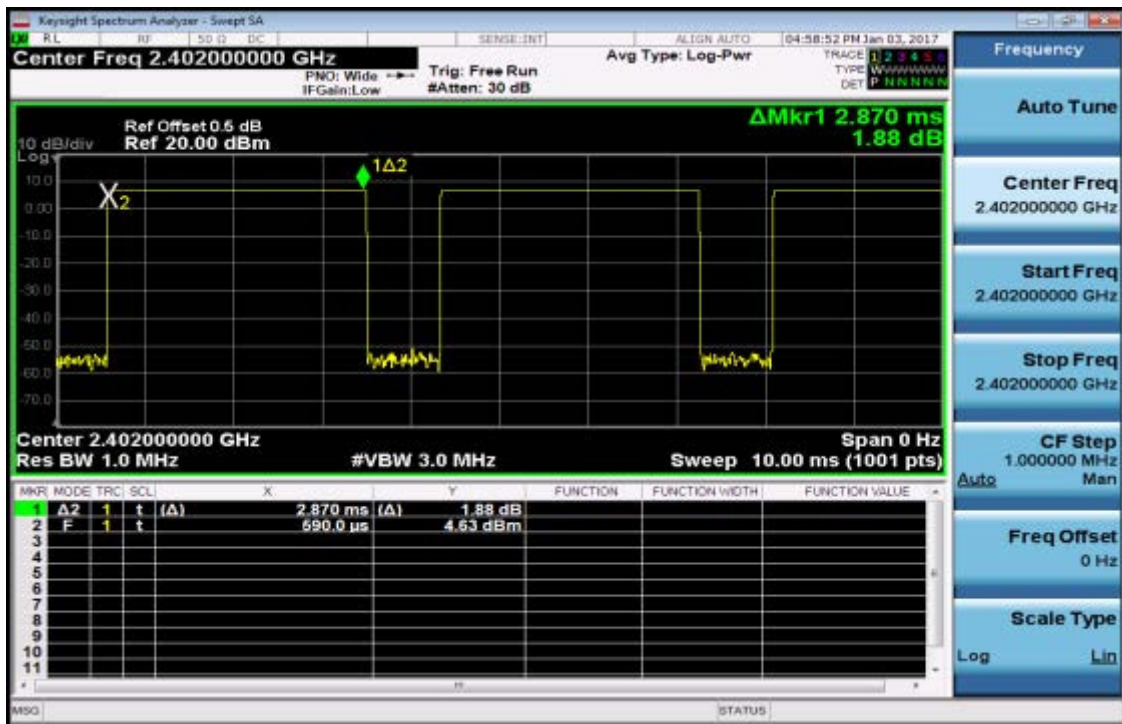

CH-Mid
DH1

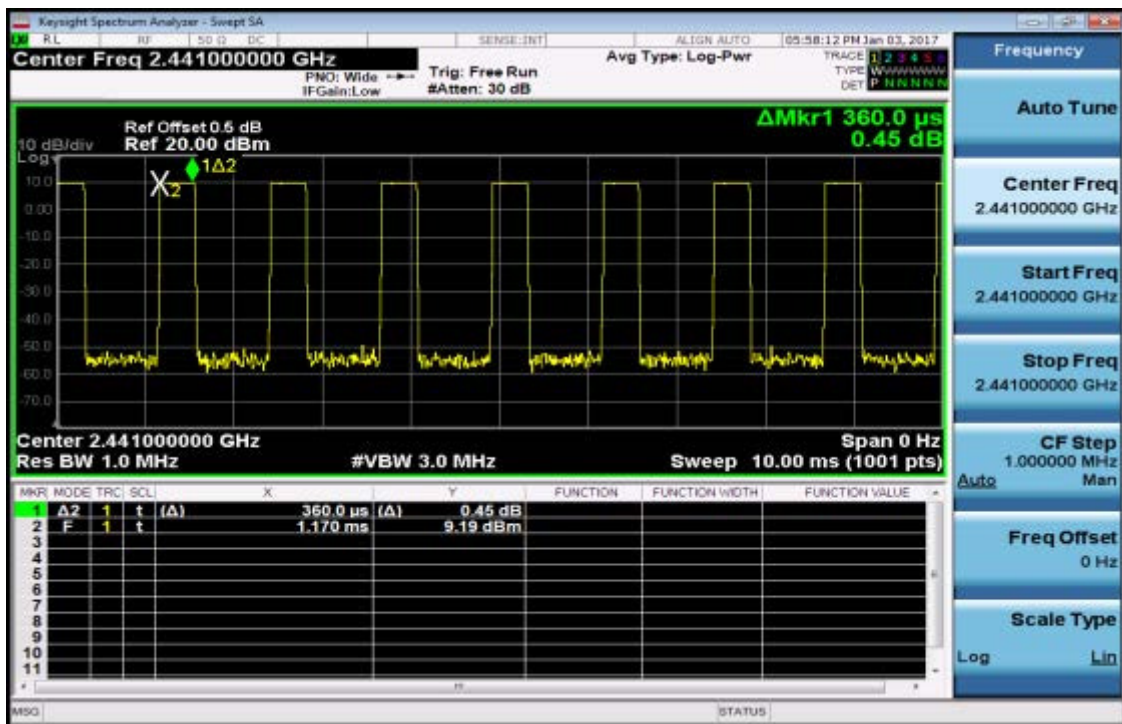

Unless otherwise stated the results shown in this test report refer only to the sample(s) tested and such sample(s) are retained for 90 days only.

除非另有說明，此報告結果僅對測試之樣品負責，同時此樣品僅保留90天。本報告未經本公司書面許可，不可部份複製。

This document is issued by the Company subject to its General Conditions of Service printed overleaf, available on request or accessible at www.sgs.com/terms_and_conditions.htm and, for electronic format documents, subject to Terms and Conditions for Electronic Documents at www.sgs.com/terms_e-document.htm. Attention is drawn to the limitation of liability, indemnification and jurisdiction issues defined therein. Any holder of this document is advised that information contained hereon reflects the Company's findings at the time of its intervention only and within the limits of Client's instructions, if any. The Company's sole responsibility is to its Client and this document does not exonerate parties to a transaction from exercising all their rights and obligations under the transaction documents. This document cannot be reproduced except in full, without prior written approval of the Company. Any unauthorized alteration, forgery or falsification of the content or appearance of this document is unlawful and offenders may be prosecuted to the fullest extent of the law.

SGS Taiwan Ltd.

No. 134, WuKungRoad, NewTaipeiIndustrialPark, WukuDistrict, NewTaipeiCity, Taiwan24803/新北市五股區新北產業園區五工路 134 號

台灣檢驗科技股份有限公司

t (886-2) 2299-3279

f (886-2) 2298-0488

www.tw.sgs.com

Member of SGS Group

DH3

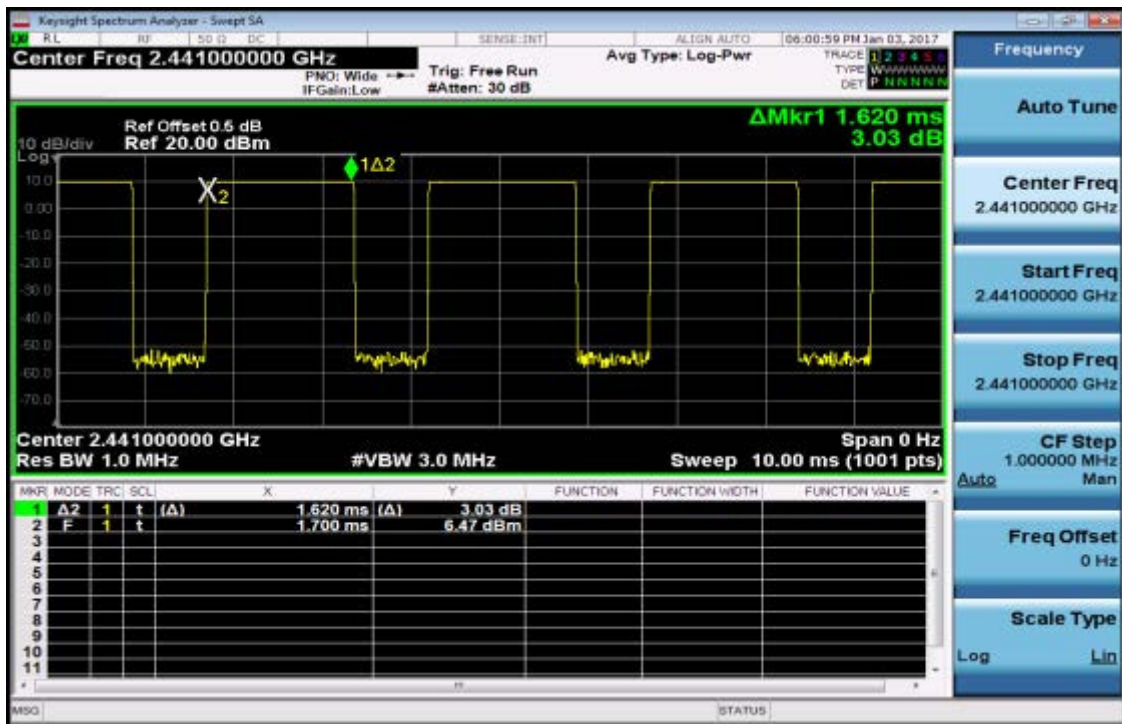

DH5

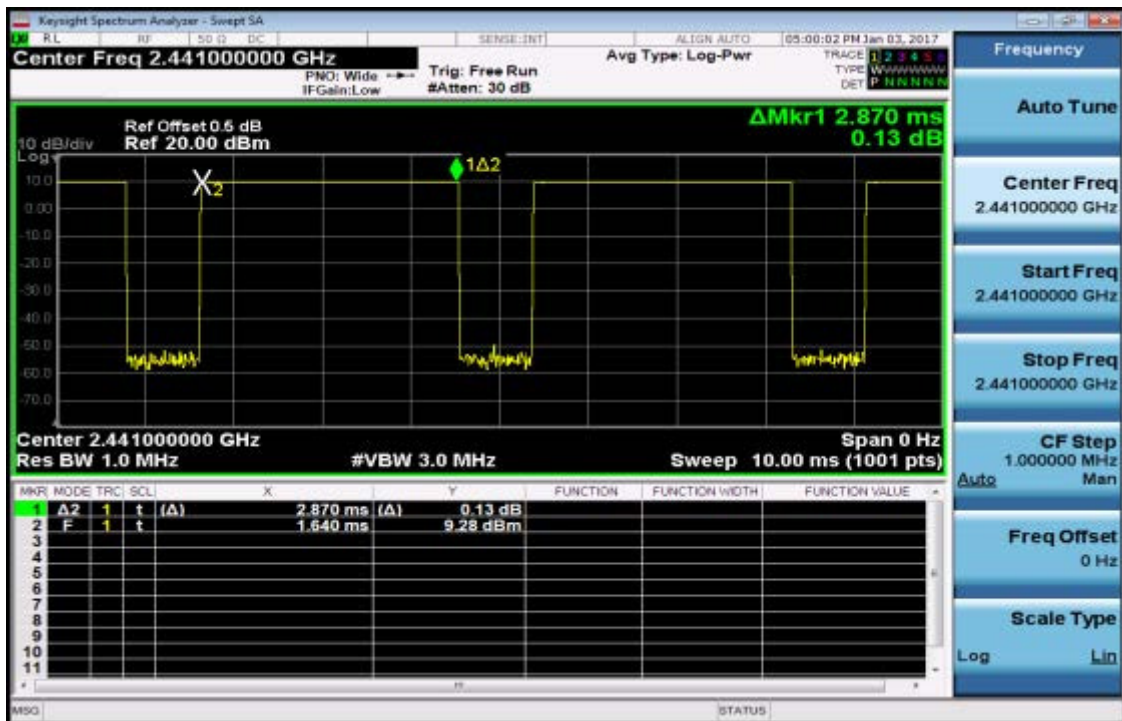

Unless otherwise stated the results shown in this test report refer only to the sample(s) tested and such sample(s) are retained for 90 days only.

除非另有說明，此報告結果僅對測試之樣品負責，同時此樣品僅保留90天。本報告未經本公司書面許可，不可部份複製。

This document is issued by the Company subject to its General Conditions of Service printed overleaf, available on request or accessible at www.sgs.com/terms_and_conditions.htm and, for electronic format documents, subject to Terms and Conditions for Electronic Documents at www.sgs.com/terms_e-document.htm. Attention is drawn to the limitation of liability, indemnification and jurisdiction issues defined therein. Any holder of this document is advised that information contained hereon reflects the Company's findings at the time of its intervention only and within the limits of Client's instructions, if any. The Company's sole responsibility is to its Client and this document does not exonerate parties to a transaction from exercising all their rights and obligations under the transaction documents. This document cannot be reproduced except in full, without prior written approval of the Company. Any unauthorized alteration, forgery or falsification of the content or appearance of this document is unlawful and offenders may be prosecuted to the fullest extent of the law.

SGS Taiwan Ltd.

No. 134, WuKungRoad, NewTaipeiIndustrialPark, WukuDistrict, NewTaipeiCity, Taiwan24803/新北市五股區新北產業園區五工路 134 號

台灣檢驗科技股份有限公司

t (886-2) 2299-3279

f (886-2) 2298-0488

www.tw.sgs.com

Member of SGS Group

CH-High DH1

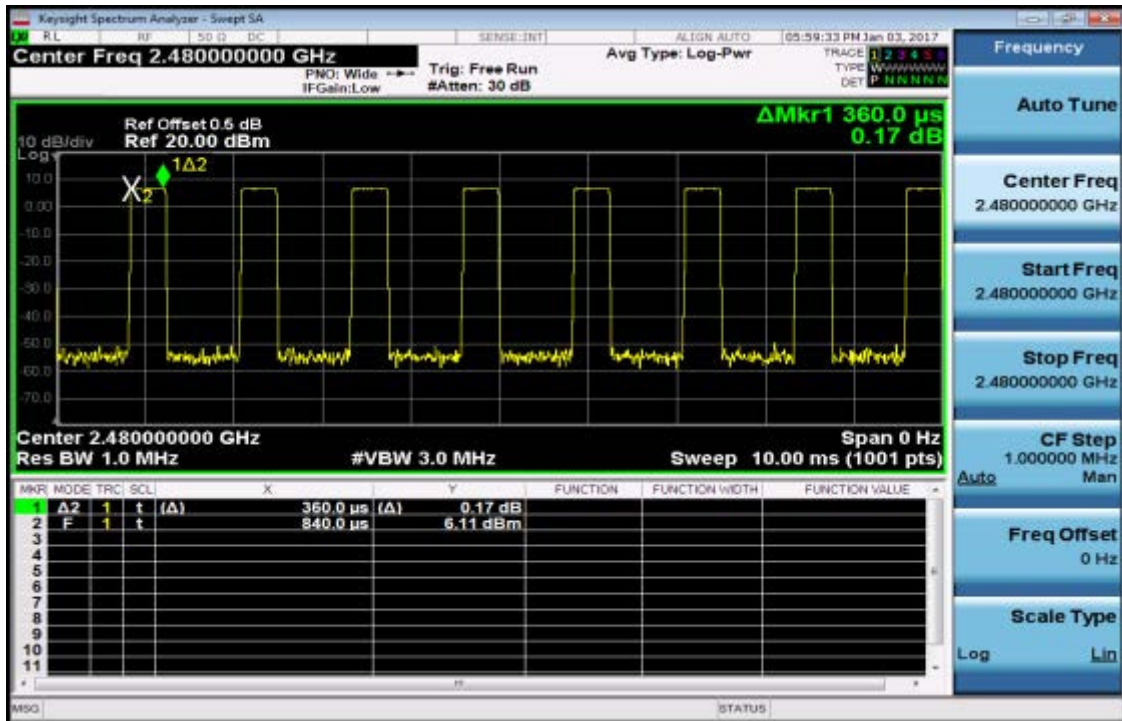

DH3

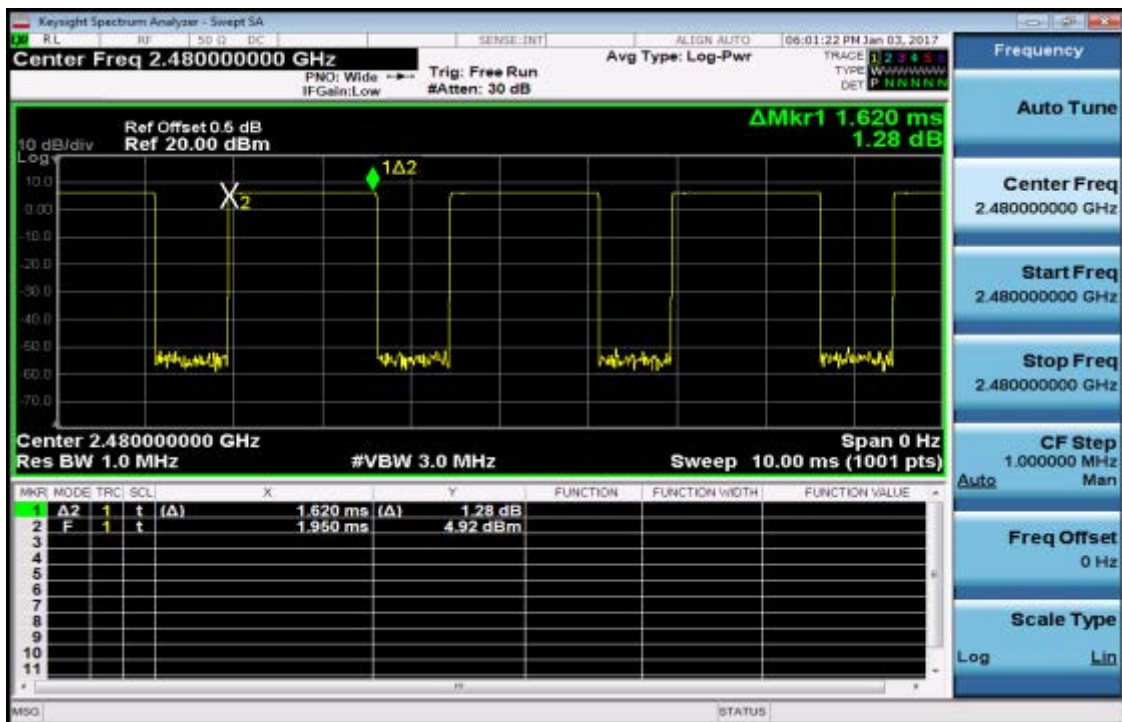

Unless otherwise stated the results shown in this test report refer only to the sample(s) tested and such sample(s) are retained for 90 days only.

除非另有說明，此報告結果僅對測試之樣品負責，同時此樣品僅保留90天。本報告未經本公司書面許可，不可部份複製。

This document is issued by the Company subject to its General Conditions of Service printed overleaf, available on request or accessible at www.sgs.com/terms_and_conditions.htm and, for electronic format documents, subject to Terms and Conditions for Electronic Documents at www.sgs.com/terms_e-document.htm. Attention is drawn to the limitation of liability, indemnification and jurisdiction issues defined therein. Any holder of this document is advised that information contained hereon reflects the Company's findings at the time of its intervention only and within the limits of Client's instructions, if any. The Company's sole responsibility is to its Client and this document does not exonerate parties to a transaction from exercising all their rights and obligations under the transaction documents. This document cannot be reproduced except in full, without prior written approval of the Company. Any unauthorized alteration, forgery or falsification of the content or appearance of this document is unlawful and offenders may be prosecuted to the fullest extent of the law.

SGS Taiwan Ltd.

No. 134, WuKung Road, New Taipei Industrial Park, Wuku District, New Taipei City, Taiwan 24803 / 新北市五股區新北產業園區五工路 134 號

台灣檢驗科技股份有限公司

t (886-2) 2299-3279

f (886-2) 2298-0488

www.tw.sgs.com

Member of SGS Group

DH5

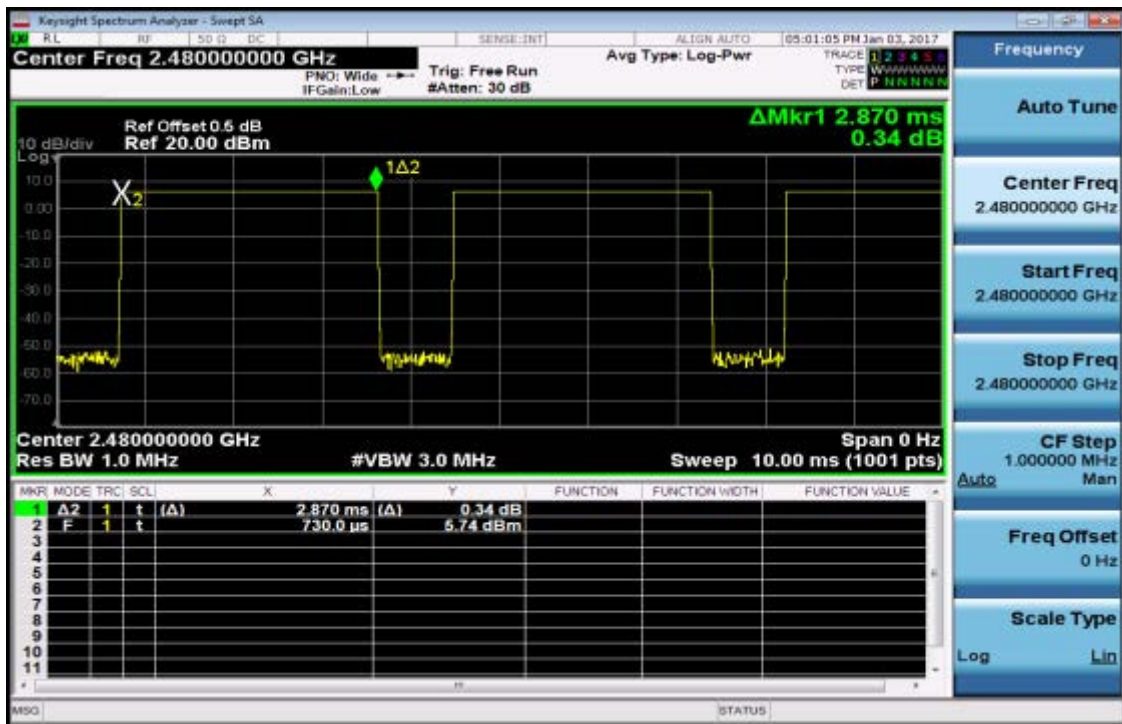

Unless otherwise stated the results shown in this test report refer only to the sample(s) tested and such sample(s) are retained for 90 days only.

除非另有說明，此報告結果僅對測試之樣品負責，同時此樣品僅保留90天。本報告未經本公司書面許可，不可部份複製。

This document is issued by the Company subject to its General Conditions of Service printed overleaf, available on request or accessible at www.sgs.com/terms_and_conditions.htm and, for electronic format documents, subject to Terms and Conditions for Electronic Documents at www.sgs.com/terms_e-document.htm. Attention is drawn to the limitation of liability, indemnification and jurisdiction issues defined therein. Any holder of this document is advised that information contained hereon reflects the Company's findings at the time of its intervention only and within the limits of Client's instructions, if any. The Company's sole responsibility is to its Client and this document does not exonerate parties to a transaction from exercising all their rights and obligations under the transaction documents. This document cannot be reproduced except in full, without prior written approval of the Company. Any unauthorized alteration, forgery or falsification of the content or appearance of this document is unlawful and offenders may be prosecuted to the fullest extent of the law.

SGS Taiwan Ltd.

No. 134, WuKungRoad, NewTaipeiIndustrialPark, WukuDistrict, NewTaipeiCity, Taiwan24803/新北市五股區新北產業園區五工路 134 號

台灣檢驗科技股份有限公司

t (886-2) 2299-3279

f (886-2) 2298-0488

www.tw.sgs.com

Member of SGS Group

CH-Mid
2DH1

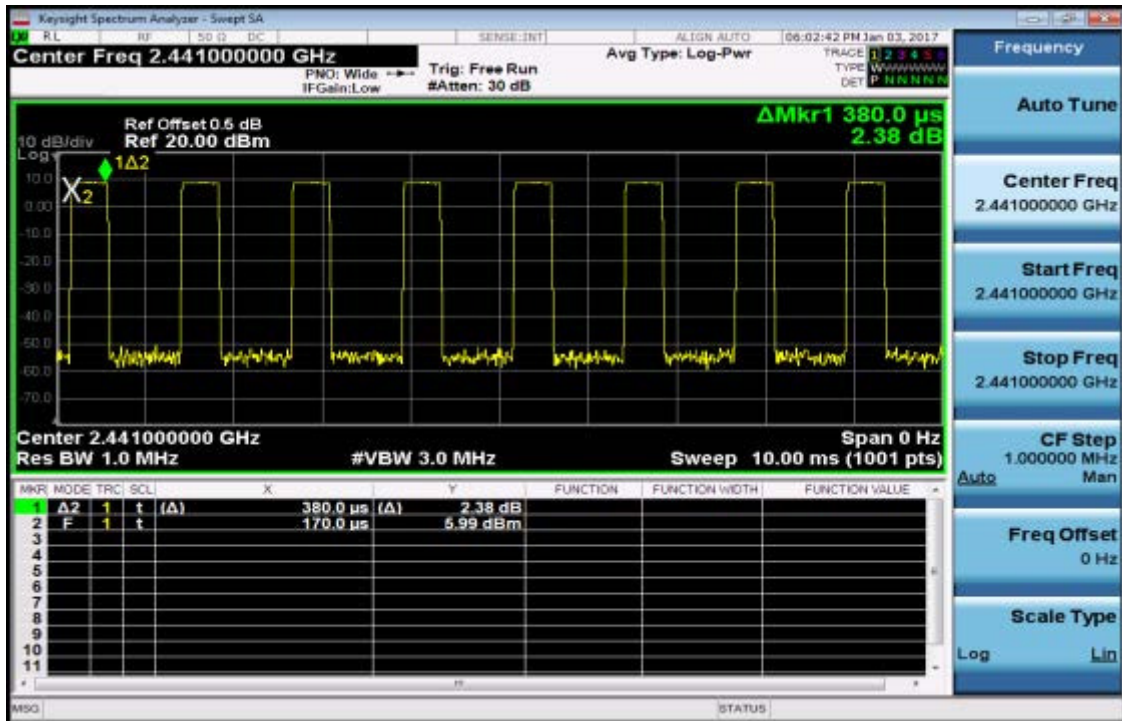

2DH3

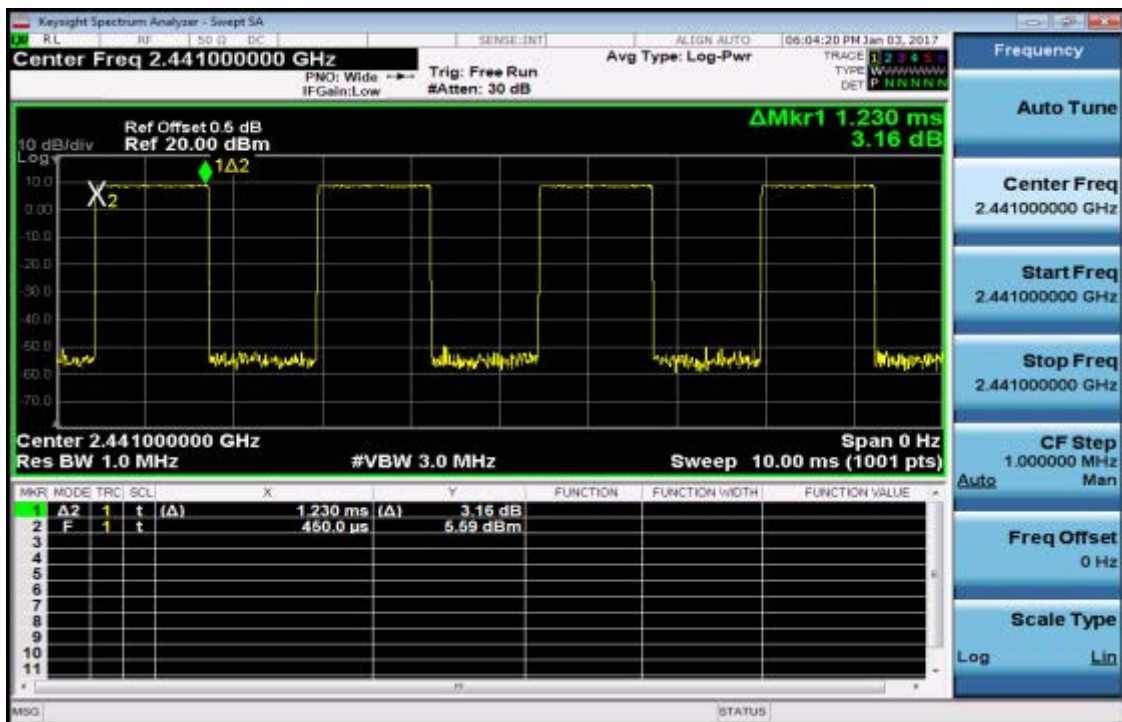

Unless otherwise stated the results shown in this test report refer only to the sample(s) tested and such sample(s) are retained for 90 days only.

除非另有說明，此報告結果僅對測試之樣品負責，同時此樣品僅保留90天。本報告未經本公司書面許可，不可部份複製。

This document is issued by the Company subject to its General Conditions of Service printed overleaf, available on request or accessible at www.sgs.com/terms_and_conditions.htm and, for electronic format documents, subject to Terms and Conditions for Electronic Documents at www.sgs.com/terms_e-document.htm. Attention is drawn to the limitation of liability, indemnification and jurisdiction issues defined therein. Any holder of this document is advised that information contained hereon reflects the Company's findings at the time of its intervention only and within the limits of Client's instructions, if any. The Company's sole responsibility is to its Client and this document does not exonerate parties to a transaction from exercising all their rights and obligations under the transaction documents. This document cannot be reproduced except in full, without prior written approval of the Company. Any unauthorized alteration, forgery or falsification of the content or appearance of this document is unlawful and offenders may be prosecuted to the fullest extent of the law.

SGS Taiwan Ltd.

No. 134, WuKungRoad, NewTaipeiIndustrialPark, WukuDistrict, NewTaipeiCity, Taiwan24803/新北市五股區新北產業園區五工路 134 號

台灣檢驗科技股份有限公司

t (886-2) 2299-3279

f (886-2) 2298-0488

www.tw.sgs.com

Member of SGS Group

2DH5

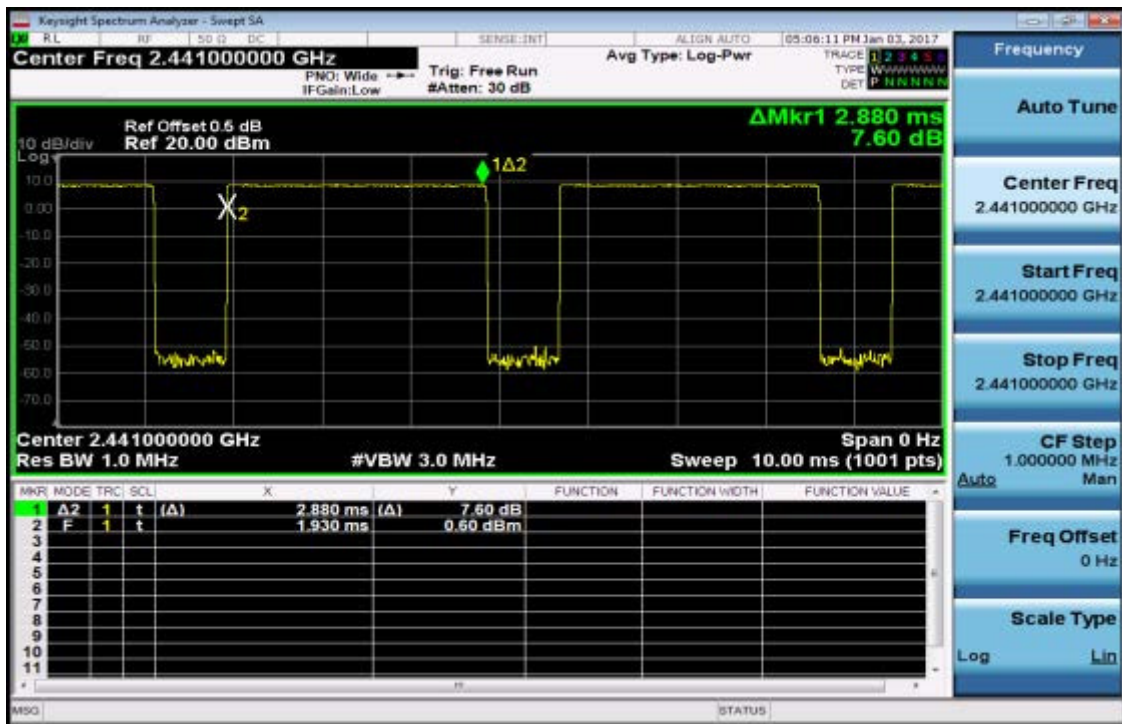

Unless otherwise stated the results shown in this test report refer only to the sample(s) tested and such sample(s) are retained for 90 days only.

除非另有說明，此報告結果僅對測試之樣品負責，同時此樣品僅保留90天。本報告未經本公司書面許可，不可部份複製。

This document is issued by the Company subject to its General Conditions of Service printed overleaf, available on request or accessible at www.sgs.com/terms_and_conditions.htm and, for electronic format documents, subject to Terms and Conditions for Electronic Documents at www.sgs.com/terms_e-document.htm. Attention is drawn to the limitation of liability, indemnification and jurisdiction issues defined therein. Any holder of this document is advised that information contained hereon reflects the Company's findings at the time of its intervention only and within the limits of Client's instructions, if any. The Company's sole responsibility is to its Client and this document does not exonerate parties to a transaction from exercising all their rights and obligations under the transaction documents. This document cannot be reproduced except in full, without prior written approval of the Company. Any unauthorized alteration, forgery or falsification of the content or appearance of this document is unlawful and offenders may be prosecuted to the fullest extent of the law.

SGS Taiwan Ltd.

No. 134, WuKungRoad, NewTaipeiIndustrialPark, WukuDistrict, NewTaipeiCity, Taiwan24803/新北市五股區新北產業園區五工路 134 號

台灣檢驗科技股份有限公司

t (886-2) 2299-3279

f (886-2) 2298-0488

www.tw.sgs.com

Member of SGS Group

CH-Mid
3DH1

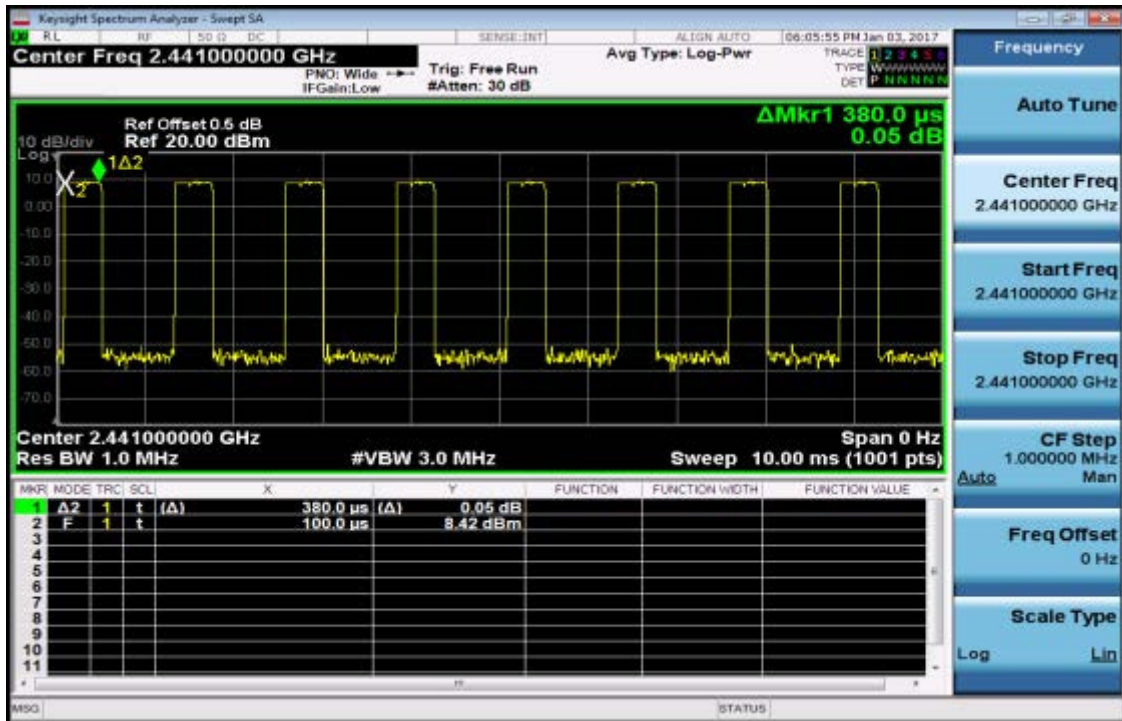

3DH3

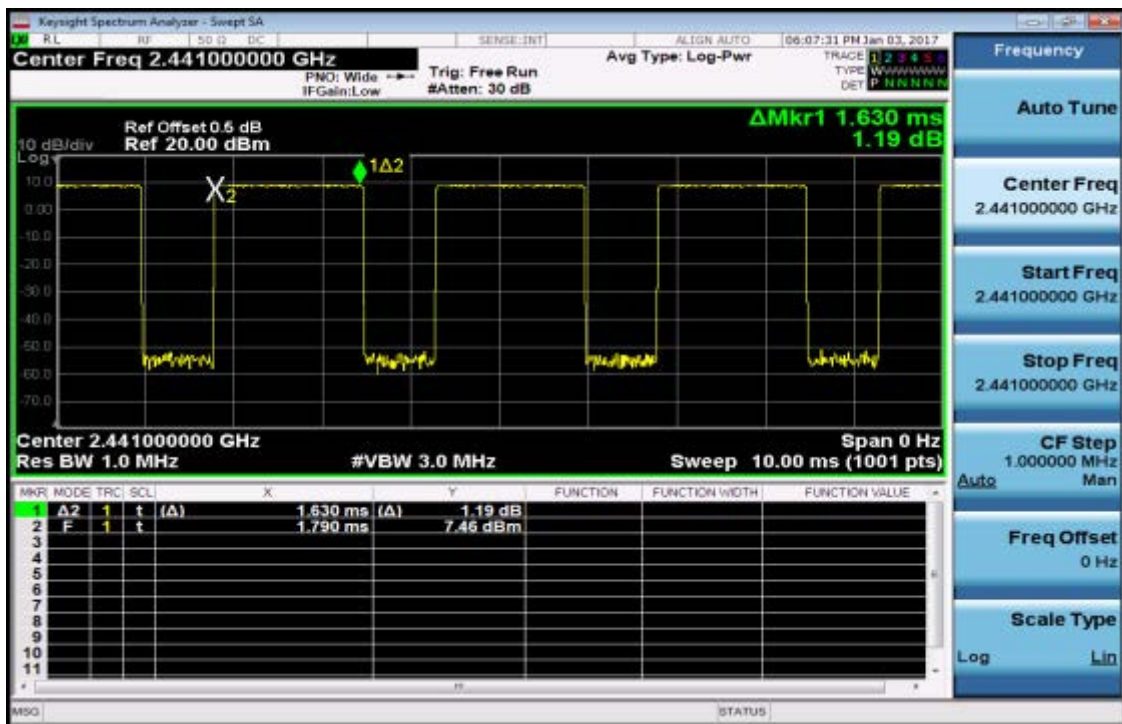

Unless otherwise stated the results shown in this test report refer only to the sample(s) tested and such sample(s) are retained for 90 days only.

除非另有說明，此報告結果僅對測試之樣品負責，同時此樣品僅保留90天。本報告未經本公司書面許可，不可部份複製。

This document is issued by the Company subject to its General Conditions of Service printed overleaf, available on request or accessible at www.sgs.com/terms_and_conditions.htm and, for electronic format documents, subject to Terms and Conditions for Electronic Documents at www.sgs.com/terms_e-document.htm. Attention is drawn to the limitation of liability, indemnification and jurisdiction issues defined therein. Any holder of this document is advised that information contained hereon reflects the Company's findings at the time of its intervention only and within the limits of Client's instructions, if any. The Company's sole responsibility is to its Client and this document does not exonerate parties to a transaction from exercising all their rights and obligations under the transaction documents. This document cannot be reproduced except in full, without prior written approval of the Company. Any unauthorized alteration, forgery or falsification of the content or appearance of this document is unlawful and offenders may be prosecuted to the fullest extent of the law.

SGS Taiwan Ltd.

No. 134, WuKungRoad, NewTaipeiIndustrialPark, WukuDistrict, NewTaipeiCity, Taiwan24803/新北市五股區新北產業園區五工路 134 號

台灣檢驗科技股份有限公司

t (886-2) 2299-3279

f (886-2) 2298-0488

www.tw.sgs.com

Member of SGS Group

3DH5

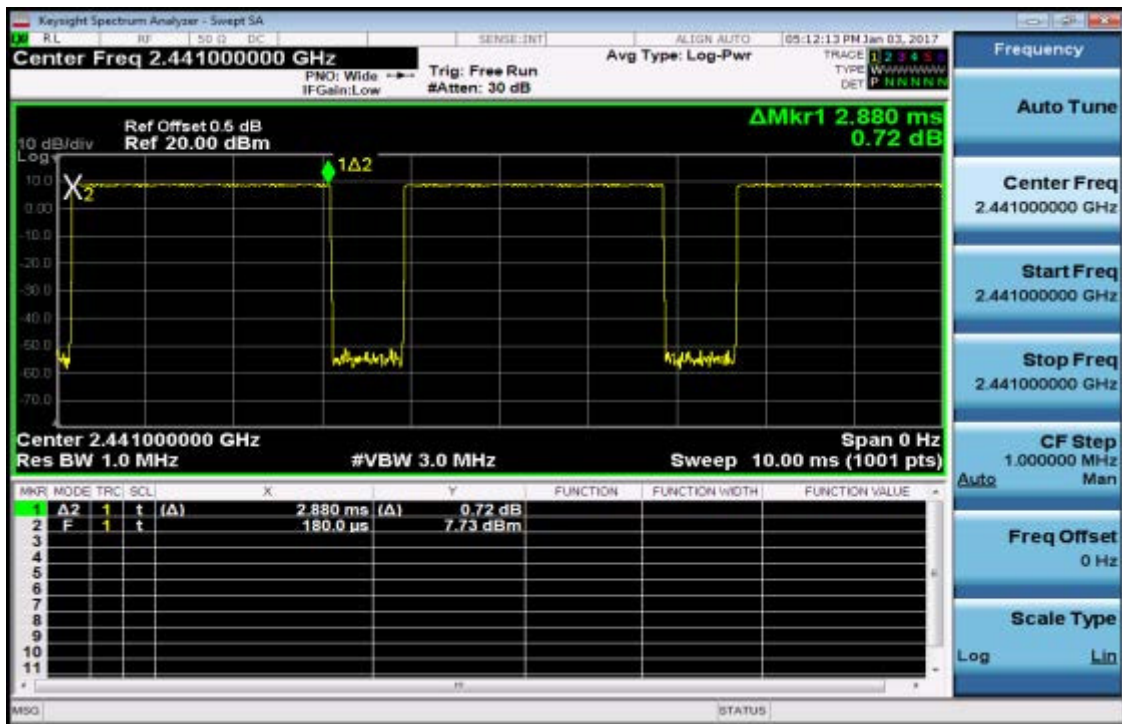

Unless otherwise stated the results shown in this test report refer only to the sample(s) tested and such sample(s) are retained for 90 days only.

除非另有說明，此報告結果僅對測試之樣品負責，同時此樣品僅保留90天。本報告未經本公司書面許可，不可部份複製。

This document is issued by the Company subject to its General Conditions of Service printed overleaf, available on request or accessible at www.sgs.com/terms_and_conditions.htm and, for electronic format documents, subject to Terms and Conditions for Electronic Documents at www.sgs.com/terms_e-document.htm. Attention is drawn to the limitation of liability, indemnification and jurisdiction issues defined therein. Any holder of this document is advised that information contained hereon reflects the Company's findings at the time of its intervention only and within the limits of Client's instructions, if any. The Company's sole responsibility is to its Client and this document does not exonerate parties to a transaction from exercising all their rights and obligations under the transaction documents. This document cannot be reproduced except in full, without prior written approval of the Company. Any unauthorized alteration, forgery or falsification of the content or appearance of this document is unlawful and offenders may be prosecuted to the fullest extent of the law.

SGS Taiwan Ltd.

No. 134, WuKungRoad, NewTaipeiIndustrialPark, WukuDistrict, NewTaipeiCity, Taiwan24803/新北市五股區新北產業園區五工路 134 號

台灣檢驗科技股份有限公司

t (886-2) 2299-3279

f (886-2) 2298-0488

www.tw.sgs.com

Member of SGS Group

14 ANTENNA REQUIREMENT

14.1 Standard Applicable

For intentional device, according to §15.203, an intentional radiator shall be designed to ensure that no antenna other than furnished by the responsible party shall be used with the device.

If the transmitting antenna is greater than 6dBi, the power shall be reduced by the same level in dB comparing to gain minus 6dBi.

According to RSS-GEN 8.3

The applicant for equipment certification, as per RSP-100, must provide a list of all antenna types that may be used with the licence-exempt transmitter, indicating the maximum permissible antenna gain (in dBi) and the required impedance for each antenna.

Licence-exempt transmitters that have received equipment certification may operate with different types of antennas. However, it is not permissible to exceed the maximum equivalent isotropically radiated power (e.i.r.p.) limits specified in the applicable standard (RSS) for the licence-exempt apparatus.

Testing shall be performed using the highest gain antenna of each combination of licence-exempt transmitter and antenna type, with the transmitter output power set at the maximum level.⁹ When a measurement at the antenna connector is used to determine RF output power, the effective gain of the device's antenna shall be stated, based on a measurement or on data from the antenna manufacturer.

14.2 Antenna Connected Construction

An embedded-in antenna design is used.

The antenna is designed as permanently attached and no consideration of replacement. Please see EUT photo and antenna spec. for details.

The antenna gain is less than 6dBi. Therefore, it is not necessary to reduce maximum output power limit.

~ *End of Report* ~

Unless otherwise stated the results shown in this test report refer only to the sample(s) tested and such sample(s) are retained for 90 days only.

除非另有說明，此報告結果僅對測試之樣品負責，同時此樣品僅保留90天。本報告未經本公司書面許可，不可部份複製。

This document is issued by the Company subject to its General Conditions of Service printed overleaf, available on request or accessible at www.sgs.com/terms_and_conditions.htm and, for electronic format documents, subject to Terms and Conditions for Electronic Documents at www.sgs.com/terms_e-document.htm. Attention is drawn to the limitation of liability, indemnification and jurisdiction issues defined therein. Any holder of this document is advised that information contained hereon reflects the Company's findings at the time of its intervention only and within the limits of Client's instructions, if any. The Company's sole responsibility is to its Client and this document does not exonerate parties to a transaction from exercising all their rights and obligations under the transaction documents. This document cannot be reproduced except in full, without prior written approval of the Company. Any unauthorized alteration, forgery or falsification of the content or appearance of this document is unlawful and offenders may be prosecuted to the fullest extent of the law.

SGS Taiwan Ltd.

台灣檢驗科技股份有限公司

No.134,WuKungRoad,NewTaipeiIndustrialPark,WukuDistrict,NewTaipeiCity,Taiwan24803/新北市五股區新北產業園區五工路 134 號

t (886-2) 2299-3279

f (886-2) 2298-0488

www.tw.sgs.com

Member of SGS Group