



RF TEST REPORT

Applicant Nokia ShangHai Bell Co., Ltd.
FCC ID 2ADZRG1425GB
Product Nokia ONT
Brand NOKIA
Model G-1425G-B
Report No. R2111A0997-R3V1
Issue Date June 6, 2022

TA Technology (Shanghai) Co., Ltd. tested the above equipment in accordance with the requirements in **FCC CFR47 Part 15E (2021)**. The test results show that the equipment tested is capable of demonstrating compliance with the requirements as documented in this report.

Prepared by: Peng Tao

Approved by: Kai Xu

TA Technology (Shanghai) Co., Ltd.

No.145, Jintang Rd, Tangzhen Industry Park, Pudong Shanghai, China

TEL: +86-021-50791141/2/3

FAX: +86-021-50791141/2/3-8000

TABLE OF CONTENT

1. Test Laboratory	5
1.1. Notes of the test report.....	5
1.2. Test facility	5
1.3. Testing Location.....	5
2. General Description of Equipment under Test.....	6
2.1. Applicant and Manufacturer Information.....	6
2.2. General information.....	6
3. Applied Standards	11
4. DFS Technical Requirements and Radar Test Waveforms	12
4.1. DFS Overview	12
4.2. DFS Detection Thresholds	13
4.3. RADAR TEST WAVEFORMS	14
4.4. Test set-ups	17
5. Test Case	19
5.1. DFS Detection Thresholds	19
5.2. U-NII Detection Bandwidth	20
5.3. Channel Availability Check Time	22
5.4. Channel Move Time, Channel Closing Transmission Time and Non-Occupancy Period ...	25
5.5. Statistical Performance Check	27
6. Test Results	29
6.1. DFS Detection Thresholds	29
6.2. U-NII Detection Bandwidth	36
6.3. Channel Availability Check Time	42
6.4. Channel Move Time, Channel Closing Transmission Time and Non-Occupancy Period.....	45
6.4. Statistical Performance Check	48
7. Main Test Instruments	86
ANNEX A: The EUT Appearance	87
ANNEX B: Test Setup Photos	88



Version	Revision description	Issue Date
Rev.0	Initial issue of report.	April 27, 2022
Rev.1	Update information.	June 6, 2022

Note: This revised report (Report No. R2111A0997-R3V1) supersedes and replaces the previously issued report (Report No. R2111A0997-R3). Please discard or destroy the previously issued report and dispose of it accordingly.



Summary of measurement results

Number	Test Case	Clause in FCC rules	Verdict
1	DFS Detection Threshold	15.407/KDB 905462 5.2	Pass
2	U-NII Detection Bandwidth	15.407/KDB 905462 7.8.1	Pass
3	Channel Availability Check Time	15.407/KDB 905462 7.8.2	Pass
4	Channel Move Time	15.407/KDB 905462 7.8.3	Pass
5	Channel Closing Transmission Time	15.407/KDB 905462 7.8.3	Pass
6	Non-Occupancy Period(NOP)	15.407/KDB 905462 7.8.3	Pass
7	Statistical Performance Check	15.407/KDB 905462 7.8.4	Pass

Date of Testing: January 29, 2022 and April 15, 2022

Date of Sample Received: December 11, 2021

Note: PASS: The EUT complies with the essential requirements in the standard.

FAIL: The EUT does not comply with the essential requirements in the standard.

All indications of Pass/Fail in this report are opinions expressed by TA Technology (Shanghai) Co., Ltd. based on interpretations and/or observations of test results. Measurement Uncertainties were not taken into account and are published for informational purposes only.



1. Test Laboratory

1.1. Notes of the test report

This report shall not be reproduced in full or partial, without the written approval of **TA technology (shanghai) co., Ltd.** The results documented in this report apply only to the tested sample, under the conditions and modes of operation as described herein. Measurement Uncertainties were not taken into account and are published for informational purposes only. This report is written to support regulatory compliance of the applicable standards stated above.

1.2. Test facility

FCC (Designation number: CN1179, Test Firm Registration Number: 446626)

TA Technology (Shanghai) Co., Ltd. has been listed on the US Federal Communications Commission list of test facilities recognized to perform electromagnetic emissions measurements.

A2LA (Certificate Number: 3857.01)

TA Technology (Shanghai) Co., Ltd. has been listed by American Association for Laboratory Accreditation to perform electromagnetic emission measurement.

1.3. Testing Location

Company: TA Technology (Shanghai) Co., Ltd.
Address: No.145, Jintang Rd, Tangzhen Industry Park, Pudong
City: Shanghai
Post code: 201201
Country: P. R. China
Contact: Xu Kai
Telephone: +86-021-50791141/2/3
Fax: +86-021-50791141/2/3-8000
Website: <http://www.ta-shanghai.com>
E-mail: xukai@ta-shanghai.com

2. General Description of Equipment under Test

2.1. Applicant and Manufacturer Information

Applicant	Nokia ShangHai Bell Co., Ltd.
Applicant address	No. 388, Ningqiao Rd. Pilot Free Trade Zone, Shanghai, China
Manufacturer 1	TAICANG T&W ELECTRONICS CO., LTD
Manufacturer address 1	89# Jiang Nan RD, Lu Du Town Taicang, Jiangsu, China
Manufacturer 2	Shenzhen Twowing Technologies CO., LTD
Manufacturer address 2	Nangang industrial building, No.3 Industrial Zone, Tangtou village, Shiyan Town, Bao'an District, Shenzhen City, Guangdong Province, China

2.2. General information

EUT Description	
Model	G-1425G-B
SN	ALCL00861234
Hardware Version	PEM1
Software Version	3FE49568HJJ131
Power Supply	AC adapter
Antenna Type	External Antenna
Operating Frequency Range(s)	U-NII-2A: 5250MHz-5350MHz U-NII-2C: 5470MHz-5725MHz with 5600MHz -5650MHz
Modulation Type	802.11a : OFDM 802.11n(HT20/HT40) : OFDM 802.11ac (VHT20/VHT40/VHT80):OFDM
Operating Mode	<input checked="" type="checkbox"/> Master <input type="checkbox"/> Client with radar detection <input type="checkbox"/> Client without radar detection
EUT Accessory	
Adapter 1	Manufacturer: Dongguan Shilong Fuhua Electronics Co.,Ltd Model: UES24WU-120200SPA
Adapter 2	Manufacturer: MOSO Power Supply Technology Co.,Ltd Model: MSA-C1500CS12.0-18J-US
Adapter 3	Manufacturer: SHENZHEN RUIDE ELECTRONICAL INDUSTRIAL Co.,Ltd Model: RD1201500-C55-153YG
Adapter 4	Manufacturer: Dongguan Shilong Fuhua Electronics Co.,Ltd Model: UES18LB-120150SPA



Adapter 5	Manufacturer: Dongguan Shilong Fuhua Electronics Co.,Ltd Model: UES18LU-120150SPA
Adapter 6	Manufacturer: SHENZHEN RUIDE ELECTRONICAL INDUSTRIAL Co.,Ltd Model: RD1201500-C55-153MG
Adapter 7	Manufacturer: ShenZhen SOY Technology Co.,Ltd Model: SOY-1200300-3014-II
Adapter 8	Manufacturer: ShenZhen Mass Power Electronic Limited Model: NBS40C120300M2
Adapter 9	Manufacturer: SHENZHEN RUIDE ELECTRONICAL INDUSTRIAL Co.,Ltd Model: RD1201500-C55-198MG
Adapter 10	Manufacturer: SHENZHEN RUIDE ELECTRONICAL INDUSTRIAL Co.,Ltd Model: RD1201500-C55-198OG
Adapter 11	Manufacturer: SHENZHEN RUIDE ELECTRONICAL INDUSTRIAL Co.,Ltd Model: RD1201500-C55-198YG
Adapter 12	Manufacturer: ShenZhen SOY Technology Co.,Ltd Model: SOY-1200150AR
Note: The EUT is sent from the applicant to TA and the information of the EUT is declared by the applicant.	

Configure		Configure 1	Configure 2
Item		G-1425G-B	G-1425G-B 2 nd
DDR	MPN	NT5CC256M16ER-EK	K4B4G1646E-BYMA
	Vendor	Nanya	Samsung
Flash	MPN	MT29F2G01ABAGDWB-IT: G	TC58CVG1S3HRAIJ
	Vendor	Micron	Kioxia
PCB	Vendor	JIANGMEN BENLIDA PRINTED CIRCUIT CO.,LTD	Mei Zhou Dingtai Circait Board Co.,Ltd
schematic		The same	
The difference between the two configurations is only the DDR, Flash and PCB. The report only records data for configuration 1.			

The detailed product change description please refers to the Difference Declaration Letter.

Information of Configuration:

ONT Mnemonic	Kit Code	EMA Code	Part Description
G-1425G-B	3FE49881XXXX (X can be A-Z or blank)	3FE49937XXXX (X can be A-Z or blank)	GPON ONT, 1xPOTS, 4xGE UNI, WIFI 5, 2x2 11n + 2x2 11ac

No.	Name	Model/Code No.	Edition	Serial No. or Quantity
1.1	EMA-G-1425G-B	3FE49937XXXX (X can be A-Z or blank)	PEM2	-
2.1	Power adapter	MSA-C1500CS12.0-18J-US	/	PEM
2.2	Power adapter	UES24WU-120200SPA	/	PEM
2.3	Power adapter	UES18LU-120150SPA	/	PEM
2.4	Power adapter	RD1201500-C55-153MG	/	PEM
2.5	Power adapter	RD1201500-C55-153YG	/	PEM
2.6	Power adapter	UES18LB-120150SPA	/	PEM
2.7	Power adapter	SOY-1200300-3014-II	/	PEM
2.8	Power adapter	NBS40C120300M2	/	PEM
2.9	Power adapter	RD1201500-C55-198MG	/	PEM
2.10	Power adapter	RD1201500-C55-198OG	/	PEM
2.11	Power adapter	RD1201500-C55-198YG	/	PEM
2.12	Power adapter	SOY-1200150AR	/	PEM

Auxiliary equipment details

No.	Name	Brand name	Model	NSB code	Valid Until
1	Test Center	Spirent	DE48E0	DC2228	2012.12.20
2	PC	Lenovo	T61	7661MC4L3KW965	No Cal. Required
3	OLT	Nokia	N.A	-	No Cal. Required
4	Phone	N.A	N.A	-	No Cal. Required

**Information of Ports**

No.	Port name	Number	Shielded or unshielded	Cable type (optic, twisted pair, etc.)	Max. Cable length
1	LAN1	/	Unshielded	CAT5E	/
2	LAN2	/	Unshielded	CAT5E	/
3	LAN3	/	Unshielded	CAT5E	/
4	LAN4	/	Unshielded	CAT5E	/
5	TEL1	/	Unshielded	twisted pair	/

**Wireless Technology and Frequency Range**

Wireless Technology		Bandwidth	Channel	Frequency
Wi-Fi	U-NII-2A	20 MHz	52	5260MHz
			56	5280MHz
			60	5300MHz
			64	5320MHz
		40 MHz	54	5270MHz
			62	5310MHz
		80 MHz	58	5290MHz
	U-NII-2C	20 MHz	100	5500MHz
			104	5520MHz
			108	5540MHz
			112	5560MHz
			116	5580MHz
			120	5600MHz
			124	5620MHz
			128	5640MHz
			132	5660MHz
			136	5680MHz
			140	5700MHz
			144	5720MHz
			40 MHz	102
		110		5550MHz
		118		5590MHz
		126		5630MHz
		134		5670MHz
		80 MHz	142	5710MHz
			106	5530MHz
			122	5610MHz
		138	5690MHz	
Does this device support TPC Function? <input checked="" type="checkbox"/> Yes <input type="checkbox"/> No				
Does this device support TDWR Band? <input checked="" type="checkbox"/> Yes <input type="checkbox"/> No				



3. Applied Standards

According to the specifications of the manufacturer, it must comply with the requirements of the following standards:

Test standards:

FCC CFR47 Part 15E (2021) Unlicensed National Information Infrastructure Devices

Reference standard:

FCC KDB 905462 D02 UNII DFS Compliance Procedures New Rules v02

4. DFS Technical Requirements and Radar Test Waveforms

4.1. DFS Overview

Table 1 Applicability of DFS Requirements Prior to Use of a Channel

Requirement	Operational Mode		
	Master	Client Without Radar Detection	Client With Radar Detection
Non-Occupancy Period	Yes	Not required	Yes
DFS Detection Threshold	Yes	Not required	Yes
Channel Availability Check Time	Yes	Not required	Not required
U-NII Detection Bandwidth	Yes	Not required	Yes

Table 2 Applicability of DFS requirements during normal operation

Requirement	Operational Mode	
	Master Device or Client with Radar Detection	Client Without Radar Detection
DFS Detection Threshold	Yes	Not required
Channel Closing Transmission Time	Yes	Yes
Channel Move Time	Yes	Yes
U-NII Detection Bandwidth	Yes	Not required
Additional requirements for devices with multiple bandwidth modes	Master Device or Client with Radar Detection	Client Without Radar Detection
U-NII Detection Bandwidth	All BW modes must be tested	Not required
Statistical Performance Check	All BW modes must be tested	Not required
Channel Closing Transmission Time	Test using widest BW mode available	Test using the widest BW mode available for the link
Channel Move Time	Test using widest BW mode available	Test using the widest BW mode available for the link
All other tests	Any single BW mode	Not required

Note: Frequencies selected for statistical performance check should include several frequencies within the radar detection bandwidth and frequencies near the edge of the radar detection bandwidth. For 802.11 devices it is suggested to select frequencies in each of the bonded 20 MHz channels and the channel center frequency.

4.2. DFS Detection Thresholds

Table 3 DFS Detection Thresholds for Master Devices and Client Devices with Radar Detection

Maximum Transmit Power	Value (See Notes 1, 2, and 3)
EIRP \geq 200 milliwatt	-64 dBm
EIRP < 200 milliwatt and power spectral density < 10 dBm/MHz	-62 dBm
EIRP < 200 milliwatt that do not meet the power spectral density requirement	-64 dBm

Note 1: This is the level at the input of the receiver assuming a 0 dBi receive antenna.

Note 2: Throughout these test procedures an additional 1 dB has been added to the amplitude of the test transmission waveforms to account for variations in measurement equipment. This will ensure that the test signal is at or above the detection threshold level to trigger a DFS response.

Note3: EIRP is based on the highest antenna gain. For MIMO devices refer to KDB Publication 662911 D01.

Table 4 DFS Response Requirement Values

Parameter	Value
Non-occupancy period	Minimum 30 minutes
Channel Availability Check Time	60 seconds
Channel Move Time	10 seconds See Note 1.
Channel Closing Transmission Time	200 milliseconds + an aggregate of 60 milliseconds over remaining 10 second period. See Notes 1 and 2.
U-NII Detection Bandwidth	Minimum 100% of the U-NII 99% transmission power bandwidth. See Note 3.

Note 1: Channel Move Time and the Channel Closing Transmission Time should be performed with Radar Type 0. The measurement timing begins at the end of the Radar Type 0 burst.

Note 2: The Channel Closing Transmission Time is comprised of 200 milliseconds starting at the beginning of the Channel Move Time plus any additional intermittent control signals required to facilitate a Channel move (an aggregate of 60 milliseconds) during the remainder of the 10 second period. The aggregate duration of control signals will not count quiet periods in between transmissions.

Note 3: During the U-NII Detection Bandwidth detection test, radar type 0 should be used. For each frequency step the minimum percentage of detection is 90 percent. Measurements are performed with no data traffic

4.3. RADAR TEST WAVEFORMS

Table 5 Short Pulse Radar Test Waveforms

Radar Type	Pulse Width (μsec)	PRI (μsec)	Number of Pulses	Minimum Percentage of Successful Detection	Minimum Number of Trials
0	1	1428	18	See Note 1	See Note 1
1	1	Test A: 15 unique PRI values randomly selected from the list of 23 PRI values in Table 5a	Roundup	60%	30
		Test B: 15 unique PRI values randomly selected within the range of 518-3066 μsec, with a minimum increment of 1 μsec, excluding PRI values selected in Test A			
2	1-5	150-230	23-29	60%	30
3	6-10	200-500	16-18	60%	30
4	11-20	200-500	12-16	60%	30
Aggregate (Radar Types 1-4)				80%	120
<p>Note 1: Short Pulse Radar Type 0 should be used for the detection bandwidth test, channel move time, and channel closing time tests.</p>					

**Table 5a Pulse Repetition Intervals Values for Test A**

Pulse Repetition Frequency Number	Pulse Repetition Frequency (Pulses Per Second)	Pulse Repetition Interval (Microseconds)
1	1930.5	518
2	1858.7	538
3	1792.1	558
4	1730.1	578
5	1672.2	598
6	1618.1	618
7	1567.4	638
8	1519.8	658
9	1474.9	678
10	1432.7	698
11	1392.8	718
12	1355	738
13	1319.3	758
14	1285.3	778
15	1253.1	798
16	1222.5	818
17	1193.3	838
18	1165.6	858
19	1139	878
20	1113.6	898
21	1089.3	918
22	1066.1	938
23	326.2	3066

The aggregate is the average of the percentage of successful detections of Short Pulse Radar Types 1-4. For example, the following table indicates how to compute the aggregate of percentage of successful detections.

Radar Type	Number of Trials	Number of Successful Detections	Minimum Percentage of Successful Detection
1	35	29	82.9%
2	30	18	60%
3	30	27	90%
4	50	44	88%
Aggregate $(82.9\% + 60\% + 90\% + 88\%)/4 = 80.2\%$			

Table 6 Long Pulse Radar Test Waveform

Radar Type	Pulse Width (μsec)	Chirp Width (MHz)	PRI (μsec)	Number of Pulses per Burst	Number of Bursts	Minimum Percentage of Successful Detection	Minimum Number of Trials
5	50-100	5-20	1000-2000	1-3	8-20	80%	30

The parameters for this waveform are randomly chosen. Thirty unique waveforms are required for the Long Pulse Radar Type waveforms. If more than 30 waveforms are used for the Long Pulse Radar Type waveforms, then each additional waveform must also be unique and not repeated from the previous waveforms.

Table 7 Frequency Hopping Radar Test Waveform

Radar Type	Pulse Width (μsec)	PRI (μsec)	Pulses per Hop	Hopping Rate (kHz)	Hopping Sequence Length (msec)	Minimum Percentage of Successful Detection	Minimum Number of Trials
6	1	333	9	0.333	300	70%	30

For the Frequency Hopping Radar Type, the same Burst parameters are used for each waveform. The hopping sequence is different for each waveform and a 100-length segment is selected from the hopping sequence defined by the following algorithm: The first frequency in a hopping sequence is selected randomly from the group of 475 integer frequencies from 5250 – 5724 MHz. Next, the frequency that was just chosen is removed from the group and a frequency is randomly selected from the remaining 474 frequencies in the group. This process continues until all 475 frequencies are chosen for the set. For selection of a random frequency, the frequencies remaining within the group are always treated as equally likely.

4.4. Test set-ups

We test the data stream using MPEG-X files.

Channel loading is based on IP.

Setup for Master with injection at the Master

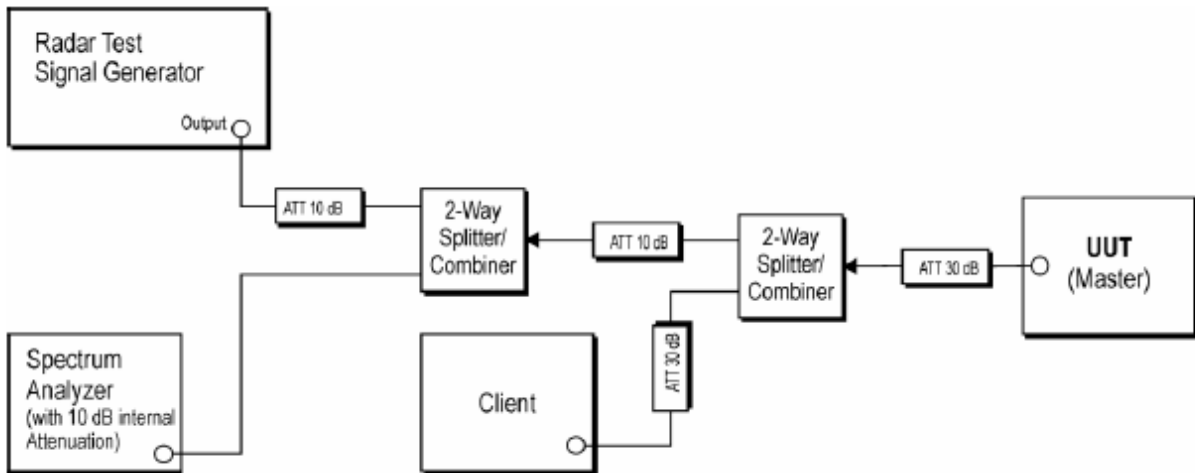

Figure 2: Example Conducted Setup where UUT is a Master and Radar Test Waveforms are injected into the Master

Setup for Client with injection at the Master

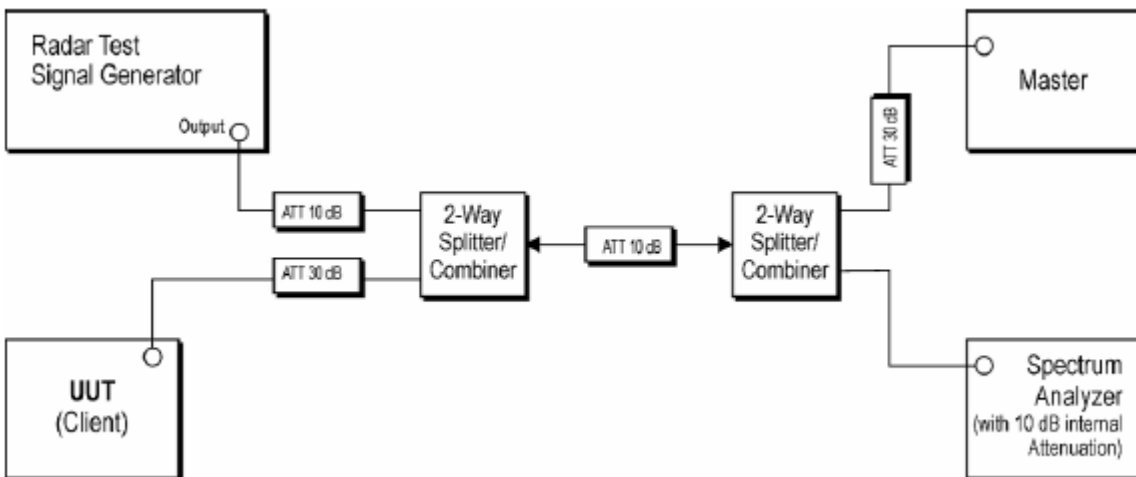

Figure 3: Example Conducted Setup where UUT is a Client and Radar Test Waveforms are injected into the Master

Setup for Client with injection at the Client

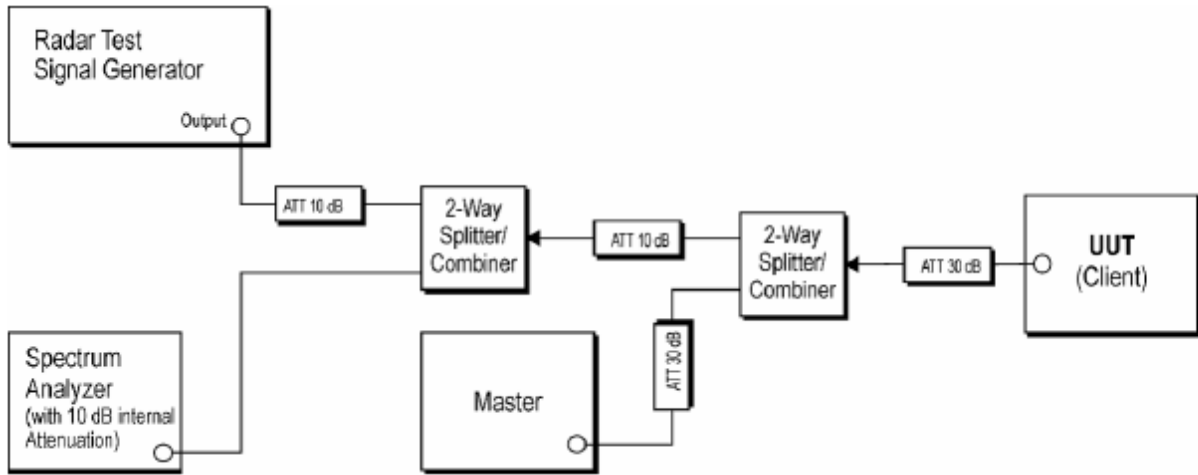

Figure 4: Example Conducted Setup where UUT is a Client and Radar Test Waveforms are injected into the Client

5. Test Case

5.1. DFS Detection Thresholds

Ambient condition

Temperature	Relative humidity	Pressure
23°C ~25°C	45%~50%	101.5kPa

Methods of Measurement

Client with injection at the Master.

For a detection threshold level of -64dBm, the required signal strength at EUT antenna location is -64dBm, the tested level is lower than required level hence it provides margin to the limit.

Frequency of Calibration	
Bandwidth	Central Frequency
20MHz	5300MHz
	5500MHz
40MHz	5270MHz
	5550MHz
80MHz	5290MHz
	5610MHz

Calibration Result

Refer to the section 6.1 of this report for test data.

5.2. U-NII Detection Bandwidth

Ambient condition

Temperature	Relative humidity	Pressure
23°C ~25°C	45%~50%	101.5kPa

Methods of Measurement

- 1 Adjust the equipment to produce a single Burst of any one of the Short Pulse Radar Types 0 – 4 in **Table 5** at the center frequency of the EUT Operating Channel at the specified DFS Detection Threshold level found in **Table 3**.
- 2 Set the EUT up as a standalone device (no associated Client or Master, as appropriate) and no traffic. Frame based systems will be set to a talk/listen ratio reflecting the worst case (maximum) that is user configurable during this test.
- 3 Generate a single radar Burst, and note the response of the UUT. Repeat for a minimum of 10 trials. The EUT must detect the Radar Waveform within the DFS band using the specified U-NII Detection Bandwidth criterion shown in **Table 4**. In cases where the channel bandwidth may exceed past the DFS band edge on specific channels select a channel that has the entire emission bandwidth within the DFS band. If this is not possible, test the detection BW to the DFS band edge.
- 4 Starting at the center frequency of the EUT operating Channel, increase the radar frequency in 5 MHz steps, repeating the above test sequence, until the detection rate falls below the U-NII Detection Bandwidth criterion specified in **Table 4**. Repeat this measurement in 1MHz steps at frequencies 5 MHz below where the detection rate begins to fall. Record the highest frequency (denote as FH) at which detection is greater than or equal to the U-NII Detection Bandwidth criterion. Recording the detection rate at frequencies above FH is not required to demonstrate compliance.
- 5 Starting at the center frequency of the EUT operating Channel, decrease the radar frequency in 5 MHz steps, repeating the above test sequence, until the detection rate falls below the U-NII Detection Bandwidth criterion specified in **Table 4**. Repeat this measurement in 1MHz steps at frequencies 5 MHz above where the detection rate begins to fall. Record the lowest frequency (denote as FL) at which detection is greater than or equal to the U-NII Detection Bandwidth criterion. Recording the detection rate at frequencies below FL is not required to demonstrate compliance.
- 6 The U-NII Detection Bandwidth is calculated as follows: U-NII Detection Bandwidth = FH – FL
- 7 The U-NII Detection Bandwidth must meet the U-NII Detection Bandwidth criterion specified in **Table 4**. Otherwise, the EUT does not comply with DFS requirements. This is essential to ensure that the EUT is capable of detecting Radar Waveforms across the same frequency spectrum that contains the significant energy from the system. In the case that the U-NII Detection Bandwidth is greater than or equal to the 99 percent power bandwidth for the measured FH and FL, the test can be truncated and the U-NII Detection Bandwidth can be reported as the measured FH and FL.

**Limits**

Rule FCC KDB 905462 7.8.1

Minimum 100% of the U-NII 99% transmission power bandwidth. During the U-NII Detection Bandwidth detection test, radar type 0 should be used. For each frequency step the minimum percentage of detection is 90 percent. Measurements are performed with no data traffic.

Measurement Uncertainty

The assessed measurement uncertainty to ensure 95% confidence level for the normal distribution is with the coverage factor $k = 2$, $U=0.44$ dB.

Test Results

Refer to the section 6.2 of this report for test data.

5.3. Channel Availability Check Time

Ambient condition

Temperature	Relative humidity	Pressure
23°C ~25°C	45%~50%	101.5kPa

Methods of Measurement

Initial Channel Availability Check Time

The U-NII devices will be powered on and be instructed to operate on the appropriate U-NII Channel that must incorporate DFS functions. At the same time the EUT is powered on, the spectrum analyzer will be set to zero span mode with a 3 MHz RBW and 3 MHz VBW on the Channel occupied by the radar with a 2.5 minute sweep time.

The EUT should not transmit any beacon or data transmissions until at least 1 minute after the completion of the power-on cycle.

Confirm that the EUT initiates transmission on the channel

Radar Burst at the Beginning of the Channel Availability Check Time

The steps below define the procedure to verify successful radar detection on the test Channel during a period equal to the Channel Availability Check Time and avoidance of operation on that Channel when a radar Burst with a level equal to the DFS Detection Threshold + 1 dB occurs at the beginning of the Channel Availability Check Time.

The Radar Waveform generator and EUT are connected using the applicable test setup described in the sections on configuration for Conducted Tests or Radiated Tests and the power of the EUT is switched off.

The EUT is powered on at T_0 - T_1 denotes the instant when the EUT has completed its power-up sequence (T_{power_up}). The Channel Availability Check Time commences on Chr at instant T_1 and will end no sooner than $T_1 + T_{ch_avail_check}$.

A single Burst of one of the Short Pulse Radar Types 0-4 will commence within a 6 second window starting at T_1 . An additional 1 dB is added to the radar test signal to ensure it is at or above the DFS Detection Threshold, accounting for equipment variations/errors.

Visual indication or measured results on the EUT of successful detection of the radar Burst will be recorded and reported. Observation of Chr for EUT emissions will continue for 2.5 minutes after the radar Burst has been generated.

Verify that during the 2.5 minute measurement window no EUT transmissions occurred on Chr. The Channel Availability Check results will be recorded.

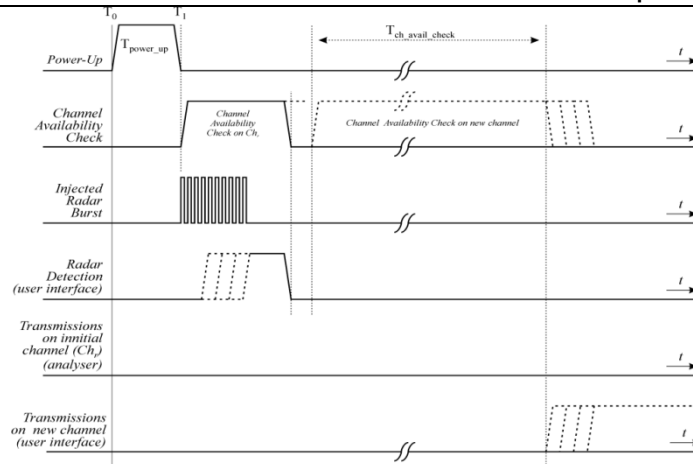

Figure: Example of timing for radar testing at the beginning of the Channel Availability Check Time

Radar Burst at the End of the Channel Availability Check Time

The steps below define the procedure to verify successful radar detection on the test Channel during a period equal to the Channel Availability Check Time and avoidance of operation on that Channel when a radar Burst with a level equal to the DFS Detection Threshold + 1dB occurs at the end of the Channel Availability Check Time.

1. The Radar Waveform generator and EUT are connected using the applicable test setup described in the sections for Conducted Tests or Radiated Tests and the power of the EUT is switched off.
2. The EUT is powered on at T_0 - T_1 denotes the instant when the EUT has completed its power-up sequence (T_{power_up}). The Channel Availability Check Time commences on Chr at instant T_1 and will end no sooner than $T_1 + T_{ch_avail_check}$.
3. A single Burst of one of the Short Pulse Radar Types 0-4 will commence within a 6 second window starting at $T_1 + 54$ seconds. An additional 1 dB is added to the radar test signal to ensure it is at or above the DFS Detection Threshold, accounting for equipment variations/errors.
4. Visual indication or measured results on the EUT of successful detection of the radar Burst will be recorded and reported. Observation of Chr for EUT emissions will continue for 2.5 minutes after the radar Burst has been generated.
5. Verify that during the 2.5 minute measurement window no EUT transmissions occurred on Chr. The Channel Availability Check results will be recorded.

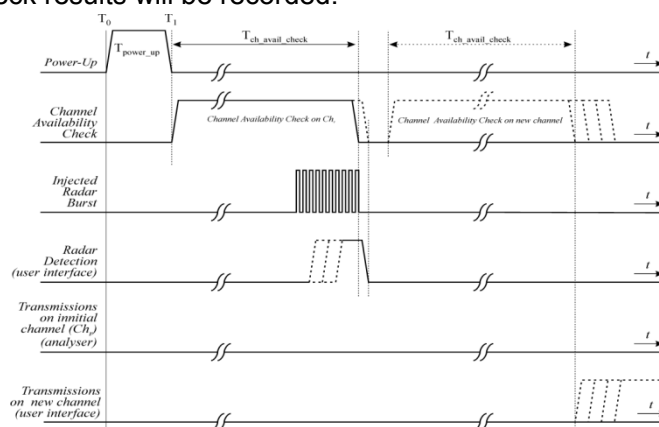

Figure : Example of timing for radar testing towards the end of the Channel Availability Check Time

**Limits**

Initial Channel Availability Check Time	60s
---	-----

Measurement Uncertainty

The assessed measurement uncertainty to ensure 95% confidence level for the normal distribution is with the coverage factor $k = 1.96$.

Test Results

Refer to the section 6.3 of this report for test data.

5.4. Channel Move Time, Channel Closing Transmission Time and Non-Occupancy Period

Ambient condition

Temperature	Relative humidity	Pressure
23°C ~25°C	45%~50%	101.5kPa

Methods of Measurement

These tests define how the following DFS parameters are verified during In-Service Monitoring;

- Channel Closing Transmission Time
- Channel Move Time
- Non-Occupancy Period

The steps below define the procedure to determine the above mentioned parameters when a radar Burst with a level equal to the DFS Detection Threshold + 1dB is generated on the Operating Channel of the U-NII device (In- Service Monitoring).

1. One frequency will be chosen from the Operating Channels of the EUT within the 5250-5350 MHz or 5470-5725 MHz bands. For 802.11 devices, the test frequency must contain control signals. This can be verified by disabling channel loading and monitoring the spectrum analyzer. If no control signals are detected, another frequency must be selected within the emission bandwidth where control signals are detected.

2. In case the EUT is a U-NII device operating as a Client Device (with or without DFS), a U-NII device operating as a Master Device will be used to allow the EUT (Client device) to Associate with the Master Device. In case the EUT is a Master Device, a U-NII device operating as a Client Device will be used and it is assumed that the Client will Associate with the EUT (Master). In both cases for conducted tests, the Radar Waveform generator will be connected to the Master Device. For radiated tests, the emissions of the Radar Waveform generator will be directed towards the Master Device. If the Master Device has antenna gain, the main beam of the antenna will be directed toward the radar emitter. Vertical polarization is used for testing.

3. Stream the channel loading test file from the Master Device to the Client Device on the test Channel for the entire period of the test.

4. At time T_0 the Radar Waveform generator sends a Burst of pulses for one of the Radar Type 0 in Table 5 at levels defined in Table 3, on the Operating Channel. An additional 1 dB is added to the radar test signal to ensure it is at or above the DFS Detection Threshold, accounting for equipment variations/errors.

5. Observe the transmissions of the EUT at the end of the radar Burst on the Operating Channel for duration greater than 10 seconds. Measure and record the transmissions from the EUT during the observation time (Channel Move Time). Measure and record the Channel Move Time and Channel Closing Transmission Time if radar detection occurs. Figure 17 illustrates Channel Closing

Transmission Time.

6. When operating as a Master Device, monitor the EUT for more than 30 minutes following instant T_2 to verify that the EUT does not resume any transmissions on this Channel. Perform this test once and record the measurement result.

7. In case the EUT is a U-NII device operating as a Client Device with In-Service Monitoring, perform steps 1 to 6.

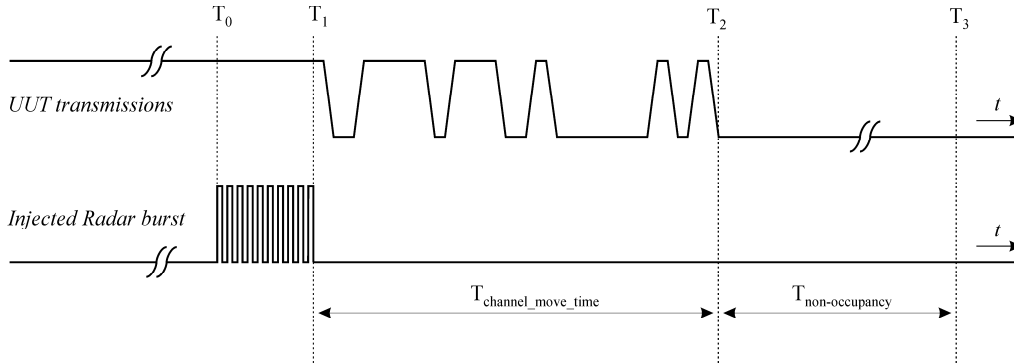

Figure 17: Example of Channel Closing Transmission Time & Channel Closing Time

Limits

Channel Move Time	$\leq 10s$
Channel Closing Transmission Time	$\leq 200ms + 60ms$ (over remaining 10s period)
Non-Occupancy Period	$\geq 30min$

Note 1: Channel Move Time and the Channel Closing Transmission Time should be performed with Radar Type 0. The measurement timing begins at the end of the Radar Type 0 burst.

Note 2: The Channel Closing Transmission Time is comprised of 200 milliseconds starting at the beginning of the Channel Move Time plus any additional intermittent control signals required to facilitate a Channel move (an aggregate of 60 milliseconds) during the remainder of the 10 second period. The aggregate duration of control signals will not count quiet periods in between transmissions.

Measurement Uncertainty

The assessed measurement uncertainty to ensure 95% confidence level for the normal distribution is with the coverage factor $k = 1.96$, $U = 2.69$ dB.

Test Results

Refer to the section 6.4 of this report for test data.

5.5. Statistical Performance Check

Ambient condition

Temperature	Relative humidity	Pressure
23°C ~25°C	45%~50%	101.5kPa

Methods of Measurement

The steps below define the procedure to determine the minimum percentage of successful detection requirements found in Tables 5-7 when a radar burst with a level equal to the DFS Detection Threshold + 1dB is generated on the Operating Channel of the U-NII device (In- Service Monitoring).

1. One frequency will be chosen from the Operating Channels of the UUT within the 5250-5350 MHz or 5470-5725 MHz bands.
2. In case the UUT is a U-NII device operating as a Client Device (with or without Radar Detection), a U-NII device operating as a Master Device will be used to allow the UUT (Client device) to Associate with the Master Device. In case the UUT is a Master Device, a U-NII device operating as a Client Device will be used and it is assumed that the Client will Associate with the UUT(Master). In both cases for conducted tests, the Radar Waveform generator will be connected to the Master Device. For radiated tests, the emissions of the Radar Waveform generator will be directed towards the Master Device. If the Master Device has antenna gain, the main beam of the antenna will be directed toward the radar emitter. Vertical polarization is used for testing.
3. Stream the channel loading test file from the Master Device to the Client Device on the test Channel for the entire period of the test.
4. At time T0 the Radar Waveform generator sends the individual waveform for each of the Radar Types 1- 6 in Tables 5-7, at levels defined in Table 3, on the Operating Channel. An additional 1 dB is added to the radar test signal to ensure it is at or above the DFS Detection Threshold, accounting for equipment variations/errors.
5. Observe the transmissions of the UUT at the end of the Burst on the Operating Channel for duration greater than 10 seconds for Radar Type 0 to ensure detection occurs.
6. Observe the transmissions of the UUT at the end of the Burst on the Operating Channel for duration greater than 22 seconds for Long Pulse Radar Type 5 to ensure detection occurs.
7. In case the UUT is a U-NII device operating as a Client Device with In-Service Monitoring, perform steps 1 to 6.

Limits

Radar Type	Minimum Percentage of Successful Detection	Minimum Number of Trials
1	60%	30
2	60%	30
3	60%	30
4	60%	30
Aggregate (Radar Types 1-4)	80%	120
5	80%	30
6	70%	30

Measurement Uncertainty

The assessed measurement uncertainty to ensure 95% confidence level for the normal distribution is with the coverage factor $k = 1.96$, $U=2.69$ dB.

Test Results

Refer to the section 6.5 of this report for test data.



6. Test Results

6.1. DFS Detection Thresholds

Radar 0

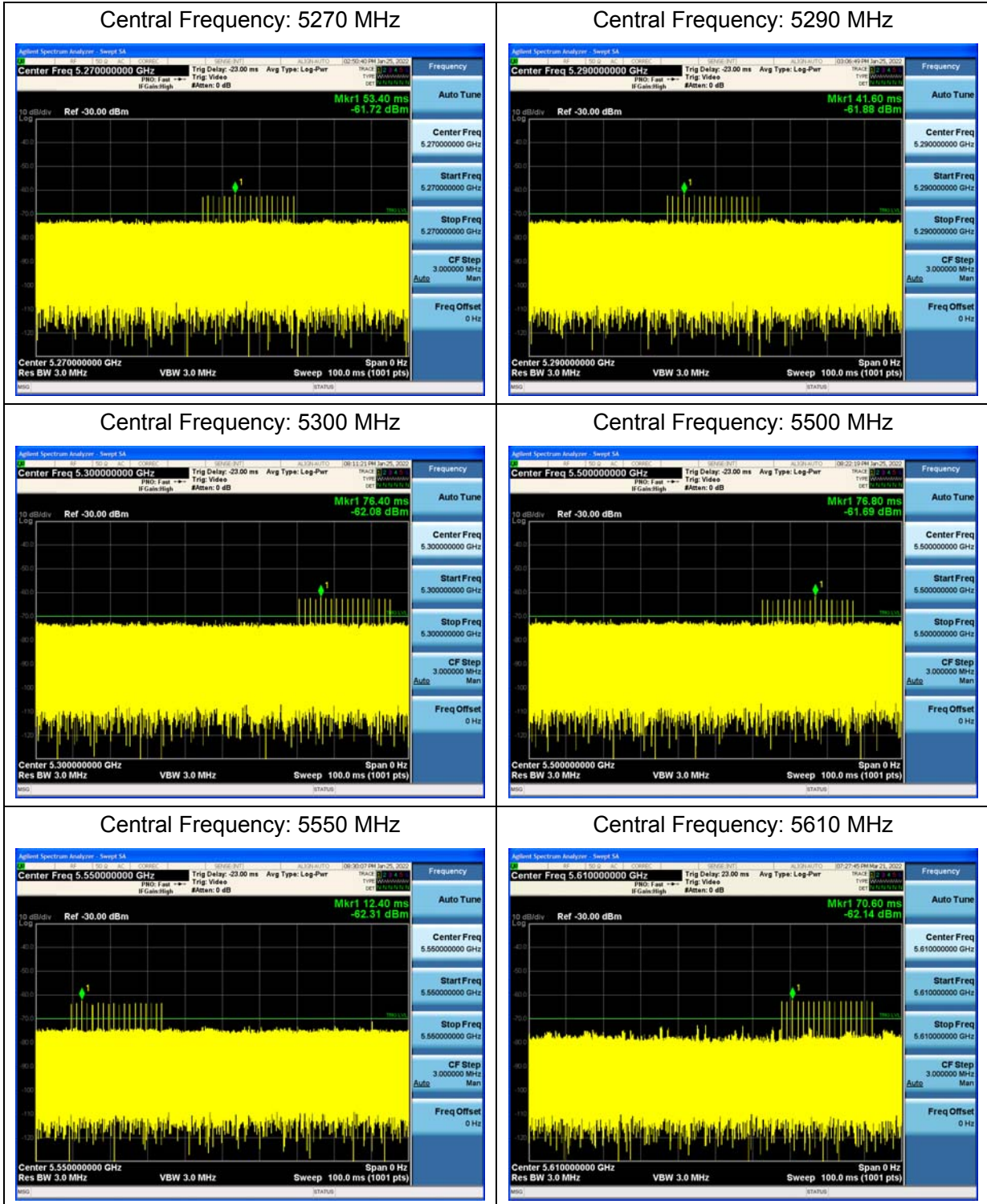



Radar 1

Central Frequency: 5270 MHz

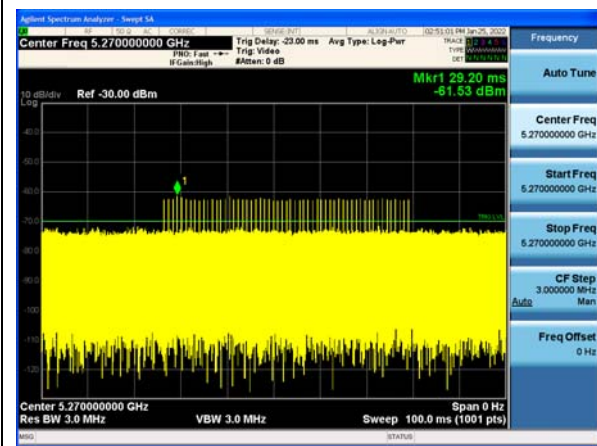

Central Frequency: 5290 MHz

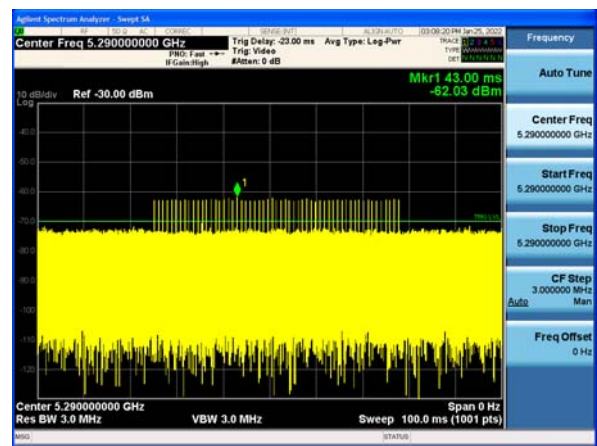

Central Frequency: 5300 MHz

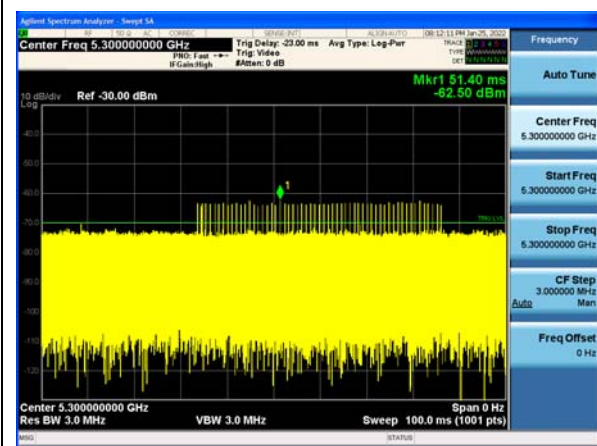

Central Frequency: 5500 MHz

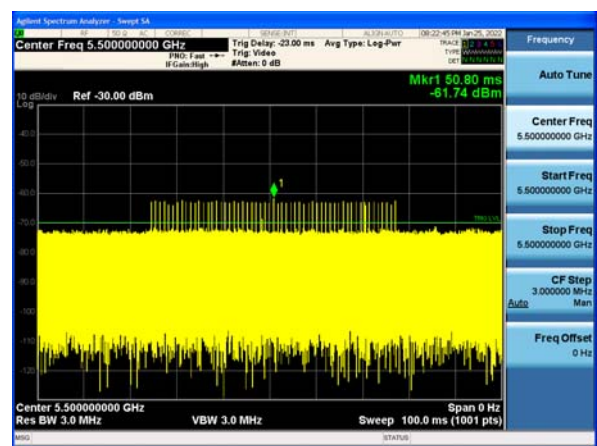

Central Frequency: 5550 MHz

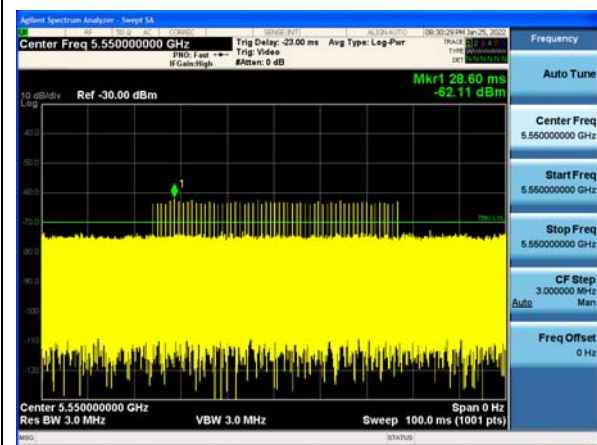

Central Frequency: 5610 MHz

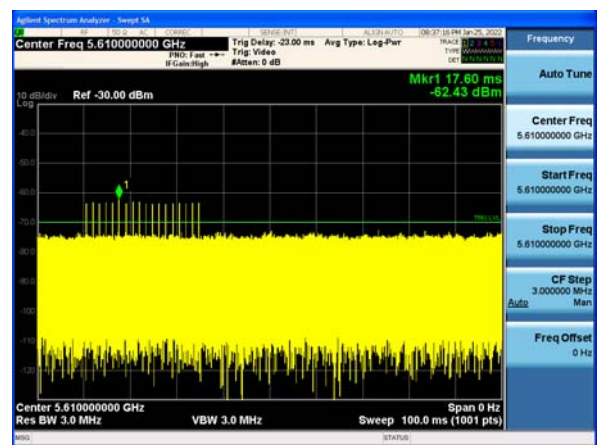



Radar 2

Central Frequency: 5270 MHz

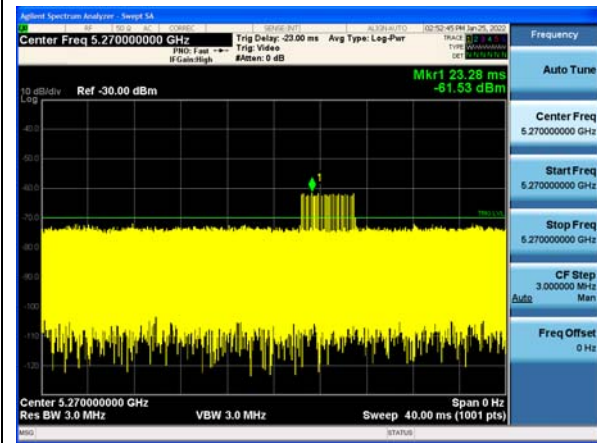

Central Frequency: 5290 MHz

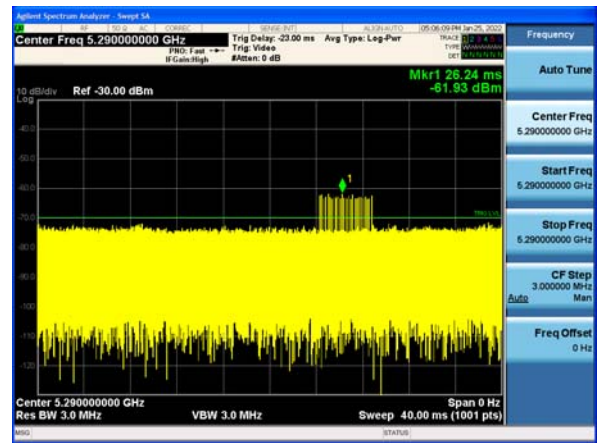

Central Frequency: 5300 MHz

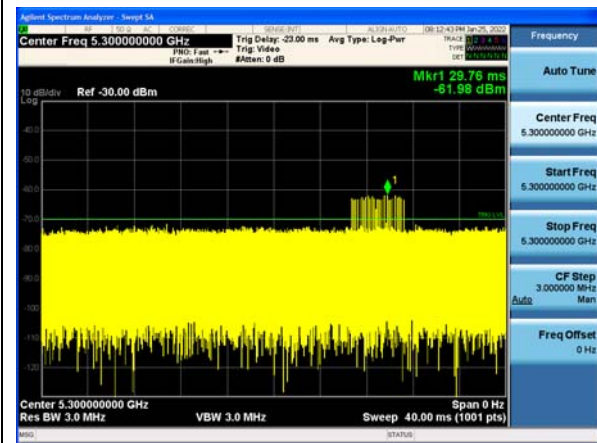

Central Frequency: 5500 MHz

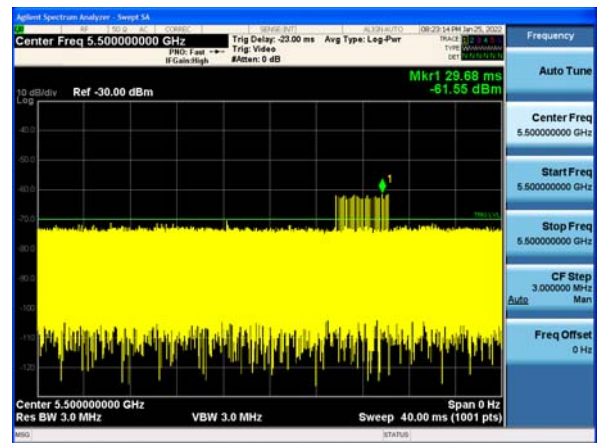

Central Frequency: 5550 MHz

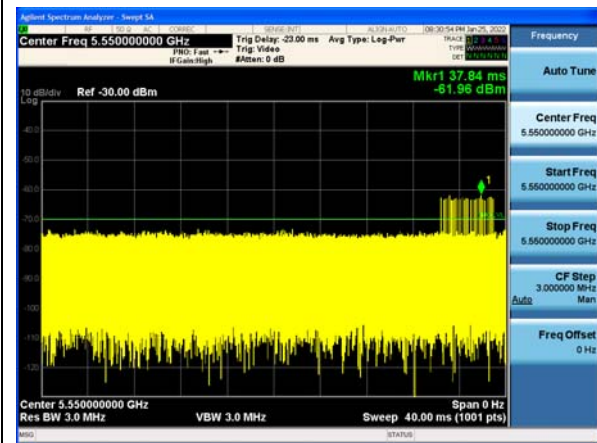

Central Frequency: 5610 MHz

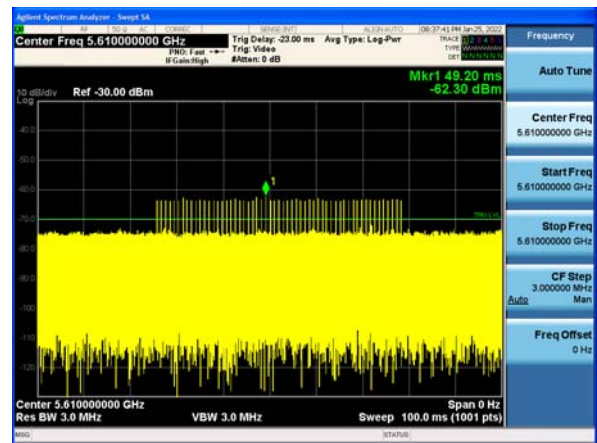



Radar 3

Central Frequency: 5270 MHz

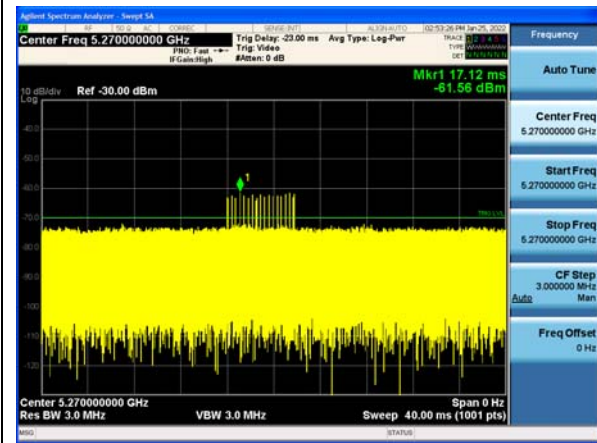

Central Frequency: 5290 MHz

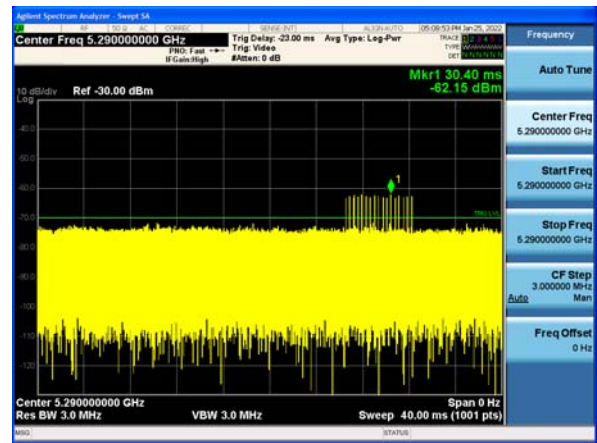

Central Frequency: 5300 MHz

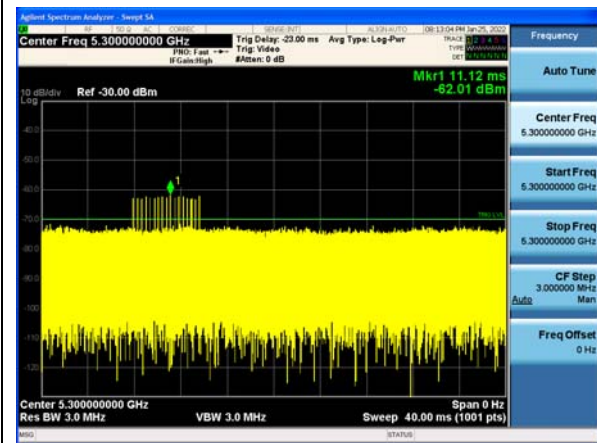

Central Frequency: 5500 MHz

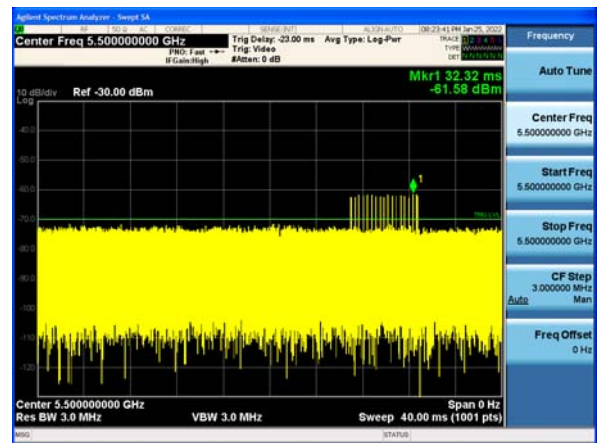

Central Frequency: 5550 MHz

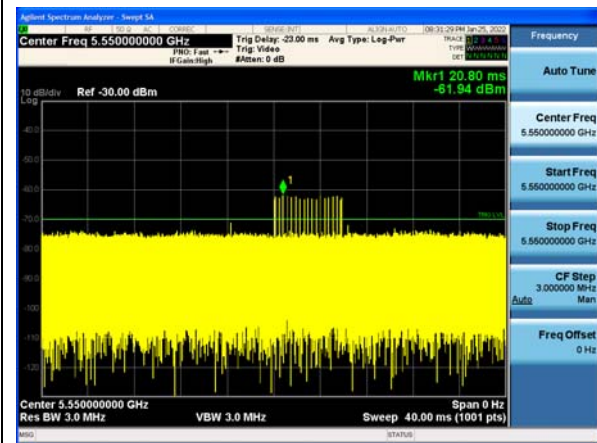

Central Frequency: 5610 MHz

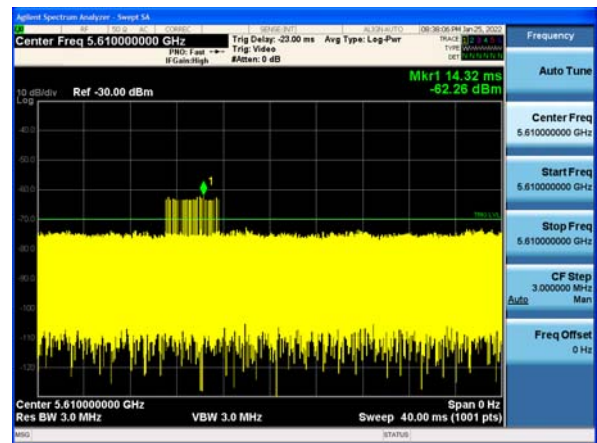



Radars 4

Central Frequency: 5270 MHz

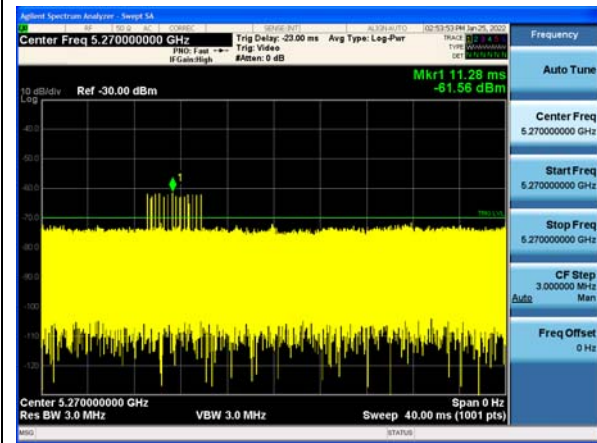

Central Frequency: 5290 MHz

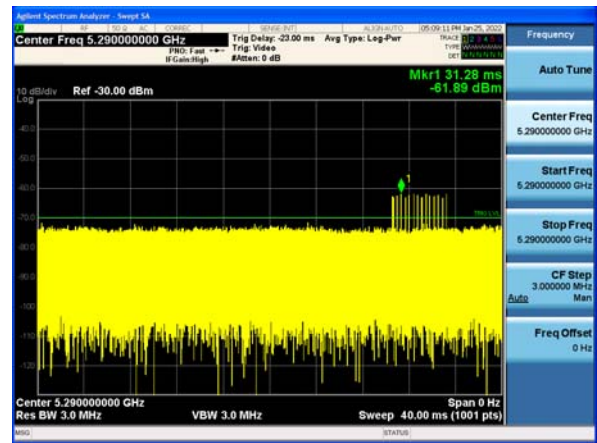

Central Frequency: 5300 MHz

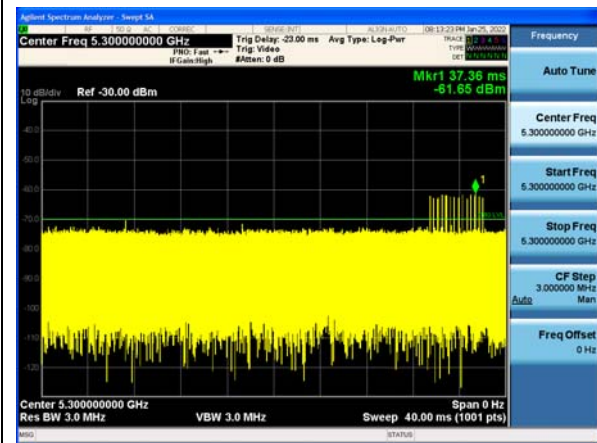

Central Frequency: 5500 MHz

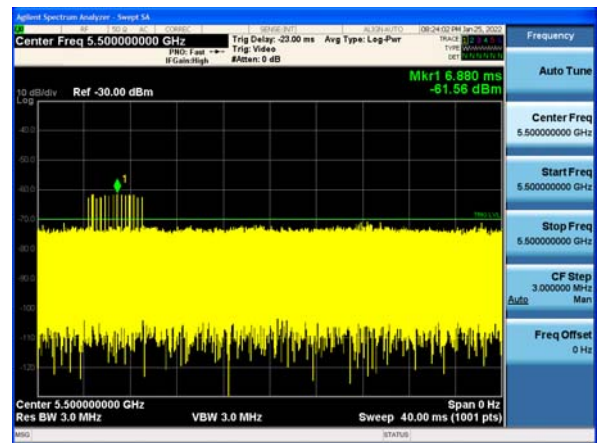

Central Frequency: 5550 MHz

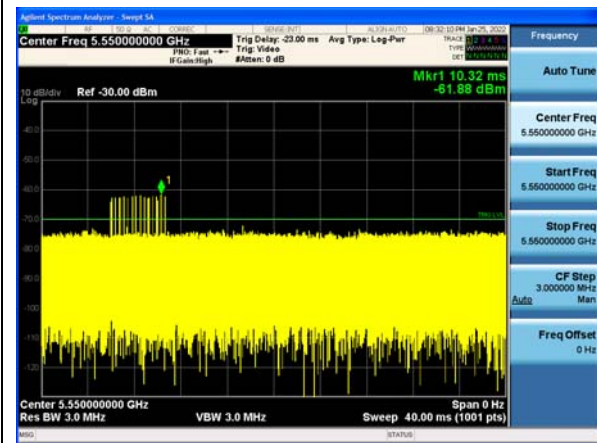

Central Frequency: 5610 MHz

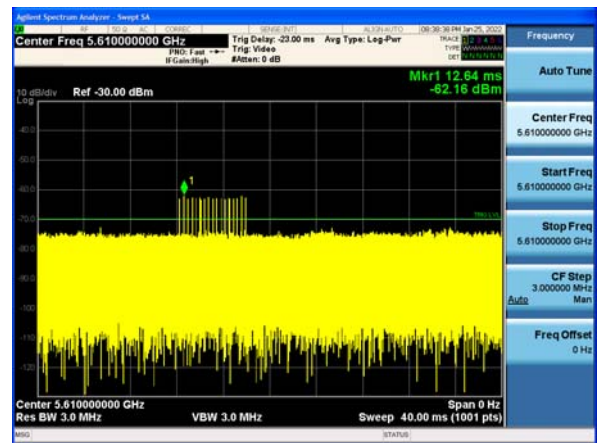



Radars 5

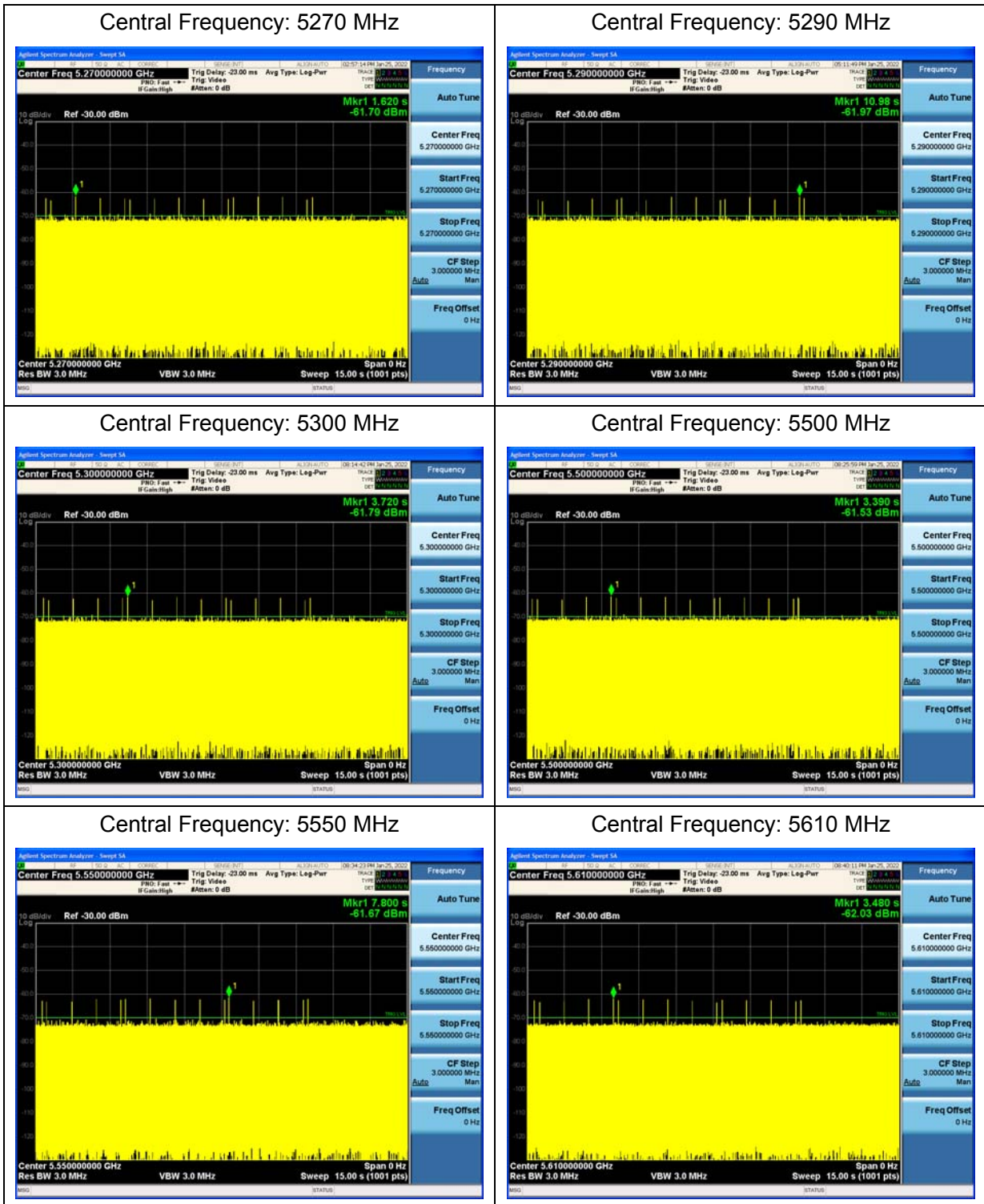



Radars 6

Central Frequency: 5270 MHz

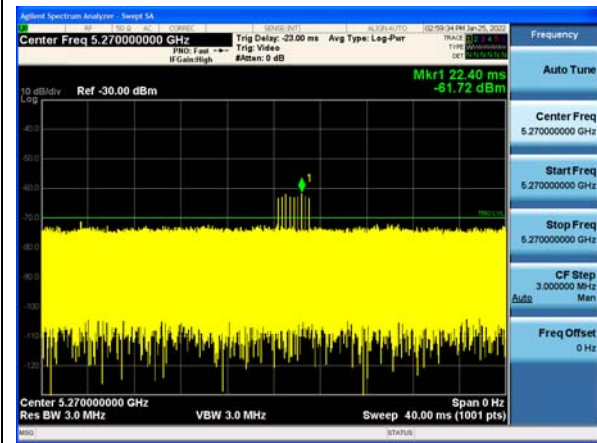

Central Frequency: 5290 MHz

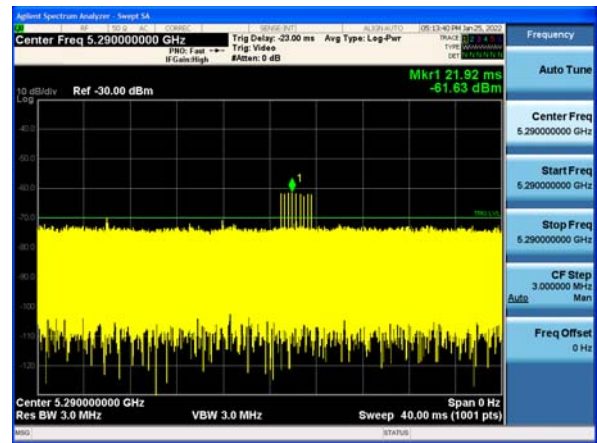

Central Frequency: 5300 MHz

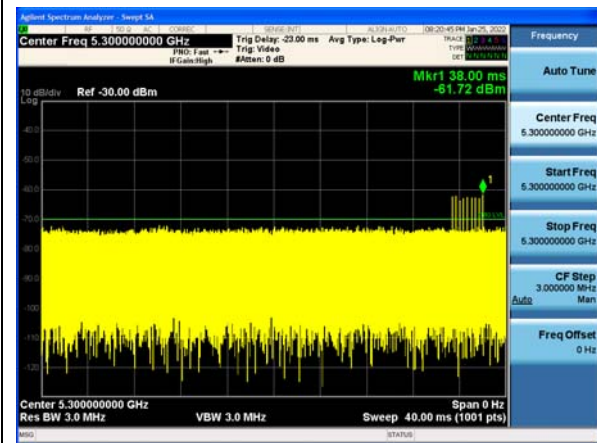

Central Frequency: 5500 MHz

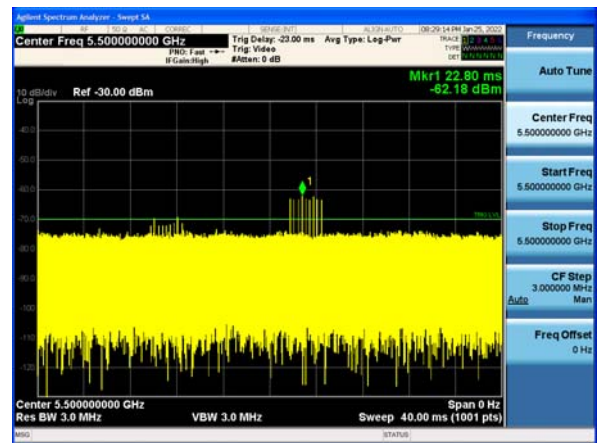

Central Frequency: 5550 MHz

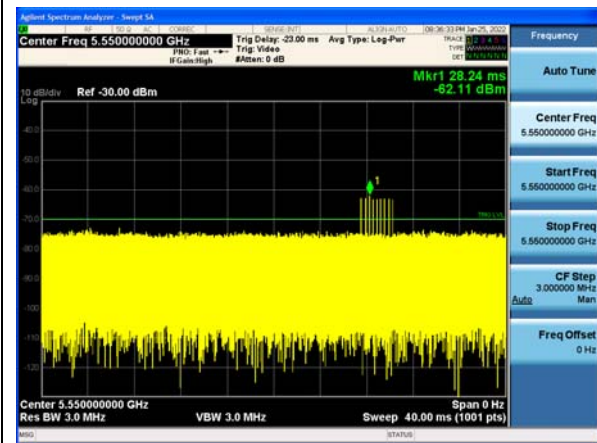

Central Frequency: 5610 MHz

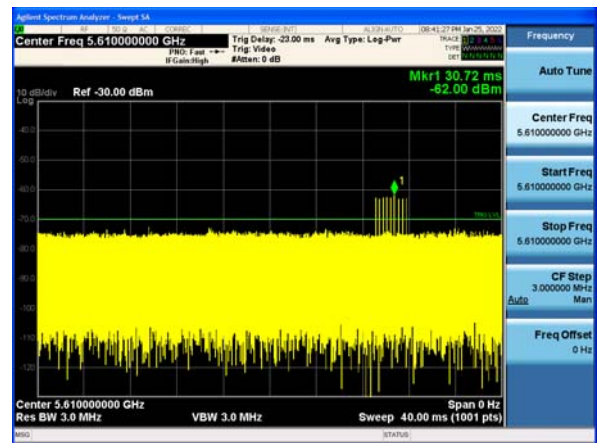

6.2. U-NII Detection Bandwidth

Timing plot

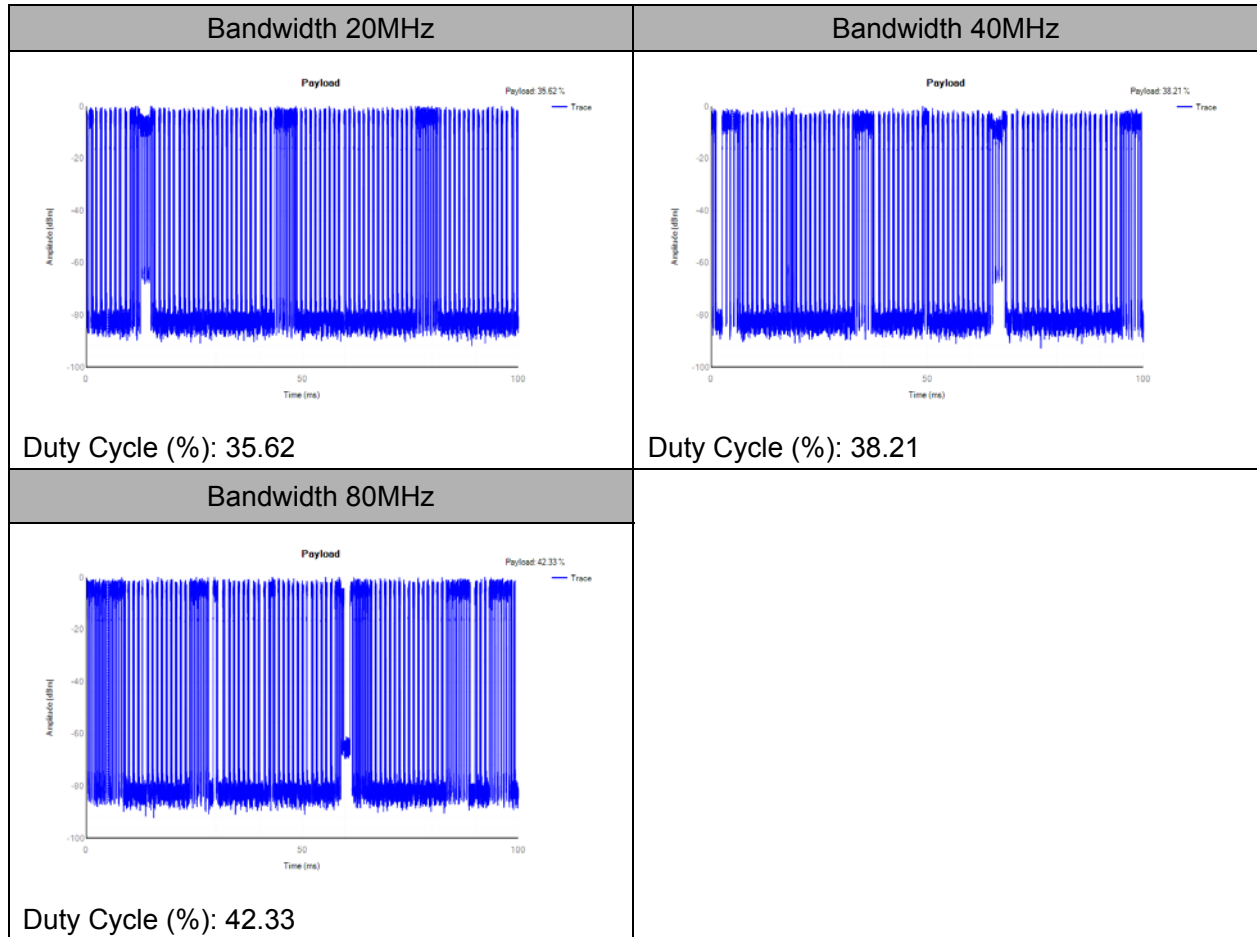



Y=Detected; N=Non-detected

Bandwidth	Frequency (MHz)	Central Frequency: 5270 MHz										Rate
		1	2	3	4	5	6	7	8	9	10	
40 MHz	5290	N	N	N	N	N	N	N	N	N	N	0%
	5289(FH)	Y	Y	Y	Y	Y	Y	Y	Y	Y	Y	100%
	5288	Y	Y	Y	Y	Y	Y	Y	Y	Y	Y	100%
	5287	Y	Y	Y	Y	Y	Y	Y	Y	Y	Y	100%
	5286	Y	Y	Y	Y	Y	Y	Y	Y	Y	Y	100%
	5285	Y	Y	Y	Y	Y	Y	Y	Y	Y	Y	100%
	5280	Y	Y	Y	Y	Y	Y	Y	Y	Y	Y	100%
	5275	Y	Y	Y	Y	Y	Y	Y	Y	Y	Y	100%
	5270	Y	Y	Y	Y	Y	Y	Y	Y	Y	Y	100%
	5265	Y	Y	Y	Y	Y	Y	Y	Y	Y	Y	100%
	5260	Y	Y	Y	Y	Y	Y	Y	Y	Y	Y	100%
	5255	Y	Y	Y	Y	Y	Y	Y	Y	Y	Y	100%
	5254	Y	Y	Y	Y	Y	Y	Y	Y	Y	Y	100%
	5253	Y	Y	Y	Y	Y	Y	Y	Y	Y	Y	100%
	5252	Y	Y	Y	Y	Y	Y	Y	Y	Y	Y	100%
	5251(FL)	Y	Y	Y	Y	Y	Y	Y	Y	Y	Y	100%
5250	N	N	N	N	N	N	N	N	N	N	0%	
Detection Bandwidth > 99%OCB		FH-FL=38>36.828										



Bandwidth	Frequency (MHz)	Central Frequency: 5290 MHz										Rate
		1	2	3	4	5	6	7	8	9	10	
80 MHz	5330	Y	Y	Y	Y	Y	Y	Y	Y	Y	Y	100%
	5329	N	N	N	N	N	N	N	N	N	N	0%
	5328 (FH)	Y	Y	Y	Y	Y	Y	Y	Y	Y	Y	100%
	5327	Y	Y	Y	Y	Y	Y	Y	Y	Y	Y	100%
	5326	Y	Y	Y	Y	Y	Y	Y	Y	Y	Y	100%
	5325	Y	Y	Y	Y	Y	Y	Y	Y	Y	Y	100%
	5320	Y	Y	Y	Y	Y	Y	Y	Y	Y	Y	100%
	5315	Y	Y	Y	Y	Y	Y	Y	Y	Y	Y	100%
	5310	Y	Y	Y	Y	Y	Y	Y	Y	Y	Y	100%
	5305	Y	Y	Y	Y	Y	Y	Y	Y	Y	Y	100%
	5300	Y	Y	Y	Y	Y	Y	Y	Y	Y	Y	100%
	5295	Y	Y	Y	Y	Y	Y	Y	Y	Y	Y	100%
	5290	Y	Y	Y	Y	Y	Y	Y	Y	Y	Y	100%
	5285	Y	Y	Y	Y	Y	Y	Y	Y	Y	Y	100%
	5280	Y	Y	Y	Y	Y	Y	Y	Y	Y	Y	100%
	5275	Y	Y	Y	Y	Y	Y	Y	Y	Y	Y	100%
	5270	Y	Y	Y	Y	Y	Y	Y	Y	Y	Y	100%
	5265	Y	Y	Y	Y	Y	Y	Y	Y	Y	Y	100%
	5260	Y	Y	Y	Y	Y	Y	Y	Y	Y	Y	100%
	5255	Y	Y	Y	Y	Y	Y	Y	Y	Y	Y	100%
5254	Y	Y	Y	Y	Y	Y	Y	Y	Y	Y	100%	
5253	Y	Y	Y	Y	Y	Y	Y	Y	Y	Y	100%	
5252 (FL)	Y	Y	Y	Y	Y	Y	Y	Y	Y	Y	100%	
5251	N	N	N	N	N	N	N	N	N	N	0%	
5250	Y	Y	Y	Y	Y	Y	Y	Y	Y	Y	100%	
Detection Bandwidth > 99%OCB		FH-FL=76>75.261										



Bandwidth	Frequency (MHz)	Central Frequency: 5300 MHz										Rate	
		1	2	3	4	5	6	7	8	9	10		
20 MHz	5310	N	N	N	N	N	N	N	N	N	N	N	0%
	5309 (FH)	Y	Y	Y	Y	Y	Y	Y	Y	Y	Y	Y	100%
	5308	Y	Y	Y	Y	Y	Y	Y	Y	Y	Y	Y	100%
	5307	Y	Y	Y	Y	Y	Y	Y	Y	Y	Y	Y	100%
	5306	Y	Y	Y	Y	Y	Y	Y	Y	Y	Y	Y	100%
	5305	Y	Y	Y	Y	Y	Y	Y	Y	Y	Y	Y	100%
	5300	Y	Y	Y	Y	Y	Y	Y	Y	Y	Y	Y	100%
	5295	Y	Y	Y	Y	Y	Y	Y	Y	Y	Y	Y	100%
	5294	Y	Y	Y	Y	Y	Y	Y	Y	Y	Y	Y	100%
	5293	Y	Y	Y	Y	Y	Y	Y	Y	Y	Y	Y	100%
	5292	Y	Y	Y	Y	Y	Y	Y	Y	Y	Y	Y	100%
	5291 (FL)	Y	Y	Y	Y	Y	Y	Y	Y	Y	Y	Y	100%
5290	N	N	N	N	N	N	N	N	N	N	N	0%	
Detection Bandwidth > 99%OCB		FH-FL=18>17.796											

Bandwidth	Frequency (MHz)	Central Frequency: 5500 MHz										Rate	
		1	2	3	4	5	6	7	8	9	10		
20 MHz	5510	N	N	N	N	N	N	N	N	N	N	N	0%
	5509 (FH)	Y	Y	Y	Y	Y	Y	Y	Y	Y	Y	Y	100%
	5508	Y	Y	Y	Y	Y	Y	Y	Y	Y	Y	Y	100%
	5507	Y	Y	Y	Y	Y	Y	Y	Y	Y	Y	Y	100%
	5506	Y	Y	Y	Y	Y	Y	Y	Y	Y	Y	Y	100%
	5505	Y	Y	Y	Y	Y	Y	Y	Y	Y	Y	Y	100%
	5500	Y	Y	Y	Y	Y	Y	Y	Y	Y	Y	Y	100%
	5495	Y	Y	Y	Y	Y	Y	Y	Y	Y	Y	Y	100%
	5494	Y	Y	Y	Y	Y	Y	Y	Y	Y	Y	Y	100%
	5493	Y	Y	Y	Y	Y	Y	Y	Y	Y	Y	Y	100%
	5492	Y	Y	Y	Y	Y	Y	Y	Y	Y	Y	Y	100%
	5491 (FL)	Y	Y	Y	Y	Y	Y	Y	Y	Y	Y	Y	100%
5490	N	N	N	N	N	N	N	N	N	N	N	0%	
Detection Bandwidth > 99%OCB		FH-FL=18>17.698											



Bandwidth	Frequency (MHz)	Central Frequency: 5550 MHz										Rate	
		1	2	3	4	5	6	7	8	9	10		
40 MHz	5570	N	N	N	N	N	N	N	N	N	N	N	0%
	5569(FH)	Y	Y	Y	Y	Y	Y	Y	Y	Y	Y	Y	100%
	5568	Y	Y	Y	Y	Y	Y	Y	Y	Y	Y	Y	100%
	5567	Y	Y	Y	Y	Y	Y	Y	Y	Y	Y	Y	100%
	5566	Y	Y	Y	Y	Y	Y	Y	Y	Y	Y	Y	100%
	5565	Y	Y	Y	Y	Y	Y	Y	Y	Y	Y	Y	100%
	5560	Y	Y	Y	Y	Y	Y	Y	Y	Y	Y	Y	100%
	5555	Y	Y	Y	Y	Y	Y	Y	Y	Y	Y	Y	100%
	5550	Y	Y	Y	Y	Y	Y	Y	Y	Y	Y	Y	100%
	5545	Y	Y	Y	Y	Y	Y	Y	Y	Y	Y	Y	100%
	5540	Y	Y	Y	Y	Y	Y	Y	Y	Y	Y	Y	100%
	5535	Y	Y	Y	Y	Y	Y	Y	Y	Y	Y	Y	100%
	5534	Y	Y	Y	Y	Y	Y	Y	Y	Y	Y	Y	100%
	5533	Y	Y	Y	Y	Y	Y	Y	Y	Y	Y	Y	100%
	5532	Y	Y	Y	Y	Y	Y	Y	Y	Y	Y	Y	100%
	5531(FL)	Y	Y	Y	Y	Y	Y	Y	Y	Y	Y	Y	100%
5530	N	N	N	N	N	N	N	N	N	N	N	0%	
Detection Bandwidth > 99%OCB		FH-FL=38>36											



Bandwidth	Frequency (MHz)	Central Frequency: 5610 MHz										Rate	
		1	2	3	4	5	6	7	8	9	10		
80 MHz	5650	N	N	N	N	N	N	N	N	N	N	N	0%
	5649 (FH)	Y	Y	Y	Y	Y	Y	Y	Y	Y	Y	Y	100%
	5648	Y	Y	Y	Y	Y	Y	Y	Y	Y	Y	Y	100%
	5647	Y	Y	Y	Y	Y	Y	Y	Y	Y	Y	Y	100%
	5646	Y	Y	Y	Y	Y	Y	Y	Y	Y	Y	Y	100%
	5645	Y	Y	Y	Y	Y	Y	Y	Y	Y	Y	Y	100%
	5640	Y	Y	Y	Y	Y	Y	Y	Y	Y	Y	Y	100%
	5635	Y	Y	Y	Y	Y	Y	Y	Y	Y	Y	Y	100%
	5630	Y	Y	Y	Y	Y	Y	Y	Y	Y	Y	Y	100%
	5625	Y	Y	Y	Y	Y	Y	Y	Y	Y	Y	Y	100%
	5620	Y	Y	Y	Y	Y	Y	Y	Y	Y	Y	Y	100%
	5615	Y	Y	Y	Y	Y	Y	Y	Y	Y	Y	Y	100%
	5610	Y	Y	Y	Y	Y	Y	Y	Y	Y	Y	Y	100%
	5605	Y	Y	Y	Y	Y	Y	Y	Y	Y	Y	Y	100%
	5600	Y	Y	Y	Y	Y	Y	Y	Y	Y	Y	Y	100%
	5595	Y	Y	Y	Y	Y	Y	Y	Y	Y	Y	Y	100%
	5590	Y	Y	Y	Y	Y	Y	Y	Y	Y	Y	Y	100%
	5585	Y	Y	Y	Y	Y	Y	Y	Y	Y	Y	Y	100%
	5580	Y	Y	Y	Y	Y	Y	Y	Y	Y	Y	Y	100%
	5575	Y	Y	Y	Y	Y	Y	Y	Y	Y	Y	Y	100%
5574	Y	Y	Y	Y	Y	Y	Y	Y	Y	Y	Y	100%	
5573	Y	Y	Y	Y	Y	Y	Y	Y	Y	Y	Y	100%	
5572	Y	Y	Y	Y	Y	Y	Y	Y	Y	Y	Y	100%	
5571 (FL)	Y	Y	Y	Y	Y	Y	Y	Y	Y	Y	Y	100%	
5570	N	N	N	N	N	N	N	N	N	N	N	0%	
Detection Bandwidth > 99%OCB		FH-FL=78>77.013											

6.3 Channel Availability Check Time

Initial Channel Availability Check Time

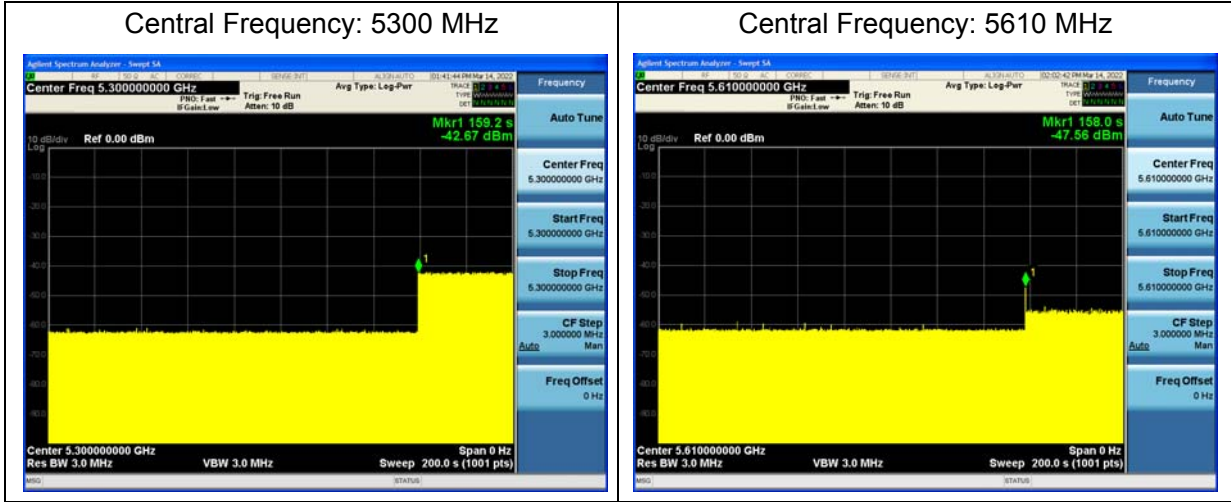



Radar Burst at the Beginning of the Channel Availability Check Time

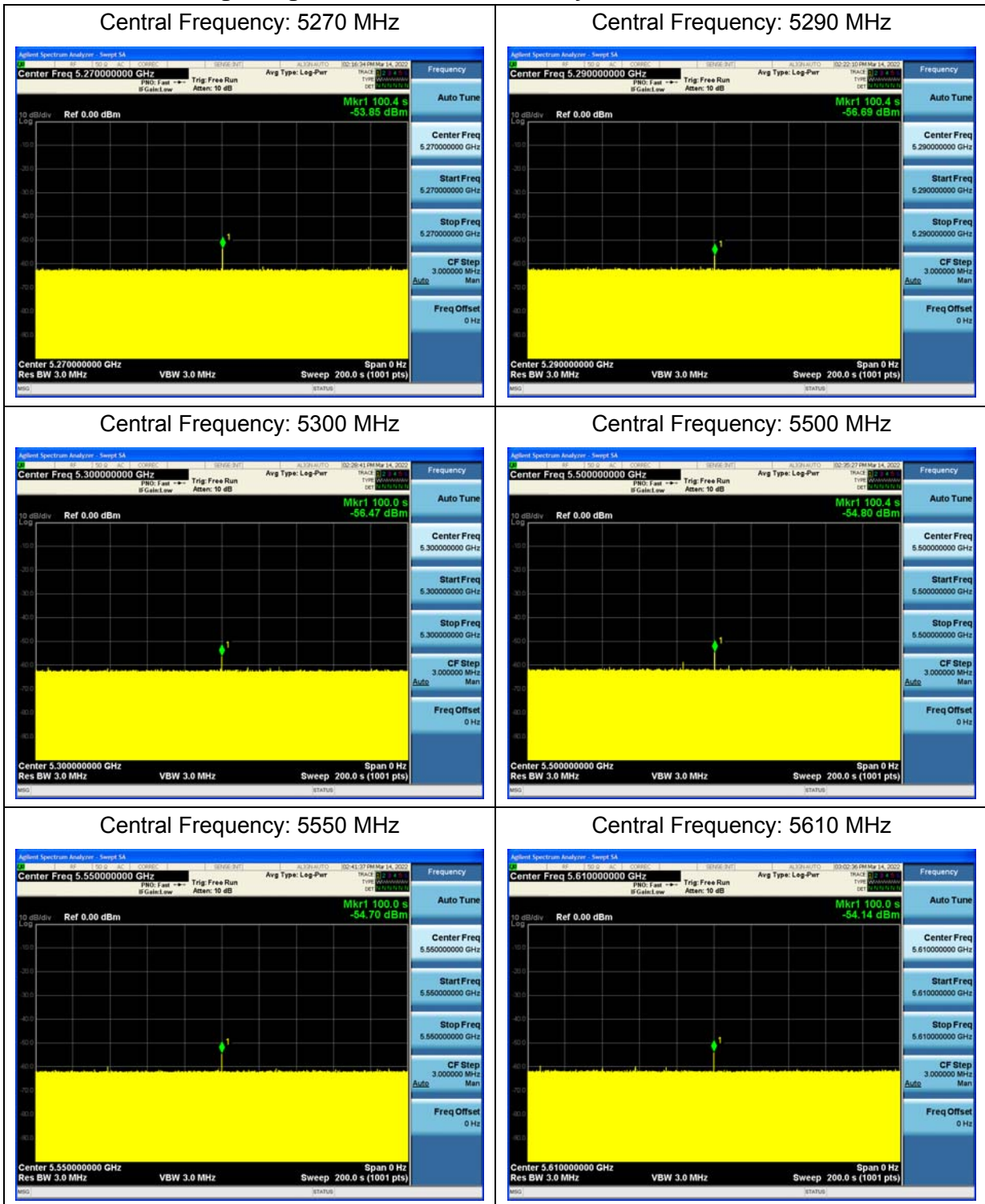



Radar Burst at the End Central Frequency: 5500 MHz

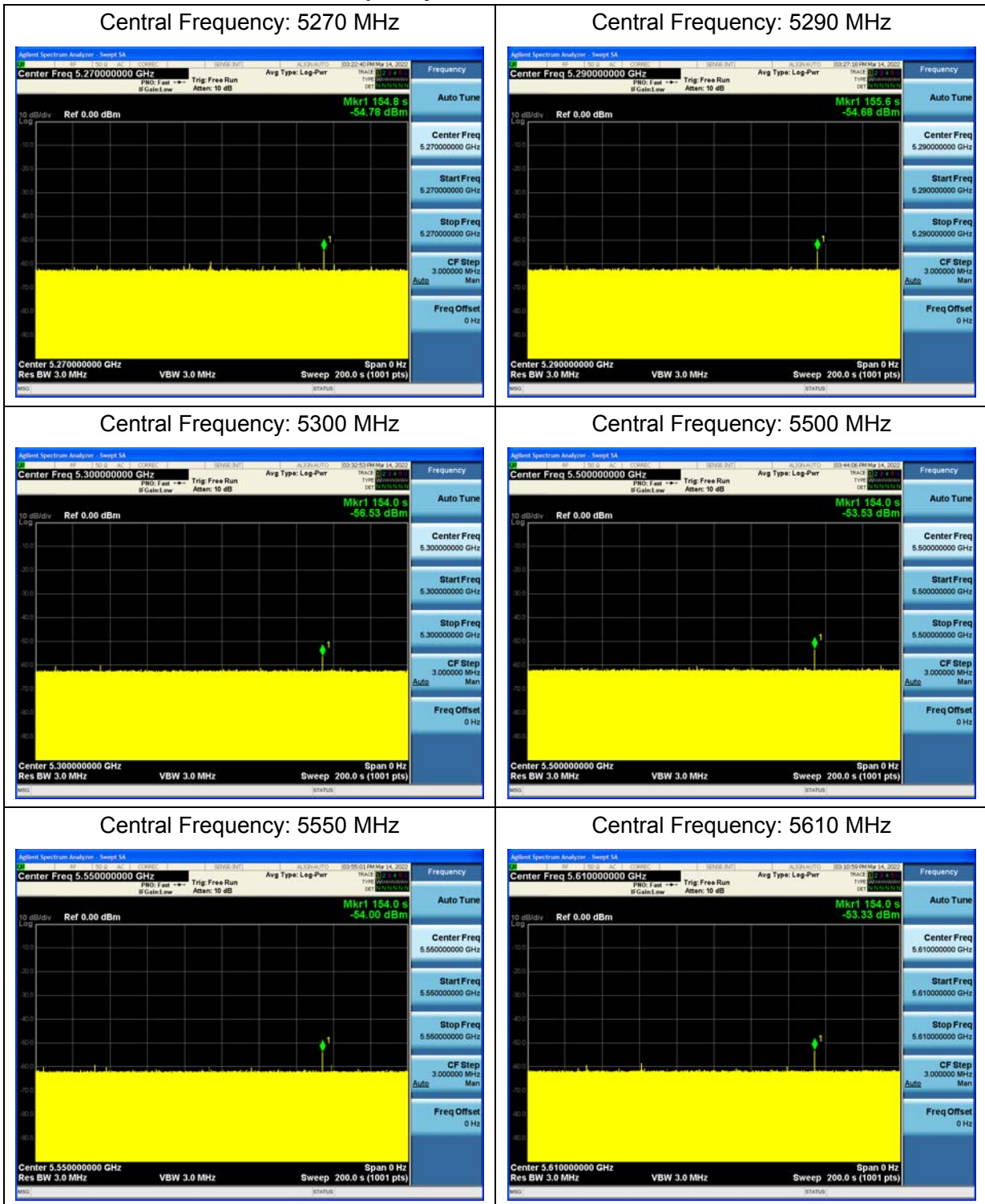



6.4 Channel Move Time, Channel Closing Transmission Time and Non-Occupancy Period

Channel Move Time

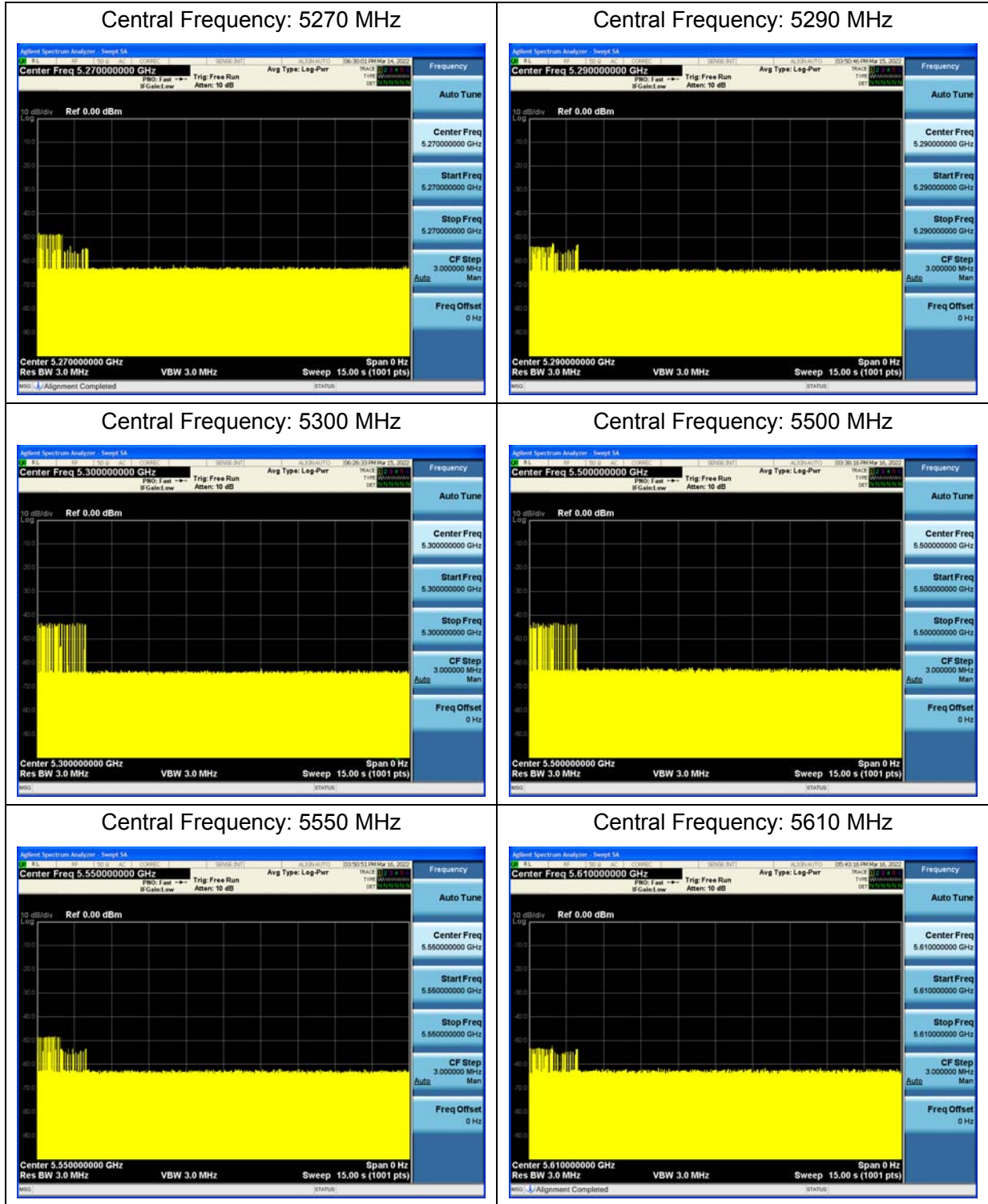



Channel Closing Transmission Time

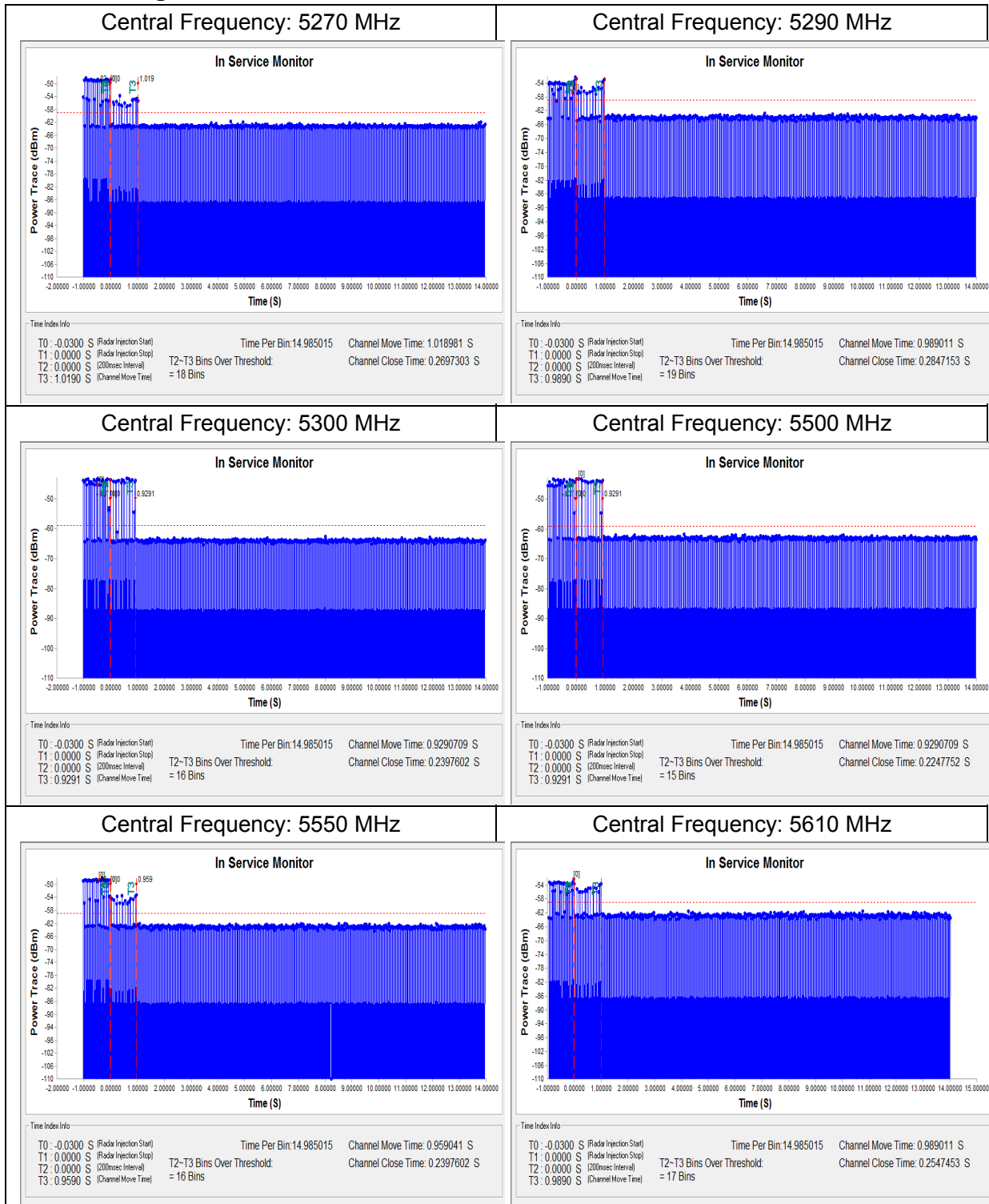



Non-Occupancy Period

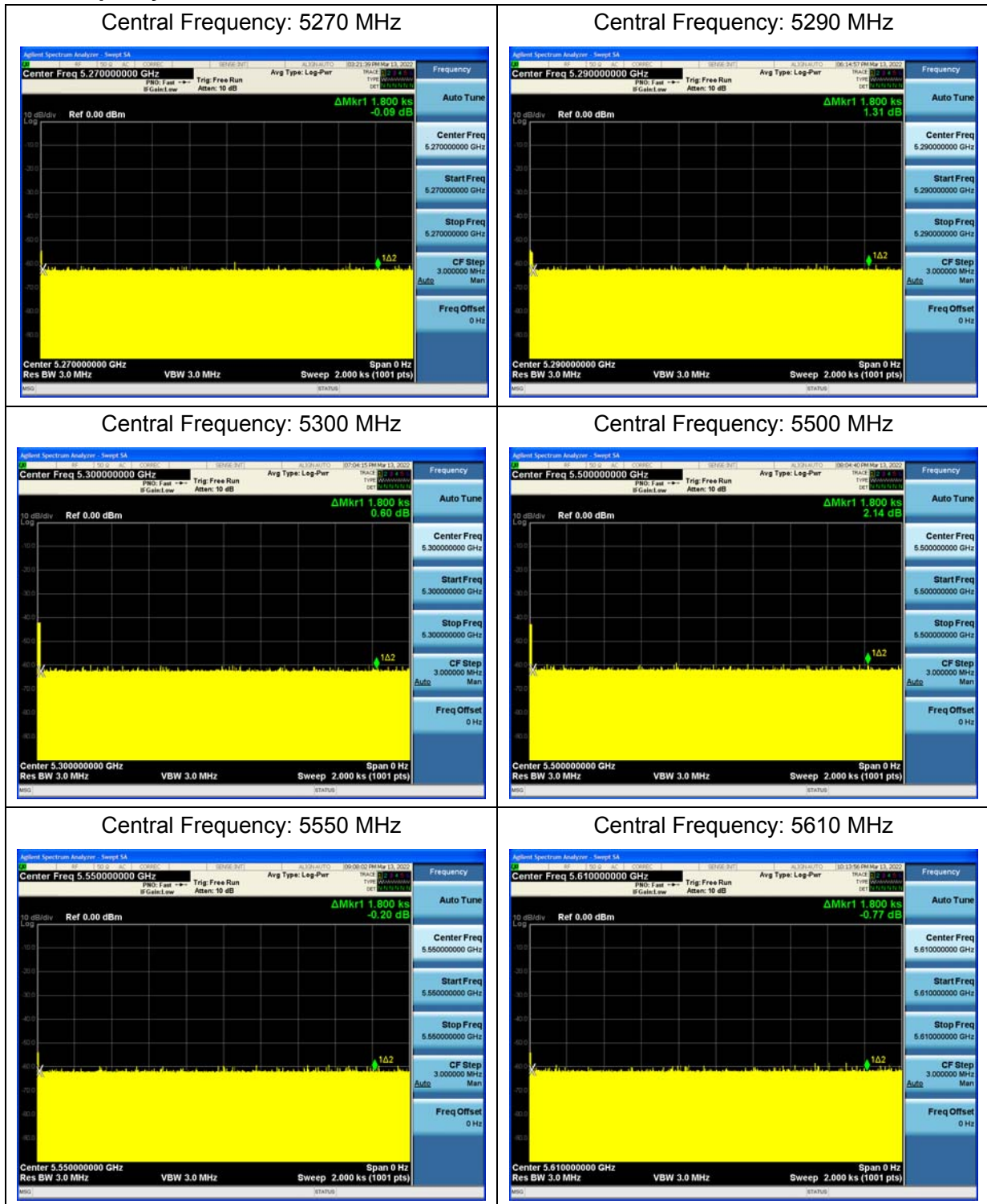

6.4 Statistical Performance Check

Y=Detected; N=Non-detected

Operating Freq (MHz)	Radar Type	Test Result	Limit
☒5270	1	100%	60%
	2	100%	60%
	3	100%	60%
	4	100%	60%
	Aggregate (Radar Types 1-4)	100%	80%
	5	97%	80%
	6	100%	70%
☒5290	1	100%	60%
	2	100%	60%
	3	97%	60%
	4	100%	60%
	Aggregate (Radar Types 1-4)	99.25%	80%
	5	100%	80%
	6	100%	70%
☒5300	1	100%	60%
	2	100%	60%
	3	100%	60%
	4	100%	60%
	Aggregate (Radar Types 1-4)	100%	80%
	5	94%	80%
	6	100%	70%
☒5500	1	100%	60%
	2	100%	60%
	3	100%	60%
	4	100%	60%
	Aggregate (Radar Types 1-4)	100%	80%
	5	100%	80%
	6	100%	70%



☒5550	1	100%	60%
	2	100%	60%
	3	97%	60%
	4	97%	60%
	Aggregate (Radar Types 1-4)	98.5%	80%
	5	100%	80%
	6	100%	70%
☒5610	1	100%	60%
	2	100%	60%
	3	100%	60%
	4	100%	60%
	Aggregate (Radar Types 1-4)	100%	80%
	5	100%	80%
	6	100%	70%

**5270MHZ, Radar 1**

Trial Id	Radar Type	Pulse Width(μ s)	PRI (μ s)	Number of Pulses	Waveform Length (μ s)	conclusion
0	1	1.0	938.0	57	53466.0	Y
1	1	1.0	698.0	76	53048.0	Y
2	1	1.0	618.0	86	53148.0	Y
3	1	1.0	538.0	99	53262.0	Y
4	1	1.0	878.0	61	53558.0	Y
5	1	1.0	3066.0	18	55188.0	Y
6	1	1.0	638.0	83	52954.0	Y
7	1	1.0	918.0	58	53244.0	Y
8	1	1.0	838.0	63	52794.0	Y
9	1	1.0	858.0	62	53196.0	Y
10	1	1.0	798.0	67	53466.0	Y
11	1	1.0	718.0	74	53132.0	Y
12	1	1.0	578.0	92	53176.0	Y
13	1	1.0	598.0	89	53222.0	Y
14	1	1.0	558.0	95	53010.0	Y
15	1	1.0	2536.0	21	53256.0	Y
16	1	1.0	966.0	55	53130.0	Y
17	1	1.0	827.0	64	52928.0	Y
18	1	1.0	2501.0	22	55022.0	Y
19	1	1.0	2595.0	21	54495.0	Y
20	1	1.0	1114.0	48	53472.0	Y
21	1	1.0	1302.0	41	53382.0	Y
22	1	1.0	3045.0	18	54810.0	Y
23	1	1.0	1624.0	33	53592.0	Y
24	1	1.0	2878.0	19	54682.0	Y
25	1	1.0	1027.0	52	53404.0	Y
26	1	1.0	2485.0	22	54670.0	Y
27	1	1.0	1600.0	33	52800.0	Y
28	1	1.0	1172.0	46	53912.0	Y
29	1	1.0	1177.0	45	52965.0	Y

Detection rate: 100%

**5270MHZ, Radar 2**

Trial Id	Radar Type	Pulse Width(μ s)	PRI (μ s)	Number of Pulses	Waveform Length (μ s)	conclusion
0	2	3.2	179.0	26	4654.0	Y
1	2	1.1	207.0	23	4761.0	Y
2	2	2.1	230.0	24	5520.0	Y
3	2	4.8	200.0	29	5800.0	Y
4	2	3.9	214.0	28	5992.0	Y
5	2	2.9	222.0	26	5772.0	Y
6	2	3.2	204.0	26	5304.0	Y
7	2	2.5	192.0	25	4800.0	Y
8	2	3.1	164.0	26	4264.0	Y
9	2	1.2	156.0	23	3588.0	Y
10	2	3.9	210.0	27	5670.0	Y
11	2	4.6	201.0	29	5829.0	Y
12	2	3.2	162.0	26	4212.0	Y
13	2	2.2	197.0	25	4925.0	Y
14	2	4.5	163.0	29	4727.0	Y
15	2	3.0	203.0	26	5278.0	Y
16	2	5.0	168.0	29	4872.0	Y
17	2	2.4	217.0	25	5425.0	Y
18	2	2.9	191.0	26	4966.0	Y
19	2	2.3	166.0	25	4150.0	Y
20	2	3.7	150.0	27	4050.0	Y
21	2	2.2	176.0	25	4400.0	Y
22	2	4.9	195.0	29	5655	Y
23	2	2.9	202.0	26	5252.0	Y
24	2	2.5	178.0	25	4450.0	Y
25	2	1.1	206.0	23	4738.0	Y
26	2	3.8	155.0	27	4185.0	Y
27	2	4.7	157.0	29	4553.0	Y
28	2	2.4	224.0	25	5600.0	Y
29	2	4.2	159.0	28	4452.0	Y

Detection rate: 100%

**5270MHZ, Radar 3**

Trial Id	Radar Type	Pulse Width(μ s)	PRI (μ s)	Number of Pulses	Waveform Length (μ s)	conclusion
0	3	8.2	355.0	17	6035.0	Y
1	3	6.1	487.0	16	7792.0	Y
2	3	7.1	344.0	16	5504.0	Y
3	3	9.8	288.0	18	5184.0	Y
4	3	8.9	230.0	18	4140.0	Y
5	3	7.9	432.0	17	7344.0	Y
6	3	8.2	207.0	17	3519.0	Y
7	3	7.5	443.0	17	7531.0	Y
8	3	8.1	439.0	17	7463.0	Y
9	3	6.2	223.0	16	3568.0	Y
10	3	8.9	208.0	18	3744.0	Y
11	3	9.6	463.0	18	8334.0	Y
12	3	8.2	441.0	17	7497.0	Y
13	3	7.2	323.0	16	5168.0	Y
14	3	9.5	297.0	18	5346.0	Y
15	3	8.0	412.0	17	7004.0	Y
16	3	10.0	324.0	18	5832.0	Y
17	3	7.4	271.0	17	4607.0	Y
18	3	7.9	349.0	17	5933.0	Y
19	3	7.3	409.0	16	6544.0	Y
20	3	8.7	373.0	18	6714.0	Y
21	3	7.2	254.0	16	4064.0	Y
22	3	9.9	274.0	18	4932.0	Y
23	3	7.9	278.0	17	4726.0	Y
24	3	7.5	317.0	17	5389.0	Y
25	3	6.1	260.0	16	4160.0	Y
26	3	8.8	211.0	18	3798.0	Y
27	3	9.7	272.0	18	4896.0	Y
28	3	7.4	264.0	17	4488.0	Y
29	3	9.2	284.0	18	5112.0	Y

Detection rate: 100%

**5270MHZ, Radar 4**

Trial Id	Radar Type	Pulse Width(μ s)	PRI (μ s)	Number of Pulses	Waveform Length (μ s)	conclusion
0	4	16.0	355.0	14	4970.0	Y
1	4	11.3	487.0	12	5844.0	Y
2	4	13.5	344.0	13	4472.0	Y
3	4	19.4	288.0	16	4608.0	Y
4	4	17.5	230.0	15	3450.0	Y
5	4	15.3	432.0	14	6048.0	Y
6	4	15.9	207.0	14	2898.0	Y
7	4	14.3	443.0	13	5759.0	Y
8	4	15.8	439.0	14	6146.0	Y
9	4	11.5	223.0	12	2676.0	Y
10	4	17.4	208.0	15	3120.0	Y
11	4	19.0	463.0	16	7408.0	Y
12	4	16.0	441.0	14	6174.0	Y
13	4	13.8	323.0	13	4199.0	Y
14	4	18.9	297.0	16	4752.0	Y
15	4	15.5	412.0	14	5768.0	Y
16	4	19.9	324.0	16	5184.0	Y
17	4	14.1	271.0	13	3523.0	Y
18	4	15.2	349.0	14	4886.0	Y
19	4	13.8	409.0	13	5317.0	Y
20	4	17.1	373.0	15	5595.0	Y
21	4	13.8	254.0	13	3302.0	Y
22	4	19.8	274.0	16	4384.0	Y
23	4	15.3	278.0	14	3892.0	Y
24	4	14.5	317.0	13	4121.0	Y
25	4	11.3	260.0	12	3120.0	Y
26	4	17.3	211.0	15	3165.0	Y
27	4	19.2	272.0	16	4352.0	Y
28	4	14.2	264.0	13	3432.0	Y
29	4	18.2	284.0	15	4260.0	Y

Detection rate: 100%

**5270MHZ, Radar 5**

Trial Id	Radar Type	Number of Pulses	Chip Width (MHz)	Burst Period (s)	Waveform Length (μ s)	Center Frequency (MHz)	conclusion
0	5	15	13	0.8000000	12.0	5.2700	Y
1	5	8	19	1.5000000	12.0	5.2700	Y
2	5	11	11	1.0909091	12.0	5.2700	Y
3	5	20	12	0.6000000	12.0	5.2700	Y
4	5	17	6	0.7058824	12.0	5.2700	Y
5	5	14	15	0.8571429	12.0	5.2700	Y
6	5	15	16	0.8000000	12.0	5.2700	Y
7	5	12	17	1.0000000	12.0	5.2700	Y
8	5	14	19	0.8571429	12.0	5.2700	Y
9	5	8	12	1.5000000	12.0	5.2700	Y
10	5	17	7	0.7058824	12.0	5.2564	Y
11	5	19	11	0.6315789	12.0	5.2576	Y
12	5	15	14	0.8000000	12.0	5.2552	Y
13	5	12	16	1.0000000	12.0	5.2540	Y
14	5	19	9	0.6315789	12.0	5.2572	Y
15	5	14	16	0.8571429	12.0	5.2548	Y
16	5	20	13	0.6000000	12.0	5.2580	Y
17	5	12	7	1.0000000	12.0	5.2540	Y
18	5	14	10	0.8571429	12.0	5.2548	Y
19	5	12	19	1.0000000	12.0	5.2540	Y
20	5	16	12	0.7500000	12.0	5.2840	Y
21	5	12	14	1.0000000	12.0	5.2864	Y
22	5	20	9	0.6000000	12.0	5.2820	N
23	5	14	14	0.8571429	12.0	5.2852	Y
24	5	13	6	0.9230769	12.0	5.2856	Y
25	5	8	7	1.5000000	12.0	5.2880	Y
26	5	17	18	0.7058824	12.0	5.2836	Y
27	5	19	16	0.6315789	12.0	5.2824	Y
28	5	12	17	1.0000000	12.0	5.2860	Y
29	5	18	16	0.6666667	12.0	5.2832	Y

Detection rate: 97%

**5270MHZ, Radar 6**

Trial Id	Radar Type	Pulse Width(μ s)	PRI (μ s)	Pulses Per Hop	Hopping Rate (kHz)	Hopping Sequence Length (ms)	Visible Frequency Number	conclusion
0	6	1.0	333.3	9	0.3333	300.00	33	Y
1	6	1.0	333.3	9	0.3333	300.00	29	Y
2	6	1.0	333.3	9	0.3333	300.00	28	Y
3	6	1.0	333.3	9	0.3333	300.00	35	Y
4	6	1.0	333.3	9	0.3333	300.00	35	Y
5	6	1.0	333.3	9	0.3333	300.00	31	Y
6	6	1.0	333.3	9	0.3333	300.00	33	Y
7	6	1.0	333.3	9	0.3333	300.00	29	Y
8	6	1.0	333.3	9	0.3333	300.00	33	Y
9	6	1.0	333.3	9	0.3333	300.00	32	Y
10	6	1.0	333.3	9	0.3333	300.00	36	Y
11	6	1.0	333.3	9	0.3333	300.00	40	Y
12	6	1.0	333.3	9	0.3333	300.00	37	Y
13	6	1.0	333.3	9	0.3333	300.00	34	Y
14	6	1.0	333.3	9	0.3333	300.00	31	Y
15	6	1.0	333.3	9	0.3333	300.00	39	Y
16	6	1.0	333.3	9	0.3333	300.00	35	Y
17	6	1.0	333.3	9	0.3333	300.00	36	Y
18	6	1.0	333.3	9	0.3333	300.00	29	Y
19	6	1.0	333.3	9	0.3333	300.00	32	Y
20	6	1.0	333.3	9	0.3333	300.00	35	Y
21	6	1.0	333.3	9	0.3333	300.00	38	Y
22	6	1.0	333.3	9	0.3333	300.00	40	Y
23	6	1.0	333.3	9	0.3333	300.00	37	Y
24	6	1.0	333.3	9	0.3333	300.00	31	Y
25	6	1.0	333.3	9	0.3333	300.00	33	Y
26	6	1.0	333.3	9	0.3333	300.00	29	Y
27	6	1.0	333.3	9	0.3333	300.00	35	Y
28	6	1.0	333.3	9	0.3333	300.00	32	Y
29	6	1.0	333.3	9	0.3333	300.00	37	Y
Detection rate: 100%								

**5290MHZ, Radar 1**

Trial Id	Radar Type	Pulse Width(μ s)	PRI (μ s)	Number of Pulses	Waveform Length (μ s)	conclusion
0	1	1.0	938.0	57	53466.0	Y
1	1	1.0	698.0	76	53048.0	Y
2	1	1.0	618.0	86	53148.0	Y
3	1	1.0	538.0	99	53262.0	Y
4	1	1.0	878.0	61	53558.0	Y
5	1	1.0	3066.0	18	55188.0	Y
6	1	1.0	638.0	83	52954.0	Y
7	1	1.0	918.0	58	53244.0	Y
8	1	1.0	838.0	63	52794.0	Y
9	1	1.0	858.0	62	53196.0	Y
10	1	1.0	798.0	67	53466.0	Y
11	1	1.0	718.0	74	53132.0	Y
12	1	1.0	578.0	92	53176.0	Y
13	1	1.0	598.0	89	53222.0	Y
14	1	1.0	558.0	95	53010.0	Y
15	1	1.0	2536.0	21	53256.0	Y
16	1	1.0	966.0	55	53130.0	Y
17	1	1.0	827.0	64	52928.0	Y
18	1	1.0	2501.0	22	55022.0	Y
19	1	1.0	2595.0	21	54495.0	Y
20	1	1.0	1114.0	48	53472.0	Y
21	1	1.0	1302.0	41	53382.0	Y
22	1	1.0	3045.0	18	54810.0	Y
23	1	1.0	1624.0	33	53592.0	Y
24	1	1.0	2878.0	19	54682.0	Y
25	1	1.0	1027.0	52	53404.0	Y
26	1	1.0	2485.0	22	54670.0	Y
27	1	1.0	1600.0	33	52800.0	Y
28	1	1.0	1172.0	46	53912.0	Y
29	1	1.0	1177.0	45	52965.0	Y

Detection rate: 100%

**5290MHZ, Radar 2**

Trial Id	Radar Type	Pulse Width(μ s)	PRI (μ s)	Number of Pulses	Waveform Length (μ s)	conclusion
0	2	3.2	179.0	26	4654.0	Y
1	2	1.1	207.0	23	4761.0	Y
2	2	2.1	230.0	24	5520.0	Y
3	2	4.8	200.0	29	5800.0	Y
4	2	3.9	214.0	28	5992.0	Y
5	2	2.9	222.0	26	5772.0	Y
6	2	3.2	204.0	26	5304.0	Y
7	2	2.5	192.0	25	4800.0	Y
8	2	3.1	164.0	26	4264.0	Y
9	2	1.2	156.0	23	3588.0	Y
10	2	3.9	210.0	27	5670.0	Y
11	2	4.6	201.0	29	5829.0	Y
12	2	3.2	162.0	26	4212.0	Y
13	2	2.2	197.0	25	4925.0	Y
14	2	4.5	163.0	29	4727.0	Y
15	2	3.0	203.0	26	5278.0	Y
16	2	5.0	168.0	29	4872.0	Y
17	2	2.4	217.0	25	5425.0	Y
18	2	2.9	191.0	26	4966.0	Y
19	2	2.3	166.0	25	4150.0	Y
20	2	3.7	150.0	27	4050.0	Y
21	2	2.2	176.0	25	4400.0	Y
22	2	4.9	195.0	29	5655	Y
23	2	2.9	202.0	26	5252.0	Y
24	2	2.5	178.0	25	4450.0	Y
25	2	1.1	206.0	23	4738.0	Y
26	2	3.8	155.0	27	4185.0	Y
27	2	4.7	157.0	29	4553.0	Y
28	2	2.4	224.0	25	5600.0	Y
29	2	4.2	159.0	28	4452.0	Y

Detection rate: 100%

**5290MHZ, Radar 3**

Trial Id	Radar Type	Pulse Width(μ s)	PRI (μ s)	Number of Pulses	Waveform Length (μ s)	conclusion
0	3	8.2	355.0	17	6035.0	Y
1	3	6.1	487.0	16	7792.0	Y
2	3	7.1	344.0	16	5504.0	Y
3	3	9.8	288.0	18	5184.0	Y
4	3	8.9	230.0	18	4140.0	Y
5	3	7.9	432.0	17	7344.0	Y
6	3	8.2	207.0	17	3519.0	Y
7	3	7.5	443.0	17	7531.0	Y
8	3	8.1	439.0	17	7463.0	Y
9	3	6.2	223.0	16	3568.0	Y
10	3	8.9	208.0	18	3744.0	Y
11	3	9.6	463.0	18	8334.0	Y
12	3	8.2	441.0	17	7497.0	Y
13	3	7.2	323.0	16	5168.0	Y
14	3	9.5	297.0	18	5346.0	Y
15	3	8.0	412.0	17	7004.0	Y
16	3	10.0	324.0	18	5832.0	Y
17	3	7.4	271.0	17	4607.0	Y
18	3	7.9	349.0	17	5933.0	Y
19	3	7.3	409.0	16	6544.0	Y
20	3	8.7	373.0	18	6714.0	Y
21	3	7.2	254.0	16	4064.0	Y
22	3	9.9	274.0	18	4932.0	Y
23	3	7.9	278.0	17	4726.0	Y
24	3	7.5	317.0	17	5389.0	N
25	3	6.1	260.0	16	4160.0	Y
26	3	8.8	211.0	18	3798.0	Y
27	3	9.7	272.0	18	4896.0	Y
28	3	7.4	264.0	17	4488.0	Y
29	3	9.2	284.0	18	5112.0	Y

Detection rate: 97%

**5290MHZ, Radar 4**

Trial Id	Radar Type	Pulse Width(μ s)	PRI (μ s)	Number of Pulses	Waveform Length (μ s)	conclusion
0	4	16.0	355.0	14	4970.0	Y
1	4	11.3	487.0	12	5844.0	Y
2	4	13.5	344.0	13	4472.0	Y
3	4	19.4	288.0	16	4608.0	Y
4	4	17.5	230.0	15	3450.0	Y
5	4	15.3	432.0	14	6048.0	Y
6	4	15.9	207.0	14	2898.0	Y
7	4	14.3	443.0	13	5759.0	Y
8	4	15.8	439.0	14	6146.0	Y
9	4	11.5	223.0	12	2676.0	Y
10	4	17.4	208.0	15	3120.0	Y
11	4	19.0	463.0	16	7408.0	Y
12	4	16.0	441.0	14	6174.0	Y
13	4	13.8	323.0	13	4199.0	Y
14	4	18.9	297.0	16	4752.0	Y
15	4	15.5	412.0	14	5768.0	Y
16	4	19.9	324.0	16	5184.0	Y
17	4	14.1	271.0	13	3523.0	Y
18	4	15.2	349.0	14	4886.0	Y
19	4	13.8	409.0	13	5317.0	Y
20	4	17.1	373.0	15	5595.0	Y
21	4	13.8	254.0	13	3302.0	Y
22	4	19.8	274.0	16	4384.0	Y
23	4	15.3	278.0	14	3892.0	Y
24	4	14.5	317.0	13	4121.0	Y
25	4	11.3	260.0	12	3120.0	Y
26	4	17.3	211.0	15	3165.0	Y
27	4	19.2	272.0	16	4352.0	Y
28	4	14.2	264.0	13	3432.0	Y
29	4	18.2	284.0	15	4260.0	Y

Detection rate: 100%

**5290MHZ, Radar 5**

Trial Id	Radar Type	Number of Pulses	Chirp Width (MHZ)	Burst Period (s)	Waveform Length (μ s)	Center Frequency (MHZ)	conclusion
0	5	13	72	0.8000000	12.0	5.290	Y
1	5	19	72	1.5000000	12.0	5.258	Y
2	5	11	72	1.0909091	12.0	5.261	Y
3	5	12	72	0.6000000	12.0	5.259	Y
4	5	6	72	0.7058824	12.0	5.262	Y
5	5	15	72	0.8571429	12.0	5.258	Y
6	5	16	72	0.8000000	12.0	5.259	Y
7	5	17	72	1.0000000	12.0	5.258	Y
8	5	19	72	0.8571429	12.0	5.320	Y
9	5	12	72	1.5000000	12.0	5.322	Y
10	5	7	72	0.7058824	12.0	5.318	Y
11	5	11	72	0.6315789	12.0	5.321	Y
12	5	14	72	0.8000000	12.0	5.322	Y
13	5	16	72	1.0000000	12.0	5.324	Y
14	5	9	72	0.6315789	12.0	5.320	Y
15	5	16	72	0.8571429	12.0	5.318	Y
16	5	13	72	0.6000000	12.0	5.322	Y
17	5	7	72	1.0000000	12.0	5.319	Y
18	5	10	72	0.8571429	12.0	5.290	Y
19	5	19	72	1.0000000	12.0	5.258	Y
20	5	12	72	0.7500000	12.0	5.261	Y
21	5	14	72	1.0000000	12.0	5.259	Y
22	5	9	72	0.6000000	12.0	5.262	Y
23	5	14	72	0.8571429	12.0	5.258	Y
24	5	6	72	0.9230769	12.0	5.259	Y
25	5	7	72	1.5000000	12.0	5.258	Y
26	5	18	72	0.7058824	12.0	5.320	Y
27	5	16	72	0.6315789	12.0	5.322	Y
28	5	17	72	1.0000000	12.0	5.318	Y
29	5	16	72	0.6666667	12.0	5.321	Y

Detection rate: 100%

**5290MHZ, Radar 6**

Trial Id	Radar Type	Pulse Width(μ s)	PRI (μ s)	Pulses Per Hop	Hopping Rate (kHz)	Hopping Sequence Length (ms)	Visible Frequency Number	conclusion
0	6	1.0	333.3	9	0.3333	300.00	33	Y
1	6	1.0	333.3	9	0.3333	300.00	29	Y
2	6	1.0	333.3	9	0.3333	300.00	28	Y
3	6	1.0	333.3	9	0.3333	300.00	35	Y
4	6	1.0	333.3	9	0.3333	300.00	35	Y
5	6	1.0	333.3	9	0.3333	300.00	31	Y
6	6	1.0	333.3	9	0.3333	300.00	33	Y
7	6	1.0	333.3	9	0.3333	300.00	29	Y
8	6	1.0	333.3	9	0.3333	300.00	33	Y
9	6	1.0	333.3	9	0.3333	300.00	32	Y
10	6	1.0	333.3	9	0.3333	300.00	36	Y
11	6	1.0	333.3	9	0.3333	300.00	40	Y
12	6	1.0	333.3	9	0.3333	300.00	37	Y
13	6	1.0	333.3	9	0.3333	300.00	34	Y
14	6	1.0	333.3	9	0.3333	300.00	31	Y
15	6	1.0	333.3	9	0.3333	300.00	39	Y
16	6	1.0	333.3	9	0.3333	300.00	35	Y
17	6	1.0	333.3	9	0.3333	300.00	36	Y
18	6	1.0	333.3	9	0.3333	300.00	29	Y
19	6	1.0	333.3	9	0.3333	300.00	32	Y
20	6	1.0	333.3	9	0.3333	300.00	35	Y
21	6	1.0	333.3	9	0.3333	300.00	38	Y
22	6	1.0	333.3	9	0.3333	300.00	40	Y
23	6	1.0	333.3	9	0.3333	300.00	37	Y
24	6	1.0	333.3	9	0.3333	300.00	31	Y
25	6	1.0	333.3	9	0.3333	300.00	33	Y
26	6	1.0	333.3	9	0.3333	300.00	29	Y
27	6	1.0	333.3	9	0.3333	300.00	35	Y
28	6	1.0	333.3	9	0.3333	300.00	32	Y
29	6	1.0	333.3	9	0.3333	300.00	37	Y

Detection rate: 100%

**5300MHZ, Radar 1**

Trial Id	Radar Type	Pulse Width(μ s)	PRI (μ s)	Number of Pulses	Waveform Length (μ s)	conclusion
0	1	1.0	938.0	57	53466.0	Y
1	1	1.0	698.0	76	53048.0	Y
2	1	1.0	618.0	86	53148.0	Y
3	1	1.0	538.0	99	53262.0	Y
4	1	1.0	878.0	61	53558.0	Y
5	1	1.0	3066.0	18	55188.0	Y
6	1	1.0	638.0	83	52954.0	Y
7	1	1.0	918.0	58	53244.0	Y
8	1	1.0	838.0	63	52794.0	Y
9	1	1.0	858.0	62	53196.0	Y
10	1	1.0	798.0	67	53466.0	Y
11	1	1.0	718.0	74	53132.0	Y
12	1	1.0	578.0	92	53176.0	Y
13	1	1.0	598.0	89	53222.0	Y
14	1	1.0	558.0	95	53010.0	Y
15	1	1.0	2536.0	21	53256.0	Y
16	1	1.0	966.0	55	53130.0	Y
17	1	1.0	827.0	64	52928.0	Y
18	1	1.0	2501.0	22	55022.0	Y
19	1	1.0	2595.0	21	54495.0	Y
20	1	1.0	1114.0	48	53472.0	Y
21	1	1.0	1302.0	41	53382.0	Y
22	1	1.0	3045.0	18	54810.0	Y
23	1	1.0	1624.0	33	53592.0	Y
24	1	1.0	2878.0	19	54682.0	Y
25	1	1.0	1027.0	52	53404.0	Y
26	1	1.0	2485.0	22	54670.0	Y
27	1	1.0	1600.0	33	52800.0	Y
28	1	1.0	1172.0	46	53912.0	Y
29	1	1.0	1177.0	45	52965.0	Y

Detection rate: 100%

**5300MHZ, Radar 2**

Trial Id	Radar Type	Pulse Width(μ s)	PRI (μ s)	Number of Pulses	Waveform Length (μ s)	conclusion
0	2	3.2	179.0	26	4654.0	Y
1	2	1.1	207.0	23	4761.0	Y
2	2	2.1	230.0	24	5520.0	Y
3	2	4.8	200.0	29	5800.0	Y
4	2	3.9	214.0	28	5992.0	Y
5	2	2.9	222.0	26	5772.0	Y
6	2	3.2	204.0	26	5304.0	Y
7	2	2.5	192.0	25	4800.0	Y
8	2	3.1	164.0	26	4264.0	Y
9	2	1.2	156.0	23	3588.0	Y
10	2	3.9	210.0	27	5670.0	Y
11	2	4.6	201.0	29	5829.0	Y
12	2	3.2	162.0	26	4212.0	Y
13	2	2.2	197.0	25	4925.0	Y
14	2	4.5	163.0	29	4727.0	Y
15	2	3.0	203.0	26	5278.0	Y
16	2	5.0	168.0	29	4872.0	Y
17	2	2.4	217.0	25	5425.0	Y
18	2	2.9	191.0	26	4966.0	Y
19	2	2.3	166.0	25	4150.0	Y
20	2	3.7	150.0	27	4050.0	Y
21	2	2.2	176.0	25	4400.0	Y
22	2	4.9	195.0	29	5655	Y
23	2	2.9	202.0	26	5252.0	Y
24	2	2.5	178.0	25	4450.0	Y
25	2	1.1	206.0	23	4738.0	Y
26	2	3.8	155.0	27	4185.0	Y
27	2	4.7	157.0	29	4553.0	Y
28	2	2.4	224.0	25	5600.0	Y
29	2	4.2	159.0	28	4452.0	Y

Detection rate: 100%

**5300MHZ, Radar 3**

Trial Id	Radar Type	Pulse Width(μ s)	PRI (μ s)	Number of Pulses	Waveform Length (μ s)	conclusion
0	3	8.2	355.0	17	6035.0	Y
1	3	6.1	487.0	16	7792.0	Y
2	3	7.1	344.0	16	5504.0	Y
3	3	9.8	288.0	18	5184.0	Y
4	3	8.9	230.0	18	4140.0	Y
5	3	7.9	432.0	17	7344.0	Y
6	3	8.2	207.0	17	3519.0	Y
7	3	7.5	443.0	17	7531.0	Y
8	3	8.1	439.0	17	7463.0	Y
9	3	6.2	223.0	16	3568.0	Y
10	3	8.9	208.0	18	3744.0	Y
11	3	9.6	463.0	18	8334.0	Y
12	3	8.2	441.0	17	7497.0	Y
13	3	7.2	323.0	16	5168.0	Y
14	3	9.5	297.0	18	5346.0	Y
15	3	8.0	412.0	17	7004.0	Y
16	3	10.0	324.0	18	5832.0	Y
17	3	7.4	271.0	17	4607.0	Y
18	3	7.9	349.0	17	5933.0	Y
19	3	7.3	409.0	16	6544.0	Y
20	3	8.7	373.0	18	6714.0	Y
21	3	7.2	254.0	16	4064.0	Y
22	3	9.9	274.0	18	4932.0	Y
23	3	7.9	278.0	17	4726.0	Y
24	3	7.5	317.0	17	5389.0	Y
25	3	6.1	260.0	16	4160.0	Y
26	3	8.8	211.0	18	3798.0	Y
27	3	9.7	272.0	18	4896.0	Y
28	3	7.4	264.0	17	4488.0	Y
29	3	9.2	284.0	18	5112.0	Y

Detection rate: 100%

**5300MHZ, Radar 4**

Trial Id	Radar Type	Pulse Width(μ s)	PRI (μ s)	Number of Pulses	Waveform Length (μ s)	conclusion
0	4	16.0	355.0	14	4970.0	Y
1	4	11.3	487.0	12	5844.0	Y
2	4	13.5	344.0	13	4472.0	Y
3	4	19.4	288.0	16	4608.0	Y
4	4	17.5	230.0	15	3450.0	Y
5	4	15.3	432.0	14	6048.0	Y
6	4	15.9	207.0	14	2898.0	Y
7	4	14.3	443.0	13	5759.0	Y
8	4	15.8	439.0	14	6146.0	Y
9	4	11.5	223.0	12	2676.0	Y
10	4	17.4	208.0	15	3120.0	Y
11	4	19.0	463.0	16	7408.0	Y
12	4	16.0	441.0	14	6174.0	Y
13	4	13.8	323.0	13	4199.0	Y
14	4	18.9	297.0	16	4752.0	Y
15	4	15.5	412.0	14	5768.0	Y
16	4	19.9	324.0	16	5184.0	Y
17	4	14.1	271.0	13	3523.0	Y
18	4	15.2	349.0	14	4886.0	Y
19	4	13.8	409.0	13	5317.0	Y
20	4	17.1	373.0	15	5595.0	Y
21	4	13.8	254.0	13	3302.0	Y
22	4	19.8	274.0	16	4384.0	Y
23	4	15.3	278.0	14	3892.0	Y
24	4	14.5	317.0	13	4121.0	Y
25	4	11.3	260.0	12	3120.0	Y
26	4	17.3	211.0	15	3165.0	Y
27	4	19.2	272.0	16	4352.0	Y
28	4	14.2	264.0	13	3432.0	Y
29	4	18.2	284.0	15	4260.0	Y
Detection rate: 100%						

**5300MHZ, Radar 5**

Trial Id	Radar Type	Number of Pulses	Chirp Width (MHz)	Burst Period (s)	Waveform Length (μ s)	Center Frequency (MHZ)	conclusion
0	5	15	13	0.8000000	12.0	5.3000	Y
1	5	8	19	1.5000000	12.0	5.3000	Y
2	5	11	11	1.0909091	12.0	5.3000	Y
3	5	20	12	0.6000000	12.0	5.3000	Y
4	5	17	6	0.7058824	12.0	5.3000	Y
5	5	14	15	0.8571429	12.0	5.3000	Y
6	5	15	16	0.8000000	12.0	5.3000	Y
7	5	12	17	1.0000000	12.0	5.3000	Y
8	5	14	19	0.8571429	12.0	5.3000	Y
9	5	8	12	1.5000000	12.0	5.3000	Y
10	5	17	7	0.7058824	12.0	5.2964	Y
11	5	19	11	0.6315789	12.0	5.2976	Y
12	5	15	14	0.8000000	12.0	5.2952	N
13	5	12	16	1.0000000	12.0	5.2940	Y
14	5	19	9	0.6315789	12.0	5.2972	Y
15	5	14	16	0.8571429	12.0	5.2948	N
16	5	20	13	0.6000000	12.0	5.2980	Y
17	5	12	7	1.0000000	12.0	5.2940	Y
18	5	14	10	0.8571429	12.0	5.2948	Y
19	5	12	19	1.0000000	12.0	5.2940	Y
20	5	16	12	0.7500000	12.0	5.3040	Y
21	5	12	14	1.0000000	12.0	5.3064	Y
22	5	20	9	0.6000000	12.0	5.3020	Y
23	5	14	14	0.8571429	12.0	5.3052	Y
24	5	13	6	0.9230769	12.0	5.3056	Y
25	5	8	7	1.5000000	12.0	5.3080	Y
26	5	17	18	0.7058824	12.0	5.3036	Y
27	5	19	16	0.6315789	12.0	5.3024	Y
28	5	12	17	1.0000000	12.0	5.3060	Y
29	5	18	16	0.6666667	12.0	5.3032	Y

Detection rate: 94%

**5300MHZ, Radar 6**

Trial Id	Radar Type	Pulse Width(μ s)	PRI (μ s)	Pulses Per Hop	Hopping Rate (kHz)	Hopping Sequence Length (ms)	Visible Frequency Number	conclusion
0	6	1.0	333.3	9	0.3333	300.00	33	Y
1	6	1.0	333.3	9	0.3333	300.00	29	Y
2	6	1.0	333.3	9	0.3333	300.00	28	Y
3	6	1.0	333.3	9	0.3333	300.00	35	Y
4	6	1.0	333.3	9	0.3333	300.00	35	Y
5	6	1.0	333.3	9	0.3333	300.00	31	Y
6	6	1.0	333.3	9	0.3333	300.00	33	Y
7	6	1.0	333.3	9	0.3333	300.00	29	Y
8	6	1.0	333.3	9	0.3333	300.00	33	Y
9	6	1.0	333.3	9	0.3333	300.00	32	Y
10	6	1.0	333.3	9	0.3333	300.00	36	Y
11	6	1.0	333.3	9	0.3333	300.00	40	Y
12	6	1.0	333.3	9	0.3333	300.00	37	Y
13	6	1.0	333.3	9	0.3333	300.00	34	Y
14	6	1.0	333.3	9	0.3333	300.00	31	Y
15	6	1.0	333.3	9	0.3333	300.00	39	Y
16	6	1.0	333.3	9	0.3333	300.00	35	Y
17	6	1.0	333.3	9	0.3333	300.00	36	Y
18	6	1.0	333.3	9	0.3333	300.00	29	Y
19	6	1.0	333.3	9	0.3333	300.00	32	Y
20	6	1.0	333.3	9	0.3333	300.00	35	Y
21	6	1.0	333.3	9	0.3333	300.00	38	Y
22	6	1.0	333.3	9	0.3333	300.00	40	Y
23	6	1.0	333.3	9	0.3333	300.00	37	Y
24	6	1.0	333.3	9	0.3333	300.00	31	Y
25	6	1.0	333.3	9	0.3333	300.00	33	Y
26	6	1.0	333.3	9	0.3333	300.00	29	Y
27	6	1.0	333.3	9	0.3333	300.00	35	Y
28	6	1.0	333.3	9	0.3333	300.00	32	Y
29	6	1.0	333.3	9	0.3333	300.00	37	Y

Detection rate: 100%

**5500MHZ, Radar 1**

Trial Id	Radar Type	Pulse Width(μ s)	PRI (μ s)	Number of Pulses	Waveform Length (μ s)	conclusion
0	1	1.0	938.0	57	53466.0	Y
1	1	1.0	698.0	76	53048.0	Y
2	1	1.0	618.0	86	53148.0	Y
3	1	1.0	538.0	99	53262.0	Y
4	1	1.0	878.0	61	53558.0	Y
5	1	1.0	3066.0	18	55188.0	Y
6	1	1.0	638.0	83	52954.0	Y
7	1	1.0	918.0	58	53244.0	Y
8	1	1.0	838.0	63	52794.0	Y
9	1	1.0	858.0	62	53196.0	Y
10	1	1.0	798.0	67	53466.0	Y
11	1	1.0	718.0	74	53132.0	Y
12	1	1.0	578.0	92	53176.0	Y
13	1	1.0	598.0	89	53222.0	Y
14	1	1.0	558.0	95	53010.0	Y
15	1	1.0	2536.0	21	53256.0	Y
16	1	1.0	966.0	55	53130.0	Y
17	1	1.0	827.0	64	52928.0	Y
18	1	1.0	2501.0	22	55022.0	Y
19	1	1.0	2595.0	21	54495.0	Y
20	1	1.0	1114.0	48	53472.0	Y
21	1	1.0	1302.0	41	53382.0	Y
22	1	1.0	3045.0	18	54810.0	Y
23	1	1.0	1624.0	33	53592.0	Y
24	1	1.0	2878.0	19	54682.0	Y
25	1	1.0	1027.0	52	53404.0	Y
26	1	1.0	2485.0	22	54670.0	Y
27	1	1.0	1600.0	33	52800.0	Y
28	1	1.0	1172.0	46	53912.0	Y
29	1	1.0	1177.0	45	52965.0	Y

Detection rate: 100%

**5500MHZ, Radar 2**

Trial Id	Radar Type	Pulse Width(μ s)	PRI (μ s)	Number of Pulses	Waveform Length (μ s)	conclusion
0	2	3.2	179.0	26	4654.0	Y
1	2	1.1	207.0	23	4761.0	Y
2	2	2.1	230.0	24	5520.0	Y
3	2	4.8	200.0	29	5800.0	Y
4	2	3.9	214.0	28	5992.0	Y
5	2	2.9	222.0	26	5772.0	Y
6	2	3.2	204.0	26	5304.0	Y
7	2	2.5	192.0	25	4800.0	Y
8	2	3.1	164.0	26	4264.0	Y
9	2	1.2	156.0	23	3588.0	Y
10	2	3.9	210.0	27	5670.0	Y
11	2	4.6	201.0	29	5829.0	Y
12	2	3.2	162.0	26	4212.0	Y
13	2	2.2	197.0	25	4925.0	Y
14	2	4.5	163.0	29	4727.0	Y
15	2	3.0	203.0	26	5278.0	Y
16	2	5.0	168.0	29	4872.0	Y
17	2	2.4	217.0	25	5425.0	Y
18	2	2.9	191.0	26	4966.0	Y
19	2	2.3	166.0	25	4150.0	Y
20	2	3.7	150.0	27	4050.0	Y
21	2	2.2	176.0	25	4400.0	Y
22	2	4.9	195.0	29	5655	Y
23	2	2.9	202.0	26	5252.0	Y
24	2	2.5	178.0	25	4450.0	Y
25	2	1.1	206.0	23	4738.0	Y
26	2	3.8	155.0	27	4185.0	Y
27	2	4.7	157.0	29	4553.0	Y
28	2	2.4	224.0	25	5600.0	Y
29	2	4.2	159.0	28	4452.0	Y

Detection rate: 100%

**5500MHZ, Radar 3**

Trial Id	Radar Type	Pulse Width(μ s)	PRI (μ s)	Number of Pulses	Waveform Length (μ s)	conclusion
0	3	8.2	355.0	17	6035.0	Y
1	3	6.1	487.0	16	7792.0	Y
2	3	7.1	344.0	16	5504.0	Y
3	3	9.8	288.0	18	5184.0	Y
4	3	8.9	230.0	18	4140.0	Y
5	3	7.9	432.0	17	7344.0	Y
6	3	8.2	207.0	17	3519.0	Y
7	3	7.5	443.0	17	7531.0	Y
8	3	8.1	439.0	17	7463.0	Y
9	3	6.2	223.0	16	3568.0	Y
10	3	8.9	208.0	18	3744.0	Y
11	3	9.6	463.0	18	8334.0	Y
12	3	8.2	441.0	17	7497.0	Y
13	3	7.2	323.0	16	5168.0	Y
14	3	9.5	297.0	18	5346.0	Y
15	3	8.0	412.0	17	7004.0	Y
16	3	10.0	324.0	18	5832.0	Y
17	3	7.4	271.0	17	4607.0	Y
18	3	7.9	349.0	17	5933.0	Y
19	3	7.3	409.0	16	6544.0	Y
20	3	8.7	373.0	18	6714.0	Y
21	3	7.2	254.0	16	4064.0	Y
22	3	9.9	274.0	18	4932.0	Y
23	3	7.9	278.0	17	4726.0	Y
24	3	7.5	317.0	17	5389.0	Y
25	3	6.1	260.0	16	4160.0	Y
26	3	8.8	211.0	18	3798.0	Y
27	3	9.7	272.0	18	4896.0	Y
28	3	7.4	264.0	17	4488.0	Y
29	3	9.2	284.0	18	5112.0	Y

Detection rate: 100%

**5500MHZ, Radar 4**

Trial Id	Radar Type	Pulse Width(μ s)	PRI (μ s)	Number of Pulses	Waveform Length (μ s)	conclusion
0	4	16.0	355.0	14	4970.0	Y
1	4	11.3	487.0	12	5844.0	Y
2	4	13.5	344.0	13	4472.0	Y
3	4	19.4	288.0	16	4608.0	Y
4	4	17.5	230.0	15	3450.0	Y
5	4	15.3	432.0	14	6048.0	Y
6	4	15.9	207.0	14	2898.0	Y
7	4	14.3	443.0	13	5759.0	Y
8	4	15.8	439.0	14	6146.0	Y
9	4	11.5	223.0	12	2676.0	Y
10	4	17.4	208.0	15	3120.0	Y
11	4	19.0	463.0	16	7408.0	Y
12	4	16.0	441.0	14	6174.0	Y
13	4	13.8	323.0	13	4199.0	Y
14	4	18.9	297.0	16	4752.0	Y
15	4	15.5	412.0	14	5768.0	Y
16	4	19.9	324.0	16	5184.0	Y
17	4	14.1	271.0	13	3523.0	Y
18	4	15.2	349.0	14	4886.0	Y
19	4	13.8	409.0	13	5317.0	Y
20	4	17.1	373.0	15	5595.0	Y
21	4	13.8	254.0	13	3302.0	Y
22	4	19.8	274.0	16	4384.0	Y
23	4	15.3	278.0	14	3892.0	Y
24	4	14.5	317.0	13	4121.0	Y
25	4	11.3	260.0	12	3120.0	Y
26	4	17.3	211.0	15	3165.0	Y
27	4	19.2	272.0	16	4352.0	Y
28	4	14.2	264.0	13	3432.0	Y
29	4	18.2	284.0	15	4260.0	Y

Detection rate: 100%

**5500MHZ, Radar 5**

Trial Id	Radar Type	Number of Pulses	Chirp Width (MHz)	Burst Period (s)	Waveform Length (μs)	Center Frequency (MHZ)	conclusion
0	5	15	13	0.8000000	12.0	5.5000	Y
1	5	8	19	1.5000000	12.0	5.5000	Y
2	5	11	11	1.0909091	12.0	5.5000	Y
3	5	20	12	0.6000000	12.0	5.5000	Y
4	5	17	6	0.7058824	12.0	5.5000	Y
5	5	14	15	0.8571429	12.0	5.5000	Y
6	5	15	16	0.8000000	12.0	5.5000	Y
7	5	12	17	1.0000000	12.0	5.5000	Y
8	5	14	19	0.8571429	12.0	5.5000	Y
9	5	8	12	1.5000000	12.0	5.5000	Y
10	5	17	7	0.7058824	12.0	5.4964	Y
11	5	19	11	0.6315789	12.0	5.4976	Y
12	5	15	14	0.8000000	12.0	5.4952	Y
13	5	12	16	1.0000000	12.0	5.4940	Y
14	5	19	9	0.6315789	12.0	5.4972	Y
15	5	14	16	0.8571429	12.0	5.4948	Y
16	5	20	13	0.6000000	12.0	5.4980	Y
17	5	12	7	1.0000000	12.0	5.4940	Y
18	5	14	10	0.8571429	12.0	5.4948	Y
19	5	12	19	1.0000000	12.0	5.4940	Y
20	5	16	12	0.7500000	12.0	5.5040	Y
21	5	12	14	1.0000000	12.0	5.5064	Y
22	5	20	9	0.6000000	12.0	5.5020	Y
23	5	14	14	0.8571429	12.0	5.5052	Y
24	5	13	6	0.9230769	12.0	5.5056	Y
25	5	8	7	1.5000000	12.0	5.5080	Y
26	5	17	18	0.7058824	12.0	5.5036	Y
27	5	19	16	0.6315789	12.0	5.5024	Y
28	5	12	17	1.0000000	12.0	5.5060	Y
29	5	18	16	0.6666667	12.0	5.5032	Y

Detection rate: 100%

**5500MHZ, Radar 6**

Trial Id	Radar Type	Pulse Width(μ s)	PRI (μ s)	Pulses Per Hop	Hopping Rate (kHz)	Hopping Sequence Length (ms)	Visible Frequency Number	conclusion
0	6	1.0	333.3	9	0.3333	300.00	33	Y
1	6	1.0	333.3	9	0.3333	300.00	29	Y
2	6	1.0	333.3	9	0.3333	300.00	28	Y
3	6	1.0	333.3	9	0.3333	300.00	35	Y
4	6	1.0	333.3	9	0.3333	300.00	35	Y
5	6	1.0	333.3	9	0.3333	300.00	31	Y
6	6	1.0	333.3	9	0.3333	300.00	33	Y
7	6	1.0	333.3	9	0.3333	300.00	29	Y
8	6	1.0	333.3	9	0.3333	300.00	33	Y
9	6	1.0	333.3	9	0.3333	300.00	32	Y
10	6	1.0	333.3	9	0.3333	300.00	36	Y
11	6	1.0	333.3	9	0.3333	300.00	40	Y
12	6	1.0	333.3	9	0.3333	300.00	37	Y
13	6	1.0	333.3	9	0.3333	300.00	34	Y
14	6	1.0	333.3	9	0.3333	300.00	31	Y
15	6	1.0	333.3	9	0.3333	300.00	39	Y
16	6	1.0	333.3	9	0.3333	300.00	35	Y
17	6	1.0	333.3	9	0.3333	300.00	36	Y
18	6	1.0	333.3	9	0.3333	300.00	29	Y
19	6	1.0	333.3	9	0.3333	300.00	32	Y
20	6	1.0	333.3	9	0.3333	300.00	35	Y
21	6	1.0	333.3	9	0.3333	300.00	38	Y
22	6	1.0	333.3	9	0.3333	300.00	40	Y
23	6	1.0	333.3	9	0.3333	300.00	37	Y
24	6	1.0	333.3	9	0.3333	300.00	31	Y
25	6	1.0	333.3	9	0.3333	300.00	33	Y
26	6	1.0	333.3	9	0.3333	300.00	29	Y
27	6	1.0	333.3	9	0.3333	300.00	35	Y
28	6	1.0	333.3	9	0.3333	300.00	32	Y
29	6	1.0	333.3	9	0.3333	300.00	37	Y

Detection rate: 100%

**5550MHZ, Radar 1**

Trial Id	Radar Type	Pulse Width(μ s)	PRI (μ s)	Number of Pulses	Waveform Length (μ s)	conclusion
0	1	1.0	938.0	57	53466.0	Y
1	1	1.0	698.0	76	53048.0	Y
2	1	1.0	618.0	86	53148.0	Y
3	1	1.0	538.0	99	53262.0	Y
4	1	1.0	878.0	61	53558.0	Y
5	1	1.0	3066.0	18	55188.0	Y
6	1	1.0	638.0	83	52954.0	Y
7	1	1.0	918.0	58	53244.0	Y
8	1	1.0	838.0	63	52794.0	Y
9	1	1.0	858.0	62	53196.0	Y
10	1	1.0	798.0	67	53466.0	Y
11	1	1.0	718.0	74	53132.0	Y
12	1	1.0	578.0	92	53176.0	Y
13	1	1.0	598.0	89	53222.0	Y
14	1	1.0	558.0	95	53010.0	Y
15	1	1.0	2536.0	21	53256.0	Y
16	1	1.0	966.0	55	53130.0	Y
17	1	1.0	827.0	64	52928.0	Y
18	1	1.0	2501.0	22	55022.0	Y
19	1	1.0	2595.0	21	54495.0	Y
20	1	1.0	1114.0	48	53472.0	Y
21	1	1.0	1302.0	41	53382.0	Y
22	1	1.0	3045.0	18	54810.0	Y
23	1	1.0	1624.0	33	53592.0	Y
24	1	1.0	2878.0	19	54682.0	Y
25	1	1.0	1027.0	52	53404.0	Y
26	1	1.0	2485.0	22	54670.0	Y
27	1	1.0	1600.0	33	52800.0	Y
28	1	1.0	1172.0	46	53912.0	Y
29	1	1.0	1177.0	45	52965.0	Y

Detection rate: 100%

**5550MHZ, Radar 2**

Trial Id	Radar Type	Pulse Width(μ s)	PRI (μ s)	Number of Pulses	Waveform Length (μ s)	conclusion
0	2	3.2	179.0	26	4654.0	Y
1	2	1.1	207.0	23	4761.0	Y
2	2	2.1	230.0	24	5520.0	Y
3	2	4.8	200.0	29	5800.0	Y
4	2	3.9	214.0	28	5992.0	Y
5	2	2.9	222.0	26	5772.0	Y
6	2	3.2	204.0	26	5304.0	Y
7	2	2.5	192.0	25	4800.0	Y
8	2	3.1	164.0	26	4264.0	Y
9	2	1.2	156.0	23	3588.0	Y
10	2	3.9	210.0	27	5670.0	Y
11	2	4.6	201.0	29	5829.0	Y
12	2	3.2	162.0	26	4212.0	Y
13	2	2.2	197.0	25	4925.0	Y
14	2	4.5	163.0	29	4727.0	Y
15	2	3.0	203.0	26	5278.0	Y
16	2	5.0	168.0	29	4872.0	Y
17	2	2.4	217.0	25	5425.0	Y
18	2	2.9	191.0	26	4966.0	Y
19	2	2.3	166.0	25	4150.0	Y
20	2	3.7	150.0	27	4050.0	Y
21	2	2.2	176.0	25	4400.0	Y
22	2	4.9	195.0	29	5655	Y
23	2	2.9	202.0	26	5252.0	Y
24	2	2.5	178.0	25	4450.0	Y
25	2	1.1	206.0	23	4738.0	Y
26	2	3.8	155.0	27	4185.0	Y
27	2	4.7	157.0	29	4553.0	Y
28	2	2.4	224.0	25	5600.0	Y
29	2	4.2	159.0	28	4452.0	Y

Detection rate: 100%

**5550MHZ, Radar 3**

Trial Id	Radar Type	Pulse Width(μ s)	PRI (μ s)	Number of Pulses	Waveform Length (μ s)	conclusion
0	3	8.2	355.0	17	6035.0	Y
1	3	6.1	487.0	16	7792.0	Y
2	3	7.1	344.0	16	5504.0	Y
3	3	9.8	288.0	18	5184.0	Y
4	3	8.9	230.0	18	4140.0	Y
5	3	7.9	432.0	17	7344.0	Y
6	3	8.2	207.0	17	3519.0	Y
7	3	7.5	443.0	17	7531.0	Y
8	3	8.1	439.0	17	7463.0	Y
9	3	6.2	223.0	16	3568.0	Y
10	3	8.9	208.0	18	3744.0	Y
11	3	9.6	463.0	18	8334.0	Y
12	3	8.2	441.0	17	7497.0	Y
13	3	7.2	323.0	16	5168.0	N
14	3	9.5	297.0	18	5346.0	Y
15	3	8.0	412.0	17	7004.0	Y
16	3	10.0	324.0	18	5832.0	Y
17	3	7.4	271.0	17	4607.0	Y
18	3	7.9	349.0	17	5933.0	Y
19	3	7.3	409.0	16	6544.0	Y
20	3	8.7	373.0	18	6714.0	Y
21	3	7.2	254.0	16	4064.0	Y
22	3	9.9	274.0	18	4932.0	Y
23	3	7.9	278.0	17	4726.0	Y
24	3	7.5	317.0	17	5389.0	Y
25	3	6.1	260.0	16	4160.0	Y
26	3	8.8	211.0	18	3798.0	Y
27	3	9.7	272.0	18	4896.0	Y
28	3	7.4	264.0	17	4488.0	Y
29	3	9.2	284.0	18	5112.0	Y

Detection rate: 97%

**5550MHZ, Radar 4**

Trial Id	Radar Type	Pulse Width(μ s)	PRI (μ s)	Number of Pulses	Waveform Length (μ s)	conclusion
0	4	16.0	355.0	14	4970.0	Y
1	4	11.3	487.0	12	5844.0	Y
2	4	13.5	344.0	13	4472.0	Y
3	4	19.4	288.0	16	4608.0	Y
4	4	17.5	230.0	15	3450.0	Y
5	4	15.3	432.0	14	6048.0	Y
6	4	15.9	207.0	14	2898.0	Y
7	4	14.3	443.0	13	5759.0	Y
8	4	15.8	439.0	14	6146.0	Y
9	4	11.5	223.0	12	2676.0	Y
10	4	17.4	208.0	15	3120.0	Y
11	4	19.0	463.0	16	7408.0	Y
12	4	16.0	441.0	14	6174.0	Y
13	4	13.8	323.0	13	4199.0	Y
14	4	18.9	297.0	16	4752.0	Y
15	4	15.5	412.0	14	5768.0	Y
16	4	19.9	324.0	16	5184.0	Y
17	4	14.1	271.0	13	3523.0	Y
18	4	15.2	349.0	14	4886.0	Y
19	4	13.8	409.0	13	5317.0	Y
20	4	17.1	373.0	15	5595.0	Y
21	4	13.8	254.0	13	3302.0	N
22	4	19.8	274.0	16	4384.0	Y
23	4	15.3	278.0	14	3892.0	Y
24	4	14.5	317.0	13	4121.0	Y
25	4	11.3	260.0	12	3120.0	Y
26	4	17.3	211.0	15	3165.0	Y
27	4	19.2	272.0	16	4352.0	Y
28	4	14.2	264.0	13	3432.0	Y
29	4	18.2	284.0	15	4260.0	Y

Detection rate: 97%

**5550MHZ, Radar 5**

Trial Id	Radar Type	Number of Pulses	Chirp Width (MHz)	Burst Period (s)	Waveform Length (μ s)	Center Frequency	conclusion
0	5	15	13	0.8000000	12.0	5.5500	Y
1	5	8	19	1.5000000	12.0	5.5500	Y
2	5	11	11	1.0909091	12.0	5.5500	Y
3	5	20	12	0.6000000	12.0	5.5500	Y
4	5	17	6	0.7058824	12.0	5.5500	Y
5	5	14	15	0.8571429	12.0	5.5500	Y
6	5	15	16	0.8000000	12.0	5.5500	Y
7	5	12	17	1.0000000	12.0	5.5500	Y
8	5	14	19	0.8571429	12.0	5.5500	Y
9	5	8	12	1.5000000	12.0	5.5500	Y
10	5	17	7	0.7058824	12.0	5.5364	Y
11	5	19	11	0.6315789	12.0	5.5376	Y
12	5	15	14	0.8000000	12.0	5.5352	Y
13	5	12	16	1.0000000	12.0	5.5340	Y
14	5	19	9	0.6315789	12.0	5.5372	Y
15	5	14	16	0.8571429	12.0	5.5348	Y
16	5	20	13	0.6000000	12.0	5.5380	Y
17	5	12	7	1.0000000	12.0	5.5340	Y
18	5	14	10	0.8571429	12.0	5.5348	Y
19	5	12	19	1.0000000	12.0	5.5340	Y
20	5	16	12	0.7500000	12.0	5.5640	Y
21	5	12	14	1.0000000	12.0	5.5664	Y
22	5	20	9	0.6000000	12.0	5.5620	Y
23	5	14	14	0.8571429	12.0	5.5652	Y
24	5	13	6	0.9230769	12.0	5.5656	Y
25	5	8	7	1.5000000	12.0	5.5680	Y
26	5	17	18	0.7058824	12.0	5.5636	Y
27	5	19	16	0.6315789	12.0	5.5624	Y
28	5	12	17	1.0000000	12.0	5.5660	Y
29	5	18	16	0.6666667	12.0	5.5632	Y

Detection rate: 100%

**5550MHZ, Radar 6**

Trial Id	Radar Type	Pulse Width(μ s)	PRI (μ s)	Pulses Per Hop	Hopping Rate (kHz)	Hopping Sequence Length (ms)	Visible Frequency Number	conclusion
0	6	1.0	333.3	9	0.3333	300.00	33	Y
1	6	1.0	333.3	9	0.3333	300.00	29	Y
2	6	1.0	333.3	9	0.3333	300.00	28	Y
3	6	1.0	333.3	9	0.3333	300.00	35	Y
4	6	1.0	333.3	9	0.3333	300.00	35	Y
5	6	1.0	333.3	9	0.3333	300.00	31	Y
6	6	1.0	333.3	9	0.3333	300.00	33	Y
7	6	1.0	333.3	9	0.3333	300.00	29	Y
8	6	1.0	333.3	9	0.3333	300.00	33	Y
9	6	1.0	333.3	9	0.3333	300.00	32	Y
10	6	1.0	333.3	9	0.3333	300.00	36	Y
11	6	1.0	333.3	9	0.3333	300.00	40	Y
12	6	1.0	333.3	9	0.3333	300.00	37	Y
13	6	1.0	333.3	9	0.3333	300.00	34	Y
14	6	1.0	333.3	9	0.3333	300.00	31	Y
15	6	1.0	333.3	9	0.3333	300.00	39	Y
16	6	1.0	333.3	9	0.3333	300.00	35	Y
17	6	1.0	333.3	9	0.3333	300.00	36	Y
18	6	1.0	333.3	9	0.3333	300.00	29	Y
19	6	1.0	333.3	9	0.3333	300.00	32	Y
20	6	1.0	333.3	9	0.3333	300.00	35	Y
21	6	1.0	333.3	9	0.3333	300.00	38	Y
22	6	1.0	333.3	9	0.3333	300.00	40	Y
23	6	1.0	333.3	9	0.3333	300.00	37	Y
24	6	1.0	333.3	9	0.3333	300.00	31	Y
25	6	1.0	333.3	9	0.3333	300.00	33	Y
26	6	1.0	333.3	9	0.3333	300.00	29	Y
27	6	1.0	333.3	9	0.3333	300.00	35	Y
28	6	1.0	333.3	9	0.3333	300.00	32	Y
29	6	1.0	333.3	9	0.3333	300.00	37	Y

Detection rate: 100%

**5610MHZ, Radar 1**

Trial Id	Radar Type	Pulse Width(μ s)	PRI (μ s)	Number of Pulses	Waveform Length (μ s)	conclusion
0	1	1.0	938.0	57	53466.0	Y
1	1	1.0	698.0	76	53048.0	Y
2	1	1.0	618.0	86	53148.0	Y
3	1	1.0	538.0	99	53262.0	Y
4	1	1.0	878.0	61	53558.0	Y
5	1	1.0	3066.0	18	55188.0	Y
6	1	1.0	638.0	83	52954.0	Y
7	1	1.0	918.0	58	53244.0	Y
8	1	1.0	838.0	63	52794.0	Y
9	1	1.0	858.0	62	53196.0	Y
10	1	1.0	798.0	67	53466.0	Y
11	1	1.0	718.0	74	53132.0	Y
12	1	1.0	578.0	92	53176.0	Y
13	1	1.0	598.0	89	53222.0	Y
14	1	1.0	558.0	95	53010.0	Y
15	1	1.0	2536.0	21	53256.0	Y
16	1	1.0	966.0	55	53130.0	Y
17	1	1.0	827.0	64	52928.0	Y
18	1	1.0	2501.0	22	55022.0	Y
19	1	1.0	2595.0	21	54495.0	Y
20	1	1.0	1114.0	48	53472.0	Y
21	1	1.0	1302.0	41	53382.0	Y
22	1	1.0	3045.0	18	54810.0	Y
23	1	1.0	1624.0	33	53592.0	Y
24	1	1.0	2878.0	19	54682.0	Y
25	1	1.0	1027.0	52	53404.0	Y
26	1	1.0	2485.0	22	54670.0	Y
27	1	1.0	1600.0	33	52800.0	Y
28	1	1.0	1172.0	46	53912.0	Y
29	1	1.0	1177.0	45	52965.0	Y

Detection rate: 100%

**5610MHZ, Radar 2**

Trial Id	Radar Type	Pulse Width(μ s)	PRI (μ s)	Number of Pulses	Waveform Length (μ s)	conclusion
0	2	3.2	179.0	26	4654.0	Y
1	2	1.1	207.0	23	4761.0	Y
2	2	2.1	230.0	24	5520.0	Y
3	2	4.8	200.0	29	5800.0	Y
4	2	3.9	214.0	28	5992.0	Y
5	2	2.9	222.0	26	5772.0	Y
6	2	3.2	204.0	26	5304.0	Y
7	2	2.5	192.0	25	4800.0	Y
8	2	3.1	164.0	26	4264.0	Y
9	2	1.2	156.0	23	3588.0	Y
10	2	3.9	210.0	27	5670.0	Y
11	2	4.6	201.0	29	5829.0	Y
12	2	3.2	162.0	26	4212.0	Y
13	2	2.2	197.0	25	4925.0	Y
14	2	4.5	163.0	29	4727.0	Y
15	2	3.0	203.0	26	5278.0	Y
16	2	5.0	168.0	29	4872.0	Y
17	2	2.4	217.0	25	5425.0	Y
18	2	2.9	191.0	26	4966.0	Y
19	2	2.3	166.0	25	4150.0	Y
20	2	3.7	150.0	27	4050.0	Y
21	2	2.2	176.0	25	4400.0	Y
22	2	4.9	195.0	29	5655	Y
23	2	2.9	202.0	26	5252.0	Y
24	2	2.5	178.0	25	4450.0	Y
25	2	1.1	206.0	23	4738.0	Y
26	2	3.8	155.0	27	4185.0	Y
27	2	4.7	157.0	29	4553.0	Y
28	2	2.4	224.0	25	5600.0	Y
29	2	4.2	159.0	28	4452.0	Y

Detection rate: 100%

**5610MHZ, Radar 3**

Trial Id	Radar Type	Pulse Width(μ s)	PRI (μ s)	Number of Pulses	Waveform Length (μ s)	conclusion
0	3	8.2	355.0	17	6035.0	Y
1	3	6.1	487.0	16	7792.0	Y
2	3	7.1	344.0	16	5504.0	Y
3	3	9.8	288.0	18	5184.0	Y
4	3	8.9	230.0	18	4140.0	Y
5	3	7.9	432.0	17	7344.0	Y
6	3	8.2	207.0	17	3519.0	Y
7	3	7.5	443.0	17	7531.0	Y
8	3	8.1	439.0	17	7463.0	Y
9	3	6.2	223.0	16	3568.0	Y
10	3	8.9	208.0	18	3744.0	Y
11	3	9.6	463.0	18	8334.0	Y
12	3	8.2	441.0	17	7497.0	Y
13	3	7.2	323.0	16	5168.0	Y
14	3	9.5	297.0	18	5346.0	Y
15	3	8.0	412.0	17	7004.0	Y
16	3	10.0	324.0	18	5832.0	Y
17	3	7.4	271.0	17	4607.0	Y
18	3	7.9	349.0	17	5933.0	Y
19	3	7.3	409.0	16	6544.0	Y
20	3	8.7	373.0	18	6714.0	Y
21	3	7.2	254.0	16	4064.0	Y
22	3	9.9	274.0	18	4932.0	Y
23	3	7.9	278.0	17	4726.0	Y
24	3	7.5	317.0	17	5389.0	Y
25	3	6.1	260.0	16	4160.0	Y
26	3	8.8	211.0	18	3798.0	Y
27	3	9.7	272.0	18	4896.0	Y
28	3	7.4	264.0	17	4488.0	Y
29	3	9.2	284.0	18	5112.0	Y

Detection rate: 100%

**5610MHZ, Radar 4**

Trial Id	Radar Type	Pulse Width(μ s)	PRI (μ s)	Number of Pulses	Waveform Length (μ s)	conclusion
0	4	16.0	355.0	14	4970.0	Y
1	4	11.3	487.0	12	5844.0	Y
2	4	13.5	344.0	13	4472.0	Y
3	4	19.4	288.0	16	4608.0	Y
4	4	17.5	230.0	15	3450.0	Y
5	4	15.3	432.0	14	6048.0	Y
6	4	15.9	207.0	14	2898.0	Y
7	4	14.3	443.0	13	5759.0	Y
8	4	15.8	439.0	14	6146.0	Y
9	4	11.5	223.0	12	2676.0	Y
10	4	17.4	208.0	15	3120.0	Y
11	4	19.0	463.0	16	7408.0	Y
12	4	16.0	441.0	14	6174.0	Y
13	4	13.8	323.0	13	4199.0	Y
14	4	18.9	297.0	16	4752.0	Y
15	4	15.5	412.0	14	5768.0	Y
16	4	19.9	324.0	16	5184.0	Y
17	4	14.1	271.0	13	3523.0	Y
18	4	15.2	349.0	14	4886.0	Y
19	4	13.8	409.0	13	5317.0	Y
20	4	17.1	373.0	15	5595.0	Y
21	4	13.8	254.0	13	3302.0	Y
22	4	19.8	274.0	16	4384.0	Y
23	4	15.3	278.0	14	3892.0	Y
24	4	14.5	317.0	13	4121.0	Y
25	4	11.3	260.0	12	3120.0	Y
26	4	17.3	211.0	15	3165.0	Y
27	4	19.2	272.0	16	4352.0	Y
28	4	14.2	264.0	13	3432.0	Y
29	4	18.2	284.0	15	4260.0	Y

Detection rate: 100%

**5610MHZ, Radar 5**

Trial Id	Radar Type	Number of Pulses	Chirp Width (MHz)	Burst Period (s)	Waveform Length (μ s)	Center Frequency (MHz)	conclusion
0	5	13	72	0.8000000	12.0	5.610	Y
1	5	19	72	1.5000000	12.0	5.610	Y
2	5	11	72	1.0909091	12.0	5.610	Y
3	5	12	72	0.6000000	12.0	5.610	Y
4	5	6	72	0.7058824	12.0	5.610	Y
5	5	15	72	0.8571429	12.0	5.610	Y
6	5	16	72	0.8000000	12.0	5.610	Y
7	5	17	72	1.0000000	12.0	5.610	Y
8	5	19	72	0.8571429	12.0	5.610	Y
9	5	12	72	1.5000000	12.0	5.610	Y
10	5	7	72	0.7058824	12.0	5.580	Y
11	5	11	72	0.6315789	12.0	5.582	Y
12	5	14	72	0.8000000	12.0	5.579	Y
13	5	16	72	1.0000000	12.0	5.578	Y
14	5	9	72	0.6315789	12.0	5.581	Y
15	5	16	72	0.8571429	12.0	5.579	Y
16	5	13	72	0.6000000	12.0	5.582	Y
17	5	7	72	1.0000000	12.0	5.578	Y
18	5	10	72	0.8571429	12.0	5.579	Y
19	5	19	72	1.0000000	12.0	5.578	Y
20	5	12	72	0.7500000	12.0	5.640	Y
21	5	14	72	1.0000000	12.0	5.642	Y
22	5	9	72	0.6000000	12.0	5.638	Y
23	5	14	72	0.8571429	12.0	5.641	Y
24	5	6	72	0.9230769	12.0	5.642	Y
25	5	7	72	1.5000000	12.0	5.644	Y
26	5	18	72	0.7058824	12.0	5.640	Y
27	5	16	72	0.6315789	12.0	5.638	Y
28	5	17	72	1.0000000	12.0	5.642	Y
29	5	16	72	0.6666667	12.0	5.639	Y

Detection rate: 100%

**5610MHZ, Radar 6**

Trial Id	Radar Type	Pulse Width(μ s)	PRI (μ s)	Pulses Per Hop	Hopping Rate (kHz)	Hopping Sequence Length (ms)	Visible Frequency Number	conclusion
0	6	1.0	333.3	9	0.3333	300.00	33	Y
1	6	1.0	333.3	9	0.3333	300.00	29	Y
2	6	1.0	333.3	9	0.3333	300.00	28	Y
3	6	1.0	333.3	9	0.3333	300.00	35	Y
4	6	1.0	333.3	9	0.3333	300.00	35	Y
5	6	1.0	333.3	9	0.3333	300.00	31	Y
6	6	1.0	333.3	9	0.3333	300.00	33	Y
7	6	1.0	333.3	9	0.3333	300.00	29	Y
8	6	1.0	333.3	9	0.3333	300.00	33	Y
9	6	1.0	333.3	9	0.3333	300.00	32	Y
10	6	1.0	333.3	9	0.3333	300.00	36	Y
11	6	1.0	333.3	9	0.3333	300.00	40	Y
12	6	1.0	333.3	9	0.3333	300.00	37	Y
13	6	1.0	333.3	9	0.3333	300.00	34	Y
14	6	1.0	333.3	9	0.3333	300.00	31	Y
15	6	1.0	333.3	9	0.3333	300.00	39	Y
16	6	1.0	333.3	9	0.3333	300.00	35	Y
17	6	1.0	333.3	9	0.3333	300.00	36	Y
18	6	1.0	333.3	9	0.3333	300.00	29	Y
19	6	1.0	333.3	9	0.3333	300.00	32	Y
20	6	1.0	333.3	9	0.3333	300.00	35	Y
21	6	1.0	333.3	9	0.3333	300.00	38	Y
22	6	1.0	333.3	9	0.3333	300.00	40	Y
23	6	1.0	333.3	9	0.3333	300.00	37	Y
24	6	1.0	333.3	9	0.3333	300.00	31	Y
25	6	1.0	333.3	9	0.3333	300.00	33	Y
26	6	1.0	333.3	9	0.3333	300.00	29	Y
27	6	1.0	333.3	9	0.3333	300.00	35	Y
28	6	1.0	333.3	9	0.3333	300.00	32	Y
29	6	1.0	333.3	9	0.3333	300.00	37	Y

Detection rate: 100%



7 Main Test Instruments

Name	Manufacturer	Type	Serial Number	Calibration Date	Expiration Date
Spectrum Analyzer	Agilent	N9010A	MY47191109	2021/05/15	2022/05/14
Signal Generator	KEYSIGHT	N5171B	MY53051706	2021/05/15	2022/05/14

*****END OF REPORT *****



ANNEX A: The EUT Appearance

The EUT Appearance is submitted separately.



ANNEX B: Test Setup Photos

The Test Setup Photos is submitted separately.