



TEST REPORT

No.I21N04009-SAR

For

TCL Communication Ltd.

MOVETIME FAMILY WATCH

Model Name: MT40A

With

Hardware Version: PIO

Software Version: V1.0

FCC ID: 2ACCJB112

Issued Date: 2022-01-26

Designation Number: CN1210

Note:

The test results in this test report relate only to the devices specified in this report. This report shall not be reproduced except in full without the written approval of SAICT.

Test Laboratory:

SAICT, Shenzhen Academy of Information and Communications Technology

Building G, Shenzhen International Innovation Center, No.1006 Shennan Road, Futian District, Shenzhen, Guangdong, P. R. China 518000.

Tel:+86(0)755-33322000, Fax:+86(0)755-33322001

Email: yewu@caict.ac.cn www.saict.ac.cn



REPORT HISTORY

Report Number	Revision	Description	Issue Date
I21N04009-SAR	Rev.0	1st edition	2022-01-26

TCONTENTS

1. SUMMARY OF TEST REPORT	5
1.1. TEST ITEMS	5
1.2. TEST STANDARDS	5
1.3. TEST RESULT.....	5
1.4. TESTING LOCATION	5
1.5. PROJECT DATA	5
1.6. SIGNATURE.....	5
2. STATEMENT OF COMPLIANCE	6
3. CLIENT INFORMATION	8
3.1. APPLICANT INFORMATION.....	8
3.2. MANUFACTURER INFORMATION	8
4. EQUIPMENT UNDER TEST (EUT) AND ANCILLARY EQUIPMENT (AE)	9
4.1. ABOUT EUT.....	9
4.2. INTERNAL IDENTIFICATION OF EUT USED DURING THE TEST	10
4.3. INTERNAL IDENTIFICATION OF AE USED DURING THE TEST.....	10
4.4. GENERAL DESCRIPTION.....	10
5. TEST METHODOLOGY	11
5.1. APPLICABLE LIMIT REGULATIONS.....	11
5.2. APPLICABLE MEASUREMENT STANDARDS	11
6. SPECIFIC ABSORPTION RATE (SAR).....	12
6.1. INTRODUCTION.....	12
6.2. SAR DEFINITION.....	12
7. TISSUE SIMULATING LIQUIDS	13
7.1. TARGETS FOR TISSUE SIMULATING LIQUID	13
7.2. DIELECTRIC PERFORMANCE	13
8. SYSTEM VERIFICATION	17
8.1. SYSTEM SETUP.....	17
8.2. SYSTEM VERIFICATION	18
9. MEASUREMENT PROCEDURES	19
9.1. TESTS TO BE PERFORMED.....	19
9.2. GENERAL MEASUREMENT PROCEDURE	21
9.3. WCDMA MEASUREMENT PROCEDURES FOR SAR	22
9.4. BLUETOOTH & WLAN MEASUREMENT PROCEDURES FOR SAR.....	23
9.5. SAR MEASUREMENT FOR LTE.....	23
9.6. POWER DRIFT.....	24
10. CONDUCTED OUTPUT POWER	25



10.1. GSM MEASUREMENT RESULT 25

10.2. WCDMA MEASUREMENT RESULT 27

10.3. LTE MEASUREMENT RESULT 29

10.4. WLAN AND BT MEASUREMENT RESULT 44

11. SIMULTANEOUS TX SAR CONSIDERATIONS45

11.1. INTRODUCTION 45

11.2. TRANSMIT ANTENNA SEPARATION DISTANCES 45

11.3. STANDALONE SAR TEST EXCLUSION CONSIDERATIONS 46

12. EVALUATION OF SIMULTANEOUS.....47

13. SUMMARY OF TEST RESULTS.....48

13.1. SAR RESULTS..... 49

13.2. WLAN EVALUATION FOR 2.4G 53

14. SAR MEASUREMENT VARIABILITY.....54

15. MEASUREMENT UNCERTAINTY55

15.1. MEASUREMENT UNCERTAINTY FOR NORMAL SAR TESTS (300MHZ~3GHZ) 55

16. MAIN TEST INSTRUMENTS.....56

ANNEX A: GRAPH RESULTS57

ANNEX B: SYSTEMVERIFICATION RESULTS.....77

ANNEX C: SAR MEASUREMENT SETUP.....82

ANNEX D: POSITION OF THE WIRELESS DEVICE IN RELATION TO THE PHANTOM.....88

ANNEX E: EQUIVALENT MEDIA RECIPES91

ANNEX F: SYSTEM VALIDATION.....92

ANNEX G: DAE CALIBRATION CERTIFICATE93

ANNEX H: PROBE CALIBRATION CERTIFICATE96

ANNEX I: DIPOLE CALIBRATION CERTIFICATE105

ANNEX J: EXTENDED CALIBRATION SAR DIPOLE.....139

ANNEX K: SPOT CHECK TEST.....140

K.1. INTERNAL IDENTIFICATION OF EUT USED DURING THE SPOT CHECK TEST 140

K.2. MEASUREMENT RESULTS..... 140

K.3. GRAPH RESULTS FOR SPOT CHECK..... 144

K.4. SYSTEM VERIFICATION RESULTS FOR SPOT CHECK..... 164



1. Summary of Test Report

1.1. Test Items

Description: MOVETIME FAMILY WATCH
Model Name: MT40A
Applicant's Name: TCL Communication Ltd.
Manufacturer's Name: TCL Communication Ltd.

1.2. Test Standards

ANSI C95.1-1992, IEEE 1528-2013

1.3. Test Result

Pass. Please refer to "13. Summary of Test Results" and "ANNEX K: Spot Check Test"

1.4. Testing Location

Address: Building G, Shenzhen International Innovation Center, No.1006 Shennan Road, Futian District, Shenzhen, Guangdong, P. R. China

1.5. Project Data

Testing Start Date: 2021-12-22

Testing End Date: 2022-01-13

1.6. Signature

Li Yongfu

(Prepared this test report)

Zhang Yunzhan

(Reviewed this test report)

Cao Junfei

(Approved this test report)

2. Statement of Compliance

This EUT is a variant product and the report of original sample is No.I19N01990-SAR. According to the client request, we quote the test results of original sample and spot check the worst case in annex K.

The maximum results of Specific Absorption Rate (SAR) found during testing for TCL Communication Ltd. MOVETIME FAMILY WATCH MT40A are as follows:

Table 2.1: Highest Reported SAR

Exposure Configuration	Technology Band	Highest Reported SAR	Equipment Class	Limited (W/kg)
Next to the mouth (Separation Distance 10mm) 1g(W/kg)	GSM850	0.35	PCT	1.6
	PCS1900	0.57		
	UMTS FDD 5	0.23		
	UMTS FDD 2	1.05		
	UMTS FDD 4	0.62		
	LTE Band 2	1.14		
	LTE Band 4	1.00		
	LTE Band 5	0.22		
	LTE Band 7	1.12		
	WLAN.24G	0.34	DTS	
Wrist worn (Separation Distance 0mm) 10g(W/kg)	GSM850	0.76	PCT	4.0
	PCS1900	0.82		
	UMTS FDD 5	0.41		
	UMTS FDD 2	1.10		
	UMTS FDD 4	0.82		
	LTE Band 2	1.57		
	LTE Band 4	0.74		
	LTE Band 5	0.16		
	LTE Band 7	1.19		
	WLAN.24G	0.41	DTS	

The SAR values found for the EUT are below the maximum recommended levels of 1.6 W/Kg as averaged over any 1g tissue and 4.0 W/Kg as averaged over any 10g tissue according to the ANSI C95.1-1992.

The EUT battery must be fully charged and checked periodically during the test to ascertain uniform power output.

The measurement together with the test system set-up is described in annex C of this test report. A detailed description of the equipment under test can be found in chapter 4 of this test report.

The highest reported SAR value is obtained at the case of (Table 2.1), **1.14 W/kg (1g)** for Next to the mouth, **1.57 W/kg (10g)** for wrist-worn.

Table2.2: The sum of reported SAR values for main antenna and WLAN

/	Position	Main antenna	WLAN	Sum
Highest reported SAR 1g (W/Kg)	Next to the mouth	1.14	0.34	1.48
Highest reported SAR 10g (W/Kg)	wrist-worn	1.57	0.41	1.98

Table2.3: The sum of reported SAR values for main antenna and BT

/	Position	Main antenna	BT*	Sum
Highest reported SAR 1g (W/Kg)	Next to the mouth	1.14	0.10	1.24
Highest reported SAR 10g (W/Kg)	wrist-worn	1.57	0.21	1.78

BT*-Estimated SAR for Bluetooth (seethetable12.3)

According to the above tables, the highest sum of reported SAR values is less than the limit. The detail for simultaneous transmission consideration is described in chapter 12.



3. Client Information

3.1. Applicant Information

Company Name:	TCL Communication Ltd.
Address:	5/F, Building 22E, 22 Science Park East Avenue, Hong Kong Science Park, Shatin, NT, Hong Kong
City:	Hong Kong
Country:	China
Telephone:	0086-755-36611722

3.2. Manufacturer Information

Company Name:	TCL Communication Ltd.
Address:	5/F, Building 22E, 22 Science Park East Avenue, Hong Kong Science Park, Shatin, NT, Hong Kong
City:	Hong Kong
Country:	China
Telephone:	0086-755-36611722

4. Equipment under Test (EUT) and Ancillary Equipment (AE)

4.1. About EUT

Description:	MOVETIME FAMILY WATCH
Model Name:	MT40A
Brand Name:	TCL
Condition of EUT as received:	No obvious damage in appearance
Frequency Bands:	GSM 850/1900, WCDMA Band 2/4/5, LTE Band 2/4/5/7, Bluetooth, WLAN 2.4G
Tested Tx Frequency:	824 – 849MHz (GSM 850)
	1850 – 1910MHz (GSM 1900)
	1850 – 1910MHz (WCDMA Band 2)
	1710 – 1755MHz (WCDMA Band 4)
	824 – 849MHz (WCDMA Band 5)
	1850 – 1910MHz (LTE Band 2)
	1710 – 1755MHz (LTE Band 4)
	824 – 849MHz (LTE Band 5)
	2500 – 2570MHz (LTE Band 7)
	2402 – 2480MHz (Bluetooth)
2412 – 2462MHz (WLAN 2.4G)	
GPRS / EGPRS Multislot Class:	12
GPRS capability Class:	B
Test device Production information:	Production unit
Device type:	Portable device
Antenna type:	Integrated antenna
<p>Remark:</p> <ol style="list-style-type: none"> 1. There is one power reduction level of WWAN Antenna. 2. For WWAN transmitter Next to the mouth exposure conditions: Reduced power –WCDMA Band 2/4, LTE Band 4/7 While the device WWAN is transmitting and the audio is actively routed through the receiver, power reduction enabled for those bands. 	

4.2. Internal Identification of EUT used during the test

EUT ID*	IMEI	HW Version	SW Version	Receipt Date
EUT1	352213110000208	PIO	V1.0	2019-09-20
EUT2	352213110000190	PIO	V1.0	2019-09-20
EUT3	352213110000059	PIO	V1.0	2019-09-20
UT05aa	352213110163733	PIO	V1.0	2021-12-20
UT07aa	352213110163758	PIO	V1.0	2021-12-20

*EUT ID: is used to identify the test sample in the lab internally.

Note: It is performed to test SAR with the EUT1 & EUT2 & UT05aa & UT07aa, and conducted power with the EUT3.

4.3. Internal Identification of AE used during the test

AE ID*	Description	Model	Manufacturer
AE1	Battery	ZWD602531V	ZWD

*AE ID: is used to identify the test sample in the lab internally.

4.4. General Description

According to client's description, the table below shows the difference between initial and Variant:

Changes	Initial	Variant
Chipset	9820E	8521E

We'll perform Variant product for spot check test. The results of spot check are presented in annex K.



5. Test Methodology

5.1. Applicable Limit Regulations

ANSI C95.1–1992: IEEE Standard for Safety Levels with Respect to Human Exposure to Radio Frequency Electromagnetic Fields, 3 kHz to 300 GHz.

It specifies the maximum exposure limit of **1.6 W/kg** as averaged over any 1 gram of tissue for portable devices being used within 20 cm of the user in the uncontrolled environment.

5.2. Applicable Measurement Standards

IEEE 1528–2013: Recommended Practice for Determining the Peak Spatial-Average Specific Absorption Rate (SAR) in the Human Head from Wireless Communications Devices: Experimental Techniques.

KDB 447498 D01 General RF Exposure Guidance v06: Mobile and Portable Devices RF Exposure Procedures and Equipment Authorization Policies.

KDB 941225 D01 SAR test for 3G devices v03r01: SAR Measurement Procedures for 3G Devices

KDB 941225 D05 SAR for LTE Devices v02r05: SAR Evaluation Considerations for LTE Devices

KDB 248227 D01 802.11 Wi-Fi SAR v02r02: SAR Guidance for IEEE 802.11 (Wi-Fi) Transmitters.

KDB 865664 D01 SAR measurement 100 MHz to 6 GHz v01r04: SAR Measurement Requirements for 100 MHz to 6 GHz.

KDB 865664 D02 RF Exposure Reporting v01r02: RF Exposure Compliance Reporting and Documentation Considerations

TCB workshop April 2019; RF Exposure Procedures (Tissue Simulating Liquids)

6. Specific Absorption Rate (SAR)

6.1. Introduction

SAR is related to the rate at which energy is absorbed per unit mass in an object exposed to a radio field. The SAR distribution in a biological body is complicated and is usually carried out by experimental techniques or numerical modeling. The standard recommends limits for two tiers of groups, occupational/controlled and general population/uncontrolled, based on a person's awareness and ability to exercise control over his or her exposure. In general, occupational/controlled exposure limits are higher than the limits for general population/uncontrolled.

6.2. SAR Definition

The SAR definition is the time derivative (rate) of the incremental energy (dW) absorbed by (dissipated in) an incremental mass (dm) contained in a volume element (dv) of a given density (ρ). The equation description is as below:

$$SAR = \frac{d}{dt} \left(\frac{dW}{dm} \right) = \frac{d}{dt} \left(\frac{dW}{\rho dv} \right)$$

SAR is expressed in units of Watts per kilogram (W/kg)

SAR measurement can be either related to the temperature elevation in tissue by

$$SAR = c \left(\frac{\delta T}{\delta t} \right)$$

Where: C is the specific heat capacity, δT is the temperature rise and δt is the exposure duration, or related to the electrical field in the tissue by

$$SAR = \frac{\sigma |E|^2}{\rho}$$

Where: σ is the conductivity of the tissue, ρ is the mass density of tissue and E is the RMS electrical field strength.

However for evaluating SAR of low power transmitter, electrical field measurement is typically applied.

7. Tissue Simulating Liquids

7.1. Targets for tissue simulating liquid

Table 7.1: Targets for tissue simulating liquid

Frequency (MHz)	Liquid Type	Conductivity (σ)	$\pm 5\%$ Range	Permittivity (ϵ)	$\pm 5\%$ Range
835	Head	0.90	0.86~0.95	41.5	39.4~43.6
1750	Head	1.37	1.30~1.44	40.1	38.1~42.1
1900	Head	1.40	1.33~1.47	40.0	38.0~42.0
2450	Head	1.80	1.71~1.89	39.2	37.2~41.2
2550	Head	1.91	1.81~2.01	39.1	37.1~41.0

7.2. Dielectric Performance

Table 7.2: Dielectric Performance of Tissue Simulating Liquid

Measurement Date (yyyy-mm-dd)	Type	Frequency	Conductivity σ (S/m)	Drift (%)	Permittivity ϵ	Drift (%)
2019-09-30	Head	835	0.923	2.56	40.24	-3.04
2019-10-04	Head	1750	1.358	-0.88	40.62	1.30
2019-10-04	Head	1900	1.424	1.71	39.78	-0.55
2019-10-09	Head	2450	1.828	1.56	38.43	-1.96
2019-10-04	Head	2550	1.945	1.83	38.06	-2.66
2022-01-13	Head	835	0.915	1.67	40.71	-1.90
2022-01-01	Head	1750	1.385	1.09	39.49	-1.52
2021-01-05	Head	1900	1.417	1.21	39.25	-1.88
2022-01-12	Head	2450	1.834	1.89	38.32	-2.24
2021-12-22	Head	2550	1.950	2.09	38.28	-2.10

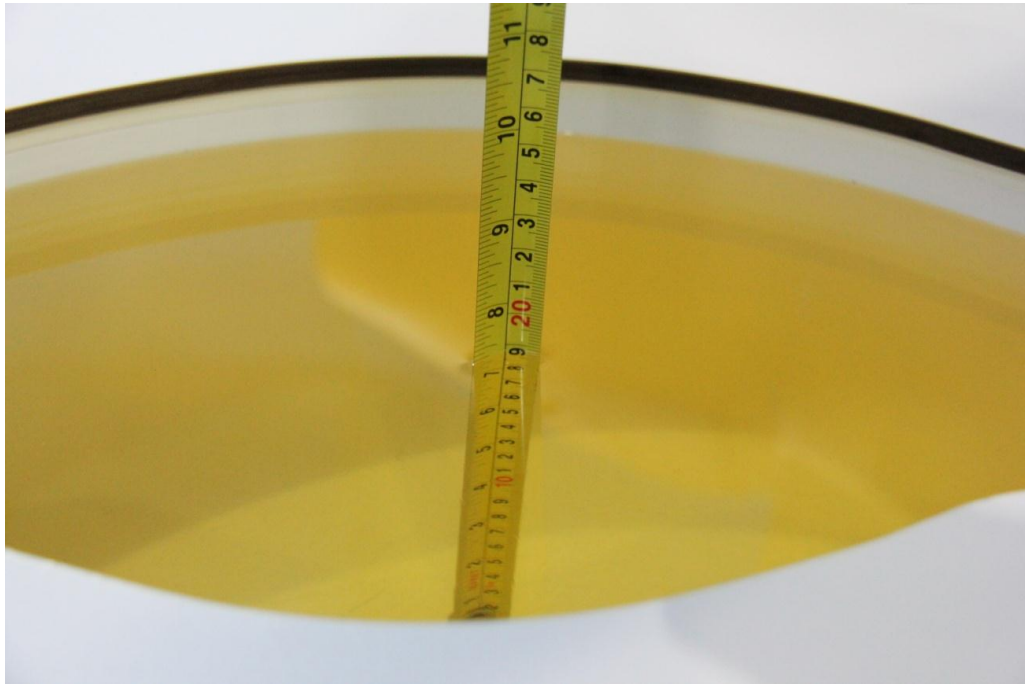

Picture 7-1: Liquid depth in the Head Phantom (835 MHz)

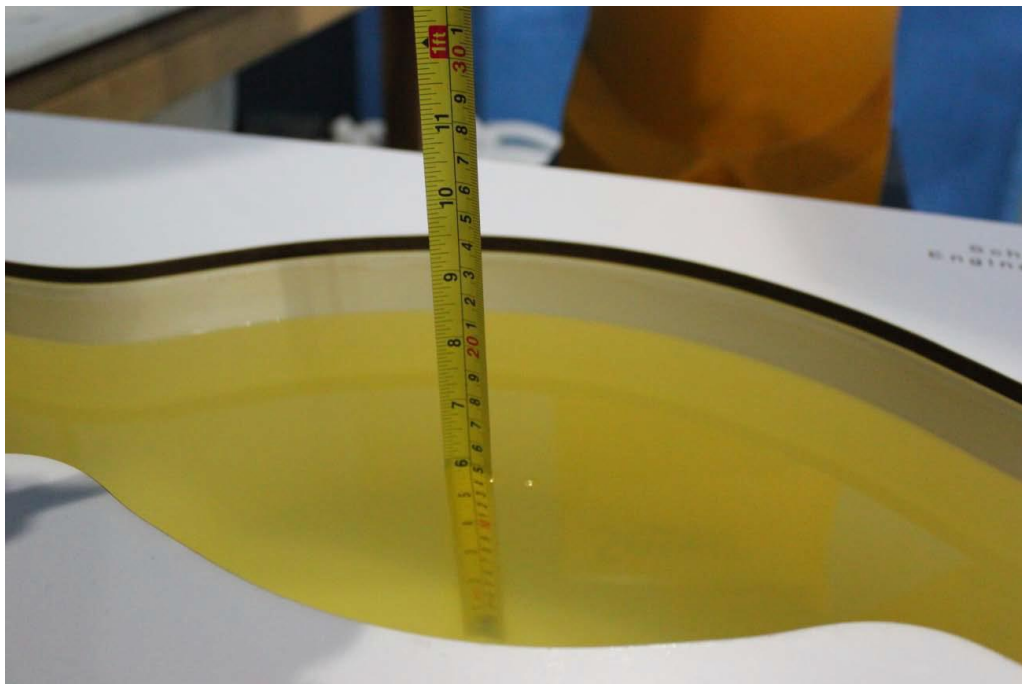

Picture 7-2: Liquid depth in the Head Phantom (1750 MHz)

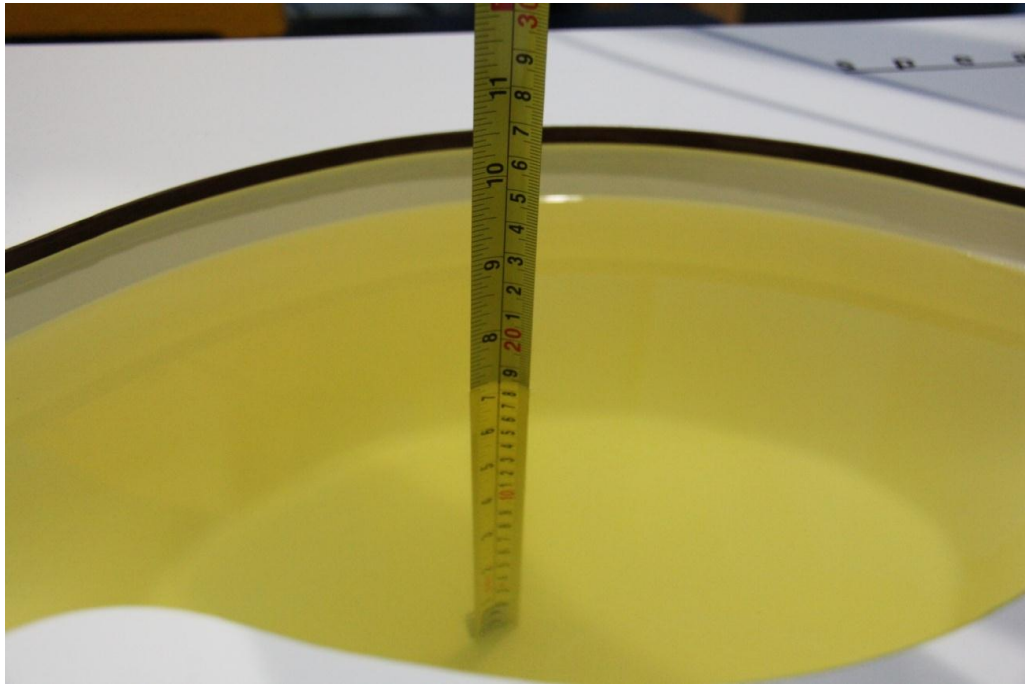

Picture 7-3: Liquid depth in the Head Phantom (1900 MHz)



Picture 7-4: Liquid depth in the Head Phantom(2450MHz)

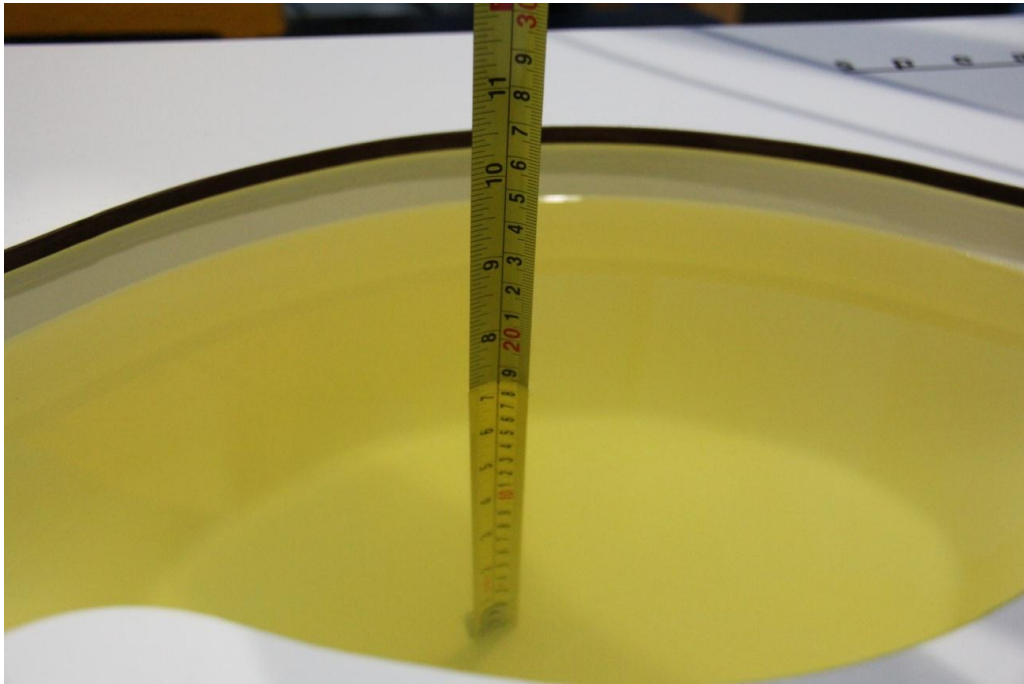

Picture 7-5: Liquid depth in the Head Phantom(2550MHz)

8. System verification

8.1. System Setup

In the simplified setup for system evaluation, the DUT is replaced by a calibrated dipole and the power source is replaced by a continuous wave that comes from a signal generator. The calibrated dipole must be placed beneath the flat phantom section of the SAM twin phantom with the correct distance holder. The distance holder should touch the phantom surface with a light pressure at the reference marking and be oriented parallel to the long side of the phantom. The equipment setup is shown below:

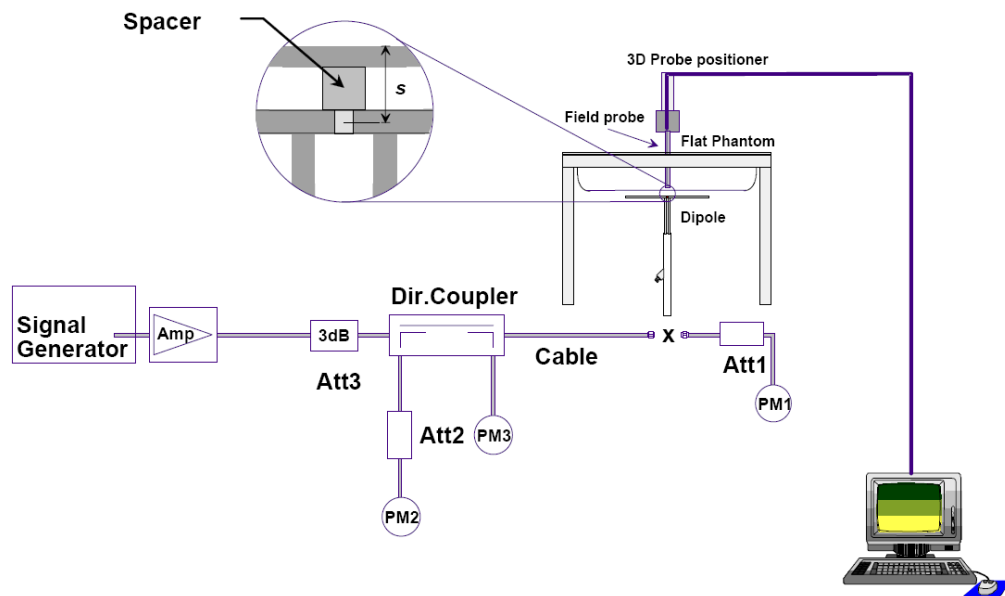

Picture 8.1 System Setup for System Evaluation

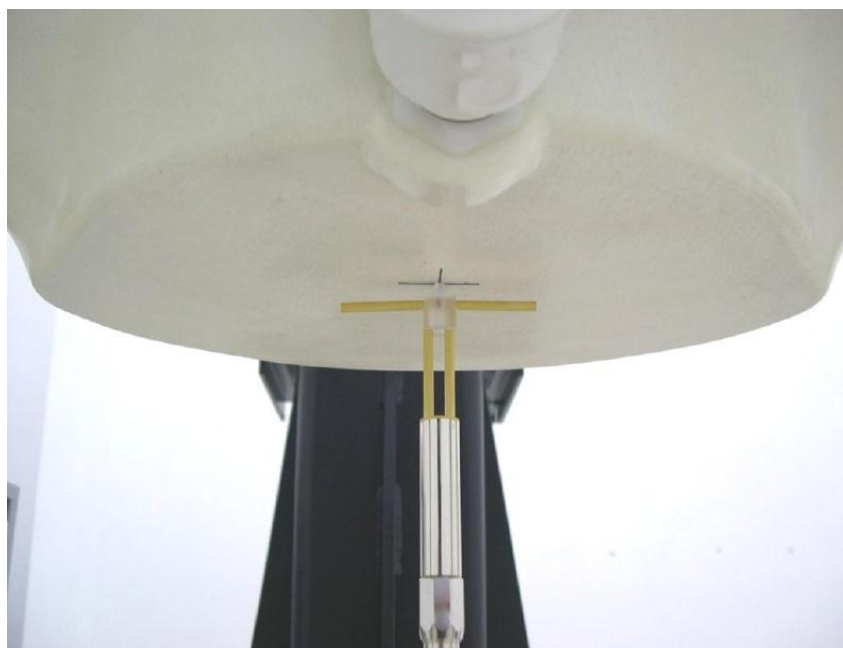

Picture 8.2 Photo of Dipole Setup

8.2. System Verification

SAR system verification is required to confirm measurement accuracy, according to the tissue dielectric media, probe calibration points and other system operating parameters required for measuring the SAR of a test device. The system verification must be performed for each frequency band and within the valid range of each probe calibration point required for testing the device.

Table 8.1: System Verification of Head

Measurement Date	Frequency (MHz)	Target value (W/kg)		Measured value (W/kg)				Deviation (%)	
				/		Normalize to 1W			
		10 g	1 g	10 g	1 g	10 g	1 g	10 g	1 g
2019-09-30	835	6.29	9.62	1.62	2.52	6.48	10.08	3.02	4.78
2019-10-04	1750	19.3	36.4	4.71	8.77	18.84	35.08	-2.38	-3.63
2019-10-04	1900	21.0	40.5	5.38	10.5	21.52	42.00	2.48	3.70
2019-10-09	2450	24.1	52.0	6.12	13.4	24.48	53.60	1.58	3.08
2019-10-04	2550	26.5	57.8	6.80	15.1	27.20	60.40	2.64	4.50
2022-01-13	835	6.29	9.24	1.59	2.37	6.36	9.48	1.11	2.60
2022-01-01	1750	19.30	36.40	4.88	9.30	19.52	37.20	1.14	2.20
2021-01-05	1900	20.50	40.20	5.27	10.5	21.08	42.00	2.83	4.48
2022-01-12	2450	24.20	53.20	6.15	13.7	24.60	54.80	1.65	3.01
2021-12-22	2550	25.20	55.90	6.48	14.6	25.92	58.40	2.86	4.47

9. Measurement Procedures

9.1. Tests to be performed

In order to determine the highest value of the peak spatial-average SAR of a handset, all device positions, configurations and operational modes shall be tested for each frequency band according to steps 1 to 3 below. A flowchart of the test process is shown in picture 9.1.

Step 1: The tests described in 9.2 shall be performed at the channel that is closest to the center of the transmit frequency band (f_c) for:

- a) all device positions (cheek and tilt, for both left and right sides of the SAM phantom, as described in annex D),
- b) all configurations for each device position in a), e.g., antenna extended and retracted, and
- c) all operational modes, e.g., analogue and digital, for each device position in a) and configuration in b) in each frequency band.

If more than three frequencies need to be tested according to 11.1 (i.e., $N_c > 3$), then all frequencies, configurations and modes shall be tested for all of the above test conditions.

Step 2: For the condition providing highest peak spatial-average SAR determined in Step 1, perform all tests described in 9.2 at all other test frequencies, i.e., lowest and highest frequencies. In addition, for all other conditions (device position, configuration and operational mode) where the peak spatial-average SAR value determined in Step 1 is within 3 dB of the applicable SAR limit, it is recommended that all other test frequencies shall be tested as well.

Step 3: Examine all data to determine the highest value of the peak spatial-average SAR found in Steps 1 to 2.

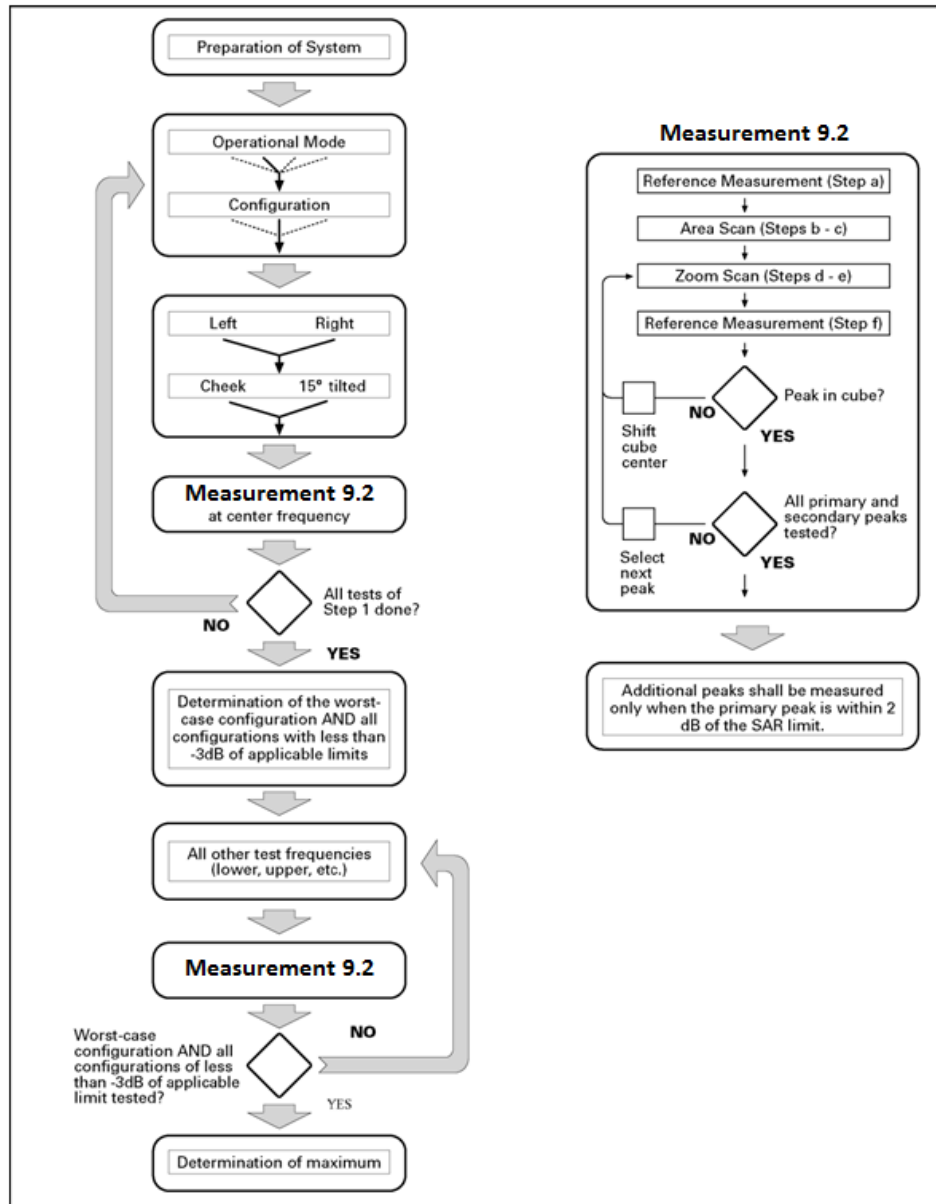

Picture 9.1 Block diagram of the tests to be performed

9.2. General Measurement Procedure

The area and zoom scan resolutions specified in the table below must be applied to the SAR measurements and fully documented in SAR reports to qualify for TCB approval. Probe boundary effect error compensation is required for measurements with the probe tip closer than half a probe tip diameter to the phantom surface. Both the probe tip diameter and sensor offset distance must satisfy measurement protocols; to ensure probe boundary effect errors are minimized and the higher fields closest to the phantom surface can be correctly measured and extrapolated to the phantom surface for computing 1-g SAR. Tolerances of the post-processing algorithms must be verified by the test laboratory for the scan resolutions used in the SAR measurements, according to the reference distribution functions specified in IEEE Std 1528-2013. The results should be documented as part of the system validation records and may be requested to support test results when all the measurement parameters in the following table are not satisfied.

		≤ 3 GHz	> 3 GHz
Maximum distance from closest measurement point (geometric center of probe sensors) to phantom surface		5 ± 1 mm	$\frac{1}{2} \cdot \delta \cdot \ln(2) \pm 0.5$ mm
Maximum probe angle from probe axis to phantom surface normal at the measurement location		$30^\circ \pm 1^\circ$	$20^\circ \pm 1^\circ$
Maximum area scan spatial resolution: $\Delta x_{Area}, \Delta y_{Area}$		≤ 2 GHz: ≤ 15 mm 2 – 3 GHz: ≤ 12 mm	3 – 4 GHz: ≤ 12 mm 4 – 6 GHz: ≤ 10 mm
		When the x or y dimension of the test device, in the measurement plane orientation, is smaller than the above, the measurement resolution must be \leq the corresponding x or y dimension of the test device with at least one measurement point on the test device.	
Maximum zoom scan spatial resolution: $\Delta x_{Zoom}, \Delta y_{Zoom}$		≤ 2 GHz: ≤ 8 mm 2 – 3 GHz: ≤ 5 mm*	3 – 4 GHz: ≤ 5 mm* 4 – 6 GHz: ≤ 4 mm*
Maximum zoom scan spatial resolution, normal to phantom surface	uniform grid: $\Delta z_{Zoom}(n)$	≤ 5 mm	3 – 4 GHz: ≤ 4 mm 4 – 5 GHz: ≤ 3 mm 5 – 6 GHz: ≤ 2 mm
	graded grid $\Delta z_{Zoom}(1)$: between 1 st two points closest to phantom surface	≤ 4 mm	3 – 4 GHz: ≤ 3 mm 4 – 5 GHz: ≤ 2.5 mm 5 – 6 GHz: ≤ 2 mm
	$\Delta z_{Zoom}(n>1)$: between subsequent points	$\leq 1.5 \cdot \Delta z_{Zoom}(n-1)$	
Minimum zoom scan volume	x, y, z	≥ 30 mm	3 – 4 GHz: ≥ 28 mm 4 – 5 GHz: ≥ 25 mm 5 – 6 GHz: ≥ 22 mm
<p>Note: δ is the penetration depth of a plane-wave at normal incidence to the tissue medium; see draft standard IEEE P1528-2011 for details.</p> <p>* When zoom scan is required and the <i>reported</i> SAR from the area scan based 1-g SAR estimation procedures of KDB 447498 is ≤ 1.4 W/kg, ≤ 8 mm, ≤ 7 mm and ≤ 5 mm zoom scan resolution may be applied, respectively, for 2 GHz to 3 GHz, 3 GHz to 4 GHz and 4 GHz to 6 GHz.</p>			

9.3. WCDMA Measurement Procedures for SAR

The following procedures are applicable to WCDMA handsets operating under 3GPP Release99, Release 5 and Release 6. The default test configuration is to measure SAR with an established radio link between the DUT and a communication test set using a 12.2kbps RMC (reference measurement channel) configured in Test Loop Mode 1. SAR is selectively confirmed for other physical channel configurations (DPCCH & DPDCH_n), HSDPA and HSPA (HSUPA/HSDPA) modes according to output power, exposure conditions and device operating capabilities. Both uplink and downlink should be configured with the same RMC or AMR, when required. SAR for Release 5 HSDPA and Release 6 HSPA are measured using the applicable FRC (fixed reference channel) and E-DCH reference channel configurations. Maximum output power is verified according to applicable versions of 3GPP TS 34.121 and SAR must be measured according to these maximum output conditions. When Maximum Power Reduction (MPR) is not implemented according to Cubic Metric (CM) requirements for Release 6 HSPA, the following procedures do not apply.

For Release 5 HSDPA Data Devices:

Sub-test	β_c	β_d	β_d (SF)	β_c / β_d	β_{hs}	CM/dB
1	2/15	15/15	64	2/15	4/15	0.0
2	12/15	15/15	64	12/15	24/25	1.0
3	15/15	8/15	64	15/8	30/15	1.5
4	15/15	4/15	64	15/4	30/15	1.5

For Release 6 HSPA Data Devices

Sub-test	β_c	β_d	β_d (SF)	β_c / β_d	β_{hs}	β_{ec}	β_{ed}	β_{ed} (SF)	β_{ed} (codes)	CM (dB)	MPR (dB)	AG Index	E-TFCI
1	11/15	15/15	64	11/15	22/15	209/225	1039/225	4	1	1.0	0.0	20	75
2	6/15	15/15	64	6/15	12/15	12/15	12/15	4	1	3.0	2.0	12	67
3	15/15	9/15	64	15/9	30/15	30/15	$\beta_{ed1}:47/15$ $\beta_{ed2}:47/15$	4	2	2.0	1.0	15	92
4	2/15	15/15	64	2/15	4/15	4/15	56/75	4	1	3.0	2.0	17	71
5	15/15	15/15	64	15/15	24/15	30/15	134/15	4	1	1.0	0.0	21	81

9.4. Bluetooth & WLAN Measurement Procedures for SAR

Normal network operating configurations are not suitable for measuring the SAR of 802.11 transmitters in general. Unpredictable fluctuations in network traffic and antenna diversity conditions can introduce undesirable variations in SAR results. The SAR for these devices should be measured using chipset based test mode software to ensure that the results are consistent and reliable.

Chipset based test mode software is hardware dependent and generally varies among manufacturers. The device operating parameters established in a test mode for SAR measurements must be identical to those programmed in production units, including output power levels, amplifier gain settings and other RF performance tuning parameters. The test frequencies should correspond to actual channel frequencies defined for domestic use. SAR for devices with switched diversity should be measured with only one antenna transmitting at a time during each SAR measurement, according to a fixed modulation and data rate. The same data pattern should be used for all measurements.

9.5. SAR Measurement for LTE

SAR tests for LTE are performed with a base station simulator, Anristu MT8820C. Closed loop power control was used so the UE transmits with maximum output power during SAR testing. All powers were measured with the Anristu MT8820C. It is performed for conducted power and SAR based on the KDB941225 D05.

SAR is evaluated separately according to the following procedures for the different test positions in each exposure condition – head, body, body-worn accessories and other use conditions. The procedures in the following subsections are applied separately to test each LTE frequency band.

1) QPSK with 1 RB allocation

Start with the largest channel bandwidth and measure SAR for QPSK with 1 RB allocation, using the RB offset and required test channel combination with the highest maximum output power among RB offsets at the upper edge, middle and lower edge of each required test channel. When the reported SAR is ≤ 0.8 W/kg, testing of the remaining RB offset configurations and required test channels is not required for 1 RB allocation; otherwise, SAR is required for the remaining required test channels and only for the RB offset configuration with the highest output power for that channel. When the reported SAR of a required test channel is > 1.45 W/kg, SAR is required for all three RB offset configurations for that required test channel.

2) QPSK with 50% RB allocation

The procedures required for 1 RB allocation in 1) are applied to measure the SAR for QPSK with 50% RB allocation.

3) QPSK with 100% RB allocation

For QPSK with 100% RB allocation, SAR is not required when the highest maximum output power for 100 % RB allocation is less than the highest maximum output power in 50% and 1 RB allocations and the highest reported SAR for 1 RB and 50% RB allocation in 1) and 2) are ≤ 0.8 W/kg. Otherwise, SAR is measured for the highest output power channel; and if the reported SAR is > 1.45 W/kg, the remaining required test channels must also be tested.



9.6. Power Drift

To control the output power stability during the SAR test, DASY5 system calculates the power drift by measuring the E-field at the same location at the beginning and at the end of the measurement for each test position. These drift values can be found in Section 14 labeled as: (Power Drift [dB]). This ensures that the power drift during one measurement is within 5%.

10. Conducted Output Power

10.1. GSM Measurement result

During the process of testing, the EUT was controlled via Agilent Digital Radio Communication tester (E5515C) to ensure the maximum power transmission and proper modulation. This result contains conducted output power for the EUT. In all cases, the measured peak output power should be greater and within 5% than EMI measurement.

Table 10.1: The conducted power measurement results for GSM

GSM 850MHz	Tune up 33.5	Conducted Power (dBm)		
		Channel 251(848.8MHz)	Channel 190(836.6MHz)	Channel 128(824.2MHz)
		32.41	32.45	32.50
GSM 1900MHz	Tune up 30.5	Conducted Power(dBm)		
		Channel 810(1909.8MHz)	Channel 661(1880MHz)	Channel 512(1850.2MHz)
		29.61	29.42	29.25

Table 10.2: The conducted power measurement results for GPRS and EGPRS

GPRS 850	Tune up	Measured Power (dBm)			calculation	Average Power (dBm)		
		251	190	128		251	190	128
1Tx-slots	33.5	32.43	32.48	32.47	-9.03dB	23.40	23.45	23.44
2Tx-slots	31.5	30.54	30.46	30.44	-6.02dB	24.52	24.44	24.42
3Tx-slots	29.5	28.74	28.66	28.62	-4.26dB	24.48	24.40	24.36
4Tx-slots	28.0	26.74	26.63	26.56	-3.01dB	23.73	23.62	23.55
EGPRS 850 (8PSK)	Tune up	Measured Power (dBm)			calculation	Measured Power (dBm)		
		251	190	128		251	190	128
1Tx-slots	26.5	25.41	25.24	24.93	-9.03dB	16.38	16.21	15.9
2Tx-slots	26.5	24.96	25.28	24.89	-6.02dB	18.94	19.26	18.87
3Tx-slots	25.0	24.09	24.23	23.88	-4.26dB	19.83	19.97	19.62
4Tx-slots	22.5	21.32	21.43	21.40	-3.01dB	18.31	18.42	18.39
GPRS 1900	Tune up	Measured Power (dBm)			calculation	Average Power (dBm)		
		810	661	512		810	661	512
1Tx-slots	30.5	29.93	29.88	29.81	-9.03dB	20.90	20.85	20.78
2Tx-slots	28.5	27.45	27.66	27.60	-6.02dB	21.43	21.64	21.58
3Tx-slots	26.5	26.01	26.21	26.16	-4.26dB	21.75	21.95	21.90
4Tx-slots	25.0	23.93	24.16	24.14	-3.01dB	20.92	21.15	21.13
EGPRS 1900 (8PSK)	Tune up	Measured Power (dBm)			calculation	Measured Power (dBm)		
		810	661	512		810	661	512
1Tx-slots	26.0	24.29	25.17	25.22	-9.03dB	15.26	16.14	16.19
2Tx-slots	26.0	24.20	24.84	25.21	-6.02dB	18.18	18.82	19.19
3Tx-slots	24.5	22.78	23.43	24.21	-4.26dB	18.52	19.17	19.95
4Tx-slots	22.5	20.94	21.90	22.34	-3.01dB	17.93	18.89	19.33



NOTES:

1) Division Factors

To average the power, the division factor is as follows:

1TX-slot = 1 transmit time slot out of 8 time slots=> conducted power divided by (8/1) => -9.03dB

2TX-slots = 2 transmit time slots out of 8 time slots=> conducted power divided by (8/2) => -6.02dB

3TX-slots = 3 transmit time slots out of 8 time slots=> conducted power divided by (8/3) => -4.26dB

4TX-slots = 4 transmit time slots out of 8 time slots=> conducted power divided by (8/4) => -3.01dB

According to the conducted power as above, the body measurements are performed with 2Txslots for 850MHz and 3Txslots for 1900MHz.

10.2. WCDMA Measurement result

Table 10.3: The conducted Power for WCDMA

Item	band	WCDMA Band 2 result			
	ARFCN	Tune up	9538 (1907.6MHz)	9400 (1880MHz)	9262 (1852.4MHz)
WCDMA	\	23.5	22.7	22.6	22.5
HSUPA	1	21.5	20.0	20.2	20.1
	2	21.5	20.5	20.7	20.6
	3	21.5	20.3	20.5	20.4
	4	21.5	20.7	21.0	20.9
	5	23	22.8	22.7	22.8
HSDPA	1	23	22.7	22.8	22.8
	2	23	22.4	22.5	22.5
	3	23	22.1	22.3	22.3
	4	23	22.2	22.2	22.3
Item	band	WCDMA Band 4 result			
	ARFCN	Tune up	1513 (1752.6MHz)	1413 (1732.6MHz)	1312 (1712.4MHz)
WCDMA	\	23.5	22.7	22.8	22.8
HSUPA	1	23	22.0	21.8	21.8
	2	23	22.4	22.0	22.0
	3	23	22.1	21.7	21.7
	4	23	22.4	22.2	22.2
	5	23.5	22.8	22.6	22.5
HSDPA	1	23.5	22.9	22.9	23.1
	2	23.5	22.8	22.8	23.0
	3	23.5	22.7	22.7	22.8
	4	23.5	22.8	22.8	22.8
Item	band	WCDMA Band 5 result			
	ARFCN	Tune up	4233 (846.6MHz)	4182 (836.4MHz)	4132 (826.4MHz)
WCDMA	\	23.5	22.6	22.8	22.9
HSUPA	1	21.5	20.1	20.2	20.0
	2	21.5	20.3	20.4	20.3
	3	21.5	20.1	20.2	20.1
	4	21.5	20.2	20.2	20.1
	5	23	21.8	22.1	21.8
HSDPA	1	23	22.1	22.3	22.1
	2	23	21.9	22.0	21.8
	3	23	21.4	21.6	21.4
	4	23	21.4	21.6	21.4

Receiver on

Item	band	WCDMA Band 2 result			
	ARFCN	Tune up	9538 (1907.6MHz)	9400 (1880MHz)	9262 (1852.4MHz)
WCDMA	\	22.5	21.8	21.8	21.7
HSUPA	1	21.0	19.2	19.2	19.1
	2	21.0	19.8	19.9	19.8
	3	21.0	19.6	19.6	19.6
	4	21.0	20.1	20.2	20.2
	5	22.5	21.9	22.3	22.1
HSDPA	1	22.5	21.9	22.0	21.9
	2	22.5	21.6	21.8	21.6
	3	22.5	21.4	21.6	21.4
	4	22.5	21.4	21.6	21.4
Item	band	WCDMA Band 4 result			
	ARFCN	Tune up	1513 (1752.6MHz)	1413 (1732.6MHz)	1312 (1712.4MHz)
WCDMA	\	21.5	20.8	21.2	21.3
HSUPA	1	21.5	19.5	19.5	19.7
	2	21.5	19.9	19.8	20.0
	3	21.5	19.6	20.3	20.3
	4	21.5	20.0	20.1	20.3
	5	21.5	20.2	20.3	20.4
HSDPA	1	21.5	20.4	20.4	20.8
	2	21.5	20.4	20.4	20.7
	3	21.5	20.4	20.4	20.6
	4	21.5	20.4	20.5	20.6

10.3. LTE Measurement result

Table 10.4: The conducted Power for LTE

LTE-FDD Band 2				Actual output Power (dBm)			Tune up
Band-width	RB allocation	RB offset	Modulation	High	Middle	Low	
1.4 MHz				1909.3MHz	1880MHz	1850.7MHz	
	1RB	High	QPSK	23.25	23.30	23.06	24
			16QAM	22.39	21.86	22.20	23
		Middle	QPSK	23.30	23.24	23.05	24
			16QAM	22.39	21.88	22.18	23
		Low	QPSK	23.25	23.27	23.03	24
			16QAM	22.41	21.90	22.24	23
	3RB	High	QPSK	23.40	23.35	23.17	24
			16QAM	22.63	22.25	22.47	23
		Middle	QPSK	23.43	23.27	23.21	24
			16QAM	22.65	22.24	22.47	23
		Low	QPSK	23.39	23.37	23.15	24
			16QAM	22.63	22.21	22.48	23
	6RB	/	QPSK	22.39	22.28	22.20	23
16QAM			21.34	21.22	21.13	22	
3 MHz				1908.5MHz	1880MHz	1851.5MHz	/
	1RB	High	QPSK	23.30	23.21	23.02	24
			16QAM	22.90	22.41	22.66	23
		Middle	QPSK	23.31	23.17	23.03	24
			16QAM	22.93	22.46	22.76	23
		Low	QPSK	23.27	23.21	23.10	24
			16QAM	22.91	22.47	22.78	23
	8RB	High	QPSK	22.27	22.26	22.15	23
			16QAM	21.50	21.38	21.31	22
		Middle	QPSK	22.37	22.31	22.18	23
			16QAM	21.50	21.40	21.34	22
		Low	QPSK	22.30	22.28	22.21	23
			16QAM	21.51	21.41	21.37	22
	15RB	/	QPSK	22.32	22.28	22.23	23
16QAM			21.46	21.36	21.33	22	



LTE-FDD Band 2				Actual output Power (dBm)			Tune up
Band-width	RB allocation	RB offset	Modulation	High	Middle	Low	
5 MHz				1907.5MHz	1880MHz	1852.5MHz	
	1RB	High	QPSK	23.19	23.11	23.05	24
			16QAM	22.91	22.82	22.71	23
		Middle	QPSK	23.20	23.08	23.05	24
			16QAM	22.91	22.81	22.74	23
		Low	QPSK	23.20	23.13	23.02	24
			16QAM	22.91	22.81	22.76	23
	12RB	High	QPSK	22.31	22.18	22.09	23
			16QAM	21.45	21.34	21.27	22
		Middle	QPSK	22.29	22.26	22.12	23
			16QAM	21.44	21.39	21.24	22
		Low	QPSK	22.33	22.20	22.17	23
			16QAM	21.47	21.34	21.33	22
	25RB	/	QPSK	22.36	22.20	22.18	23
16QAM			21.38	21.26	21.23	22	
10 MHz				1905MHz	1880MHz	1855MHz	/
	1RB	High	QPSK	23.26	23.19	23.12	24
			16QAM	22.38	22.83	22.17	23
		Middle	QPSK	23.26	23.14	23.10	24
			16QAM	22.35	22.83	22.21	23
		Low	QPSK	23.22	23.18	23.13	24
			16QAM	22.31	22.84	22.25	23
	25RB	High	QPSK	22.36	22.20	22.09	23
			16QAM	21.54	21.28	21.40	22
		Middle	QPSK	22.31	22.25	22.20	23
			16QAM	21.58	21.29	21.46	22
		Low	QPSK	22.38	22.25	22.18	23
			16QAM	21.62	21.23	21.46	22
	50RB	/	QPSK	22.36	22.24	22.18	23
16QAM			21.41	21.35	21.27	22	



LTE-FDD Band 2				Actual output Power (dBm)			Tune up
Band-width	RB allocation	RB offset	Modulation	High	Middle	Low	
15 MHz				1902.5MHz	1880MHz	1857.5MHz	
	1RB	High	QPSK	23.17	23.04	23.03	24
			16QAM	22.34	22.87	22.19	23
		Middle	QPSK	23.19	23.03	22.99	24
			16QAM	22.40	22.86	22.19	23
		Low	QPSK	23.13	23.07	23.08	24
			16QAM	22.32	22.90	22.27	23
	36RB	High	QPSK	22.31	22.24	22.12	23
			16QAM	21.49	21.21	21.34	22
		Middle	QPSK	22.32	22.28	22.12	23
			16QAM	21.55	21.26	21.34	22
		Low	QPSK	22.26	22.24	22.21	23
			16QAM	21.49	21.24	21.34	22
	75RB	/	QPSK	22.35	22.24	22.22	23
16QAM			21.40	21.40	21.22	22	
20 MHz				1900MHz	1880MHz	1860MHz	/
	1RB	High	QPSK	23.19	23.22	23.00	24
			16QAM	22.90	21.85	22.74	23
		Middle	QPSK	23.17	23.23	23.05	24
			16QAM	22.86	21.76	22.78	23
		Low	QPSK	23.12	23.32	23.07	24
			16QAM	22.89	21.83	22.82	23
	50RB	High	QPSK	22.36	22.21	22.24	23
			16QAM	21.33	21.33	21.30	22
		Middle	QPSK	22.22	22.26	22.23	23
			16QAM	21.41	21.36	21.24	22
		Low	QPSK	22.22	22.29	22.30	23
			16QAM	21.39	21.32	21.26	22
	100RB	/	QPSK	22.28	22.21	22.24	23
16QAM			21.43	21.35	21.26	22	



Full Power

LTE-FDD Band 4				Actual output Power (dBm)			Tune up
Band-width	RB allocation	RB offset	Modulation	High	Middle	Low	
1.4 MHz				1754.3MHz	1732.5MHz	1710.7MHz	
	1RB	High	QPSK	23.22	23.35	23.33	24
			16QAM	23.07	23.02	23.07	23
		Middle	QPSK	23.27	23.36	23.32	24
			16QAM	23.06	23.02	23.06	23
		Low	QPSK	23.27	23.35	23.32	24
			16QAM	23.05	23.01	23.07	23
	3RB	High	QPSK	23.38	23.45	23.45	24
			16QAM	22.66	22.79	22.77	23
		Middle	QPSK	23.46	23.41	23.49	24
			16QAM	22.71	22.79	22.81	23
		Low	QPSK	23.43	23.50	23.42	24
			16QAM	22.71	22.82	22.90	23
	6RB	/	QPSK	22.35	22.46	22.52	23
16QAM			21.11	21.25	21.27	22	
3 MHz				1753.5MHz	1732.5MHz	1711.5MHz	/
	1RB	High	QPSK	23.26	23.37	23.42	24
			16QAM	22.54	22.48	22.48	23
		Middle	QPSK	23.27	23.38	23.43	24
			16QAM	22.50	22.46	22.50	23
		Low	QPSK	23.28	23.37	23.43	24
			16QAM	22.53	22.50	22.50	23
	8RB	High	QPSK	22.32	22.41	22.38	23
			16QAM	21.63	21.68	21.68	22
		Middle	QPSK	22.37	22.38	22.44	23
			16QAM	21.68	21.65	21.70	22
		Low	QPSK	22.32	22.34	22.43	23
			16QAM	21.65	21.64	21.66	22
	15RB	/	QPSK	22.32	22.44	22.55	23
16QAM			21.59	21.62	21.67	22	



Full Power

LTE-FDD Band 4				Actual output Power (dBm)			Tune up
Band-width	RB allocation	RB offset	Modulation	High	Middle	Low	
5 MHz				1752.5MHz	1732.5MHz	1712.5MHz	
	1RB	High	QPSK	23.15	23.26	23.30	24
			16QAM	23.02	22.93	22.99	23
		Middle	QPSK	23.19	23.30	23.32	24
			16QAM	22.97	23.02	23.02	23
		Low	QPSK	23.18	23.35	23.35	24
			16QAM	23.04	23.02	23.08	23
	12RB	High	QPSK	22.29	22.43	22.42	23
			16QAM	21.46	21.54	21.52	22
		Middle	QPSK	22.36	22.39	22.37	23
			16QAM	21.47	21.51	21.59	22
		Low	QPSK	22.37	22.37	22.45	23
			16QAM	21.45	21.53	21.57	22
	25RB	/	QPSK	22.28	22.38	22.44	23
16QAM			21.40	21.50	21.49	22	
10 MHz				1750MHz	1732.5MHz	1715MHz	/
	1RB	High	QPSK	23.29	23.33	23.40	24
			16QAM	22.41	22.40	22.45	23
		Middle	QPSK	23.33	23.34	23.42	24
			16QAM	22.44	22.45	22.46	23
		Low	QPSK	23.36	23.44	23.43	24
			16QAM	22.46	22.52	22.50	23
	25RB	High	QPSK	22.38	22.42	22.48	23
			16QAM	21.71	21.67	21.75	22
		Middle	QPSK	22.42	22.40	22.45	23
			16QAM	21.73	21.69	21.74	22
		Low	QPSK	22.38	22.40	22.50	23
			16QAM	21.73	21.73	21.75	22
	50RB	/	QPSK	22.38	22.42	22.46	23
16QAM			21.53	21.55	21.54	22	



Full Power

LTE-FDD Band 4				Actual output Power (dBm)			Tune up
Band-width	RB allocation	RB offset	Modulation	High	Middle	Low	
15 MHz				1747.5MHz	1732.5MHz	1717.5MHz	
	1RB	High	QPSK	23.26	23.23	23.34	24
			16QAM	22.38	22.89	22.98	23
		Middle	QPSK	23.34	23.34	23.36	24
			16QAM	22.44	23.02	23.05	23
		Low	QPSK	23.36	23.44	23.34	24
			16QAM	22.49	23.05	23.09	23
	36RB	High	QPSK	22.27	22.37	22.48	23
			16QAM	21.53	21.42	21.51	22
		Middle	QPSK	22.39	22.45	22.40	23
			16QAM	21.59	21.47	21.55	22
		Low	QPSK	22.38	22.38	22.47	23
			16QAM	21.59	21.52	21.53	22
	75RB	/	QPSK	22.36	22.40	22.42	23
16QAM			21.42	21.54	21.59	22	
20 MHz				1745MHz	1732.5MHz	1720MHz	/
	1RB	High	QPSK	23.14	23.21	23.26	24
			16QAM	23.01	22.89	22.94	23
		Middle	QPSK	23.19	23.29	23.35	24
			16QAM	23.03	22.98	23.05	23
		Low	QPSK	23.29	23.34	23.37	24
			16QAM	23.13	23.05	23.11	23
	50RB	High	QPSK	22.26	22.35	22.37	23
			16QAM	21.50	21.41	21.54	22
		Middle	QPSK	22.37	22.44	22.50	23
			16QAM	21.47	21.50	21.54	22
		Low	QPSK	22.30	22.39	22.50	23
			16QAM	21.55	21.49	21.54	22
	100RB	/	QPSK	22.38	22.42	22.53	23
16QAM			21.51	21.50	21.60	22	



Receiver on

LTE-FDD Band 4				Actual output Power (dBm)			Tune up
Band-width	RB allocation	RB offset	Modulation	High	Middle	Low	
1.4 MHz				1754.3MHz	1732.5MHz	1710.7MHz	
	1RB	High	QPSK	21.02	20.97	21.00	22
			16QAM	20.28	20.75	20.74	21
		Middle	QPSK	21.02	20.99	21.05	22
			16QAM	20.29	20.70	20.79	21
		Low	QPSK	21.01	20.99	21.03	22
			16QAM	20.35	20.75	20.70	21
	3RB	High	QPSK	21.14	21.12	21.19	22
			16QAM	20.39	20.47	20.47	21
		Middle	QPSK	21.20	21.20	21.14	22
			16QAM	20.38	20.46	20.50	21
		Low	QPSK	21.20	21.13	21.15	22
			16QAM	20.46	20.41	20.49	21
	6RB	/	QPSK	20.12	20.16	20.15	21
16QAM			18.84	19.26	19.24	20	
3 MHz				1753.5MHz	1732.5MHz	1711.5MHz	/
	1RB	High	QPSK	20.99	21.12	21.10	22
			16QAM	20.26	20.65	20.70	21
		Middle	QPSK	21.03	21.11	21.11	22
			16QAM	20.32	20.65	20.73	21
		Low	QPSK	21.00	21.16	21.11	22
			16QAM	20.32	20.77	20.72	21
	8RB	High	QPSK	20.06	20.15	20.13	21
			16QAM	18.95	19.30	19.35	20
		Middle	QPSK	20.13	20.09	20.17	21
			16QAM	19.13	19.34	19.40	20
		Low	QPSK	20.18	20.18	20.10	21
			16QAM	19.21	19.34	19.36	20
	15RB	/	QPSK	20.16	20.15	20.11	21
16QAM			19.01	19.31	19.36	20	



Receiver on

LTE-FDD Band 4				Actual output Power (dBm)			Tune up
Band-width	RB allocation	RB offset	Modulation	High	Middle	Low	
5 MHz				1752.5MHz	1732.5MHz	1712.5MHz	
	1RB	High	QPSK	20.88	20.94	21.00	22
			16QAM	20.59	20.70	20.70	21
		Middle	QPSK	20.86	21.01	21.05	22
			16QAM	20.64	20.65	20.76	21
		Low	QPSK	20.88	20.97	21.03	22
			16QAM	20.66	20.78	20.78	21
	12RB	High	QPSK	20.12	20.12	20.10	21
			16QAM	18.91	19.21	19.28	20
		Middle	QPSK	20.09	20.08	20.13	21
			16QAM	19.28	19.37	19.48	20
		Low	QPSK	20.07	20.19	20.15	21
			16QAM	19.26	19.24	19.33	20
	25RB	/	QPSK	20.02	20.15	20.15	21
16QAM			19.19	19.24	19.34	20	
10 MHz				1750MHz	1732.5MHz	1715MHz	/
	1RB	High	QPSK	21.03	21.04	21.06	22
			16QAM	20.08	20.65	20.73	21
		Middle	QPSK	21.04	21.18	21.15	22
			16QAM	20.17	20.68	20.72	21
		Low	QPSK	21.06	21.21	21.15	22
			16QAM	20.17	20.77	20.77	21
	25RB	High	QPSK	20.07	20.10	20.14	21
			16QAM	19.31	19.40	19.53	20
		Middle	QPSK	20.10	20.13	20.16	21
			16QAM	19.40	19.33	19.46	20
		Low	QPSK	20.08	20.21	20.23	21
			16QAM	19.40	19.22	19.36	20
	50RB	/	QPSK	20.08	20.10	20.27	21
16QAM			19.41	19.35	19.50	20	



Receiver on

LTE-FDD Band 4				Actual output Power (dBm)			Tune up
Band-width	RB allocation	RB offset	Modulation	High	Middle	Low	
15 MHz				1747.5MHz	1732.5MHz	1717.5MHz	
	1RB	High	QPSK	20.97	20.91	20.94	22
			16QAM	20.48	20.64	20.64	21
		Middle	QPSK	21.03	20.99	21.08	22
			16QAM	20.69	20.65	20.70	21
		Low	QPSK	21.09	21.00	21.04	22
			16QAM	20.71	20.70	20.76	21
	36RB	High	QPSK	20.01	20.17	20.10	21
			16QAM	19.05	19.19	19.37	20
		Middle	QPSK	20.10	20.06	20.23	21
			16QAM	19.31	19.17	19.26	20
		Low	QPSK	20.18	20.25	20.17	21
			16QAM	19.50	19.13	19.25	20
	75RB	/	QPSK	20.06	20.08	20.23	21
16QAM			19.22	19.16	19.29	20	
20 MHz				1745MHz	1732.5MHz	1720MHz	/
	1RB	High	QPSK	20.91	20.93	20.98	22
			16QAM	20.84	20.59	20.66	21
		Middle	QPSK	20.94	21.01	21.08	22
			16QAM	20.87	20.66	20.76	21
		Low	QPSK	21.05	21.03	21.11	22
			16QAM	20.89	20.69	20.79	21
	50RB	High	QPSK	20.09	20.16	20.02	21
			16QAM	19.37	19.25	19.61	20
		Middle	QPSK	20.11	20.11	20.08	21
			16QAM	19.43	19.25	19.38	20
		Low	QPSK	20.14	20.21	20.09	21
			16QAM	19.57	19.01	19.18	20
	100RB	/	QPSK	20.15	20.10	20.19	21
16QAM			19.50	19.17	19.43	20	



LTE-FDD Band 5				Actual output Power (dBm)			Tune up
Band-width	RB allocation	RB offset	Modulation	High	Middle	Low	
1.4 MHz				848.3MHz	836.5MHz	824.7MHz	
	1RB	High	QPSK	23.24	23.06	23.03	24
			16QAM	22.59	22.71	22.70	23
		Middle	QPSK	23.21	23.05	23.00	24
			16QAM	22.56	22.69	22.65	23
		Low	QPSK	23.25	23.08	23.09	24
			16QAM	22.59	22.67	22.73	23
	3RB	High	QPSK	23.39	23.27	23.28	24
			16QAM	22.45	22.55	22.54	23
		Middle	QPSK	23.37	23.30	23.18	24
			16QAM	22.51	22.59	22.55	23
		Low	QPSK	23.33	23.24	23.23	24
			16QAM	22.52	22.58	22.57	23
	6RB	/	QPSK	22.30	22.24	22.23	23
16QAM			20.98	20.95	20.92	22	
3 MHz				847.5MHz	836.5MHz	825.5MHz	/
	1RB	High	QPSK	23.31	23.07	23.08	23
			16QAM	22.29	22.21	22.20	22
		Middle	QPSK	23.26	23.12	23.05	23
			16QAM	22.27	22.19	22.17	22
		Low	QPSK	23.24	23.04	23.03	23
			16QAM	22.26	22.16	22.22	22
	8RB	High	QPSK	22.27	22.19	22.22	23
			16QAM	21.39	21.29	21.31	22
		Middle	QPSK	22.30	22.20	22.17	23
			16QAM	21.35	21.32	21.25	22
		Low	QPSK	22.20	22.12	22.09	23
			16QAM	21.39	21.29	21.28	22
	15RB	/	QPSK	22.33	22.15	22.11	23
16QAM			21.41	21.35	21.27	22	



LTE-FDD Band 5				Actual output Power (dBm)			Tune up
Band-width	RB allocation	RB offset	Modulation	High	Middle	Low	
5 MHz				846.5MHz	836.5MHz	826.5MHz	
	1RB	High	QPSK	23.22	23.18	23.09	23
			16QAM	22.79	22.81	22.74	22
		Middle	QPSK	23.21	23.13	23.13	23
			16QAM	22.80	22.76	22.75	22
		Low	QPSK	23.18	23.13	23.08	23
			16QAM	22.82	22.76	22.76	22
	12RB	High	QPSK	22.31	22.29	22.28	23
			16QAM	21.36	21.30	21.25	22
		Middle	QPSK	22.33	22.28	22.26	23
			16QAM	21.35	21.32	21.32	22
		Low	QPSK	22.26	22.22	22.25	23
			16QAM	21.35	21.27	21.24	22
	25RB	/	QPSK	22.23	22.27	22.25	23
16QAM			21.28	21.30	21.18	22	
10 MHz				844MHz	836.5MHz	829MHz	/
	1RB	High	QPSK	23.41	23.31	23.25	23
			16QAM	22.36	22.32	22.74	22
		Middle	QPSK	23.34	23.28	23.18	23
			16QAM	22.31	22.27	22.72	22
		Low	QPSK	23.24	23.19	23.25	23
			16QAM	22.35	22.26	22.78	22
	25RB	High	QPSK	22.32	22.30	22.32	23
			16QAM	21.52	21.51	21.18	22
		Middle	QPSK	22.34	22.27	22.27	23
			16QAM	21.54	21.49	21.23	22
		Low	QPSK	22.30	22.36	22.26	23
			16QAM	21.53	21.47	21.20	22
	50RB	/	QPSK	22.30	22.30	22.23	23
16QAM			21.37	21.33	21.28	22	



Full Power

LTE-FDD Band 7				Actual output Power (dBm)			Tune up
Band-width	RB allocation	RB offset	Modulation	High	Middle	Low	
5 MHz				2567.4MHz	2535MHz	2502.5MHz	
	1RB	High	QPSK	22.99	23.08	23.07	24
			16QAM	22.40	22.92	22.90	23
		Middle	QPSK	23.09	23.04	23.05	24
			16QAM	22.41	22.96	22.93	23
		Low	QPSK	23.06	23.02	23.05	24
			16QAM	22.39	22.97	22.93	23
	12RB	High	QPSK	22.36	22.31	22.21	23
			16QAM	21.55	21.41	21.36	22
		Middle	QPSK	22.41	22.33	22.15	23
			16QAM	21.56	21.39	21.35	22
		Low	QPSK	22.36	22.21	22.21	23
			16QAM	21.54	21.39	21.34	22
	25RB	/	QPSK	22.24	22.21	22.24	23
16QAM			21.67	21.34	21.29	22	
10 MHz				2565MHz	2535MHz	2505MHz	/
	1RB	High	QPSK	22.76	22.78	22.66	24
			16QAM	22.30	22.61	22.57	23
		Middle	QPSK	22.75	22.65	22.62	24
			16QAM	22.31	22.55	22.52	23
		Low	QPSK	22.69	22.59	22.58	24
			16QAM	22.27	22.58	22.48	23
	25RB	High	QPSK	21.85	21.87	21.85	23
			16QAM	21.29	21.00	20.90	22
		Middle	QPSK	21.91	21.84	21.73	23
			16QAM	21.23	20.93	20.93	22
		Low	QPSK	21.92	21.80	21.78	23
			16QAM	21.27	21.01	20.86	22
	50RB	/	QPSK	21.86	21.85	21.75	23
16QAM			21.03	20.94	20.99	22	



Full Power

LTE-FDD Band 7				Actual output Power (dBm)			Tune up
Band-width	RB allocation	RB offset	Modulation	High	Middle	Low	
15 MHz				2562.5MHz	2535MHz	2507.5MHz	
	1RB	High	QPSK	22.75	22.78	22.72	24
			16QAM	22.76	22.18	22.67	23
		Middle	QPSK	22.75	22.73	22.66	24
			16QAM	22.79	22.11	22.66	23
		Low	QPSK	22.64	22.57	22.62	24
			16QAM	22.76	22.05	22.57	23
	36RB	High	QPSK	21.96	21.95	21.91	23
			16QAM	21.04	21.18	20.84	22
		Middle	QPSK	21.84	21.85	21.88	23
			16QAM	20.97	21.12	20.94	22
		Low	QPSK	21.93	21.81	21.79	23
			16QAM	20.98	21.07	20.99	22
	75RB	/	QPSK	21.90	21.87	21.75	23
16QAM			21.16	21.00	20.88	22	
20 MHz				2560MHz	2535MHz	2510MHz	/
	1RB	High	QPSK	22.86	22.80	22.75	24
			16QAM	22.24	22.31	22.65	23
		Middle	QPSK	22.75	22.66	22.70	24
			16QAM	22.20	22.22	22.49	23
		Low	QPSK	22.69	22.57	22.66	24
			16QAM	22.10	22.09	22.46	23
	50RB	High	QPSK	21.86	21.83	21.82	23
			16QAM	21.11	21.05	21.04	22
		Middle	QPSK	21.87	21.84	21.77	23
			16QAM	21.02	21.01	20.90	22
		Low	QPSK	21.86	21.75	21.83	23
			16QAM	21.02	20.99	20.94	22
	100RB	/	QPSK	21.81	21.83	21.83	23
16QAM			21.00	21.05	20.95	22	



Receiver on

LTE-FDD Band 7				Actual output Power (dBm)			Tune up
Band-width	RB allocation	RB offset	Modulation	High	Middle	Low	
5 MHz				2567.4MHz	2535MHz	2502.5MHz	
	1RB	High	QPSK	20.77	20.82	20.74	21.5
			16QAM	20.61	19.96	19.90	21.5
		Middle	QPSK	20.80	20.68	20.76	21.5
			16QAM	20.60	19.92	19.89	21.5
		Low	QPSK	20.77	20.75	20.71	21.5
			16QAM	20.65	19.97	19.85	21.5
	12RB	High	QPSK	19.95	19.94	19.89	21.5
			16QAM	20.74	20.76	20.49	21.5
		Middle	QPSK	19.85	19.95	19.82	21.5
			16QAM	20.96	20.90	20.38	21.5
		Low	QPSK	19.90	19.99	19.87	21.5
			16QAM	20.95	20.87	20.21	21.5
	25RB	/	QPSK	19.85	19.98	19.89	21.5
16QAM			20.79	20.76	20.24	21.5	
10 MHz				2565MHz	2535MHz	2505MHz	/
	1RB	High	QPSK	20.36	20.42	20.33	21.5
			16QAM	19.98	20.25	19.91	21.5
		Middle	QPSK	20.32	20.36	20.32	21.5
			16QAM	20.01	20.14	19.86	21.5
		Low	QPSK	20.36	20.30	20.27	21.5
			16QAM	19.98	20.15	19.83	21.5
	25RB	High	QPSK	19.62	19.58	19.52	21.5
			16QAM	20.86	20.89	20.65	21.5
		Middle	QPSK	19.62	19.56	19.44	21.5
			16QAM	20.88	20.86	20.38	21.5
		Low	QPSK	19.56	19.49	19.43	21.5
			16QAM	20.84	20.81	20.23	21.5
	50RB	/	QPSK	19.54	19.57	19.51	21.5
16QAM			20.80	20.78	20.38	21.5	



Receiver on

LTE-FDD Band 7				Actual output Power (dBm)			Tune up
Band-width	RB allocation	RB offset	Modulation	High	Middle	Low	
15 MHz				2562.5MHz	2535MHz	2507.5MHz	
	1RB	High	QPSK	20.44	20.46	20.45	21.5
			16QAM	19.90	19.87	20.30	21.5
		Middle	QPSK	20.43	20.47	20.34	21.5
			16QAM	19.85	19.79	20.20	21.5
		Low	QPSK	20.38	20.30	20.30	21.5
			16QAM	19.86	19.79	20.15	21.5
	36RB	High	QPSK	19.62	19.54	19.51	21.5
			16QAM	20.69	20.73	20.61	21.5
		Middle	QPSK	19.57	19.58	19.51	21.5
			16QAM	20.71	20.83	20.47	21.5
		Low	QPSK	19.53	19.55	19.52	21.5
			16QAM	20.73	20.95	20.36	21.5
	75RB	/	QPSK	19.59	19.51	19.44	21.5
16QAM			20.63	20.82	20.47	21.5	
20 MHz				2560MHz	2535MHz	2510MHz	/
	1RB	High	QPSK	20.56	20.58	20.47	21.5
			16QAM	20.23	19.98	19.86	21.5
		Middle	QPSK	20.55	20.38	20.48	21.5
			16QAM	20.23	19.89	19.74	21.5
		Low	QPSK	20.51	20.29	20.40	21.5
			16QAM	20.21	19.76	19.65	21.5
	50RB	High	QPSK	19.63	19.65	19.57	21.5
			16QAM	20.97	20.82	21.22	21.5
		Middle	QPSK	19.61	19.45	19.49	21.5
			16QAM	21.04	20.84	20.80	21.5
		Low	QPSK	19.61	19.51	19.40	21.5
			16QAM	20.98	20.87	20.42	21.5
	100RB	/	QPSK	19.59	19.59	19.54	21.5
16QAM			20.91	20.84	20.69	21.5	

10.4. WLAN and BT Measurement result

The highest BT power is 6.36dBm and tune up is 7dBm.

Table 10.5: The conducted Power measurement results for 2.4G WLAN

WiFi 2.4GHz	Tune up	Averaged Power (dBm)	Tune up	Averaged Power (dBm)	Tune up	Averaged Power (dBm)
Mode	Ch.1(2412 MHz)		Ch.6(2437Mhz)		Ch.11(2462MHz)	
802.11b	15	14.35	14.5	13.03	15	13.62
802.11g	13	11.90	12.5	10.84	13	12.02
802.11n(20MHz)	12	11.18	11.5	10.14	12	11.42

The Duty Cycle is 100%

11. Simultaneous TX SAR Considerations

11.1. Introduction

The following procedures adopted from “FCC SAR Considerations for Cell Phones with Multiple Transmitters” are applicable to handsets with built-in unlicensed transmitters such as 802.11 a/b/g and Bluetooth devices which may simultaneously transmit with the licensed transmitter. For this device, the BT and WLAN can transmit simultaneous with other transmitters.

11.2. Transmit Antenna Separation Distances



Picture 12.1 Antenna Locations

11.3. Standalone SAR Test Exclusion Considerations

Standalone 1-g head or body SAR evaluation by measurement or numerical simulation is not required when the corresponding SAR Exclusion Threshold condition, listed below, is satisfied. The 1-g SAR test exclusion threshold for 100 MHz to 6 GHz at test separation distances ≤ 50 mm are determined by:

$[(\text{max. power of channel, including tune-up tolerance, mW}) / (\text{min. test separation distance, mm})] \cdot [\sqrt{f(\text{GHz})}] \leq 3.0$ for 1-g SAR, where

- f(GHz) is the RF channel transmit frequency in GHz
- Power and distance are rounded to the nearest mW and mm before calculation
- The result is rounded to one decimal place for comparison

Table 11.1: Standalone SAR test exclusion considerations

Band/Mode	f(GHz)	Position	SAR test exclusion threshold (mW)	RF output power		SAR test exclusion
				dBm	mW	
Bluetooth	2.441	Next to the mouth	19.20	7	5.01	Yes
		wrist-worn	9.60	7	5.01	Yes
WLAN 2.4GHz	2.45	Next to the mouth	19.17	17.5	56.23	No
		wrist-worn	9.58	17.5	56.23	No

12. Evaluation of Simultaneous

Table 12.1: The sum of reported SAR values for main antenna and WLAN

/	Position	Main antenna	WLAN	Sum
Highest reported SAR 1g (W/Kg)	Next to the mouth	1.14	0.34	1.48
Highest reported SAR 10g (W/Kg)	wrist-worn	1.57	0.41	1.98

Table 12.2: The sum of reported SAR values for main antenna and Bluetooth

/	Position	Main antenna	BT*	Sum
Highest reported SAR 1g (W/Kg)	Next to the mouth	1.14	0.10	1.24
Highest reported SAR 10g (W/Kg)	wrist-worn	1.57	0.21	1.78

BT* - Estimated SAR for Bluetooth (see the table 12.3)

Table 12.3: Estimated SAR for Bluetooth

Position	f (GHz)	Distance (mm)	Upper limit of power *		Estimated _{1g} (W/kg)
			dBm	mW	
Next to the mouth	2.441	10	7	5.01	0.10
wrist-worn	2.441	5	7	5.01	0.21

* - Maximum possible output power declared by manufacturer

When standalone SAR test exclusion applies to an antenna that transmits simultaneously with other antennas, the standalone SAR must be estimated according to following to determine simultaneous transmission SAR test exclusion:

(max. power of channel, including tune-up tolerance, mW) / (min. test separation distance, mm) · [$\sqrt{f(\text{GHz})/x}$] W/kg for test separation distances ≤ 50 mm;

Where $x = 7.5$ for 1-g SAR.

When the minimum test separation distance is < 5 mm, a distance of 5 mm is applied to determine SAR test exclusion

Conclusion:

According to the above tables, the sum of reported SAR values is less than limit. So the simultaneous transmission SAR with volume scans is not required.

13. Summary of Test Results

According to the client's decision rule in the test registration form, which is "based on the measurement results as the basis of the conformity statement", the test conclusion of this report meets the limit requirements.

The calculated SAR is obtained by the following formula:

$$\text{Reported SAR} = \text{Measured SAR} \times 10^{(P_{\text{Target}} - P_{\text{Measured}})/10}$$

Where P_{Target} is the power of manufacturing upper limit;

P_{Measured} is the measured power in chapter 10.

Duty Cycle

Mode	Duty Cycle
Speech for GSM850/1900	1:8.3
GPRS for GSM850	1:4
GPRS for GSM1900	1:2.67
WCDMA 850/1700/1900	1:1
FDD LTE Band 2/4/5/7	1:1

13.1. SAR results

Table 13.1: SAR Values - GSM 850

Frequency		Test Mode	Test Position	Figure No.	Conducted Power (dBm)	Max. tune-up Power (dBm)	Measured SAR(1g) (W/kg)	Reported SAR(1g) (W/kg)	Power Drift (dB)
Ambient Temperature: 22.5°C	Liquid Temperature: 22.0°C								
MHz	Ch.								
836.6	190	Speech	Next to the mouth	Fig.1	32.45	33.5	0.277	0.35	-0.12
Frequency		Test Mode	Test Position	Figure No.	Conducted Power (dBm)	Max. tune-up Power (dBm)	Measured SAR(10g) (W/kg)	Reported SAR(10g) (W/kg)	Power Drift (dB)
MHz	Ch.								
836.6	190	GPRS	Wrist Worn	Fig.2	30.46	31.5	0.598	0.76	-0.13

Table 13.2: SAR Values - GSM 1900

Frequency		Test Mode	Test Position	Figure No.	Conducted Power (dBm)	Max. tune-up Power (dBm)	Measured SAR(1g) (W/kg)	Reported SAR(1g) (W/kg)	Power Drift (dB)
Ambient Temperature: 22.5°C	Liquid Temperature: 22.0°C								
MHz	Ch.								
1880	661	Speech	Next to the mouth	Fig.3	29.42	30.5	0.445	0.57	0.01
Frequency		Test Mode	Test Position	Figure No.	Conducted Power (dBm)	Max. tune-up Power (dBm)	Measured SAR(10g) (W/kg)	Reported SAR(10g) (W/kg)	Power Drift (dB)
MHz	Ch.								
1880	661	GPRS	Wrist Worn	Fig.4	26.21	26.5	0.764	0.82	0.04

Table 13.3: SAR Values - WCDMA Band 5

Frequency		Test Mode	Test Position	Figure No.	Conducted Power (dBm)	Max. tune-up Power (dBm)	Measured SAR(1g) (W/kg)	Reported SAR(1g) (W/kg)	Power Drift (dB)
Ambient Temperature: 22.5°C	Liquid Temperature: 22.0°C								
MHz	Ch.								
836.4	4182	RMC	Next to the mouth	Fig.5	22.80	23.5	0.198	0.23	-0.11
Frequency		Test Mode	Test Position	Figure No.	Conducted Power (dBm)	Max. tune-up Power (dBm)	Measured SAR(10g) (W/kg)	Reported SAR(10g) (W/kg)	Power Drift (dB)
MHz	Ch.								
836.4	4182	RMC	Wrist Worn	Fig.6	22.80	23.5	0.330	0.39	0.10

Table 13.4: SAR Values – WCDMA Band 2

Ambient Temperature: 22.5°C					Liquid Temperature: 22.0°C				
Frequency		Test Mode	Test Position	Figure No.	Conducted Power (dBm)	Max. tune-up Power (dBm)	Measured SAR(1g) (W/kg)	Reported SAR(1g) (W/kg)	Power Drift (dB)
MHz	Ch.								
1907.6	9538	RMC	Next to the mouth	Fig.7	21.80	22.5	0.894	1.05	0.09
1880	9400	RMC	Next to the mouth	/	21.80	22.5	0.764	0.90	0.01
1852.4	9262	RMC	Next to the mouth	/	21.70	22.5	0.807	0.97	0.07

Frequency		Test Mode	Test Position	Figure No.	Conducted Power (dBm)	Max. tune-up Power (dBm)	Measured SAR(10g) (W/kg)	Reported SAR(10g) (W/kg)	Power Drift (dB)
MHz	Ch.								
1880	9400	RMC	Wrist Worn	Fig.8	22.60	23.5	0.898	1.10	-0.05

Table 13.5: SAR Values - WCDMA Band 4

Ambient Temperature: 22.5°C					Liquid Temperature: 22.0°C				
Frequency		Test Mode	Test Position	Figure No.	Conducted Power (dBm)	Max. tune-up Power (dBm)	Measured SAR(1g) (W/kg)	Reported SAR(1g) (W/kg)	Power Drift (dB)
MHz	Ch.								
1732.6	1413	RMC	Next to the mouth	Fig.9	21.20	21.5	0.582	0.62	-0.08

Frequency		Test Mode	Test Position	Figure No.	Conducted Power (dBm)	Max. tune-up Power (dBm)	Measured SAR(10g) (W/kg)	Reported SAR(10g) (W/kg)	Power Drift (dB)
MHz	Ch.								
1732.6	1413	RMC	Wrist Worn	Fig.10	22.80	23.5	0.628	0.74	0.08

Table 13.6: SAR Values - LTE Band 2

Ambient Temperature: 22.4°C					Liquid Temperature: 22.0°C				
Frequency		Test Mode	Test Position	Figure No.	Conducted Power (dBm)	Max. tune-up Power (dBm)	Measured SAR(1g) (W/kg)	Reported SAR(1g) (W/kg)	Power Drift (dB)
MHz	Ch.								
1880	18900	1RB_Low	Next to the mouth	/	23.32	24	0.910	1.06	-0.13
1900	19100	50RB_High	Next to the mouth	/	22.36	23	0.784	0.91	0.11
1900	19100	1RB_High	Next to the mouth	/	23.19	24	0.895	1.08	0.08
1860	18700	1RB_Low	Next to the mouth	Fig.11	23.07	24	0.919	1.14	0.02
1880	18900	50RB_Low	Next to the mouth	/	22.29	23	0.728	0.86	0.01
1860	18700	50RB_Low	Next to the mouth	/	22.30	23	0.791	0.93	0.15
1900	19100	100RB	Next to the mouth		22.28	23	0.886	1.05	0.06
Frequency		Test Mode	Test Position	Figure No.	Conducted Power (dBm)	Max. tune-up Power (dBm)	Measured SAR(10g) (W/kg)	Reported SAR(10g) (W/kg)	Power Drift (dB)
MHz	Ch.								
1880	18900	1RB_Low	Wrist Worn	Fig.12	23.32	24	1.340	1.57	0.09
1900	19100	50RB_High	Wrist Worn	/	22.36	23	1.310	1.52	0.04

Table 13.7: SAR Values - LTE Band 4

Ambient Temperature: 22.4°C					Liquid Temperature: 22.0°C				
Frequency		Test Mode	Test Position	Figure No.	Conducted Power (dBm)	Max. tune-up Power (dBm)	Measured SAR(1g) (W/kg)	Reported SAR(1g) (W/kg)	Power Drift (dB)
Frequency	Frequency								
1720	20050	1RB_Low	Next to the mouth	/	21.11	22	0.756	0.93	0.04
1732.5	20175	50RB_Low	Next to the mouth	/	20.21	21	0.668	0.80	0.08
1745	20300	1RB_Low	Next to the mouth	Fig.13	21.05	22	0.763	0.95	0.09
1732.5	20175	1RB_Low	Next to the mouth	/	21.03	22	0.743	0.93	0.04
1720	20050	100RB	Next to the mouth	/	20.19	21	0.606	0.73	0.05
Frequency		Test Mode	Test Position	Figure No.	Conducted Power (dBm)	Max. tune-up Power (dBm)	Measured SAR(10g) (W/kg)	Reported SAR(10g) (W/kg)	Power Drift (dB)
MHz	Ch.								
1720	20050	1RB_Low	Wrist Worn	Fig.14	23.37	24	0.638	0.74	0.07
1720	20050	50RB_Low	Wrist Worn	/	22.50	23	0.606	0.68	0.09

Table 13.8: SAR Values - LTE Band 5

Ambient Temperature: 22.8°C					Liquid Temperature: 22.2°C				
Frequency		Test Mode	Test Position	Figure No.	Conducted Power (dBm)	Max. tune-up Power (dBm)	Measured SAR(1g) (W/kg)	Reported SAR(1g) (W/kg)	Power Drift (dB)
MHz	Ch.								
844	20600	1RB_High	Next to the mouth	Fig.15	23.41	24	0.165	0.19	-0.13
836.5	20525	25RB_Low	Next to the mouth	/	22.36	23	0.160	0.19	-0.04

Frequency		Test Mode	Test Position	Figure No.	Conducted Power (dBm)	Max. tune-up Power (dBm)	Measured SAR(10g) (W/kg)	Reported SAR(10g) (W/kg)	Power Drift (dB)
MHz	Ch.								
844	20600	1RB_High	Wrist Worn	Fig.16	23.41	24	0.105	0.12	-0.11
836.5	20525	25RB_Low	Wrist Worn	/	22.36	23	0.100	0.12	0.05

Table 13.9: SAR Values - LTE Band 7

Ambient Temperature: 22.2°C					Liquid Temperature: 21.7°C				
Frequency		Test Mode	Test Position	Figure No. / Note	Conducted Power (dBm)	Max. tune-up Power (dBm)	Measured SAR(1g) (W/kg)	Reported SAR(1g) (W/kg)	Power Drift (dB)
MHz	Ch.								
2535	21100	1RB_High	Next to the mouth	Fig.17	20.58	21.5	0.862	1.07	0.08
2535	21100	50RB_High	Next to the mouth	/	19.65	21.5	0.730	1.12	0.09
2560	21350	1RB_High	Next to the mouth	/	20.56	21.5	0.783	0.97	0.00
2510	20850	1RB_High	Next to the mouth	/	20.49	21.5	0.824	1.04	0.04
2560	21350	50RB_High	Next to the mouth	/	19.63	21.5	0.713	1.10	0.04
2510	20850	50RB_High	Next to the mouth	/	19.57	21.5	0.701	1.09	0.08
2535	21100	100RB	Next to the mouth	/	19.59	21.5	0.721	1.12	0.01

Frequency		Test Mode	Test Position	Figure No. / Note	Conducted Power (dBm)	Max. tune-up Power (dBm)	Measured SAR(10g) (W/kg)	Reported SAR(10g) (W/kg)	Power Drift (dB)
MHz	Ch.								
2560	21350	50RB_High	Wrist Worn	Fig.18	22.86	24	0.917	1.19	-0.09
2560	21350	1RB_Mid	Wrist Worn	/	21.87	23	0.779	1.01	0.02

13.2. WLAN Evaluation for 2.4G

According to the KDB248227 D01, SAR is measured for 2.4GHz 802.11b DSSS using the initial test position procedure.

Table 13.10: SAR Values (WLAN 2.4G - Body)

Frequency		Test Mode	Test Position	Figure No.	Conducte d Power (dBm)	Max. tune-up Power (dBm)	Measured SAR(1g) (W/kg)	Reported SAR(1g) (W/kg)	Power Drift (dB)
MHz	Ch.								
Ambient Temperature: 22.6°C Liquid Temperature: 22.0°C									
2412	1	802.11 b	Next to the mouth	Fig.19	14.35	15	0.280	0.33	0.12
Frequency		Test Mode	Test Position	Figure No.	Conducte d Power (dBm)	Max. tune-up Power (dBm)	Measured SAR(10g) (W/kg)	Reported SAR(10g) (W/kg)	Power Drift (dB)
MHz	Ch.								
2412	1	802.11 b	Wrist Worn	Fig.20	14.35	15	0.285	0.33	0.05

Note1: For all positions/configurations tested using the initial test position and subsequent test positions, when the reported SAR is > 0.8 W/kg, SAR is measured for these test positions/configurations on the subsequent next highest measured output power channel until the reported SAR is ≤ 1.2 W/kg or all required channels are tested.

According to the KDB248227 D01, The reported SAR must be scaled to 100% transmission duty factor to determine compliance at the maximum tune-up tolerance limit.

Table 13.11: SAR Values (WLAN - Head) – 802.11b 1Mbps (Scaled Reported SAR)

Frequency		Test Position	Actual duty factor	maximum duty factor	Reported SAR (1g)(W/kg)	Scaled reported SAR (1g)(W/kg)
MHz	Ch.					
2412	1	Next to the mouth	100%	100%	0.33	0.33
2412	1	Wrist worn	100%	100%	0.33	0.33

SAR is not required for OFDM because the 802.11b adjusted SAR ≤ 1.2 W/kg.

14. SAR Measurement Variability

SAR measurement variability must be assessed for each frequency band, which is determined by the SAR probe calibration point and tissue-equivalent medium used for the device measurements. When both head and body tissue-equivalent media are required for SAR measurements in a frequency band, the variability measurement procedures should be applied to the tissue medium with the highest measured SAR, using the highest measured SAR configuration for that tissue-equivalent medium.

The following procedures are applied to determine if repeated measurements are required.

- 1) Repeated measurement is not required when the original highest measured SAR is < 0.80 W/kg; steps 2) through 4) do not apply.
- 2) When the original highest measured SAR is ≥ 0.80 W/kg, repeat that measurement once.
- 3) Perform a second repeated measurement only if the ratio of largest to smallest SAR for the original and first repeated measurements is > 1.20 or when the original or repeated measurement is ≥ 1.45 W/kg (~ 10% from the 1-g SAR limit).
- 4) Perform a third repeated measurement only if the original, first or second repeated measurement is ≥ 1.5 W/kg and the ratio of largest to smallest SAR for the original, first and second repeated measurements is > 1.20 .

Table 14.1: SAR Measurement Variability for WCDMA Band 2

Frequency		Test Position	Original	1 st Repeated	Ratio	2 nd Repeated
MHz	Ch.		SAR (W/kg)	SAR (W/kg)		SAR (W/kg)
1907.6	9538	Next to the mouth	0.894	0.886	1.01	/

Table 14.2: SAR Measurement Variability for LTE Band 2

Frequency		Test Position	Original	1 st Repeated	Ratio	2 nd Repeated
MHz	Ch.		SAR (W/kg)	SAR (W/kg)		SAR (W/kg)
1860	18700	Next to the mouth	0.919	0.904	1.02	/

Table 14.3: SAR Measurement Variability for LTE Band 7

Frequency		Test Position	Original	1 st Repeated	Ratio	2 nd Repeated
MHz	Ch.		SAR (W/kg)	SAR (W/kg)		SAR (W/kg)
2535	21100	Next to the mouth	0.862	0.855	1.01	/

15. Measurement Uncertainty

15.1. Measurement Uncertainty for Normal SAR Tests (300MHz~3GHz)

No.	Error Description	Type	Uncertainty value	Probably Distribution	Div.	(Ci) 1g	(Ci) 10g	Std. Unc. (1g)	Std. Unc. (10g)	Degree of freedom
Measurement system										
1	Probe calibration	B	12	N	2	1	1	6.0	6.0	∞
2	Isotropy	B	7.4	R	$\sqrt{3}$	1	1	4.3	4.3	∞
3	Boundary effect	B	1.1	R	$\sqrt{3}$	1	1	0.6	0.6	∞
4	Linearity	B	4.7	R	$\sqrt{3}$	1	1	2.7	2.7	∞
5	Detection limit	B	1.0	R	$\sqrt{3}$	1	1	0.6	0.6	∞
6	Readout electronics	B	1.0	N	1	1	1	1.0	1.0	∞
7	Response time	B	0.0	R	$\sqrt{3}$	1	1	0.0	0.0	∞
8	Integration time	B	1.7	R	$\sqrt{3}$	1	1	1.0	1.0	∞
9	RF ambient conditions-noise	B	3.0	R	$\sqrt{3}$	1	1	1.7	1.7	∞
10	RF ambient conditions-reflection	B	3.0	R	$\sqrt{3}$	1	1	1.7	1.7	∞
11	Probe positioned mech. restrictions	B	0.35	R	$\sqrt{3}$	1	1	0.2	0.2	∞
12	Probe positioning with respect to phantom shell	B	2.9	R	$\sqrt{3}$	1	1	1.7	1.7	∞
13	Post-processing	B	1.0	R	$\sqrt{3}$	1	1	0.6	0.6	∞
Test sample related										
14	Test sample positioning	A	3.3	N	1	1	1	3.3	3.3	5
15	Device holder uncertainty	A	3.4	N	1	1	1	3.4	3.4	5
16	Drift of output power	B	5.0	R	$\sqrt{3}$	1	1	2.9	2.9	∞
Phantom and set-up										
17	Phantom uncertainty	B	1.0	R	$\sqrt{3}$	1	1	0.6	0.6	∞
18	Liquid conductivity (target)	B	5.0	R	$\sqrt{3}$	0.64	0.43	1.8	1.2	∞
19	Liquid conductivity (meas.)	A	1.3	N	1	0.64	0.43	0.83	0.56	9
20	Liquid permittivity (target)	B	5.0	R	$\sqrt{3}$	0.6	0.49	1.7	1.4	∞
21	Liquid permittivity (meas.)	A	1.6	N	1	0.6	0.49	0.96	0.78	9
Combined standard uncertainty		$u_c = \sqrt{\sum_{i=1}^{21} c_i^2 u_i^2}$						10.4	10.3	95.5
Expanded uncertainty (Confidence interval of 95 %)		$u_e = 2u_c$						20.8	20.6	

16. Main Test Instruments

Table 16.1: List of Main Instruments

No.	Name	Type	Serial Number	Calibration Date	Valid Period
01	Network analyzer	E5071C	MY46103759	2021-11-15	One year
02	Dielectric probe	85070E	MY44300317	/	/
03	Power meter	E4418B	MY50000366	2021-12-13	One year
04	Power sensor	E9304A	MY50000188		
05	Power meter	NRP	101460	2021-01-15	One year
06	Power sensor	NRP-Z91	100553		
07	Signal Generator	E8257D	MY47461211	2021-01-15	One year
08	Amplifier	VTL5400	0404	/	/
09	E-field Probe	ES3DV3	3151	2021-04-26	One year
10	DAE	DAE4	786	2021-04-09	One year
11	Dipole Validation Kit	D835V2	4d057	2021-10-18	Three years
12	Dipole Validation Kit	D1750V2	1152	2019-08-30	Three years
13	Dipole Validation Kit	D1900V2	5d088	2021-10-18	Three years
14	Dipole Validation Kit	D2450V2	873	2021-10-21	Three years
15	Dipole Validation Kit	D2550V2	1010	2021-05-21	Three years
16	BTS	E5515C	GB46110722	2021-01-15	One year
17	BTS	MT8820C	6201341853	2021-01-15	One year
18	Software	DASY5	/	/	/

ANNEX A: Graph Results

GSM850 Next to the mouth

Date: 2019-9-30

Electronics: DAE4 Sn786

Medium: Head 835 MHz

Medium parameters used (interpolated): $f = 836.6$ MHz; $\sigma = 0.924$ S/m; $\epsilon_r = 40.218$; $\rho = 1000$ kg/m³

Ambient Temperature: 22.0°C Liquid Temperature: 21.5°C

Communication System: UID 0, GSM (0) Frequency: 836.6 MHz Duty Cycle: 1:8.3

Probe: EX3DV4 - SN3633 ConvF (9.51, 9.51, 9.51)

Front Side Middle/Area Scan (61x61x1): Interpolated grid: dx=1.500 mm, dy=1.500 mm

Maximum value of SAR (interpolated) = 0.411 W/kg

Front Side Middle/Zoom Scan (5x5x7)/Cube 0: Measurement grid: dx=8mm, dy=8mm, dz=5mm

Reference Value = 13.56 V/m; Power Drift = -0.12 dB

Peak SAR (extrapolated) = 0.498 W/kg

SAR(1 g) = 0.277 W/kg; SAR(10 g) = 0.166 W/kg

Maximum value of SAR (measured) = 0.377 W/kg

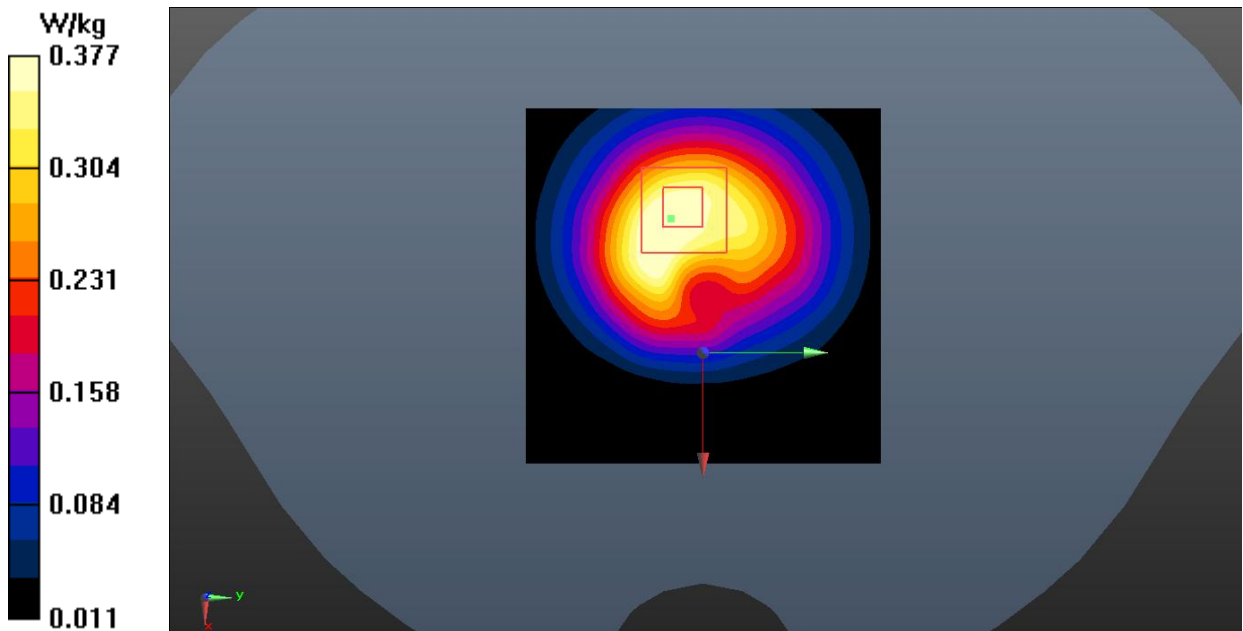

Fig.1 GSM 850 MHz

GSM850 Wrist worn

Date: 2019-9-30

Electronics: DAE4 Sn786

Medium: Head 835 MHz

Medium parameters used (interpolated): $f = 836.6$ MHz; $\sigma = 0.924$ S/m; $\epsilon_r = 40.218$; $\rho = 1000$ kg/m³

Ambient Temperature: 22.0°C Liquid Temperature: 21.5°C

Communication System: UID 0, GPRS 2Txslot (0) Frequency: 836.6 MHz Duty Cycle: 1:4

Probe: EX3DV4 - SN3633 ConvF (9.51, 9.51, 9.51)

Rear Side Middle/Area Scan (61x61x1): Interpolated grid: dx=1.500 mm, dy=1.500 mm

Maximum value of SAR (interpolated) = 1.45 W/kg

Rear Side Middle/Zoom Scan (5x5x7)/Cube 0: Measurement grid: dx=8mm, dy=8mm, dz=5mm

Reference Value = 27.78 V/m; Power Drift = -0.13 dB

Peak SAR (extrapolated) = 1.97 W/kg

SAR(1 g) = 1.02 W/kg; SAR(10 g) = 0.598 W/kg

Maximum value of SAR (measured) = 1.43 W/kg

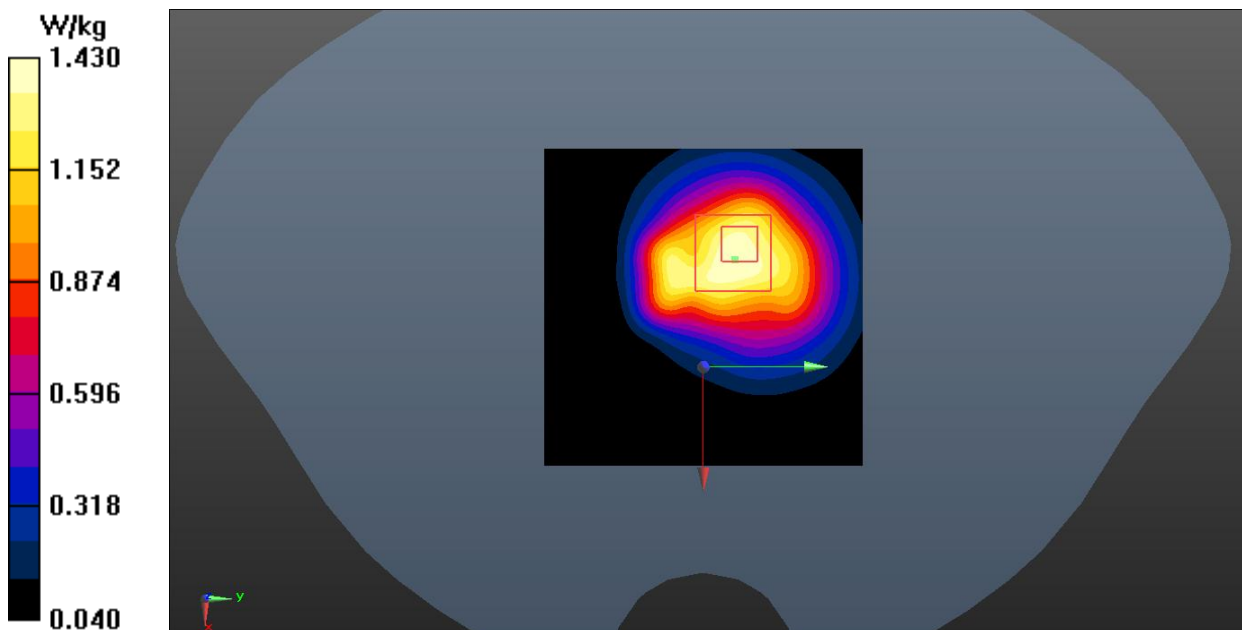
**Fig.2 GSM 850 MHz**

GSM1900 Next to the mouth

Date: 2019-10-4

Electronics: DAE4 Sn786

Medium: Head 1900 MHz

Medium parameters used: $f = 1880$ MHz; $\sigma = 1.406$ S/m; $\epsilon_r = 39.856$; $\rho = 1000$ kg/m³

Ambient Temperature: 22.0°C Liquid Temperature: 21.5°C

Communication System: UID 0, GSM (0) Frequency: 1880 MHz Duty Cycle: 1:8.3

Probe: EX3DV4 - SN3633 ConvF (7.63, 7.63, 7.63)

Front Side Middle/Area Scan (61x61x1): Interpolated grid: $dx=1.500$ mm, $dy=1.500$ mm

Maximum value of SAR (interpolated) = 0.712 W/kg

Front Side Middle/Zoom Scan (5x5x7)/Cube 0: Measurement grid: $dx=8$ mm, $dy=8$ mm, $dz=5$ mm

Reference Value = 14.50 V/m; Power Drift = 0.01 dB

Peak SAR (extrapolated) = 0.807 W/kg

SAR(1 g) = 0.445 W/kg; SAR(10 g) = 0.235 W/kg

Maximum value of SAR (measured) = 0.627 W/kg

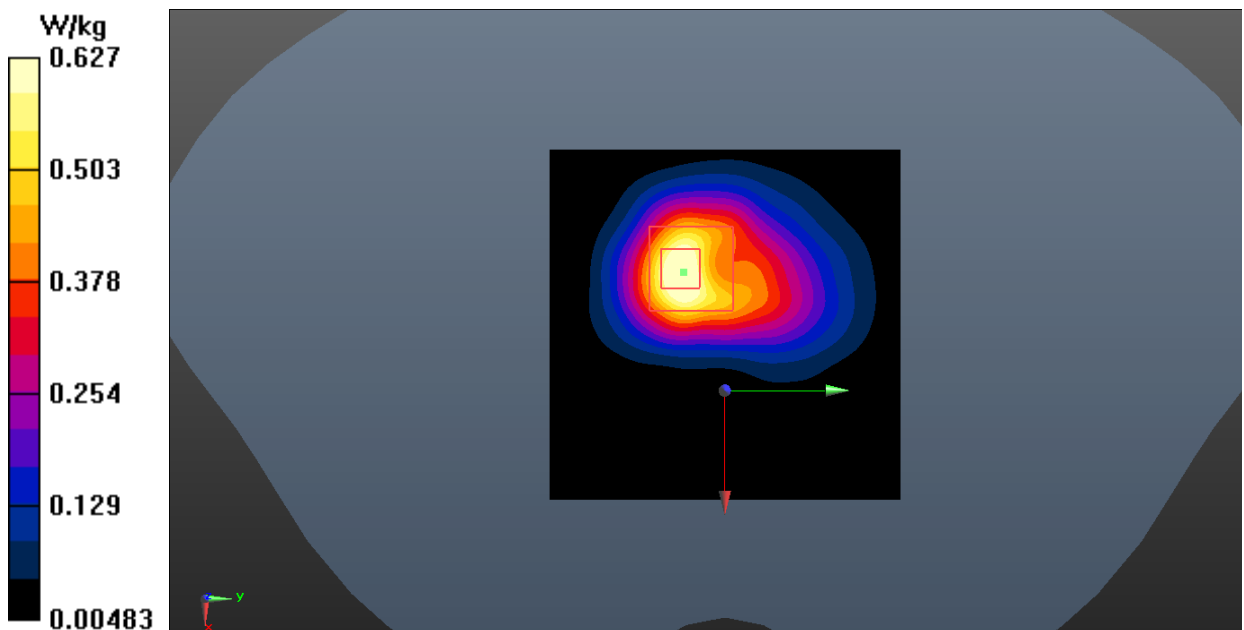

Fig.3 GSM 1900 MHz

GSM1900 Wrist worn

Date: 2019-10-4

Electronics: DAE4 Sn786

Medium: Head 1900 MHz

Medium parameters used: $f = 1880$ MHz; $\sigma = 1.406$ S/m; $\epsilon_r = 39.856$; $\rho = 1000$ kg/m³

Ambient Temperature: 22.0°C Liquid Temperature: 21.5°C

Communication System: UID 0, GPRS 3Txslot (0) Frequency: 1880 MHz Duty Cycle: 1:2.67

Probe: EX3DV4 - SN3633 ConvF (7.63, 7.63, 7.63)

Rear Side Middle/Area Scan (61x61x1): Interpolated grid: dx=1.500 mm, dy=1.500 mm

Maximum value of SAR (interpolated) = 2.19 W/kg

Rear Side Middle/Zoom Scan (5x5x7)/Cube 0: Measurement grid: dx=8mm, dy=8mm, dz=5mm

Reference Value = 22.01 V/m; Power Drift = 0.04 dB

Peak SAR (extrapolated) = 2.53 W/kg

SAR(1 g) = 1.45 W/kg; SAR(10 g) = 0.764 W/kg

Maximum value of SAR (measured) = 1.95 W/kg

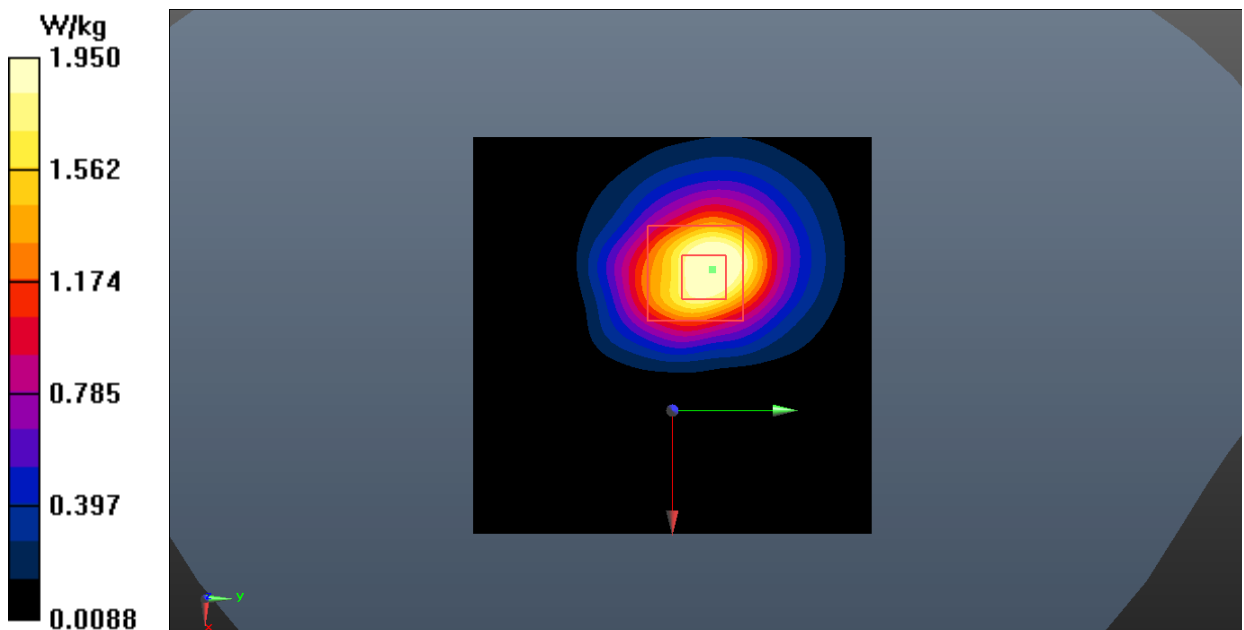

Fig.4 GSM 1900 MHz

WCDMA Band 5 Next to the mouth

Date: 2019-9-30

Electronics: DAE4 Sn786

Medium: Head 835 MHz

Medium parameters used (interpolated): $f = 836.4$ MHz; $\sigma = 0.924$ S/m; $\epsilon_r = 40.22$; $\rho = 1000$ kg/m³

Ambient Temperature: 22.0°C Liquid Temperature: 21.5°C

Communication System: UID 0, WCDMA (0) Frequency: 836.4 MHz Duty Cycle: 1:1

Probe: EX3DV4 - SN3633 ConvF (9.51, 9.51, 9.51)

Front Side Middle/Area Scan (61x61x1): Interpolated grid: dx=1.500 mm, dy=1.500 mm

Maximum value of SAR (interpolated) = 0.291 W/kg

Front Side Middle/Zoom Scan (5x5x7)/Cube 0: Measurement grid: dx=8mm, dy=8mm, dz=5mm

Reference Value = 13.18 V/m; Power Drift = -0.11 dB

Peak SAR (extrapolated) = 0.364 W/kg

SAR(1 g) = 0.198 W/kg; SAR(10 g) = 0.142 W/kg

Maximum value of SAR (measured) = 0.275 W/kg

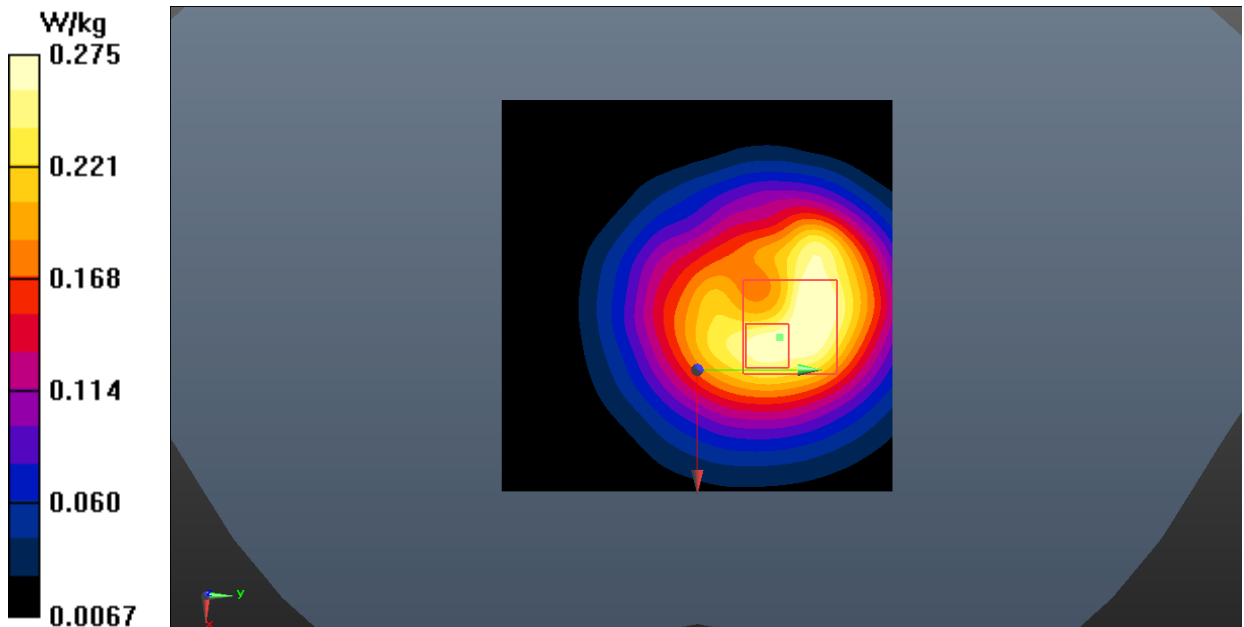

Fig.5 WCDMA 850

WCDMA Band 5 Wrist worn

Date: 2019-9-30

Electronics: DAE4 Sn786

Medium: Head 835 MHz

Medium parameters used (interpolated): $f = 836.4$ MHz; $\sigma = 0.924$ S/m; $\epsilon_r = 40.22$; $\rho = 1000$ kg/m³

Ambient Temperature: 22.0°C Liquid Temperature: 21.5°C

Communication System: UID 0, WCDMA (0) Frequency: 836.4 MHz Duty Cycle: 1:1

Probe: EX3DV4 - SN3633 ConvF (9.51, 9.51, 9.51)

Rear Side Middle/Area Scan (61x61x1): Interpolated grid: dx=1.500 mm, dy=1.500 mm

Maximum value of SAR (interpolated) = 0.838 W/kg

Rear Side Middle/Zoom Scan (5x5x7)/Cube 0: Measurement grid: dx=8mm, dy=8mm, dz=5mm

Reference Value = 22.49 V/m; Power Drift = 0.10 dB

Peak SAR (extrapolated) = 1.10 W/kg

SAR(1 g) = 0.577 W/kg; SAR(10 g) = 0.330 W/kg

Maximum value of SAR (measured) = 0.803 W/kg

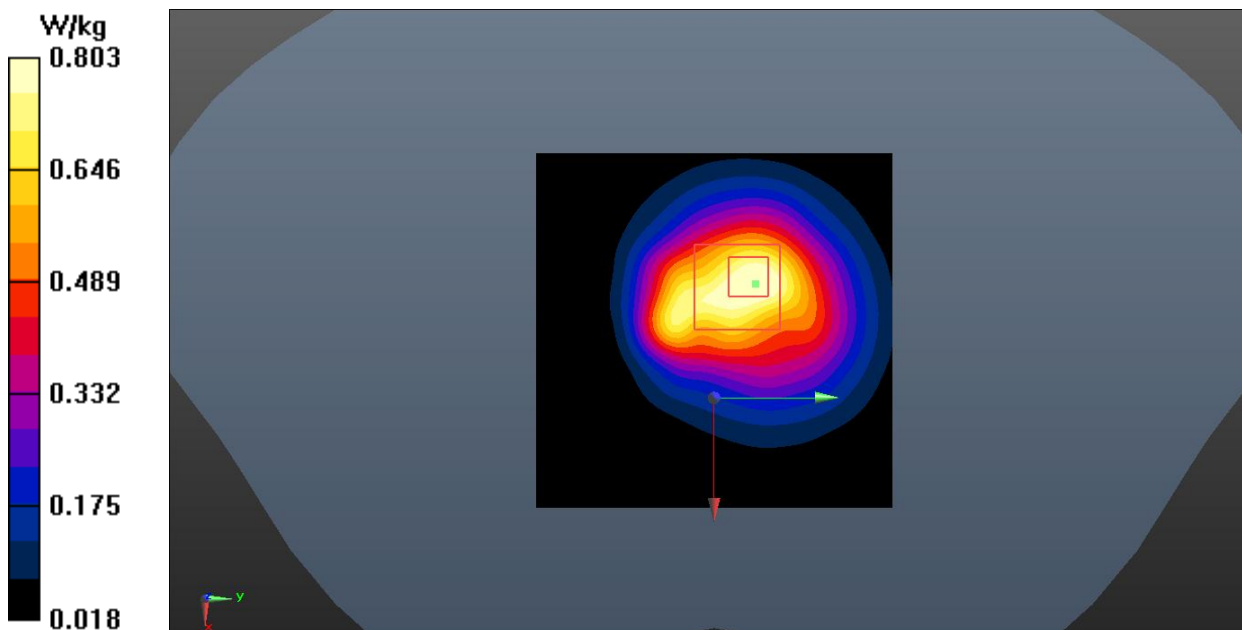

Fig.6 WCDMA 850

WCDMA Band 2 Next to the mouth

Date: 2019-10-4

Electronics: DAE4 Sn786

Medium: Head 1900 MHz

Medium parameters used: $f = 1900$ MHz; $\sigma = 1.424$ S/m; $\epsilon_r = 39.778$; $\rho = 1000$ kg/m³

Ambient Temperature: 22.0°C Liquid Temperature: 21.5°C

Communication System: UID 0, WCDMA (0) Frequency: 1900 MHz Duty Cycle: 1:1

Probe: EX3DV4 - SN3633 ConvF (7.63, 7.63, 7.63)

Front Side High/Area Scan (61x61x1): Interpolated grid: $dx=1.500$ mm, $dy=1.500$ mm

Maximum value of SAR (interpolated) = 1.33 W/kg

Front Side High/Zoom Scan (5x5x7)/Cube 0: Measurement grid: $dx=8$ mm, $dy=8$ mm, $dz=5$ mm

Reference Value = 16.52 V/m; Power Drift = 0.09 dB

Peak SAR (extrapolated) = 1.50 W/kg

SAR(1 g) = 0.894 W/kg; SAR(10 g) = 0.498 W/kg

Maximum value of SAR (measured) = 1.18 W/kg

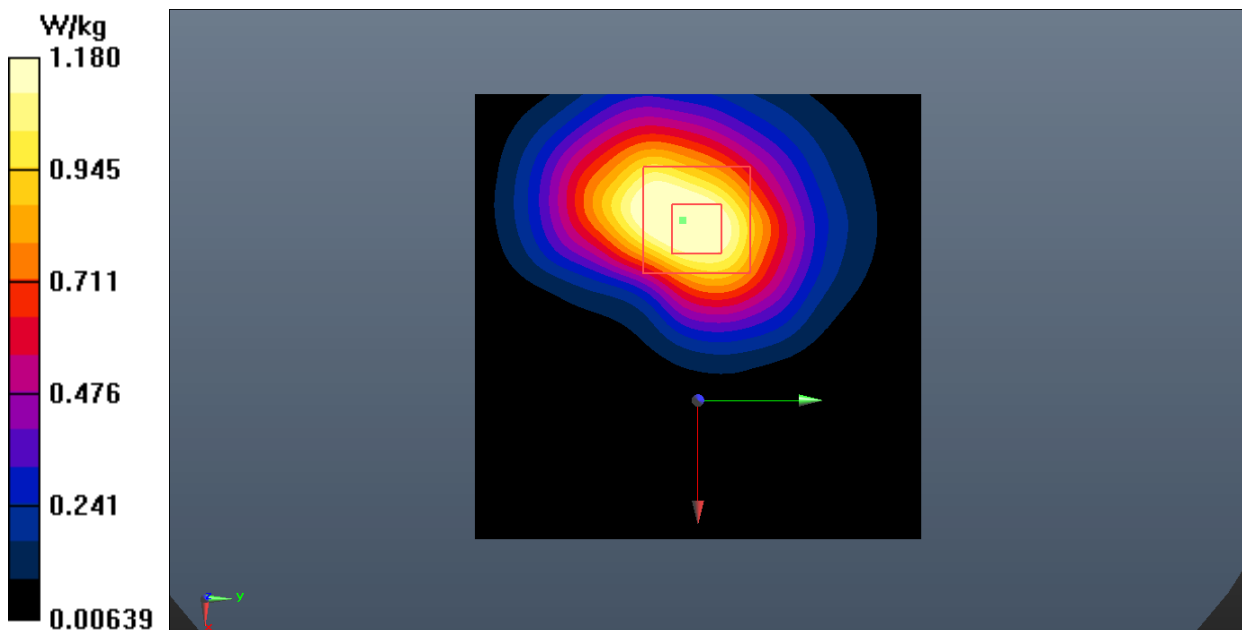

Fig.7 WCDMA 1900

WCDMA Band 2 Wrist worn

Date: 2019-10-4

Electronics: DAE4 Sn786

Medium: Head 1900 MHz

Medium parameters used: $f = 1880$ MHz; $\sigma = 1.406$ S/m; $\epsilon_r = 39.856$; $\rho = 1000$ kg/m³

Ambient Temperature: 22.0°C Liquid Temperature: 21.5°C

Communication System: UID 0, WCDMA (0) Frequency: 1880 MHz Duty Cycle: 1:1

Probe: EX3DV4 - SN3633 ConvF (7.63, 7.63, 7.63)

Rear Side Middle/Area Scan (61x61x1): Interpolated grid: dx=1.500 mm, dy=1.500 mm

Maximum value of SAR (interpolated) = 2.51 W/kg

Rear Side Middle/Zoom Scan (5x5x7)/Cube 0: Measurement grid: dx=8mm, dy=8mm, dz=5mm

Reference Value = 30.59 V/m; Power Drift = -0.05 dB

Peak SAR (extrapolated) = 2.91 W/kg

SAR(1 g) = 1.70 W/kg; SAR(10 g) = 0.898 W/kg

Maximum value of SAR (measured) = 2.26 W/kg

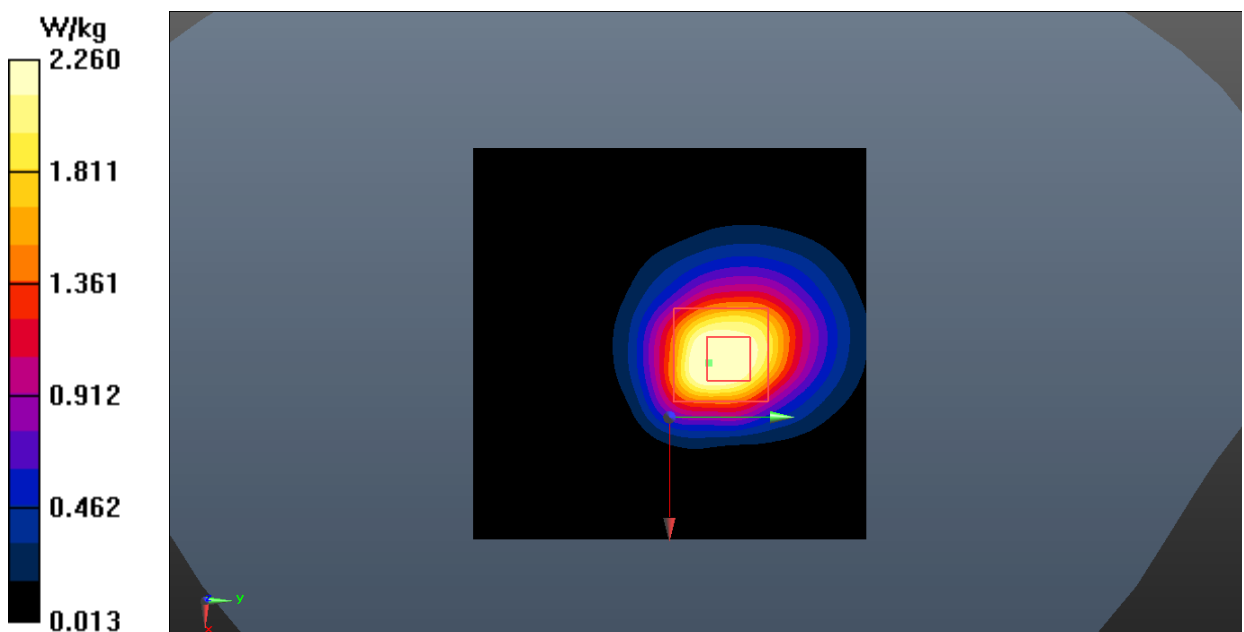

Fig.8 WCDMA 1900

WCDMA Band 4 Next to the mouth

Date: 2019-10-4

Electronics: DAE4 Sn786

Medium: Head 1750 MHz

Medium parameters used (interpolated): $f = 1732.6$ MHz; $\sigma = 1.343$ S/m; $\epsilon_r = 40.689$; $\rho = 1000$

Ambient Temperature: 22.0°C Liquid Temperature: 21.5°C

Communication System: UID 0, WCDMA (0) Frequency: 1732.6 MHz Duty Cycle: 1:1

Probe: EX3DV4 - SN3633 ConvF (8.07, 8.07, 8.07)

Front Side Middle/Area Scan (61x61x1): Interpolated grid: $dx=1.500$ mm, $dy=1.500$ mm

Maximum value of SAR (interpolated) = 0.853 W/kg

Front Side Middle/Zoom Scan (5x5x7)/Cube 0: Measurement grid: $dx=8$ mm, $dy=8$ mm, $dz=5$ mm

Reference Value = 9.956 V/m; Power Drift = -0.08 dB

Peak SAR (extrapolated) = 1.06 W/kg

SAR(1 g) = 0.582 W/kg; SAR(10 g) = 0.300 W/kg

Maximum value of SAR (measured) = 0.809 W/kg

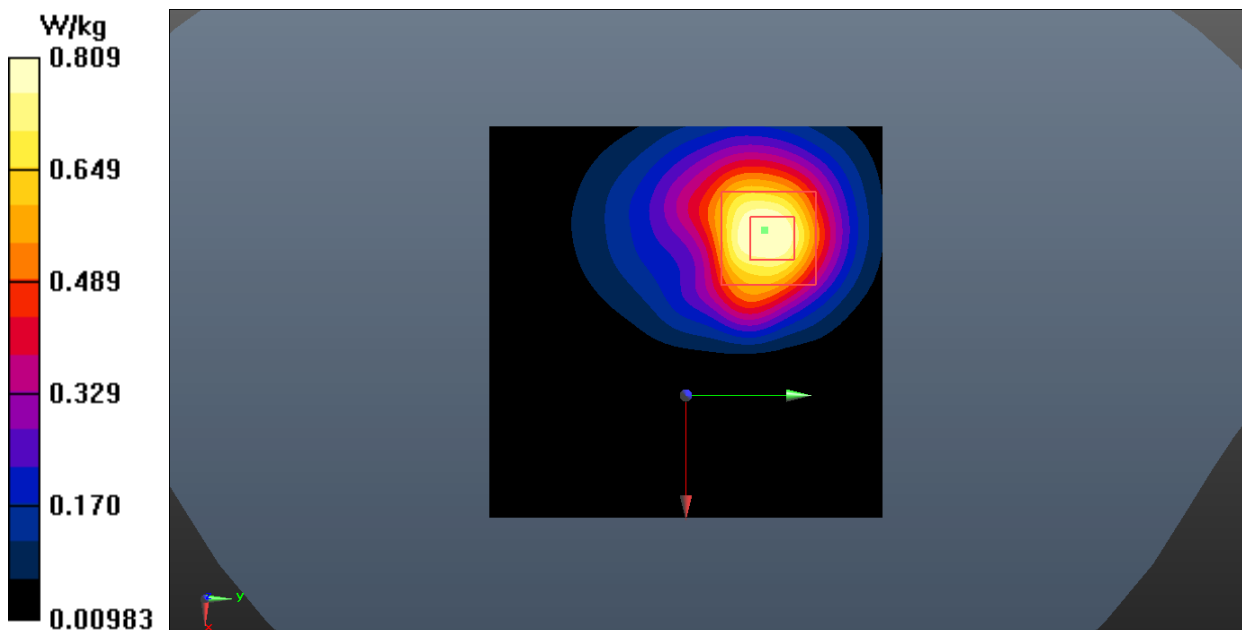

Fig.9 WCDMA 1700

WCDMA Band 4 Wrist worn

Date: 2019-10-4

Electronics: DAE4 Sn786

Medium: Head 1750 MHz

Medium parameters used (interpolated): $f = 1732.6$ MHz; $\sigma = 1.343$ S/m; $\epsilon_r = 40.689$; $\rho = 1000$ Ambient Temperature: 22.0°C Liquid Temperature: 21.5°C

Communication System: UID 0, WCDMA (0) Frequency: 1732.6 MHz Duty Cycle: 1:1

Probe: EX3DV4 - SN3633 ConvF (8.07, 8.07, 8.07)

Rear Side Middle/Area Scan (61x61x1): Interpolated grid: $dx=1.500$ mm, $dy=1.500$ mm

Maximum value of SAR (interpolated) = 1.66 W/kg

Rear Side Middle/Zoom Scan (5x5x7)/Cube 0: Measurement grid: $dx=8$ mm, $dy=8$ mm, $dz=5$ mm

Reference Value = 22.81 V/m; Power Drift = 0.08 dB

Peak SAR (extrapolated) = 2.10 W/kg

SAR(1 g) = 1.15 W/kg; SAR(10 g) = 0.628 W/kg

Maximum value of SAR (measured) = 1.50 W/kg

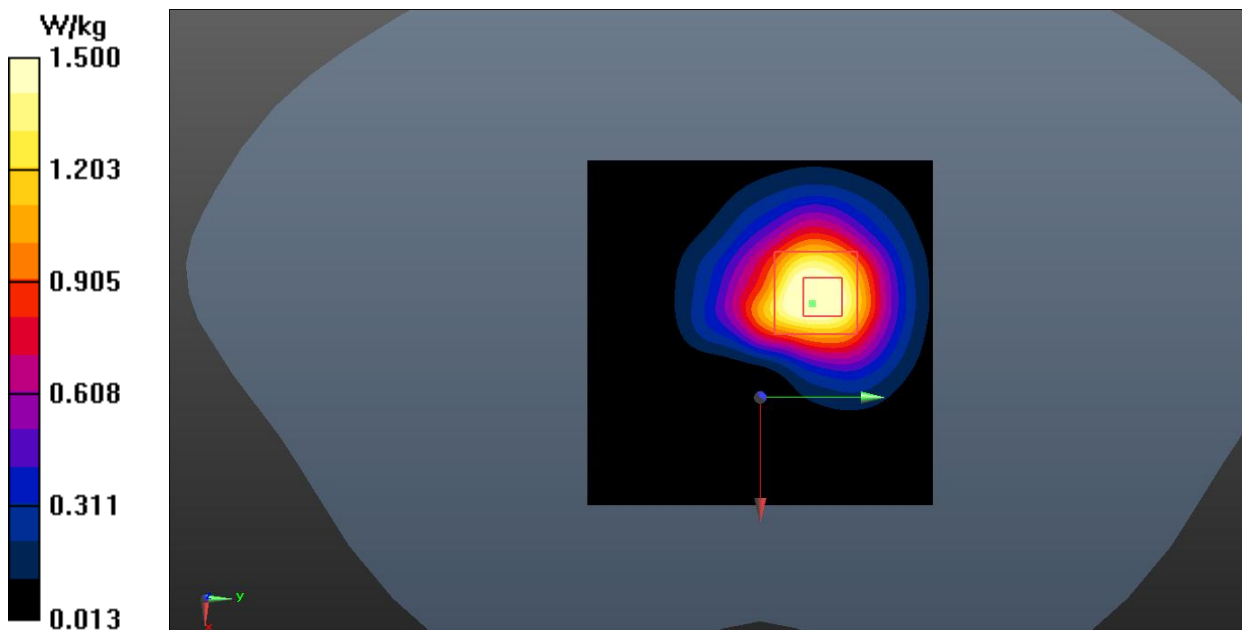

Fig.10 WCDMA 1700

LTE Band 2 Next to the mouth

Date: 2019-10-4

Electronics: DAE4 Sn786

Medium: Head 1900 MHz

Medium parameters used: $f = 1860$ MHz; $\sigma = 1.389$ S/m; $\epsilon_r = 39.934$; $\rho = 1000$ kg/m³

Ambient Temperature: 22.0°C Liquid Temperature: 21.5°C

Communication System: UID 0, LTE_FDD (0) Frequency: 1860 MHz Duty Cycle: 1:1

Probe: EX3DV4 - SN3633 ConvF (7.63, 7.63, 7.63)

Front Side Low 1RB_Low/Area Scan (51x51x1): Interpolated grid: dx=1.500 mm, dy=1.500 mm

Maximum value of SAR (interpolated) = 1.49 W/kg

Front Side Low 1RB_Low/Zoom Scan (5x5x7)/Cube 0: Measurement grid: dx=8mm, dy=8mm, dz=5mm

Reference Value = 20.68 V/m; Power Drift = 0.02 dB

Peak SAR (extrapolated) = 1.64 W/kg

SAR(1 g) = 0.919 W/kg; SAR(10 g) = 0.500 W/kg

Maximum value of SAR (measured) = 1.28 W/kg

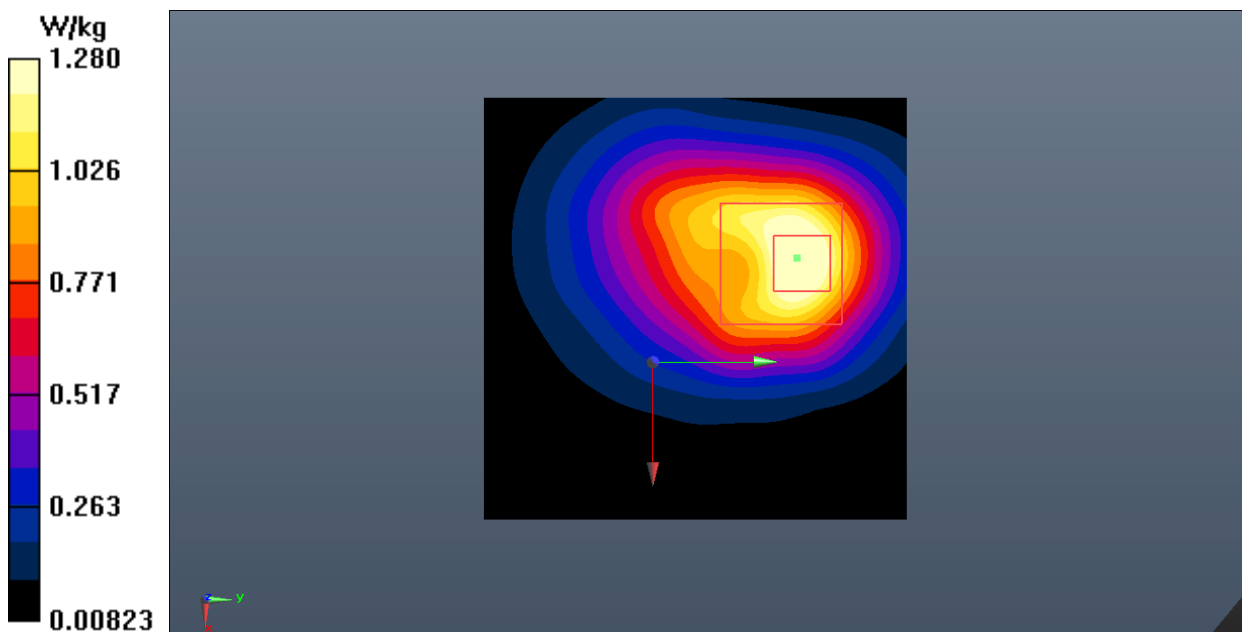

Fig.11 LTE Band 2

LTE Band 2 Wrist worn

Date: 2019-10-4

Electronics: DAE4 Sn786

Medium: Head 1900 MHz

Medium parameters used: $f = 1880$ MHz; $\sigma = 1.406$ S/m; $\epsilon_r = 39.856$; $\rho = 1000$ kg/m³

Ambient Temperature: 22.0°C Liquid Temperature: 21.5°C

Communication System: UID 0, LTE_FDD (0) Frequency: 1880 MHz Duty Cycle: 1:1

Probe: EX3DV4 - SN3633 ConvF (7.63, 7.63, 7.63)

Rear Side Middle 1RB_Low/Area Scan (61x61x1): Interpolated grid: dx=1.500 mm, dy=1.500 mm

Maximum value of SAR (interpolated) = 3.89 W/kg

Rear Side Middle 1RB_Low/Zoom Scan (5x5x7)/Cube 0: Measurement grid: dx=8mm, dy=8mm, dz=5mm

Reference Value = 16.32 V/m; Power Drift = 0.09 dB

Peak SAR (extrapolated) = 4.34 W/kg

SAR(1 g) = 2.51 W/kg; SAR(10 g) = 1.34 W/kg

Maximum value of SAR (measured) = 3.14 W/kg

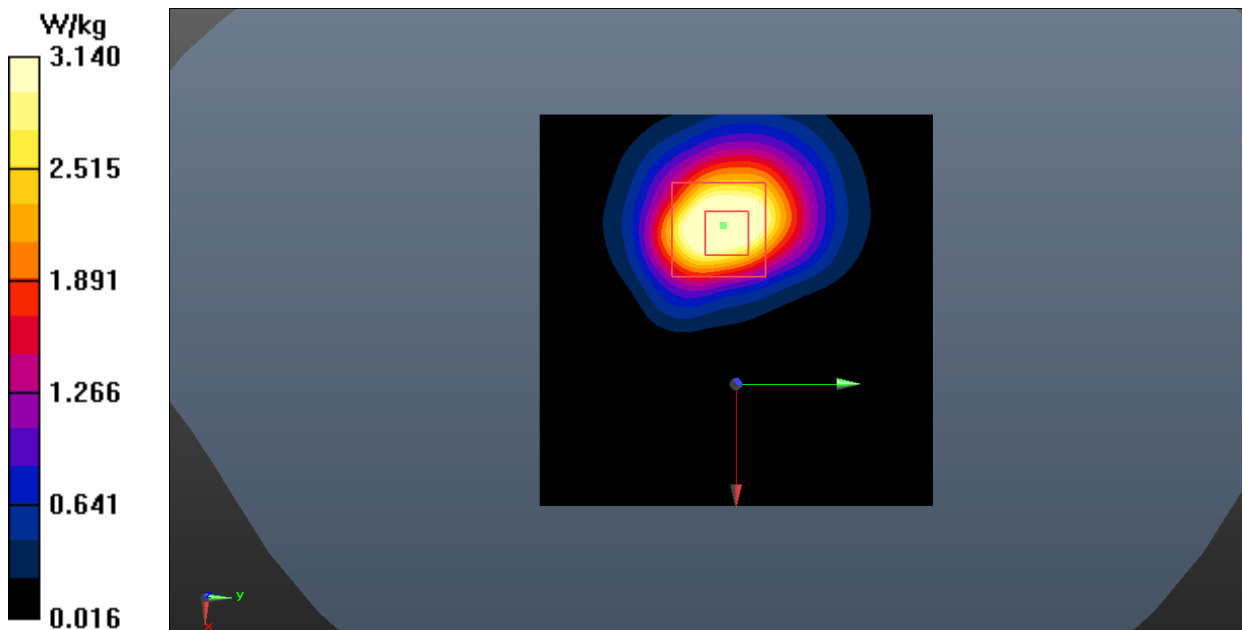

Fig.12 LTE Band 2

LTE Band 4 Next to the mouth

Date: 2019-10-4

Electronics: DAE4 Sn786

Medium: Head 1750 MHz

Medium parameters used: $f = 1745$ MHz; $\sigma = 1.354$ S/m; $\epsilon_r = 40.641$; $\rho = 1000$ kg/m³

Ambient Temperature: 22.0°C Liquid Temperature: 21.5°C

Communication System: UID 0, LTE_FDD (0) Frequency: 1745 MHz Duty Cycle: 1:1

Probe: EX3DV4 - SN3633 ConvF (8.07, 8.07, 8.07)

Front Side High 1RB_Low/Area Scan (51x51x1): Interpolated grid: dx=1.500 mm, dy=1.500 mm

Maximum value of SAR (interpolated) = 1.12 W/kg

Front Side High 1RB_Low/Zoom Scan (5x5x7)/Cube 0: Measurement grid: dx=8mm, dy=8mm, dz=5mm

Reference Value = 14.72 V/m; Power Drift = 0.09 dB

Peak SAR (extrapolated) = 1.39 W/kg

SAR(1 g) = 0.763 W/kg; SAR(10 g) = 0.399 W/kg

Maximum value of SAR (measured) = 1.02 W/kg

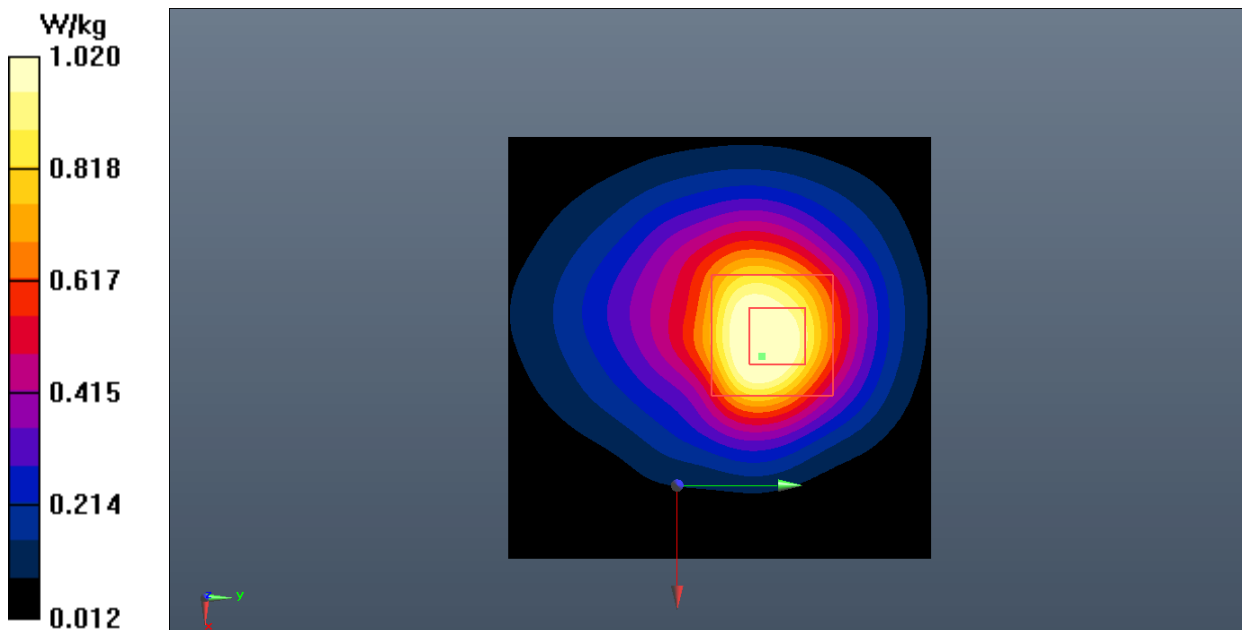
**Fig.13 LTE Band 4**

LTE Band 4 Wrist worn

Date: 2019-10-4

Electronics: DAE4 Sn786

Medium: Head 1750 MHz

Medium parameters used: $f = 1720$ MHz; $\sigma = 1.332$ S/m; $\epsilon_r = 40.738$; $\rho = 1000$ kg/m³

Ambient Temperature: 22.0°C Liquid Temperature: 21.5°C

Communication System: UID 0, LTE_FDD (0) Frequency: 1720 MHz Duty Cycle: 1:1

Probe: EX3DV4 - SN3633 ConvF (8.07, 8.07, 8.07)

Rear Side Low 1RB_Low/Area Scan (61x61x1): Interpolated grid: dx=1.500 mm, dy=1.500 mm

Maximum value of SAR (interpolated) = 1.83 W/kg

Rear Side Low 1RB_Low/Zoom Scan (5x5x7)/Cube 0: Measurement grid: dx=8mm, dy=8mm, dz=5mm

Reference Value = 9.518 V/m; Power Drift = 0.07 dB

Peak SAR (extrapolated) = 2.12 W/kg

SAR(1 g) = 1.18 W/kg; SAR(10 g) = 0.638 W/kg

Maximum value of SAR (measured) = 1.60 W/kg

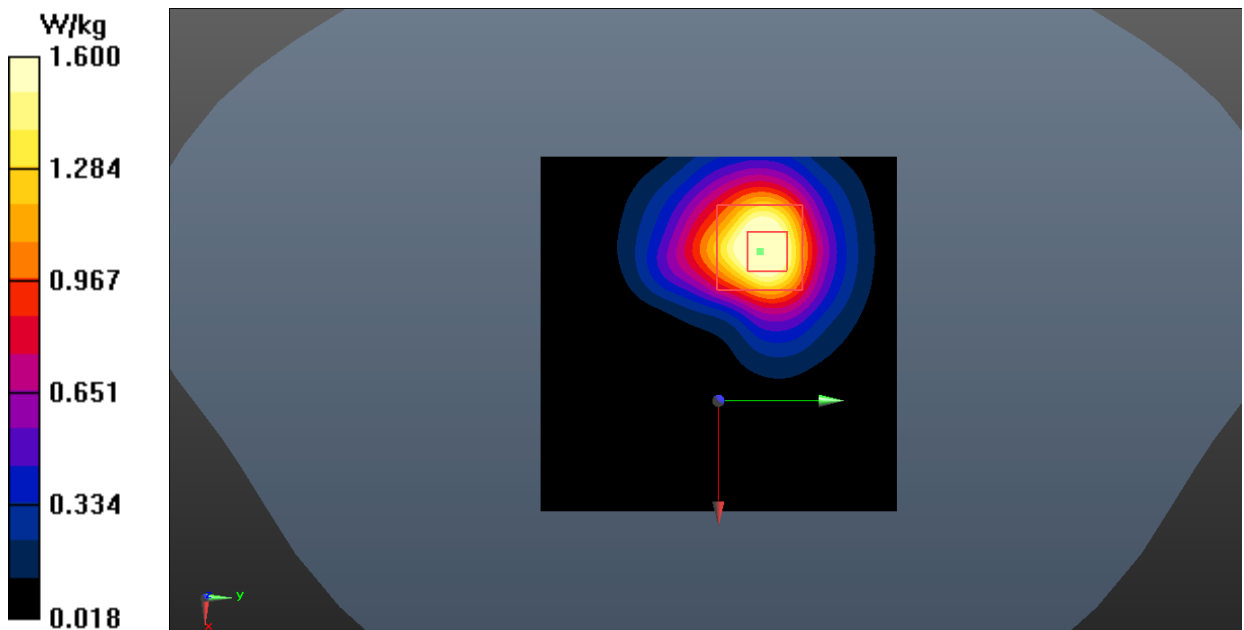

Fig.14 LTE Band 4

LTE Band 5 Next to the mouth

Date: 2019-9-30

Electronics: DAE4 Sn786

Medium: Head 835 MHz

Medium parameters used: $f = 844 \text{ MHz}$; $\sigma = 0.931 \text{ S/m}$; $\epsilon_r = 40.129$; $\rho = 1000 \text{ kg/m}^3$ Ambient Temperature: 22.0°C Liquid Temperature: 21.5°C

Communication System: UID 0, LTE_FDD (0) Frequency: 844 MHz Duty Cycle: 1:1

Probe: EX3DV4 - SN3633 ConvF (9.51, 9.51, 9.51)

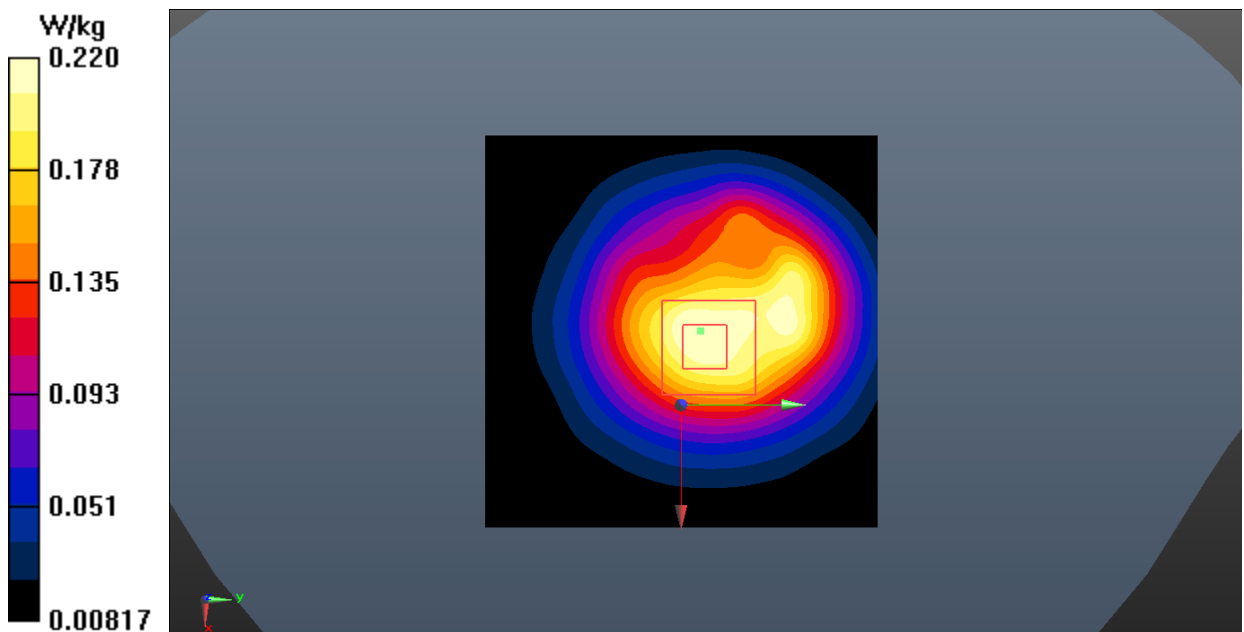
Front Side High 1RB_High/Area Scan (61x61x1): Interpolated grid: $dx=1.500 \text{ mm}$, $dy=1.500 \text{ mm}$ Maximum value of SAR (interpolated) = 0.226 W/kg **Front Side High 1RB_High/Zoom Scan (5x5x7)/Cube 0:** Measurement grid: $dx=8\text{mm}$, $dy=8\text{mm}$, $dz=5\text{mm}$ Reference Value = 13.75 V/m ; Power Drift = -0.13 dB Peak SAR (extrapolated) = 0.293 W/kg **SAR(1 g) = 0.165 W/kg ; SAR(10 g) = 0.098 W/kg** Maximum value of SAR (measured) = 0.220 W/kg **Fig.15 LTE Band 5**

LTE Band 5 Wrist worn

Date: 2019-9-30

Electronics: DAE4 Sn786

Medium: Head 835 MHz

Medium parameters used: $f = 844$ MHz; $\sigma = 0.931$ S/m; $\epsilon_r = 40.129$; $\rho = 1000$ kg/m³

Ambient Temperature: 22.0°C Liquid Temperature: 21.5°C

Communication System: UID 0, LTE_FDD (0) Frequency: 844 MHz Duty Cycle: 1:1

Probe: EX3DV4 - SN3633 ConvF (9.51, 9.51, 9.51)

Rear Side High 1RB_High/Area Scan (61x61x1): Interpolated grid: dx=1.500 mm, dy=1.500 mm

Maximum value of SAR (interpolated) = 0.286 W/kg

Rear Side High 1RB_High/Zoom Scan (5x5x7)/Cube 0: Measurement grid: dx=8mm, dy=8mm, dz=5mm

Reference Value = 14.94 V/m; Power Drift = -0.11 dB

Peak SAR (extrapolated) = 0.335 W/kg

SAR(1 g) = 0.177 W/kg; SAR(10 g) = 0.105 W/kg

Maximum value of SAR (measured) = 0.251 W/kg

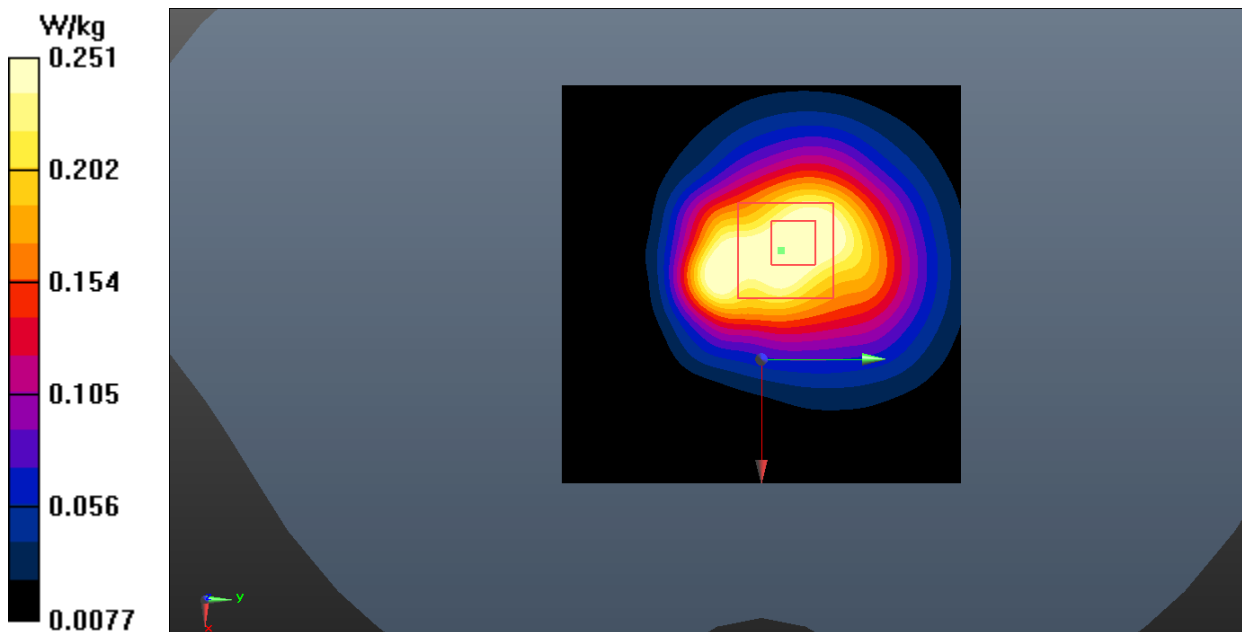

Fig.16 LTE Band 5

LTE Band 7 Next to the mouth

Date: 2019-10-4

Electronics: DAE4 Sn786

Medium: Head 2550 MHz

Medium parameters used (interpolated): $f = 2535$ MHz; $\sigma = 1.927$ S/m; $\epsilon_r = 38.114$; $\rho = 1000$ kg/m³

Ambient Temperature: 22.0°C Liquid Temperature: 21.5°C

Communication System: UID 0, 4G_LTE_FDD (0) Frequency: 2535 MHz Duty Cycle: 1:1

Probe: EX3DV4 - SN3633 ConvF (7.12, 7.12, 7.12)

Front Side Middle 1RB_High/Area Scan (91x91x1): Interpolated grid: dx=1.000 mm, dy=1.000 mm

Maximum value of SAR (interpolated) = 1.26 W/kg

Front Side Middle 1RB_High/Zoom Scan (7x7x7)/Cube 0: Measurement grid: dx=5mm, dy=5mm, dz=5mm

Reference Value = 13.19 V/m; Power Drift = 0.08 dB

Peak SAR (extrapolated) = 1.77 W/kg

SAR(1 g) = 0.862 W/kg; SAR(10 g) = 0.411 W/kg

Maximum value of SAR (measured) = 1.28 W/kg

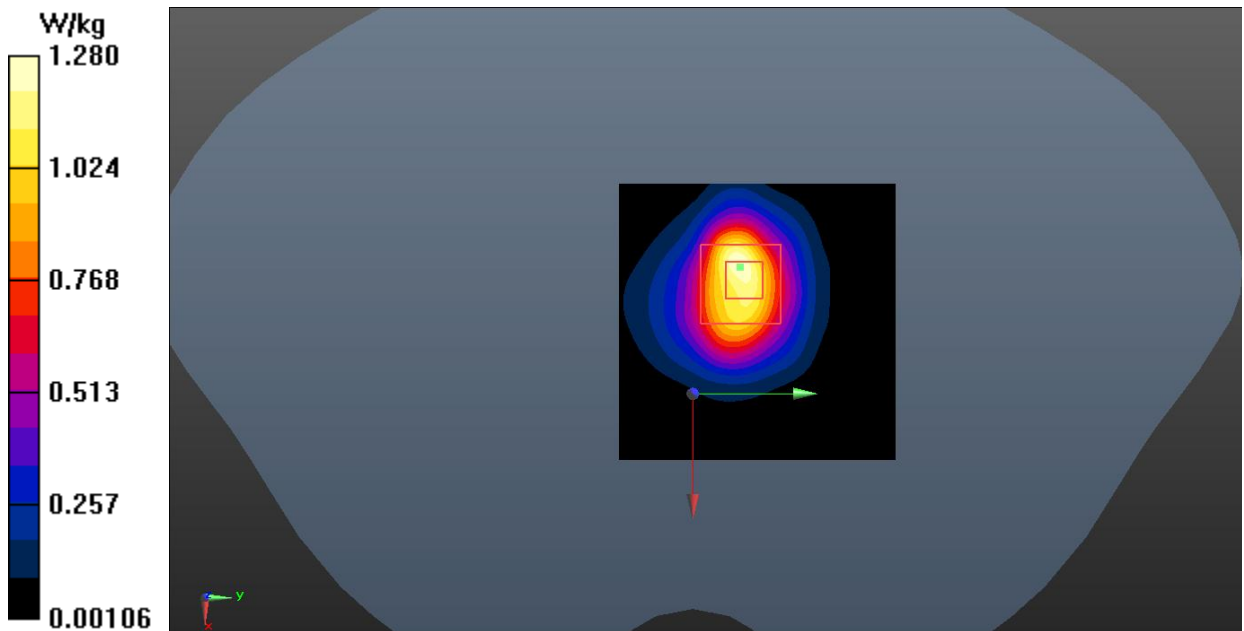

Fig.17 LTE Band 7

LTE Band 7 Wrist worn

Date: 2019-10-4

Electronics: DAE4 Sn786

Medium: Head 2550 MHz

Medium parameters used: $f = 2560$ MHz; $\sigma = 1.957$ S/m; $\epsilon_r = 38.031$; $\rho = 1000$ kg/m³

Ambient Temperature: 22.0°C Liquid Temperature: 21.5°C

Communication System: UID 0, 4G_LTE_FDD (0) Frequency: 2560 MHz Duty Cycle: 1:1

Probe: EX3DV4 - SN3633 ConvF (7.12, 7.12, 7.12)

Rear Side High 1RB_High/Area Scan (91x91x1): Interpolated grid: dx=1.000 mm, dy=1.000 mm

Maximum value of SAR (interpolated) = 2.72 W/kg

Rear Side High 1RB_High/Zoom Scan (7x7x7)/Cube 0: Measurement grid: dx=5mm, dy=5mm, dz=5mm

Reference Value = 19.95 V/m; Power Drift = -0.09 dB

Peak SAR (extrapolated) = 3.39 W/kg

SAR(1 g) = 1.79 W/kg; SAR(10 g) = 0.917 W/kg

Maximum value of SAR (measured) = 2.48 W/kg

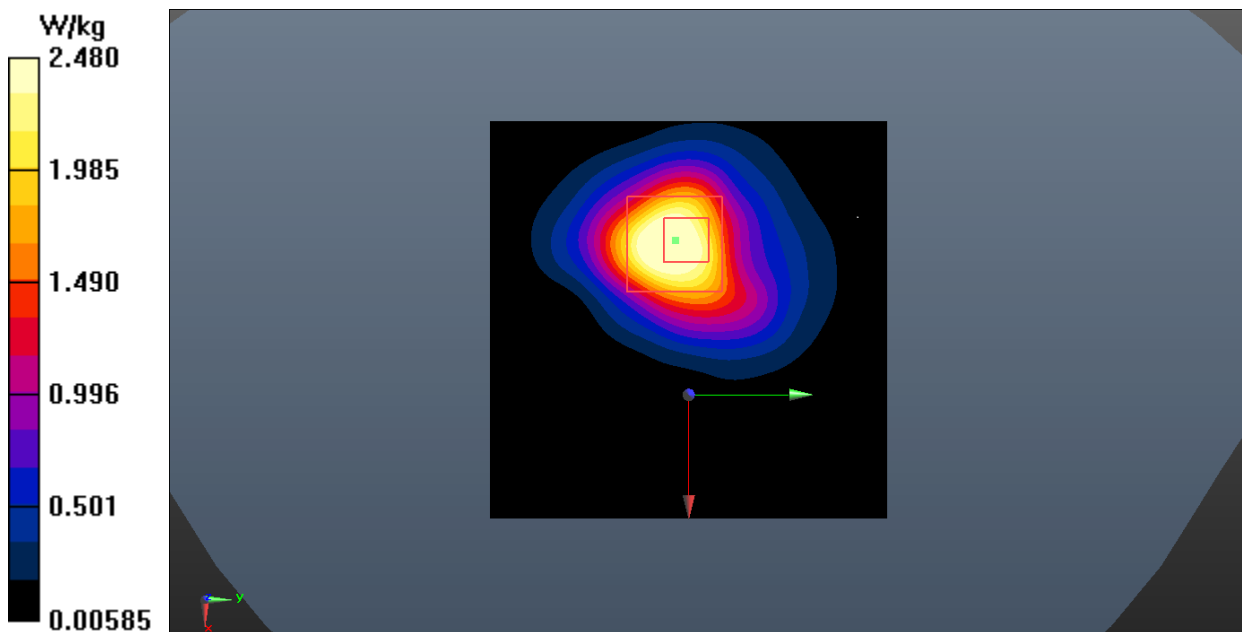

Fig.18 LTE Band 7

WLAN 2.4G Next to the mouth

Date: 2019-10-9

Electronics: DAE4 Sn786

Medium: Head 2450 MHz

Medium parameters used: $f = 2412$ MHz; $\sigma = 1.783$ S/m; $\epsilon_r = 38.557$; $\rho = 1000$ kg/m³

Ambient Temperature: 22.0°C Liquid Temperature: 21.5°C

Communication System: UID 0, WiFi (0) Frequency: 2412 MHz Duty Cycle: 1:1

Probe: EX3DV4 – SN3633 ConvF (7.33, 7.33, 7.33);

Front Side Low/Area Scan (91x91x1): Interpolated grid: dx=1.000 mm, dy=1.000 mm

Maximum value of SAR (interpolated) = 0.362 W/kg

Front Side Low/Zoom Scan (7x7x7)/Cube 0: Measurement grid: dx=5mm, dy=5mm, dz=5mm

Reference Value = 9.840 V/m; Power Drift = 0.12 dB

Peak SAR (extrapolated) = 0.500 W/kg

SAR(1 g) = 0.280 W/kg; SAR(10 g) = 0.154 W/kg

Maximum value of SAR (measured) = 0.386 W/kg

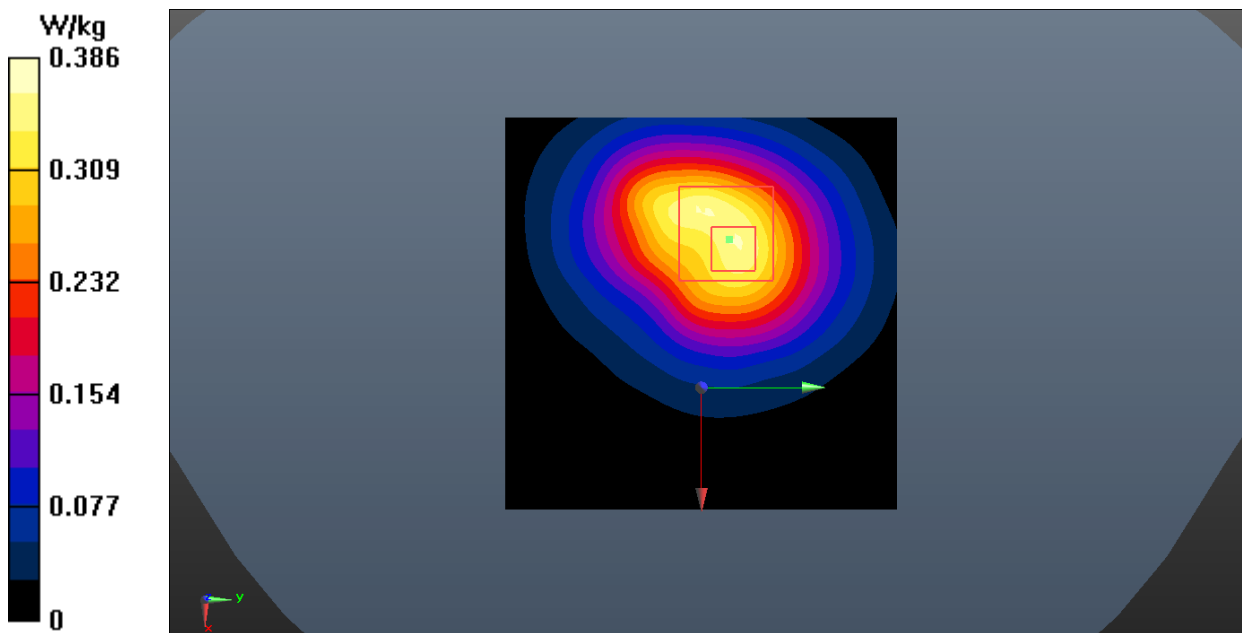

Fig.19 WLAN 2.4G

WLAN 2.4G Wrist worn

Date: 2019-10-9

Electronics: DAE4 Sn786

Medium: Head 2450 MHz

Medium parameters used: $f = 2412$ MHz; $\sigma = 1.783$ S/m; $\epsilon_r = 38.557$; $\rho = 1000$ kg/m³

Ambient Temperature: 22.0°C Liquid Temperature: 21.5°C

Communication System: UID 0, WiFi (0) Frequency: 2412 MHz Duty Cycle: 1:1

Probe: EX3DV4 – SN3633 ConvF (7.33, 7.33, 7.33);

Rear Side Low /Area Scan (61x61x1): Interpolated grid: dx=1.500 mm, dy=1.500 mm

Maximum value of SAR (interpolated) = 0.982 W/kg

Rear Side Low/Zoom Scan (5x5x7)/Cube 0: Measurement grid: dx=8mm, dy=8mm, dz=5mm

Reference Value = 6.212 V/m; Power Drift = 0.05 dB

Peak SAR (extrapolated) = 1.25 W/kg

SAR(1 g) = 0.577 W/kg; SAR(10 g) = 0.285 W/kg

Maximum value of SAR (measured) = 0.849 W/kg

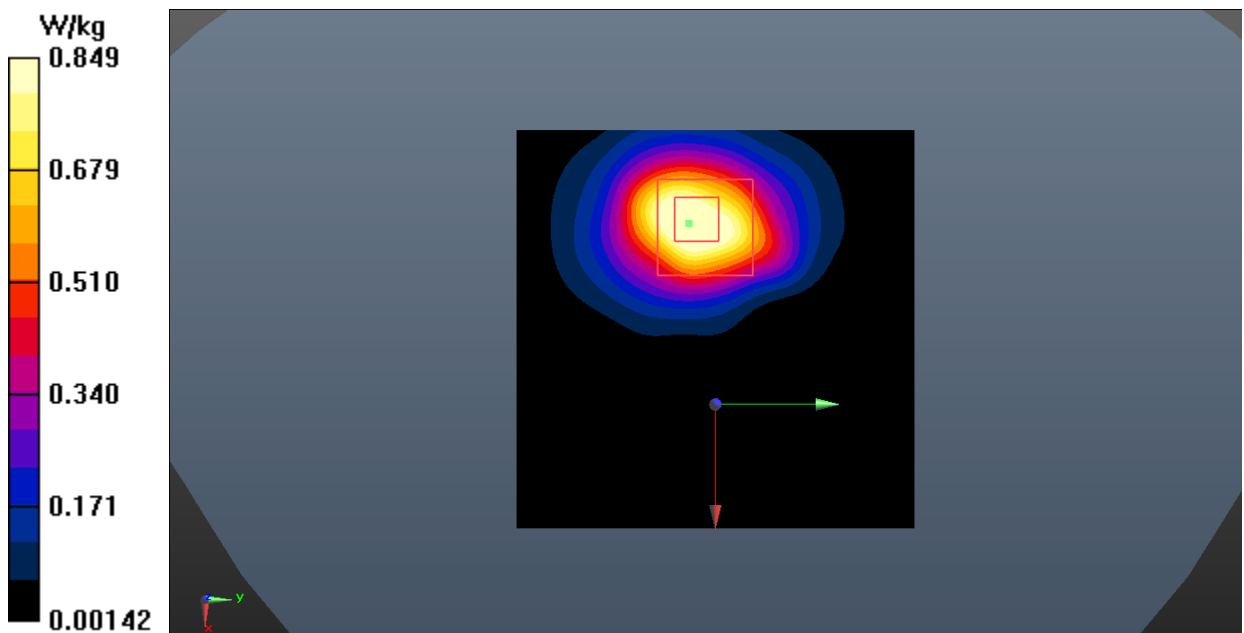

Fig.20 WLAN 2.4G

ANNEX B: System Verification Results

835MHz

Date: 2019-9-30

Electronics: DAE4 Sn786

Medium: Head 835 MHz

Medium parameters used: $f = 835 \text{ MHz}$; $\sigma = 0.923 \text{ S/m}$; $\epsilon_r = 40.237$; $\rho = 1000 \text{ kg/m}^3$

Ambient Temperature: 22.9°C Liquid Temperature: 22.5°C

Communication System: CW Frequency: 835 MHz Duty Cycle: 1:1

Probe: EX3DV4 - SN3633 ConvF (9.51, 9.51, 9.51)

System Validation /Area Scan (81x161x1): Interpolated grid: $dx=1.000 \text{ mm}$, $dy=1.000 \text{ mm}$

Reference Value = 61.402 V/m ; Power Drift = 0.08 dB

SAR(1 g) = 2.49 W/kg ; SAR(10 g) = 1.60 W/kg

Maximum value of SAR (interpolated) = 2.66 W/kg

System Validation /Zoom Scan (7x7x7)/Cube 0: Measurement grid: $dx=5\text{mm}$, $dy=5\text{mm}$, $dz=5\text{mm}$

Reference Value = 61.402 V/m ; Power Drift = 0.08 dB

Peak SAR (extrapolated) = 3.44 W/kg

SAR(1 g) = 2.52 W/kg ; SAR(10 g) = 1.62 W/kg

Maximum value of SAR (measured) = 2.70 W/kg

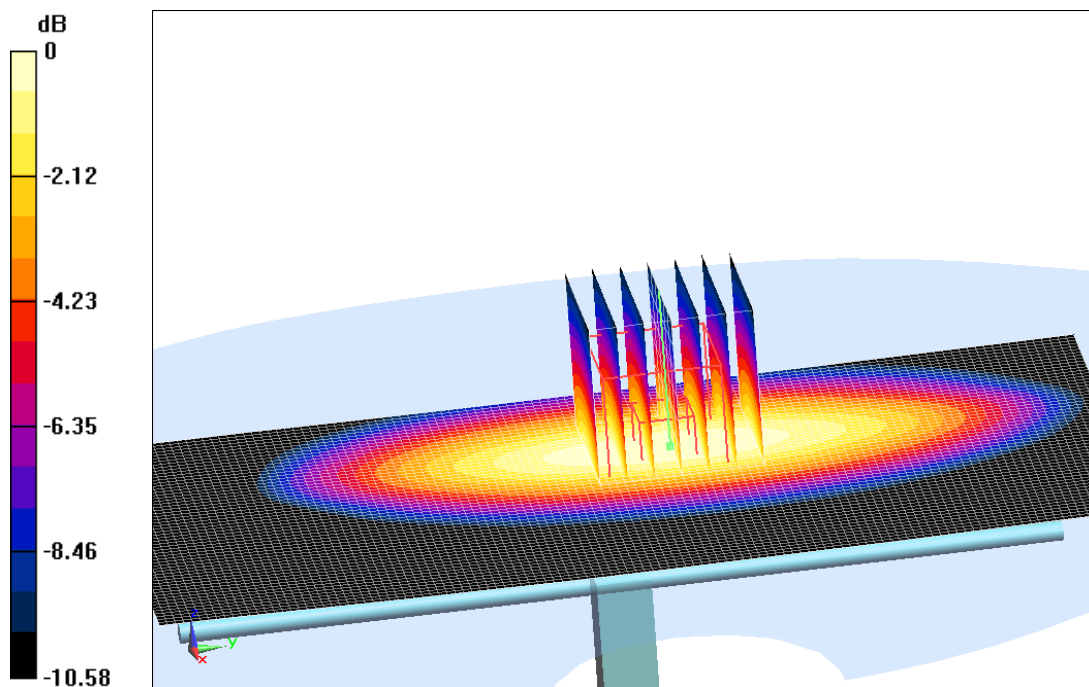

$0 \text{ dB} = 2.70 \text{ W/kg} = 4.31 \text{ dB W/kg}$

Fig.B.1. Validation 835MHz 250mW

1750MHz

Date: 2019-10-4

©Copyright. All rights reserved by SAICT.

Electronics: DAE4 Sn786

Medium: Head 1750 MHz

Medium parameters used: $f = 1750$ MHz; $\sigma = 1.358$ S/m; $\epsilon_r = 40.621$; $\rho = 1000$ kg/m³

Ambient Temperature: 22.0°C Liquid Temperature: 21.5°C

Communication System: CW Frequency: 1750 MHz Duty Cycle: 1:1

Probe: EX3DV4 - SN3633 ConvF (8.07, 8.07, 8.07)

System Validation/Area Scan (61x121x1): Interpolated grid: dx=1.000 mm, dy=1.000 mm

Reference Value = 77.549 V/m; Power Drift = -0.02 dB

SAR(1 g) = 8.89 W/kg; SAR(10 g) = 4.76 W/kg

Maximum value of SAR (interpolated) = 10.8 W/kg

System Validation/Zoom Scan (7x7x7)/Cube 0: Measurement grid: dx=5mm, dy=5mm, dz=5mm

Reference Value = 77.549 V/m; Power Drift = -0.02 dB

Peak SAR (extrapolated) = 17.5 W/kg

SAR(1 g) = 8.77 W/kg; SAR(10 g) = 4.71 W/kg

Maximum value of SAR (measured) = 10.6 W/kg

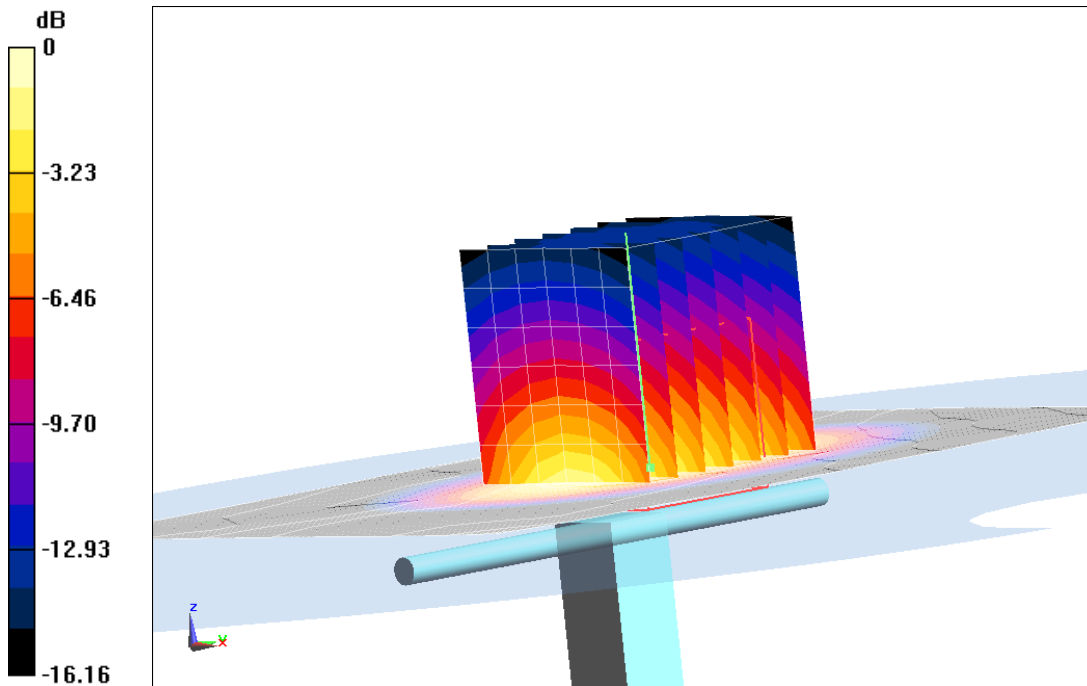

0 dB = 10.6 W/kg = 10.25 dB W/kg

Fig.B.2. Validation 1750MHz 250mW

1900MHz

Date: 2019-10-4

Electronics: DAE4 Sn786

Medium: Head 1900 MHz

Medium parameters used: $f = 1900 \text{ MHz}$; $\sigma = 1.424 \text{ S/m}$; $\epsilon_r = 39.778$; $\rho = 1000 \text{ kg/m}^3$

Ambient Temperature: 22.9°C Liquid Temperature: 22.5°C

Communication System: CW Frequency: 1900 MHz Duty Cycle: 1:1

Probe: EX3DV4 - SN3633 ConvF (7.63, 7.63, 7.63)

System Validation /Area Scan (81x121x1): Interpolated grid: $dx=1.000 \text{ mm}$, $dy=1.000 \text{ mm}$

Reference Value = 91.756 V/m ; Power Drift = 0.10 dB

SAR(1 g) = 10.3 W/kg ; SAR(10 g) = 5.29 W/kg

Maximum value of SAR (interpolated) = 13.5 W/kg

System Validation /Zoom Scan (7x7x7)/Cube 0: Measurement grid: $dx=5\text{mm}$, $dy=5\text{mm}$, $dz=5\text{mm}$

Reference Value = 91.756 V/m ; Power Drift = 0.10 dB

Peak SAR (extrapolated) = 22.1 W/kg

SAR(1 g) = 10.5 W/kg ; SAR(10 g) = 5.38 W/kg

Maximum value of SAR (measured) = 13.8 W/kg

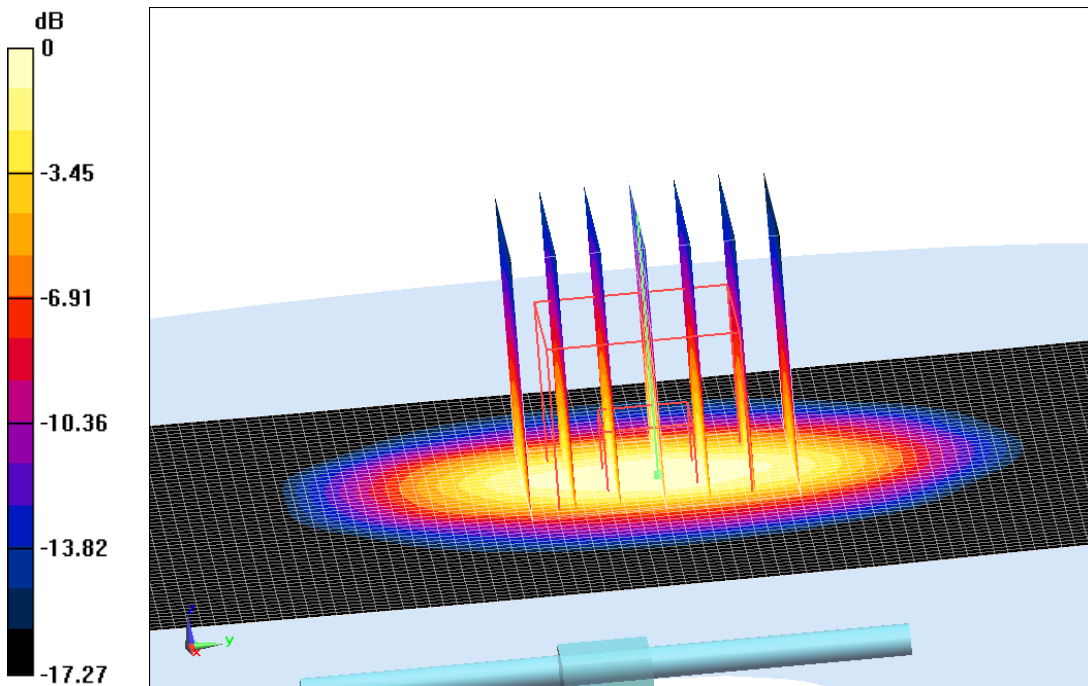

0 dB = 13.8 W/kg = 11.40 dB W/kg

Fig.B.3. Validation 1900MHz 250mW

2450MHz

Date: 2019-10-9

Electronics: DAE4 Sn786

Medium: Head 2450 MHz

Medium parameters used: $f = 2450$ MHz; $\sigma = 1.828$ S/m; $\epsilon_r = 38.432$; $\rho = 1000$ kg/m³

Ambient Temperature: 22.0°C Liquid Temperature: 21.6°C

Communication System: CW Frequency: 2450 MHz Duty Cycle: 1:1

Probe: EX3DV4 – SN3633 ConvF (7.33, 7.33, 7.33);

System Validation /Area Scan (61x81x1): Interpolated grid: dx=1.000 mm, dy=1.000 mm

Reference Value = 92.522 V/m; Power Drift = 0.03 dB

SAR(1 g) = 13.3 W/kg; SAR(10 g) = 6.10 W/kg

Maximum value of SAR (interpolated) = 15.5 W/kg

System Validation /Zoom Scan (7x7x7)/Cube 0: Measurement grid: dx=5mm, dy=5mm, dz=5mm

Reference Value = 92.522 V/m; Power Drift = 0.03 dB

Peak SAR (extrapolated) = 27.3 W/kg

SAR(1 g) = 13.4 W/kg; SAR(10 g) = 6.12 W/kg

Maximum value of SAR (measured) = 15.8 W/kg

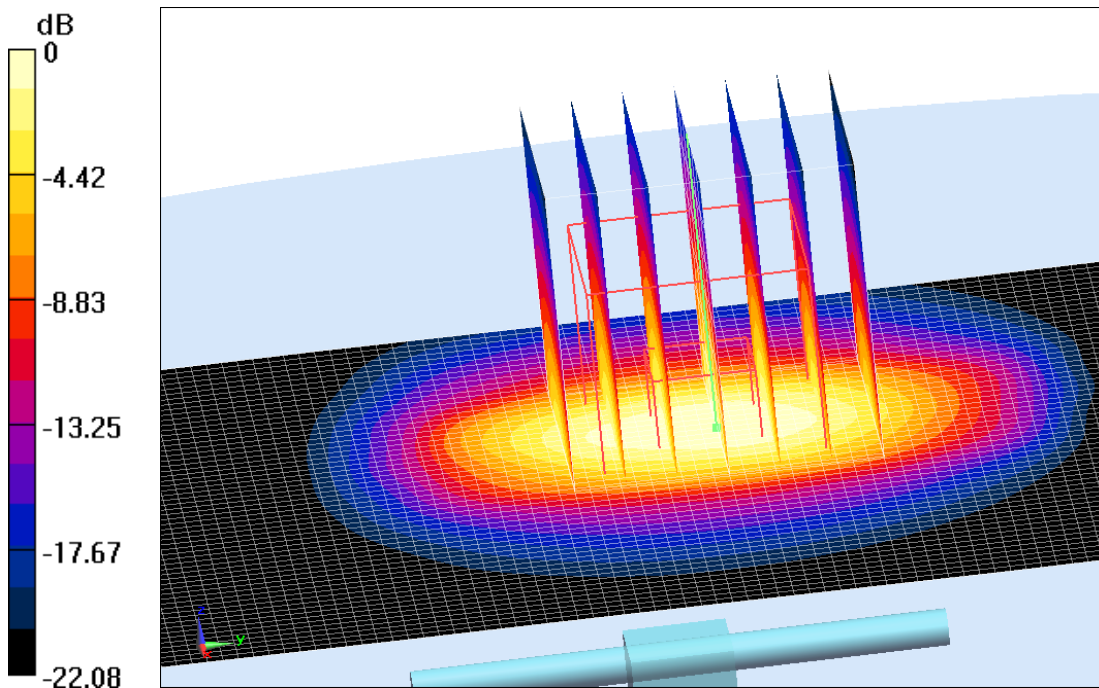

0 dB = 15.8 W/kg = 11.99 dB W/kg

Fig.B.4. Validation 2450MHz 250mW

2550MHz

Date: 2019-10-4

Electronics: DAE4 Sn786

Medium: Head 2550 MHz

Medium parameters used: $f = 2550 \text{ MHz}$; $\sigma = 1.945 \text{ S/m}$; $\epsilon_r = 38.064$; $\rho = 1000 \text{ kg/m}^3$

Ambient Temperature: 22.0°C Liquid Temperature: 21.6°C

Communication System: CW Frequency: 2550 MHz Duty Cycle: 1:1

Probe: EX3DV4 - SN3633 ConvF (7.12, 7.12, 7.12)

System Validation/Area Scan (81x101x1): Interpolated grid: $dx=1.000 \text{ mm}$, $dy=1.000 \text{ mm}$

Reference Value = 94.638 V/m ; Power Drift = 0.12 dB

SAR(1 g) = 14.7 W/kg ; SAR(10 g) = 6.66 W/kg

Maximum value of SAR (interpolated) = 16.7 W/kg

System Validation/Zoom Scan (7x7x7)/Cube 0: Measurement grid: $dx=5\text{mm}$, $dy=5\text{mm}$, $dz=5\text{mm}$

Reference Value = 94.638 V/m ; Power Drift = 0.12 dB

Peak SAR (extrapolated) = 29.8 W/kg

SAR(1 g) = 15.1 W/kg ; SAR(10 g) = 6.80 W/kg

Maximum value of SAR (measured) = 17.0 W/kg

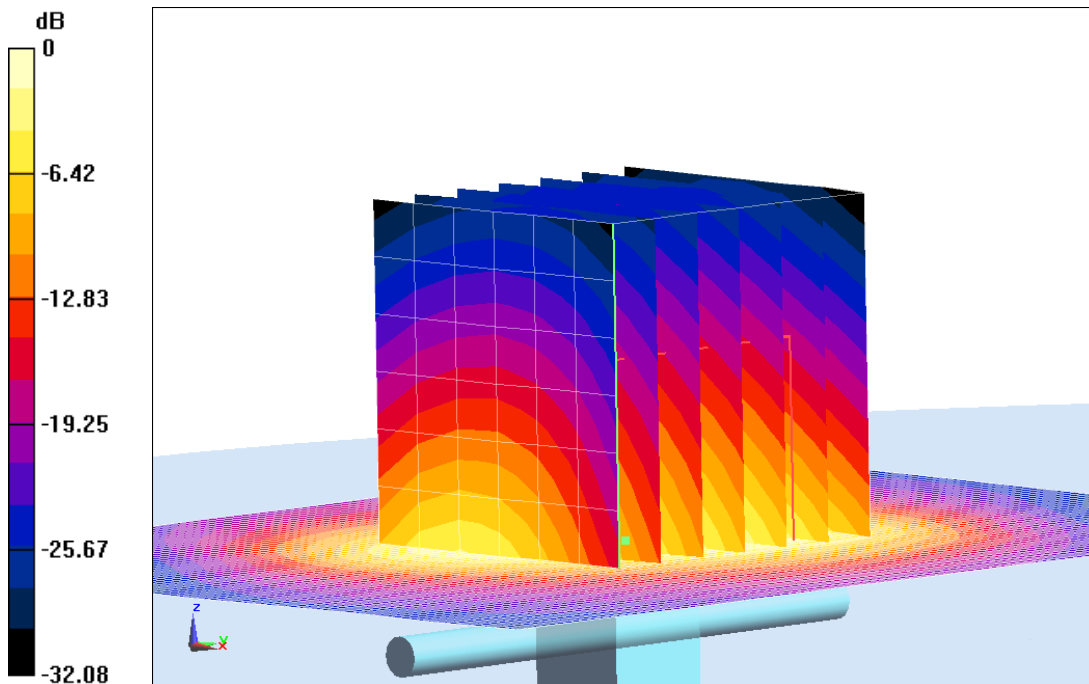

0 dB = 17.0 W/kg = 12.30 dB W/kg

Fig.B.5. Validation 2550MHz 250mW

ANNEX C: SAR Measurement Setup

C.1. Measurement Set-up

DASY5 system for performing compliance tests is illustrated above graphically. This system consists of the following items:

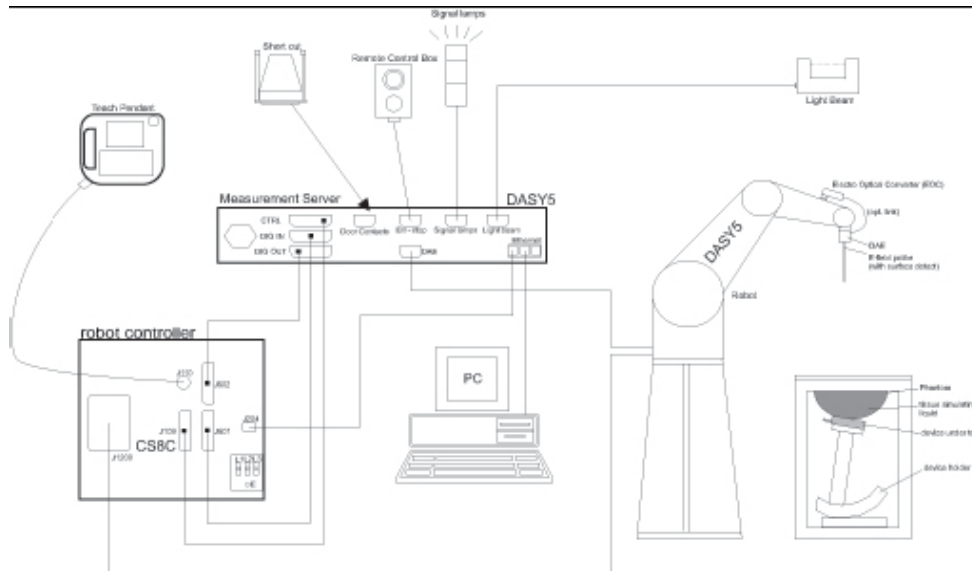

Picture C.1 SAR Lab Test Measurement Set-up

- A standard high precision 6-axis robot (Stäubli TX=RX family) with controller, teach pendant and software. An arm extension for accommodating the data acquisition electronics (DAE).
- An isotropic field probe optimized and calibrated for the targeted measurement.
- A data acquisition electronics (DAE) which performs the signal amplification, signal multiplexing, AD-conversion, offset measurements, mechanical surface detection, collision detection, etc. The unit is battery powered with standard or rechargeable batteries. The signal is optically transmitted to the EOC.
- The Electro-optical converter (EOC) performs the conversion from optical to electrical signals for the digital communication to the DAE. To use optical surface detection, a special version of the EOC is required. The EOC signal is transmitted to the measurement server.
- The function of the measurement server is to perform the time critical tasks such as signal filtering, control of the robot operation and fast movement interrupts.
- The Light Beam used is for probe alignment. This improves the (absolute) accuracy of the probe positioning.
- A computer running WinXP and the DASY5 software.
- Remote control and teach pendant as well as additional circuitry for robot safety such as
- warning lamps, etc.
- The phantom, the device holder and other accessories according to the targeted measurement.

C.2. DASY5 E-field Probe System

The SAR measurements were conducted with the dosimetric probe designed in the classical triangular configuration and optimized for dosimetric evaluation. The probe is constructed using the thick film technique; with printed resistive lines on ceramic substrates. The probe is equipped with an optical multifiber line ending at the front of the probe tip. It is connected to the EOC box on the robot arm and provides an automatic detection of the phantom surface. Half of the fibers are connected to a pulsed infrared transmitter, the other half to a synchronized receiver. As the probe approaches the surface, the reflection from the surface produces a coupling from the transmitting to the receiving fibers. This reflection increases first during the approach, reaches maximum and then decreases. If the probe is flatly touching the surface, the coupling is zero. The distance of the coupling maximum to the surface is independent of the surface reflectivity and largely independent of the surface to probe angle. The DASY5 software reads the reflection during a software approach and looks for the maximum using 2nd order curve fitting. The approach is stopped at reaching the maximum.

Probe Specifications:

Model:	ES3DV3, EX3DV4
Frequency	10MHz — 6.0GHz(EX3DV4)
Range:	10MHz — 4GHz(ES3DV3)
Calibration:	In head and body simulating tissue at Frequencies from 835 up to 5800MHz
Linearity:	± 0.2 dB(30 MHz to 6 GHz) for EX3DV4 ± 0.2 dB(30 MHz to 4 GHz) for ES3DV3
Dynamic Range:	10 mW/kg — 100W/kg
Probe Length:	330 mm
Probe Tip	
Length:	20 mm
Body Diameter:	12 mm
Tip Diameter:	2.5 mm (3.9 mm for ES3DV3)
Tip-Center:	1 mm (2.0mm for ES3DV3)
Application:	SAR Dosimetry Testing Compliance tests of mobile phones Dosimetry in strong gradient fields



Picture C.2 Near-field Probe



Picture C.3 E-field Probe

C.3. E-field Probe Calibration

Each E-Probe/Probe Amplifier combination has unique calibration parameters. A TEM cell calibration procedure is conducted to determine the proper amplifier settings to enter in the probe parameters. The amplifier settings are determined for a given frequency by subjecting the probe to a known E-field density (1 mW/cm^2) using an RF Signal generator, TEM cell, and RF Power Meter.

The free space E-field from amplified probe outputs is determined in a test chamber. This calibration can be performed in a TEM cell if the frequency is below 1 GHz and in a waveguide or other methodologies above 1 GHz for free space. For the free space calibration, the probe is placed

in the volumetric center of the cavity and at the proper orientation with the field. The probe is then rotated 360 degrees until the three channels show the maximum reading. The power density readings equates to 1 mW/ cm²:

E-field temperature correlation calibration is performed in a flat phantom filled with the appropriate simulated brain tissue. The E-field in the medium correlates with the temperature rise in the dielectric medium. For temperature correlation calibration a RF transparent thermistor-based temperature probe is used in conjunction with the E-field probe.

$$SAR = C \frac{\Delta T}{\Delta t}$$

Where:

Δt = Exposure time (30 seconds),

C = Heat capacity of tissue (brain or muscle),

ΔT = Temperature increase due to RF exposure.

$$SAR = \frac{|E|^2 \cdot \sigma}{\rho}$$

Where:

σ = Simulated tissue conductivity,

ρ = Tissue density (kg/m³).

C.4. Other Test Equipment

C.4.1 Data Acquisition Electronics (DAE)

The data acquisition electronics consist of a highly sensitive electrometer-grade preamplifier with auto-zeroing, a channel and gain-switching multiplexer, a fast 16 bit AD-converter and a command decoder with a control logic unit. Transmission to the measurement server is accomplished through an optical downlink for data and status information, as well as an optical uplink for commands and the clock.

The mechanical probe mounting device includes two different sensor systems for frontal and sideways probe contacts. They are used for mechanical surface detection and probe collision detection.

The input impedance of the DAE is 200 MOhm; the inputs are symmetrical and floating. Common mode rejection is above 80 dB.



PictureC.4: DAE

C.4.2. Robot

The SPEAG DASY system uses the high precision robots (DASY5: RX160L) type from Stäubli SA (France). For the 6-axis controller system, the robot controller version from Stäubli is used. The Stäubli robot series have many features that are important for our application:

- High precision (repeatability 0.02mm)
- High reliability (industrial design)
- Low maintenance costs (virtually maintenance free due to direct drive gears; no belt drives)
- Jerk-free straight movements (brushless synchron motors; no stepper motors)
- Low ELF interference (motor control fields shielded via the closed metallic construction shields)



Picture C.5 DASY 5

C.4.3. Measurement Server

The Measurement server is based on a PC/104 CPU board with CPU (DASY5: 400 MHz, Intel Celeron), chipdisk (DASY5:128MB), RAM (DASY5:128MB). The necessary circuits for communication with the DAE electronic box, as well as the 16 bit AD converter system for optical detection and digital I/O interface are contained on the DASY I/O board, which is directly connected to the PC/104 bus of the CPU board.

The measurement server performs all real-time data evaluation of field measurements and surface detection, controls robot movements and handles safety operation. The PC operating system cannot interfere with these time critical processes. All connections are supervised by a watchdog, and disconnection of any of the cables to the measurement server will automatically disarm the robot and disable all program-controlled robot movements. Furthermore, the measurement server is equipped with an expansion port which is reserved for future applications. Please note that this expansion port does not have a standardized pinout, and therefore only devices provided by SPEAG can be connected. Devices from any other supplier could seriously damage the measurement server.



Picture C.6 Server for DASY 5

C.4.4. Device Holder for Phantom

The SAR in the phantom is approximately inversely proportional to the square of the distance between the source and the liquid surface. For a source at 5mm distance, a positioning uncertainty of $\pm 0.5\text{mm}$ would produce a SAR uncertainty of $\pm 20\%$. Accurate device positioning is therefore crucial for accurate and repeatable measurements. The positions in which the devices must be measured are defined by the standards.

The DASY device holder is designed to cope with the different positions given in the standard. It has two scales for device rotation (with respect to the body axis) and device inclination (with respect to the line between the ear reference points). The rotation centers for both scales is the ear reference point (ERP). Thus the device needs no repositioning when changing the angles.

The DASY device holder is constructed of low-loss POM material having the following dielectric

parameters: relative permittivity $\epsilon = 3$ and loss tangent $\delta = 0.02$. The amount of dielectric material has been reduced in the closest vicinity of the device, since measurements have suggested that the influence of the clamp on the test results could thus be lowered.

<Laptop Extension Kit>

The extension is lightweight and made of POM, acrylic glass and foam. It fits easily on the upper part of the Mounting Device in place of the phone positioner. The extension is fully compatible with the Twin-SAM and ELI phantoms.



Picture C.7-1: Device Holder

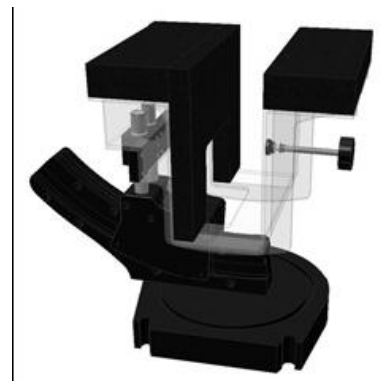

Picture C.7-2: Laptop Extension Kit

C.4.5. Phantom

The SAM Twin Phantom V4.0 is constructed of a fiberglass shell integrated in a table. The shape of the shell is based on data from an anatomical study designed to

Represent the 90th percentile of the population. The phantom enables the dissymmetric evaluation of SAR for both left and right handed handset usage, as well as body-worn usage using the flat phantom region. Reference markings on the Phantom allow the complete setup of all predefined phantom positions and measurement grids by manually teaching three points in the robot. The shell phantom has a 2mm shell thickness (except the ear region where shell thickness increases to 6 mm).



Shell Thickness: 2 ± 0.2 mm
Filling Volume: Approx. 25 liters
Dimensions: 810 x 1000 x 500 mm (H x L x W)
Available: Special



Picture C.8: SAM Twin Phantom

ANNEX D: Position of the wireless device in relation to the phantom

D.1. General Considerations

This standard specifies two handset test positions against the head phantom – the “cheek” position and the “tilt” position.

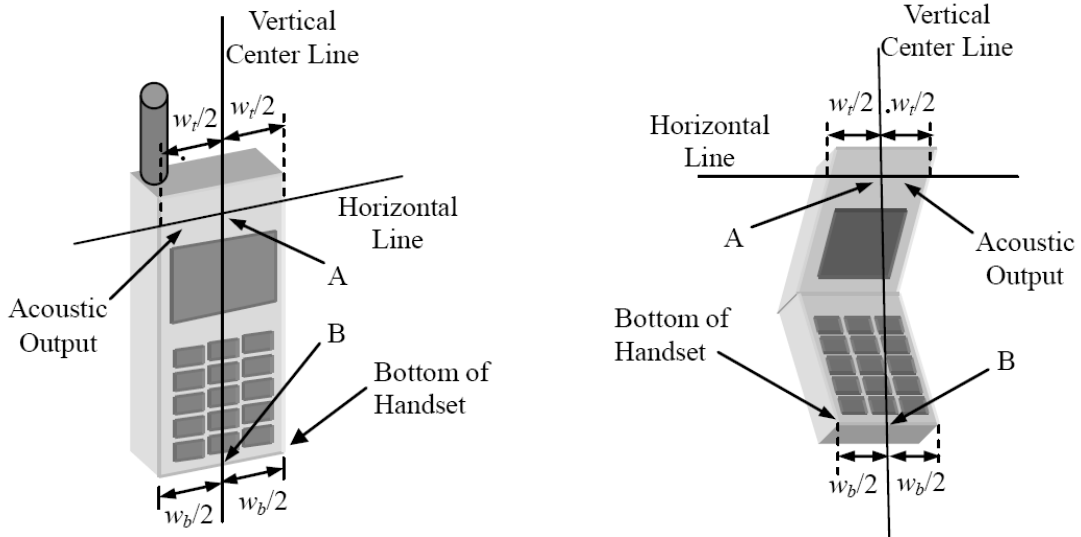

- w_t Width of the handset at the level of the acoustic
- w_b Width of the bottom of the handset
- A Midpoint of the width w_t of the handset at the level of the acoustic output
- B Midpoint of the width w_b of the bottom of the handset

Picture D.1-a Typical “fixed” case handset Picture D.1-b Typical “clam-shell” case handset

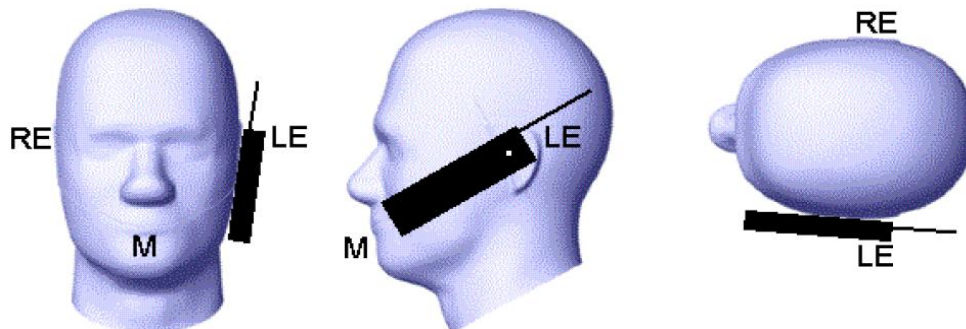

Picture D.2 Cheek position of the wireless device on the left side of SAM

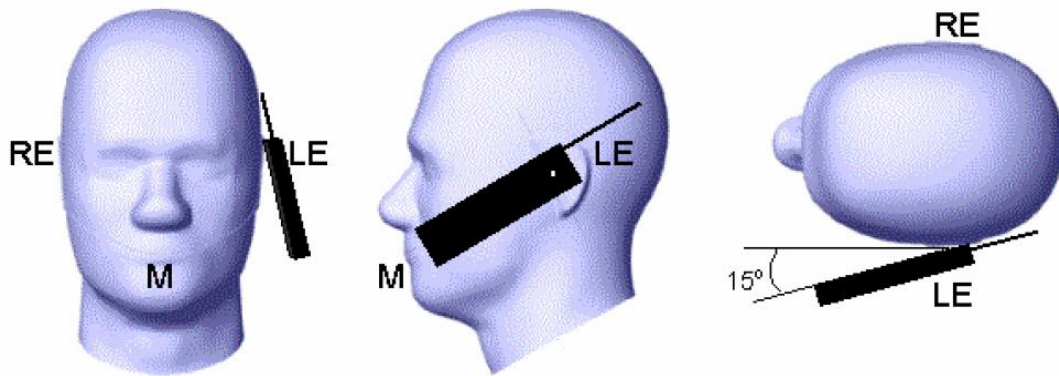

Picture D.3 Tilt position of the wireless device on the left side of SAM

D.2. Body-worn device

A typical example of a body-worn device is a mobile phone, wireless enabled PDA or other battery operated wireless device with the ability to transmit while mounted on a person's body using a carry accessory approved by the wireless device manufacturer.

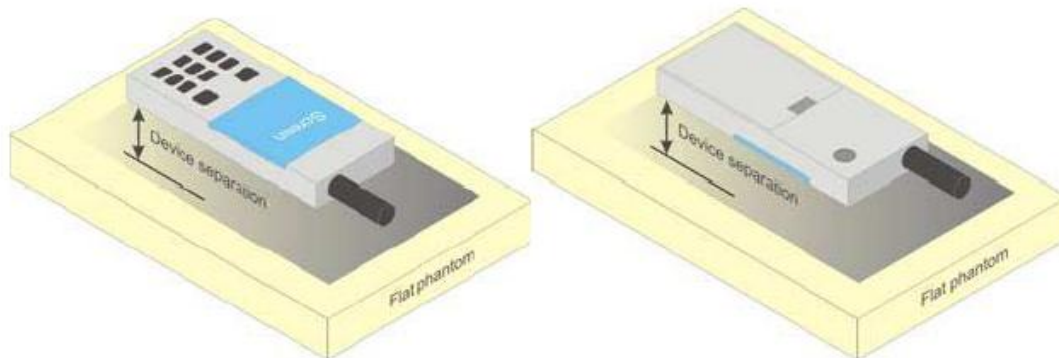

Picture D.4 Test positions for body-worn devices

D.3. Desktop device

A typical example of a desktop device is a wireless enabled desktop computer placed on a table or desk when used.

The DUT shall be positioned at the distance and in the orientation to the phantom that corresponds to the intended use as specified by the manufacturer in the user instructions. For devices that employ an external antenna with variable positions, tests shall be performed for all antenna positions specified. Picture 8.5 show positions for desktop device SAR tests. If the intended use is not specified, the device shall be tested directly against the flat phantom.

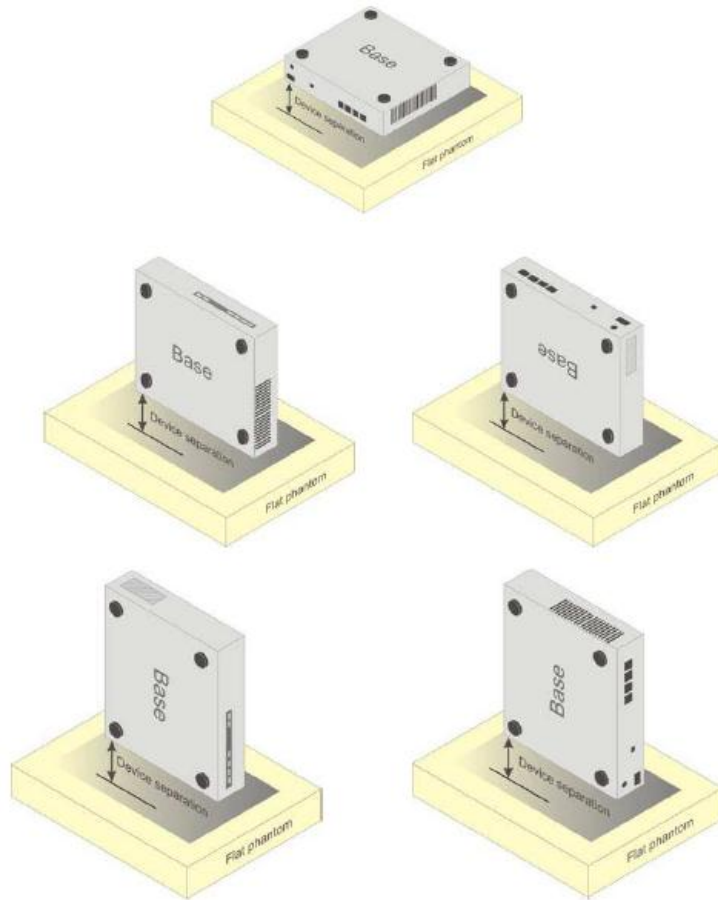

Picture D.5 Test positions for desktop devices

D.4. DUT Setup Photos

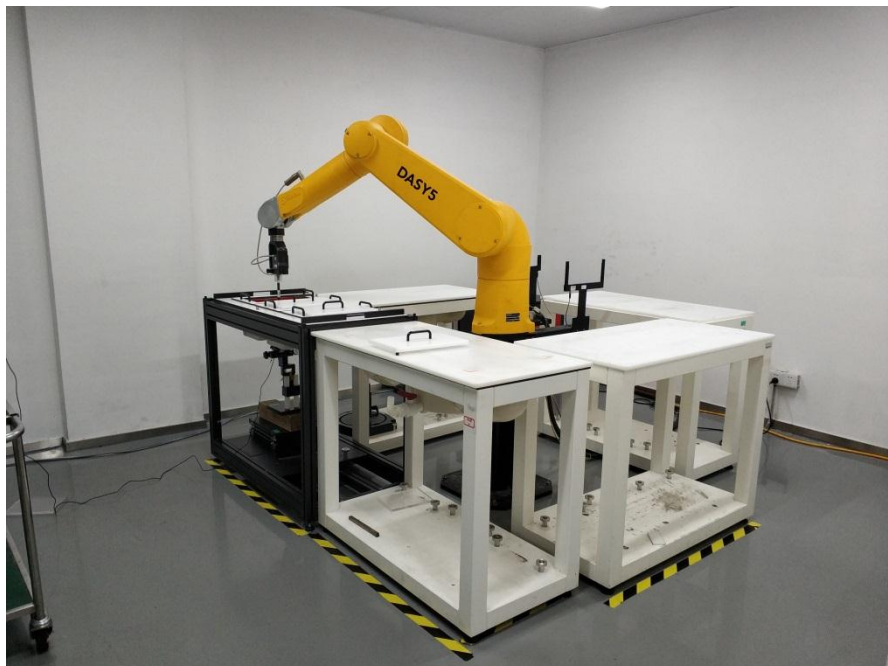

Picture D.6

ANNEX E: Equivalent Media Recipes

The liquid used for the frequency range of 700-6000 MHz consisted of water, sugar, salt, preventol, glycol monobutyl and Cellulose. The liquid has been previously proven to be suited for worst-case. The Table E.1 shows the detail solution. It's satisfying the latest tissue dielectric parameters requirements proposed by the IEEE 1528 and IEC 62209.

Table E.1: Composition of the Tissue Equivalent Matter

Frequency (MHz)	835 Head	835 Body	1900 Head	1900 Body	2450 Head	2450 Body	5800 Head	5800 Body
Ingredients (% by weight)								
Water	41.45	52.5	55.242	69.91	58.79	72.60	65.53	65.53
Sugar	56.0	45.0	\	\	\	\	\	\
Salt	1.45	1.4	0.306	0.13	0.06	0.18	\	\
Preventol	0.1	0.1	\	\	\	\	\	\
Cellulose	1.0	1.0	\	\	\	\	\	\
Glycol Monobutyl	\	\	44.452	29.96	41.15	27.22	\	\
Diethylenglycol monohexylether	\	\	\	\	\	\	17.24	17.24
Triton X-100	\	\	\	\	\	\	17.24	17.24
Dielectric Parameters Target Value	$\epsilon=41.5$ $\sigma=0.90$	$\epsilon=55.2$ $\sigma=0.97$	$\epsilon=40.0$ $\sigma=1.40$	$\epsilon=53.3$ $\sigma=1.52$	$\epsilon=39.2$ $\sigma=1.80$	$\epsilon=52.7$ $\sigma=1.95$	$\epsilon=35.3$ $\sigma=5.27$	$\epsilon=48.2$ $\sigma=6.00$

Note: There is a little adjustment respectively for 750, 1800, 2600, 5200, 5300, and 5600, based on the recipe of closest frequency in table E.1

ANNEX F: System Validation

The SAR system must be validated against its performance specifications before it is deployed. When SAR probes, system components or software are changed, upgraded or recalibrated, these must be validated with the SAR system(s) that operates with such components.

Table F.1: System Validation

Probe SN.	Liquid name	Validation date	Frequency point	Status (OK or Not)
3151	Head 835MHz	2021-04-29	835 MHz	OK
3151	Head 1750MHz	2021-04-29	1750 MHz	OK
3151	Head 1900MHz	2021-04-29	1900 MHz	OK
3151	Head 2450MHz	2021-04-30	2450 MHz	OK
3151	Head 2550MHz	2021-04-30	2550 MHz	OK



ANNEX G: DAE Calibration Certificate



Add: No.52 HuaYuanBei Road, Haidian District, Beijing, 100191, China
Tel: +86-10-62304633-2512 Fax: +86-10-62304633-2504
E-mail: cttl@chinattl.com Http://www.chinattl.cn



中国认可
国际互认
校准
CALIBRATION
CNAS L0570

Client : CTTL(South Branch)

Certificate No: Z21-60093

CALIBRATION CERTIFICATE			
Object	DAE4 - SN: 786		
Calibration Procedure(s)	FF-Z11-002-01 Calibration Procedure for the Data Acquisition Electronics (DAEx)		
Calibration date:	April 09, 2021		
This calibration Certificate documents the traceability to national standards, which realize the physical units of measurements(SI). The measurements and the uncertainties with confidence probability are given on the following pages and are part of the certificate.			
All calibrations have been conducted in the closed laboratory facility: environment temperature(22±3)°C and humidity<70%.			
Calibration Equipment used (M&TE critical for calibration)			
Primary Standards	ID #	Cal Date(Calibrated by, Certificate No.)	Scheduled Calibration
Process Calibrator 753	1971018	16-Jun-20 (CTTL, No.J20X04342)	Jun-21
Calibrated by:	Name	Function	Signature
	Yu Zongying	SAR Test Engineer	
Reviewed by:	Lin Hao	SAR Test Engineer	
Approved by:	Qi Dianyuan	SAR Project Leader	
			Issued: April 11, 2021
This calibration certificate shall not be reproduced except in full without written approval of the laboratory.			



Add: No.52 HuaYuanBei Road, Haidian District, Beijing, 100191, China
Tel: +86-10-62304633-2512 Fax: +86-10-62304633-2504
E-mail: ttl@chinatl.com Http://www.chinatl.cn

Glossary:

DAE data acquisition electronics
Connector angle information used in DASY system to align probe sensor X to the robot coordinate system.

Methods Applied and Interpretation of Parameters:

- *DC Voltage Measurement:* Calibration Factor assessed for use in DASY system by comparison with a calibrated instrument traceable to national standards. The figure given corresponds to the full scale range of the voltmeter in the respective range.
- *Connector angle:* The angle of the connector is assessed measuring the angle mechanically by a tool inserted. Uncertainty is not required.
- The report provide only calibration results for DAE, it does not contain other performance test results.



Add: No.52 HuaYuanBei Road, Haidian District, Beijing, 100191, China
Tel: +86-10-62304633-2512 Fax: +86-10-62304633-2504
E-mail: ttl@chinatl.com Http: www.chinatl.cn

DC Voltage Measurement

A/D - Converter Resolution nominal
High Range: 1LSB = 6.1μV, full range = -100...+300 mV
Low Range: 1LSB = 61nV, full range = -1.....+3mV
DASY measurement parameters: Auto Zero Time: 3 sec; Measuring time: 3 sec

Calibration Factors	X	Y	Z
High Range	404.112 ± 0.15% (k=2)	404.269 ± 0.15% (k=2)	404.666 ± 0.15% (k=2)
Low Range	3.97192 ± 0.7% (k=2)	3.97396 ± 0.7% (k=2)	3.95762 ± 0.7% (k=2)

Connector Angle

Connector Angle to be used in DASY system	229° ± 1°
---	-----------



ANNEX H: Probe Calibration Certificate



Add: No.52 HuaYuanBei Road, Haidian District, Beijing, 100191, China
Tel: +86-10-62304633-2512 Fax: +86-10-62304633-2504
E-mail: ctll@chinattl.com <http://www.chinattl.cn>



中国认可
国际互认
校准
CALIBRATION
CNAS L0570

Client **CTTL(South Branch)**

Certificate No: **Z21-60094**

CALIBRATION CERTIFICATE

Object: **ES3DV3 - SN : 3151**

Calibration Procedure(s): **FF-Z11-004-02
Calibration Procedures for Dosimetric E-field Probes**

Calibration date: **April 26, 2021**

This calibration Certificate documents the traceability to national standards, which realize the physical units of measurements(SI). The measurements and the uncertainties with confidence probability are given on the following pages and are part of the certificate.

All calibrations have been conducted in the closed laboratory facility; environment temperature(22±3)°C and humidity<70%.

Calibration Equipment used (M&TE critical for calibration)

Primary Standards	ID #	Cal Date(Calibrated by, Certificate No.)	Scheduled Calibration
Power Meter NRP2	101919	16-Jun-20(CTTL, No.J20X04344)	Jun-21
Power sensor NRP-Z91	101547	16-Jun-20(CTTL, No.J20X04344)	Jun-21
Power sensor NRP-Z91	101548	16-Jun-20(CTTL, No.J20X04344)	Jun-21
Reference 10dBAttenuator	18N50W-10dB	10-Feb-20(CTTL, No.J20X00525)	Feb-22
Reference 20dBAttenuator	18N50W-20dB	10-Feb-20(CTTL, No.J20X00526)	Feb-22
Reference Probe EX3DV4	SN 3617	27-Jan-21(SPEAG, No.EX3-3617_Jan21)	Jan-22
DAE4	SN 1556	15-Jan-21(SPEAG, No.DAE4-1556_Jan21)	Jan-22
Secondary Standards	ID #	Cal Date(Calibrated by, Certificate No.)	Scheduled Calibration
SignalGenerator MG3700A	6201052605	23-Jun-20(CTTL, No.J20X04343)	Jun-21
Network Analyzer E5071C	MY48110673	21-Jan-21(CTTL, No.J20X00515)	Jan-22

	Name	Function	Signature
Calibrated by:	Yu Zongying	SAR Test Engineer	
Reviewed by:	Lin Hao	SAR Test Engineer	
Approved by:	Qi Dianyuan	SAR Project Leader	

Issued: April 28, 2021

This calibration certificate shall not be reproduced except in full without written approval of the laboratory.

Glossary:

TSL	tissue simulating liquid
NORM _{x,y,z}	sensitivity in free space
ConvF	sensitivity in TSL / NORM _{x,y,z}
DCP	diode compression point
CF	crest factor (1/duty_cycle) of the RF signal
A,B,C,D	modulation dependent linearization parameters
Polarization Φ	Φ rotation around probe axis
Polarization θ	θ rotation around an axis that is in the plane normal to probe axis (at measurement center), $\theta=0$ is normal to probe axis

Connector Angle information used in DASY system to align probe sensor X to the robot coordinate system

Calibration is Performed According to the Following Standards:

- IEEE Std 1528-2013, "IEEE Recommended Practice for Determining the Peak Spatial-Averaged Specific Absorption Rate (SAR) in the Human Head from Wireless Communications Devices: Measurement Techniques", June 2013
- IEC 62209-1, "Measurement procedure for the assessment of Specific Absorption Rate (SAR) from hand-held and body-mounted devices used next to the ear (frequency range of 300 MHz to 6 GHz)", July 2016
- IEC 62209-2, "Procedure to determine the Specific Absorption Rate (SAR) for wireless communication devices used in close proximity to the human body (frequency range of 30 MHz to 6 GHz)", March 2010
- KDB 865664, "SAR Measurement Requirements for 100 MHz to 6 GHz"

Methods Applied and Interpretation of Parameters:

- NORM_{x,y,z}:** Assessed for E-field polarization $\theta=0$ ($f \leq 900\text{MHz}$ in TEM-cell; $f > 1800\text{MHz}$: waveguide). NORM_{x,y,z} are only intermediate values, i.e., the uncertainties of NORM_{x,y,z} does not effect the E^2 -field uncertainty inside TSL (see below ConvF).
- NORM(f)_{x,y,z} = NORM_{x,y,z} * frequency_response** (see Frequency Response Chart). This linearization is implemented in DASY4 software versions later than 4.2. The uncertainty of the frequency response is included in the stated uncertainty of ConvF.
- DCP_{x,y,z}:** DCP are numerical linearization parameters assessed based on the data of power sweep (no uncertainty required). DCP does not depend on frequency nor media.
- PAR:** PAR is the Peak to Average Ratio that is not calibrated but determined based on the signal characteristics.
- A_{x,y,z}; B_{x,y,z}; C_{x,y,z}; VR_{x,y,z}; A,B,C** are numerical linearization parameters assessed based on the data of power sweep for specific modulation signal. The parameters do not depend on frequency nor media. VR is the maximum calibration range expressed in RMS voltage across the diode.
- ConvF and Boundary Effect Parameters:** Assessed in flat phantom using E-field (or Temperature Transfer Standard for $f \leq 800\text{MHz}$) and inside waveguide using analytical field distributions based on power measurements for $f > 800\text{MHz}$. The same setups are used for assessment of the parameters applied for boundary compensation (alpha, depth) of which typical uncertainty valued are given. These parameters are used in DASY4 software to improve probe accuracy close to the boundary. The sensitivity in TSL corresponds to NORM_{x,y,z} * ConvF whereby the uncertainty corresponds to that given for ConvF. A frequency dependent ConvF is used in DASY version 4.4 and higher which allows extending the validity from $\pm 50\text{MHz}$ to $\pm 100\text{MHz}$.
- Spherical isotropy (3D deviation from isotropy):** in a field of low gradients realized using a flat phantom exposed by a patch antenna.
- Sensor Offset:** The sensor offset corresponds to the offset of virtual measurement center from the probe tip (on probe axis). No tolerance required.
- Connector Angle:** The angle is assessed using the information gained by determining the NORM_x (no uncertainty required).



Add: No.52 HuaYuanBei Road, Haidian District, Beijing, 100191, China
Tel: +86-10-62304633-2512 Fax: +86-10-62304633-2504
E-mail: cttl@chinattl.com [Http://www.chinattl.cn](http://www.chinattl.cn)

DASY/EASY – Parameters of Probe: ES3DV3 – SN:3151

Basic Calibration Parameters

	Sensor X	Sensor Y	Sensor Z	Unc (k=2)
Norm($\mu\text{V}/(\text{V}/\text{m})^2$) ^A	1.17	1.25	1.20	$\pm 10.0\%$
DCP(mV) ^B	105.1	105.5	103.7	

Modulation Calibration Parameters

UID	Communication System Name		A dB	B dB· μV	C	D dB	VR mV	Unc ^E (k=2)
0	CW	X	0.0	0.0	1.0	0.00	277.8	$\pm 2.2\%$
		Y	0.0	0.0	1.0		288.5	
		Z	0.0	0.0	1.0		279.6	

The reported uncertainty of measurement is stated as the standard uncertainty of Measurement multiplied by the coverage factor $k=2$, which for a normal distribution Corresponds to a coverage probability of approximately 95%.

^A The uncertainties of Norm X, Y, Z do not affect the E^2 -field uncertainty inside TSL (see Page 4).

^B Numerical linearization parameter; uncertainty not required.

^E Uncertainty is determined using the max. deviation from linear response applying rectangular distribution and is expressed for the square of the field value.

DASY/EASY – Parameters of Probe: ES3DV3 – SN:3151

Calibration Parameter Determined in Head Tissue Simulating Media

f [MHz] ^C	Relative Permittivity ^F	Conductivity (S/m) ^F	ConvF X	ConvF Y	ConvF Z	Alpha ^G	Depth ^G (mm)	Unct. (k=2)
750	41.9	0.89	6.40	6.40	6.40	0.40	1.40	±12.1%
900	41.5	0.97	6.19	6.19	6.19	0.37	1.57	±12.1%
1450	40.5	1.20	5.48	5.48	5.48	0.31	1.61	±12.1%
1750	40.1	1.37	5.25	5.25	5.25	0.61	1.27	±12.1%
1900	40.0	1.40	5.09	5.09	5.09	0.65	1.25	±12.1%
2000	40.0	1.40	5.07	5.07	5.07	0.63	1.29	±12.1%
2300	39.5	1.67	4.83	4.83	4.83	0.60	1.36	±12.1%
2450	39.2	1.80	4.58	4.58	4.58	0.60	1.45	±12.1%
2600	39.0	1.96	4.39	4.39	4.39	0.70	1.33	±12.1%

^C Frequency validity above 300 MHz of ±100MHz only applies for DASY v4.4 and higher (Page 2), else it is restricted to ±50MHz. The uncertainty is the RSS of ConvF uncertainty at calibration frequency and the uncertainty for the indicated frequency band. Frequency validity below 300 MHz is ± 10, 25, 40, 50 and 70 MHz for ConvF assessments at 30, 64, 128, 150 and 220 MHz respectively. Above 5 GHz frequency validity can be extended to ± 110 MHz.

^F At frequency below 3 GHz, the validity of tissue parameters (ϵ and σ) can be relaxed to ±10% if liquid compensation formula is applied to measured SAR values. At frequencies above 3 GHz, the validity of tissue parameters (ϵ and σ) is restricted to ±5%. The uncertainty is the RSS of the ConvF uncertainty for indicated target tissue parameters.

^G Alpha/Depth are determined during calibration. SPEAG warrants that the remaining deviation due to the boundary effect after compensation is always less than ± 1% for frequencies below 3 GHz and below ± 2% for the frequencies between 3-6 GHz at any distance larger than half the probe tip diameter from the boundary.



Frequency Response of E-Field (TEM-Cell: ifi110 EXX, Waveguide: R22)

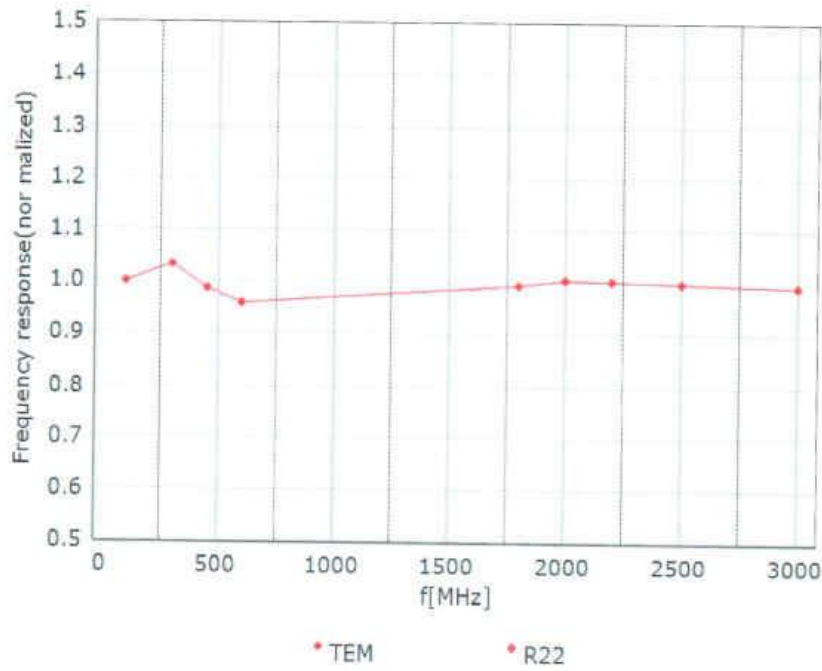

Uncertainty of Frequency Response of E-field: $\pm 7.4\%$ ($k=2$)

Receiving Pattern (Φ), $\theta=0^\circ$

f=600 MHz, TEM

f=1800 MHz, R22

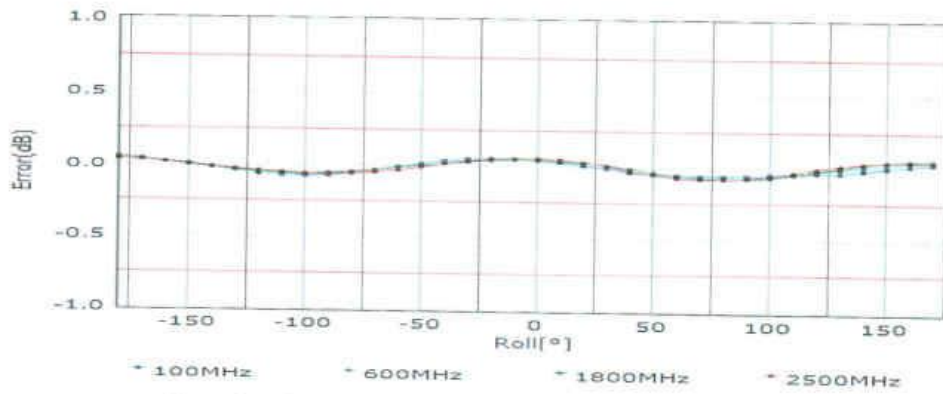
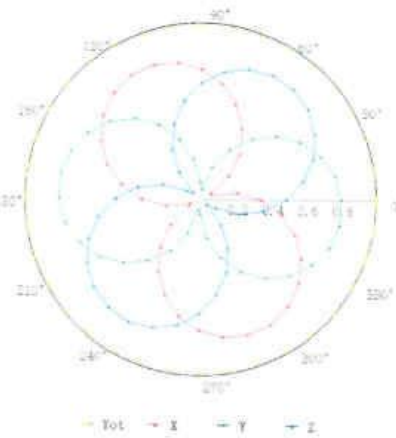
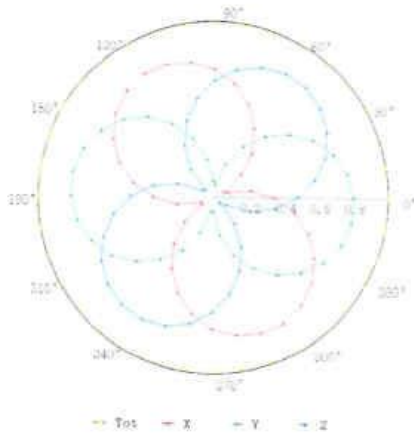

Uncertainty of Axial Isotropy Assessment: $\pm 1.2\%$ ($k=2$)



Add: No.52 HuaYuanBei Road, Haidian District, Beijing, 100191, China
 Tel: +86-10-62304633-2512 Fax: +86-10-62304633-2504
 E-mail: cttl@chinattl.com <http://www.chinattl.cn>

Dynamic Range f(SAR_{head}) (TEM cell, f = 900 MHz)

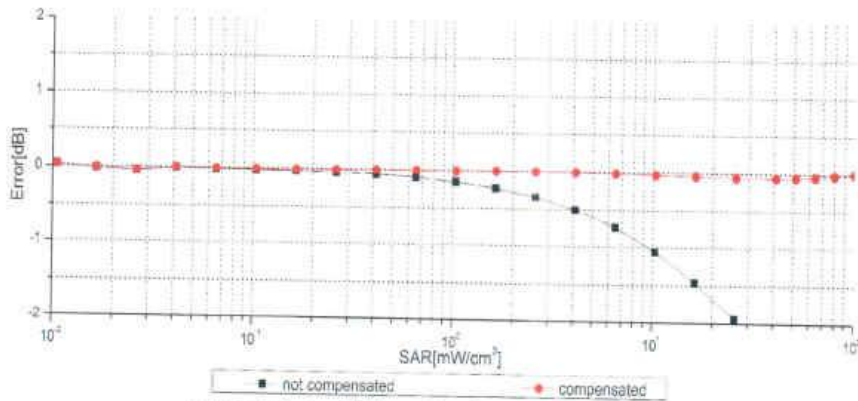
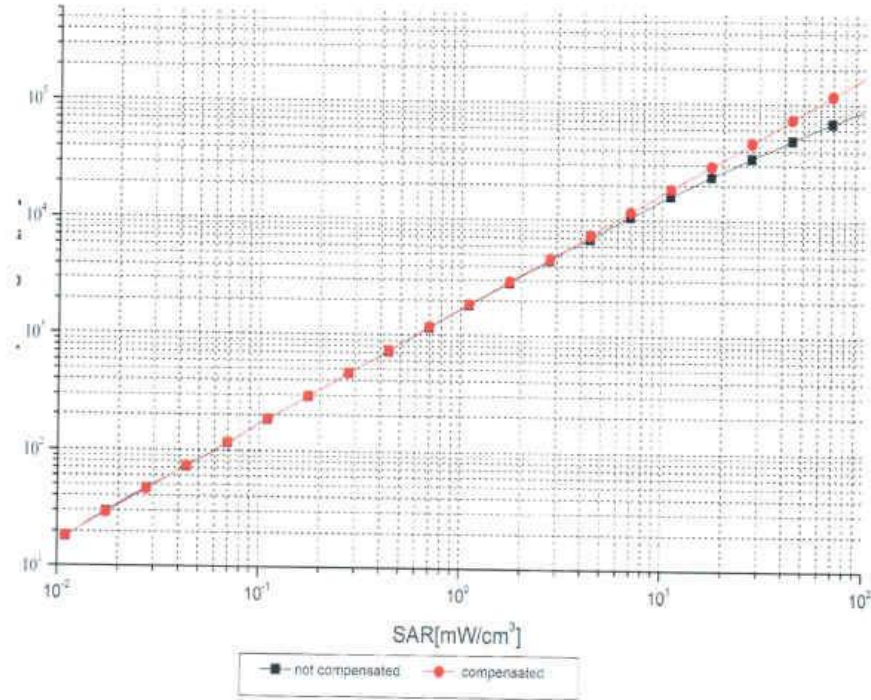

Uncertainty of Linearity Assessment: ±0.9% (k=2)



Add: No.52 HuaYuanBei Road, Haidian District, Beijing, 100191, China
 Tel: +86-10-62304633-2512 Fax: +86-10-62304633-2504
 E-mail: cttl@chinattl.com [Http://www.chinattl.cn](http://www.chinattl.cn)

Conversion Factor Assessment

f=750 MHz,WGLS R9(H_convF)

f=1750 MHz,WGLS R22(H_convF)

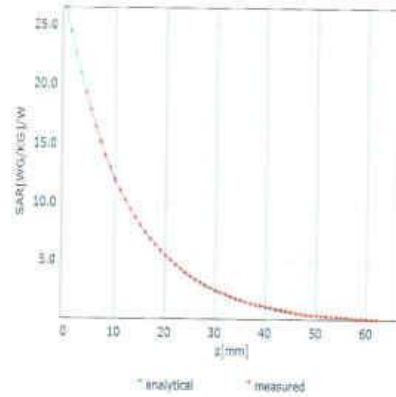
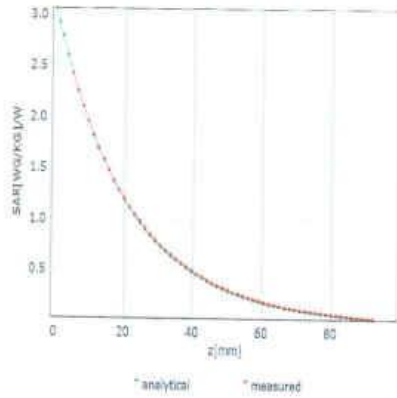

Deviation from Isotropy in Liquid

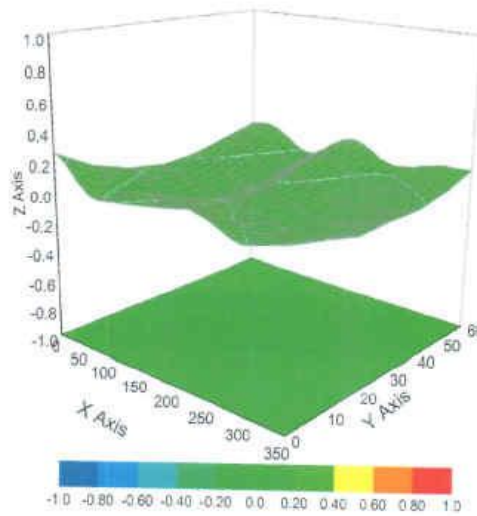

Uncertainty of Spherical Isotropy Assessment: $\pm 3.2\%$ ($k=2$)



Add: No.52 HuaYuanBei Road, Haidian District, Beijing, 100191, China
Tel: +86-10-62304633-2512 Fax: +86-10-62304633-2504
E-mail: ctl@chinatl.com <http://www.chinatl.cn>

DASY/EASY – Parameters of Probe: ES3DV3 – SN:3151

Other Probe Parameters

Sensor Arrangement	Triangular
Connector Angle (°)	87.5
Mechanical Surface Detection Mode	enabled
Optical Surface Detection Mode	disable
Probe Overall Length	337mm
Probe Body Diameter	10mm
Tip Length	10mm
Tip Diameter	4mm
Probe Tip to Sensor X Calibration Point	2mm
Probe Tip to Sensor Y Calibration Point	2mm
Probe Tip to Sensor Z Calibration Point	2mm
Recommended Measurement Distance from Surface	3mm



ANNEX I: Dipole Calibration Certificate

835MHz Dipole Calibration Certificate



In Collaboration with
s p e a g
CALIBRATION LABORATORY



中国认可
国际互认
校准
CALIBRATION
CNAS L0570

Add: No.52 HuaYuanBei Road, Haidian District, Beijing, 100191, Chi
Tel: +86-10-62304633-2079 Fax: +86-10-62304633-2504
E-mail: cttl@chinattl.com http://www.chinattl.cn

Client **SAICT**

Certificate No: **Z21-60355**

CALIBRATION CERTIFICATE

Object: **D835V2 - SN: 4d057**

Calibration Procedure(s): **FF-Z11-003-01**
Calibration Procedures for dipole validation kits

Calibration date: **October 18, 2021**

This calibration Certificate documents the traceability to national standards, which realize the physical units of measurements (SI). The measurements and the uncertainties with confidence probability are given on the following pages and are part of the certificate.

All calibrations have been conducted in the closed laboratory facility: environment temperature (22±3)°C and humidity<70%.

Calibration Equipment used (M&TE critical for calibration)

Primary Standards	ID #	Cal Date (Calibrated by, Certificate No.)	Scheduled Calibration
Power Meter NRP2	106277	24-Sep-21 (CTTL, No.J21X08326)	Sep-22
Power sensor NRP8S	104291	24-Sep-21 (CTTL, No.J21X08326)	Sep-22
Reference Probe EX3DV4	SN 7517	03-Feb-21(CTTL-SPEAG.No.Z21-60001)	Feb-22
DAE4	SN 1556	15-Jan-21(SPEAG,No.DAE4-1556_Jan21)	Jan-22
Secondary Standards	ID #	Cal Date (Calibrated by, Certificate No.)	Scheduled Calibration
Signal Generator E4438C	MY49071430	01-Feb-21 (CTTL, No.J21X00593)	Jan-22
NetworkAnalyzer E5071C	MY46110673	14-Jan-21 (CTTL, No.J21X00232)	Jan-22

	Name	Function	Signature
Calibrated by:	Zhao Jing	SAR Test Engineer	
Reviewed by:	Lin Hao	SAR Test Engineer	
Approved by:	Qi Dianyuan	SAR Project Leader	

Issued: October 24, 2021

This calibration certificate shall not be reproduced except in full without written approval of the laboratory.



Add: No.52 HuaYuanBei Road, Haidian District, Beijing, 100191, China
Tel: +86-10-62304633-2079 Fax: +86-10-62304633-2504
E-mail: cttl@chinattl.com http://www.chinattl.cn

Glossary:

TSL	tissue simulating liquid
ConvF	sensitivity in TSL / NORM _{x,y,z}
N/A	not applicable or not measured

Calibration is Performed According to the Following Standards:

- IEEE Std 1528-2013, "IEEE Recommended Practice for Determining the Peak Spatial-Averaged Specific Absorption Rate (SAR) in the Human Head from Wireless Communications Devices: Measurement Techniques", June 2013
- IEC 62209-1, "Measurement procedure for assessment of specific absorption rate of human exposure to radio frequency fields from hand-held and body-mounted wireless communication devices- Part 1: Device used next to the ear (Frequency range of 300MHz to 6GHz)", July 2016
- IEC 62209-2, "Procedure to measure the Specific Absorption Rate (SAR) For wireless communication devices used in close proximity to the human body (frequency range of 30MHz to 6GHz)", March 2010
- KDB865664, SAR Measurement Requirements for 100 MHz to 6 GHz

Additional Documentation:

- DASY4/5 System Handbook

Methods Applied and Interpretation of Parameters:

- Measurement Conditions:* Further details are available from the Validation Report at the end of the certificate. All figures stated in the certificate are valid at the frequency indicated.
- Antenna Parameters with TSL:* The dipole is mounted with the spacer to position its feed point exactly below the center marking of the flat phantom section, with the arms oriented parallel to the body axis.
- Feed Point Impedance and Return Loss:* These parameters are measured with the dipole positioned under the liquid filled phantom. The impedance stated is transformed from the measurement at the SMA connector to the feed point. The Return Loss ensures low reflected power. No uncertainty required.
- Electrical Delay:* One-way delay between the SMA connector and the antenna feed point. No uncertainty required.
- SAR measured:* SAR measured at the stated antenna input power.
- SAR normalized:* SAR as measured, normalized to an input power of 1 W at the antenna connector.
- SAR for nominal TSL parameters:* The measured TSL parameters are used to calculate the nominal SAR result.

The reported uncertainty of measurement is stated as the standard uncertainty of Measurement multiplied by the coverage factor $k=2$, which for a normal distribution Corresponds to a coverage probability of approximately 95%.



Add: No.52 HuaYuanBei Road, Haidian District, Beijing, 100191, China
 Tel: +86-10-62304633-2079 Fax: +86-10-62304633-2504
 E-mail: cttl@chinattl.com http://www.chinattl.cn

Measurement Conditions

DASY system configuration, as far as not given on page 1.

DASY Version	DASY52	V52.10.4
Extrapolation	Advanced Extrapolation	
Phantom	Triple Flat Phantom 5.1C	
Distance Dipole Center - TSL	15 mm	with Spacer
Zoom Scan Resolution	dx, dy, dz = 5 mm	
Frequency	835 MHz ± 1 MHz	

Head TSL parameters

The following parameters and calculations were applied.

	Temperature	Permittivity	Conductivity
Nominal Head TSL parameters	22.0 °C	41.5	0.90 mho/m
Measured Head TSL parameters	(22.0 ± 0.2) °C	40.9 ± 6 %	0.89 mho/m ± 6 %
Head TSL temperature change during test	<1.0 °C	---	----

SAR result with Head TSL

SAR averaged over 1 cm ³ (1 g) of Head TSL	Condition	
SAR measured	250 mW input power	2.39 W/kg
SAR for nominal Head TSL parameters	normalized to 1W	9.64 W/kg ± 18.8 % (k=2)
SAR averaged over 10 cm ³ (10 g) of Head TSL	Condition	
SAR measured	250 mW input power	1.56 W/kg
SAR for nominal Head TSL parameters	normalized to 1W	6.29 W/kg ± 18.7 % (k=2)



Add: No.52 HuaYuanBei Road, Haidian District, Beijing, 100191, China
Tel: +86-10-62304633-2079 Fax: +86-10-62304633-2504
E-mail: cttl@chinattl.com http://www.chinattl.cn

Appendix (Additional assessments outside the scope of CNAS L0570)

Antenna Parameters with Head TSL

Impedance, transformed to feed point	49.8 Ω - 4.19j Ω
Return Loss	- 27.5dB

General Antenna Parameters and Design

Electrical Delay (one direction)	1.301 ns
----------------------------------	----------

After long term use with 100W radiated power, only a slight warming of the dipole near the feedpoint can be measured.

The dipole is made of standard semirigid coaxial cable. The center conductor of the feeding line is directly connected to the second arm of the dipole. The antenna is therefore short-circuited for DC-signals. On some of the dipoles, small end caps are added to the dipole arms in order to improve matching when loaded according to the position as explained in the "Measurement Conditions" paragraph. The SAR data are not affected by this change. The overall dipole length is still according to the Standard. No excessive force must be applied to the dipole arms, because they might bend or the soldered connections near the feedpoint may be damaged.

Additional EUT Data

Manufactured by	SPEAG
-----------------	-------



Add: No.52 HuaYuanBei Road, Haidian District, Beijing, 100191, China
 Tel: +86-10-62304633-2079 Fax: +86-10-62304633-2504
 E-mail: cttl@chinattl.com http://www.chinattl.cn

DASY5 Validation Report for Head TSL

Date: 10.18.2021

Test Laboratory: CTTL, Beijing, China

DUT: Dipole 835 MHz; Type: D835V2; Serial: D835V2 - SN: 4d057

Communication System: UID 0, CW; Frequency: 835 MHz; Duty Cycle: 1:1

Medium parameters used: $f = 835$ MHz; $\sigma = 0.886$ S/m; $\epsilon_r = 40.9$; $\rho = 1000$ kg/m³

Phantom section: Right Section

DASY5 Configuration:

- Probe: EX3DV4 - SN7517; ConvF(9.81, 9.81, 9.81) @ 835 MHz; Calibrated: 2021-02-03
- Sensor-Surface: 1.4mm (Mechanical Surface Detection)
- Electronics: DAE4 Sn1556; Calibrated: 2021-01-15
- Phantom: MFP_V5.1C (20deg probe tilt); Type: QD 000 P51 Cx; Serial: 1062
- Measurement SW: DASY52, Version 52.10 (4); SEMCAD X Version 14.6.14 (7501)

Dipole Calibration/Zoom Scan (7x7x7) (7x7x7)/Cube 0: Measurement grid: dx=5mm, dy=5mm, dz=5mm

Reference Value = 58.86 V/m; Power Drift = 0.00 dB

Peak SAR (extrapolated) = 3.68 W/kg

SAR(1 g) = 2.39 W/kg; SAR(10 g) = 1.56 W/kg

Smallest distance from peaks to all points 3 dB below = 18 mm

Ratio of SAR at M2 to SAR at M1 = 64.9%

Maximum value of SAR (measured) = 3.23 W/kg

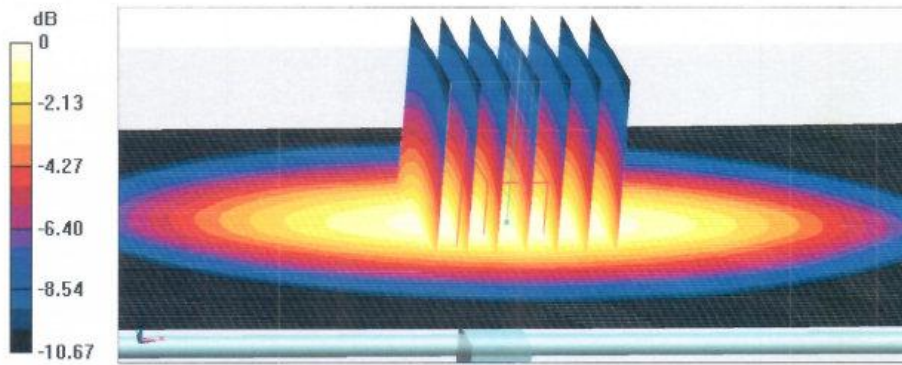

0 dB = 3.23 W/kg = 5.09 dBW/kg



Add: No.52 HuaYuanBei Road, Haidian District, Beijing, 100191, China
Tel: +86-10-62304633-2079 Fax: +86-10-62304633-2504
E-mail: cttl@chinattl.com http://www.chinattl.cn

Impedance Measurement Plot for Head TSL

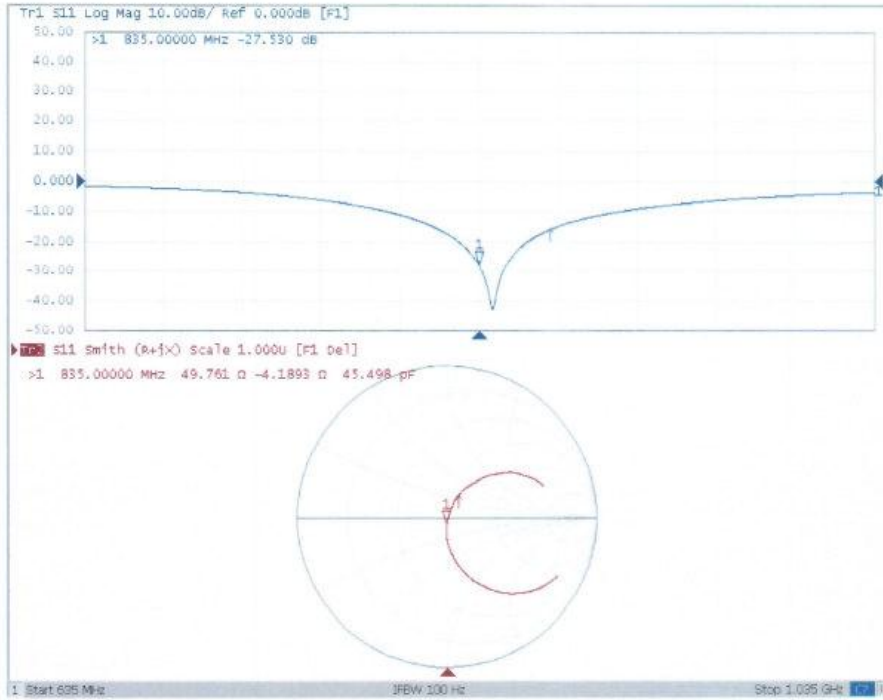



1750MHz Dipole Calibration Certificate



In Collaboration with
s p e a g
CALIBRATION LABORATORY



中国认可
国际互认
校准
CALIBRATION
CNAS L0570

Add: No.51 Xueyuan Road, Haidian District, Beijing, 100191, China
Tel: +86-10-62304633-2079 Fax: +86-10-62304633-2504
E-mail: cttl@chinattl.com http://www.chinattl.cn

Client **CTTL(South Branch)**

Certificate No: **Z19-60292**

CALIBRATION CERTIFICATE

Object: **D1750V2 - SN: 1152**

Calibration Procedure(s): **FF-Z11-003-01**
Calibration Procedures for dipole validation kits

Calibration date: **August 30, 2019**

This calibration Certificate documents the traceability to national standards, which realize the physical units of measurements(SI). The measurements and the uncertainties with confidence probability are given on the following pages and are part of the certificate.

All calibrations have been conducted in the closed laboratory facility: environment temperature(22±3)°C and humidity<70%.

Calibration Equipment used (M&TE critical for calibration)

Primary Standards	ID #	Cal Date(Calibrated by, Certificate No.)	Scheduled Calibration
Power Meter NRP2	106276	11-Apr-19 (CTTL, No.J19X02605)	Apr-20
Power sensor NRP6A	101369	11-Apr-19 (CTTL, No.J19X02605)	Apr-20
Reference Probe EX3DV4	SN 3617	31-Jan-19(SPEAG,No.EX3-3617_Jan19)	Jan-20
DAE4	SN 1555	22-Aug-19(CTTL-SPEAG,No.Z19-60295)	Aug-20
Secondary Standards	ID #	Cal Date(Calibrated by, Certificate No.)	Scheduled Calibration
Signal Generator E4438C	MY49071430	23-Jan-19 (CTTL, No.J19X00336)	Jan-20
NetworkAnalyzer E5071C	MY46110673	24-Jan-19 (CTTL, No.J19X00547)	Jan-20

	Name	Function	Signature
Calibrated by:	Zhao Jing	SAR Test Engineer	
Reviewed by:	Lin Hao	SAR Test Engineer	
Approved by:	Qi Dianyuan	SAR Project Leader	

Issued: September 2, 2019

This calibration certificate shall not be reproduced except in full without written approval of the laboratory.