

Product specification

Quick Reference Date

	Antenna module on the system board	
Frequenc Range	2400 ~ 2500MHz	
Ant. Port Input Pwr. (dBm)	0 (Typ. BT class 2 output power)	
Tot. Rad. Pwr. (dBm)	-1.2 (Input pwr – loss pwr)	
Peak EIRP(dBm)	1.9	
Directivity (dBi)	1 (all direction antenna)	
Efficiency (dB)	6 0.2 %	
Gain (dBi)	1.2 (Avg Gain XY-plane)	
Maximum Power (dBm)	1.7 (XY-plane)	
Minimum Power (dBm)	-4(XY-plane)	
Avg. Power (dBm)	-0.5(XY-plane)	
Input Impendence(ohm)	50	
Polarization Type	V ertical & Horizontal	
V . S .W .R	< 1.4	

All the technical data and information contained herein are subject to change without prior notice

Antenna Layout & module on the system board

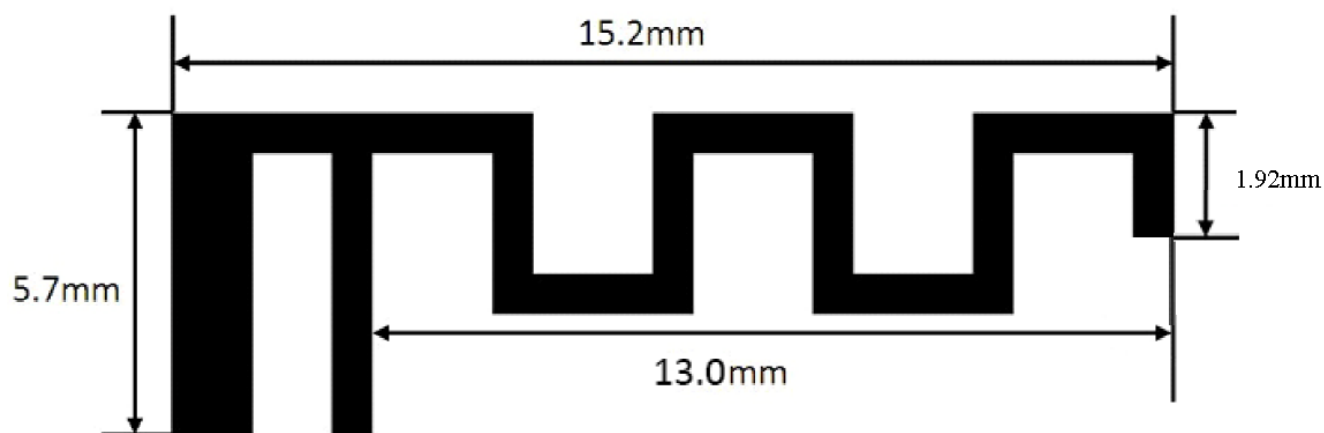

Antenna Gain

Gain Table

Unit in dBi @2.44GHz	XY-plane		XZ-plane		YZ-plane		Efficiency
	Peak	Avg.	Peak	Avg.	Peak	Avg.	
Module Board	1.2	-0.5	1.9	-3.6	1.1	-3.0	6 0.2 %

Return Loss

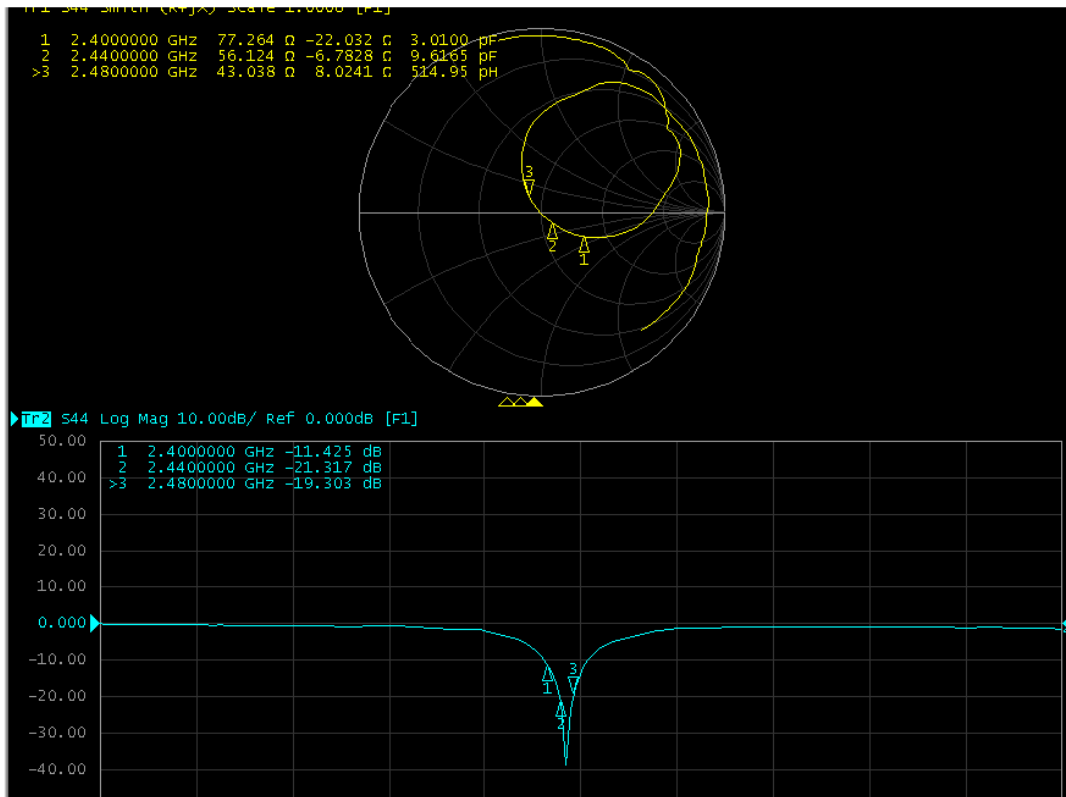

The Environment of Antenna Radiation Pattern

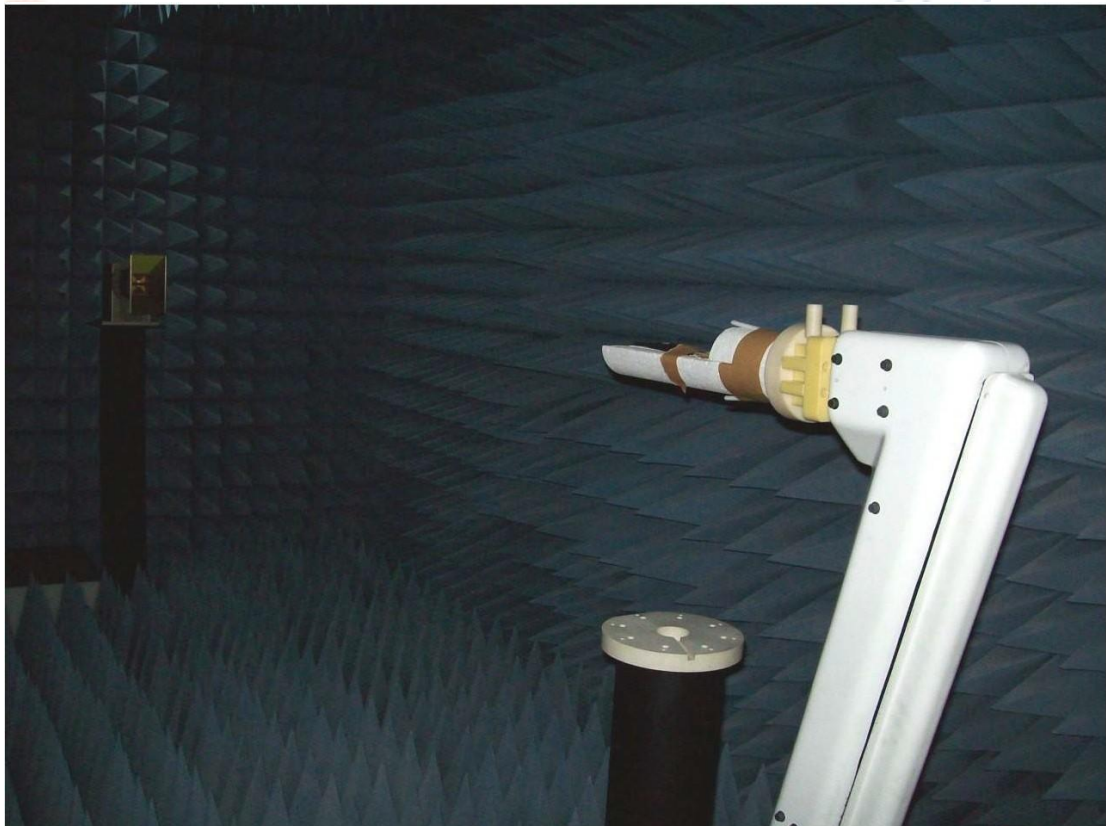
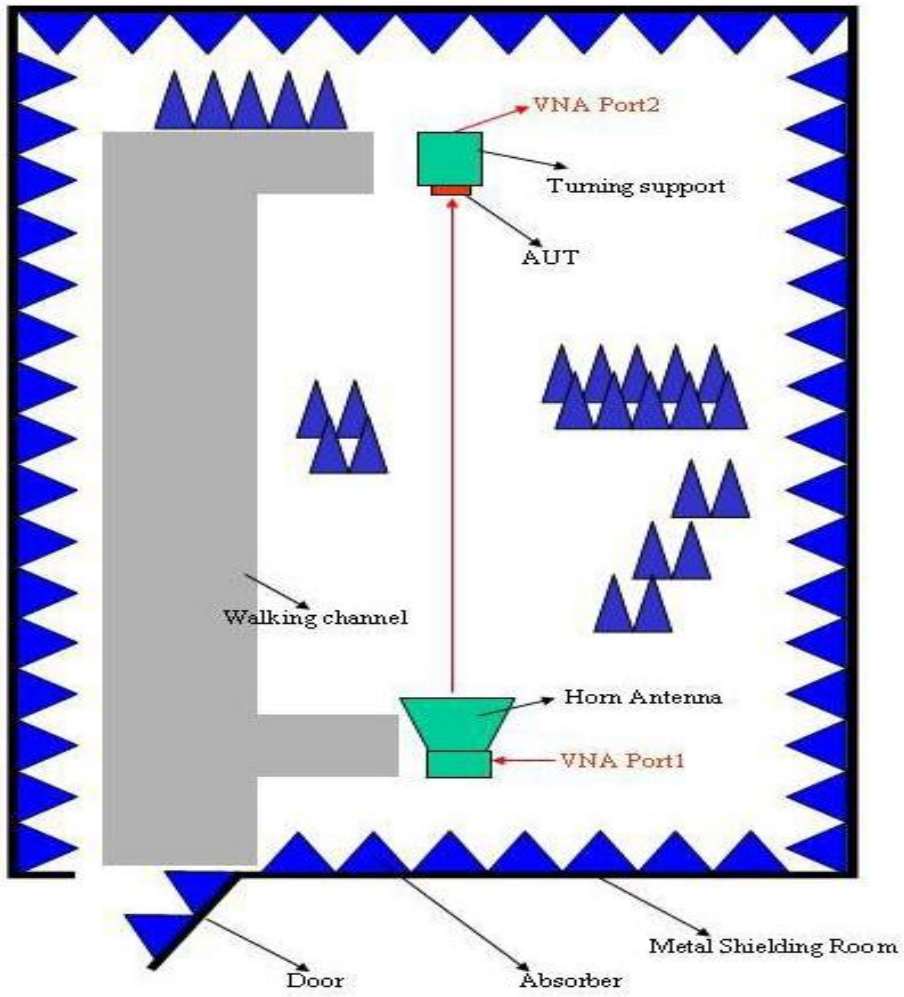

3D radiation pattern diagram

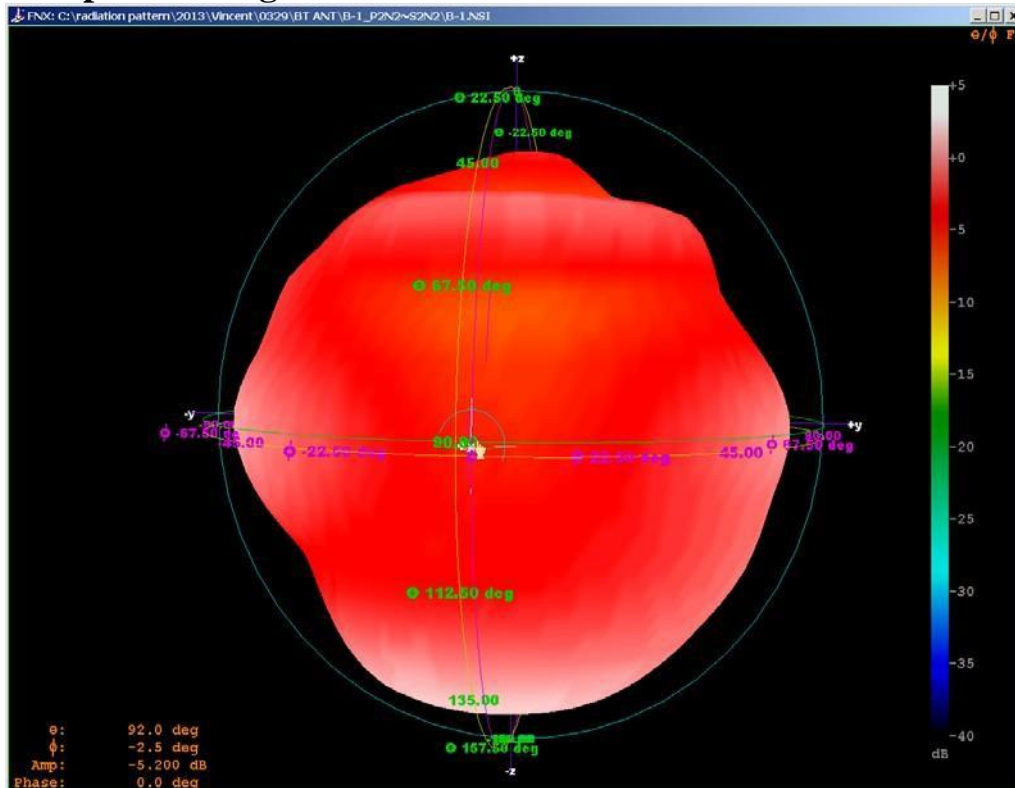

XY-plane

Far-field Power Distribution(H+V) on X-Y Plane
Plot Peak Gain(H+V)= 1.35 dB; Plot AvgGain(H+V)= -0.48dB @2.44000 GHz

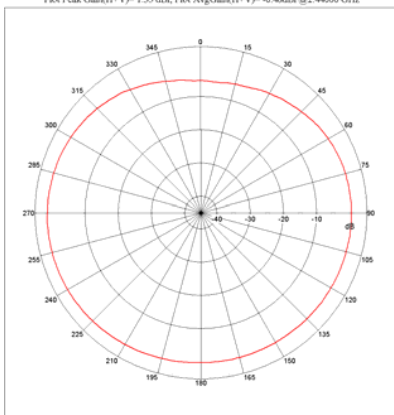

XZ-plane

Far-field Power Distribution(H+V) on X-Z Plane
Plot Peak Gain(H+V)= 1.68 dB; Plot AvgGain(H+V)= -3.83dB @2.44000 GHz

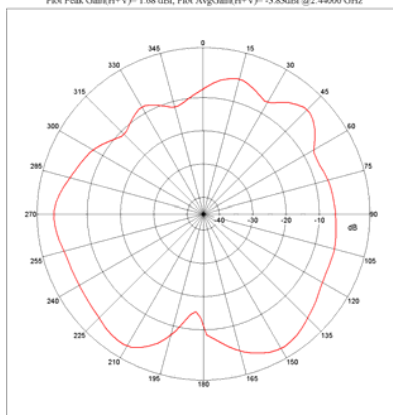

YZ-plane

Far-field Power Distribution(H+V) on Y-Z Plane
Plot Peak Gain(H+V)= 1.11 dB; Plot AvgGain(H+V)= -2.99dB @2.44000 GHz

