

TEST REPORT

Product Name : **Wireless Router**
Model Number : **RAX1810**
FCC ID : **2A7EI-RAX1810**

Prepared for : HUIZHOU MTN WEIYE TECHNOLOGY DEVELOPMENT CO.,LTD.
Address : NO.2 Huitai Road,Huinan High-tech Industrial Park,Huiao Avenue,Huizhou City,Guangdong Province,China

Prepared by : EMTEK (SHENZHEN) CO., LTD.
Address : Building 69, Majialong Industry Zone, Nanshan District, Shenzhen, Guangdong, China

Tel: (0755) 26954280
Fax: (0755) 26954282

Report Number : ENS2203310266W00202R
Date(s) of Tests : March 31, 2022 to April 25, 2022
Date of issue : April 27, 2022

1 TEST RESULT CERTIFICATION

Applicant : HUIZHOU MTN WEIYE TECHNOLOGY DEVELOPMENT CO.,LTD.
 Address : NO.2 Huitai Road,Huinan High-tech Industrial Park,Huiao Avenue,Huizhou City,Guangdong Province,China
 Manufacturer : HUIZHOU MTN WEIYE TECHNOLOGY DEVELOPMENT CO.,LTD.
 Address : NO.2 Huitai Road,Huinan High-tech Industrial Park,Huiao Avenue,Huizhou City,Guangdong Province,China
 EUT : Wireless Router
 Model Name : RAX1810
 Trademark : MTN

Measurement Procedure Used:

APPLICABLE STANDARDS	
STANDARD	TEST RESULT
FCC 47 CFR Part 2, Subpart J FCC 47 CFR Part 15, Subpart E	PASS

The above equipment was tested by EMTEK (SHENZHEN) CO., LTD. The test data, data evaluation, test procedures, and equipment configurations shown in this report were made in accordance with the procedures given in ANSI C63.10 (2013) and the energy emitted by the sample EUT tested as described in this report is in compliance with the requirements of FCC Rules Part 2 and Part 15.407

The test results of this report relate only to the tested sample identified in this report.

Date of Test : March 31, 2022 to April 25, 2022

Prepared by : Una Yu
 Una Yu /Editor

Reviewer : Joe Xia
 Joe Xia /Supervisor

Approve & Authorized Signer : Lisa Wang
 Lisa Wang/Manager



Modified History

Version	Report No.	Revision Date	Summary
V1.0	ENS2203310266W00202R	/	Original Report



TABLE OF CONTENTS

1 TEST RESULT CERTIFICATION	2
2 EUT TECHNICAL DESCRIPTION	5
3 SUMMARY OF TEST RESULT	7
4 TEST METHODOLOGY	8
4.1 GENERAL DESCRIPTION OF APPLIED STANDARDS	8
4.2 MEASUREMENT EQUIPMENT USED	8
4.3 DESCRIPTION OF TEST MODES	10
5 FACILITIES AND ACCREDITATIONS	12
5.1 FACILITIES	12
5.2 EQUIPMENT	12
5.3 LABORATORY ACCREDITATIONS AND LISTINGS	12
6 TEST SYSTEM UNCERTAINTY	13
7 SETUP OF EQUIPMENT UNDER TEST	14
7.1 RADIO FREQUENCY TEST SETUP	14
7.2 RADIO FREQUENCY TEST SETUP	14
7.3 CONDUCTED EMISSION TEST SETUP	15
7.4 BLOCK DIAGRAM CONFIGURATION OF TEST SYSTEM	16
7.5 SUPPORT EQUIPMENT	16
8 TEST REQUIREMENTS	17
8.1 BANDWIDTH MEASUREMENT	17
8.2 MAXIMUM CONDUCTED OUTPUT POWER	124
8.3 MAXIMUM PEAK POWER DENSITY	129
8.4 FREQUENCY STABILITY	174
8.5 UNDESIRABLE RADIATED SPURIOUS EMISSION	189
8.6 POWER LINE CONDUCTED EMISSIONS	208
8.7 ANTENNA APPLICATION	211

2 EUT TECHNICAL DESCRIPTION

Characteristics	Description
Product:	Wireless Router
Model Number:	RAX1810
Sample Number:	2#
Wifi Type:	<input checked="" type="checkbox"/> Wifi 5G with 5150MHz-5250MHz Band <input checked="" type="checkbox"/> Wifi 5G with 5725MHz-5850MHz Band
WLAN Supported:	<input checked="" type="checkbox"/> 802.11a <input checked="" type="checkbox"/> 802.11n(20MHz channel bandwidth) <input checked="" type="checkbox"/> 802.11n(40MHz channel bandwidth) <input checked="" type="checkbox"/> 802.11ac(20MHz channel bandwidth) <input checked="" type="checkbox"/> 802.11ac(40MHz channel bandwidth) <input checked="" type="checkbox"/> 802.11ac(80MHz channel bandwidth) <input checked="" type="checkbox"/> 802.11ax(20MHz channel bandwidth) <input checked="" type="checkbox"/> 802.11ax(40MHz channel bandwidth) <input checked="" type="checkbox"/> 802.11ax(80MHz channel bandwidth)
Data Rate :	<input checked="" type="checkbox"/> 802.11a:54/48/36/24/18/12/9/6Mbps <input checked="" type="checkbox"/> 802.11n:up to 300 Mbps <input checked="" type="checkbox"/> 802.11ac:up to 867 Mbps <input checked="" type="checkbox"/> 802.11ax:up to 1201 Mbps
Modulation:	<input checked="" type="checkbox"/> OFDM with BPSK/QPSK/16QAM/64QAM for 802.11a/n <input checked="" type="checkbox"/> OFDM with BPSK/QPSK/16QAM/64QAM/256QAM for 802.11ac <input checked="" type="checkbox"/> OFDMA with 1024QAM for 802.11AX HE
Frequency Range:	<input checked="" type="checkbox"/> UNII-1: 5150MHz-5250MHz Band
	<input checked="" type="checkbox"/> 5180-5240MHz for 802.11a; <input checked="" type="checkbox"/> 5180-5240MHz for 802.11n(HT20); <input checked="" type="checkbox"/> 5180-5240MHz for 802.11ac(HT20);
	<input checked="" type="checkbox"/> 5190-5230MHz for 802.11n(HT40); <input checked="" type="checkbox"/> 5190-5230MHz for 802.11ac(HT40); <input checked="" type="checkbox"/> 5210MHz for 802.11ac(HT80);
	<input checked="" type="checkbox"/> UNII-3 with 5725MHz-5850MHz Band
	<input checked="" type="checkbox"/> 5745-5825MHz for 802.11a; <input checked="" type="checkbox"/> 5745-5825MHz for 802.11n(HT20); <input checked="" type="checkbox"/> 5745-5825MHz for 802.11ac(HT20);
	<input checked="" type="checkbox"/> 5755-5795MHz for 802.11n(HT40); <input checked="" type="checkbox"/> 5755-5795MHz for 802.11ac(HT40); <input checked="" type="checkbox"/> 5775MHz for 802.11ac(HT80);
TPC Function:	<input type="checkbox"/> Applicable <input checked="" type="checkbox"/> Not Applicable
Antenna Port:	<input checked="" type="checkbox"/> Antenna port 1 <input checked="" type="checkbox"/> Antenna port 2
Antenna Type:	External Antenna
Antenna Gain:	5 dBi
Transmit Power:	5150MHz-5250MHz: 12.33 dBm 5745MHz-5825MHz: 13.1 dBm

Power Supply :	AC 100-240V~50/60Hz
Date of Received:	March 31, 2022
Temperature Range:	-5°C ~ +40°C

Note: For more details, please refer to the User's manual of the EUT.



3 SUMMARY OF TEST RESULT

FCC Part Clause	Test Parameter	Verdict	Remark
15.407 (a) 15.407 (e)	99% , 6dB and 26dB Bandwidth	PASS	
15.407 (a)	Maximum Conducted Output Power	PASS	
15.407 (a)	Peak Power Spectral Density	PASS	
15.407 (b)	Radiated Spurious Emission	PASS	
15.407(g)	Frequency Stability	PASS	
15.407 (b)(6) 15.207	Power Line Conducted Emission	PASS	
15.407(a) 15.203	Antenna Application	PASS	
NOTE1: N/A (Not Applicable) NOTE2: According to FCC OET KDB 789033 D2 General UNII Test Procedures New Rules v02r01, In addition, the radiated test is also performed to ensure the emissions emanating from the device cabinet also comply with the applicable limits.			

RELATED SUBMITTAL(S) / GRANT(S):

This submittal(s) (test report) is intended for FCC ID: 2A7EI-RAX1810 filing to comply with Section 15.247 of the FCC Part 15, Subpart C Rules.

4 TEST METHODOLOGY

4.1 GENERAL DESCRIPTION OF APPLIED STANDARDS

According to its specifications, the EUT must comply with the requirements of the following standards:

FCC 47 CFR Part 2, Subpart J

FCC 47 CFR Part 15, Subpart E

FCC KDB 662911 D01 Multiple Transmitter Output v02r01

FCC KDB 789033 D2 General UNII Test Procedures New Rules v02r01

4.2 MEASUREMENT EQUIPMENT USED

Conducted Emission Test Equipment

Equipment	Manufacturer	Model No.	Serial No.	Last Cal.	Cal. Interval
Test Receiver	Rohde & Schwarz	ESCI	101384	May 15, 2021	1 Year
L.I.S.N.	Rohde & Schwarz	ENV216	5	May 15, 2021	1 Year
L.I.S.N.	Kyoritsu	KNW-407	8-1492-9	May 16, 2021	1 Year
Absorbing Clamp	Rohde & Schwarz	MDS-21	833711/025	June 15, 2021	1 Year
Loop antenna	Laplace	RF300	8006	May 15, 2021	1 Year
Van der Hoofden test-head	Schwarzbeck	VDHH 9502	9502-054	May 15, 2021	1 Year
Pulse Limiter	Rohde & Schwarz	ESH3-Z2	100107	May 15, 2021	1 Year

For Spurious Emissions Test

Equipment	Manufacturer	Model No.	Serial No.	Last Cal.	Cal. Interval
EMI Test Receiver	Rohde & Schwarz	ESU 26	100154	May 15, 2021	1 Year
Pre-Amplifie	Lunar EM	LNA30M3G-25	J10100000070	May 15, 2021	1 Year
Bilog Antenna	Schwarzbeck	VULB9163	659	Aug. 22, 2021	2 Year
Horn antenna	Schwarzbeck	BBHA9120D	9120D-1177	July 4, 2020	2 Year
Pre-Amplifie	SKET	LNPA_0118G-45	SK2019051801	May 15, 2021	1 Year
Loop Antenna	Schwarzbeck	FMZB1519	1519-012	June 12, 2021	2 Year
Spectrum Analyzer	Rohde & Schwarz	FSV40	100967	May 15, 2021	1 Year
Horn antenna	Schwarzbeck	BBHA9120D	9120D-1198	July 4 2020	2 Year
Bilog Antenna	Schwarzbeck	VULB9163	660	June 12, 2021	2 Year
Cable	H+B	NmSm-05-C15052	N/A	May 15, 2021	1 Year
Cable	H+B	NmSm-2-C15201	N/A	May 15, 2021	1 Year
Cable	H+B	NmNm-7-C15702	N/A	May 15, 2021	1 Year
Cable	H+B	SAC-40G-1	414	May 15, 2021	1 Year
Cable	H+B	SUCOFLEX104	MY14871/4	May 15, 2021	
Cable	H+B	BLU18A-NmSm-6500	D8501	May 15, 2021	1 Year
Band reject Filter(50dB)	WI/DE	WRCGV-2400(2400-2485MHz)	2	May 15, 2021	1 Year

For other test items:

Equipment	Manufacturer	Model No.	Serial No.	Last Cal.	Cal. Interval
Vector Signal Generator	Agilent	N5182B	My53050553	May 15, 2021	1 Year
Analog Signal Generator	Agilent	N5171B	My53050878	May 15, 2021	1 Year
Signal Analyzer	Agilent	N9010A	My53470879	May 15, 2021	1 Year
Power Analyzer	Agilent	PS-X10-200	N/A	May 15, 2021	1 Year
Wideband Radio Communication Tester	R&S	CMW500	1201.0002K50-140822zk	May 15, 2021	1 Year
Test Accessories	Agilent	PS-X10-100	N/A	May 15, 2021	1 Year
Temperature&Humidity test chamber	ESPEC	EL-02KA	12107166	July 03, 2021	1 Year
Blocking Box	Agilent	AD211	N/A	May 15, 2021	1 Year

Remark: Each piece of equipment is scheduled for calibration once a year.



4.3 DESCRIPTION OF TEST MODES

The EUT has been tested under its typical operating condition.

The EUT configuration for testing is installed on RF field strength measurement to meet the Commissions requirement and operating in a manner which intends to maximize its emission characteristics in a continuous normal application.

The Transmitter was operated in the normal operating mode. The TX frequency was fixed which was for the purpose of the measurements.

Test of channel included the lowest and middle and highest frequency to perform the test, then record on this report.

Pre-defined engineering program for regulatory testing used to control the EUT for staying in continuous transmitting and receiving mode is programmed.

Wifi 5G with U-NII - 1

Frequency and Channel list for 802.11a, 802.11n (HT20), 802.11ac (HT20), 802.11ax (20MHz):

Channel	Frequency (MHz)	Channel	Frequency (MHz)	Channel	Frequency (MHz)
36	5180	44	5220		
40	5200	48	5240		

Frequency and Channel list for 802.11n (HT40), 802.11ac (HT40), 802.11 ax (40MHz):

Channel	Frequency (MHz)	Channel	Frequency (MHz)	Channel	Frequency (MHz)
38	5190	46	5230		

Frequency and Channel list for 802.11ac (HT80), 802.11 ax (80MHz):

Channel	Frequency (MHz)	Channel	Frequency (MHz)	Channel	Frequency (MHz)
42	5210				

Test Frequency and Channel for 802.11a, 802.11n (HT20), 802.11ac (HT20), 802.11 ax (20MHz):

Lowest Frequency		Middle Frequency		Highest Frequency	
Channel	Frequency (MHz)	Channel	Frequency (MHz)	Channel	Frequency (MHz)
36	5180	40	5200	48	5240

Test Frequency and channel for 802.11n (HT40), 802.11ac (HT40), 802.11 ax (40MHz):

Lowest Frequency		Middle Frequency		Highest Frequency	
Channel	Frequency (MHz)	Channel	Frequency (MHz)	Channel	Frequency (MHz)
38	5190	N/A	N/A	46	5230

Test Frequency and channel for 802.11ac (HT80), 802.11 ax (80MHz):

Lowest Frequency		Middle Frequency		Highest Frequency	
Channel	Frequency (MHz)	Channel	Frequency (MHz)	Channel	Frequency (MHz)
42	5210	N/A	N/A	N/A	N/A

Wifi 5G with U-NII -3

Frequency and Channel list for 802.11a, 802.11n (HT20), 802.11ac (HT20), 802.11 ax (20MHz):

Channel	Frequency (MHz)	Channel	Frequency (MHz)	Channel	Frequency (MHz)
149	5745	157	5785	165	5825
153	5765	161	5805		

Frequency and Channel list for 802.11n (HT40), 802.11ac (HT40), 802.11 ax (40MHz):

Channel	Frequency (MHz)	Channel	Frequency (MHz)	Channel	Frequency (MHz)
151	5755	159	5795		

Frequency and Channel list for 802.11ac (HT80), 802.11 ax (80MHz):

Channel	Frequency (MHz)	Channel	Frequency (MHz)	Channel	Frequency (MHz)
155	5775				

Test Frequency and Channel for 802.11a, 802.11n (HT20), 802.11ac (HT20), 802.11 ax (20MHz):

Lowest Frequency		Middle Frequency		Highest Frequency	
Channel	Frequency (MHz)	Channel	Frequency (MHz)	Channel	Frequency (MHz)
149	5745	157	5785	165	5825

Test Frequency and channel for 802.11n (HT40), 802.11ac (HT40), 802.11 ax (40 MHz)

Lowest Frequency		Middle Frequency		Highest Frequency	
Channel	Frequency (MHz)	Channel	Frequency (MHz)	Channel	Frequency (MHz)
151	5755	N/A	N/A	159	5795

Test Frequency and channel for 802.11ac (HT80), 802.11 ax (80MHz)

Lowest Frequency		Middle Frequency		Highest Frequency	
Channel	Frequency (MHz)	Channel	Frequency (MHz)	Channel	Frequency (MHz)
155	5775				

The 5G WIFI has two antennas and support Multiple Outputs for 802.11n/ac/ax mode for this report; Antenna 1 Gain is 5.0dBi; Antenna 2 Gain is 5.0dBi; for this function is belong to Correlated Categorization equipment

According to KDB 662911, for identical antenna gains,

$$\text{Directional gain} = 10 \log (2) + 5.0\text{dBi}=8.0 \text{ dBi}$$

5 FACILITIES AND ACCREDITATIONS

5.1 FACILITIES

All measurement facilities used to collect the measurement data are located at:

EMTEK (Shenzhen) Co., Ltd.

Building 69, Majialong Industry Zone District, Nanshan District, Shenzhen, China

The sites are constructed in conformance with the requirements of ANSI C63.7, ANSI C63.4 and CISPR Publication 22.

5.2 EQUIPMENT

Radiated emissions are measured with one or more of the following types of linearly polarized antennas: tuned dipole, biconical, log periodic, bi-log, and/or ridged waveguide, horn. Spectrum analyzers with preselectors and quasi-peak detectors are used to perform radiated measurements.

Conducted emissions are measured with Line Impedance Stabilization Networks and EMI Test Receivers.

Calibrated wideband preamplifiers, coaxial cables, and coaxial attenuators are also used for making measurements.

All receiving equipment conforms to CISPR Publication 16-1, "Radio Interference Measuring Apparatus and Measurement Methods."

5.3 LABORATORY ACCREDITATIONS AND LISTINGS

Site Description

EMC Lab.	<p>: Accredited by CNAS The Certificate Registration Number is L2291. The Laboratory has been assessed and proved to be in compliance with CNAS-CL01 (identical to ISO/IEC 17025:2017)</p> <p>Accredited by FCC Designation Number: CN1204 Test Firm Registration Number: 882943</p> <p>Accredited by A2LA The Certificate Number is 4321.01.</p> <p>Accredited by Industry Canada The Conformity Assessment Body Identifier is CN0008</p>
Name of Firm	: EMTEK (SHENZHEN) CO., LTD.
Site Location	: Building 69, Majialong Industry Zone, Nanshan District, Shenzhen, Guangdong, China

6 TEST SYSTEM UNCERTAINTY

The following measurement uncertainty levels have been estimated for tests performed on the apparatus:

Parameter	Uncertainty
Radio Frequency	$\pm 1 \times 10^{-5}$
Maximum Peak Output Power Test	$\pm 1.0\text{dB}$
Conducted Emissions Test	$\pm 2.0\text{dB}$
Radiated Emission Test	$\pm 2.0\text{dB}$
Power Density	$\pm 2.0\text{dB}$
Occupied Bandwidth Test	$\pm 1.0\text{dB}$
Band Edge Test	$\pm 3\text{dB}$
All emission, radiated	$\pm 3\text{dB}$
Antenna Port Emission	$\pm 3\text{dB}$
Temperature	$\pm 0.5^\circ\text{C}$
Humidity	$\pm 3\%$

Measurement Uncertainty for a level of Confidence of 95%

7 SETUP OF EQUIPMENT UNDER TEST

7.1 RADIO FREQUENCY TEST SETUP

The WLAN component's antenna ports(s) of the EUT are connected to the measurement instrument per an appropriate attenuator. The EUT is controlled by PC/software to emit the specified signals for the purpose of measurements.

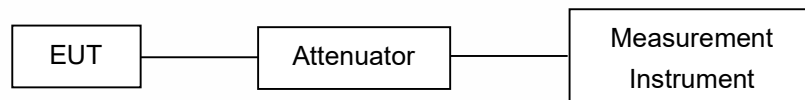

7.2 RADIO FREQUENCY TEST SETUP

The test site semi-anechoic chamber has met the requirement of NSA tolerance 4 dB according to the standards: ANSI C63.10. The test distance is 3m. The setup is according to the requirements in Section 13.1.4.1 of ANSI C63.10-2013 and CAN/CSA-CEI/IEC CISPR 22.

Above 30MHz:

The EUT is placed on a plane 0.1 meters above the ground in the chamber, 3 meter away from the antenna. The maximal emission value is acquired by adjusting the antenna height, polarisation and turntable azimuth. Normally, the height range of antenna is 1 m to 4 m, the azimuth range of turntable is 0° to 360°, and the receive antenna has two polarizations Vertical (V) and Horizontal (H).

Above 1GHz:

(Note: the FCC's permission to use 1.5m as an alternative per TCBC Conf call of Dec. 2, 2014.)

The EUT is placed on a plane 0.1 meters above the ground in the chamber, 3 meter away from the antenna. The maximal emission value is acquired by adjusting the antenna height, polarisation and turntable azimuth. Normally, the height range of antenna is 1 m to 4 m, the azimuth range of turntable is 0° to 360°, and the receive antenna has two polarizations Vertical (V) and Horizontal (H).

(a) Radiated Emission Test Set-Up, Frequency Below 1000MHz

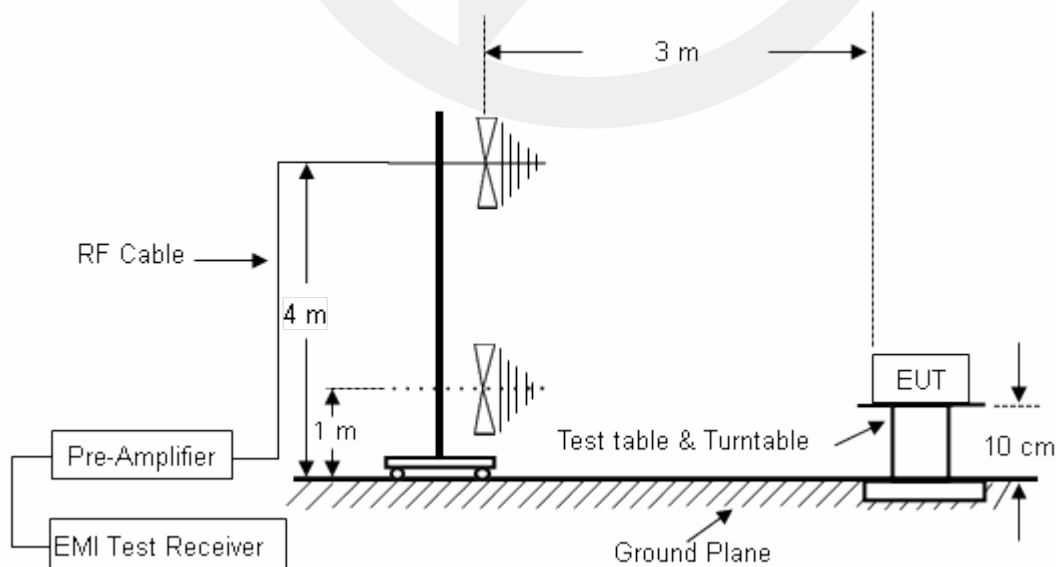

(b) Radiated Emission Test Set-Up, Frequency above 1000MHz

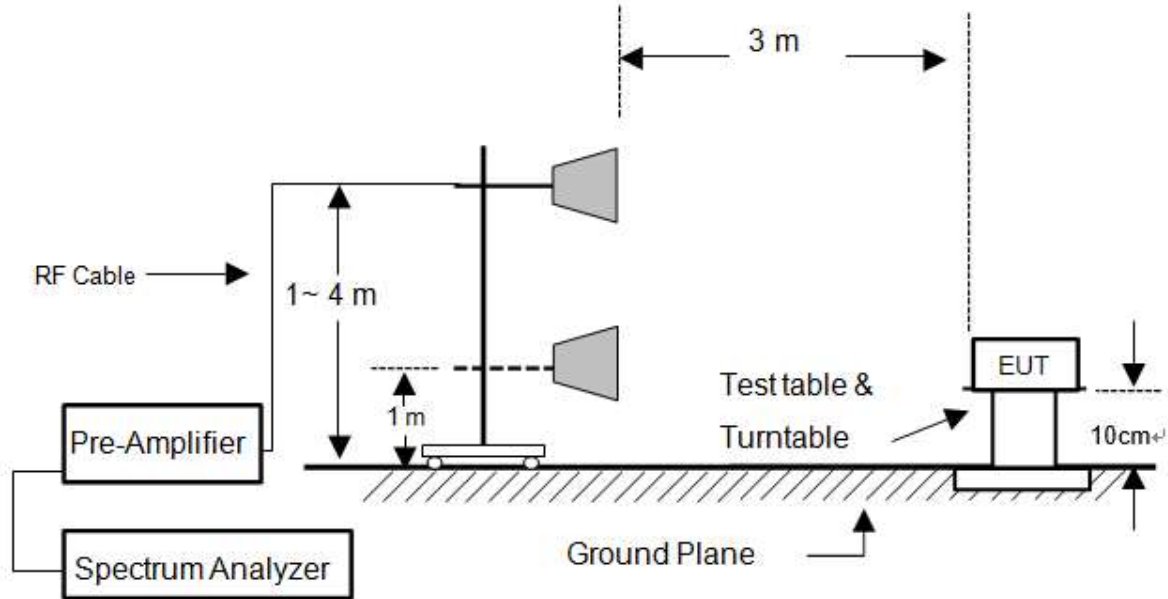

7.3 CONDUCTED EMISSION TEST SETUP

The mains cable of the EUT (maybe per AC/DC Adapter) must be connected to LISN. The LISN shall be placed 0.8 m from the boundary of EUT and bonded to a ground reference plane for LISN mounted on top of the ground reference plane. This distance is between the closest points of the LISN and the EUT. All other units of the EUT and associated equipment shall be at least 0.8m from the LISN.

Ground connections, where required for safety purposes, shall be connected to the reference ground point of the LISN and, where not otherwise provided or specified by the manufacturer, shall be of same length as the mains cable and run parallel to the mains connection at a separation distance of not more than 0.1 m.

According to the requirements in Section 13.1.4.1 of ANSI C63.10-2013 Conducted emissions from the EUT measured in the frequency range between 0.15 MHz and 30 MHz using CISPR Quasi-Peak and average detector mode.

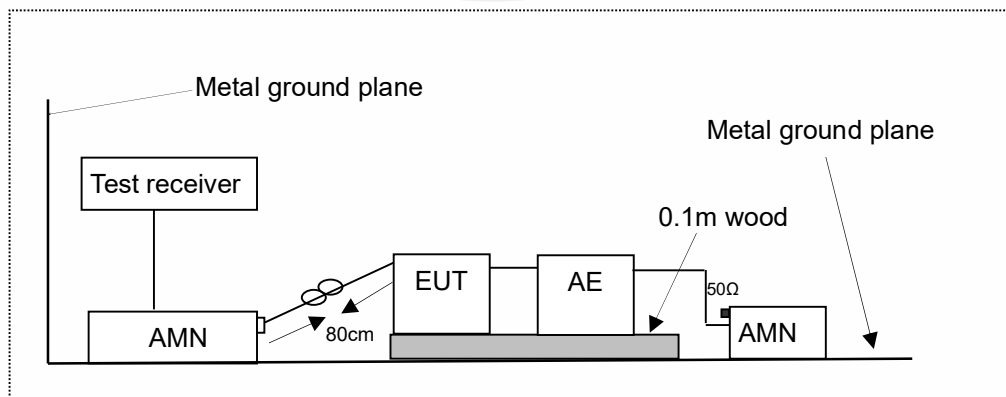

7.4 BLOCK DIAGRAM CONFIGURATION OF TEST SYSTEM

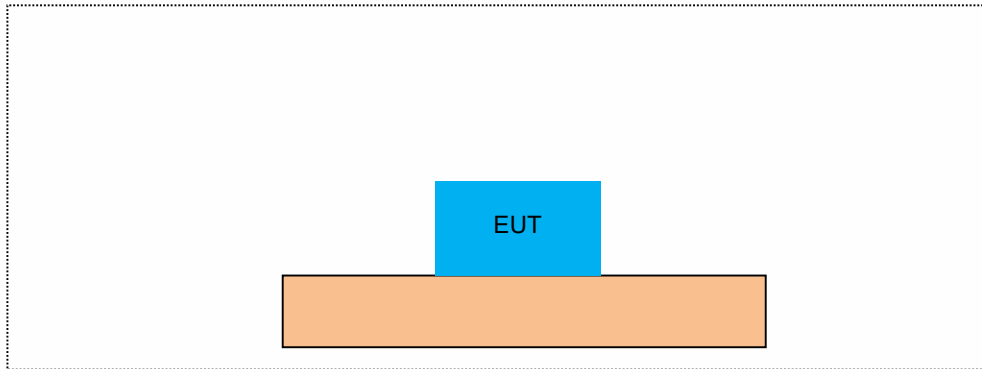

7.5 SUPPORT EQUIPMENT

EUT Cable List and Details			
Cable Description	Length (m)	Shielded/Unshielded	With / Without Ferrite
/	/	/	/

Auxiliary Cable List and Details			
Cable Description	Length (m)	Shielded/Unshielded	With / Without Ferrite
/	/	/	/

Auxiliary Equipment List and Details			
Description	Manufacturer	Model	Serial Number
Notebook	acer	ZR1	LXTECOCO76643158 372500

Notes:

- 1.All the equipment/cables were placed in the worst-case configuration to maximize the emission during the test.
- 2.Grounding was established in accordance with the manufacturer’s requirements and conditions for the intended use.

8 TEST REQUIREMENTS

8.1 BANDWIDTH MEASUREMENT

8.1.1 Applicable Standard

According to FCC Part 15.407(a)(1) for UNII Band I
According to FCC Part 15.407(a)(2) for UNII Band II-A and UNII Band II-C
According to FCC Part 15.407(a)(3) for UNII Band III
According to FCC Part 15.407(e) for UNII Band III
According to 789033 D02 Section II(C)
According to 789033 D02 Section II(D)

8.1.2 Conformance Limit

(1) For the band 5.15-5.25 GHz.

(iv) For mobile and portable client devices in the 5.15-5.25 GHz band, the maximum conducted output power over the frequency band of operation shall not exceed 250 mW provided the maximum antenna gain does not exceed 6 dBi. In addition, the maximum power spectral density shall not exceed 11 dBm in any 1 megahertz band. If transmitting antennas of directional gain greater than 6 dBi are used, both the maximum conducted output power and the maximum power spectral density shall be reduced by the amount in dB that the directional gain of the antenna exceeds 6 dBi.

(2) For the 5.25-5.35 GHz and 5.47-5.725 GHz bands, the maximum conducted output power over the frequency bands of operation shall not exceed the lesser of 250 mW or $11 \text{ dBm} + 10 \log B$, where B is the 26 dB emission bandwidth in megahertz. In addition, the maximum power spectral density shall not exceed 11 dBm in any 1 megahertz band. If transmitting antennas of directional gain greater than 6 dBi are used, both the maximum conducted output power and the maximum power spectral density shall be reduced by the amount in dB that the directional gain of the antenna exceeds 6 dBi.

(3) For the band 5.725-5.85 GHz, the maximum conducted output power over the frequency band of operation shall not exceed 1 W. In addition, the maximum power spectral density shall not exceed 30 dBm in any 500-kHz band. If transmitting antennas of directional gain greater than 6 dBi are used, both the maximum conducted output power and the maximum power spectral density shall be reduced by the amount in dB that the directional gain of the antenna exceeds 6 dBi. However, fixed point-to-point U-NII devices operating in this band may employ transmitting antennas with directional gain greater than 6 dBi without any corresponding reduction in transmitter conducted power. Fixed, point-to-point operations exclude the use of point-to-multipoint systems, omnidirectional applications, and multiple collocated transmitters transmitting the same information. The operator of the U-NII device, or if the equipment is professionally installed, the installer, is responsible for ensuring that systems employing high gain directional antennas are used exclusively for fixed, point-to-point operations.

(e) Within the 5.725-5.85 GHz band, the minimum 6 dB bandwidth of U-NII devices shall be at least 500 kHz.

8.1.3 Test Configuration

Test according to clause 7.1 radio frequency test setup

8.1.4 Test Procedure

According to 789033 D02 v02r01 section C&D, the following is the measurement procedure.

1. Emission Bandwidth (EBW)

- a) Set RBW = approximately 1% of the emission bandwidth.
- b) Set the VBW > RBW.
- c) Detector = Peak.
- d) Trace mode = max hold.
- e) Measure the maximum width of the emission that is 26 dB down from the maximum of the emission.

Compare this with the RBW setting of the analyzer. Readjust RBW and repeat measurement as needed until the RBW/EBW ratio is approximately 1%.

2. Minimum Emission Bandwidth for the band 5.725-5.85 GHz

Section 15.407(e) specifies the minimum 6 dB emission bandwidth of at least 500 KHz for the band 5.715-5.85 GHz. The following procedure shall be used for measuring this bandwidth:

- a) Set RBW = 100 kHz.
- b) Set the video bandwidth (VBW) $\geq 3 \times$ RBW.
- c) Detector = Peak.
- d) Trace mode = max hold.
- e) Sweep = auto couple.
- f) Allow the trace to stabilize.
- g) Measure the maximum width of the emission that is constrained by the frequencies associated with the two outermost amplitude points (upper and lower frequencies) that are attenuated by 6 dB relative to the maximum level measured in the fundamental emission.

Note: The automatic bandwidth measurement capability of a spectrum analyzer or EMI receiver may be employed if it implements the functionality described above.

D. 99 Percent Occupied Bandwidth

The 99-percent occupied bandwidth is the frequency bandwidth such that, below its lower and above its upper frequency limits, the mean powers are each equal to 0.5 % of the total mean power of the given emission. Measurement of the 99-percent occupied bandwidth is required only as a condition for using the optional band-edge measurement techniques described in section II.G.3.d). Measurements of 99-percent occupied bandwidth may also optionally be used in lieu of the EBW to 789033 D02 v01r02 General UNII Test Procedures New Rules v01 define the minimum frequency range over which the spectrum is integrated when measuring maximum conducted output power as described in section II.E. However, the EBW must be measured to determine bandwidth dependent limits on maximum conducted output power in accordance with 15.407(a).

The following procedure shall be used for measuring (99 %) power bandwidth:

1. Set center frequency to the nominal EUT channel center frequency.
2. Set span = 1.5 times to 5.0 times the OBW.
3. Set RBW = 1 % to 5 % of the OBW
4. Set VBW $\geq 3 \cdot$ RBW
5. Video averaging is not permitted. Where practical, a sample detection and single sweep mode shall be used. Otherwise, peak detection and max hold mode (until the trace stabilizes) shall be used.
6. Use the 99 % power bandwidth function of the instrument (if available).
7. If the instrument does not have a 99 % power bandwidth function, the trace data points are recovered and directly summed in power units. The recovered amplitude data points, beginning at the lowest frequency, are placed in a running sum until 0.5 % of the total is reached; that frequency is recorded as the lower frequency. The process is repeated until 99.5 % of the total is reached; that frequency is recorded as the upper frequency. The 99% occupied bandwidth is the difference between these two frequencies.

8.1.5 Test Results

TestMode	Antenna	Frequency[MHz]	26db EBW [MHz]	FL[MHz]	FH[MHz]	Limit[MHz]	Verdict
11A	Ant1	5180	19.52	5170.28	5189.80	---	---
	Ant2	5180	19.44	5170.28	5189.72	---	---
	Ant1	5220	19.56	5210.24	5229.80	---	---
	Ant2	5220	19.64	5210.20	5229.84	---	---
	Ant1	5240	19.56	5230.24	5249.80	---	---
	Ant2	5240	19.60	5230.16	5249.76	---	---
	Ant1	5745	19.44	5735.28	5754.72	---	---
	Ant2	5745	19.40	5735.36	5754.76	---	---
	Ant1	5785	19.48	5775.28	5794.76	---	---
	Ant2	5785	19.52	5775.32	5794.84	---	---
	Ant1	5825	19.56	5815.24	5834.80	---	---
	Ant2	5825	19.56	5815.24	5834.80	---	---
11N20SISO	Ant1	5180	20.00	5169.96	5189.96	---	---
	Ant2	5180	19.88	5170.12	5190.00	---	---
	Ant1	5220	19.80	5210.08	5229.88	---	---
	Ant2	5220	19.96	5210.08	5230.04	---	---
	Ant1	5240	19.84	5230.08	5249.92	---	---
	Ant2	5240	19.84	5230.16	5250.00	---	---
	Ant1	5745	19.72	5735.16	5754.88	---	---
	Ant2	5745	19.64	5735.24	5754.88	---	---
	Ant1	5785	20.00	5775.08	5795.08	---	---
	Ant2	5785	19.88	5775.08	5794.96	---	---
	Ant1	5825	19.92	5815.04	5834.96	---	---
	Ant2	5825	20.04	5815.04	5835.08	---	---
11N40SISO	Ant1	5190	39.68	5170.16	5209.84	---	---
	Ant2	5190	40.08	5169.92	5210.00	---	---
	Ant1	5230	40.48	5210.00	5250.48	---	---
	Ant2	5230	40.16	5210.00	5250.16	---	---
	Ant1	5755	40.00	5735.16	5775.16	---	---
	Ant2	5755	40.24	5735.00	5775.24	---	---
	Ant1	5795	40.16	5774.92	5815.08	---	---
	Ant2	5795	40.00	5775.08	5815.08	---	---
11AC20SISO	Ant1	5180	20.12	5170.00	5190.12	---	---
	Ant2	5180	20.00	5170.04	5190.04	---	---
	Ant1	5220	20.04	5209.96	5230.00	---	---
	Ant2	5220	20.08	5210.00	5230.08	---	---
	Ant1	5240	20.04	5230.00	5250.04	---	---
	Ant2	5240	20.04	5230.00	5250.04	---	---
	Ant1	5745	19.96	5735.04	5755.00	---	---
	Ant2	5745	20.04	5735.00	5755.04	---	---
	Ant1	5785	20.08	5775.00	5795.08	---	---
	Ant2	5785	20.16	5775.00	5795.16	---	---
	Ant1	5825	20.00	5815.04	5835.04	---	---
	Ant2	5825	20.08	5815.00	5835.08	---	---
11AC40SISO	Ant1	5190	40.00	5170.08	5210.08	---	---
	Ant2	5190	40.24	5169.92	5210.16	---	---
	Ant1	5230	40.32	5209.92	5250.24	---	---
	Ant2	5230	40.32	5209.84	5250.16	---	---
	Ant1	5755	40.32	5735.00	5775.32	---	---
	Ant2	5755	40.24	5734.84	5775.08	---	---
	Ant1	5795	40.08	5775.08	5815.16	---	---

	Ant2	5795	40.48	5774.84	5815.32	---	---	
11AC80SISO	Ant1	5210	80.16	5170.00	5250.16	---	---	
	Ant2	5210	80.16	5170.00	5250.16	---	---	
	Ant1	5775	80.16	5735.00	5815.16	---	---	
	Ant2	5775	80.00	5735.16	5815.16	---	---	
	Ant1	5180	21.72	5169.08	5190.80	---	---	
11AX20SISO	Ant2	5180	21.92	5168.88	5190.80	---	---	
	Ant1	5220	21.80	5208.96	5230.76	---	---	
	Ant2	5220	21.28	5209.48	5230.76	---	---	
	Ant1	5240	19.88	5230.12	5250.00	---	---	
	Ant2	5240	19.88	5230.08	5249.96	---	---	
	Ant1	5745	22.20	5733.72	5755.92	---	---	
	Ant2	5745	21.48	5734.32	5755.80	---	---	
	Ant1	5785	21.64	5774.36	5796.00	---	---	
	Ant2	5785	21.88	5774.12	5796.00	---	---	
	Ant1	5825	22.12	5813.76	5835.88	---	---	
	Ant2	5825	22.12	5813.72	5835.84	---	---	
	11AX40SISO	Ant1	5190	39.68	5170.16	5209.84	---	---
		Ant2	5190	39.68	5170.16	5209.84	---	---
Ant1		5230	39.60	5210.24	5249.84	---	---	
Ant2		5230	39.68	5210.24	5249.92	---	---	
Ant1		5755	39.52	5735.24	5774.76	---	---	
Ant2		5755	39.68	5735.16	5774.84	---	---	
Ant1		5795	39.68	5775.24	5814.92	---	---	
Ant2		5795	39.68	5775.24	5814.92	---	---	
11AX80SISO	Ant1	5210	80.16	5170.00	5250.16	---	---	
	Ant2	5210	80.32	5169.84	5250.16	---	---	
	Ant1	5775	80.32	5735.00	5815.32	---	---	
	Ant2	5775	80.48	5735.00	5815.48	---	---	

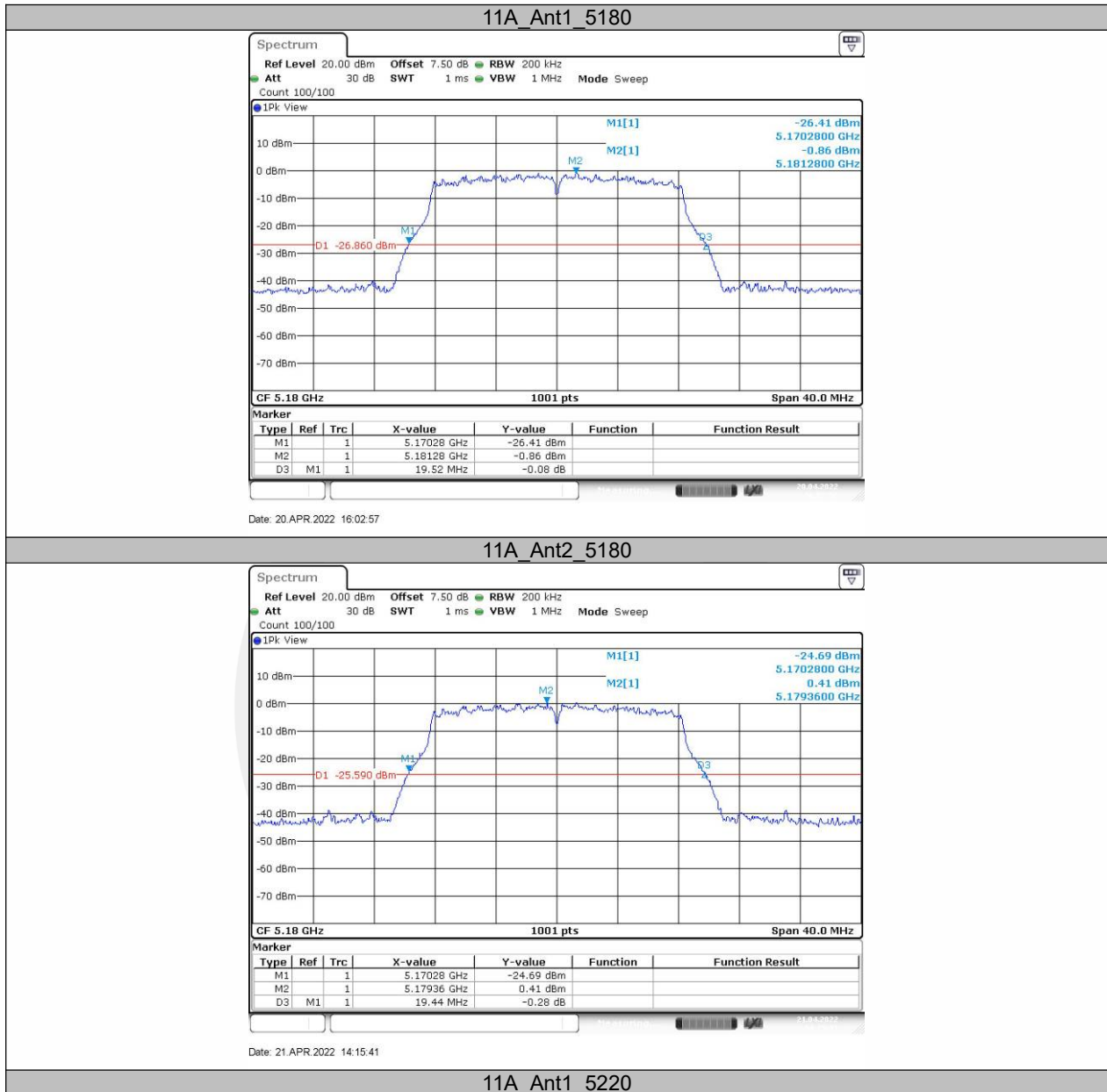

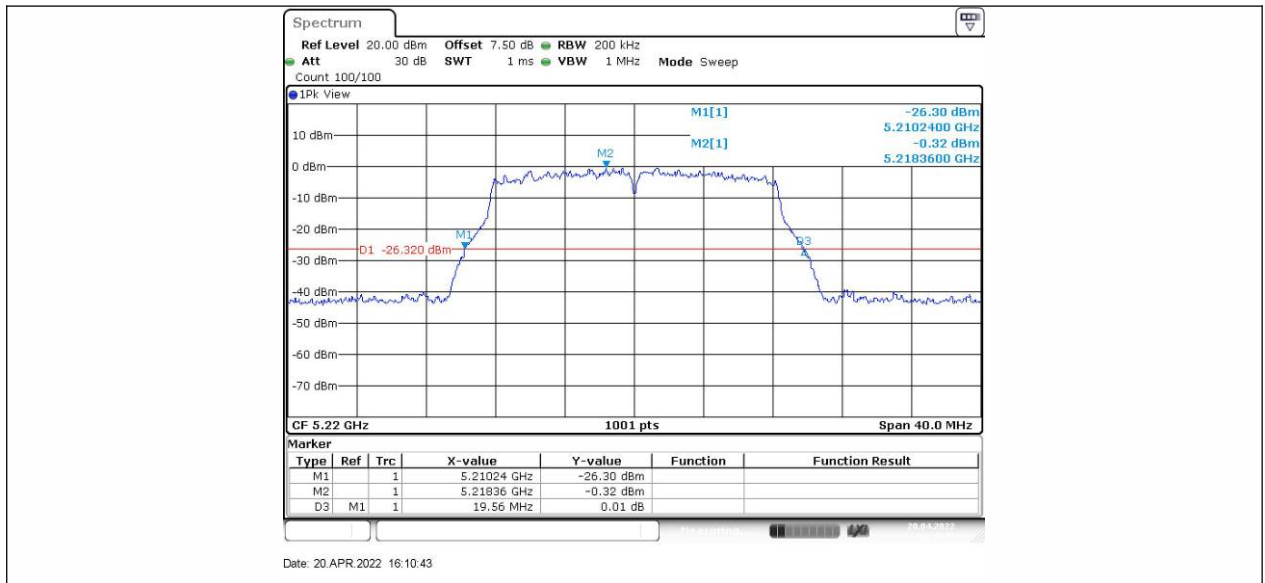

11A_Ant2_5220

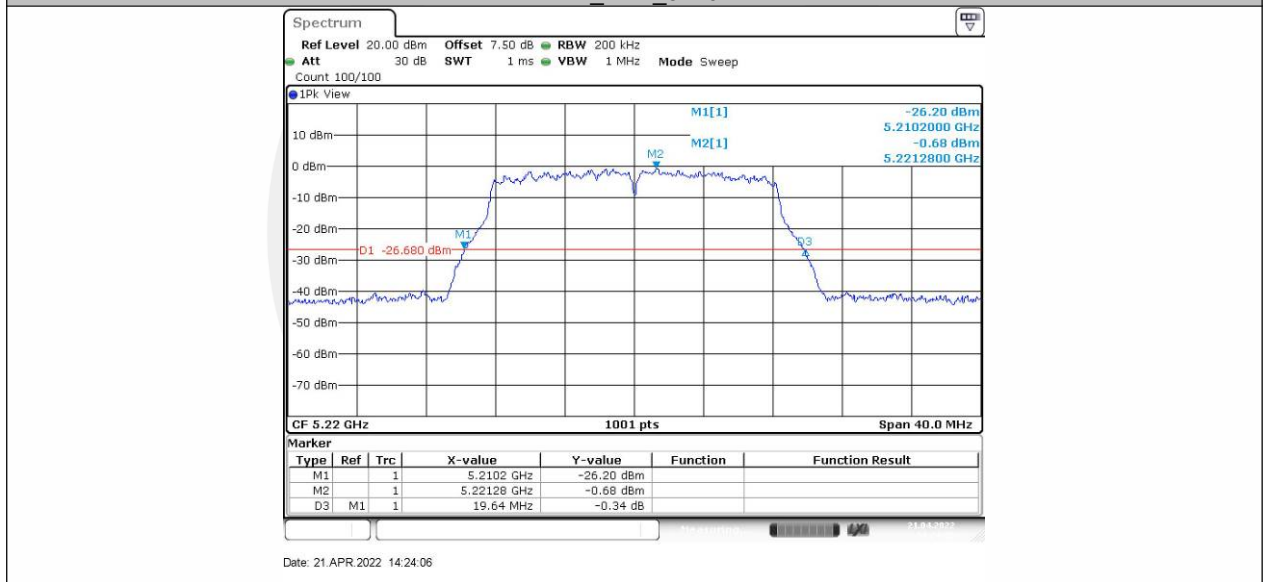

11A_Ant1_5240

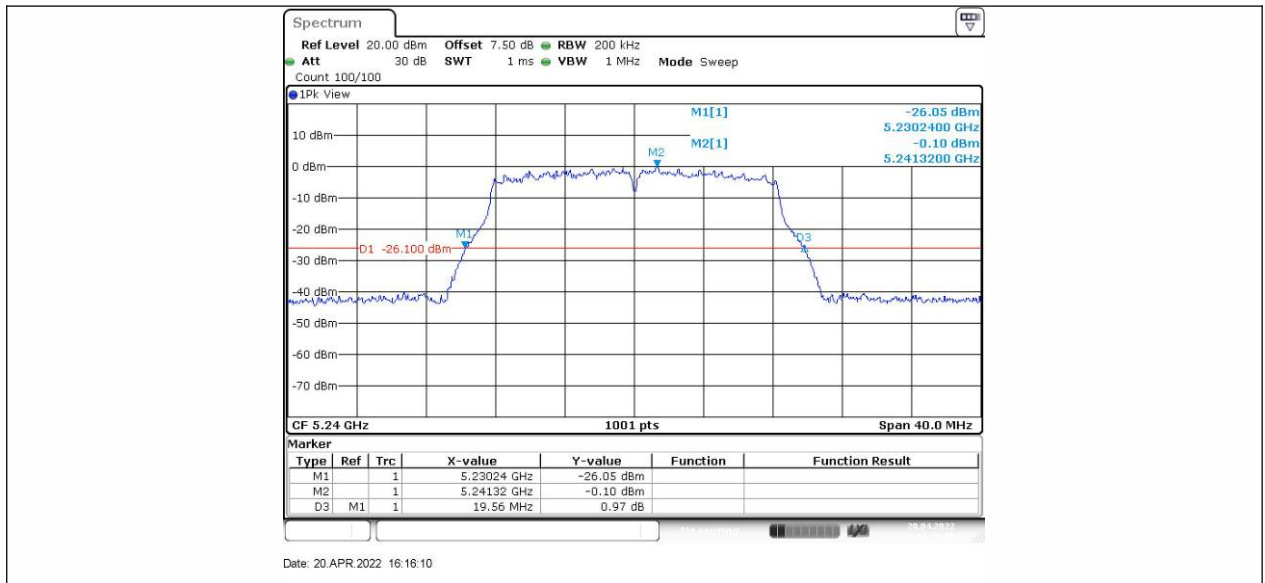

11A_Ant2_5240

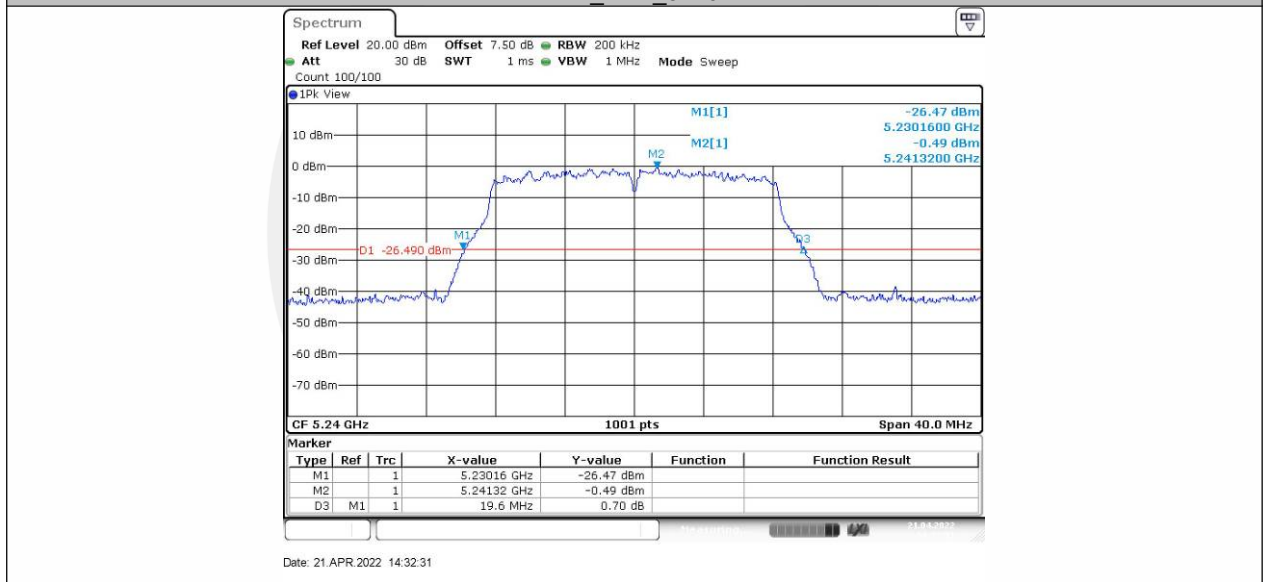

11A_Ant1_5745

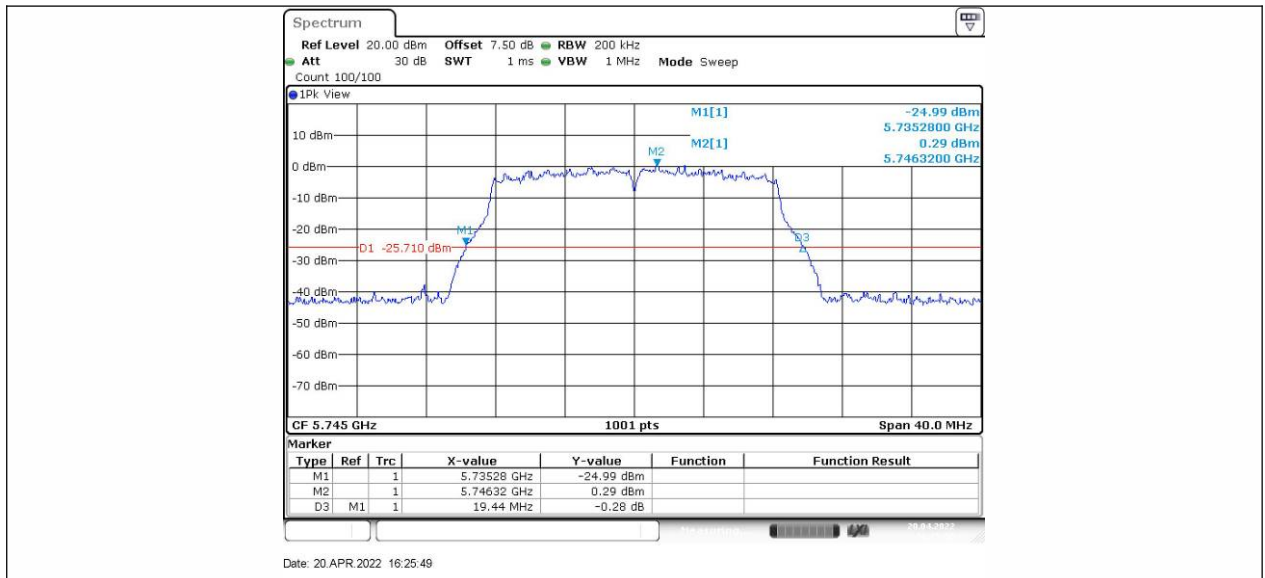

11A_Ant2_5745

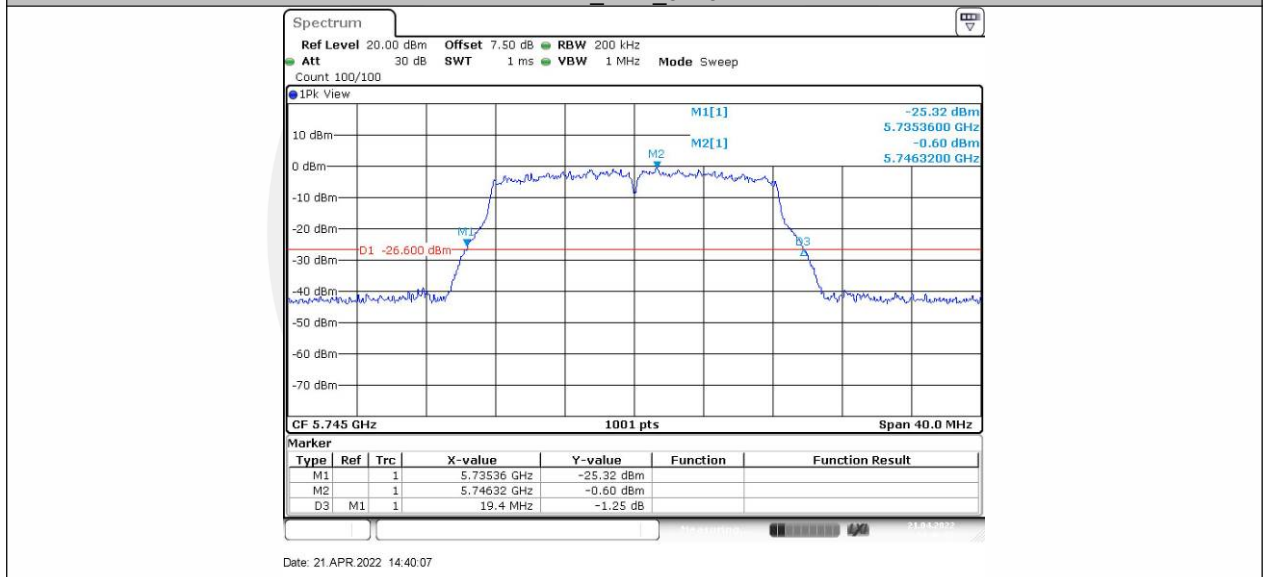

11A_Ant1_5785

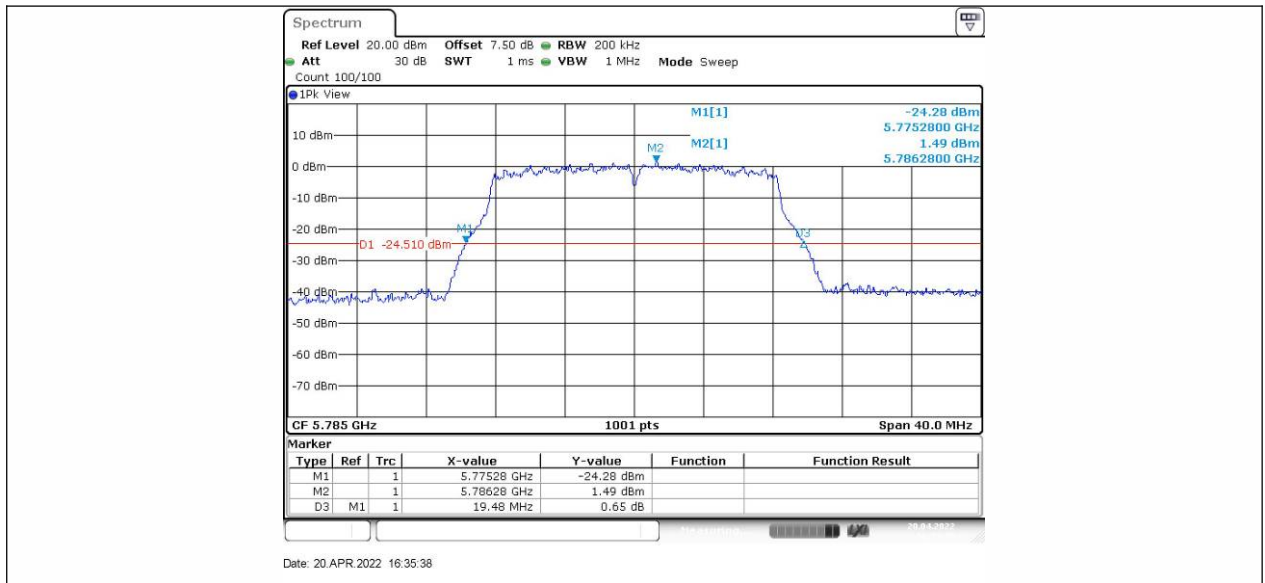

11A_Ant2_5785

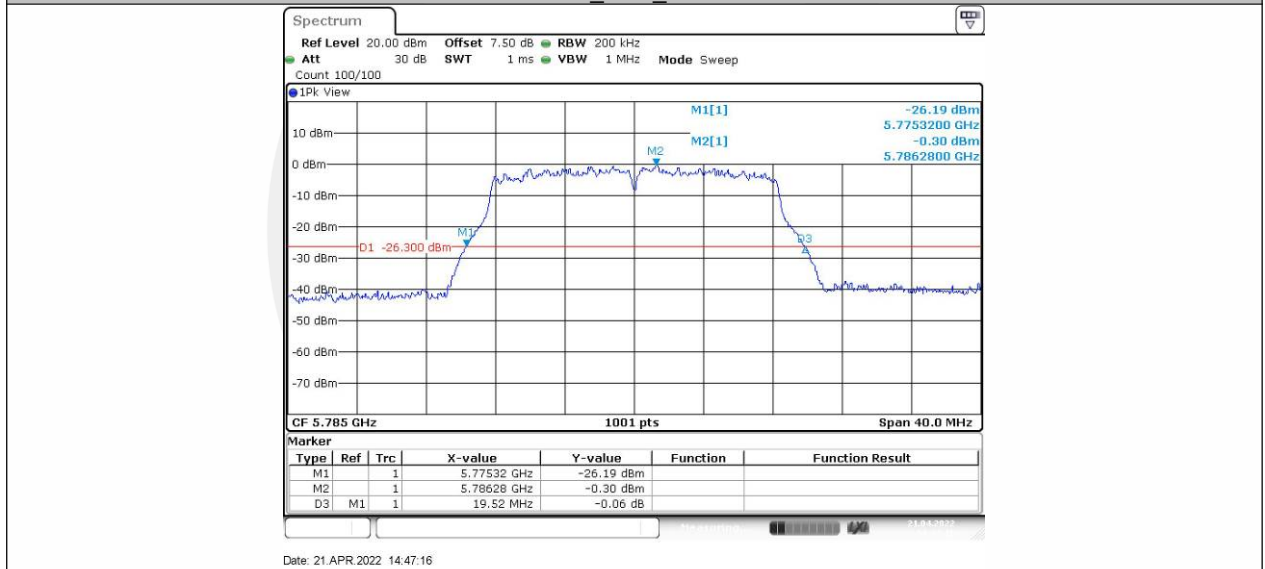

11A_Ant1_5825

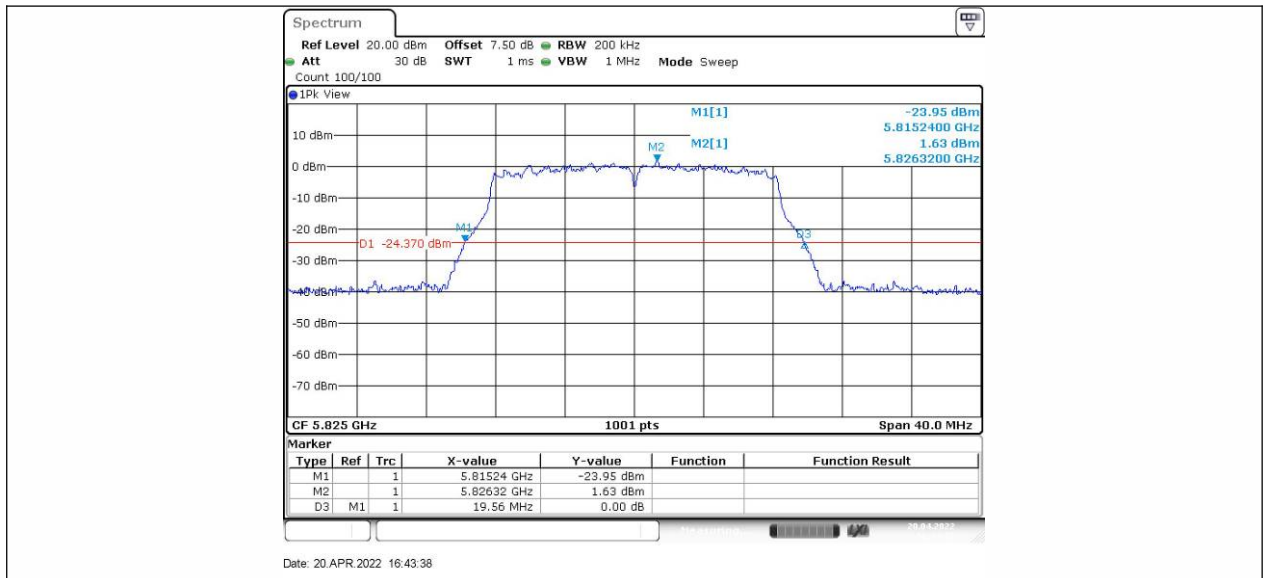

11A_Ant2_5825

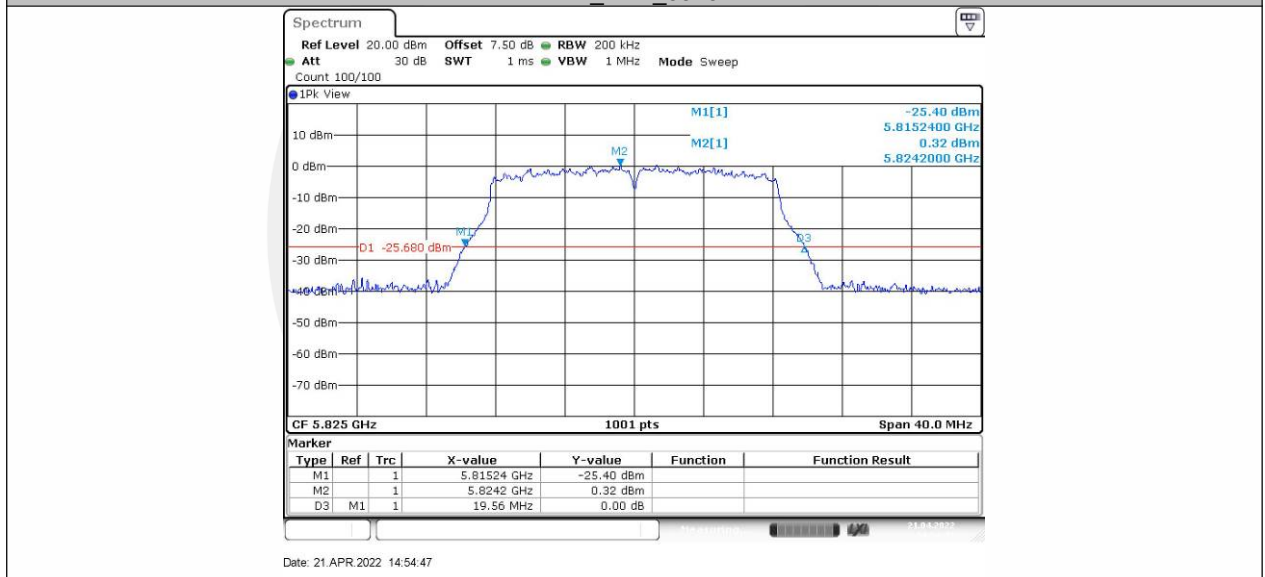

11N20SISO_Ant1_5180

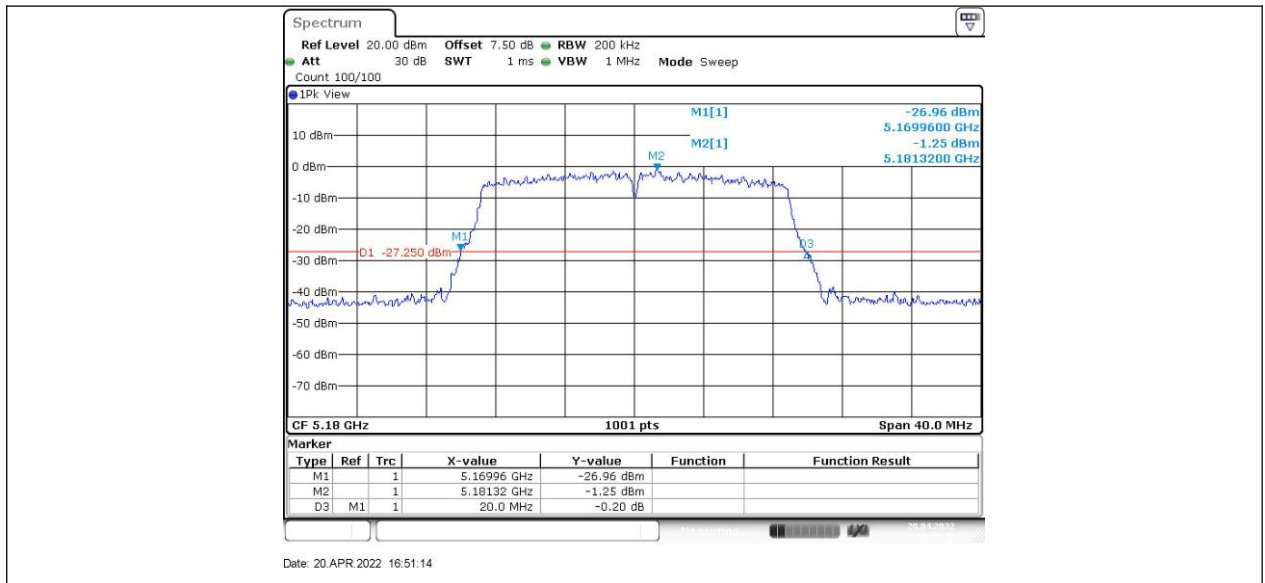

11N20SISO_Ant2_5180

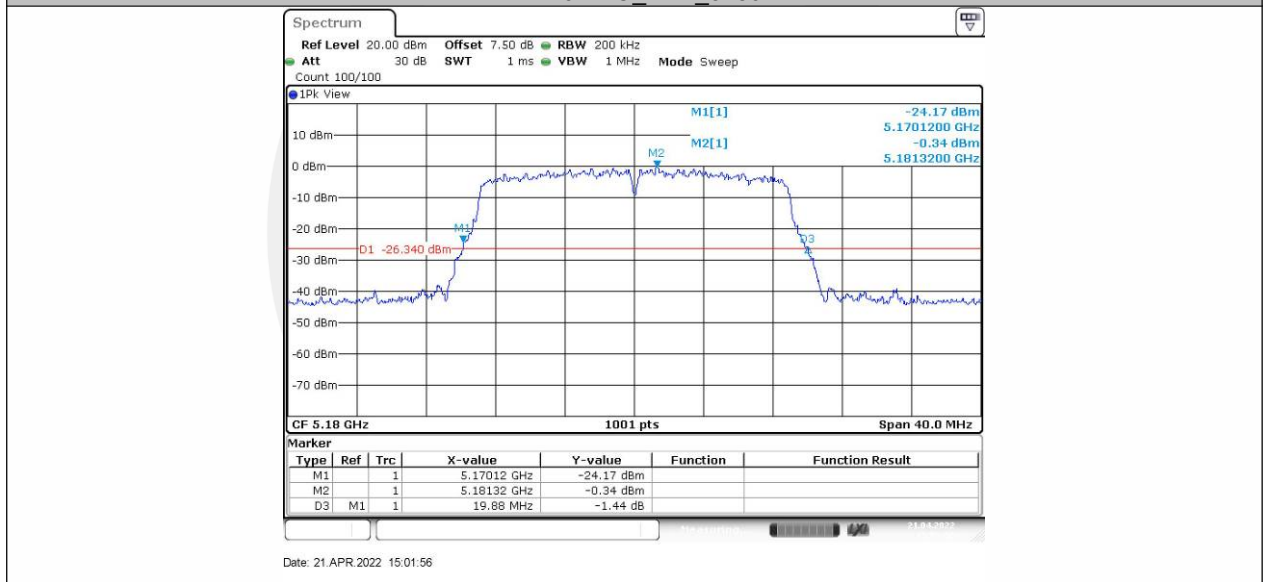

11N20SISO_Ant1_5220

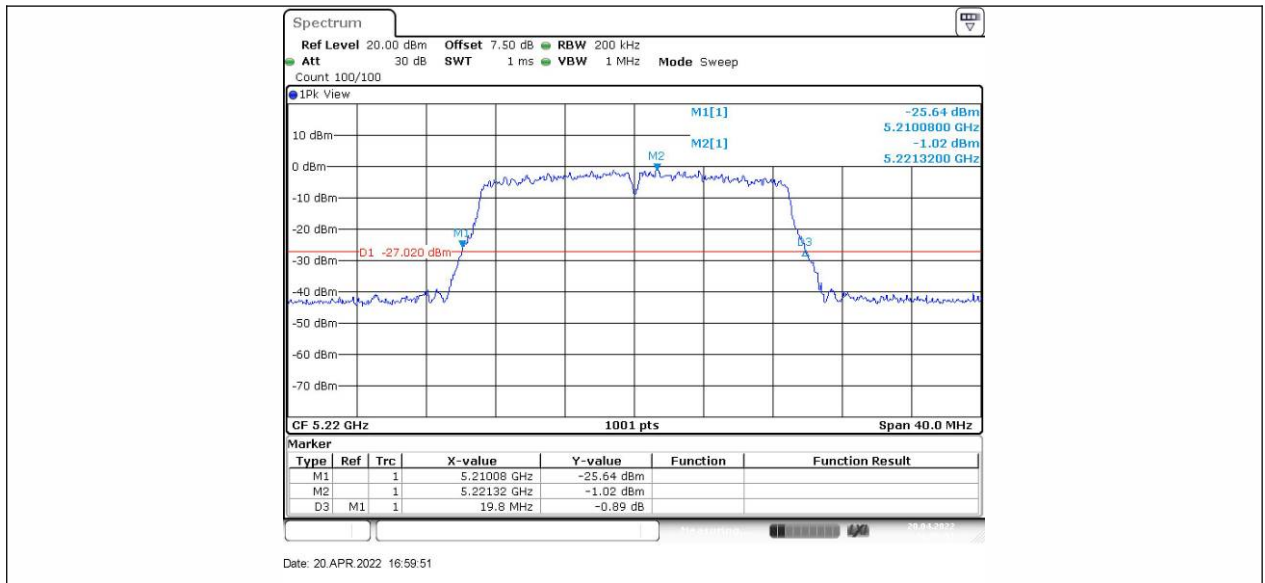

11N20SISO_Ant2_5220

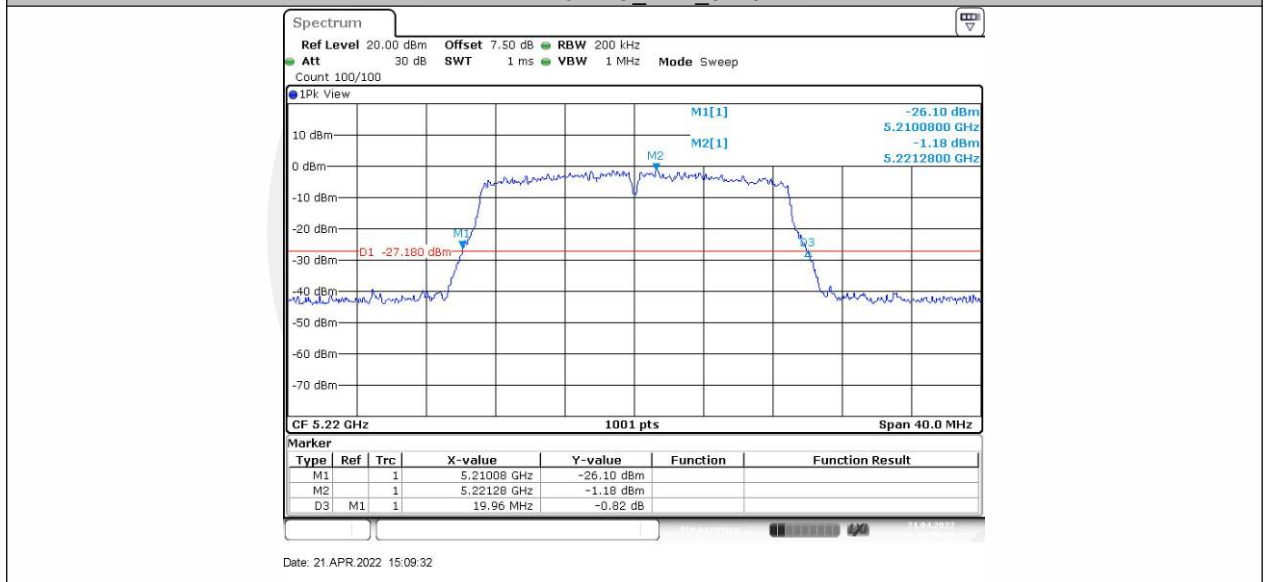

11N20SISO_Ant1_5240

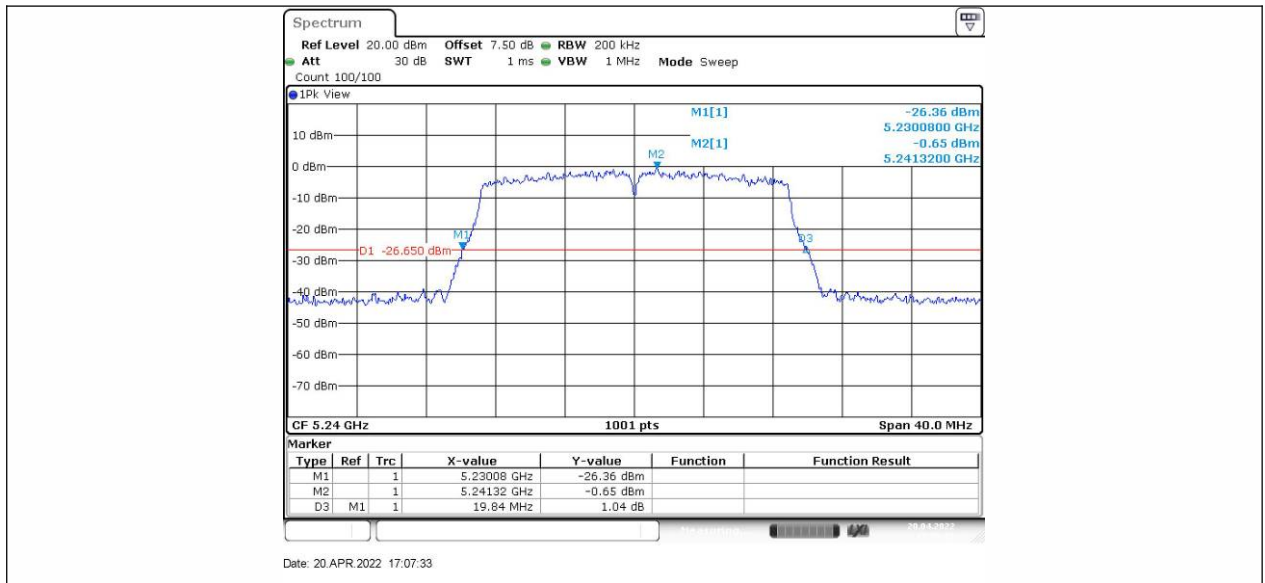

11N20SISO_Ant2_5240

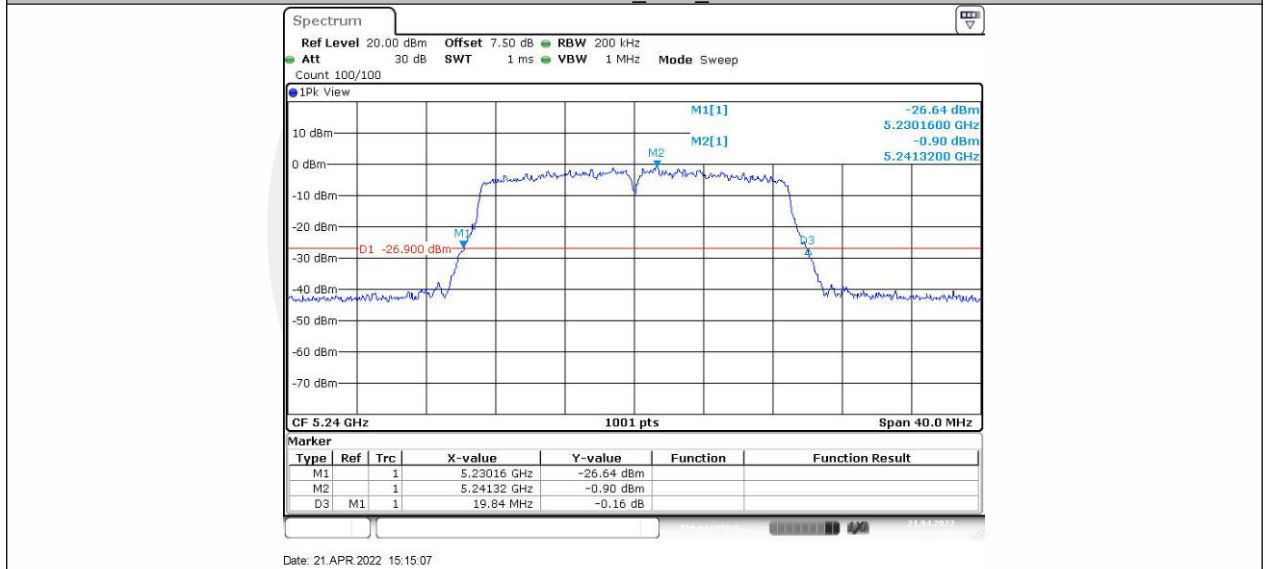

11N20SISO_Ant1_5745

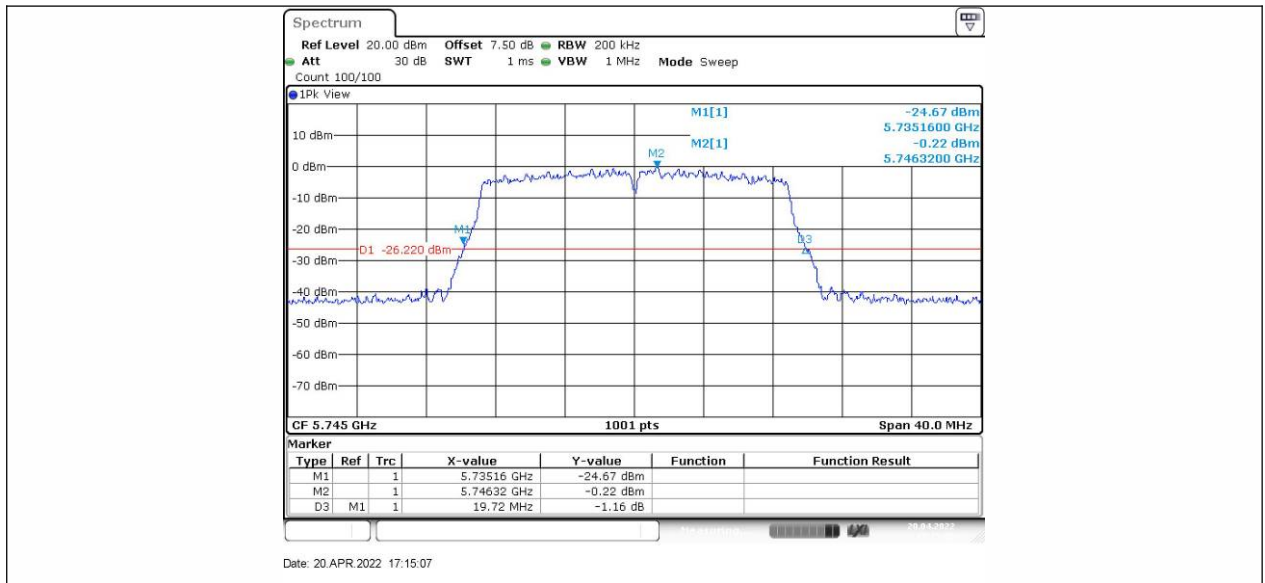

11N20SISO_Ant2_5745

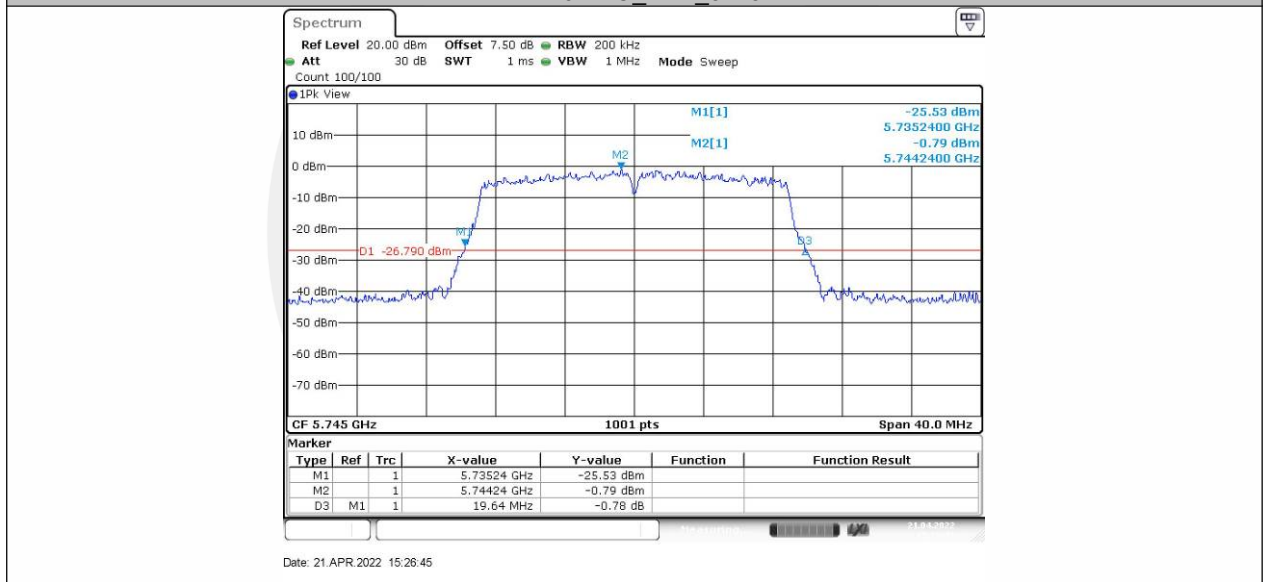

11N20SISO_Ant1_5785

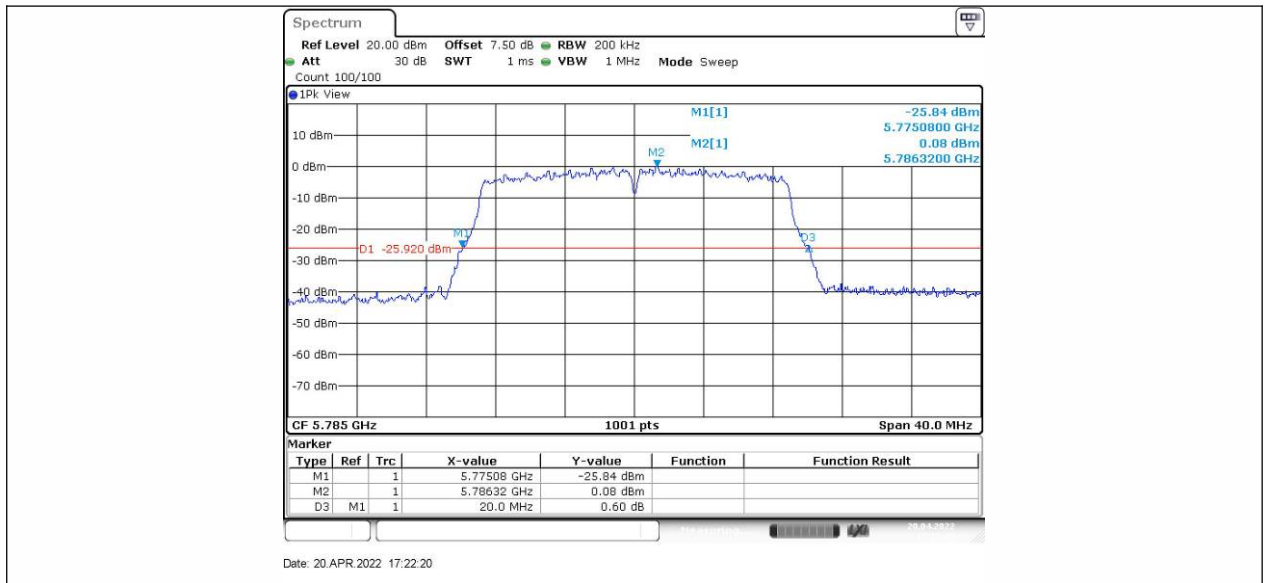

11N20SISO_Ant2_5785

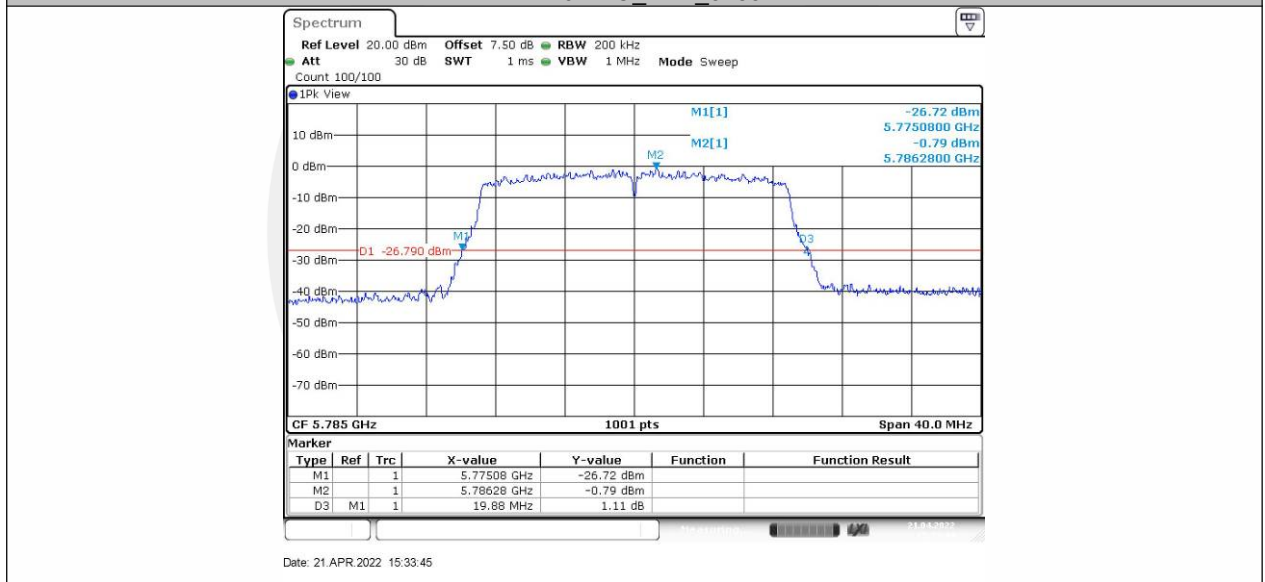

11N20SISO_Ant1_5825

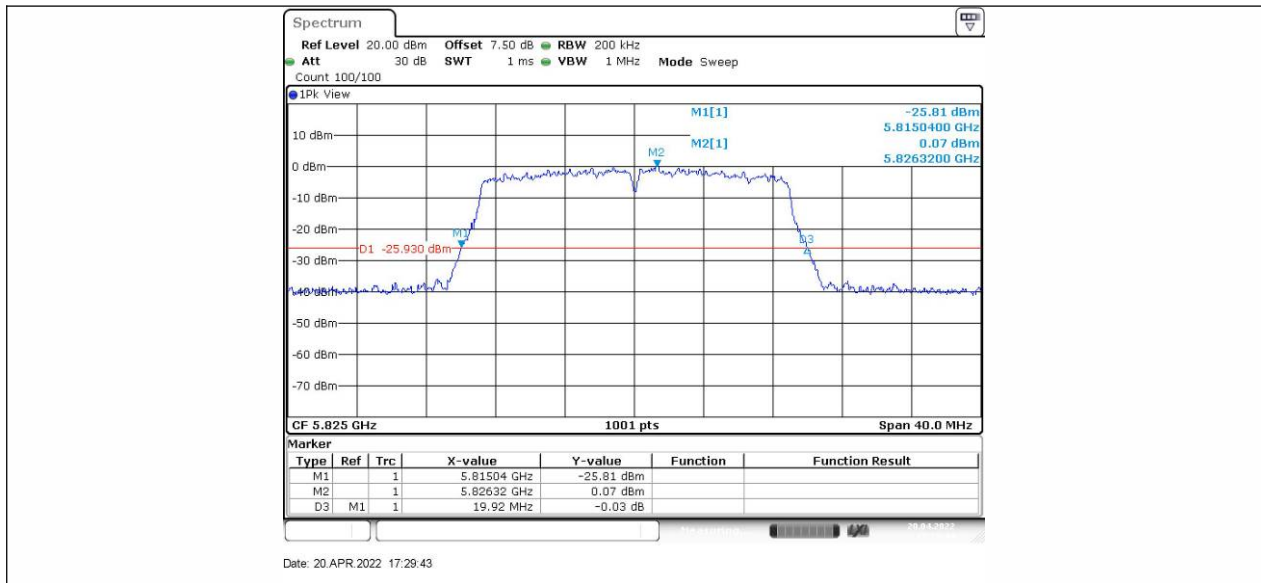

11N20SISO_Ant2_5825

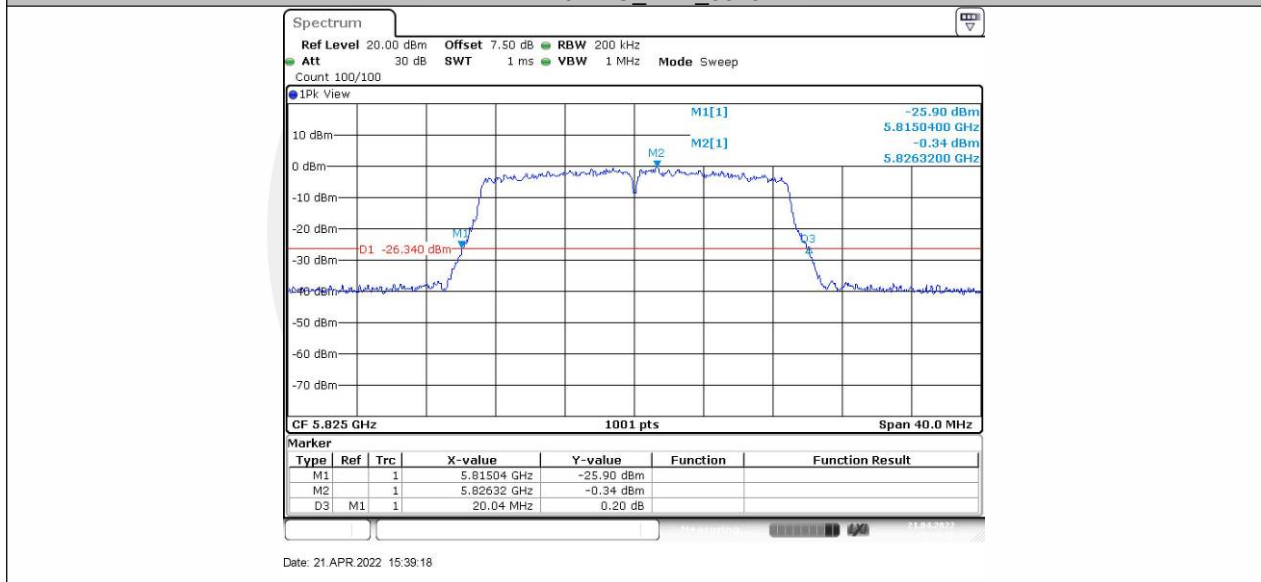

11N40SISO_Ant1_5190

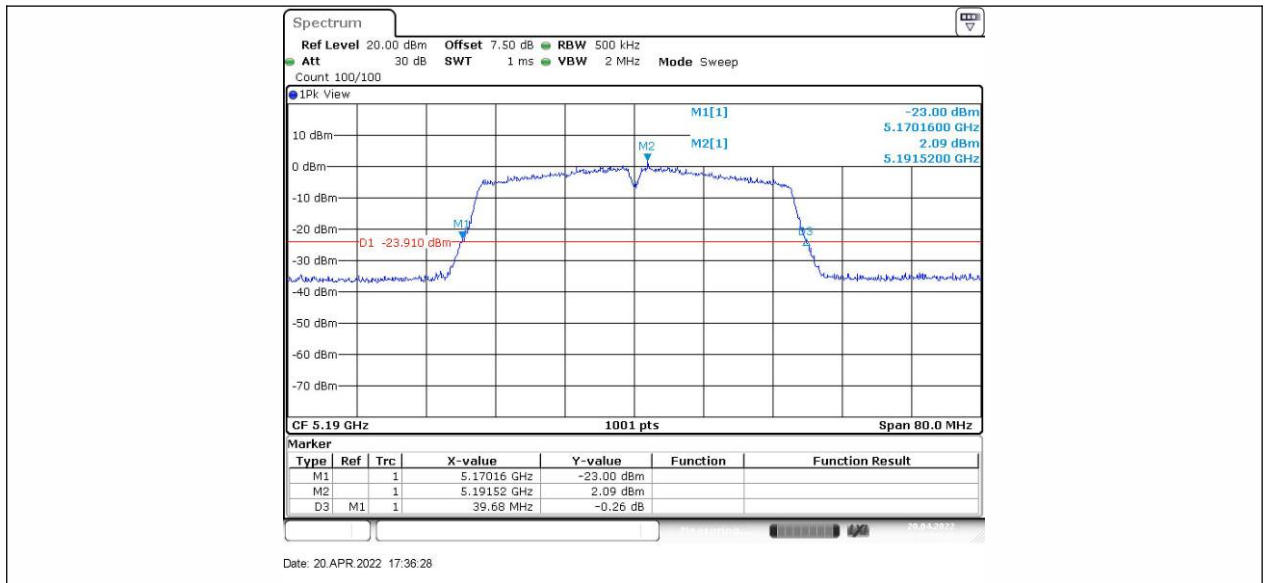

11N40SISO_Ant2_5190

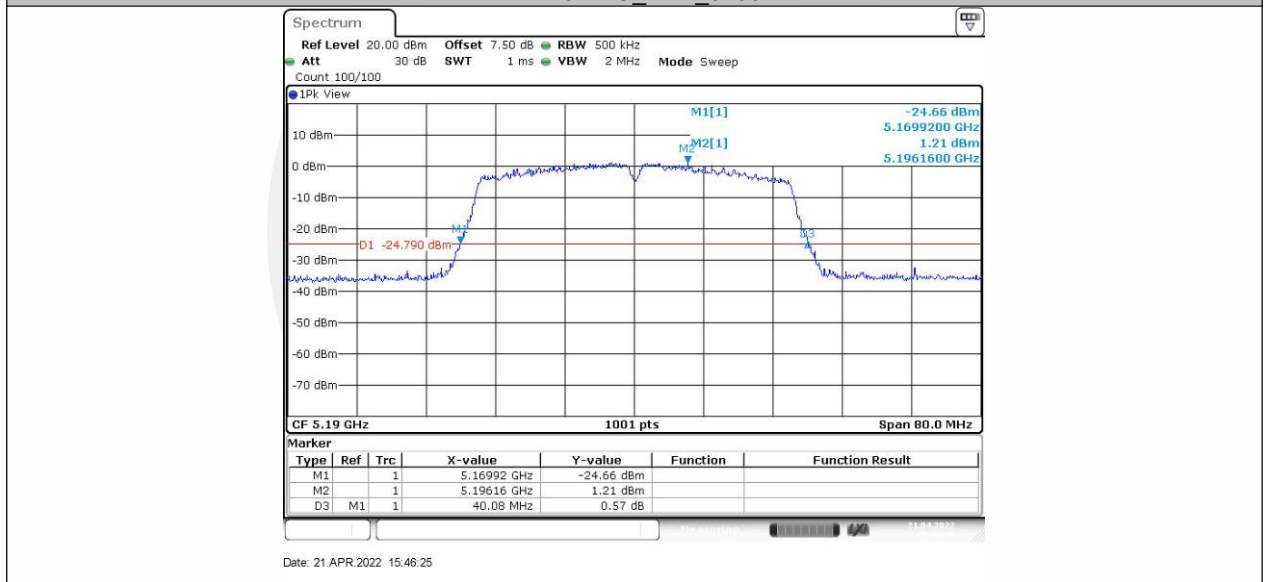

11N40SISO_Ant1_5230

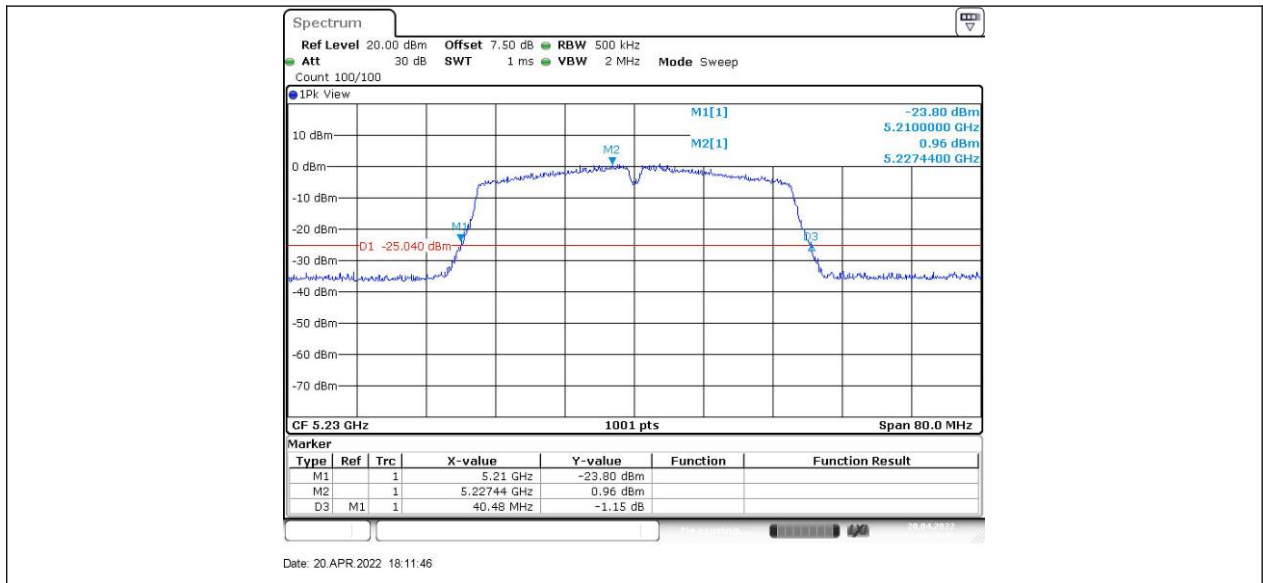

11N40SISO_Ant2_5230

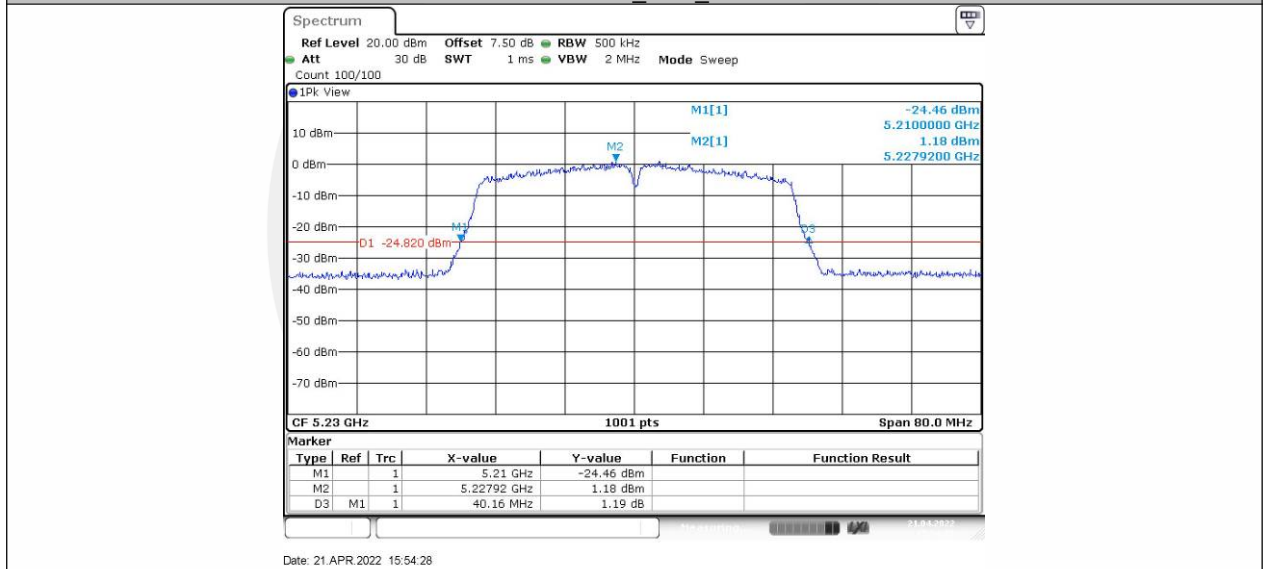

11N40SISO_Ant1_5755

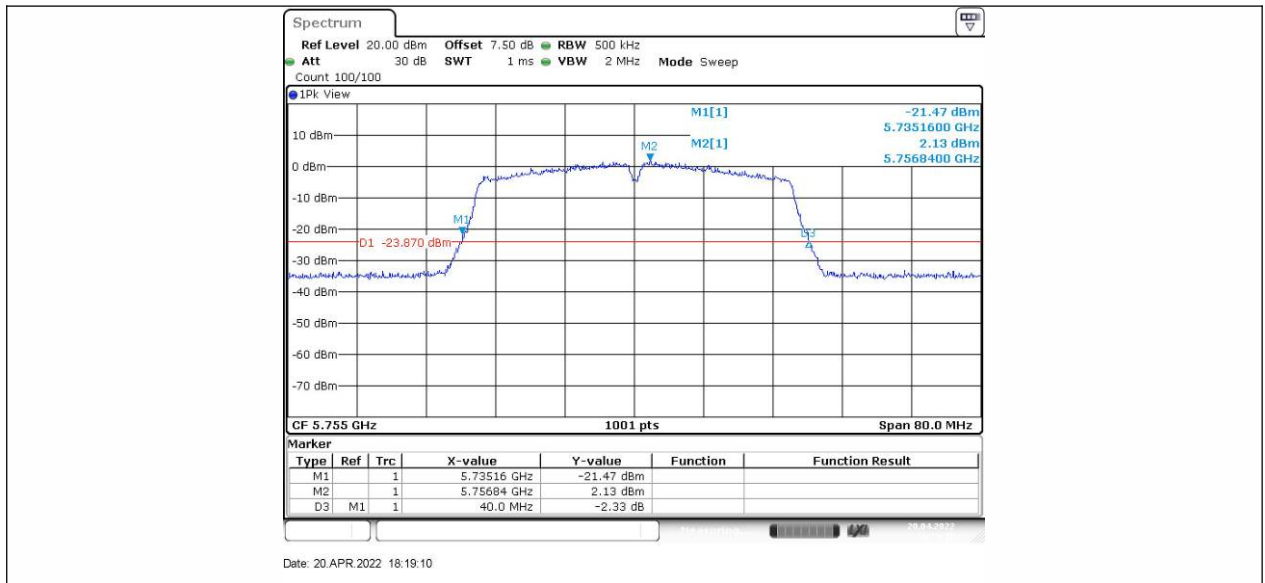

11N40SISO_Ant2_5755

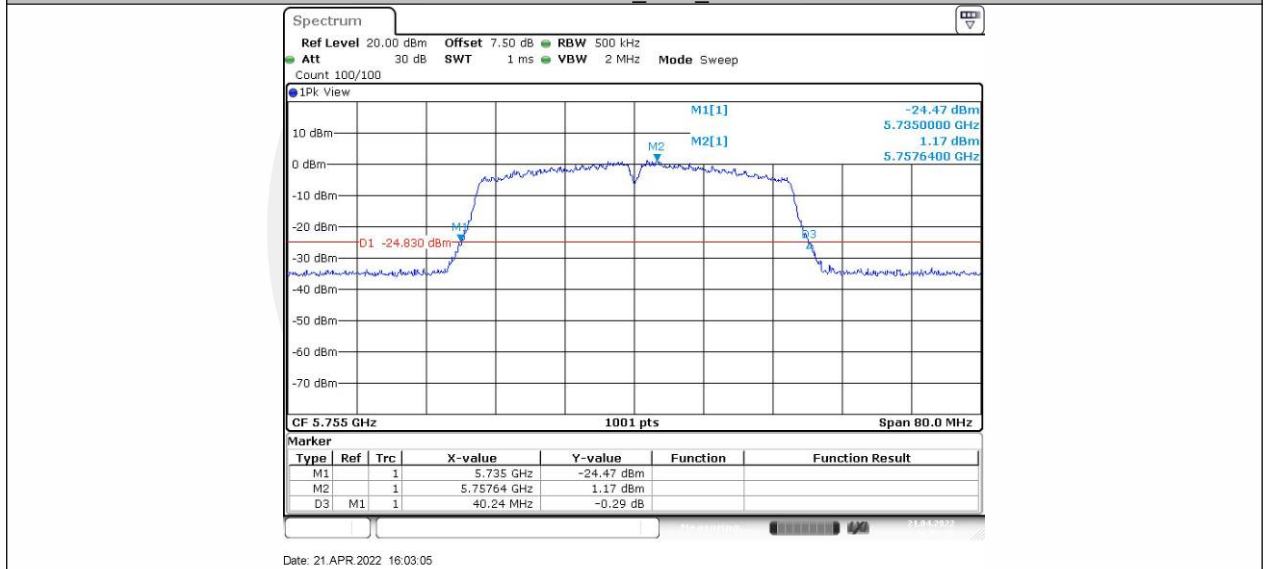

11N40SISO_Ant1_5795

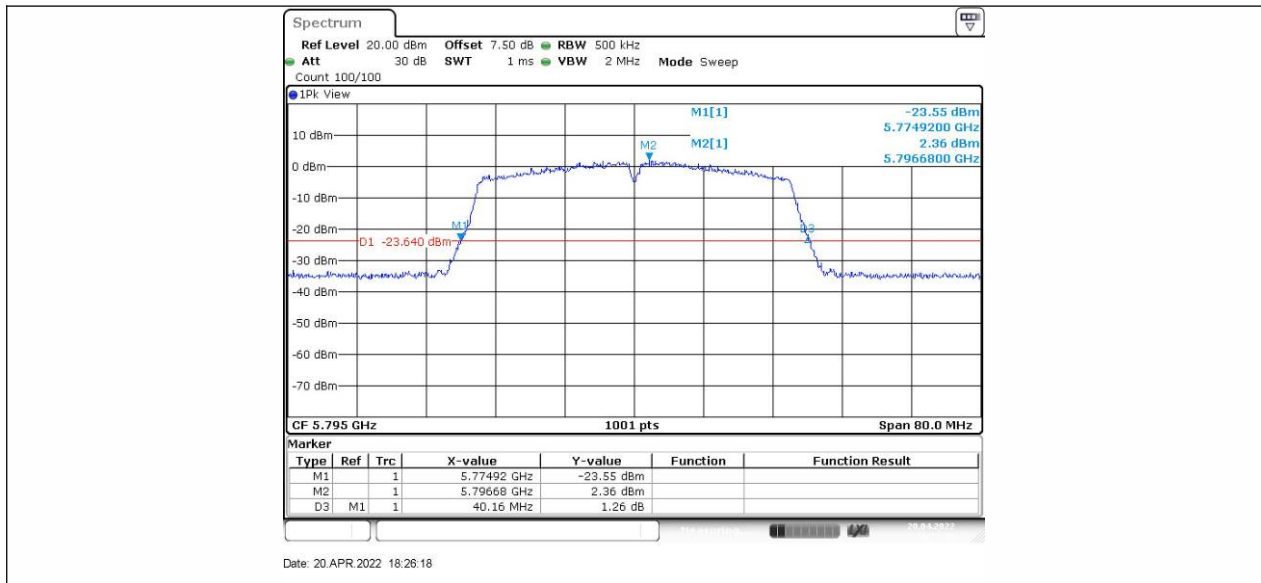

11N40SISO_Ant2_5795

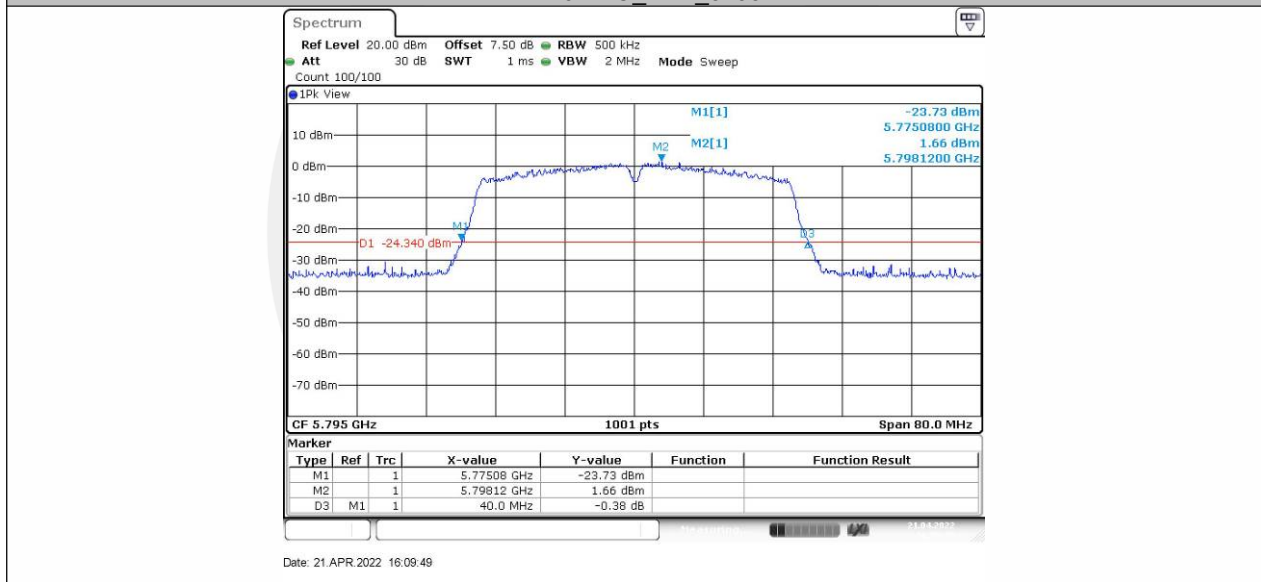

11AC20SISO_Ant1_5180

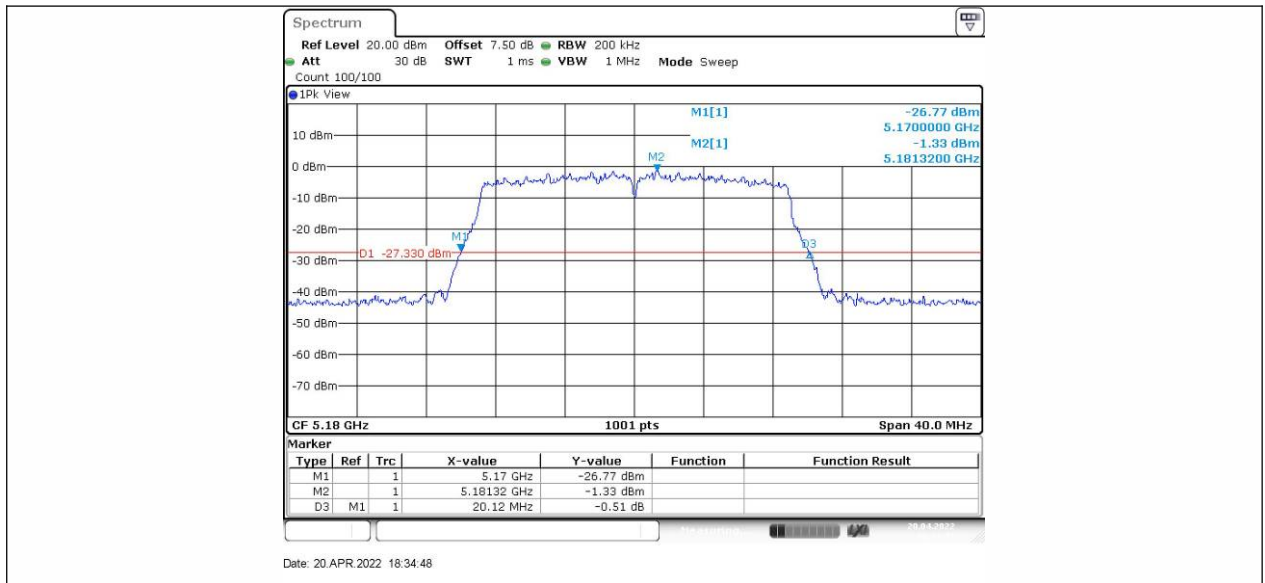

11AC20SISO_Ant2_5180

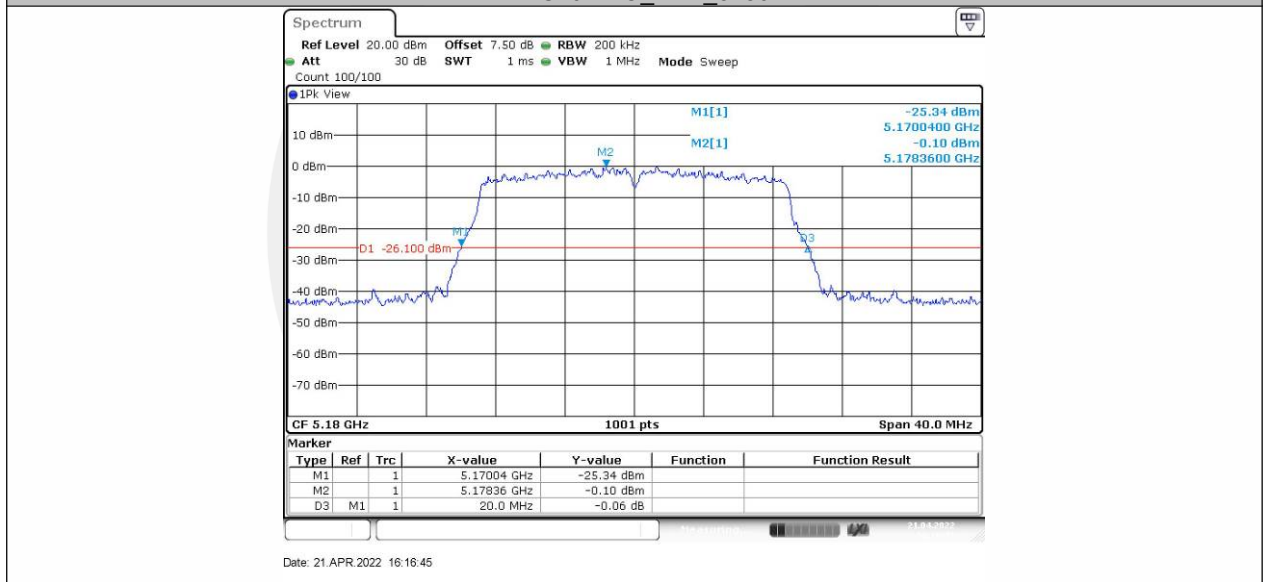

11AC20SISO_Ant1_5220

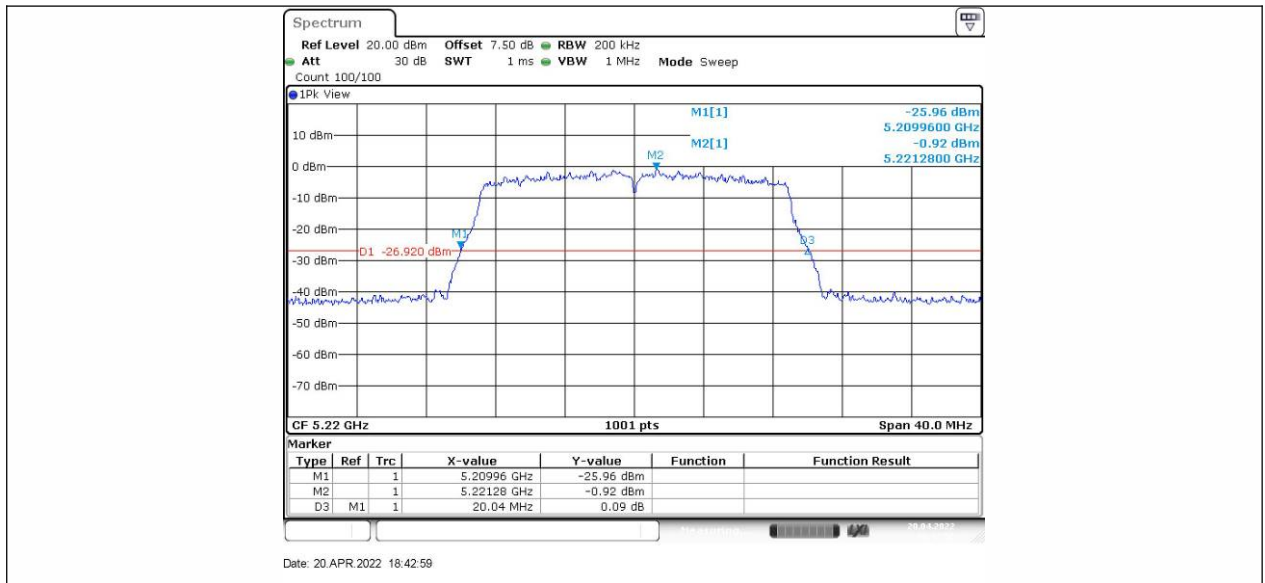

11AC20SISO_Ant2_5220

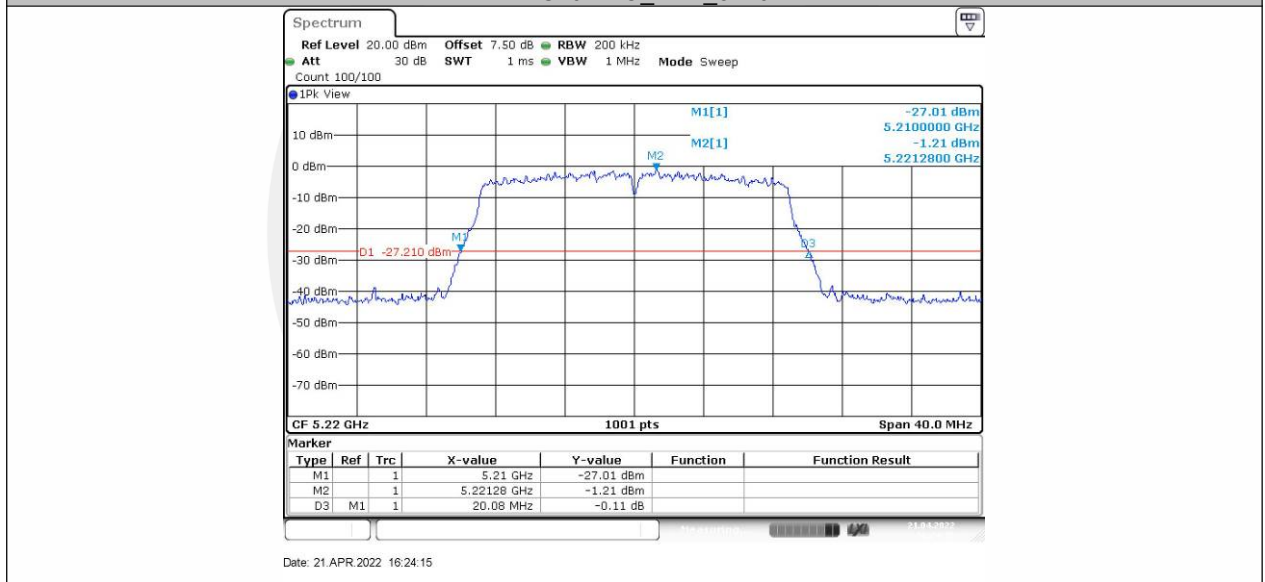

11AC20SISO_Ant1_5240

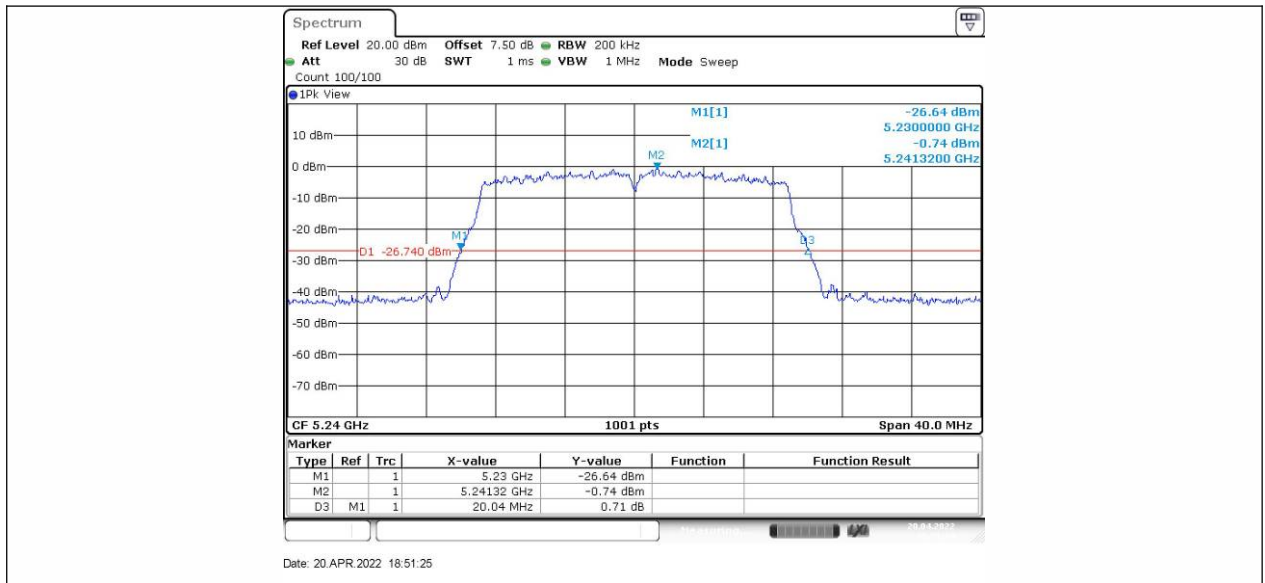

11AC20SISO_Ant2_5240

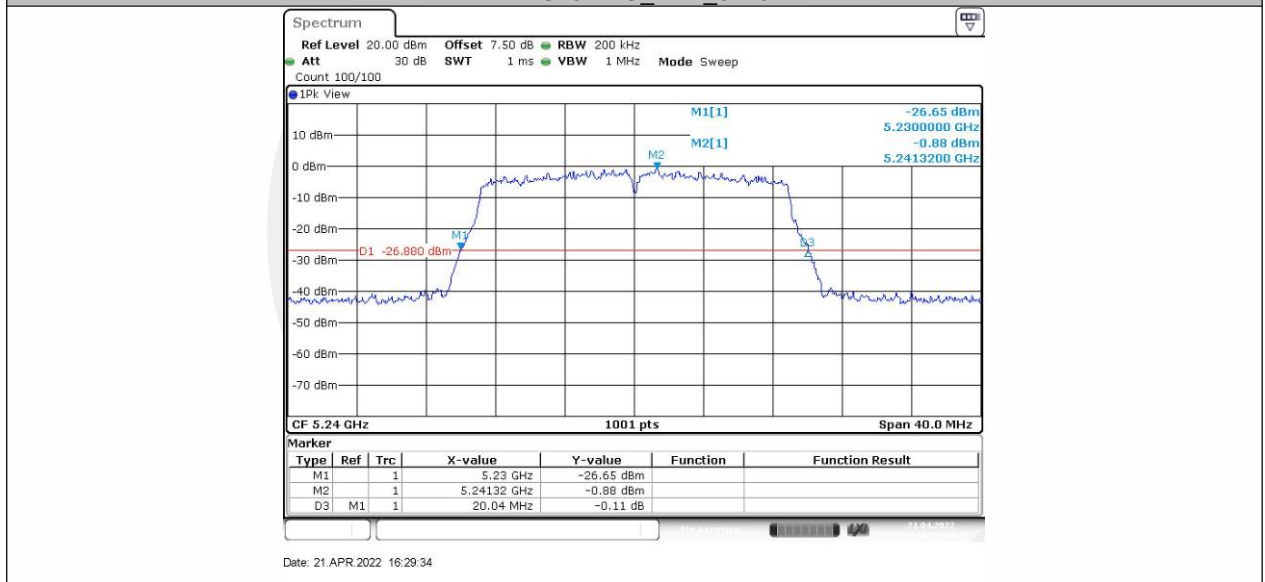

11AC20SISO_Ant1_5745

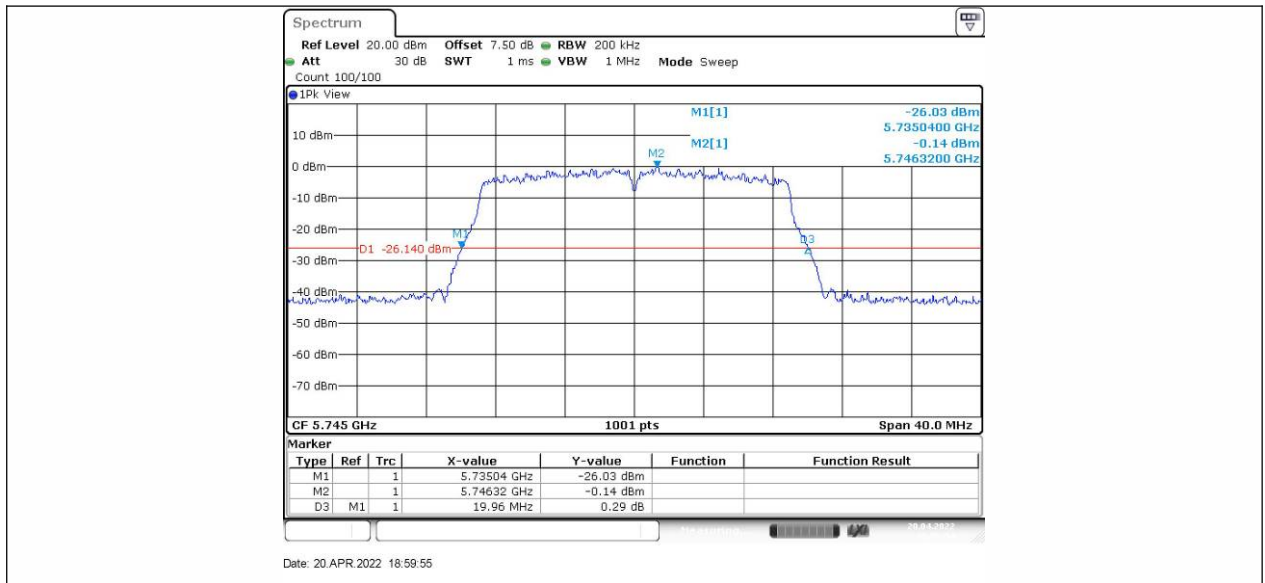

11AC20SISO_Ant2_5745

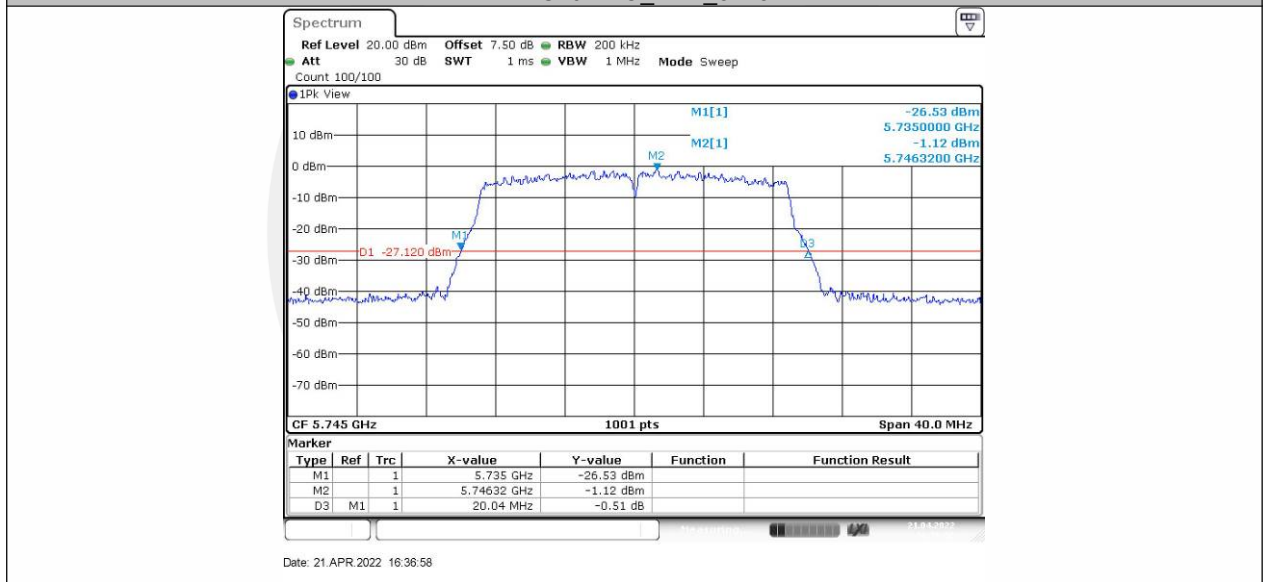

11AC20SISO_Ant1_5785

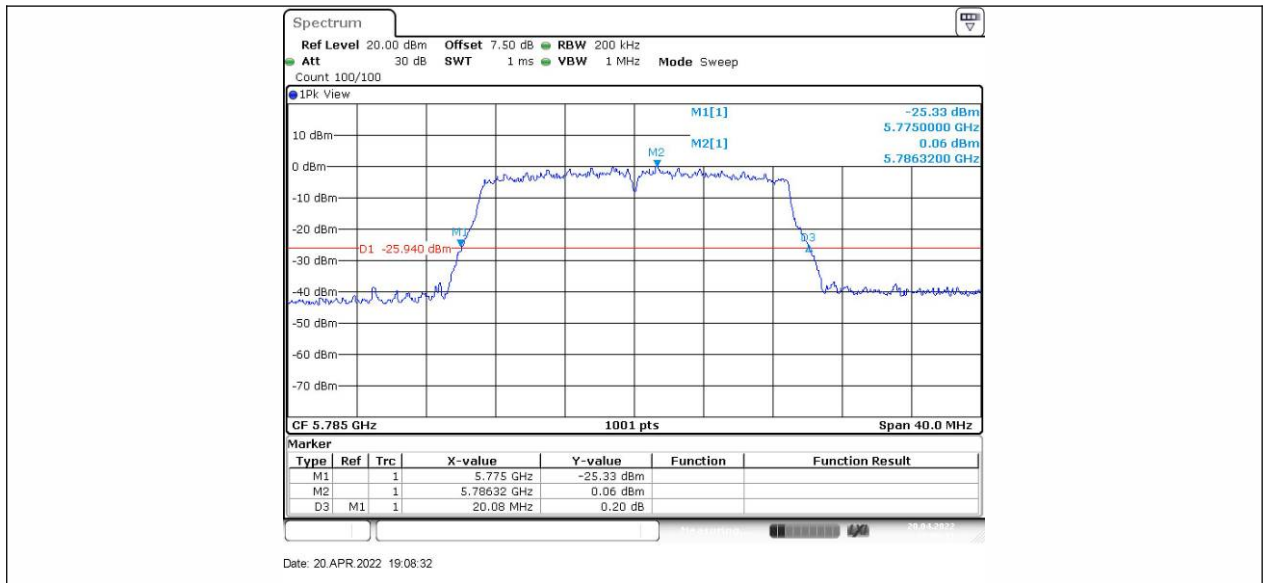

11AC20SISO_Ant2_5785

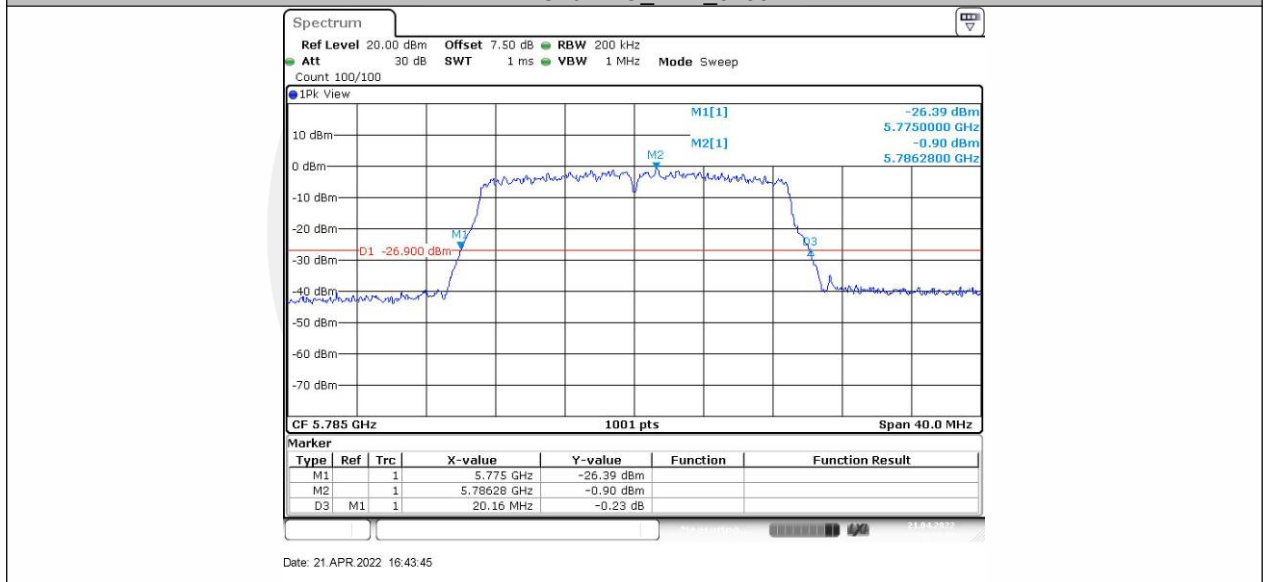

11AC20SISO_Ant1_5825

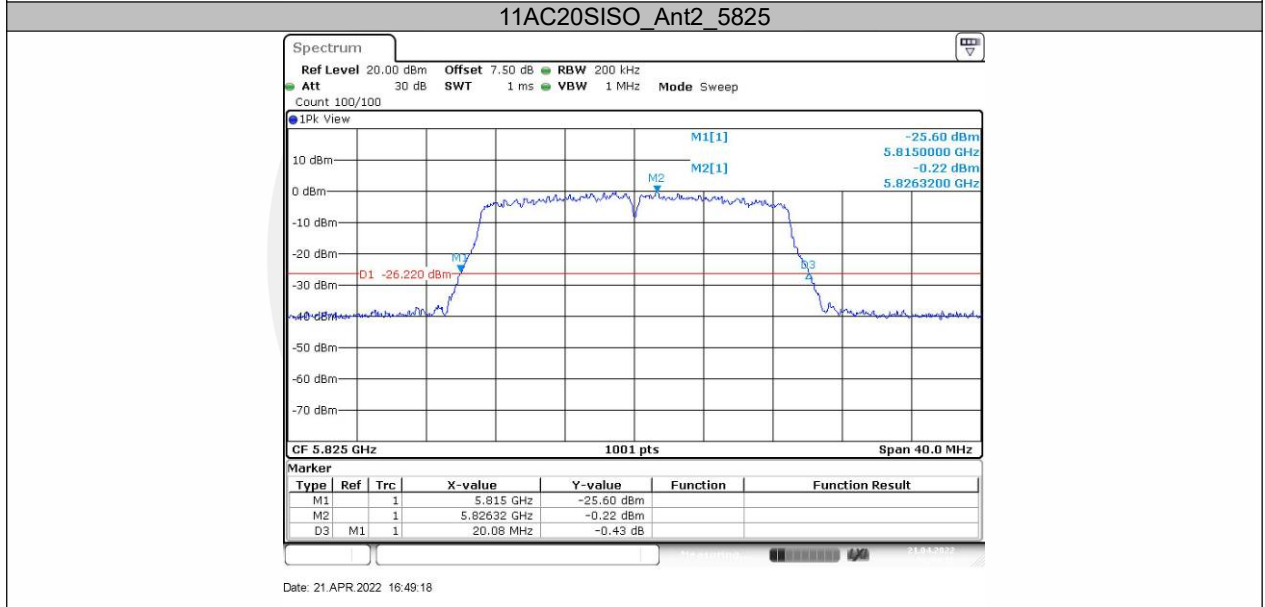
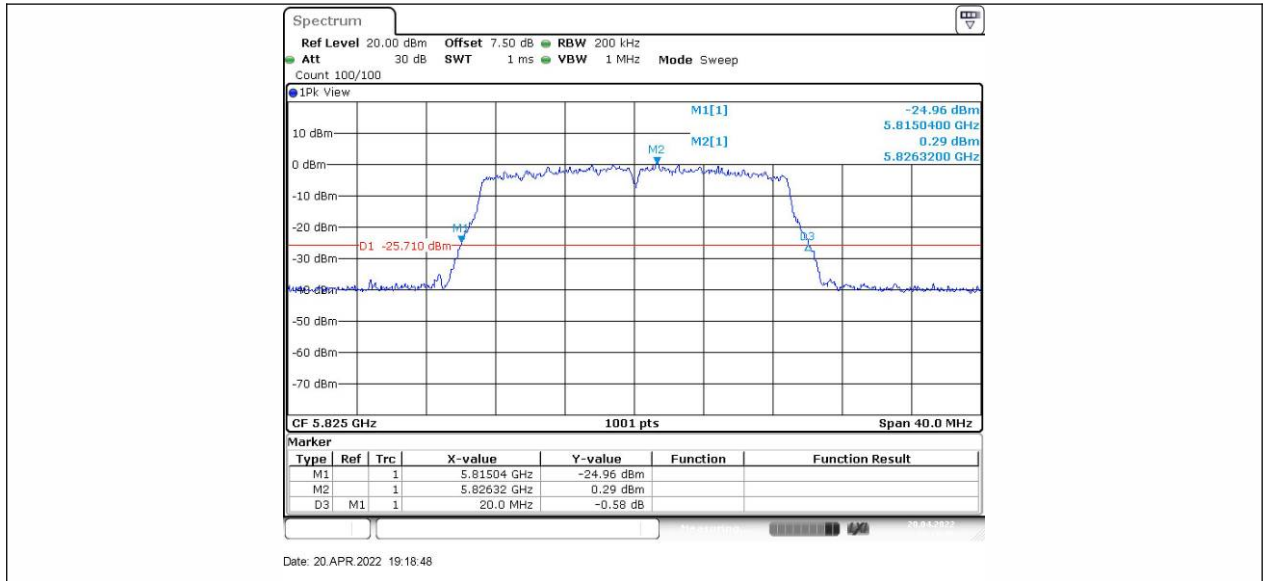

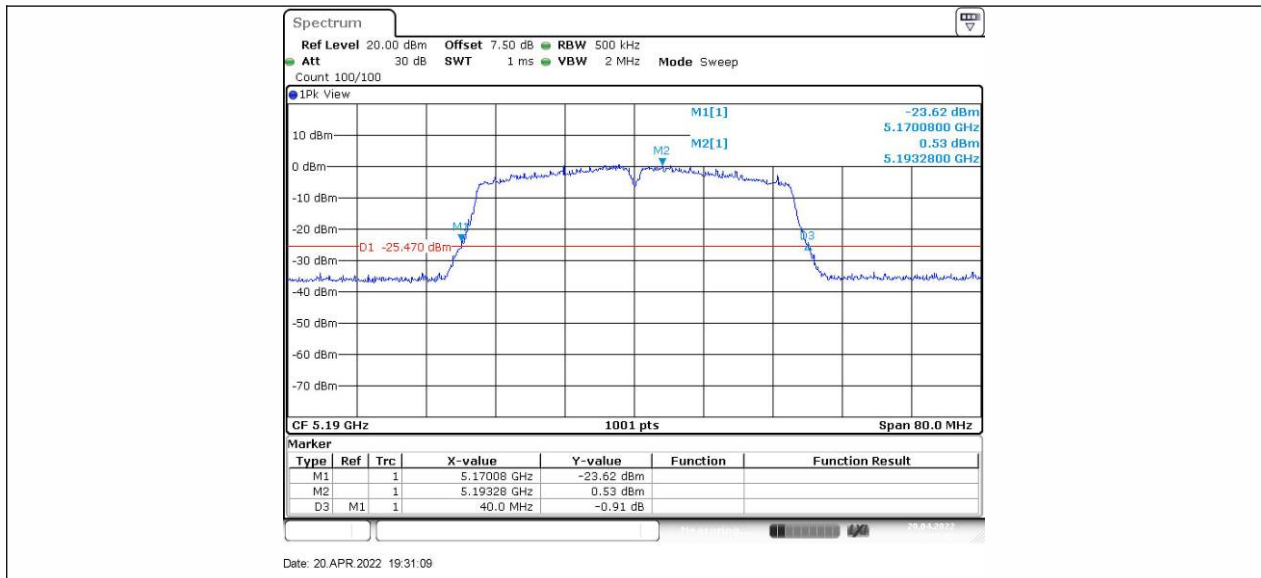

11AC40SISO_Ant2_5190

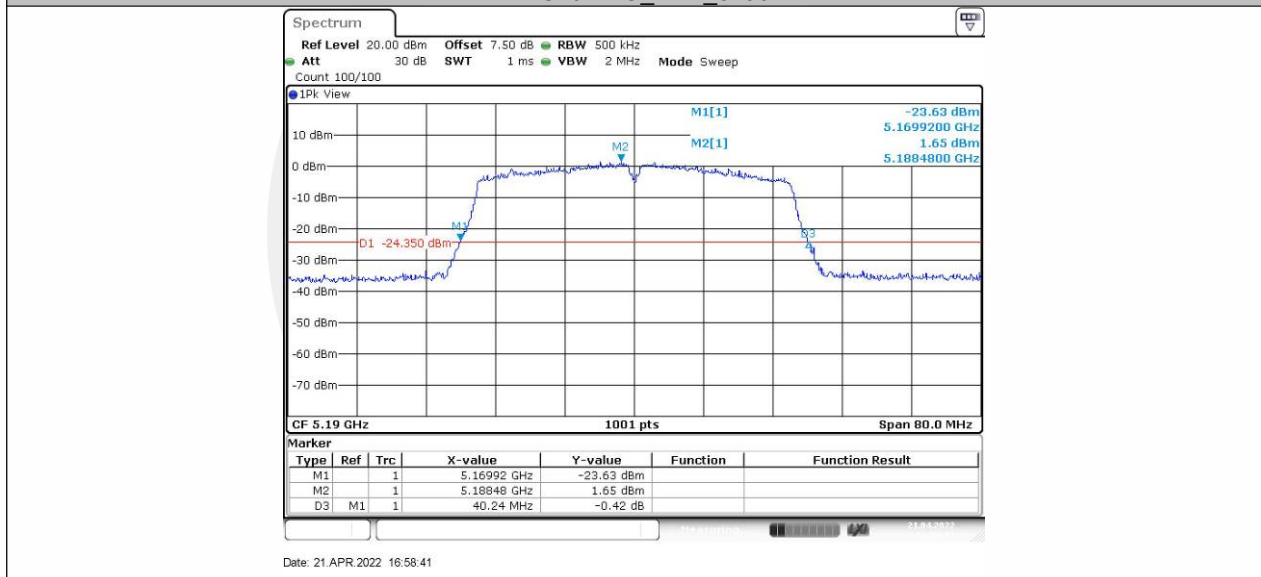

11AC40SISO_Ant1_5230

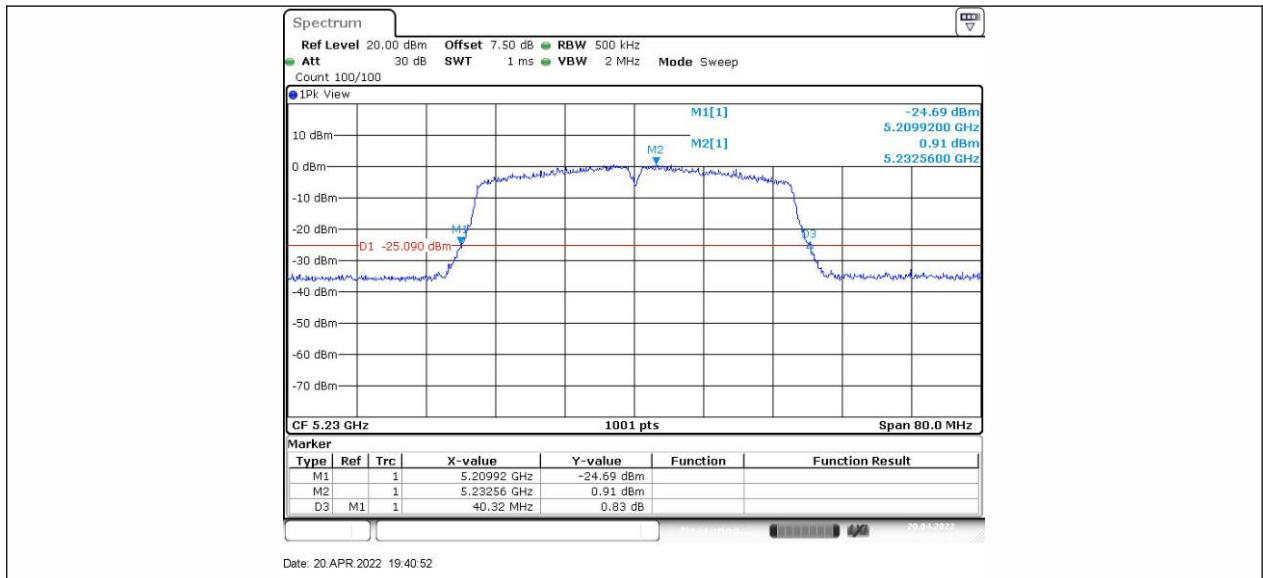

11AC40SISO_Ant2_5230

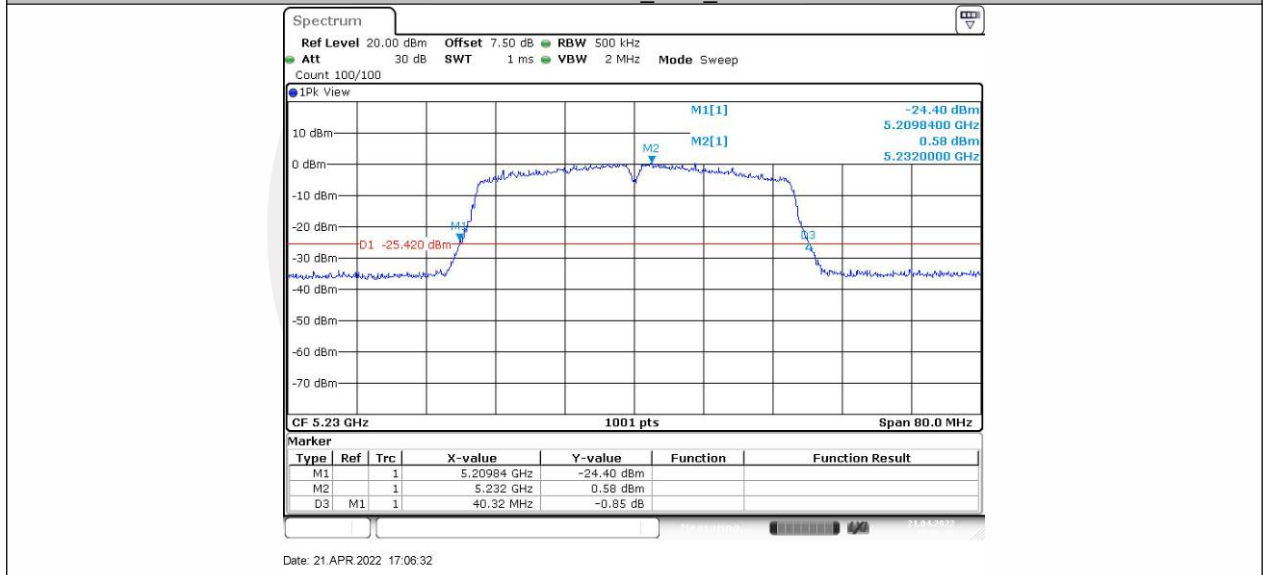

11AC40SISO_Ant1_5755

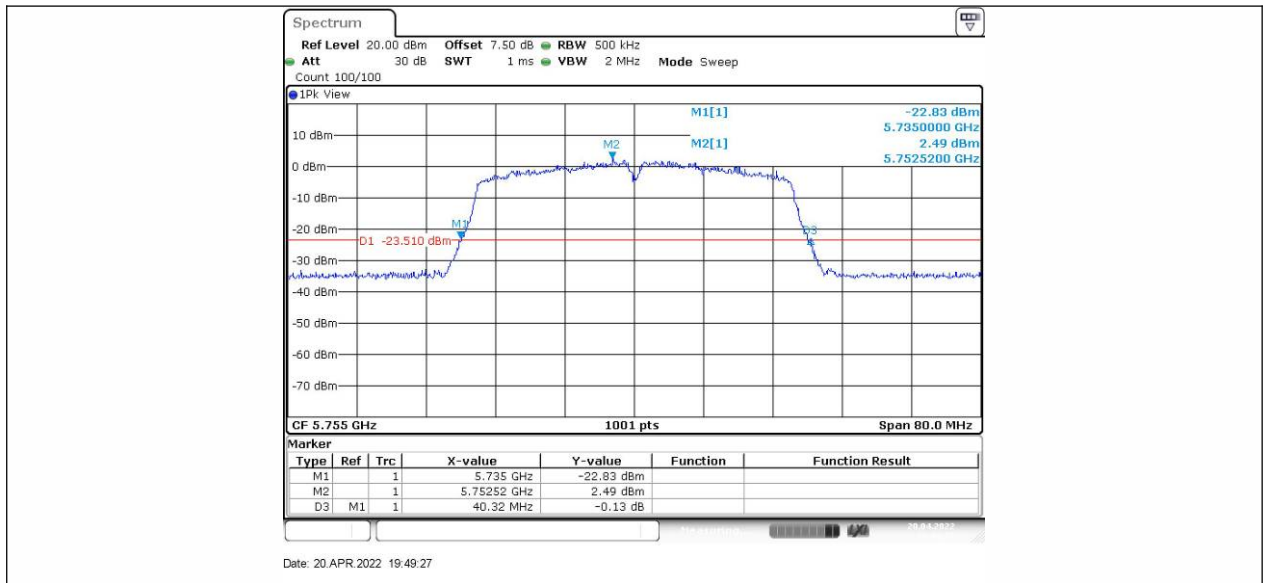

11AC40SISO_Ant2_5755

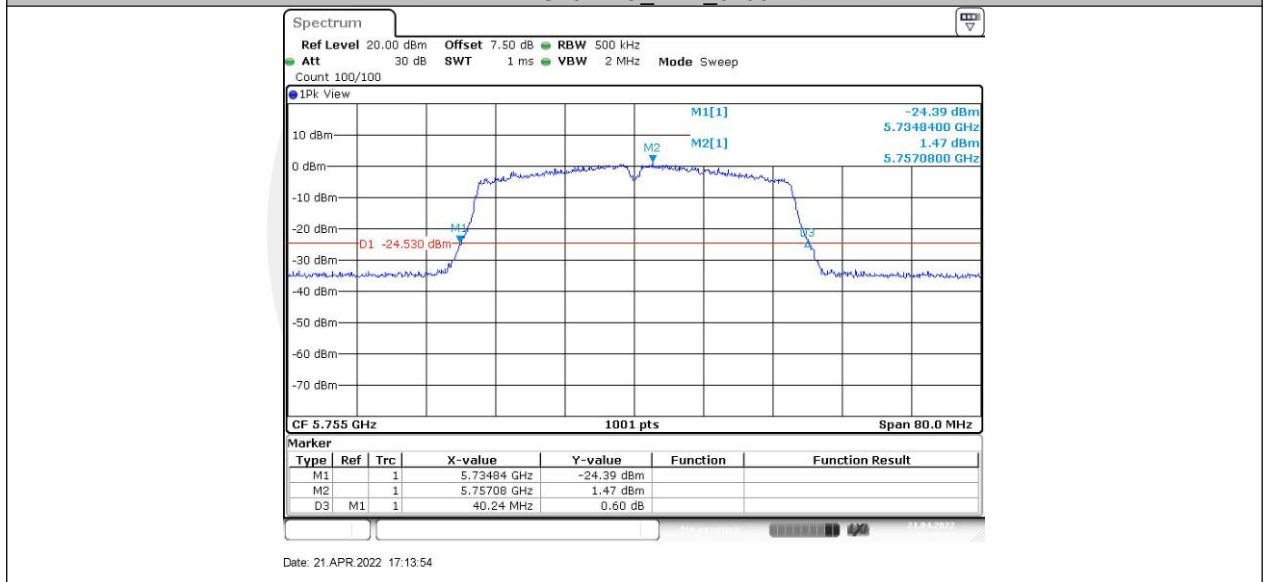

11AC40SISO_Ant1_5795

