

FCC RF Test Report

APPLICANT : Assured Wireless
EQUIPMENT : HPUE Module
BRAND NAME : Assured Wireless
MODEL NAME : AW12-HP
FCC ID : 2AUZ8AW12HP
STANDARD : 47 CFR Part 2, 27(D)
CLASSIFICATION : PCS Licensed Transmitter (PCB)

The product was received on Nov. 06, 2019 and completely tested on Jan. 12, 2020. We, Sporton International (Kunshan) Inc., would like to declare that the tested sample has been evaluated in accordance with the procedures given in ANSI C63.26-2015 and shown compliance with the applicable technical standards.

The test results in this report apply exclusively to the tested model / sample. Without written approval of Sporton International (Kunshan) Inc., the test report shall not be reproduced except in full.

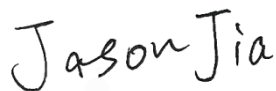

Reviewed by: Jason Jia / Supervisor



Approved by: James Huang / Manager



Sporton International (Kunshan) Inc.

**No. 1098, Pengxi North Road, Kunshan Economic Development Zone Jiangsu Province 215300
People's Republic of China**



TABLE OF CONTENTS

REVISION HISTORY..... 3
SUMMARY OF TEST RESULT 4
1 GENERAL DESCRIPTION 5
1.1 Applicant 5
1.2 Manufacturer 5
1.3 Product Feature of Equipment Under Test 5
1.4 Product Specification of Equipment Under Test 5
1.5 Modification of EUT 5
1.6 Maximum Conducted power, Frequency Tolerance and Emission Designator 6
1.7 Testing Site 7
1.8 Test Software 7
1.9 Applied Standards 7
2 TEST CONFIGURATION OF EQUIPMENT UNDER TEST 8
2.1 Test Mode 8
2.2 Connection Diagram of Test System 9
2.3 Support Unit used in test configuration and system 9
2.4 Measurement Results Explanation Example 9
2.5 Frequency List of Low/Middle/High Channels 10
3 CONDUCTED TEST ITEMS 11
3.1 Measuring Instruments 11
3.2 Test Setup 11
3.3 Test Result of Conducted Test 11
3.4 Conducted Output Power Measurement 12
3.5 Peak-to-Average Ratio 13
3.6 EIRP Power Density 14
3.7 Occupied Bandwidth 15
3.8 Conducted Band Edge Measurement 16
3.9 Conducted Spurious Emission Measurement 17
3.10 Frequency Stability Measurement 18
4 RADIATED TEST ITEMS 19
4.1 Measuring Instruments 19
4.2 Test Setup 19
4.3 Test Result of Radiated Test 19
4.4 Radiated Spurious Emission Measurement 20
5 LIST OF MEASURING EQUIPMENT 21
6 UNCERTAINTY OF EVALUATION 22
APPENDIX A. TEST RESULTS OF CONDUCTED TEST
APPENDIX B. TEST RESULTS OF RADIATED TEST
APPENDIX C. TEST SETUP PHOTOGRAPHS



REVISION HISTORY

REPORT NO.	VERSION	DESCRIPTION	ISSUED DATE
FG9N0606D	Rev. 01	Initial issue of report	Feb. 20, 2020

SUMMARY OF TEST RESULT

Report Section	FCC Rule	Description	Limit	Result	Remark
3.4	§2.1046	Conducted Output Power	Reporting Only	PASS	-
3.5	-	Peak-to-Average Ratio	<13dB	N/A	Reporting only
3.6	§27.50 (a)(3)	EIRP Power Density	EIRP < 250mW/5MHz	PASS	-
3.7	§2.1049	Occupied Bandwidth	Reporting Only	PASS	-
3.8	§2.1051 §27.53 (a)(4)	Conducted Band Edge Measurement	Refer standard	PASS	-
3.9	§2.1051 §27.53 (a)(4)	Conducted Spurious Emission	< 70+10log ₁₀ (P[Watts])	PASS	-
3.10	§2.1055 §27.54	Frequency Stability Temperature & Voltage	Within the band	PASS	-
4.4	§2.1053 §27.53 (a)(4)	Radiated Spurious Emission	< 70+10log ₁₀ (P[Watts])	PASS	Under limit 9.55 dB at 46.12 MHz

Declaration of Conformity:

The test results with all measurement uncertainty excluded are presented in accordance with the regulation limits or requirements declared by manufacturers.

Comments and Explanations:

The declared of product specification for EUT presented in the report are provided by the manufacturer, and the manufacturer takes all the responsibilities for the accuracy of product specification.



1 General Description

1.1 Applicant

Assured Wireless

16885 W. Bernardo Dr., Suite 300, San Diego, CA 92127

1.2 Manufacturer

Assured Wireless

16885 W. Bernardo Dr., Suite 300, San Diego, CA 92127

1.3 Product Feature of Equipment Under Test

Product Feature	
Equipment	HPUE Module
Brand Name	Assured Wireless
Model Name	AW12-HP
FCC ID	2AUZ8AW12HP
EUT supports Radios application	WCDMA /LTE
HW Version	R1.0
SW Version	EM12AWPAR01A07M4G
EUT Stage	Production Unit

1.4 Product Specification of Equipment Under Test

Product Feature	
Tx Frequency	LTE Band 30 : 2307.5 MHz ~ 2312.5 MHz
Rx Frequency	LTE Band 30 : 2352.5 MHz ~ 2357.5 MHz
Bandwidth	5MHz / 10MHz
Maximum Output Power to Antenna	LTE Band 30 : 22.50 dBm
Antenna Gain	LTE Band 30 : 0 dBi
Type of Modulation	QPSK / 16QAM / 64QAM

1.5 Modification of EUT

No modifications are made to the EUT during all test items.

1.6 Maximum Conducted power, Frequency Tolerance and Emission Designator

LTE Band 30		QPSK			16QAM		
BW (MHz)	Frequency Range (MHz)	Emission Designator (99%OBW)	Frequency Tolerance (ppm)	Maximum Conducted power(W)	Emission Designator (99%OBW)	Frequency Tolerance (ppm)	Maximum Conducted power(W)
5	2307.5 ~ 2312.5	4M51G7D	-	0.1778	4M52W7D	-	0.1535
10	2310.0	9M03G7D	0.0026	0.1766	9M01W7D	-	0.1514
LTE Band 30		64QAM					
BW (MHz)	Frequency Range (MHz)	Emission Designator (99%OBW)	Frequency Tolerance (ppm)	Maximum Conducted power(W)			
5	2307.5 ~ 2312.5	4M51W7D	-	0.1180			
10	2310.0	9M05W7D	-	0.1172			

1.7 Testing Site

<FCC>-KS

Sporton International (Kunshan) Inc. is accredited to ISO/IEC 17025:2017 by American Association for Laboratory Accreditation with Certificate Number 5145.02.

Test Firm	Sporton International (Kunshan) Inc.		
Test Site Location	No. 1098, Pengxi North Road, Kunshan Economic Development Zone Jiangsu Province 215300 People's Republic of China TEL : +86-512-57900158 FAX : +86-512-57900958		
Test Site No.	Sporton Site No.	FCC Designation No.	FCC Test Firm Registration No.
	03CH04-KS TH01-KS	CN1257	314309

1.8 Test Software

Item	Site	Manufacture	Name	Version
1.	03CH04-KS	AUDIX	E3	6.2009-8-24a

1.9 Applied Standards

According to the specifications of the manufacturer, the EUT must comply with the requirements of the following standards:

- 47 CFR Part 2, Part 27(D)
- ANSI C63.26-2015
- FCC KDB 971168 Power Meas License Digital Systems D01 v03r01

Remark:

1. All test items were verified and recorded according to the standards and without any deviation during the test.
2. This EUT has also been tested and complied with the requirements of FCC Part 15, Subpart B, recorded in a separate test report.



2 Test Configuration of Equipment Under Test

2.1 Test Mode

Antenna port conducted and radiated test items listed below are performed according to KDB 971168 D01 Power Meas. License Digital Systems v03r01 with maximum output power.

Radiated measurements are performed by rotating the EUT in three different orthogonal test planes to find the maximum emission.

Conducted Test Cases	Band	Bandwidth (MHz)						Modulation			RB #			Test Channel		
		1.4	3	5	10	15	20	QPSK	16QAM	64QAM	1	Half	Full	L	M	H
Max. Output Power	30	-	-	V		-	-	V	V	V	V	V	V	V	V	V
		-	-		V	-	-	V	V	V	V	V	V		V	
Peak-to-Average Ratio	30	-	-		V	-	-	V	V	V	V		V		V	
E.I.R.P PSD	30	-	-	V		-	-	V	V	V	V			V	V	V
		-	-		V	-	-	V	V	V	V				V	
26dB and 99% Bandwidth	30	-	-	V		-	-	V	V	V			V	V	V	V
		-	-		V	-	-	V	V	V			V		V	
Conducted Band Edge	30	-	-	V		-	-	V	V	V	V		V	V		V
		-	-		V	-	-	V	V	V	V		V		V	
Conducted Spurious Emission	30	-	-	V		-	-	V	V	V	V			V	V	V
		-	-		V	-	-	V	V	V	V				V	
Frequency Stability	30	-	-		V	-	-	V					V		V	
Radiated Spurious Emission	30	-	-		V	-	-	V				V			V	
Note	<ol style="list-style-type: none"> The mark "v " means that this configuration is chosen for testing The mark "- " means that this bandwidth is not supported. The device is investigated from 30MHz to 10 times of fundamental signal for radiated spurious emission test under different RB size/offset and modulations in exploratory test. Subsequently, only the worst case emissions are reported. 															

2.2 Connection Diagram of Test System

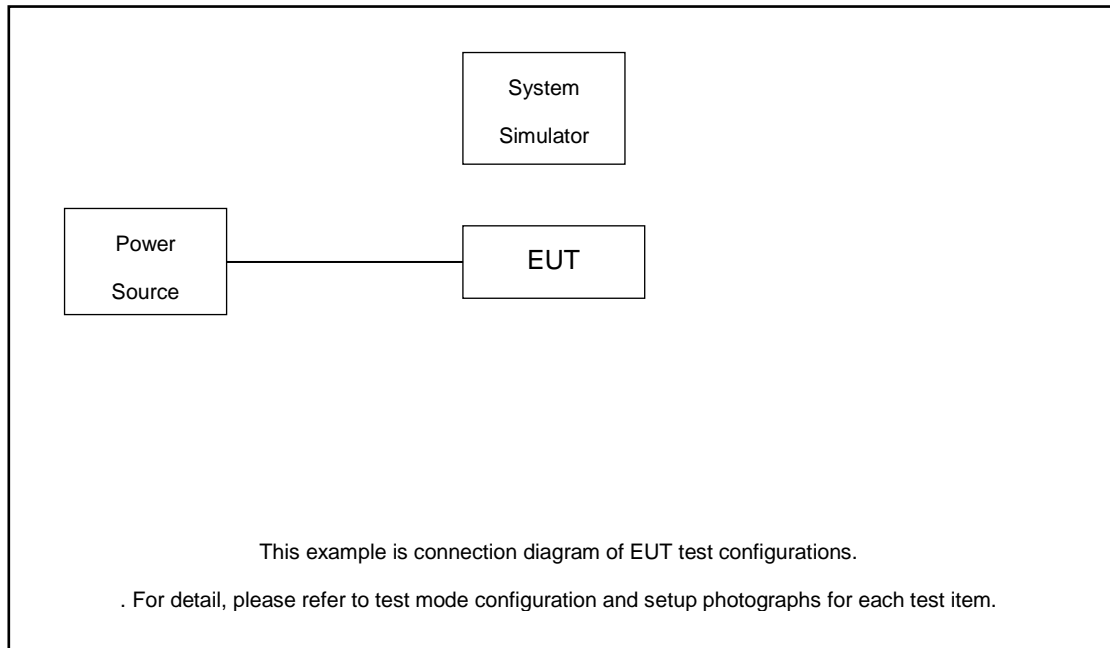

2.3 Support Unit used in test configuration and system

Item	Equipment	Trade Name	Model No.	FCC ID	Data Cable	Power Cord
1.	Power Supply	GWINSTEK	PSS-2002	N/A	N/A	Unshielded, 1.8 m
2.	LTE Base Station	Anritsu	MT8820C	N/A	N/A	Unshielded, 1.8 m

2.4 Measurement Results Explanation Example

For all conducted test items:

The offset level is set in the spectrum analyzer to compensate the RF cable loss and attenuator factor between EUT conducted output port and spectrum analyzer. With the offset compensation, the spectrum analyzer reading level is exactly the EUT RF output level.

The spectrum analyzer offset is derived from RF cable loss and attenuator factor.

Offset = RF cable loss.

Following shows an offset computation example with cable loss 4.80dB.

Example :

$$\begin{aligned}
 \text{Offset(dB)} &= \text{RF cable loss(dB)}. \\
 &= 4.80 \text{ (dB)}
 \end{aligned}$$



2.5 Frequency List of Low/Middle/High Channels

LTE Band 30 Channel and Frequency List				
BW [MHz]	Channel/Frequency(MHz)	Lowest	Middle	Highest
10	Channel	-	27710	-
	Frequency	-	2310	-
5	Channel	27685	27710	27735
	Frequency	2307.5	2310	2312.5

3 Conducted Test Items

3.1 Measuring Instruments

See list of measuring instruments of this test report.

3.2 Test Setup

3.2.1 Conducted Output Power



3.2.2 Peak-to-Average Ratio, Occupied / 26dB Bandwidth, Band-Edge and Conducted Spurious Emission

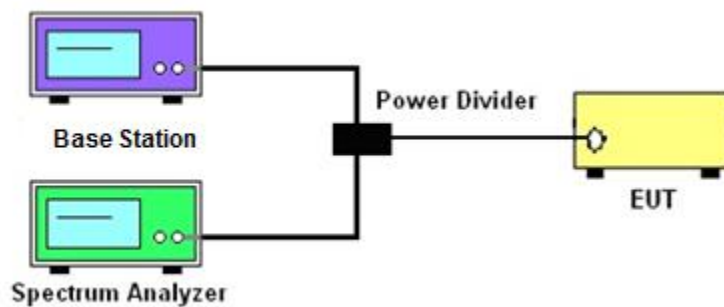

3.2.3 Frequency Stability

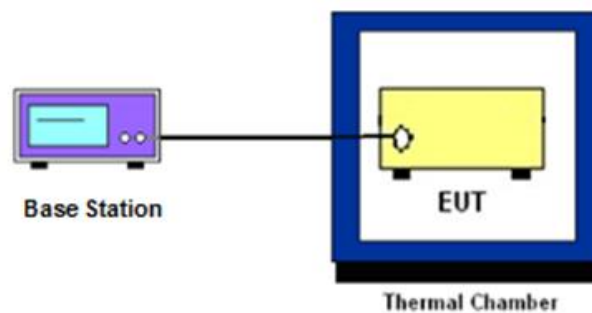

3.3 Test Result of Conducted Test

Please refer to Appendix A.



3.4 Conducted Output Power Measurement

3.4.1 Description of the Conducted Output Power Measurement

A base station simulator was used to establish communication with the EUT. Its parameters were set to transmit the maximum power on the EUT. The measured power in the radio frequency on the transmitter output terminals shall be reported.

3.4.2 Test Procedures

1. The testing follows ANSI C63.26 Section 5.2
2. The transmitter output port was connected to the system simulator.
3. Set EUT at maximum power through the system simulator.
4. Select lowest, middle, and highest channels for each band and different modulation.
5. Measure and record the power level from the system simulator.

3.5 Peak-to-Average Ratio

3.5.1 Description of the PAR Measurement

Power Complementary Cumulative Distribution Function (CCDF) curves provide a means for characterizing the power peaks of a digitally modulated signal on a statistical basis. A CCDF curve depicts the probability of the peak signal amplitude exceeding the average power level. Most contemporary measurement instrumentation include the capability to produce CCDF curves for an input signal provided that the instrument's resolution bandwidth can be set wide enough to accommodate the entire input signal bandwidth. In measuring transmissions in this band using an average power technique, the peak-to-average ratio (PAR) of the transmission may not exceed 13 dB.

3.5.2 Test Procedures

1. The testing follows ANSI C63.26 Section 5.2.3.4 (CCDF).
2. The EUT was connected to spectrum and system simulator via a power divider.
3. Set the CCDF (Complementary Cumulative Distribution Function) option in spectrum analyzer.
4. The highest RF powers were measured and recorded the maximum PAPR level associated with a probability of 0.1 %.
5. Record the deviation as Peak to Average Ratio.

3.6 EIRP Power Density

3.6.1 Description of EIRP Power Density

For mobile and portable stations transmitting in the 2305-2315 MHz band or the 2350-2360 MHz band, the average EIRP must not exceed 50 milliwatts within any 1 megahertz of authorized bandwidth, *except that* for mobile and portable stations compliant with 3GPP LTE standards or another advanced mobile broadband protocol that avoids concentrating energy at the edge of the operating band the average EIRP must not exceed 250 milliwatts within any 5 megahertz of authorized bandwidth but may exceed 50 milliwatts within any 1 megahertz of authorized bandwidth. For mobile and portable stations using time division duplexing (TDD) technology, the duty cycle must not exceed 38 percent in the 2305-2315 MHz and 2350-2360 MHz bands. Mobile and portable stations using FDD technology are restricted to transmitting in the 2305-2315 MHz band. Power averaging shall not include intervals in which the transmitter is off.

3.6.2 Test Procedures

1. The testing follows ANSI C63.26 Section 5.2.4.5
2. Set instrument center frequency to OBW center frequency.
3. Set span to at least 1.5 times the OBW.
4. Set the RBW to the specified reference bandwidth (5MHz).
5. Set VBW $\geq 3 \times$ RBW.
6. Detector = RMS (power averaging).
7. Ensure that the number of measurement points in the sweep $\geq 2 \times$ span/RBW.
8. Sweep time = auto couple.
9. Employ trace averaging (RMS) mode over a minimum of 100 traces.
10. Use the peak marker function to determine the maximum amplitude level within the reference bandwidth (PSD).

3.7 Occupied Bandwidth

3.7.1 Description of Occupied Bandwidth Measurement

The occupied bandwidth is the width of a frequency band such that, below the lower and above the upper frequency limits, the mean powers emitted are each equal to a specified percentage 0.5% of the total mean transmitted power.

The 26 dB emission bandwidth is defined as the frequency range between two points, one above and one below the carrier frequency, at which the spectral density of the emission is attenuated 26 dB below the maximum in-band spectral density of the modulated signal. Spectral density (power per unit bandwidth) is to be measured with a detector of resolution bandwidth equal to approximately 1.0% of the emission bandwidth.

3.7.2 Test Procedures

1. The testing follows ANSI C63.26 Section 5.4
2. The EUT was connected to spectrum analyzer and system simulator via a power divider.
3. The spectrum analyzer center frequency is set to the nominal EUT channel center frequency. The span range for the spectrum analyzer shall be between two and five times the anticipated OBW.
4. The nominal resolution bandwidth (RBW) shall be in the range of 1 to 5 % of the anticipated OBW, and the VBW shall be at least 3 times the RBW.
5. Set the detection mode to peak, and the trace mode to max hold.
6. Determine the reference value: Set the EUT to transmit a modulated signal. Allow the trace to stabilize. Set the spectrum analyzer marker to the highest level of the displayed trace.
(this is the reference value)
7. Determine the “-26 dB down amplitude” as equal to (Reference Value – X).
8. Place two markers, one at the lowest and the other at the highest frequency of the envelope of the spectral display such that each marker is at or slightly below the “-X dB down amplitude” determined in step 6. If a marker is below this “-X dB down amplitude” value it shall be placed as close as possible to this value. The OBW is the positive frequency difference between the two markers.
9. Use the 99 % power bandwidth function of the spectrum analyzer and report the measured bandwidth.

3.8 Conducted Band Edge Measurement

3.8.1 Description of Conducted Band Edge Measurement

27.53 (a)(4)

For mobile and portable stations operating in the 2305-2315 MHz and 2350-2360 MHz bands:

- (i) By a factor of not less than: $43 + 10 \log (P)$ dB on all frequencies between 2305 and 2320 MHz and on all frequencies between 2345 and 2360 MHz that are outside the licensed band(s) of operation, not less than $55 + 10 \log (P)$ dB on all frequencies between 2320 and 2324 MHz and on all frequencies between 2341 and 2345 MHz, not less than $61 + 10 \log (P)$ dB on all frequencies between 2324 and 2328 MHz and on all frequencies between 2337 and 2341 MHz, and not less than $67 + 10 \log (P)$ dB on all frequencies between 2328 and 2337 MHz;
- (ii) By a factor of not less than $43 + 10 \log (P)$ dB on all frequencies between 2300 and 2305 MHz, $55 + 10 \log (P)$ dB on all frequencies between 2296 and 2300 MHz, $61 + 10 \log (P)$ dB on all frequencies between 2292 and 2296 MHz, $67 + 10 \log (P)$ dB on all frequencies between 2288 and 2292 MHz, and $70 + 10 \log (P)$ dB below 2288 MHz;
- (iii) By a factor of not less than $43 + 10 \log (P)$ dB on all frequencies between 2360 and 2365 MHz, and not less than $70 + 10 \log (P)$ dB above 2365 MHz.

3.8.2 Test Procedures

1. The testing follows ANSI C63.26 section 5.7
2. The EUT was connected to spectrum analyzer and system simulator via a power divider.
3. The band edges of low and high channels for the highest RF powers were measured.
4. Set RBW \geq 1% EBW in the 1MHz band immediately outside and adjacent to the band edge.
5. Beyond the 1 MHz band from the band edge, RBW=1MHz was used or a narrower RBW was used and the measured power was integrated over the full required measurement bandwidth of 1 MHz.
6. Set spectrum analyzer with RMS detector.
7. The RF fundamental frequency should be excluded against the limit line in the operating frequency band.
8. Checked that all the results comply with the emission limit line.

Example:

The limit line is derived from $43 + 10\log(P)$ dB below the transmitter power P(Watts)

$$= P(W) - [43 + 10\log(P)] \text{ (dB)}$$

$$= [30 + 10\log(P)] \text{ (dBm)} - [43 + 10\log(P)] \text{ (dB)} = -13\text{dBm.}$$

3.9 Conducted Spurious Emission Measurement

3.9.1 Description of Conducted Spurious Emission Measurement

The power of any emission outside of the authorized operating frequency ranges must be lower than the transmitter power (P) by a factor of at least $70 + 10 \log (P)$ dB.

It is measured by means of a calibrated spectrum analyzer and scanned from 9 kHz up to a frequency including its 10th harmonic.

3.9.2 Test Procedures

1. The testing follows ANSI C63.26 section 5.7
2. The EUT was connected to spectrum analyzer and system simulator via a power divider.
3. The RF output of EUT was connected to the spectrum analyzer by RF cable and attenuator. The path loss was compensated to the results for each measurement.
4. The middle channel for the highest RF power within the transmitting frequency was measured.
5. The conducted spurious emission for the whole frequency range was taken.
6. Make the measurement with the spectrum analyzer's RBW = 1MHz, VBW = 3MHz.
7. Set spectrum analyzer with RMS detector.
8. Taking the record of maximum spurious emission.
9. The RF fundamental frequency should be excluded against the limit line in the operating frequency band.
10. The limit line is derived from $70 + 10\log(P)$ dB below the transmitter power P(Watts)
= P(W)- [70 + 10log(P)] (dB)
= [30 + 10log(P)] (dBm) - [70 + 10log(P)] (dB)
= -40dBm

3.10 Frequency Stability Measurement

3.10.1 Description of Frequency Stability Measurement

The frequency stability shall be measured by variation of ambient temperature and variation of primary supply voltage to ensure that the fundamental emission stays within the authorized frequency block. The frequency stability of the transmitter shall be maintained within $\pm 0.00025\%$ ($\pm 2.5\text{ppm}$) of the center frequency.

3.10.2 Test Procedures for Temperature Variation

1. The testing follows ANSI C63.26 section 5.6.4
2. The EUT was set up in the thermal chamber and connected with the system simulator.
3. With power OFF, the temperature was decreased to -30°C and the EUT was stabilized before testing. Power was applied and the maximum change in frequency was recorded within one minute.
4. With power OFF, the temperature was raised in 10°C step up to 50°C . The EUT was stabilized at each step for at least half an hour. Power was applied and the maximum frequency change was recorded within one minute.

3.10.3 Test Procedures for Voltage Variation

1. The testing follows ANSI C63.26 section 5.6.5.
2. The EUT was placed in a temperature chamber at $20\pm 5^{\circ}\text{C}$ and connected with the system simulator.
3. The power supply voltage to the EUT was varied from 85% to 115% of the nominal value for other than hand carried battery equipment.
4. For hand carried, battery powered equipment, reduce the primary ac or dc supply voltage to the battery operating end point, which shall be specified by the manufacturer.
5. The variation in frequency was measured for the worst case.

4 Radiated Test Items

4.1 Measuring Instruments

See list of measuring instruments of this test report.

4.2 Test Setup

4.2.1 For radiated test from 30MHz to 1GHz

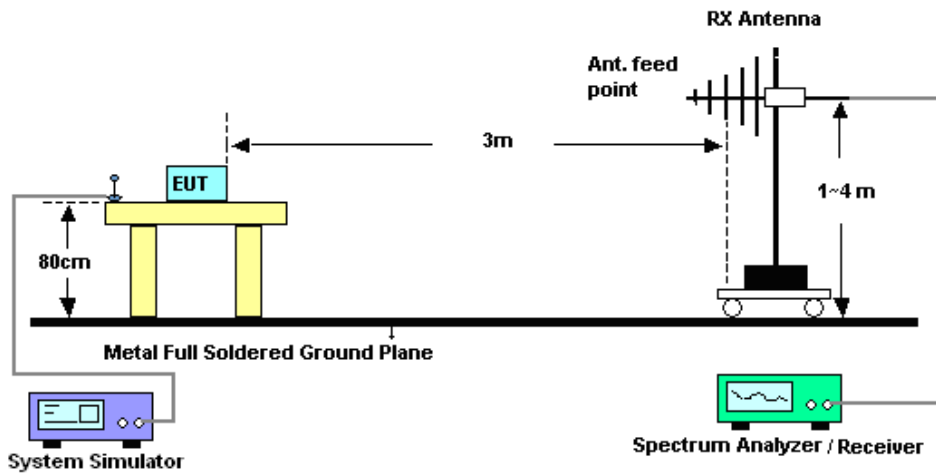

4.2.2 For radiated test above 1GHz

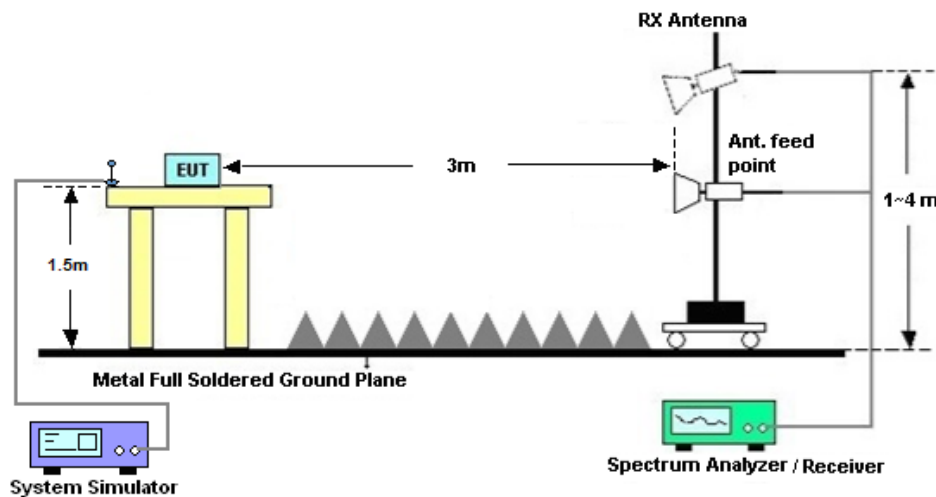

4.3 Test Result of Radiated Test

Please refer to Appendix B.

4.4 Radiated Spurious Emission Measurement

4.4.1 Description of Radiated Spurious Emission

The radiated spurious emission was measured by substitution method according to ANSI/TIA-603-E. The power of any emission outside of the authorized operating frequency ranges must be attenuated below the transmitter power (P) by a factor of at least $70 + 10 \log(P)$ dB.

The spectrum is scanned from 30 MHz up to a frequency including its 10th harmonic.

4.4.2 Test Procedures

1. The testing follows ANSI C63.26 Section 5.5
2. The EUT was placed on a turntable with 0.8 meter height for frequency below 1GHz and 1.5 meter height for frequency above 1GHz respectively above ground.
3. The EUT was set 3 meters from the receiving antenna mounted on the antenna tower.
4. The table was rotated 360 degrees to determine the position of the highest spurious emission.
5. The height of the receiving antenna is varied between 1m to 4m to search the maximum spurious emission for both horizontal and vertical polarizations.
6. During the measurement, the system simulator parameters were set to force the EUT transmitting at maximum output power.
7. Make the measurement with the spectrum analyzer's RBW = 1MHz, VBW = 3MHz, taking the record of maximum spurious emission.
8. A horn antenna was substituted in place of the EUT and was driven by a signal generator.
9. Tune the output power of signal generator to the same emission level with EUT maximum spurious emission.

$$\text{EIRP (dBm)} = \text{S.G. Power} - \text{Tx Cable Loss} + \text{Tx Antenna Gain}$$

$$\text{ERP (dBm)} = \text{EIRP} - 2.15$$

10. The RF fundamental frequency should be excluded against the limit line in the operating frequency band.

The limit line is derived from $70 + 10\log(P)$ dB below the transmitter power P(Watts)

$$= P(W) - [70 + 10\log(P)] \text{ (dB)}$$

$$= [30 + 10\log(P)] \text{ (dBm)} - [70 + 10\log(P)] \text{ (dB)}$$

$$= -40\text{dBm.}$$



5 List of Measuring Equipment

Instrument	Manufacturer	Model No.	Serial No.	Characteristics	Calibration Date	Test Date	Due Date	Remark
Spectrum Analyzer	R&S	FSV40	101040	10Hz~40GHz	Aug. 06, 2019	Jan. 08, 2020	Aug. 05, 2020	Conducted (TH01-KS)
Thermal Chamber	Ten Billion	TTC-B3S	TBN-960502	-40~+150°C	Nov. 19, 2018	Jan. 08, 2020	Nov. 18, 2019	Conducted (TH01-KS)
EXA Spectrum Analyzer	Keysight	N9010A	MY55150244	10Hz-44G,MAX 30dB	Apr.16, 2019	Jan. 12, 2020	Apr. 15, 2020	Radiation (03CH04-KS)
Bilog Antenna	TeseQ	CBL6111D	49922	30MHz-1GHz	May 30, 2019	Jan. 12, 2020	May 29, 2020	Radiation (03CH04-KS)
Horn Antenna	Schwarzbeck	BBHA9120D	1648	1GHz~18GHz	Jan. 27, 2019	Jan. 12, 2020	Jan. 26, 2020	Radiation (03CH04-KS)
SHF-EHF Horn	Com-power	AH-840	101070	18GHz~40GHz	Jan. 05, 2019	Jan. 12, 2020	Jan.04, 2020	Radiation (03CH04-KS)
Amplifier	SONOMA	310N	187289	9KHz-1GHz	Aug..06.2019	Jan. 12, 2020	Aug.05.2020	Radiation (03CH04-KS)
Amplifier	MITEQ	TTA1840-35-HG	2014749	18~40GHz	Jan. 14, 2019	Jan. 12, 2020	Jan.13, 2020	Radiation (03CH04-KS)
high gain Amplifier	MITEQ	AMF-7D-00 101800-30-1 OP	2025788	1Ghz-18Ghz	Aug.16.2019	Jan. 12, 2020	Aug.15,2020	Radiation (03CH04-KS)
Amplifier	Keysight	83017A	MY57280106	500MHz~26.5GHz	Apr. 15, 2019	Jan. 12, 2020	Apr. 14, 2020	Radiation (03CH04-KS)
AC Power Source	Chroma	61601	F104090004	N/A	NCR	Jan. 12, 2020	NCR	Radiation (03CH04-KS)
Turn Table	ChamPro	EM 1000-T	060762-T	0~360 degree	NCR	Jan. 12, 2020	NCR	Radiation (03CH04-KS)
Antenna Mast	ChamPro	EM 1000-A	060762-A	1 m~4 m	NCR	Jan. 12, 2020	NCR	Radiation (03CH04-KS)

NCR: No Calibration Required

6 Uncertainty of Evaluation

The measurement uncertainties shown below were calculated in accordance with the requirements of ANSI 63.26-2015. All the measurement uncertainty value were shown with a coverage $K=2$ to indicate 95% level of confidence. The measurement data show herein meets or exceeds the CISPR measurement uncertainty values specified in CISPR 16-4-2 and can be compared directly to specified limit to determine compliance.

Uncertainty of Radiated Emission Measurement (30 MHz ~ 1000 MHz)

Measuring Uncertainty for a Level of Confidence of 95% ($U = 2Uc(y)$)	3.30dB
---	--------

Uncertainty of Radiated Emission Measurement (1 GHz ~ 40 GHz)

Measuring Uncertainty for a Level of Confidence of 95% ($U = 2Uc(y)$)	2.80dB
---	--------



Appendix A. Test Results of Conducted Test

Conducted Output Power(Average power)

LTE Band 30 Maximum Average Power [dBm]						
BW [MHz]	RB Size	RB Offset	Mod	Lowest	Middle	Highest
5	1	0	QPSK	22.41	22.5	22.45
5	1	12		22.36	22.37	22.34
5	1	24		22.38	22.39	22.36
5	12	0		21.45	21.47	21.49
5	12	7		21.52	21.49	21.55
5	12	13		21.48	21.48	21.37
5	25	0		21.45	21.49	21.49
5	1	0	16-QAM	21.71	21.86	21.71
5	1	12		21.79	21.65	21.64
5	1	24		21.75	21.82	21.74
5	12	0		20.59	20.61	20.62
5	12	7		20.6	20.6	20.63
5	12	13		20.57	20.59	20.5
5	25	0		20.58	20.58	20.59
5	1	0	64QAM	20.71	20.69	20.68
5	1	12		20.65	20.67	20.64
5	1	24		20.67	20.72	20.63
5	12	0		19.64	19.69	19.65
5	12	7		19.61	19.65	19.7
5	12	13		19.61	19.64	19.54
5	25	0		19.54	19.6	19.61



10	1	0	QPSK	-	22.47	-
10	1	25			22.39	
10	1	49			22.3	
10	25	0			21.53	
10	25	12			21.52	
10	25	25			21.47	
10	50	0			21.45	
10	1	0	16-QAM		21.8	
10	1	25			21.68	
10	1	49			21.61	
10	25	0			20.59	
10	25	12			20.59	
10	25	25			20.59	
10	50	0			20.59	
10	1	0	64QAM		20.69	
10	1	25			20.63	
10	1	49			20.53	
10	25	0			19.61	
10	25	12			19.61	
10	25	25			19.57	
10	50	0			19.61	



LTE Band 30

Peak-to-Average Ratio

Mode	LTE Band 30 / 10MHz				
Mod.	QPSK		16QAM		Limit: 13dB
RB Size	1RB	Full RB	1RB	Full RB	Result
Lowest CH	-	-	-	-	PASS
Middle CH	3.57	4.38	5.19	5.86	
Highest CH	-	-	-	-	
Mod.	64QAM		Limit: 13dB		
RB Size	1RB	Full RB	Result		
Lowest CH			PASS		
Middle CH	5.62	6.43			
Highest CH					

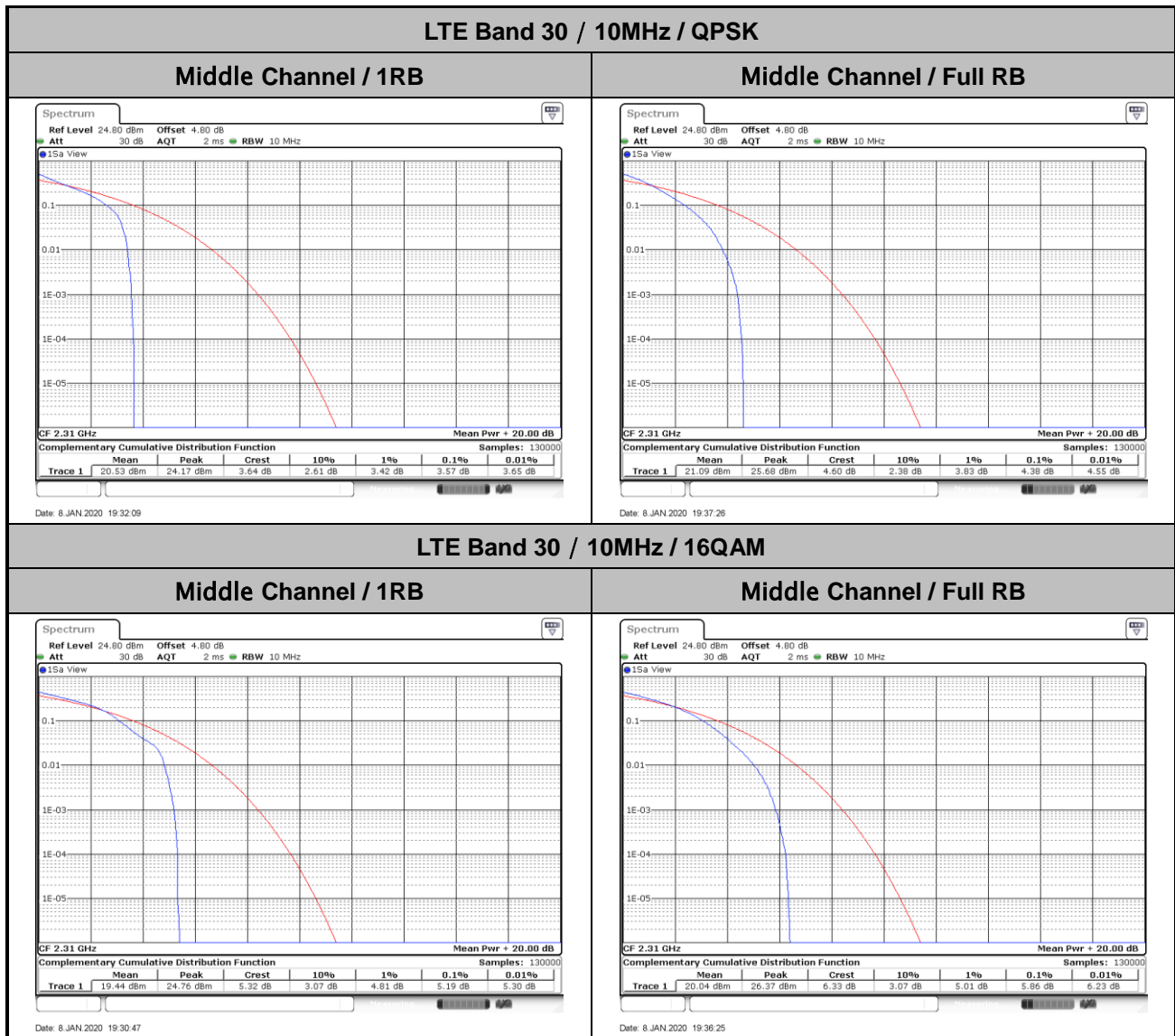

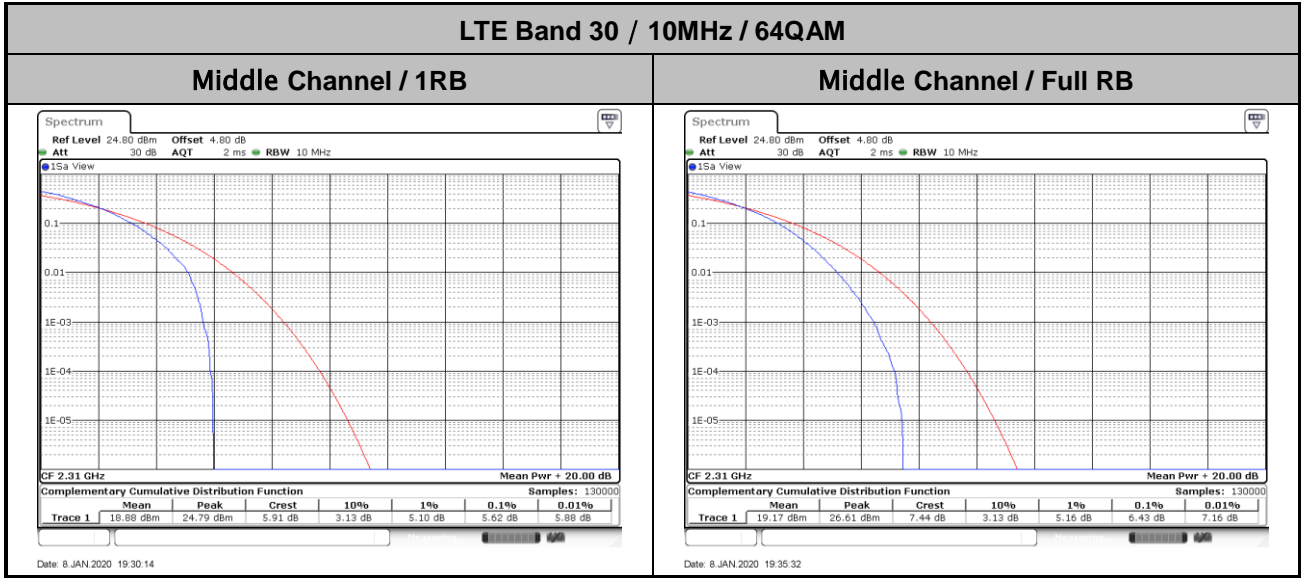



EIRP Power Density

Mode	LTE Band 30 : Conducted Power Density (dBm/5MHz)									
	5MHz		10MHz		5MHz		10MHz			
Mod.	QPSK	16QAM	QPSK	16QAM	64QAM		64QAM			
Lowest CH	23.39	22.58			21.79					
Middle CH	23.19	22.51	23.19	22.37	21.54		21.51			
Highest CH	23.30	22.77			21.75					

Mode	LTE Band 30 : EIRP Power Density (dBm/5MHz)									
	5MHz		10MHz		5MHz		10MHz			
Mod.	QPSK	16QAM	QPSK	16QAM	64QAM		64QAM			
Lowest CH	23.39	22.58			21.79					
Middle CH	23.19	22.51	23.19	22.37	21.54		21.51			
Highest CH	23.30	22.77			21.75					
Antenna Gain	0 dBi									
Limit	250mW / 5MHz = 24dBm / 5MHz									
Result	Pass									



LTE Band 30 / 5MHz

Lowest Channel / 5MHz / 1RB0 / QPSK

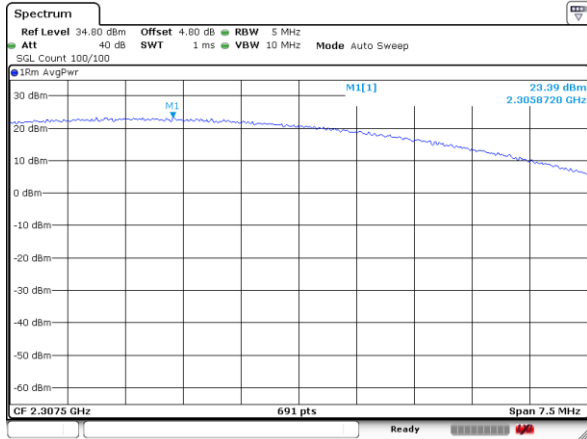

Date: 8 JAN 2020 19:45:37

Lowest Channel / 5MHz / 1RB0 / 16QAM

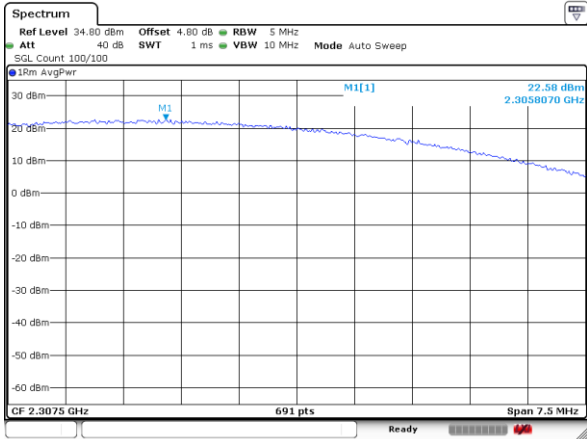

Date: 8 JAN 2020 19:45:59

Middle Channel / 5MHz / 1RB0 / QPSK

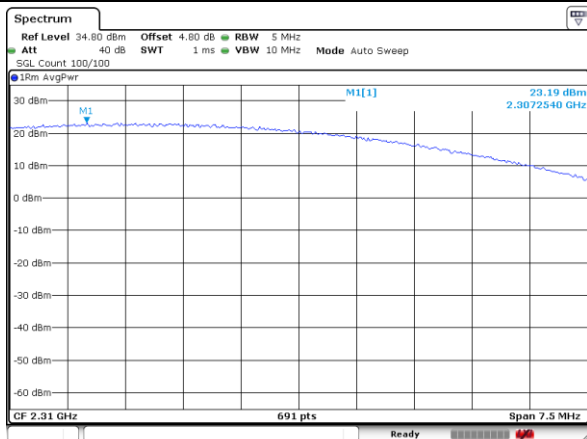

Date: 8 JAN 2020 19:44:53

Middle Channel / 5MHz / 1RB0 / 16QAM

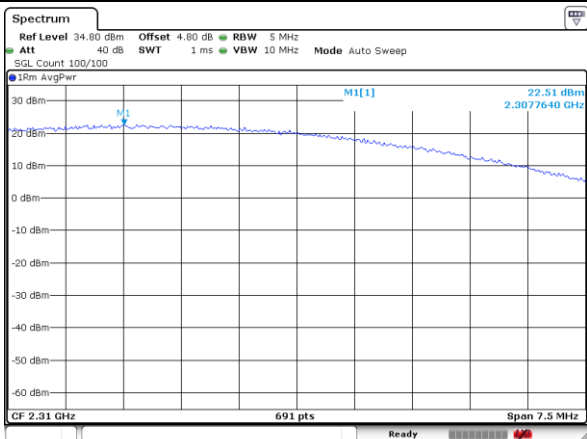

Date: 8 JAN 2020 19:44:33

Highest Channel / 5MHz / 1RB0 / QPSK

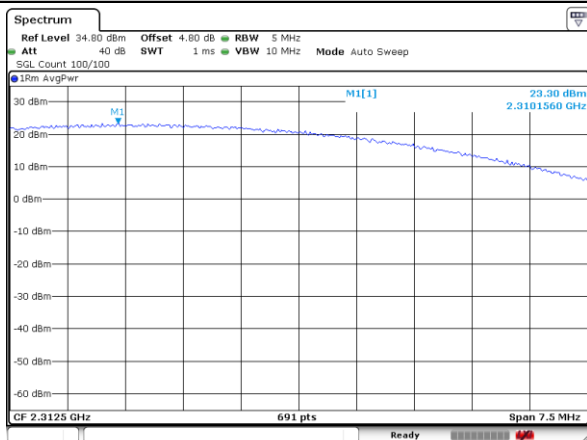

Date: 8 JAN 2020 19:47:18

Highest Channel / 5MHz / 1RB0 / 16QAM

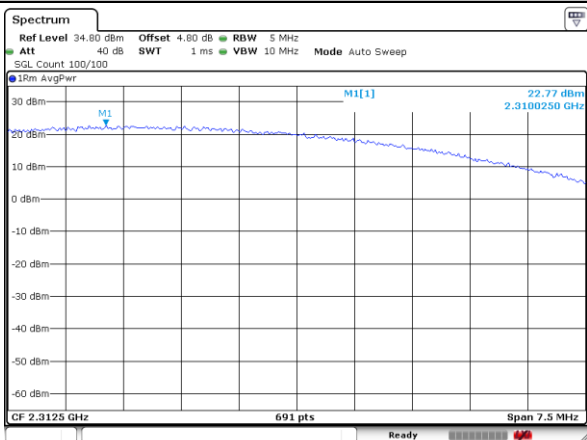

Date: 8 JAN 2020 19:47:06



LTE Band 30 / 5MHz

Lowest Channel / 5MHz / 1RB0 / 64QAM

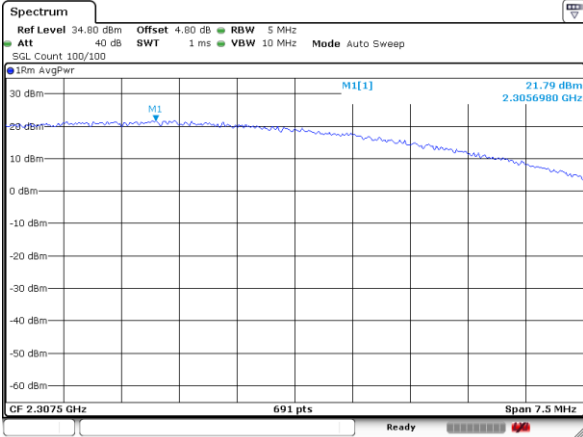

Date: 8 JAN 2020 19:46:15

Middle Channel / 5MHz / 1RB0 / 64QAM

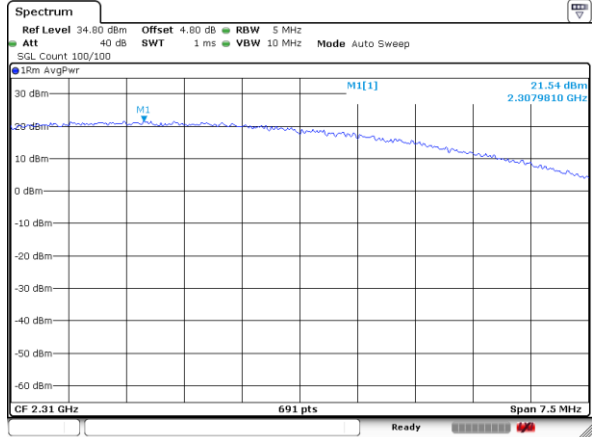

Date: 8 JAN 2020 19:44:10

Highest Channel / 5MHz / 1RB0 / 64QAM

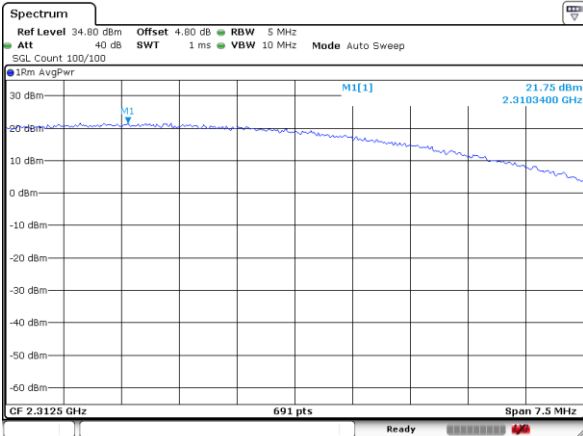

Date: 8 JAN 2020 19:46:47



LTE Band 30 / 10MHz

Lowest Channel / 10MHz / 1RB0 / QPSK

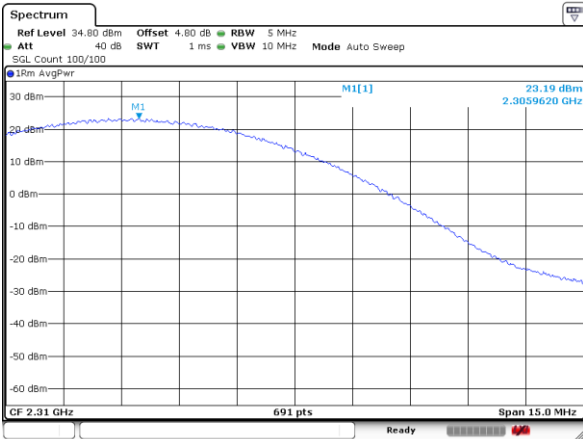

Date: 8 JAN 2020 19:42:20

Lowest Channel / 10MHz / 1RB0 / 16QAM

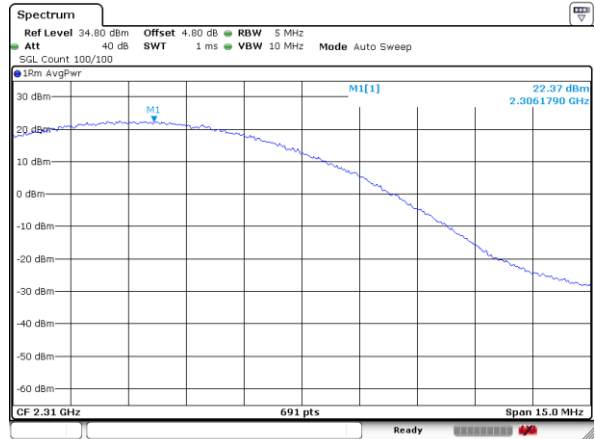

Date: 8 JAN 2020 19:42:54

Lowest Channel / 10MHz / 1RB0 / 64QAM

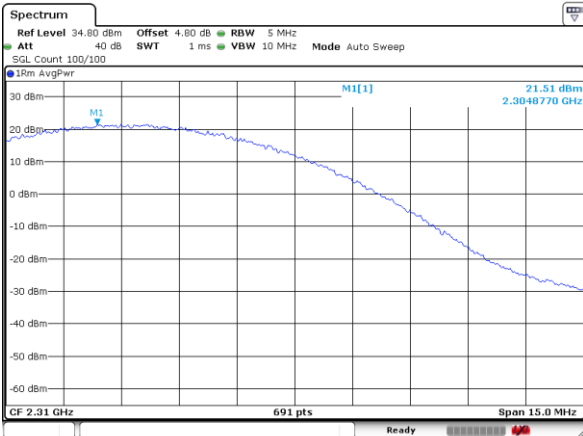

Date: 8 JAN 2020 19:43:09



26dB Bandwidth

Mode	LTE Band 30 : 26dB BW(MHz)											
	5MHz		10MHz		5MHz		10MHz					
Mod.	QPSK	16QAM	QPSK	16QAM	64QAM		64QAM					
Lowest CH	4.885	4.905			4.895							-
Middle CH	4.945	4.905	9.83	9.87	4.865		9.87					-
Highest CH	4.875	5.005			4.925							-



LTE Band 30

Lowest Channel / 5MHz / QPSK

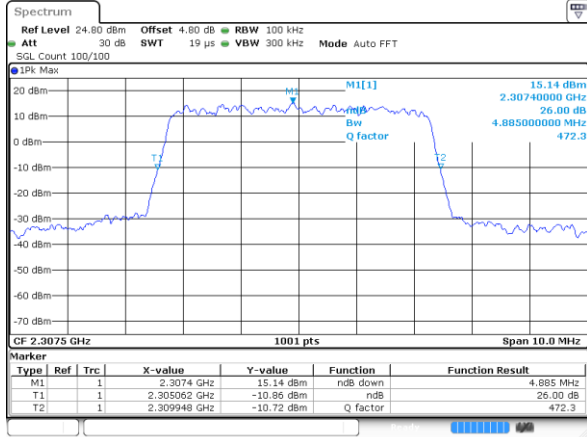

Date: 8 JAN 2020 19:25:40

Lowest Channel / 5MHz / 16QAM

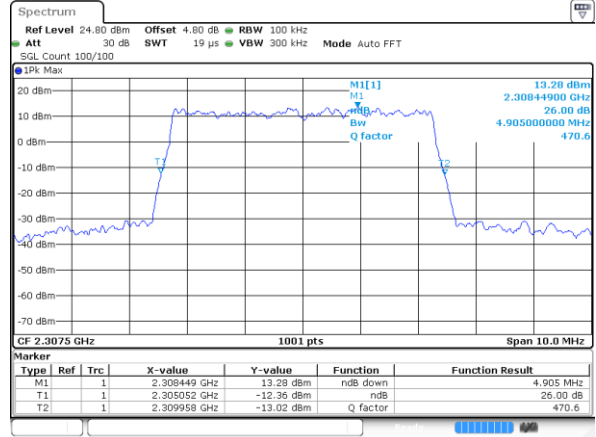

Date: 8 JAN 2020 19:26:37

Middle Channel / 5MHz / QPSK

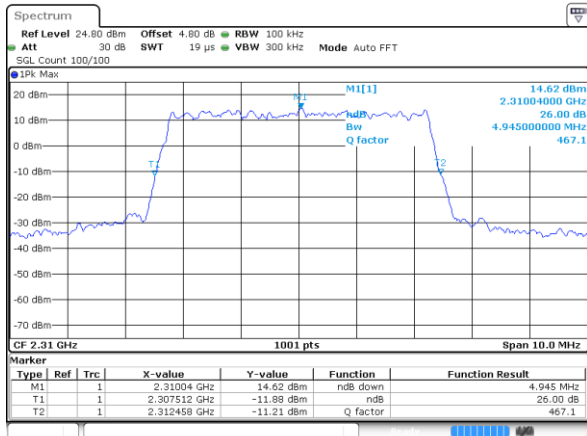

Date: 8 JAN 2020 19:25:20

Middle Channel / 5MHz / 16QAM

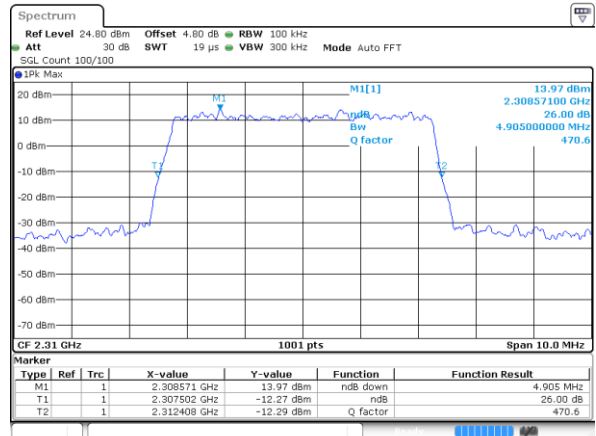

Date: 8 JAN 2020 19:25:00

Highest Channel / 5MHz / QPSK

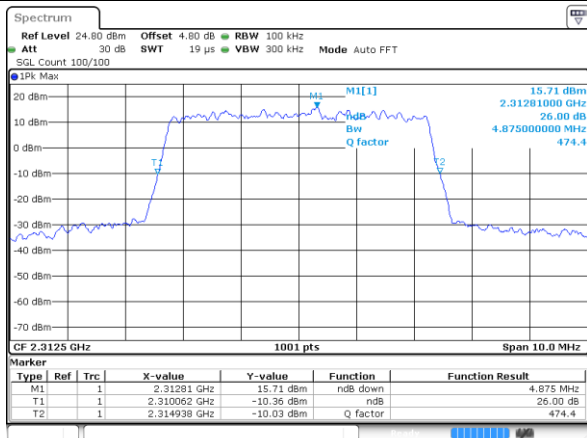

Date: 8 JAN 2020 19:10:15

Highest Channel / 5MHz / 16QAM

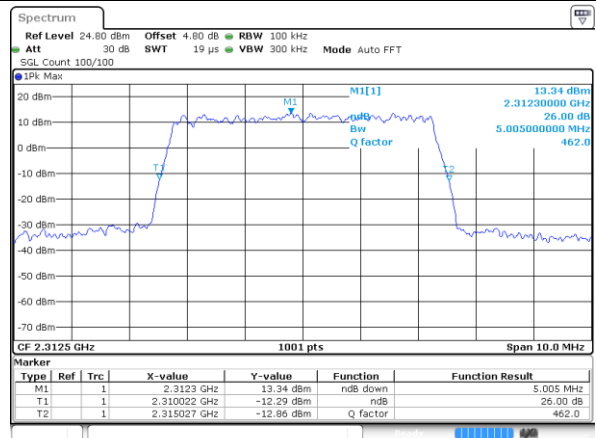

Date: 8 JAN 2020 19:11:32



LTE Band 30

Middle Channel / 10MHz / QPSK

Middle Channel / 10MHz / 16QAM

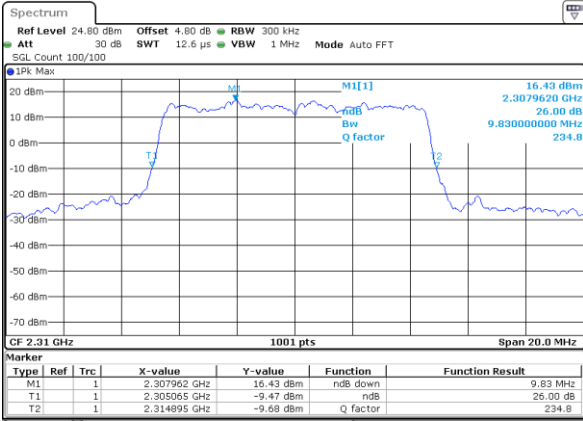

Date: 8 JAN 2020 19:37:46

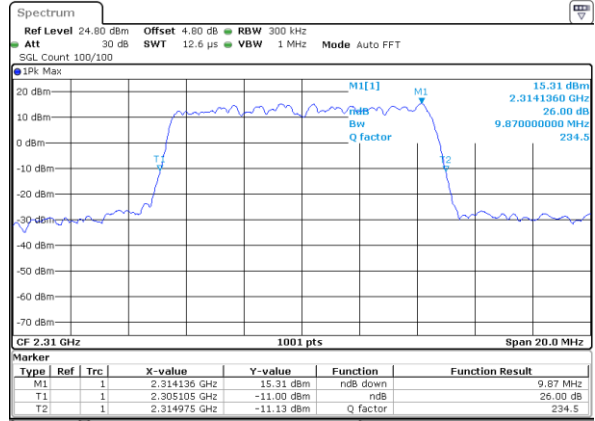

Date: 8 JAN 2020 19:36:48



LTE Band 30

Lowest Channel / 5MHz / 64QAM

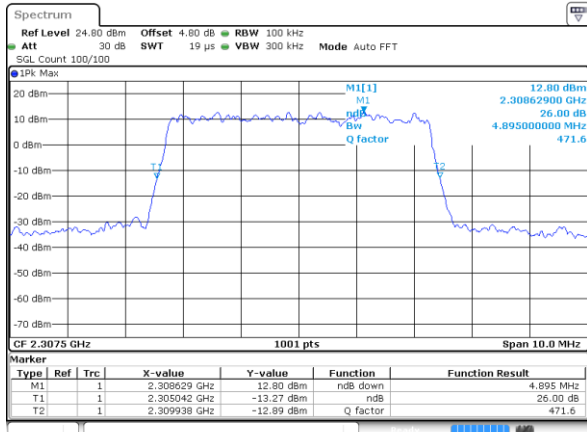

Date: 8 JAN 2020 19:27:55

Middle Channel / 5MHz / 64QAM

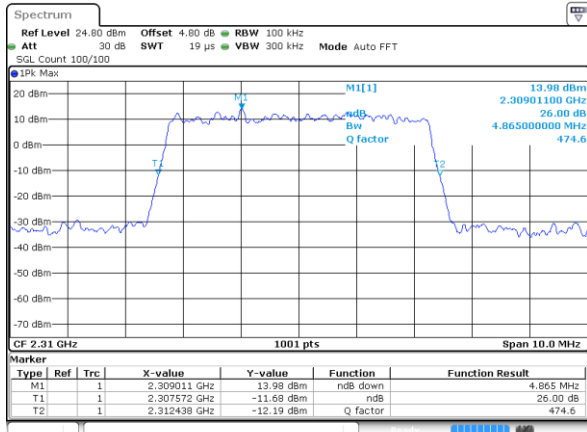

Date: 8 JAN 2020 19:14:15

Middle Channel / 10MHz / 64QAM

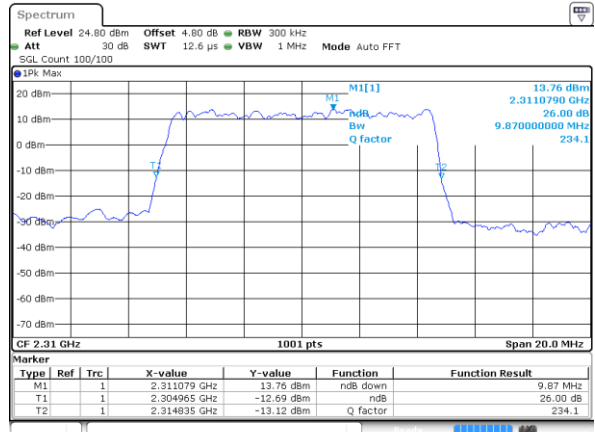

Date: 8 JAN 2020 19:35:52

Highest Channel / 5MHz / 64QAM

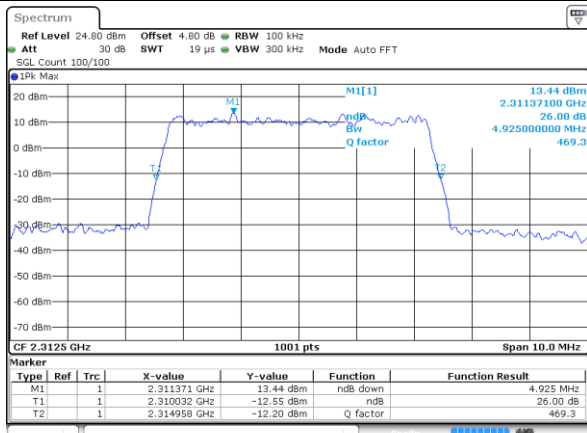

Date: 8 JAN 2020 19:12:41



Occupied Bandwidth

Mode	LTE Band 30 : 99%OBW(MHz)											
BW	5MHz		10MHz		5MHz		10MHz					
Mod.	QPSK	16QAM	QPSK	16QAM	64QAM		64QAM					
Lowest CH	4.49	4.50			4.49					-	-	-
Middle CH	4.47	4.50	9.03	9.01	4.50		9.05		-	-	-	-
Highest CH	4.51	4.52			4.51				-	-	-	-



LTE Band 30

Lowest Channel / 5MHz / QPSK

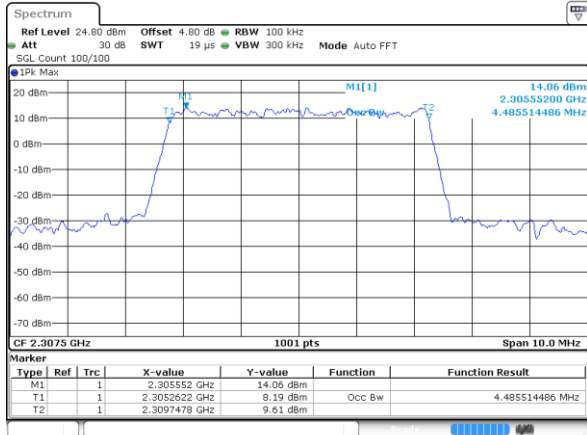

Date: 8 JAN 2020 19:25:32

Lowest Channel / 5MHz / 16QAM

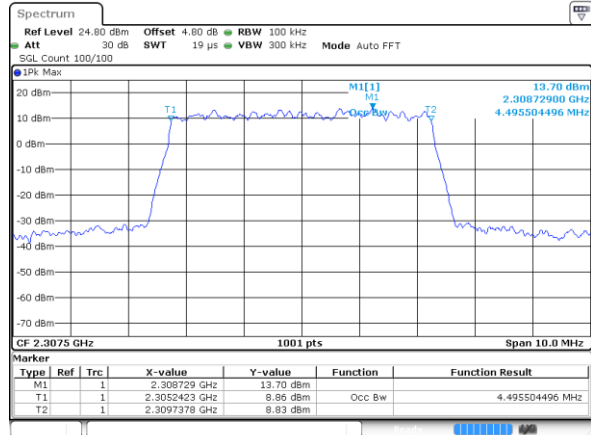

Date: 8 JAN 2020 19:26:27

Middle Channel / 5MHz / QPSK

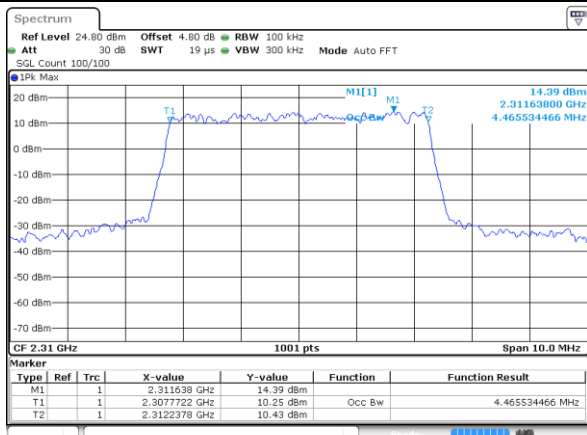

Date: 8 JAN 2020 19:25:10

Middle Channel / 5MHz / 16QAM

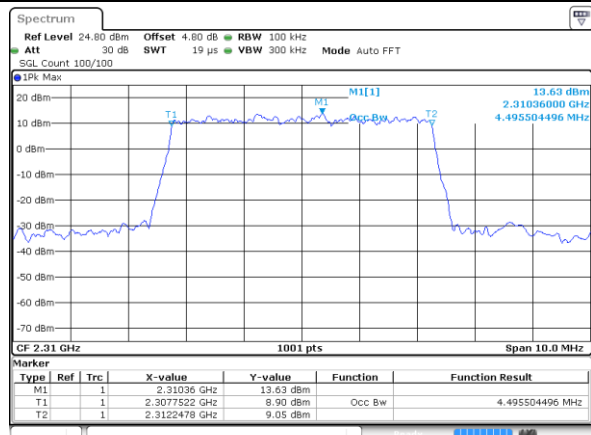

Date: 8 JAN 2020 19:24:52

Highest Channel / 5MHz / QPSK

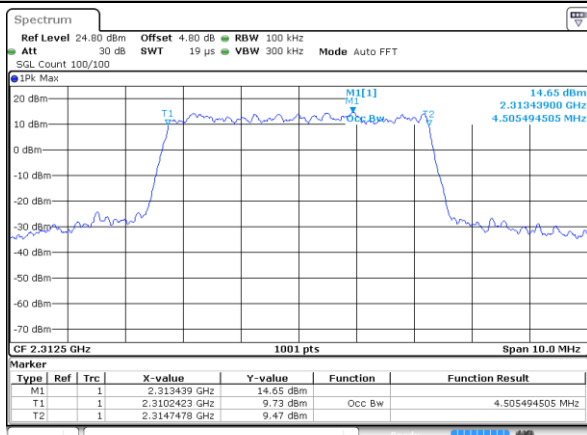

Date: 8 JAN 2020 19:10:07

Highest Channel / 5MHz / 16QAM

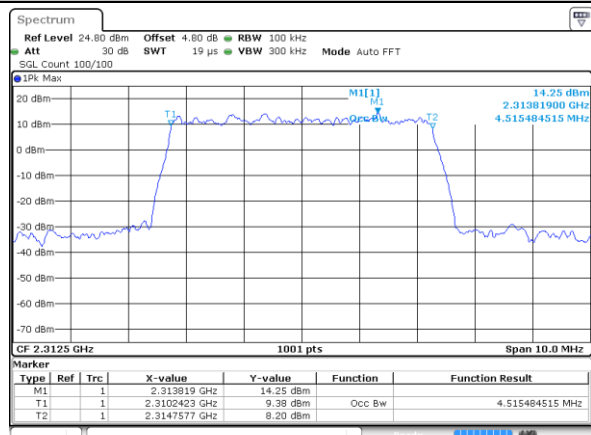

Date: 8 JAN 2020 19:11:41



LTE Band 30

Middle Channel / 10MHz / QPSK

Middle Channel / 10MHz / 16QAM

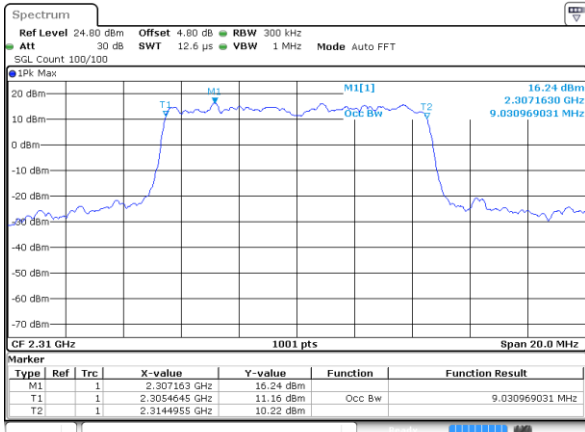

Date: 8 JAN 2020 19:37:35

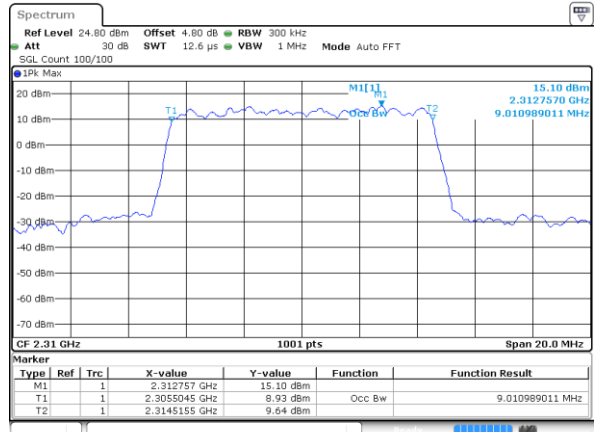

Date: 8 JAN 2020 19:36:35



LTE Band 30

Lowest Channel / 5MHz / 64QAM

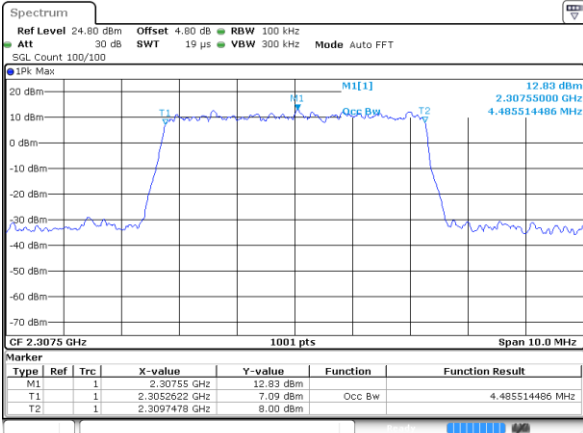

Date: 8 JAN 2020 19:27:46

Middle Channel / 5MHz / 64QAM

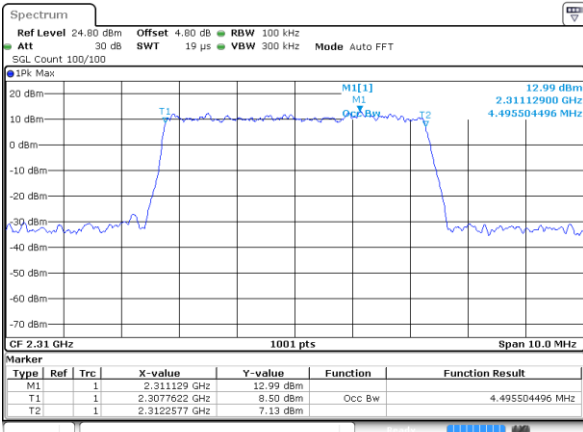

Date: 8 JAN 2020 19:14:06

Middle Channel / 10MHz / 64QAM

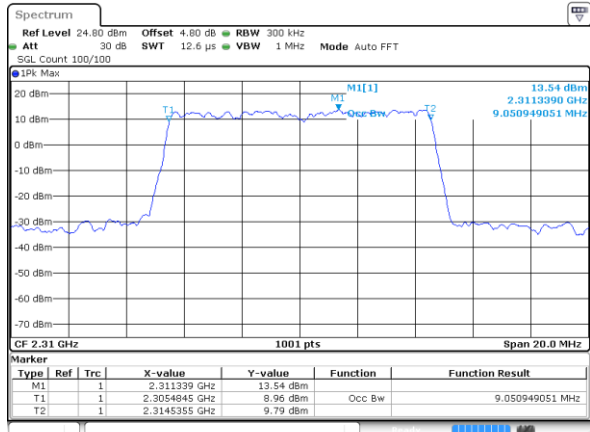

Date: 8 JAN 2020 19:35:41

Highest Channel / 5MHz / 64QAM

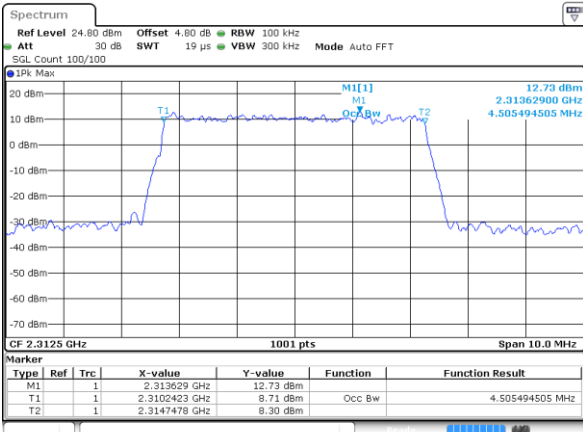

Date: 8 JAN 2020 19:12:00



SPORTON LAB.

Conducted Band Edge



LTE Band 30 / 5MHz / QPSK

Lowest Band Edge / 1 RB

Highest Band Edge / 1 RB

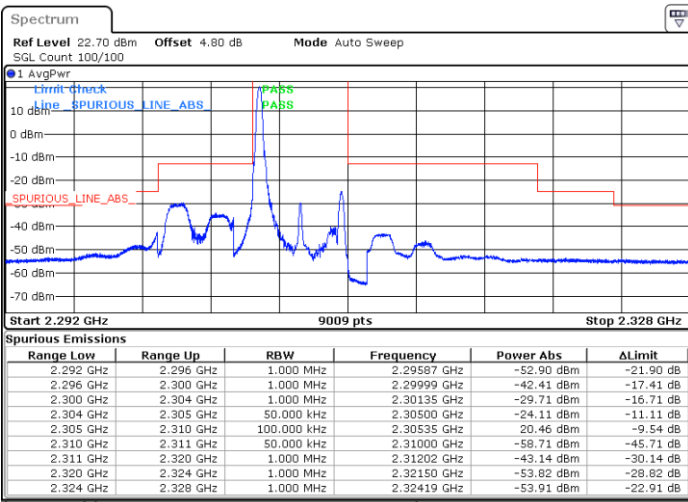

Date: 8 JAN 2020 18:56:59

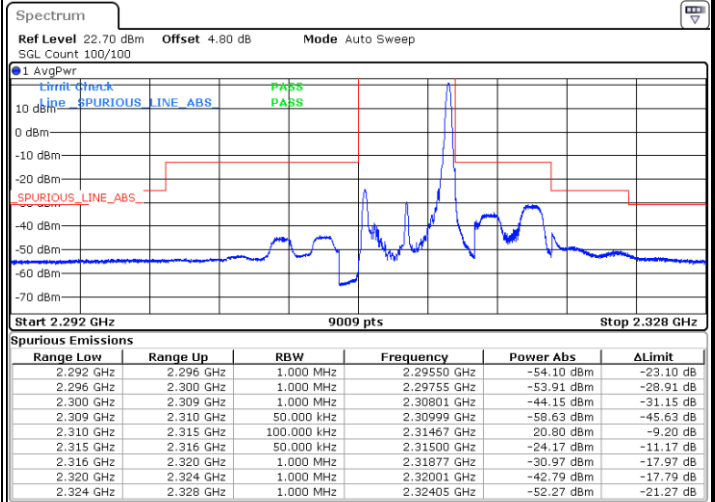

Date: 8 JAN 2020 19:09:54

Lowest Band Edge / Full RB

Highest Band Edge / Full RB

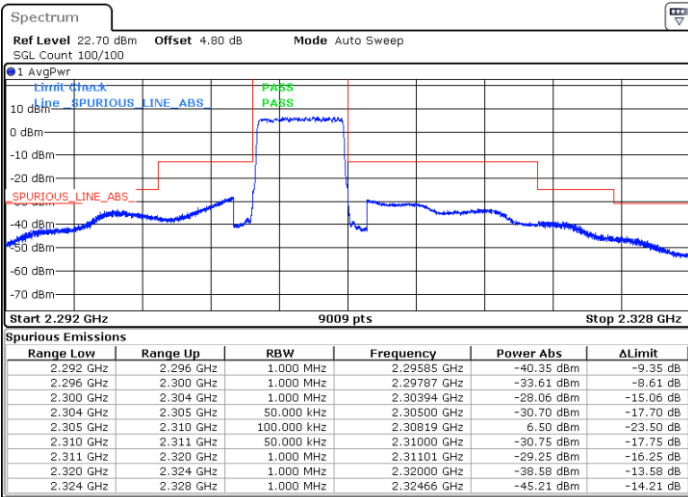

Date: 8 JAN 2020 19:26:16

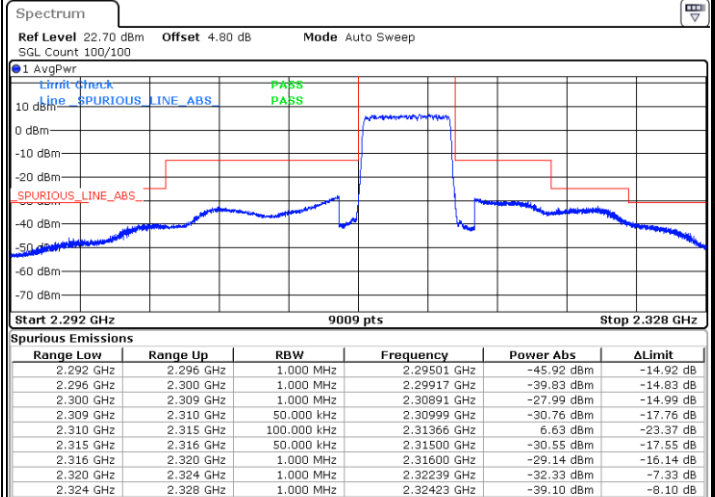

Date: 8 JAN 2020 19:10:47



LTE Band 30 / 5MHz / 16QAM

Lowest Band Edge / 1RB

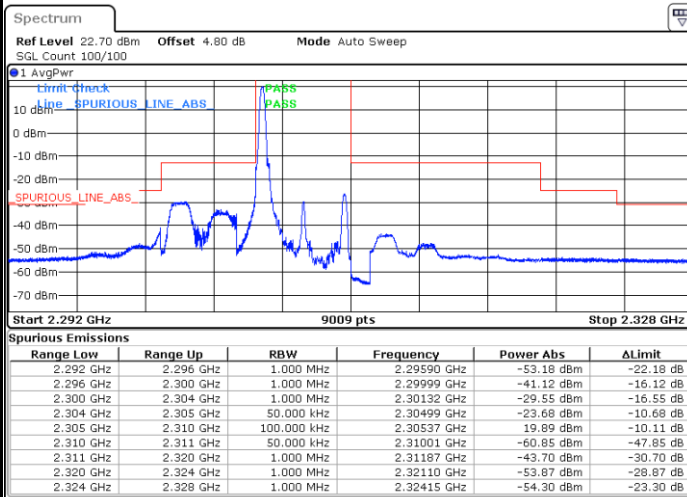

Date: 8 JAN 2020 18:57:45

Highest Band Edge / 1 RB

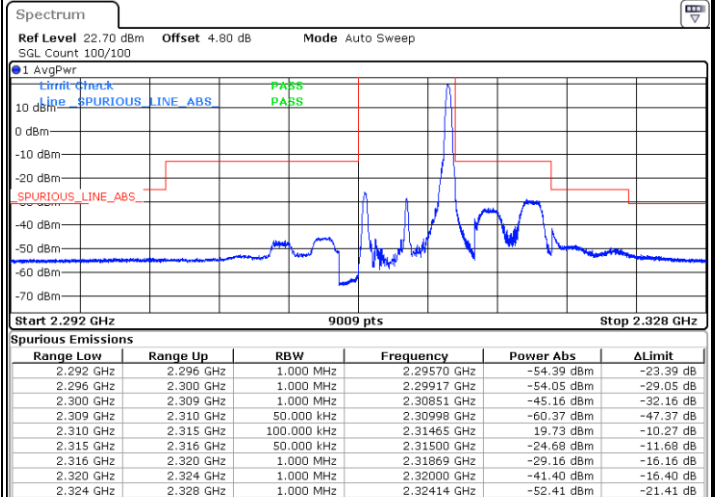

Date: 8 JAN 2020 19:09:22

Lowest Band Edge / Full RB

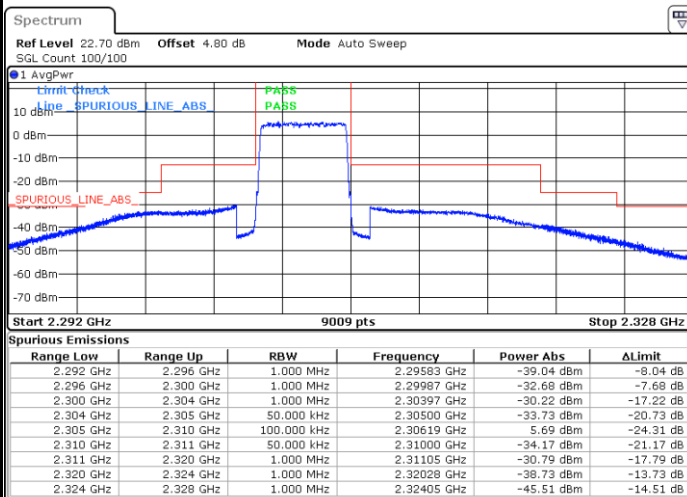

Date: 8 JAN 2020 19:27:32

Highest Band Edge / Full RB

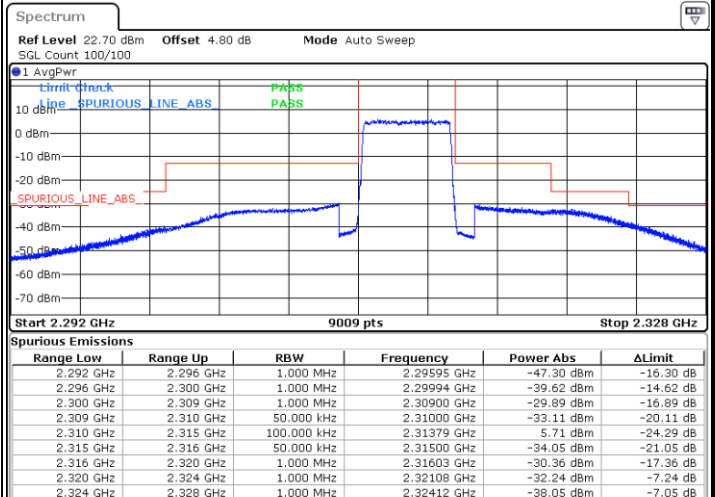

Date: 8 JAN 2020 19:11:19



LTE Band 30 / 5MHz / 64QAM

Lowest Band Edge / 1RB

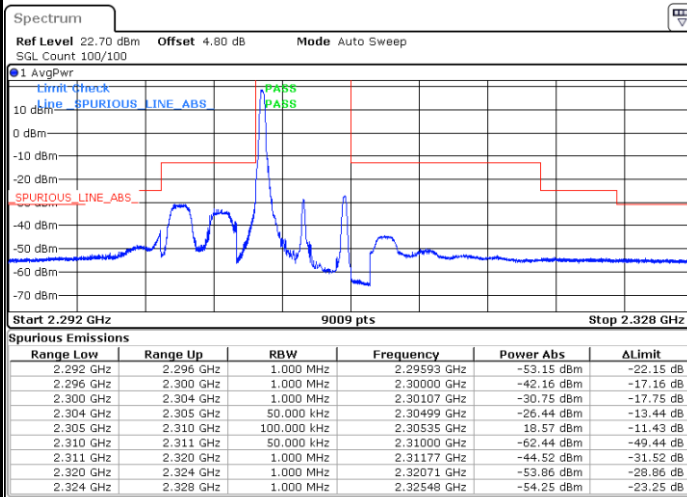

Date: 8 JAN 2020 18:59:31

Highest Band Edge / 1 RB

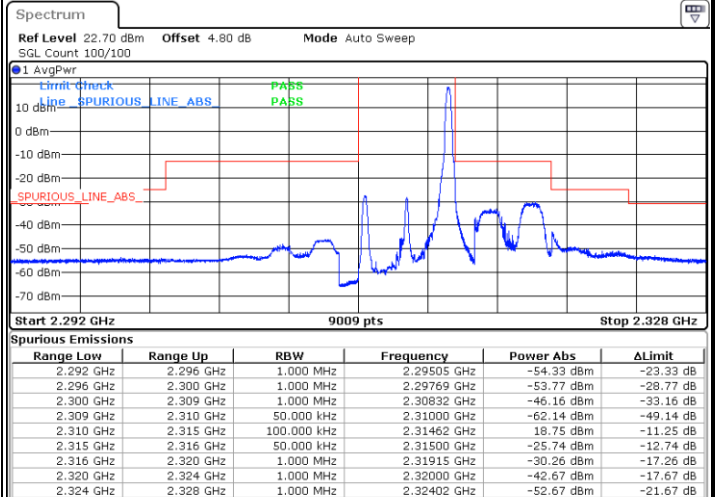

Date: 8 JAN 2020 19:08:25

Lowest Band Edge / Full RB

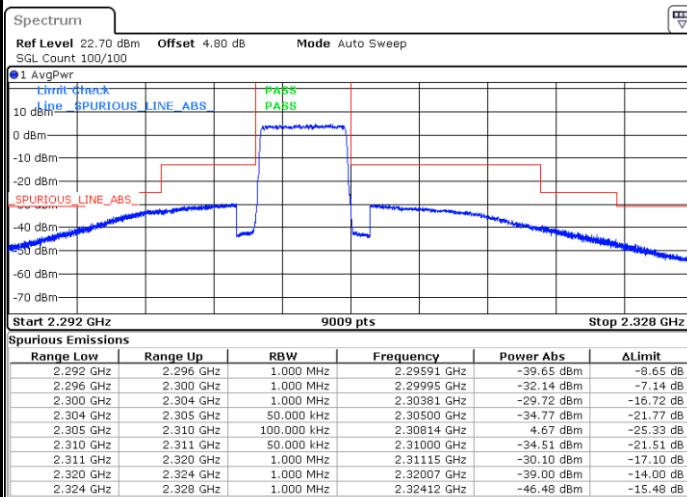

Date: 8 JAN 2020 19:28:26

Highest Band Edge / Full RB

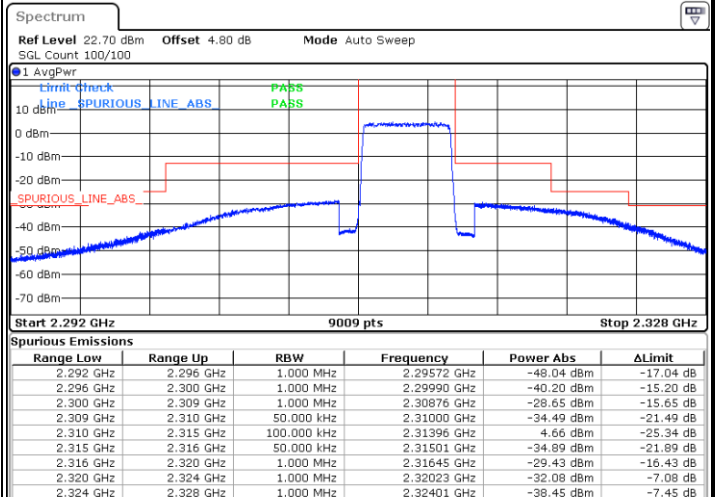

Date: 8 JAN 2020 19:29:08



LTE Band 30 / 10MHz / QPSK

Lowest Band Edge / 1 RB

Highest Band Edge / 1 RB

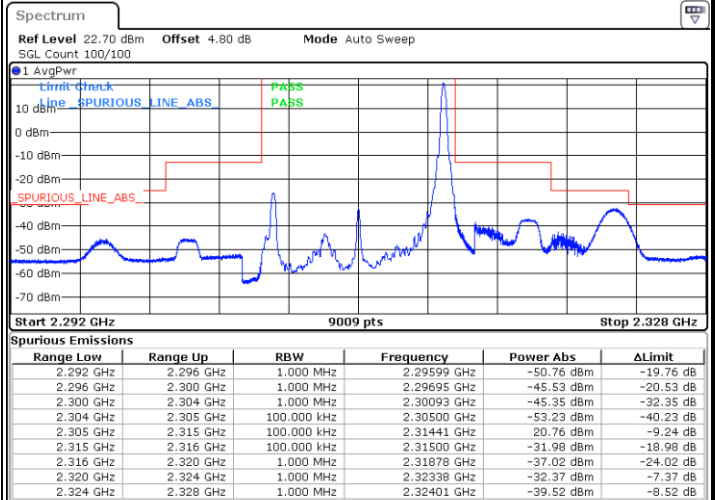
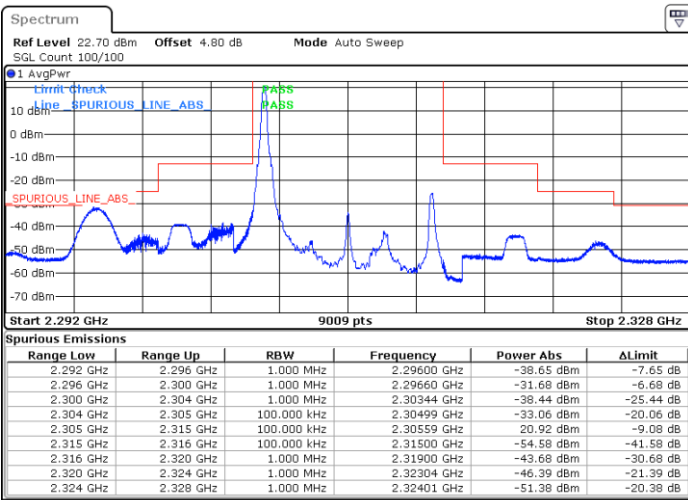

Date: 8 JAN 2020 19:32:28

Date: 8 JAN 2020 19:33:51

Band Edge / Full RB

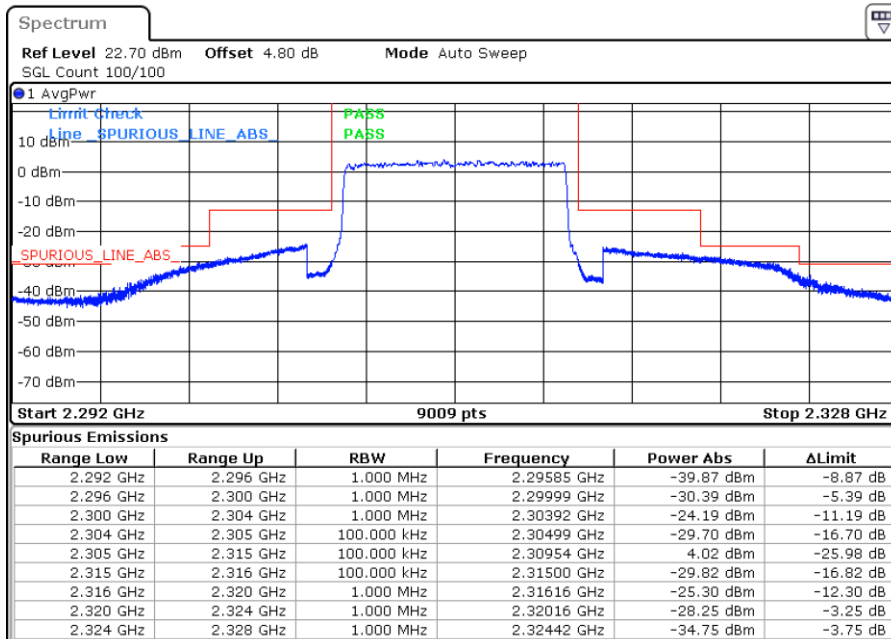

Date: 8 JAN 2020 19:38:05



LTE Band 30 / 10MHz / 16QAM

Lowest Band Edge / 1 RB

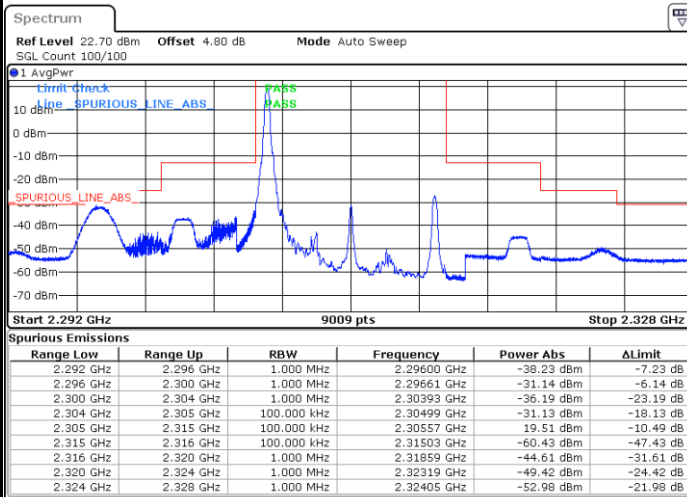

Date: 8 JAN 2020 19:31:06

Highest Band Edge / 1 RB

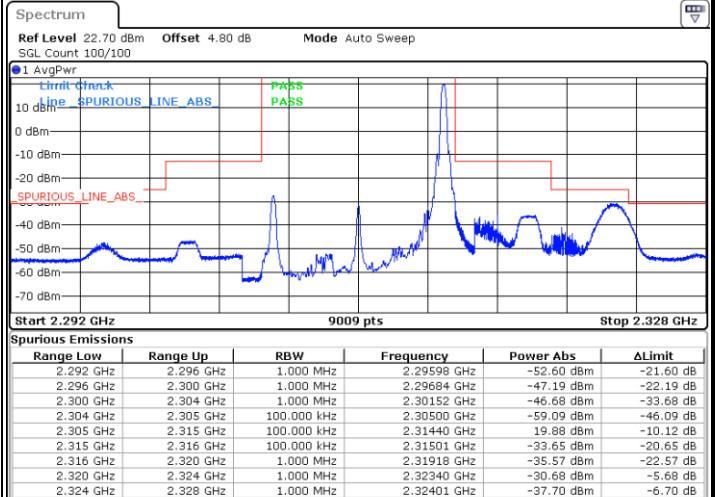

Date: 8 JAN 2020 19:34:53

Band Edge / Full RB

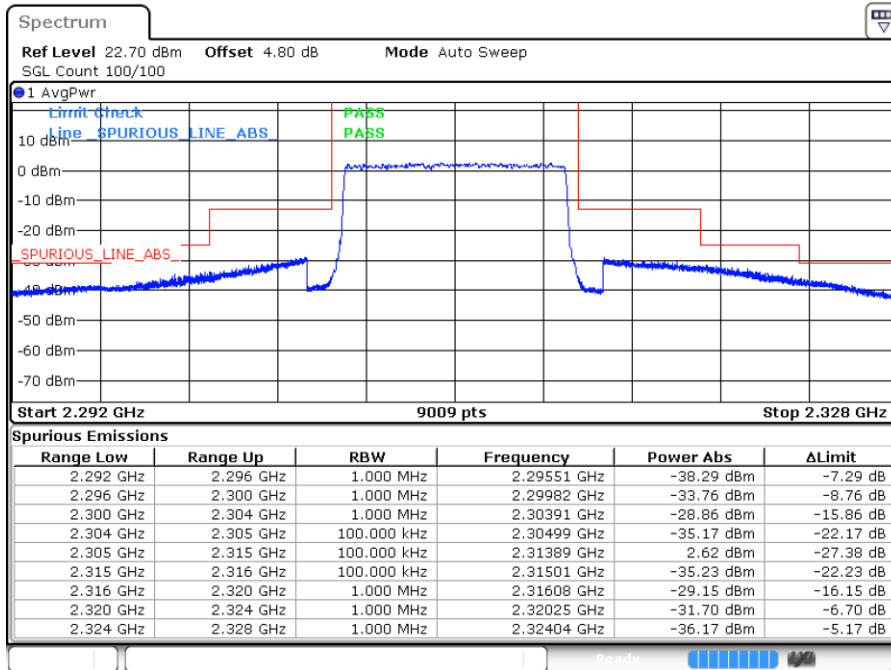

Date: 8 JAN 2020 19:37:08

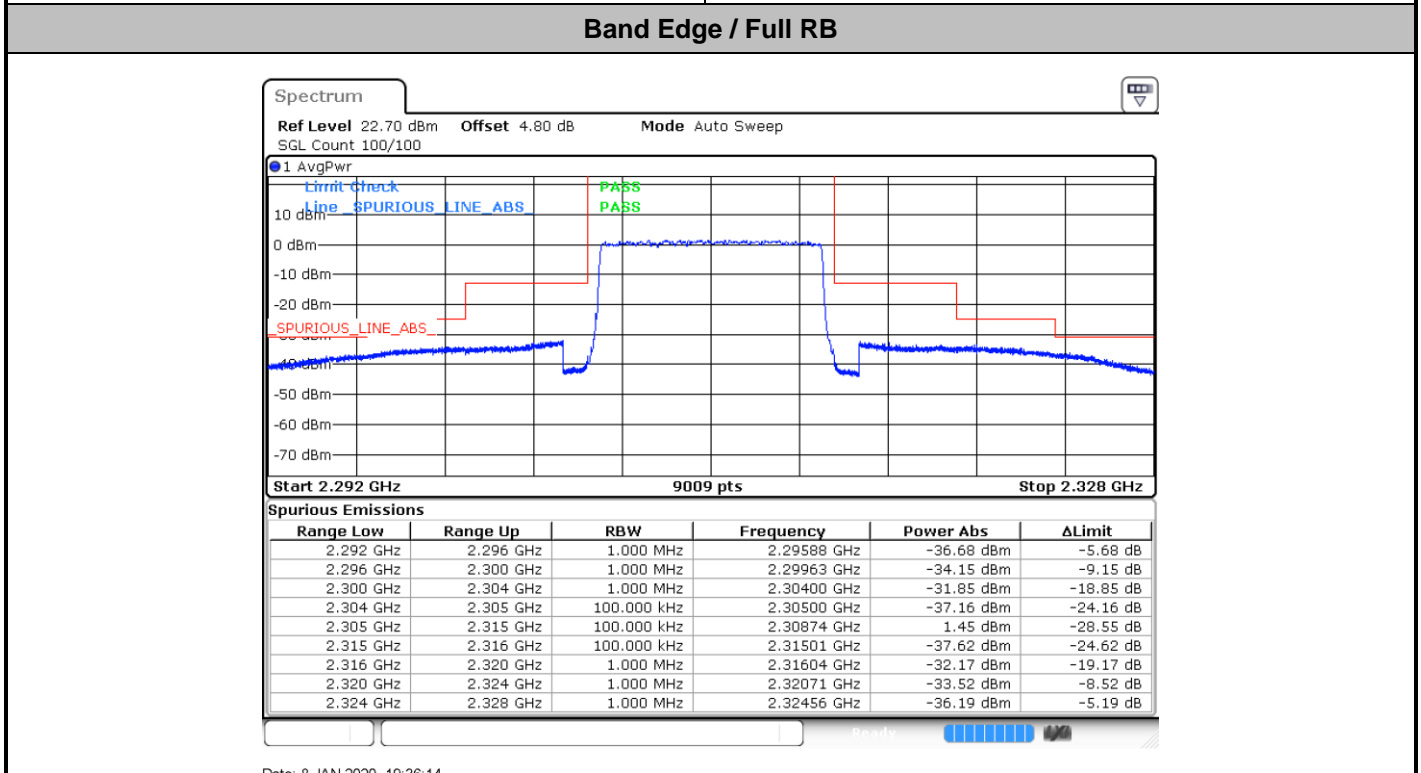
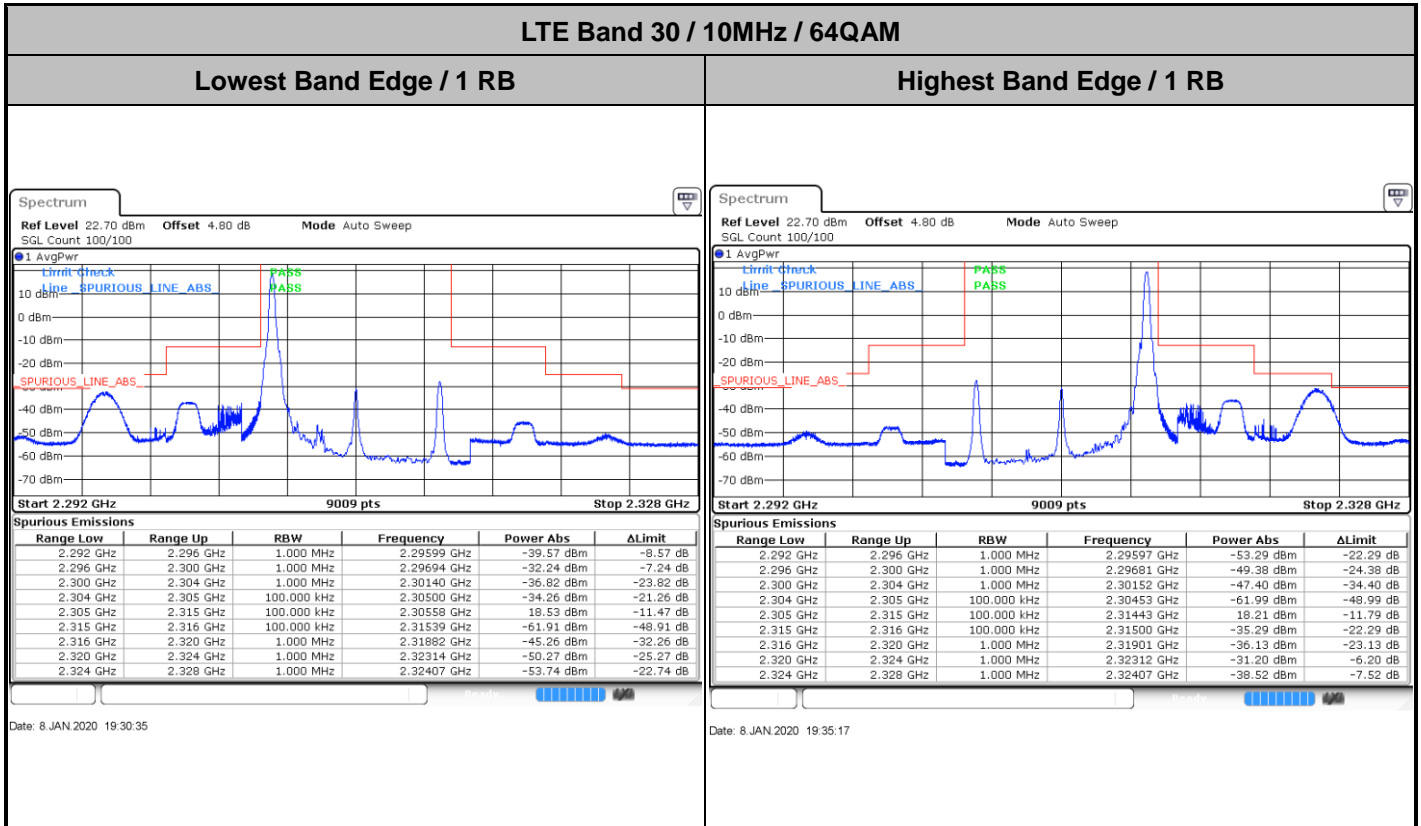



SPORTON LAB.

Conducted Spurious Emission



LTE Band 30 / 5MHz

Lowest Channel / QPSK

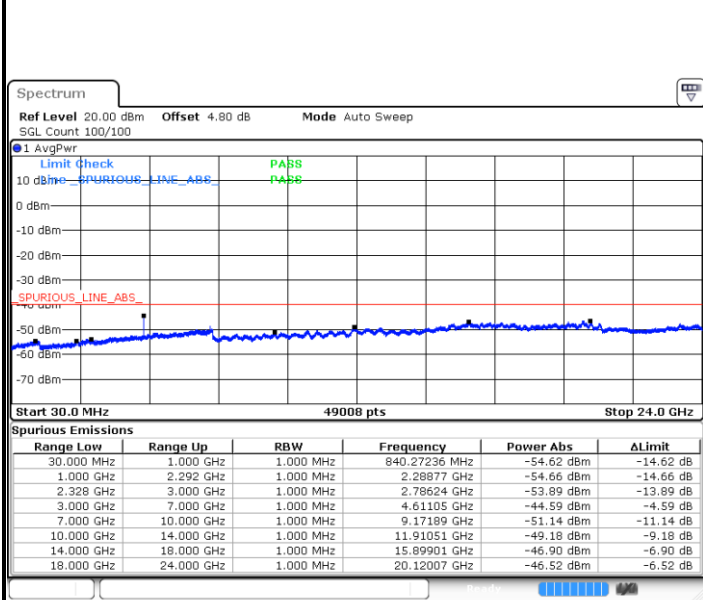

Date: 8 JAN 2020 18:53:50

Lowest Channel / 16QAM

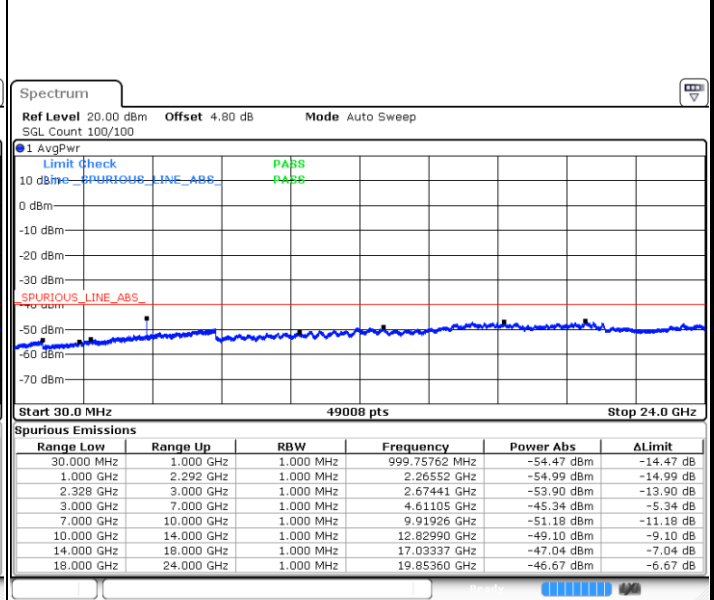

Date: 8 JAN 2020 18:58:48

Middle Channel / QPSK

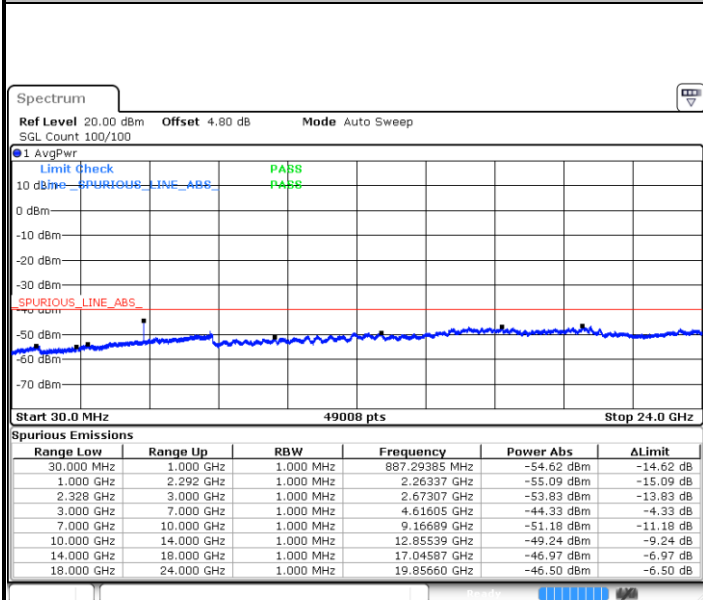

Date: 8 JAN 2020 19:03:31

Middle Channel / 16QAM

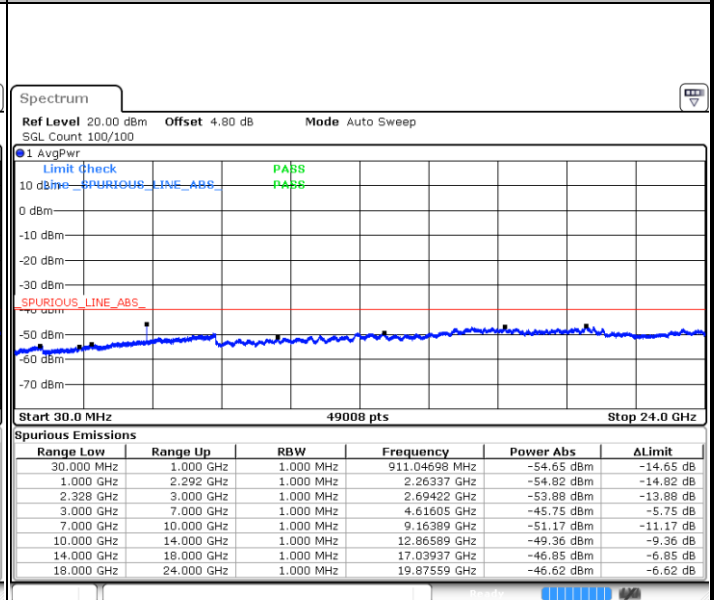

Date: 8 JAN 2020 19:01:58

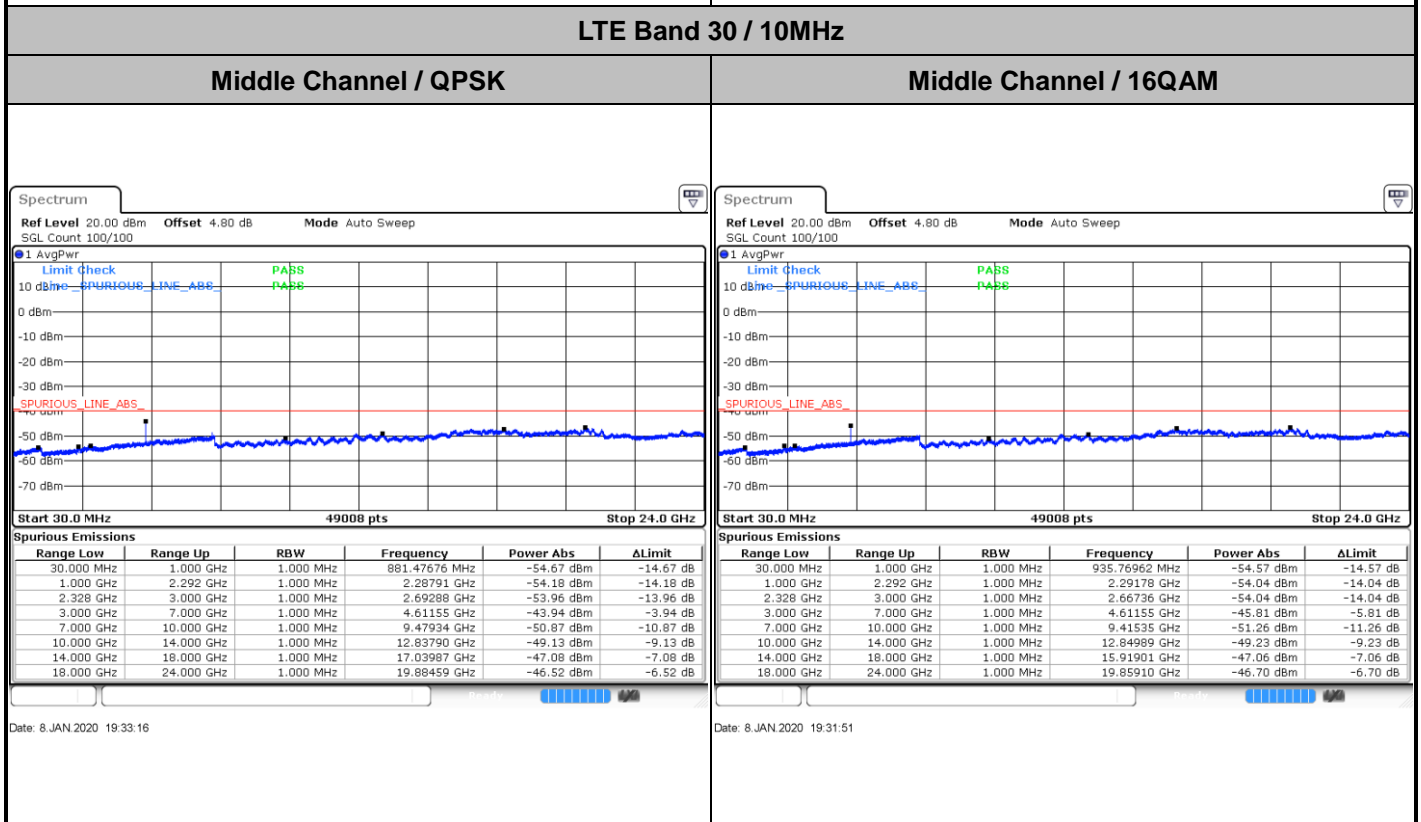
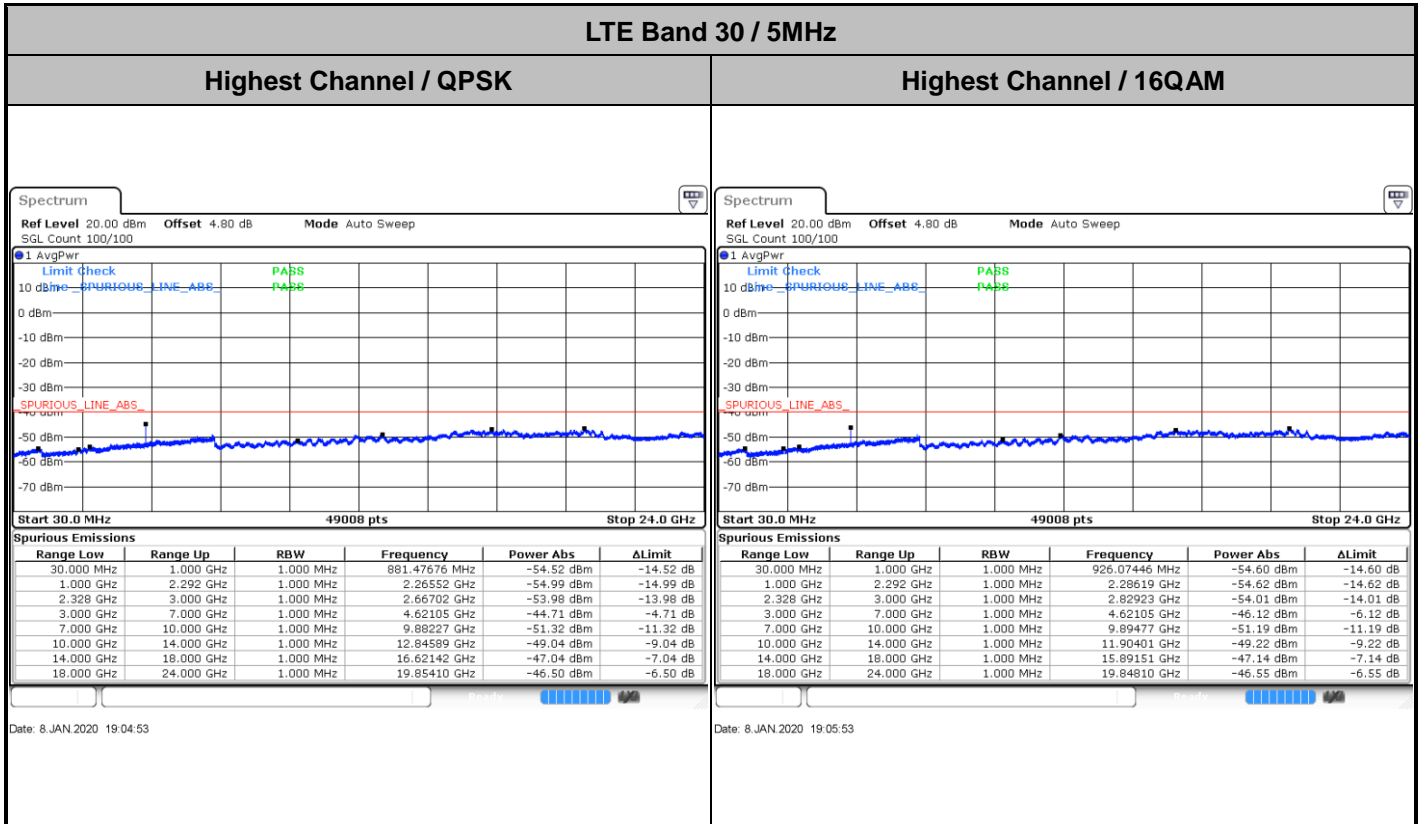

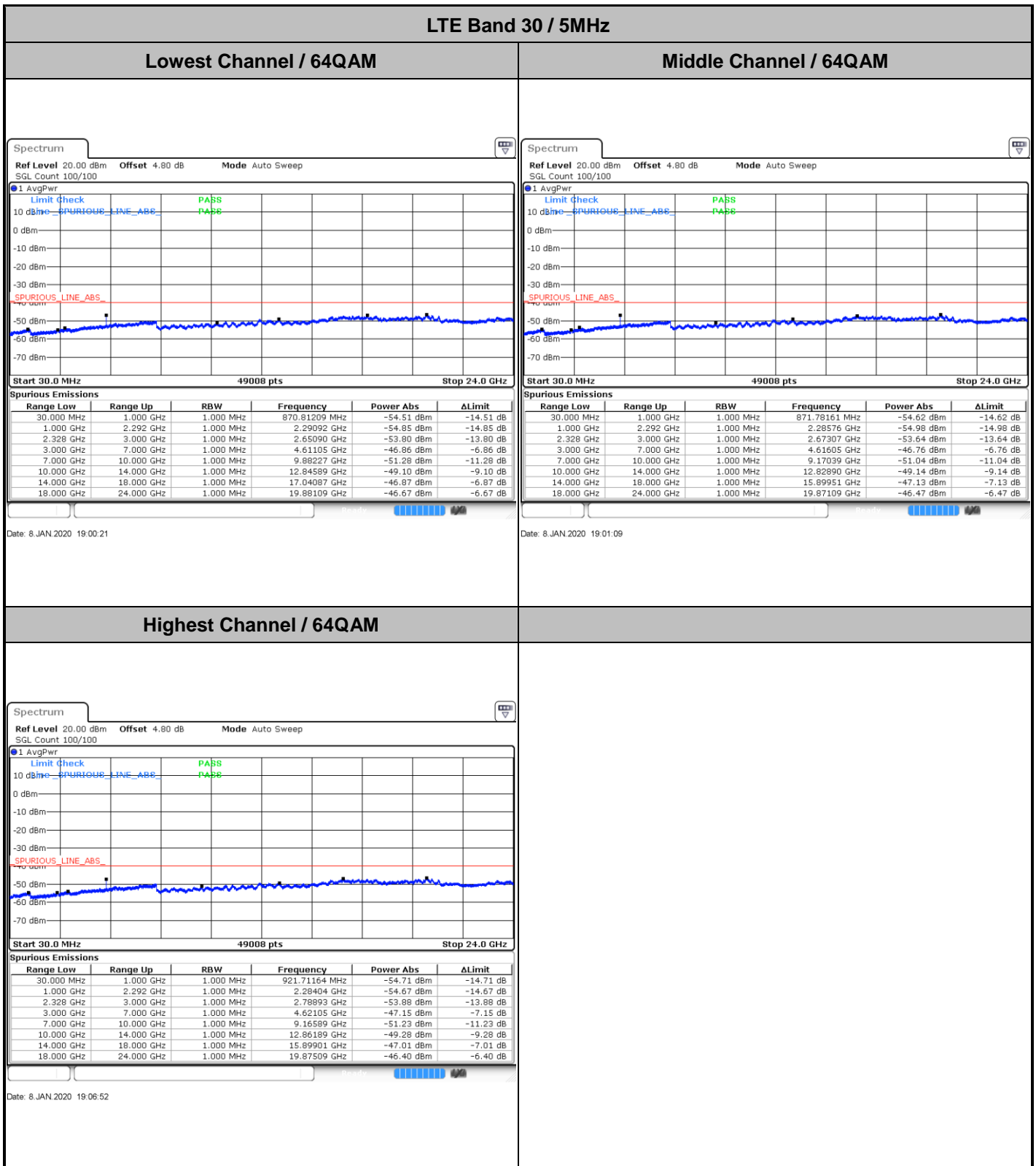

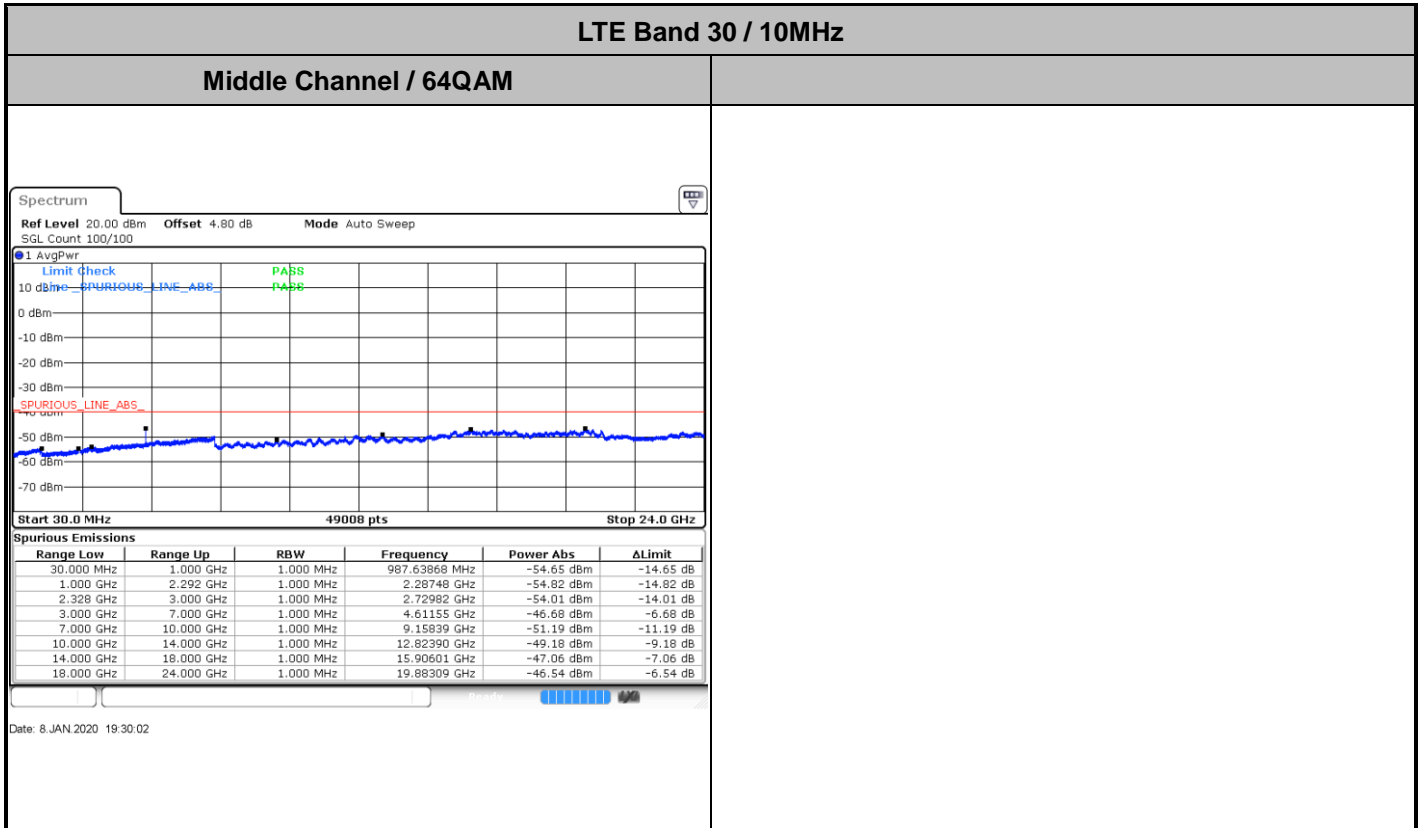



Frequency Stability

Test Conditions		LTE Band 30 (QPSK) / Middle Channel	Limit
Temperature (°C)	Voltage (Volt)	BW 10MHz	Note 2.
		Deviation (ppm)	Result
50	Normal Voltage	0.0017	PASS
40	Normal Voltage	0.0012	
30	Normal Voltage	0.0026	
20(Ref.)	Normal Voltage	0.0000	
10	Normal Voltage	0.0013	
0	Normal Voltage	0.0017	
-10	Normal Voltage	0.0016	
-20	Normal Voltage	0.0003	
-30	Normal Voltage	0.0001	
20	Maximum Voltage	0.0017	
20	Normal Voltage	0.0000	
20	Battery End Point	0.0015	

Note:

- 1. Normal Voltage =12 V. ; Battery End Point (BEP) =4.5 V. ; Maximum Voltage =14 V.
- 2. Note: The frequency fundamental emissions stay within the authorized frequency block.



Appendix B. Test Results of Radiated Test

Radiated Spurious Emission

LTE Band 30 / 10MHz / QPSK / RB Size 1 Offset 0								
Channel	Frequency (MHz)	EIRP (dBm)	Limit (dBm)	Over Limit (dB)	S.G. Power (dBm)	TX Cable loss (dB)	TX Antenna Gain (dBi)	Polarization (H/V)
Middle	4612	-49.55	-40	-9.55	-61.01	2.84	14.30	H
	6916	-58.72	-40	-18.72	-68.66	3.49	13.43	H
	9222.36	-56.72	-40	-16.72	-66.96	3.85	14.09	H
	11530	-53.37	-40	-13.37	-62.93	4.27	13.83	H
	13830	-55.44	-40	-15.44	-65.27	4.54	14.37	H
	4612	-53.45	-40	-13.45	-64.91	2.84	14.30	V
	6916	-53.83	-40	-13.83	-63.77	3.49	13.43	V
	9220	-57.59	-40	-17.59	-67.83	3.85	14.09	V

Remark: Spurious emissions within 30-1000MHz were found more than 20dB below limit line.