

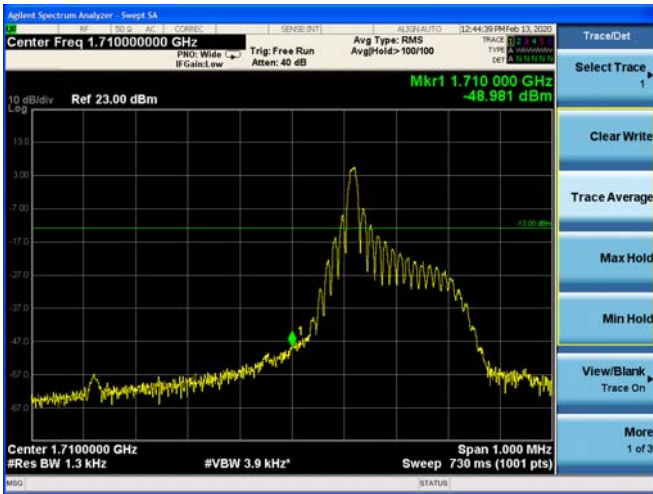

### NB-IOT Band 4 QPSK 15KHz 1@0 CH-Low



### NB-IOT Band 4 QPSK 15KHz 1@0 CH-High



### NB-IOT Band 4 QPSK 15KHz 12@0 CH-Low

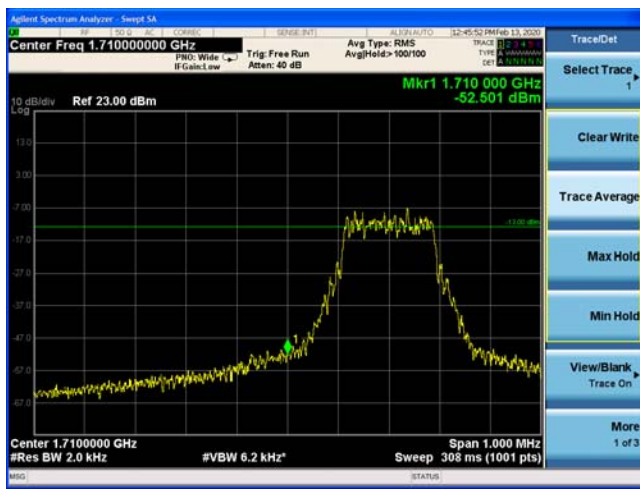

### NB-IOT Band 4 QPSK 15KHz 12@0 CH-High

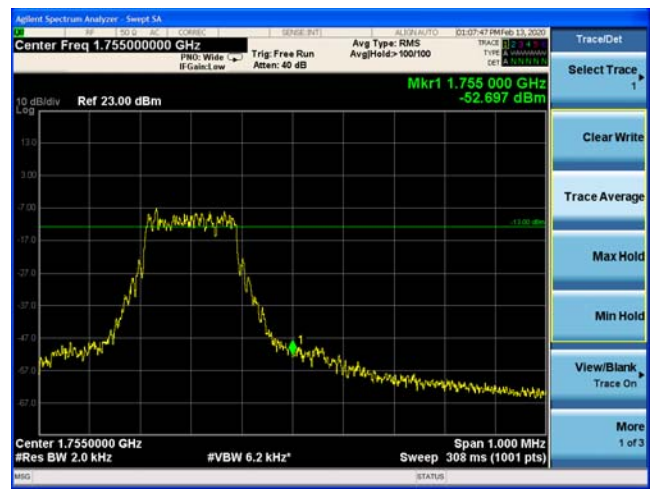



### NB-IOT Band 12 BPSK 3.75KHz 1@0 CH-Low



### NB-IOT Band 12 BPSK3.75KHz 1@0 CH-High



### NB-IOT Band 12 BPSK 15KHz 1@0 CH-Low



### NB-IOT Band 12 BPSK 15KHz 1@0 CH-High



### NB-IOT Band 12 QPSK 3.75KHz 1@0 CH-Low



### NB-IOT Band 12 QPSK 3.75KHz 1@0 CH-High





### NB-IOT Band 12QPSK 15KHz 1@0 CH-Low



### NB-IOT Band 12 QPSK 15KHz 1@0 CH-High

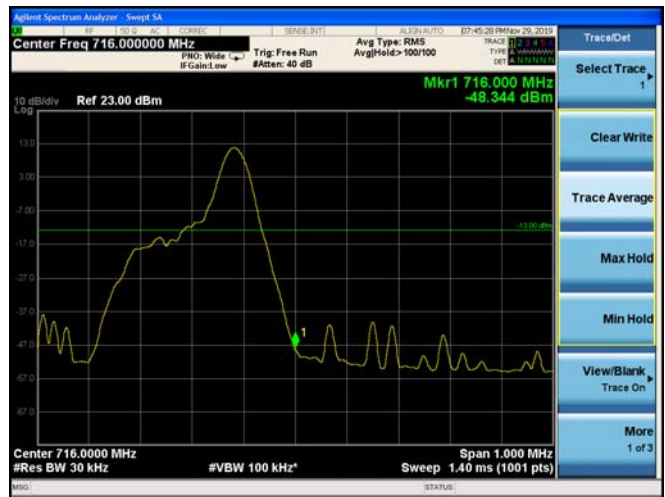

### NB-IOT Band 12 QPSK 15KHz 12@0 CH-Low



### NB-IOT Band 12 QPSK 15KHz 12@0 CH-High





### NB-IOT Band 13 BPSK 3.75KHz 1@0 CH-Low

### NB-IOT Band 13 BPSK 3.75KHz 1@0 CH-High

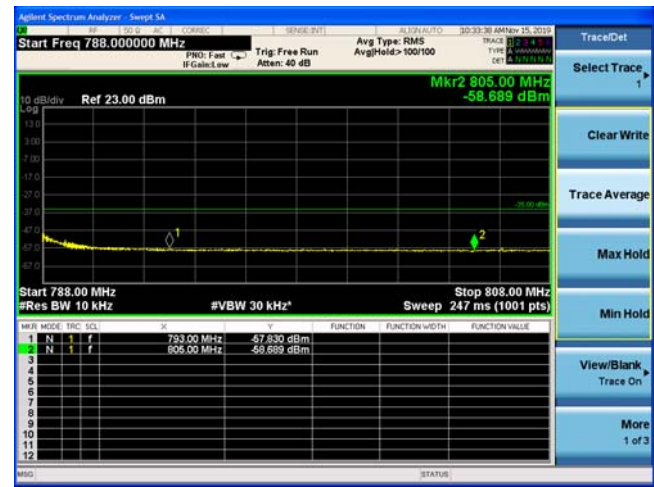
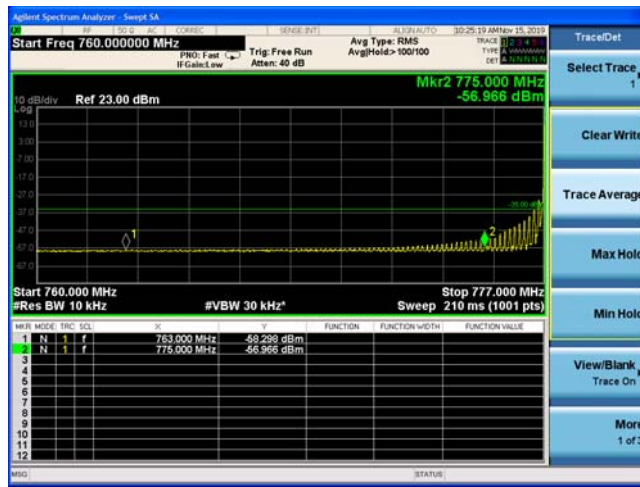



NB-IOT Band 13 BPSK 15KHz 1@0 CH-Low

NB-IOT Band 13 BPSK 15KHz 1@0 CH-High

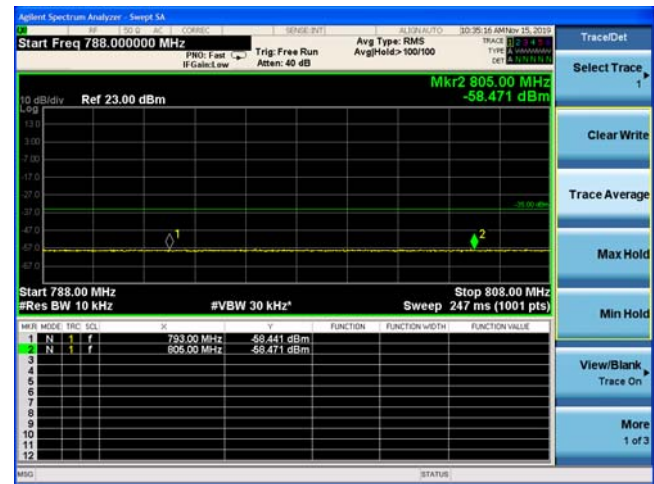
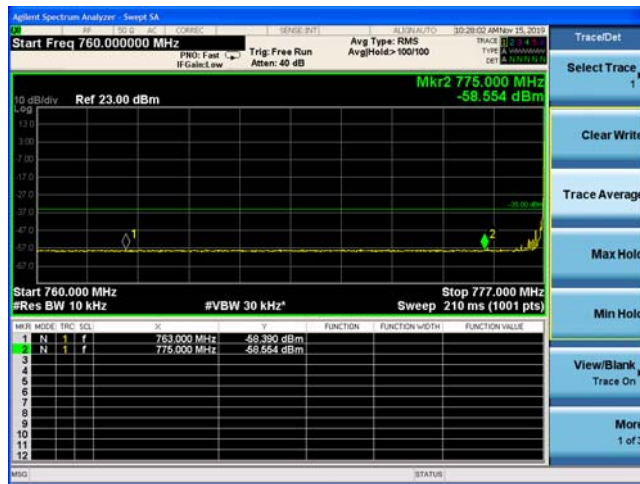



NB-IOT Band 13 QPSK 3.75KHz 1@0 CH-Low

NB-IOT Band 13 QPSK 3.75KHz 1@0 CH-High

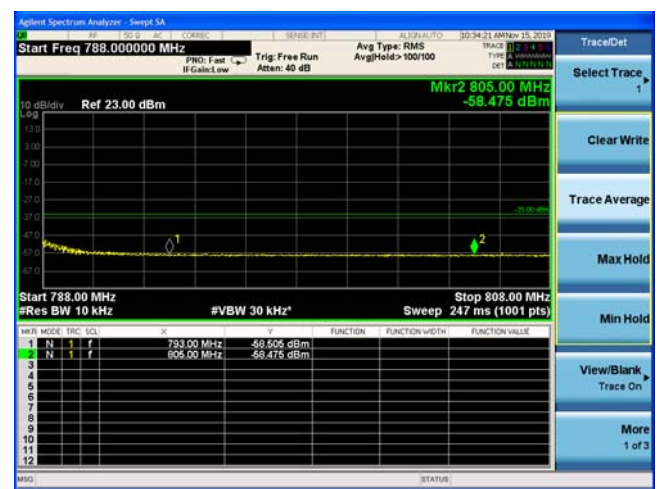
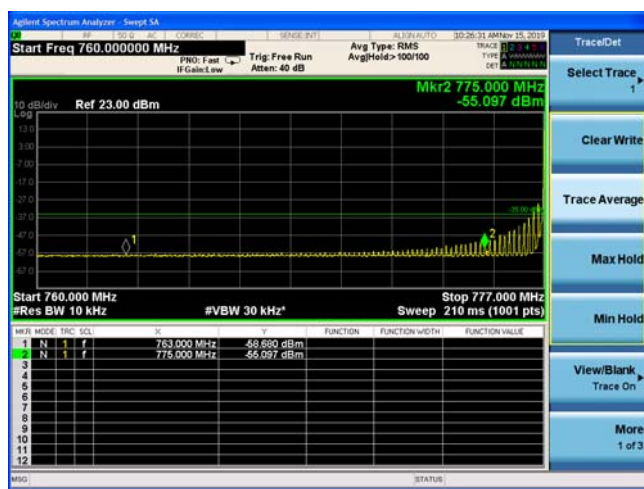



### NB-IOT Band 13QPSK 15KHz 1@0 CH-Low



### NB-IOT Band 13 QPSK 15KHz 1@0 CH-High

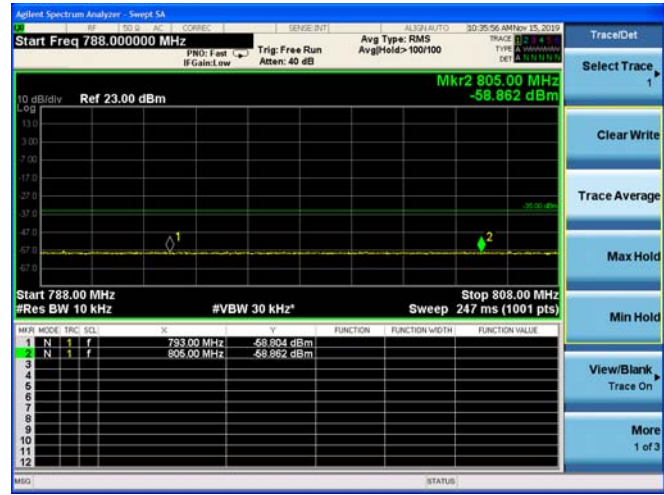
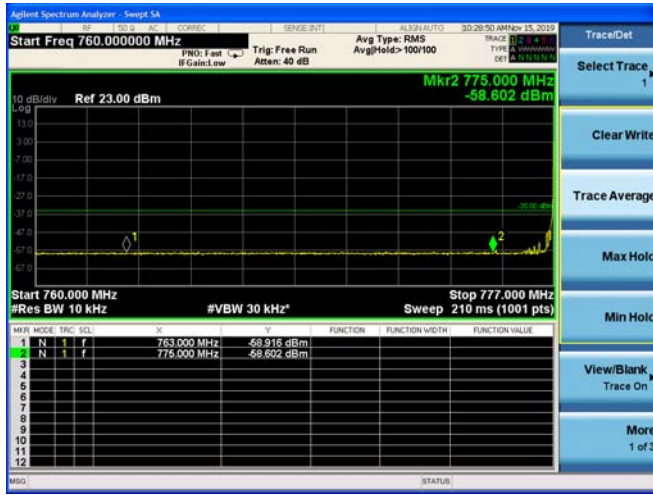



### NB-IOT Band 13 QPSK 15KHz 12@0 CH-Low

### NB-IOT Band 13 QPSK 15KHz 12@0 CH-High

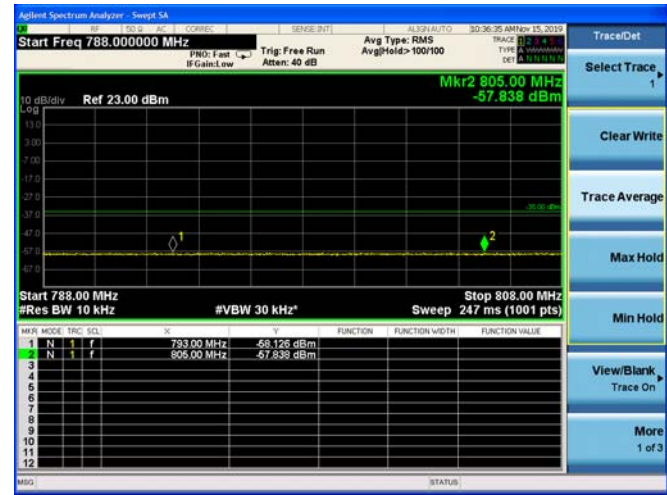
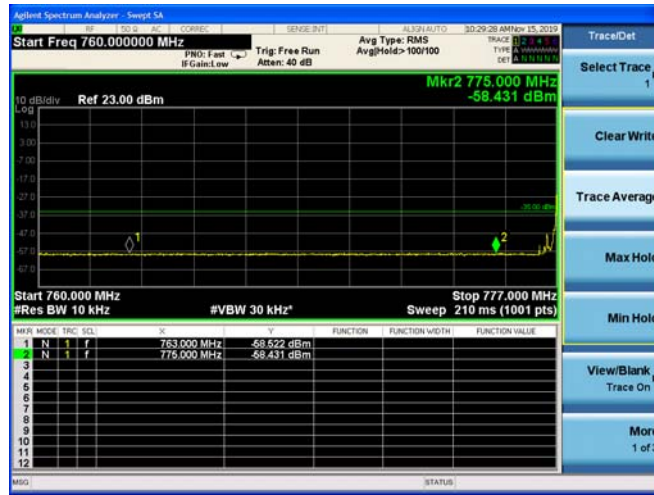





NB-IOT Band 66 BPSK 3.75KHz 1@0 CH-Low

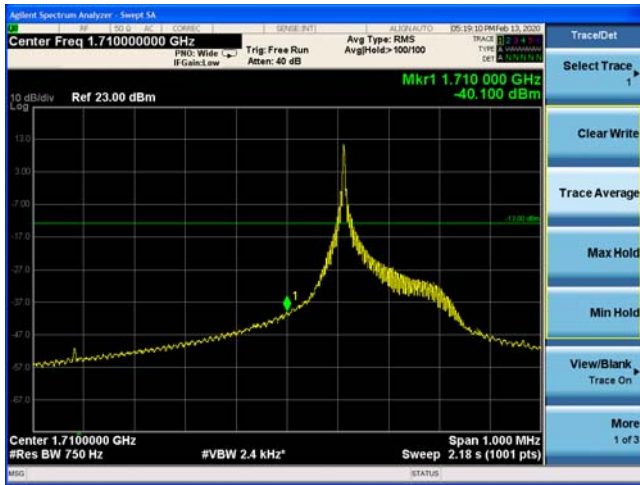

NB-IOT Band 66 BPSK 3.75KHz 1@0 CH-High

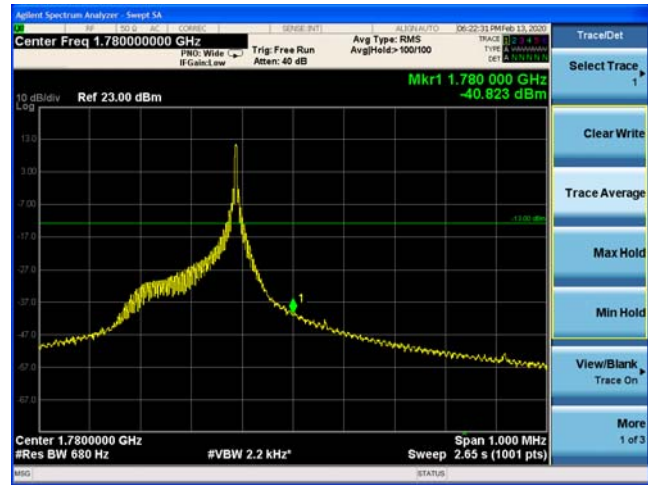

NB-IOT Band 66 BPSK 15KHz 1@0 CH-Low

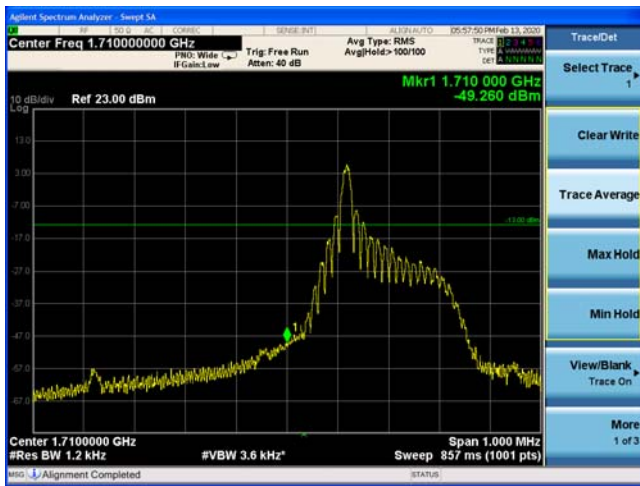

NB-IOT Band 66 BPSK 15KHz 1@0 CH-High

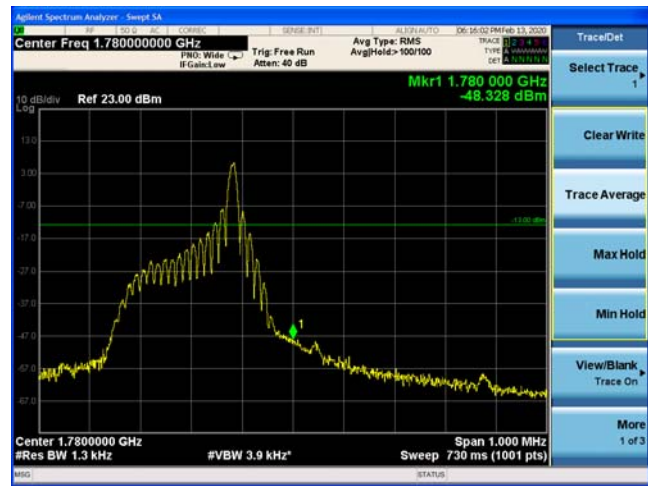

NB-IOT Band 66 QPSK 3.75KHz 1@0 CH-Low



NB-IOT Band 66 QPSK 3.75KHz 1@0 CH-High





### NB-IOT Band 66 QPSK 15KHz 1@0 CH-Low

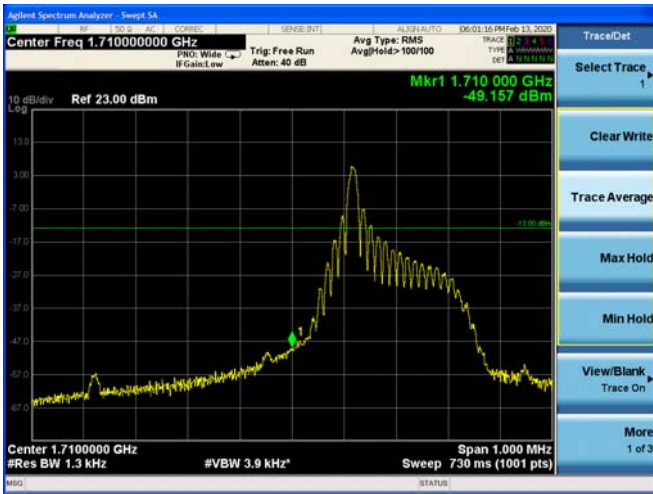

### NB-IOT Band 66 QPSK 15KHz 1@0 CH-High

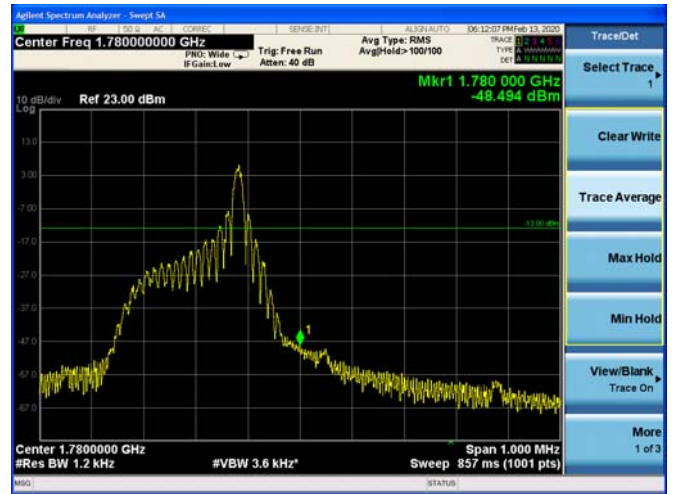

### NB-IOT Band 66 QPSK 15KHz 12@0 CH-Low

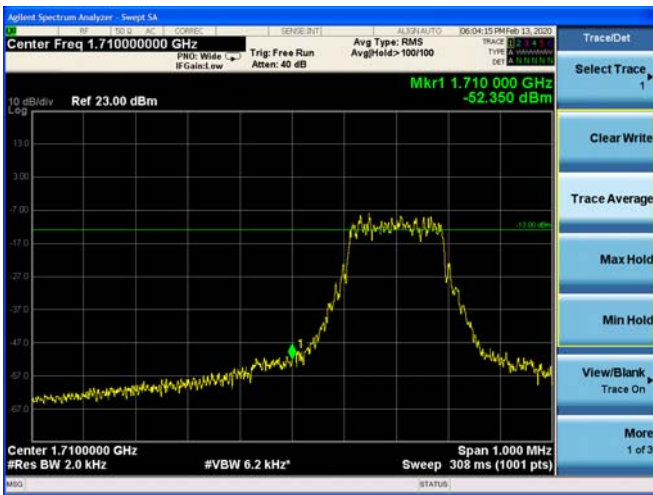

### NB-IOT Band 66 QPSK 15KHz 12@0 CH-High

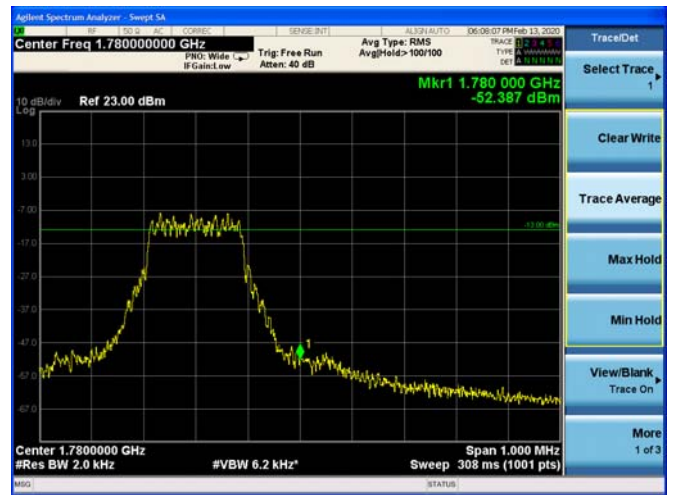



### NB-IOT Band 71 BPSK 3.75KHz 1@0 CH-Low



### NB-IOT Band 71 BPSK 3.75KHz 1@0 CH-High



### NB-IOT Band 71 BPSK 15KHz 1@0 CH-Low



### NB-IOT Band 71 BPSK 15KHz 1@0 CH-High



### NB-IOT Band 71 QPSK 3.75KHz 1@0 CH-Low



### NB-IOT Band 71 QPSK 3.75KHz 1@0 CH-High





### NB-IOT Band 71 QPSK 15KHz 1@0 CH-Low



### NB-IOT Band 71 QPSK 15KHz 1@0 CH-High



### NB-IOT Band 71 QPSK 15KHz 12@0 CH-Low



### NB-IOT Band 71 QPSK 15KHz 12@0 CH-High





### NB-IOT Band 85 BPSK 3.75KHz 1@0 CH-Low



### NB-IOT Band 85 BPSK 3.75KHz 1@0 CH-High



### NB-IOT Band 85 BPSK 15KHz 1@0 CH-Low



### NB-IOT Band 85 BPSK 15KHz 1@0 CH-High



### NB-IOT Band 85 QPSK 3.75KHz 1@0 CH-Low

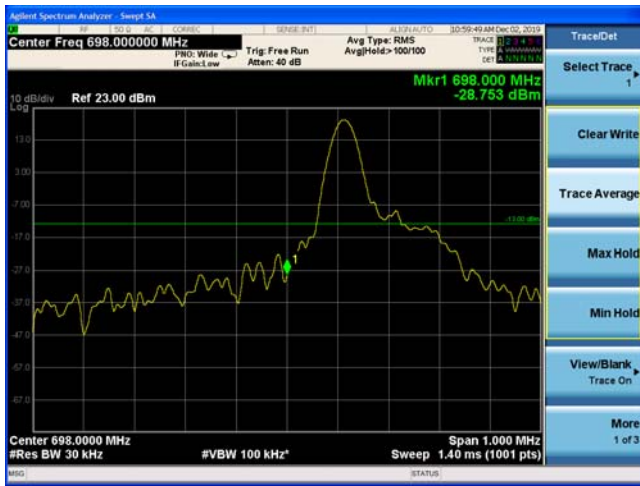

### NB-IOT Band 85 QPSK 3.75KHz 1@0 CH-High





### NB-IOT Band 85 QPSK 15KHz 1@0 CH-Low



### NB-IOT Band 85 QPSK 15KHz 1@0 CH-High



### NB-IOT Band 85 QPSK 15KHz 12@0 CH-Low



### NB-IOT Band 85 QPSK 15KHz 12@0 CH-High



### 5.4 Peak-to-Average Power Ratio (PAPR)

#### Ambient condition

Temperature	Relative humidity	Pressure
23°C ~25°C	45%~50%	101.5kPa

#### Methods of Measurement

Measure the total peak power and record as PPK. And measure the total average power and record as PAvg. Both the peak and average power levels must be expressed in the same logarithmic units (e.g., dBm). Determine the PAPR from:

$$PAPR (dB) = PPK (dBm) - PAvg (dBm).$$

#### Test Setup

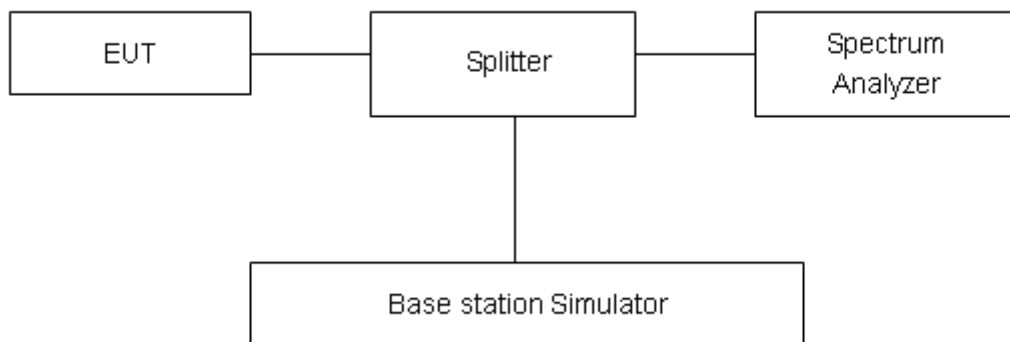

#### Limits

Rule Part 27.50(d)(5) Equipment employed must be authorized in accordance with the provisions of 24.51. Power measurements for transmissions by stations authorized under this section may be made either in accordance with a Commission-approved average power technique or in compliance with paragraph (d)(6) of this section. In measuring transmissions in this band using an average power technique, the peak-to-average ratio (PAR) of the transmission may not exceed 13 dB.

#### Measurement Uncertainty

The assessed measurement uncertainty to ensure 95% confidence level for the normal distribution is with the coverage factor  $k = 2$ ,  $U = 0.4$  dB.



## Test Results

Mode	Modulation	Sub-carrier spacing (KHz)	Channel/ Frequency(MHz)	Peak-to-Average Power Ratio (PAPR)		
				Peak(dBm)	Avg(dBm)	PAPR(dB)
Band 4 Standalone	BPSK	3.75	20175/1732.5	20.94	17.05	3.89
	QPSK	3.75	20175/1732.5	20.45	17.03	3.42
	BPSK	15	20175/1732.5	20.96	14.45	6.51
	QPSK	15	20175/1732.5	20.94	14.48	6.46
Mode	Modulation	Sub-carrier spacing (KHz)	Channel/ Frequency(MHz)	Peak-to-Average Power Ratio (PAPR)		
				Peak(dBm)	Avg(dBm)	PAPR(dB)
Band 12 Standalone	BPSK	3.75	23095/707.5	22.13	18.29	3.84
	QPSK	3.75	23095/707.5	21.68	18.29	3.39
	BPSK	15	23095/707.5	21.80	15.38	6.42
	QPSK	15	23095/707.5	21.74	15.34	6.40
Mode	Modulation	Sub-carrier spacing (KHz)	Channel/ Frequency(MHz)	Peak-to-Average Power Ratio (PAPR)		
				Peak(dBm)	Avg(dBm)	PAPR(dB)
Band 13 Standalone	BPSK	3.75	23230/782	22.20	18.34	3.86
	QPSK	3.75	23230/782	21.78	18.38	3.40
	BPSK	15	23230/782	21.83	15.33	6.50
	QPSK	15	23230/782	21.79	15.33	6.46
Mode	Modulation	Sub-carrier spacing (KHz)	Channel/ Frequency(MHz)	Peak-to-Average Power Ratio (PAPR)		
				Peak(dBm)	Avg(dBm)	PAPR(dB)
Band 66 Standalone	BPSK	3.75	132322/1745	21.53	17.64	3.89
	QPSK	3.75	132322/1745	21.09	17.65	3.44
	BPSK	15	132322/1745	21.23	14.70	6.53
	QPSK	15	132322/1745	21.19	14.71	6.48
Mode	Modulation	Sub-carrier spacing (KHz)	Channel/ Frequency(MHz)	Peak-to-Average Power Ratio (PAPR)		
				Peak(dBm)	Avg(dBm)	PAPR(dB)
Band 71 Standalone	BPSK	3.75	133297/680.5	22.49	18.72	3.77
	QPSK	3.75	133297/680.5	22.09	18.74	3.35
	BPSK	15	133297/680.5	22.18	15.56	6.62
	QPSK	15	133297/680.5	22.16	15.76	6.40
Mode	Modulation	Sub-carrier spacing (KHz)	Channel/ Frequency(MHz)	Peak-to-Average Power Ratio (PAPR)		
				Peak(dBm)	Avg(dBm)	PAPR(dB)
Band 85 Standalone	BPSK	3.75	134092/707	22.29	18.47	3.82
	QPSK	3.75	134092/707	21.83	18.43	3.40
	BPSK	15	134092/707	21.98	15.52	6.46
	QPSK	15	134092/707	21.99	15.58	6.41



## 5.5 Frequency Stability

### Ambient condition

Temperature	Relative humidity	Pressure
23°C ~25°C	45%~50%	101.5kPa

### Method of Measurement

#### Frequency Stability (Temperature Variation)

The temperature inside the climate chamber is varied from -40°C to +85°C in 10°C step size.

(1) With all power removed, the temperature was decreased to -10°C and permitted to stabilize for three hours.

(2) Measure the carrier frequency with the test equipment in a “call mode”. These measurements should be made within 1 minute of powering up the mobile station, to prevent significant self warming.

(3) Repeat the above measurements at 10°C increments from -40°C to +85°C. Allow at least 1.5 hours at each temperature, un-powered, before making measurements.

#### Frequency Stability (Voltage Variation)

The frequency stability shall be measured with variation of primary supply voltage as follows:

(1) Vary primary supply voltage from 85 to 115 percent of the nominal value for other than hand carried battery equipment.

(2) For hand carried, battery powered equipment, reduce primary supply voltage to the battery-operating end point which shall be specified by the manufacturer.

This transceiver is specified to operate with an input voltage of between 2.6 V and 4.8 V, with a nominal voltage of 3.3V.

### Test setup

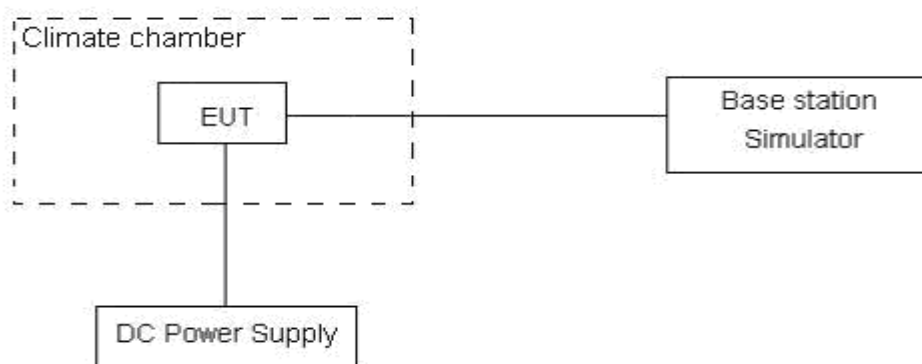

### Limits

The frequency stability shall be sufficient to ensure that the fundamental emissions stay within the authorized bands of operation.

### Measurement Uncertainty

The assessed measurement uncertainty to ensure 99.75% confidence level for the normal distribution is with the coverage factor  $k = 3, U = 0.01\text{ppm}$ .



## Test Result:

NB-IOT Band4	Condition		Freq.Error (Hz)	Freq.Error (Hz)	Frequency Stability (ppm)	Frequency Stability (ppm)	Verdict	
	Sub-carrier spacing	3.75KHz						
	Temperature	Voltage	BPSK	QPSK	BPSK	QPSK		
	Normal(25°C)	Normal	10.37	11.52	0.00551	0.00613	PASS	
	Extreme(85°C)		7.71	5.71	0.00410	0.00304	PASS	
	Extreme(80°C)		13.92	3.65	0.00740	0.00194	PASS	
	Extreme(70°C)		2.83	6.14	0.00150	0.00327	PASS	
	Extreme(60°C)		11.58	1.39	0.00616	0.00074	PASS	
	Extreme(50°C)		9.52	15.74	0.00507	0.00837	PASS	
	Extreme(40°C)		16.09	7.14	0.00856	0.00380	PASS	
	Extreme(30°C)		2.93	17.98	0.00156	0.00956	PASS	
	Extreme(20°C)		14.65	11.60	0.00779	0.00617	PASS	
	Extreme(10°C)		5.18	17.31	0.00275	0.00921	PASS	
	Extreme(0°C)		15.67	4.43	0.00834	0.00236	PASS	
	Extreme(-10°C)		4.44	5.93	0.00236	0.00316	PASS	
	Extreme(-20°C)		16.72	17.15	0.00890	0.00912	PASS	
	Extreme(-30°C)		16.48	3.29	0.00877	0.00175	PASS	
	Extreme(-40°C)		10.82	8.83	0.00576	0.00470	PASS	
	25°C		LV	10.43	9.96	0.00555	0.00530	PASS
			HV	16.51	1.75	0.00878	0.00093	PASS
	Condition		Freq.Error (Hz)	Freq.Error (Hz)	Frequency Stability(ppm)	Frequency Stability(ppm)	Verdict	
	Sub-carrier spacing	15KHz						
	Temperature	Voltage	BPSK	QPSK	BPSK	QPSK		
	Normal(25°C)	Normal	12.24	2.09	0.00651	0.00111	PASS	
	Extreme(85°C)		6.34	5.87	0.00337	0.00312	PASS	
	Extreme(80°C)		1.37	3.88	0.00073	0.00206	PASS	
	Extreme(70°C)		12.80	15.24	0.00681	0.00810	PASS	
	Extreme(60°C)		2.62	8.17	0.00139	0.00434	PASS	
	Extreme(50°C)		16.19	5.67	0.00861	0.00301	PASS	
	Extreme(40°C)		10.36	6.50	0.00551	0.00346	PASS	
	Extreme(30°C)		4.78	4.91	0.00254	0.00261	PASS	
	Extreme(20°C)		15.63	8.69	0.00832	0.00462	PASS	
	Extreme(10°C)		12.25	10.09	0.00652	0.00537	PASS	
	Extreme(0°C)		16.49	11.05	0.00877	0.00588	PASS	
	Extreme(-10°C)		12.41	13.30	0.00660	0.00707	PASS	
	Extreme(-20°C)		11.80	10.95	0.00628	0.00583	PASS	
	Extreme(-30°C)		17.67	1.29	0.00940	0.00069	PASS	
	Extreme(-40°C)		3.15	3.07	0.00167	0.00163	PASS	



25°C	LV	6.23	9.50	0.00331	0.00505	PASS
	HV	8.05	14.30	0.00428	0.00761	PASS

Condition	Sub-carrier spacing	3.75KHz	Freq.Error (Hz)	Freq.Error (Hz)	Frequency Stability(ppm)		Verdict		
					Voltage				
					BPSK	QPSK		BPSK	QPSK
Normal(25°C)	Normal	Normal	3.04	13.59	0.00162	0.00723	PASS		
			6.46	14.13	0.00343	0.00752	PASS		
			11.44	17.12	0.00609	0.00911	PASS		
			3.70	9.45	0.00197	0.00503	PASS		
			6.78	12.11	0.00361	0.00644	PASS		
			1.10	6.07	0.00059	0.00323	PASS		
			7.58	7.01	0.00403	0.00373	PASS		
			1.06	7.94	0.00057	0.00422	PASS		
			14.94	8.70	0.00795	0.00463	PASS		
			5.27	13.70	0.00280	0.00729	PASS		
			14.94	3.30	0.00795	0.00176	PASS		
			14.92	14.57	0.00794	0.00775	PASS		
			16.12	15.30	0.00857	0.00814	PASS		
			13.97	3.24	0.00743	0.00172	PASS		
			17.91	11.77	0.00953	0.00626	PASS		
			25°C	LV	5.25	14.44	0.00279	0.00768	PASS
				HV	15.79	1.58	0.00840	0.00084	PASS
Condition			Freq.Error (Hz)	Freq.Error (Hz)	Frequency Stability(ppm)		Verdict		
Sub-carrier spacing	15KHz	Voltage			Voltage				
					BPSK	QPSK		BPSK	QPSK
			Normal	4.77	11.94	0.00254	0.00635	PASS	
5.92	1.37	0.00315		0.00073	PASS				
1.14	5.00	0.00061		0.00266	PASS				
2.54	7.24	0.00135		0.00385	PASS				
13.04	1.00	0.00694		0.00053	PASS				
9.01	13.34	0.00479		0.00709	PASS				
15.21	6.45	0.00809		0.00343	PASS				
5.25	5.74	0.00279		0.00305	PASS				
9.24	10.82	0.00492		0.00576	PASS				
14.89	7.43	0.00792		0.00395	PASS				
16.01	11.46	0.00852		0.00610	PASS				
11.34	10.78	0.00603		0.00573	PASS				



	Extreme(-20°C)		6.67	12.73	0.00355	0.00677	PASS
	Extreme(-30°C)		17.28	15.17	0.00919	0.00807	PASS
	Extreme(-40°C)		3.87	8.52	0.00206	0.00453	PASS
	25°C	LV	4.93	14.74	0.00262	0.00784	PASS
		HV	2.56	17.37	0.00136	0.00924	PASS

	Condition		Freq.Error (Hz)	Freq.Error (Hz)	Frequency Stability(ppm)	Frequency Stability(ppm)	Verdict		
	Sub-carrier spacing	3.75KHz							
	Temperature	Voltage	BPSK	QPSK	BPSK	QPSK			
NB-IOT Band13	Normal(25°C)	Normal	12.65	15.89	0.00673	0.00845	PASS		
	Extreme(85°C)		10.31	9.22	0.00549	0.00490	PASS		
	Extreme(80°C)		12.20	8.07	0.00649	0.00429	PASS		
	Extreme(70°C)		15.05	7.77	0.00800	0.00413	PASS		
	Extreme(60°C)		16.54	13.24	0.00880	0.00704	PASS		
	Extreme(50°C)		2.75	13.88	0.00146	0.00739	PASS		
	Extreme(40°C)		10.53	2.86	0.00560	0.00152	PASS		
	Extreme(30°C)		6.18	7.19	0.00329	0.00382	PASS		
	Extreme(20°C)		14.08	3.41	0.00749	0.00181	PASS		
	Extreme(10°C)		15.73	3.34	0.00837	0.00178	PASS		
	Extreme(0°C)		12.50	4.51	0.00665	0.00240	PASS		
	Extreme(-10°C)		11.21	12.40	0.00596	0.00659	PASS		
	Extreme(-20°C)		1.74	16.97	0.00093	0.00903	PASS		
	Extreme(-30°C)		14.03	7.86	0.00746	0.00418	PASS		
	Extreme(-40°C)		6.99	8.16	0.00372	0.00434	PASS		
	25°C		LV	1.05	15.16	0.00056	0.00806	PASS	
			HV	5.06	8.59	0.00269	0.00457	PASS	
			Condition		Freq.Error (Hz)	Freq.Error (Hz)	Frequency Stability(ppm)	Frequency Stability(ppm)	Verdict
			Sub-carrier spacing	15KHz					
		Temperature	Voltage	BPSK	QPSK	BPSK	QPSK		
	Normal(25°C)	Normal	14.03	8.27	0.00746	0.00440	PASS		
	Extreme(85°C)		4.67	4.07	0.00249	0.00217	PASS		
	Extreme(80°C)		8.29	1.60	0.00441	0.00085	PASS		
	Extreme(70°C)		14.73	7.99	0.00784	0.00425	PASS		
	Extreme(60°C)		1.49	11.98	0.00079	0.00637	PASS		
	Extreme(50°C)		2.28	6.63	0.00121	0.00352	PASS		
	Extreme(40°C)		13.89	14.40	0.00739	0.00766	PASS		
	Extreme(30°C)		13.26	3.00	0.00706	0.00160	PASS		
	Extreme(20°C)		9.04	2.15	0.00481	0.00114	PASS		



	Extreme(10°C)		2.34	15.31	0.00125	0.00815	PASS
	Extreme(0°C)		2.42	5.76	0.00129	0.00306	PASS
	Extreme(-10°C)		5.75	2.49	0.00306	0.00133	PASS
	Extreme(-20°C)		11.68	14.60	0.00621	0.00777	PASS
	Extreme(-30°C)		1.44	4.07	0.00077	0.00216	PASS
	Extreme(-40°C)		13.70	7.66	0.00729	0.00408	PASS
	25°C		LV	13.72	1.46	0.00730	0.00078
	HV	2.34	8.49	0.00124	0.00451	PASS	

	Condition		Freq.Error (Hz)	Freq.Error (Hz)	Frequency Stability(ppm)	Frequency Stability(ppm)	Verdict	
	Sub-carrier spacing	3.75KHz						
	Temperature	Voltage	BPSK	QPSK	BPSK	QPSK		
NB-IOT Band66	Normal(25°C)	Normal	11.22	16.60	0.00597	0.00883	PASS	
	Extreme(85°C)		11.82	9.45	0.00629	0.00503	PASS	
	Extreme(80°C)		3.55	5.84	0.00189	0.00311	PASS	
	Extreme(70°C)		14.34	12.57	0.00763	0.00668	PASS	
	Extreme(60°C)		17.33	15.77	0.00922	0.00839	PASS	
	Extreme(50°C)		15.92	1.58	0.00847	0.00084	PASS	
	Extreme(40°C)		17.47	5.96	0.00930	0.00317	PASS	
	Extreme(30°C)		1.88	9.14	0.00100	0.00486	PASS	
	Extreme(20°C)		10.68	7.18	0.00568	0.00382	PASS	
	Extreme(10°C)		7.80	2.46	0.00415	0.00131	PASS	
	Extreme(0°C)		15.91	2.47	0.00846	0.00131	PASS	
	Extreme(-10°C)		11.80	4.78	0.00628	0.00254	PASS	
	Extreme(-20°C)		13.08	8.01	0.00695	0.00426	PASS	
	Extreme(-30°C)		5.99	8.40	0.00319	0.00447	PASS	
	Extreme(-40°C)		6.21	11.40	0.00330	0.00606	PASS	
	25°C		LV	6.02	3.27	0.00320	0.00174	PASS
			HV	16.05	2.11	0.00854	0.00112	PASS
		Condition		Freq.Error (Hz)	Freq.Error (Hz)	Frequency Stability(ppm)	Frequency Stability(ppm)	Verdict
		Sub-carrier spacing	15KHz					
		Temperature	Voltage	BPSK	QPSK	BPSK	QPSK	
	Normal(25°C)	Normal	10.04	15.80	0.00534	0.00841	PASS	
	Extreme(85°C)		12.24	17.23	0.00651	0.00917	PASS	
	Extreme(80°C)		10.65	6.84	0.00567	0.00364	PASS	
	Extreme(70°C)		17.24	17.03	0.00917	0.00906	PASS	
	Extreme(60°C)		7.45	16.26	0.00396	0.00865	PASS	
	Extreme(50°C)		14.50	15.19	0.00771	0.00808	PASS	



	Extreme(40°C)		8.66	7.20	0.00461	0.00383	PASS
	Extreme(30°C)		6.16	17.68	0.00328	0.00940	PASS
	Extreme(20°C)		2.26	2.29	0.00120	0.00122	PASS
	Extreme(10°C)		1.66	9.99	0.00088	0.00531	PASS
	Extreme(0°C)		14.92	14.03	0.00793	0.00746	PASS
	Extreme(-10°C)		16.74	2.59	0.00890	0.00138	PASS
	Extreme(-20°C)		6.13	8.03	0.00326	0.00427	PASS
	Extreme(-30°C)		8.55	7.44	0.00455	0.00396	PASS
	Extreme(-40°C)		10.84	5.35	0.00577	0.00285	PASS
	25°C		LV	2.09	13.47	0.00111	0.00717
HV		2.56	2.23	0.00136	0.00119	PASS	

	Condition		Freq.Error (Hz)	Freq.Error (Hz)	Frequency Stability(ppm)	Frequency Stability(ppm)	Verdict	
	Sub-carrier spacing	3.75KHz						
	Temperature	Voltage	BPSK	QPSK	BPSK	QPSK		
NB-IOT Band71	Normal(25°C)	Normal	10.75	5.03	0.00572	0.00267	PASS	
	Extreme(85°C)		10.00	14.30	0.00532	0.00761	PASS	
	Extreme(80°C)		13.75	4.65	0.00731	0.00247	PASS	
	Extreme(70°C)		10.95	5.08	0.00582	0.00270	PASS	
	Extreme(60°C)		3.24	3.59	0.00173	0.00191	PASS	
	Extreme(50°C)		9.02	12.35	0.00480	0.00657	PASS	
	Extreme(40°C)		7.49	2.52	0.00398	0.00134	PASS	
	Extreme(30°C)		16.99	5.60	0.00904	0.00298	PASS	
	Extreme(20°C)		14.29	10.67	0.00760	0.00568	PASS	
	Extreme(10°C)		2.24	11.97	0.00119	0.00637	PASS	
	Extreme(0°C)		8.99	10.41	0.00478	0.00554	PASS	
	Extreme(-10°C)		12.32	6.40	0.00656	0.00340	PASS	
	Extreme(-20°C)		5.04	7.57	0.00268	0.00402	PASS	
	Extreme(-30°C)		14.31	15.37	0.00761	0.00818	PASS	
	Extreme(-40°C)		4.01	17.38	0.00214	0.00924	PASS	
	25°C		LV	9.77	14.33	0.00519	0.00762	PASS
			HV	13.44	8.80	0.00715	0.00468	PASS
			Condition		Freq.Error (Hz)	Freq.Error (Hz)	Frequency Stability(ppm)	Frequency Stability(ppm)
		Sub-carrier spacing	15KHz					
		Temperature	Voltage	BPSK	QPSK	BPSK	QPSK	
	Normal(25°C)	Normal	15.52	12.48	0.00826	0.00664	PASS	
	Extreme(85°C)		14.67	7.21	0.00780	0.00383	PASS	
	Extreme(80°C)		17.08	11.52	0.00908	0.00613	PASS	



	Extreme(70°C)		1.68	8.90	0.00089	0.00474	PASS	
	Extreme(60°C)		2.94	11.08	0.00156	0.00589	PASS	
	Extreme(50°C)		10.18	7.53	0.00541	0.00401	PASS	
	Extreme(40°C)		4.12	16.73	0.00219	0.00890	PASS	
	Extreme(30°C)		7.84	16.27	0.00417	0.00865	PASS	
	Extreme(20°C)		15.24	12.68	0.00811	0.00674	PASS	
	Extreme(10°C)		7.67	6.25	0.00408	0.00333	PASS	
	Extreme(0°C)		4.53	8.62	0.00241	0.00459	PASS	
	Extreme(-10°C)		16.18	16.55	0.00861	0.00880	PASS	
	Extreme(-20°C)		2.53	14.74	0.00135	0.00784	PASS	
	Extreme(-30°C)		5.09	1.57	0.00271	0.00084	PASS	
	Extreme(-40°C)		10.56	17.32	0.00562	0.00921	PASS	
	25°C		LV	15.29	14.37	0.00814	0.00764	PASS
			HV	13.41	3.18	0.00713	0.00169	PASS

NB-IOT Band85	Condition		Freq.Error (Hz)	Freq.Error (Hz)	Frequency Stability(ppm)	Frequency Stability(ppm)	Verdict
	Sub-carrier spacing	3.75KHz					
	Temperature	Voltage	BPSK	QPSK	BPSK	QPSK	
	Normal(25°C)	Normal	2.80	12.09	0.00149	0.00643	PASS
	Extreme(85°C)		4.16	10.31	0.00221	0.00548	PASS
	Extreme(80°C)		8.04	10.66	0.00428	0.00567	PASS
	Extreme(70°C)		1.56	9.15	0.00083	0.00486	PASS
	Extreme(60°C)		1.95	17.67	0.00104	0.00940	PASS
	Extreme(50°C)		6.44	13.44	0.00342	0.00715	PASS
	Extreme(40°C)		13.67	8.06	0.00727	0.00429	PASS
	Extreme(30°C)		1.52	3.73	0.00081	0.00198	PASS
	Extreme(20°C)		2.73	9.50	0.00145	0.00505	PASS
	Extreme(10°C)		15.59	2.36	0.00829	0.00126	PASS
	Extreme(0°C)		13.28	13.98	0.00706	0.00744	PASS
	Extreme(-10°C)		8.76	9.97	0.00466	0.00530	PASS
	Extreme(-20°C)		10.65	15.79	0.00566	0.00840	PASS
	Extreme(-30°C)		8.43	12.35	0.00449	0.00657	PASS
	Extreme(-40°C)		13.84	6.48	0.00736	0.00345	PASS
	25°C		LV	14.01	8.56	0.00745	0.00455
		HV	14.96	4.66	0.00796	0.00248	PASS
	Condition		Freq.Error (Hz)	Freq.Error (Hz)	Frequency Stability(ppm)	Frequency Stability(ppm)	Verdict
	Sub-carrier spacing	15KHz					
	Temperature	Voltage	BPSK	QPSK	BPSK	QPSK	



	Normal(25℃)	Normal	2.60	2.02	0.00138	0.00107	PASS	
	Extreme(85℃)		1.25	7.55	0.00066	0.00402	PASS	
	Extreme(80℃)		2.59	3.77	0.00138	0.00200	PASS	
	Extreme(70℃)		7.37	16.37	0.00392	0.00871	PASS	
	Extreme(60℃)		6.66	7.63	0.00354	0.00406	PASS	
	Extreme(50℃)		4.57	3.11	0.00243	0.00166	PASS	
	Extreme(40℃)		2.05	8.79	0.00109	0.00467	PASS	
	Extreme(30℃)		4.84	7.39	0.00258	0.00393	PASS	
	Extreme(20℃)		12.20	17.20	0.00649	0.00915	PASS	
	Extreme(10℃)		3.65	6.14	0.00194	0.00326	PASS	
	Extreme(0℃)		5.15	3.76	0.00274	0.00200	PASS	
	Extreme(-10℃)		14.50	17.66	0.00771	0.00939	PASS	
	Extreme(-20℃)		5.46	17.04	0.00290	0.00906	PASS	
	Extreme(-30℃)		1.01	5.54	0.00054	0.00295	PASS	
	Extreme(-40℃)		1.11	7.12	0.00059	0.00379	PASS	
	25℃	LV		9.83	12.07	0.00523	0.00642	PASS
		HV		7.26	15.96	0.00386	0.00849	PASS



## 5.6 Spurious Emissions at Antenna Terminals

### Ambient condition

Temperature	Relative humidity	Pressure
23°C ~25°C	45%~50%	101.5kPa

### Method of Measurement

The EUT was connected to Spectrum Analyzer and Base Station Simulator via power Splitter. The measurement is carried out using a spectrum analyzer. The spectrum analyzer scans from 9kHz to the 10th harmonic of the carrier. The peak detector is used.

RBW is set to 100kHz, VBW is set to 300kHz for 30MHz~1GHz

RBW is set to 1MHz, VBW is set to 3MHz for above 1GHz, Sweep is set to ATUO.

Of those disturbances below (limit – 20 dB), the mark is not required for the EUT.

The modulation mode and RB allocation refer to section 5.1, using the maximum output power configuration.

### Test setup

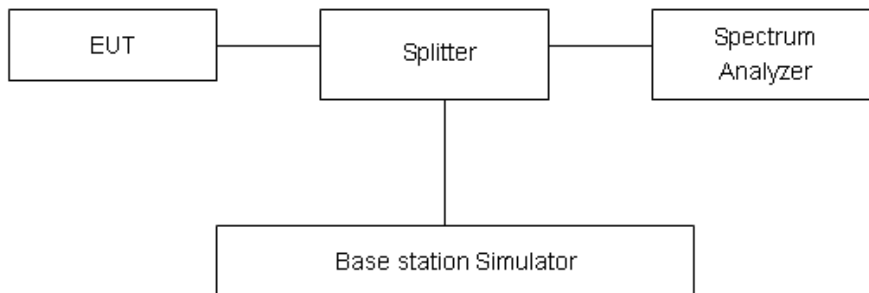

### Limits

Rule Part 27.53(h) specifies that “for operations in the 1695-1710 MHz, 1710-1755 MHz, 1755-1780 MHz, 1915-1920 MHz, 1995-2000 MHz, 2000-2020 MHz, 2110-2155 MHz, 2155-2180 MHz, and 2180-2200 bands, the power of any emission outside a licensee's frequency block shall be attenuated below the transmitter power (P) in watts by at least  $43 + 10 \log_{10}(P)$  dB..”

Rule Part 27.53 (g) For operations in the 600 MHz band and the 698-746 MHz band, the power of any emission outside a licensee's frequency band(s) of operation shall be attenuated below the transmitter power (P) within the licensed band(s) of operation, measured in watts, by at least  $43 + 10 \log(P)$  dB. Compliance with this provision is based on the use of measurement instrumentation employing a resolution bandwidth of 100 kilohertz or greater. However, in the 100 kilohertz bands immediately outside and adjacent to a licensee's frequency block, a resolution bandwidth of at least 30 kHz may be employed.

Rule Part 27.53(f) For operations in the 746-758 MHz, 775-788 MHz, and 805-806 MHz bands, emissions in the band 1559-1610 MHz shall be limited to  $-70$  dBW/MHz equivalent isotropically



radiated power (EIRP) for wideband signals, and -80 dBW EIRP for discrete emissions of less than 700 Hz bandwidth. For the purpose of equipment authorization, a transmitter shall be tested with an antenna that is representative of the type that will be used with the equipment in normal operation.

Part 27.53(a)/(h)/(g) Limit		-13 dBm
Part 27.53(f) Limit	Limit out of the band 1559-1610 MHz	-13 dBm
	Limit in the band 1559-1610 MHz	-40 dBm
Part 27.53(m) Limit		-25 dBm

### Measurement Uncertainty

The assessed measurement uncertainty to ensure 99.75% confidence level for the normal distribution is with the coverage factor  $k = 1.96$ .

Frequency	Uncertainty
9kHz-1GHz	0.684 dB
1GHz-27GHz	1.407 dB



### Test Result

Sweep the whole frequency band through the range from 9kHz to the 10th harmonic of the carrier, the emissions more than 20 dB below the limit are not reported.

The signal beyond the limit is carrier.

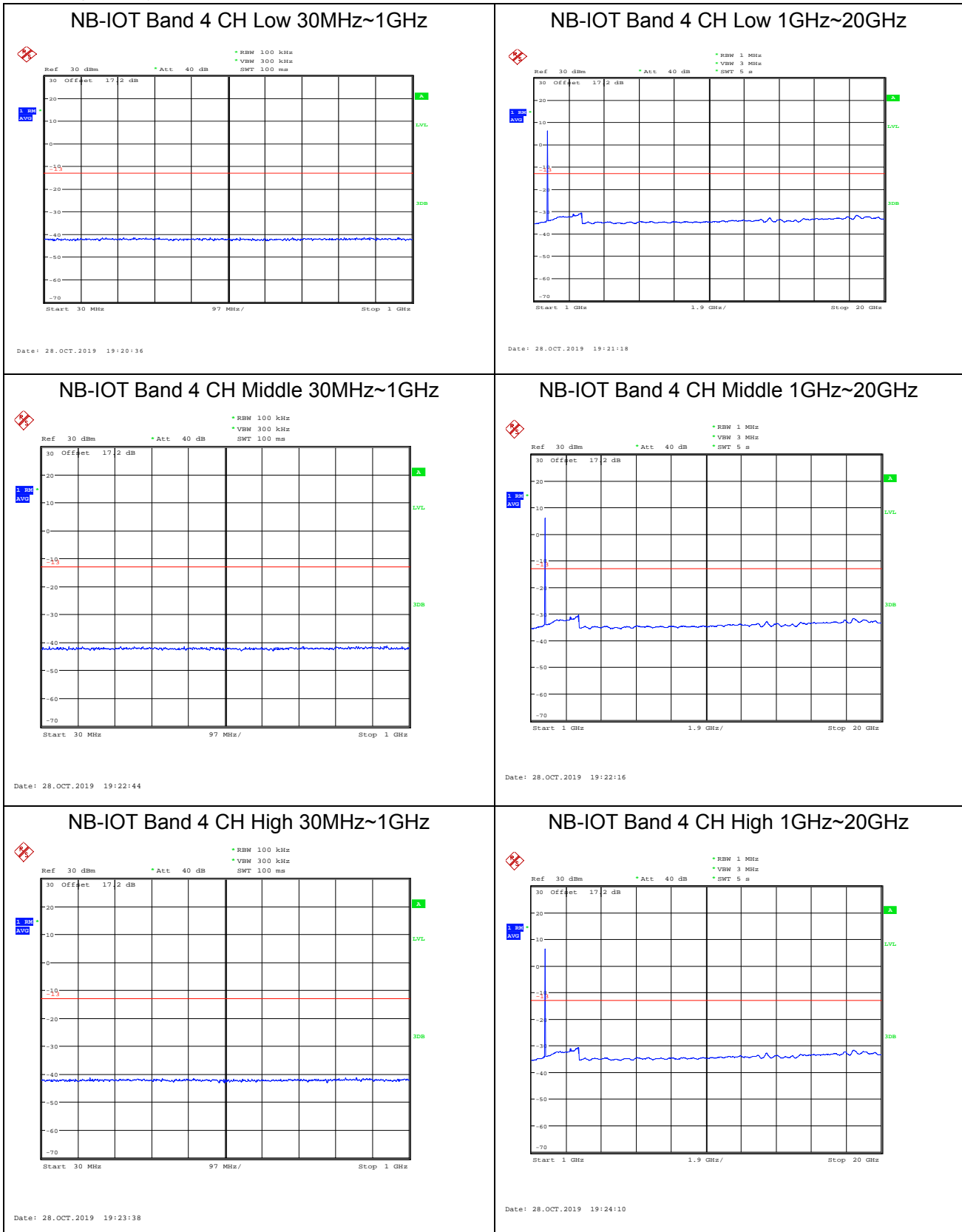



### NB-IOT Band 12 CH Low 30MHz~1GHz

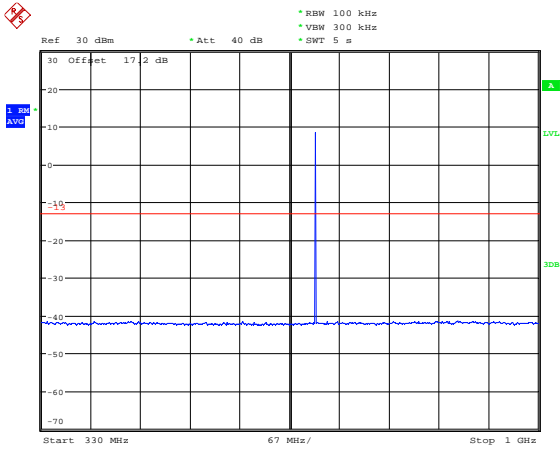

Date: 28.OCT.2019 19:37:30

### NB-IOT Band 12 CH Low 1GHz~9GHz

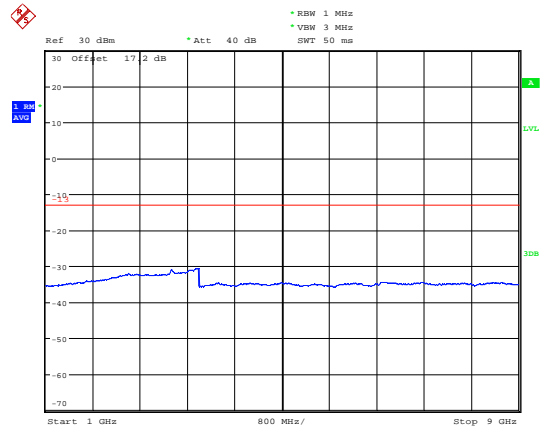

Date: 28.OCT.2019 19:37:56

### NB-IOT Band 12 CH Middle 30MHz~1GHz

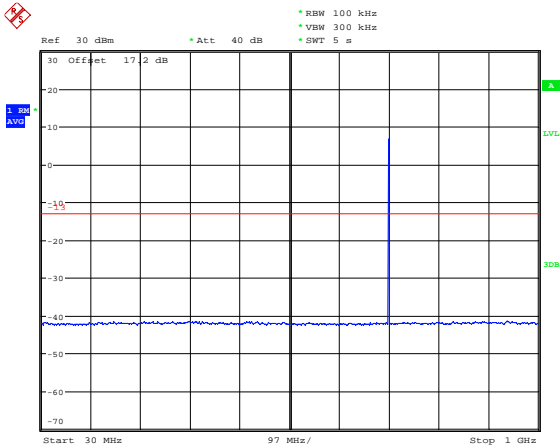

Date: 28.OCT.2019 19:39:58

### NB-IOT Band 12 CH Middle 1GHz~9GHz

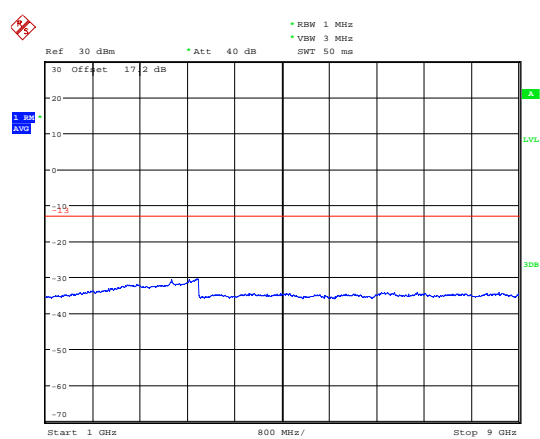

Date: 28.OCT.2019 19:38:49

### NB-IOT Band 12 CH High 30MHz~1GHz

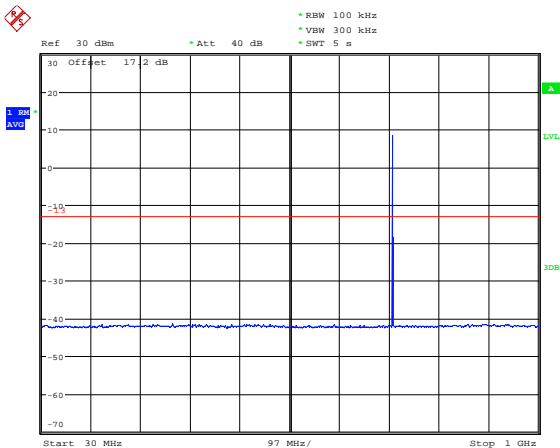

Date: 28.OCT.2019 19:41:35

### NB-IOT Band 12 CH High 1GHz~9GHz

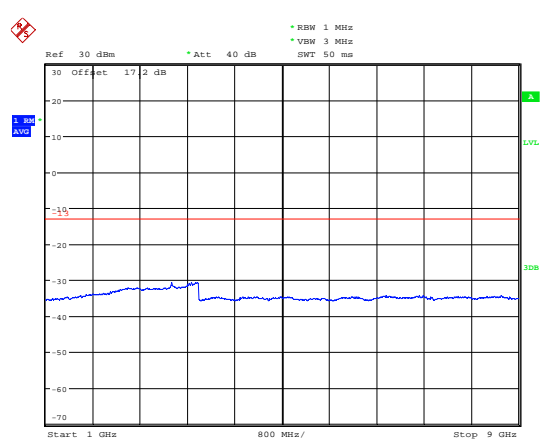

Date: 28.OCT.2019 19:42:05



### NB-IOT Band 13 CH Low 30MHz~1GHz

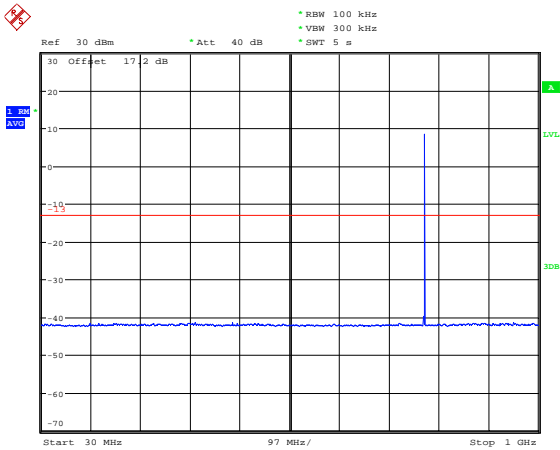

Date: 28.OCT.2019 19:45:00

### NB-IOT Band 13 CH Low 1GHz~9GHz

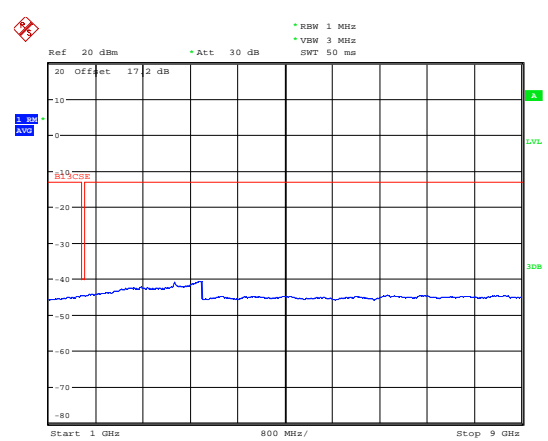

Date: 28.OCT.2019 21:01:46

### NB-IOT Band 13 CH Middle 30MHz~1GHz

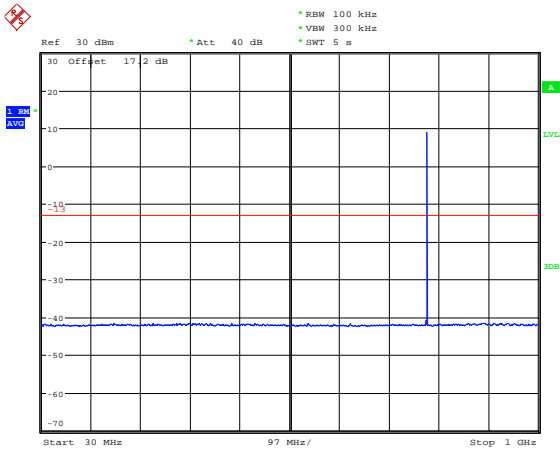

Date: 28.OCT.2019 19:46:53

### NB-IOT Band 13 CH Middle 1GHz~9GHz

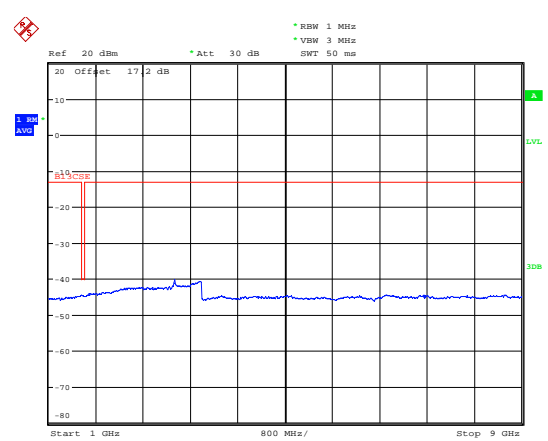

Date: 28.OCT.2019 21:03:01

### NB-IOT Band 13 CH High 30MHz~1GHz

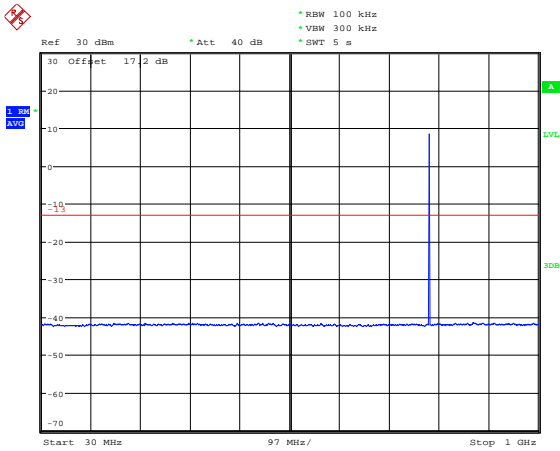

Date: 28.OCT.2019 19:48:41

### NB-IOT Band 13 CH High 1GHz~9GHz

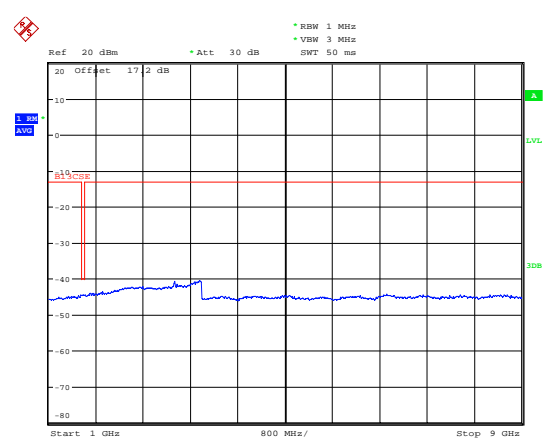

Date: 28.OCT.2019 21:03:42



### NB-IOT Band 66 CH Low 30MHz~1GHz

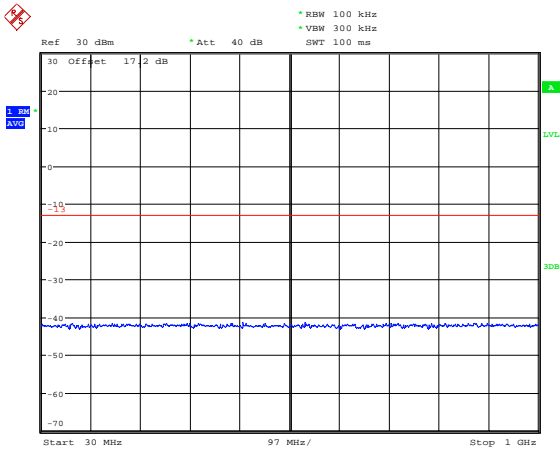

Date: 28.OCT.2019 20:26:29

### NB-IOT Band 66 CH Low 1GHz~20GHz

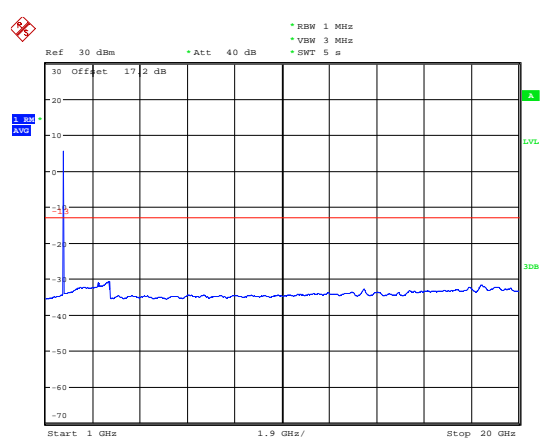

Date: 28.OCT.2019 20:27:07

### NB-IOT Band 66 CH Middle 30MHz~1GHz

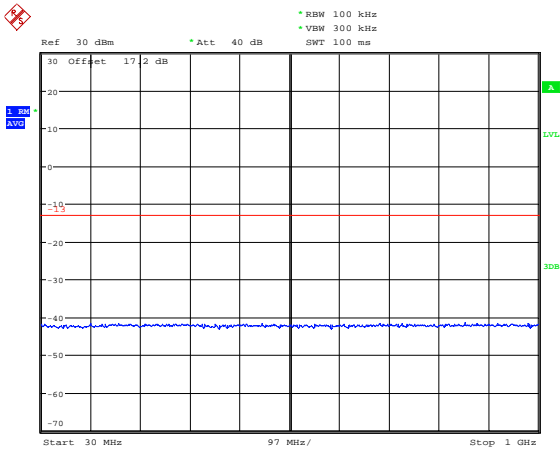

Date: 28.OCT.2019 20:29:15

### NB-IOT Band 66 CH Middle 1GHz~20GHz

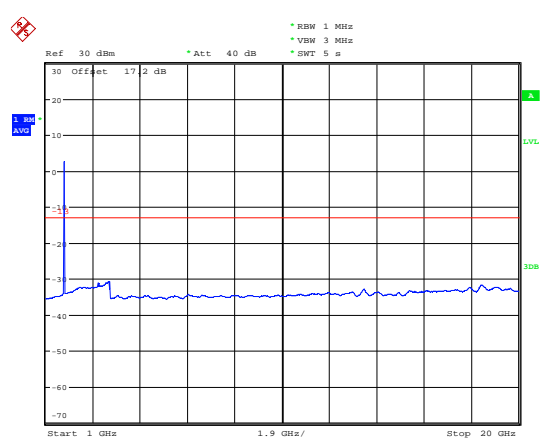

Date: 28.OCT.2019 20:28:27

### NB-IOT Band 66 CH High 30MHz~1GHz

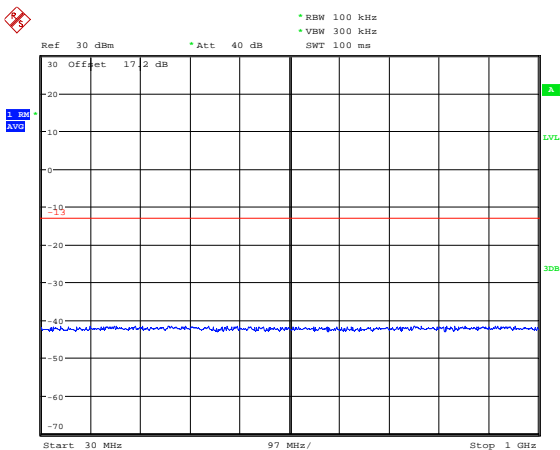

Date: 28.OCT.2019 20:30:34

### NB-IOT Band 66 CH High 1GHz~20GHz

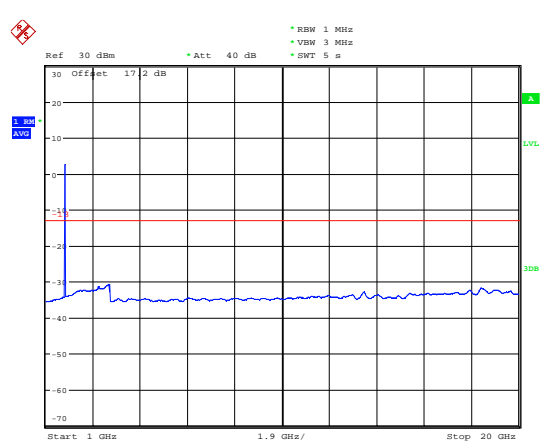

Date: 28.OCT.2019 20:31:08



### NB-IOT Band 71 CH Low 30MHz~1GHz

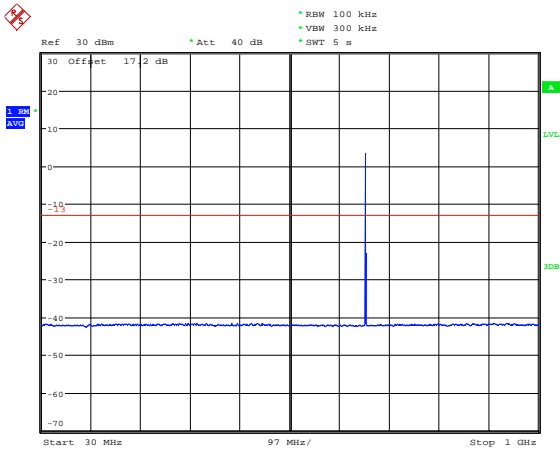

Date: 28.OCT.2019 20:37:42

### NB-IOT Band 71 CH Low 1GHz~9GHz

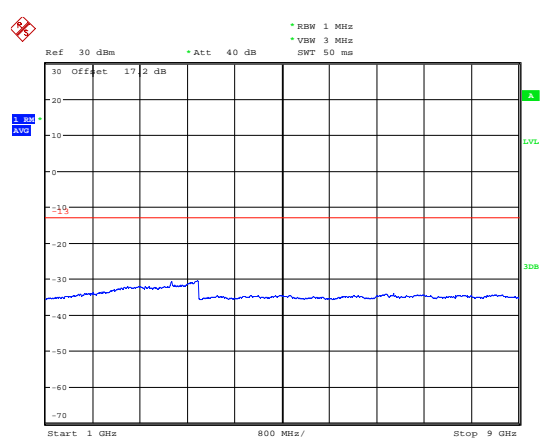

Date: 28.OCT.2019 20:38:08

### NB-IOT Band 71 CH Middle 30MHz~1GHz

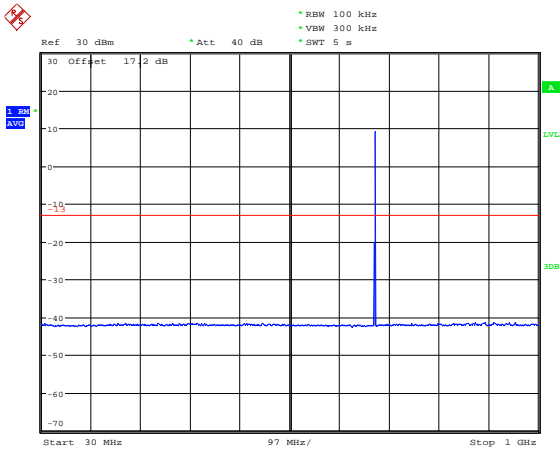

Date: 28.OCT.2019 20:40:30

### NB-IOT Band 71 CH Middle 1GHz~9GHz

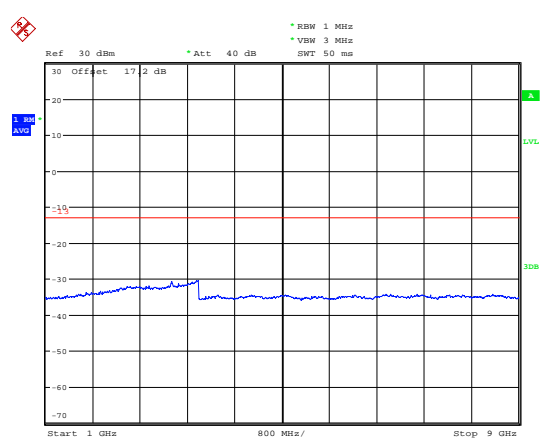

Date: 28.OCT.2019 20:39:39

### NB-IOT Band 71 CH High 30MHz~1GHz

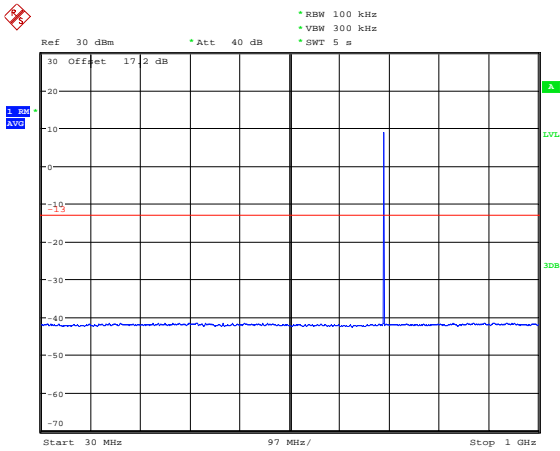

Date: 28.OCT.2019 20:43:20

### NB-IOT Band 71 CH High 1GHz~9GHz

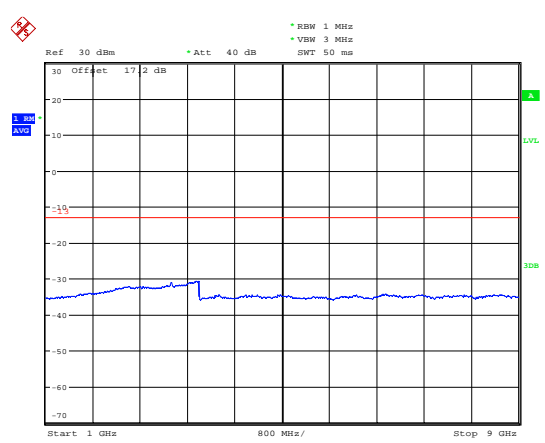

Date: 28.OCT.2019 20:43:43



### NB-IOT Band 85 CH Low 30MHz~1GHz

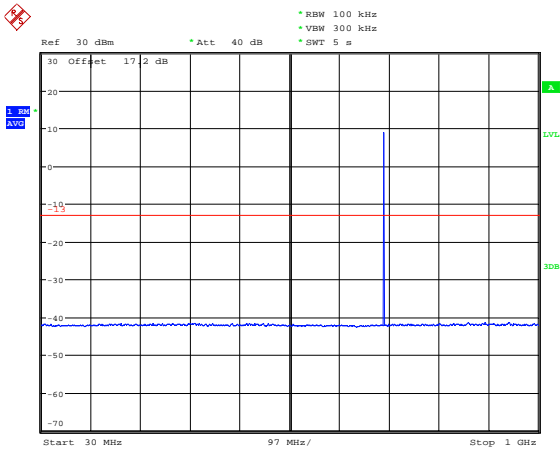

Date: 28.OCT.2019 20:47:57

### NB-IOT Band 85 CH Low 1GHz~9GHz

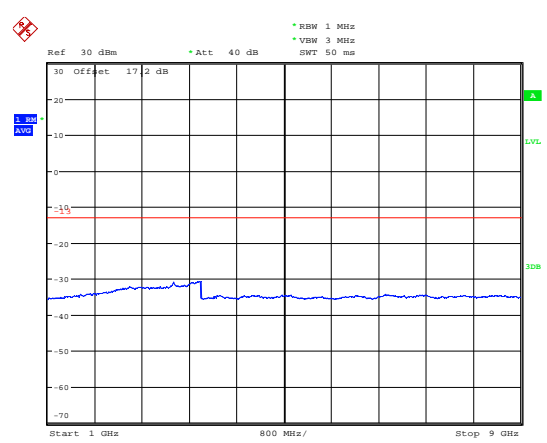

Date: 28.OCT.2019 20:48:19

### NB-IOT Band 85 CH Middle 30MHz~1GHz

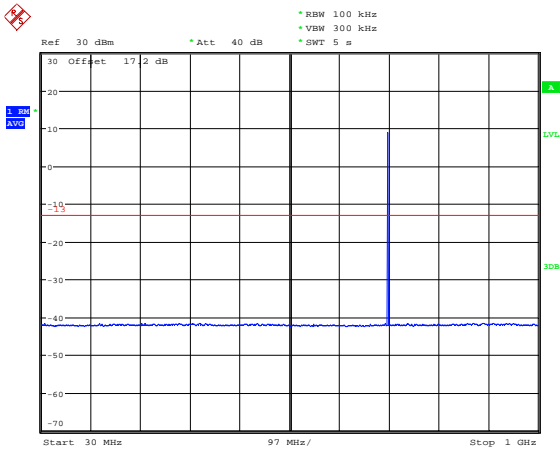

Date: 28.OCT.2019 20:49:27

### NB-IOT Band 85 CH Middle 1GHz~9GHz

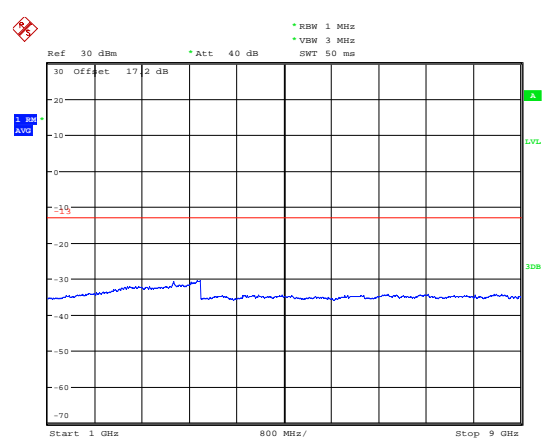

Date: 28.OCT.2019 20:48:54

### NB-IOT Band 85 CH High 30MHz~1GHz

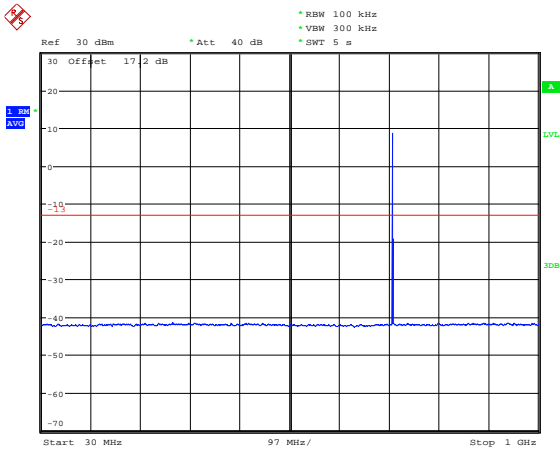

Date: 28.OCT.2019 20:50:57

### NB-IOT Band 85 CH High 1GHz~9GHz

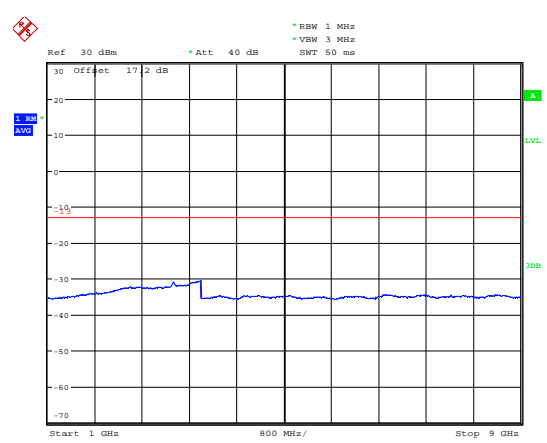

Date: 28.OCT.2019 20:51:16



## 5.7 Radiates Spurious Emission

### Ambient condition

Temperature	Relative humidity	Pressure
23°C ~25°C	45%~50%	101.5kPa

### Method of Measurement

- The testing follows FCC KDB 971168D01v03r01 Section 5.8 and ANSI C63.26 (2015).
- Below 1GHz:The EUT is placed on a turntable 0.8 meters above the ground in the chamber, 3 meter away from the antenna. The maximal emission value is acquired by adjusting the antenna height, polarisation and turntable azimuth. Normally, the height range of antenna is 1 m to 4 m, the azimuth range of turntable is 0° to 360°, and the receive antenna has two polarizations Vertical (V) and Horizontal (H). Above 1GHz:(Note: the FCC's permission to use 1.5m as an alternative per TCBC Conf call of Dec. 2, 2014.)The EUT is placed on a turntable 1.5 meters above the ground in the chamber, 3 meter away from the antenna. The maximal emission value is acquired by adjusting the antenna height, polarisation and turntable azimuth. Normally, the height range of antenna is 1 m to 4 m, the azimuth range of turntable is 0° to 360°, and the receive antenna has two polarizations Vertical (V) and Horizontal (H).
- A loop antenna, A log-periodic antenna or horn antenna shall be substituted in place of the EUT. The log-periodic antenna will be driven by a signal generator and the level will be adjusted till the same power value on the spectrum analyzer or receiver. The level of the spurious emissions can be calculated through the level of the signal generator, cable loss, the gain of the substitution antenna and the reading of the spectrum analyzer or receiver.
- The EUT is then put into continuously transmitting mode at its maximum power level during the test. Set Test Receiver or Spectrum RBW=200Hz, VBW=600Hz for 9kHz-150kHz, RBW=10kHz, VBW=30kHz-30MHz, RBW=100kHz, VBW=300kHz for 30MHz to 1GHz and RBW=1MHz, VBW=3MHz for above 1GHz And the maximum value of the receiver should be recorded as (Pr).
- The EUT shall be replaced by a substitution antenna. In the chamber, a substitution antenna for the frequency band of interest is placed at the reference point of the chamber. An RF Signal source for the frequency band of interest is connected to the substitution antenna with a cable that has been constructed to not interfere with the radiation pattern of the antenna. A power (P<sub>Mea</sub>) is applied to the input of the substitution antenna, and adjust the level of the signal generator output until the value of the receiver reach the previously recorded (Pr). The power of signal source (P<sub>Mea</sub>) is recorded. The test should be performed by rotating the test item and adjusting the receiving antenna polarization.
- An amplifier should be connected to the Signal Source output port. And the cable should be connect between the Amplifier and the Substitution Antenna. The cable loss (P<sub>cl</sub>), the Substitution Antenna Gain (G<sub>a</sub>) and the Amplifier Gain (P<sub>Ag</sub>) should be recorded after test.
- The measurement results are obtained as described below:  

$$\text{Power(EIRP)} = P_{Mea} - P_{Ag} - P_{cl} + G_a$$
 The measurement results are amend as described below:  

$$\text{Power(EIRP)} = P_{Mea} - P_{cl} + G_a$$
- This value is EIRP since the measurement is calibrated using an antenna of known gain (2.15 dBi)

and known input power. ERP can be calculated from EIRP by subtracting the gain of the dipole,  $ERP = EIRP - 2.15\text{dBi}$ .

The modulation mode and RB allocation refer to section 5.1, using the maximum output power configuration.

**Test setup**

**9KHz~ 30MHz**

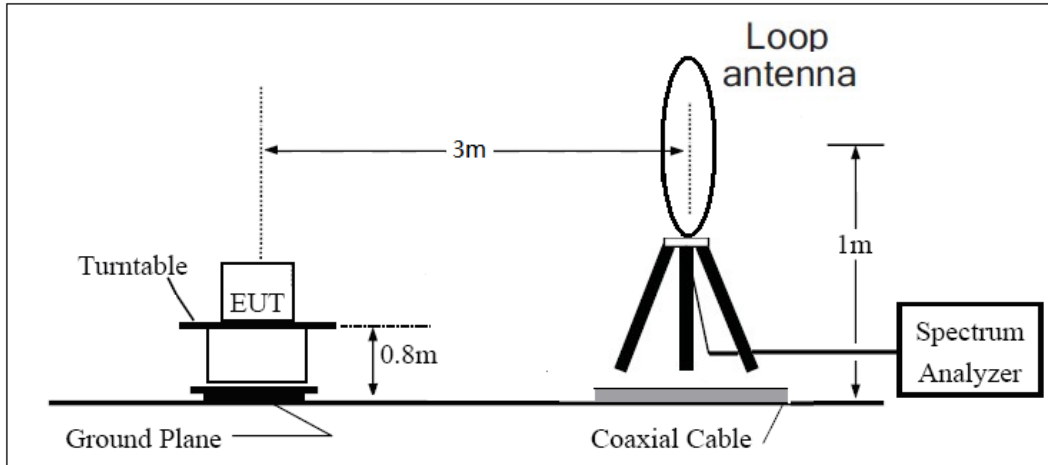

**30MHz~ 1GHz**

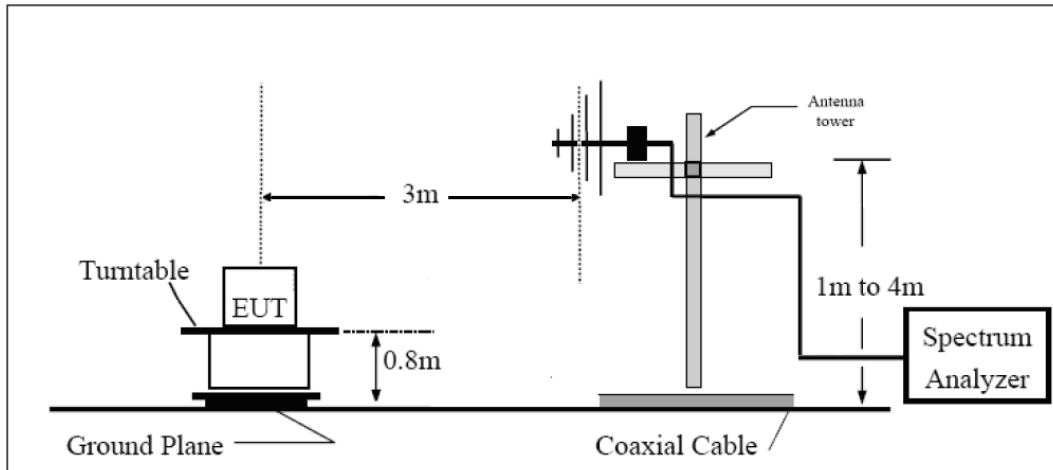

**Above 1GHz**

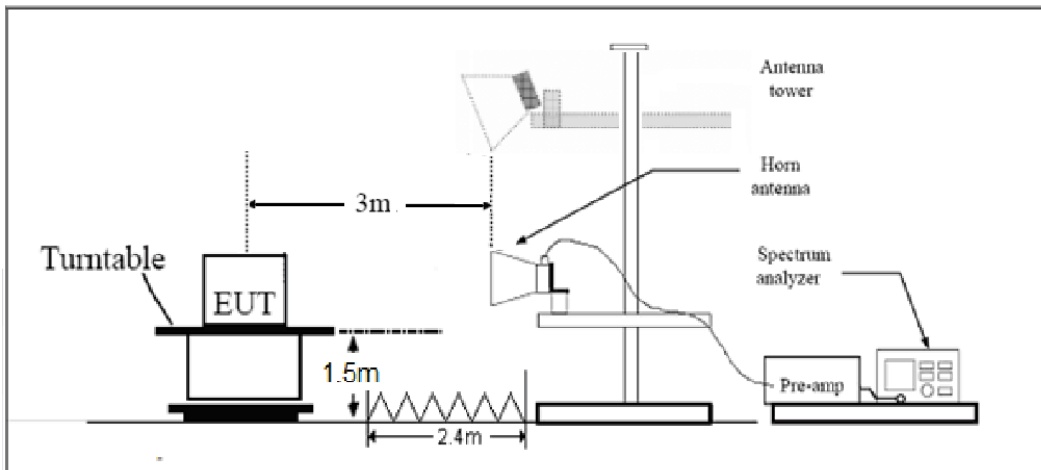

Note: Area side:2.4mX3.6m

**Limits**

Rule Part 27.53(h) specifies that “for operations in the 1695-1710 MHz, 1710-1755 MHz, 1755-1780 MHz, 1915-1920 MHz, 1995-2000 MHz, 2000-2020 MHz, 2110-2155 MHz, 2155-2180 MHz, and 2180-2200 bands, the power of any emission outside a licensee's frequency block shall be attenuated below the transmitter power (P) in watts by at least  $43 + 10 \log_{10} (P)$  dB.”

Rule Part 27.53 (g) For operations in the 600 MHz band and the 698-746 MHz band, the power of any emission outside a licensee's frequency band(s) of operation shall be attenuated below the transmitter power (P) within the licensed band(s) of operation, measured in watts, by at least  $43 + 10 \log (P)$  dB. Compliance with this provision is based on the use of measurement instrumentation employing a resolution bandwidth of 100 kilohertz or greater. However, in the 100 kilohertz bands immediately outside and adjacent to a licensee's frequency block, a resolution bandwidth of at least 30 kHz may be employed.

Rule Part 27.53(f) For operations in the 746-758 MHz, 775-788 MHz, and 805-806 MHz bands, emissions in the band 1559-1610 MHz shall be limited to  $-70$  dBW/MHz equivalent isotropically radiated power (EIRP) for wideband signals, and  $-80$  dBW EIRP for discrete emissions of less than 700 Hz bandwidth. For the purpose of equipment authorization, a transmitter shall be tested with an antenna that is representative of the type that will be used with the equipment in normal operation.

Part 27.53(a)/(h)/(g) Limit		-13 dBm
Part 27.53(f) Limit	Limit out of the band 1559-1610 MHz	-13 dBm
	Limit in the band 1559-1610 MHz	-40 dBm
Part 27.53(m) Limit		-25 dBm

**Measurement Uncertainty**

The assessed measurement uncertainty to ensure 95% confidence level for the normal distribution is with the coverage factor  $k = \pm 1.96$ ,  $U = \pm 3.55$  dB.

**Test Result**

Sweep the whole frequency band through the range from 9kHz to the 10th harmonic of the carrier, the emissions below the noise floor will not be recorded in the report.

NB-IOT Band 4 BPSK 15KHz CH-Low

Harmonic	Frequency (MHz)	SG (dBm)	Cable Loss (dB)	Gain (dBi)	Antenna Polarization	EIRP Level (dBm)	Limit (dBm)	Margin (dB)	Azimuth (deg)
2	3420.2	-50.45	2.6	10.15	Horizontal	-42.90	-13.00	29.90	45
3	5130.3	-57.95	2.4	11.35	Horizontal	-49.00	-13.00	36.00	0
4	6840.4	-55.45	4.5	10.85	Horizontal	-49.10	-13.00	36.10	0
5	8550.5	-53.25	5.1	11.35	Horizontal	-47.00	-13.00	34.00	90
6	10260.6	-51.75	5.3	11.95	Horizontal	-45.10	-13.00	32.10	135
7	11970.7	-52.35	5.5	13.55	Horizontal	-44.30	-13.00	31.30	180
8	13680.8	-49.85	6.3	13.75	Horizontal	-42.40	-13.00	29.40	270
9	15390.9	-49.55	6.7	13.85	Horizontal	-42.40	-13.00	29.40	225
10	17101.0	-44.55	6.8	14.25	Horizontal	-37.10	-13.00	24.10	135

Note: 1.The other Spurious RF Radiated emissions level is no more than noise floor.

2. The worst emission was found in the antenna is Horizontal position.

NB-IOT Band 4 BPSK 15KHz CH-Middle

Harmonic	Frequency (MHz)	SG (dBm)	Cable Loss (dB)	Gain (dBi)	Antenna Polarization	EIRP Level (dBm)	Limit (dBm)	Margin (dB)	Azimuth (deg)
2	3465.0	-54.85	2.6	10.75	Horizontal	-46.70	-13.00	33.70	180
3	5197.5	-57.25	2.4	11.05	Horizontal	-48.60	-13.00	35.60	315
4	6930.0	-58.95	4.5	11.15	Horizontal	-52.30	-13.00	39.30	270
5	8662.5	-52.89	5.1	11.35	Horizontal	-46.64	-13.00	33.64	225
6	10395.0	-49.15	5.3	11.95	Horizontal	-42.50	-13.00	29.50	90
7	12127.5	-51.74	5.5	13.55	Horizontal	-43.69	-13.00	30.69	45
8	13860.0	-49.75	6.3	13.75	Horizontal	-42.30	-13.00	29.30	0
9	15592.5	-50.15	6.7	13.85	Horizontal	-43.00	-13.00	30.00	90
10	17325.0	-46.13	6.8	14.25	Horizontal	-38.68	-13.00	25.68	135

Note: 1.The other Spurious RF Radiated emissions level is no more than noise floor.

2. The worst emission was found in the antenna is Horizontal position.



## NB-IOT Band 4 BPSK 15KHz CH-High

Harmonic	Frequency (MHz)	SG (dBm)	Cable Loss (dB)	Gain (dBi)	Antenna Polarization	EIRP Level (dBm)	Limit (dBm)	Margin (dB)	Azimuth (deg)
2	3509.8	-60.05	2.6	10.15	Horizontal	-52.50	-13.00	39.50	0
3	5264.7	-57.95	2.4	11.05	Horizontal	-49.30	-13.00	36.30	90
4	7019.6	-56.65	4.5	11.15	Horizontal	-50.00	-13.00	37.00	45
5	8774.5	-52.74	5.1	11.35	Horizontal	-46.49	-13.00	33.49	135
6	10529.4	-50.55	5.3	11.95	Horizontal	-43.90	-13.00	30.90	90
7	12284.3	-50.04	5.5	13.55	Horizontal	-41.99	-13.00	28.99	315
8	14039.2	-50.25	6.3	13.75	Horizontal	-42.80	-13.00	29.80	270
9	15794.1	-49.55	6.7	13.85	Horizontal	-42.40	-13.00	29.40	135
10	17549.0	-44.85	6.8	14.25	Horizontal	-37.40	-13.00	24.40	225

Note: 1.The other Spurious RF Radiated emissions level is no more than noise floor.

2. The worst emission was found in the antenna is Horizontal position.

## NB-IOT Band 12BPSK 15KHz CH-Low

Harmonic	Frequency (MHz)	SG (dBm)	Cable Loss (dB)	Gain (dBi)	Antenna Polarization	ERP Level (dBm)	Limit (dBm)	Margin (dB)	Azimuth (deg)
2	1398.2	-48.21	2.00	10.15	Horizontal	-42.21	-13.00	29.21	90
3	2097.3	-55.55	2.50	11.35	Horizontal	-48.85	-13.00	35.85	45
4	2796.4	-54.18	4.20	10.85	Horizontal	-49.68	-13.00	36.68	315
5	3495.5	-56.20	5.20	11.35	Horizontal	-52.20	-13.00	39.20	135
6	4194.6	-54.80	5.50	11.95	Horizontal	-50.50	-13.00	37.50	225
7	4893.7	-55.20	5.70	13.55	Horizontal	-49.50	-13.00	36.50	180
8	5592.8	-54.80	6.30	13.75	Horizontal	-49.50	-13.00	36.50	135
9	6291.9	-54.40	6.80	13.85	Horizontal	-49.50	-13.00	36.50	225
10	6991.0	-56.90	6.90	14.25	Horizontal	-51.70	-13.00	38.70	135

Note: 1.The other Spurious RF Radiated emissions level is no more than noise floor.

2. The worst emission was found in the antenna is Horizontal position.



## NB-IOT Band 13BPSK 15KHz CH-Middle

Harmonic	Frequency (MHz)	SG (dBm)	Cable Loss (dB)	Gain (dBi)	Antenna Polarization	ERP Level (dBm)	Limit (dBm)	Margin (dB)	Azimuth (deg)
2	1415.0	-47.28	2.00	10.75	Horizontal	-40.68	-13.00	27.68	45
3	2122.5	-52.30	2.51	11.05	Horizontal	-45.91	-13.00	32.91	135
4	2830.0	-52.95	4.20	11.15	Horizontal	-48.15	-13.00	35.15	45
5	3537.5	-55.89	5.20	11.15	Horizontal	-52.09	-13.00	39.09	90
6	4245.0	-53.55	5.50	11.95	Horizontal	-49.25	-13.00	36.25	315
7	4952.5	-54.50	5.70	13.55	Horizontal	-48.80	-13.00	35.80	90
8	5660.0	-53.40	6.30	13.75	Horizontal	-48.10	-13.00	35.10	45
9	6367.5	-55.10	6.80	13.85	Horizontal	-50.20	-13.00	37.20	135
10	7075.0	-54.77	6.90	14.25	Horizontal	-49.57	-13.00	36.57	45

Note: 1.The other Spurious RF Radiated emissions level is no more than noise floor.

2. The worst emission was found in the antenna is Horizontal position.

## NB-IOT Band 12BPSK 15KHz CH-High

Harmonic	Frequency (MHz)	SG (dBm)	Cable Loss (dB)	Gain (dBi)	Antenna Polarization	ERP Level (dBm)	Limit (dBm)	Margin (dB)	Azimuth (deg)
2	1431.8	-51.54	2.00	10.15	Horizontal	-45.54	-13.00	32.54	225
3	2147.7	-56.50	2.51	11.05	Horizontal	-50.11	-13.00	37.11	180
4	2863.6	-53.21	4.20	11.15	Horizontal	-48.41	-13.00	35.41	135
5	3579.5	-56.08	5.20	11.15	Horizontal	-52.28	-13.00	39.28	225
6	4295.4	-53.60	5.50	11.95	Horizontal	-49.30	-13.00	36.30	135
7	5011.3	-53.50	5.70	13.55	Horizontal	-47.80	-13.00	34.80	225
8	5727.2	-53.30	6.30	13.75	Horizontal	-48.00	-13.00	35.00	180
9	6443.1	-55.10	6.80	13.85	Horizontal	-50.20	-13.00	37.20	135
10	7159.0	-55.00	6.90	14.25	Horizontal	-49.80	-13.00	36.80	225

Note: 1.The other Spurious RF Radiated emissions level is no more than noise floor.

2. The worst emission was found in the antenna is Horizontal position.



## NB-IOT Band 13BPSK 15KHz CH-Low

Harmonic	Frequency (MHz)	SG (dBm)	Cable Loss (dB)	Gain (dBi)	Antenna Polarization	ERP Level (dBm)	Limit (dBm)	Margin (dB)	Azimuth (deg)
2	1554.2	-53.65	2.00	10.15	Horizontal	-47.65	-40.00	7.65	315
3	2331.3	-46.14	2.50	11.35	Horizontal	-39.44	-13.00	26.44	315
4	3108.4	-53.90	4.20	10.85	Horizontal	-49.40	-13.00	36.40	135
5	3885.5	-54.90	5.20	11.35	Horizontal	-50.90	-13.00	37.90	225
6	4662.6	-54.70	5.50	11.95	Horizontal	-50.40	-13.00	37.40	180
7	5439.7	-54.30	5.70	13.55	Horizontal	-48.60	-13.00	35.60	180
8	6216.8	-55.30	6.30	13.75	Horizontal	-50.00	-13.00	37.00	270
9	6993.9	-56.30	6.80	13.85	Horizontal	-51.40	-13.00	38.40	315
10	7771.0	-53.30	6.90	14.25	Horizontal	-48.10	-13.00	35.10	45

Note: 1.The other Spurious RF Radiated emissions level is no more than noise floor.

2. The worst emission was found in the antenna is Horizontal position.

## NB-IOT Band 13BPSK 15KHz CH-Middle

Harmonic	Frequency (MHz)	SG (dBm)	Cable Loss (dB)	Gain (dBi)	Antenna Polarization	EIRP Level (dBm)	Limit (dBm)	Margin (dB)	Azimuth (deg)
2	1564.0	-53.76	2.00	10.75	Horizontal	-47.16	-40.00	7.16	180
3	2346.0	-46.85	2.51	11.05	Horizontal	-40.46	-13.00	27.46	90
4	3128.0	-55.14	4.20	11.15	Horizontal	-50.34	-13.00	37.34	45
5	3910.0	-54.19	5.20	11.15	Horizontal	-50.39	-13.00	37.39	315
6	4692.0	-54.30	5.50	11.95	Horizontal	-50.00	-13.00	37.00	135
7	5474.0	-54.30	5.70	13.55	Horizontal	-48.60	-13.00	35.60	45
8	6256.0	-55.00	6.30	13.75	Horizontal	-49.70	-13.00	36.70	90
9	7038.0	-55.40	6.80	13.85	Horizontal	-50.50	-13.00	37.50	315
10	7820.0	-52.50	6.90	14.25	Horizontal	-47.30	-13.00	34.30	90

Note: 1.The other Spurious RF Radiated emissions level is no more than noise floor.

2. The worst emission was found in the antenna is Horizontal position.



## NB-IOT Band 13BPSK 15KHz CH-High

Harmonic	Frequency (MHz)	SG (dBm)	Cable Loss (dB)	Gain (dBi)	Antenna Polarization	ERP Level (dBm)	Limit (dBm)	Margin (dB)	Azimuth (deg)
2	1573.8	-53.46	2.00	10.15	Horizontal	-47.46	-40.00	7.46	0
3	2360.7	-50.30	2.51	11.05	Horizontal	-43.91	-13.00	30.91	0
4	3147.6	-52.80	4.20	11.15	Horizontal	-48.00	-13.00	35.00	90
5	3934.5	-54.60	5.20	11.15	Horizontal	-50.80	-13.00	37.80	135
6	4721.4	-53.90	5.50	11.95	Horizontal	-49.60	-13.00	36.60	180
7	5508.3	-54.50	5.70	13.55	Horizontal	-48.80	-13.00	35.80	270
8	6295.2	-56.10	6.30	13.75	Horizontal	-50.80	-13.00	37.80	225
9	7082.1	-55.00	6.80	13.85	Horizontal	-50.10	-13.00	37.10	90
10	7869.0	-51.90	6.90	14.25	Horizontal	-46.70	-13.00	33.70	315

Note: 1. The other Spurious RF Radiated emissions level is no more than noise floor.

2. The worst emission was found in the antenna is Horizontal position.

## NB-IOT Band 66BPSK 15KHz CH-Low

Harmonic	Frequency (MHz)	SG (dBm)	Cable Loss (dB)	Gain (dBi)	Antenna Polarization	EIRP Level (dBm)	Limit (dBm)	Margin (dB)	Azimuth (deg)
2	3420.0	-57.70	2.6	10.15	Horizontal	-50.15	-13.00	37.15	315
3	5130.0	-57.71	2.4	11.35	Horizontal	-48.76	-13.00	35.76	0
4	6840.0	-57.05	4.5	10.85	Horizontal	-50.70	-13.00	37.70	135
5	8550.0	-53.13	5.1	11.35	Horizontal	-46.88	-13.00	33.88	225
6	10260.0	-50.87	5.3	11.95	Horizontal	-44.22	-13.00	31.22	45
7	11970.0	-51.78	5.5	13.55	Horizontal	-43.73	-13.00	30.73	90
8	13680.0	-49.10	6.3	13.75	Horizontal	-41.65	-13.00	28.65	180
9	15390.0	-49.03	6.7	13.85	Horizontal	-41.88	-13.00	28.88	225
10	17100.0	-45.29	6.8	14.25	Horizontal	-37.84	-13.00	24.84	90

Note: 1. The other Spurious RF Radiated emissions level is no more than noise floor.

2. The worst emission was found in the antenna is Horizontal position.





## NB-IOT Band 66BPSK 15KHz CH-Middle

Harmonic	Frequency (MHz)	SG (dBm)	Cable Loss (dB)	Gain (dBi)	Antenna Polarization	EIRP Level (dBm)	Limit (dBm)	Margin (dB)	Azimuth (deg)
2	3490.0	-59.55	2.6	10.75	Horizontal	-51.40	-13.00	38.40	0
3	5235.0	-57.64	2.4	11.05	Horizontal	-48.99	-13.00	35.99	90
4	6980.0	-57.51	4.5	11.15	Horizontal	-50.86	-13.00	37.86	45
5	8725.0	-51.52	5.1	11.35	Horizontal	-45.27	-13.00	32.27	315
6	10470.0	-50.41	5.3	11.95	Horizontal	-43.76	-13.00	30.76	225
7	12215.0	-50.37	5.5	13.55	Horizontal	-42.32	-13.00	29.32	180
8	13960.0	-49.20	6.3	13.75	Horizontal	-41.75	-13.00	28.75	45
9	15705.0	-48.32	6.7	13.85	Horizontal	-41.17	-13.00	28.17	45
10	17450.0	-45.39	6.8	14.25	Horizontal	-37.94	-13.00	24.94	90

Note: 1.The other Spurious RF Radiated emissions level is no more than noise floor.

2. The worst emission was found in the antenna is Horizontal position.

## NB-IOT Band 66BPSK 15KHz CH-High

Harmonic	Frequency (MHz)	SG (dBm)	Cable Loss (dB)	Gain (dBi)	Antenna Polarization	EIRP Level (dBm)	Limit (dBm)	Margin (dB)	Azimuth (deg)
2	3559.8	-59.07	2.6	10.15	Horizontal	-51.52	-13.00	38.52	45
3	5339.7	-57.94	2.4	11.05	Horizontal	-49.29	-13.00	36.29	225
4	7119.6	-56.61	4.5	11.15	Horizontal	-49.96	-13.00	36.96	90
5	8899.5	-52.42	5.1	11.35	Horizontal	-46.17	-13.00	33.17	180
6	10679.4	-49.98	5.3	11.95	Horizontal	-43.33	-13.00	30.33	45
7	12459.3	-50.28	5.5	13.55	Horizontal	-42.23	-13.00	29.23	0
8	14239.2	-49.60	6.3	13.75	Horizontal	-42.15	-13.00	29.15	135
9	16019.1	-47.63	6.7	13.85	Horizontal	-40.48	-13.00	27.48	180
10	17799.0	-45.88	6.8	14.25	Horizontal	-38.43	-13.00	25.43	315

Note: 1.The other Spurious RF Radiated emissions level is no more than noise floor.

2. The worst emission was found in the antenna is Horizontal position.



## NB-IOT Band 71BPSK 15KHz CH-Low

Harmonic	Frequency (MHz)	SG (dBm)	Cable Loss (dB)	Gain (dBi)	Antenna Polarization	ERP Level (dBm)	Limit (dBm)	Margin (dB)	Azimuth (deg)
2	1326.2	-44.73	2.00	10.15	Horizontal	-38.73	-13.00	25.73	315
3	1989.3	-44.88	2.50	11.35	Horizontal	-38.18	-13.00	25.18	225
4	2652.4	-54.30	4.20	10.85	Horizontal	-49.80	-13.00	36.80	180
5	3315.5	-53.53	5.20	11.35	Horizontal	-49.53	-13.00	36.53	90
6	3978.6	-61.49	5.50	11.95	Horizontal	-57.19	-13.00	44.19	0
7	4641.7	-61.46	5.70	13.55	Horizontal	-55.76	-13.00	42.76	315
8	5304.8	-61.88	6.30	13.75	Horizontal	-56.58	-13.00	43.58	225
9	5967.9	-59.33	6.80	13.85	Horizontal	-54.43	-13.00	41.43	90
10	6631.0	-59.08	6.90	14.25	Horizontal	-53.88	-13.00	40.88	0

Note: 1.The other Spurious RF Radiated emissions level is no more than noise floor.  
2. The worst emission was found in the antenna is Horizontal position.

## NB-IOT Band 71BPSK 15KHz CH-Middle

Harmonic	Frequency (MHz)	SG (dBm)	Cable Loss (dB)	Gain (dBi)	Antenna Polarization	ERP Level (dBm)	Limit (dBm)	Margin (dB)	Azimuth (deg)
2	1361.0	-53.38	2.00	10.75	Horizontal	-46.78	-13.00	33.78	0
3	2041.5	-47.07	2.51	11.05	Horizontal	-40.68	-13.00	27.68	135
4	2722.0	-55.87	4.20	11.15	Horizontal	-51.07	-13.00	38.07	225
5	3402.5	-59.90	5.20	11.15	Horizontal	-56.10	-13.00	43.10	45
6	4083.0	-61.16	5.50	11.95	Horizontal	-56.86	-13.00	43.86	0
7	4763.5	-61.16	5.70	13.55	Horizontal	-55.46	-13.00	42.46	270
8	5444.0	-61.73	6.30	13.75	Horizontal	-56.43	-13.00	43.43	135
9	6124.5	-59.66	6.80	13.85	Horizontal	-54.76	-13.00	41.76	90
10	6805.0	-58.30	6.90	14.25	Horizontal	-53.10	-13.00	40.10	180

Note: 1.The other Spurious RF Radiated emissions level is no more than noise floor.  
2. The worst emission was found in the antenna is Horizontal position.



## NB-IOT Band 71BPSK 15KHz CH-High

Harmonic	Frequency (MHz)	SG (dBm)	Cable Loss (dB)	Gain (dBi)	Antenna Polarization	ERP Level (dBm)	Limit (dBm)	Margin (dB)	Azimuth (deg)
2	1395.8	-46.89	2.00	10.15	Horizontal	-40.89	-13.00	27.89	135
3	2093.7	-56.79	2.51	11.05	Horizontal	-50.40	-13.00	37.40	270
4	2791.6	-53.97	4.20	11.15	Horizontal	-49.17	-13.00	36.17	225
5	3489.5	-58.83	5.20	11.15	Horizontal	-55.03	-13.00	42.03	180
6	4187.4	-60.31	5.50	11.95	Horizontal	-56.01	-13.00	43.01	45
7	4885.3	-60.74	5.70	13.55	Horizontal	-55.04	-13.00	42.04	135
8	5583.2	-60.35	6.30	13.75	Horizontal	-55.05	-13.00	42.05	90
9	6281.1	-58.68	6.80	13.85	Horizontal	-53.78	-13.00	40.78	45
10	6979.0	-57.25	6.90	14.25	Horizontal	-52.05	-13.00	39.05	270

Note: 1.The other Spurious RF Radiated emissions level is no more than noise floor.

2. The worst emission was found in the antenna is Horizontal position.

## NB-IOT Band 85BPSK 15KHz CH-Low

Harmonic	Frequency (MHz)	SG (dBm)	Cable Loss (dB)	Gain (dBi)	Antenna Polarization	ERP Level (dBm)	Limit (dBm)	Margin (dB)	Azimuth (deg)
2	1395.8	-41.58	2.00	10.15	Horizontal	-35.58	-13.00	22.58	0
3	2184.0	-56.66	2.50	11.35	Horizontal	-49.96	-13.00	36.96	45
4	2792.3	-52.12	4.20	10.85	Horizontal	-47.62	-13.00	34.62	90
5	3490.5	-58.05	5.20	11.35	Horizontal	-54.05	-13.00	41.05	90
6	4188.6	-58.43	5.50	11.95	Horizontal	-54.13	-13.00	41.13	45
7	4886.7	-60.91	5.70	13.55	Horizontal	-55.21	-13.00	42.21	90
8	5584.8	-58.72	6.30	13.75	Horizontal	-53.42	-13.00	40.42	180
9	6282.9	-57.13	6.80	13.85	Horizontal	-52.23	-13.00	39.23	225
10	6981.0	-54.61	6.90	14.25	Horizontal	-49.41	-13.00	36.41	135

Note: 1.The other Spurious RF Radiated emissions level is no more than noise floor.

2. The worst emission was found in the antenna is Horizontal position.



## NB-IOT Band 85BPSK 15KHz CH-Middle

Harmonic	Frequency (MHz)	SG (dBm)	Cable Loss (dB)	Gain (dBi)	Antenna Polarization	ERP Level (dBm)	Limit (dBm)	Margin (dB)	Azimuth (deg)
2	1411.8	-54.00	2.00	10.75	Horizontal	-47.40	-13.00	34.40	180
3	2117.7	-55.06	2.51	11.05	Horizontal	-48.67	-13.00	35.67	225
4	2823.6	-60.07	4.20	11.15	Horizontal	-55.27	-13.00	42.27	135
5	3529.5	-59.52	5.20	11.15	Horizontal	-55.72	-13.00	42.72	90
6	4235.4	-59.55	5.50	11.95	Horizontal	-55.25	-13.00	42.25	0
7	4941.3	-60.09	5.70	13.55	Horizontal	-54.39	-13.00	41.39	45
8	5647.2	-59.49	6.30	13.75	Horizontal	-54.19	-13.00	41.19	90
9	6353.1	-57.26	6.80	13.85	Horizontal	-52.36	-13.00	39.36	225
10	7059.0	-55.06	6.90	14.25	Horizontal	-49.86	-13.00	36.86	135

Note: 1.The other Spurious RF Radiated emissions level is no more than noise floor.  
2. The worst emission was found in the antenna is Horizontal position.

## NB-IOT Band 85BPSK 15KHz CH-High

Harmonic	Frequency (MHz)	SG (dBm)	Cable Loss (dB)	Gain (dBi)	Antenna Polarization	ERP Level (dBm)	Limit (dBm)	Margin (dB)	Azimuth (deg)
2	1431.8	-45.71	2.00	10.15	Horizontal	-39.71	-13.00	26.71	135
3	2147.5	-54.12	2.51	11.05	Horizontal	-47.73	-13.00	34.73	225
4	2863.3	-52.18	4.20	11.15	Horizontal	-47.38	-13.00	34.38	315
5	3579.5	-58.60	5.20	11.15	Horizontal	-54.80	-13.00	41.80	45
6	4295.4	-59.11	5.50	11.95	Horizontal	-54.81	-13.00	41.81	90
7	5011.3	-60.62	5.70	13.55	Horizontal	-54.92	-13.00	41.92	0
8	5727.2	-58.45	6.30	13.75	Horizontal	-53.15	-13.00	40.15	45
9	6443.1	-56.09	6.80	13.85	Horizontal	-51.19	-13.00	38.19	135
10	7159.0	-54.62	6.90	14.25	Horizontal	-49.42	-13.00	36.42	315

Note: 1.The other Spurious RF Radiated emissions level is no more than noise floor.  
2. The worst emission was found in the antenna is Horizontal position.



## 6 Main Test Instruments

Name	Manufacturer	Type	Serial Number	Calibration Date	Expiration Date
Base Station Simulator	R&S	CMW500	113824	2019-05-19	2020-05-18
Power Splitter	Hua Xiang	SHX-GF2-2-13	10120101	/	/
Spectrum Analyzer	Key sight	N9010A	MY50210259	2019-05-19	2020-05-18
Signal Analyzer	R&S	FSV40	101298	2019-05-19	2020-05-18
Loop Antenna	SCHWARZBECK	FMZB1519	1519-047	2017-09-26	2020-09-25
Trilog Antenna	SCHWARZBECK	VUBL 9163	9163-201	2017-11-18	2020-11-17
Horn Antenna	R&S	HF907	100126	2018-07-07	2020-07-06
Horn Antenna	ETS-Lindgren	3160-09	00102643	2018-06-20	2020-06-19
Horn Antenna	STEATITE	QSH-SL-26-40-K-15	16779	2017-07-20	2020-07-19
Signal generator	R&S	SMB 100A	102594	2019-05-19	2020-05-18
Climatic Chamber	ESPEC	SU-242	93000506	2017-12-17	2020-12-16
Preamplifier	R&S	SCU18	102327	2019-05-19	2020-05-18
MOB COMMS DC SUPPLY	Keysight	66319D	MY43004105	2019-05-19	2020-05-18
RF Cable	Agilent	SMA 15cm	0001	2019-12-13	2020-6-12
Software	R&S	EMC32	9.26.0	/	/

\*\*\*\*\*END OF REPORT \*\*\*\*\*