



# RF TEST REPORT

**Applicant**      Quectel Wireless Solutions Co., Ltd  
**FCC ID**            XMR201912BG77  
**Product**          LTE Cat M1 & Cat NB2 Module  
**Brand**             Quectel  
**Model**             BG77  
**Report No.**       R1909A0576-R2V1  
**Issue Date**      April 3, 2020

TA Technology (Shanghai) Co., Ltd. tested the above equipment in accordance with the requirements in **FCC CFR47 Part 2 (2019)/ FCC CFR 47 Part 24E (2019)**. The test results show that the equipment tested is capable of demonstrating compliance with the requirements as documented in this report.

Performed by: Peng Tao

Approved by: Kai Xu

---

## TA Technology (Shanghai) Co., Ltd.

No.145, Jintang Rd, Tangzhen Industry Park, Pudong Shanghai, China

TEL: +86-021-50791141/2/3

FAX: +86-021-50791141/2/3-8000



# TABLE OF CONTENT

- 1. Test Laboratory .....4
  - 1.1. Notes of the test report.....4
  - 1.2. Test facility.....4
  - 1.3. Testing Location .....4
- 2. General Description of Equipment under Test.....5
  - 2.3. Applicant and Manufacturer Information .....5
  - 2.4. General information .....5
- 3. Applied Standards.....6
- 4. Test Configuration.....7
- 5. Test Case Results.....8
  - 5.1. RF Power Output and Effective Isotropic Radiated Power .....8
  - 5.2. Occupied Bandwidth .....12
  - 5.3. Band Edge Compliance.....19
  - 5.4. Peak-to-Average Power Ratio (PAPR) .....24
  - 5.5. Frequency Stability .....26
  - 5.6. Spurious Emissions at Antenna Terminals .....31
  - 5.7. Radiates Spurious Emission .....34
- 6. Main Test Instruments .....40



## Summary of measurement results

No.	Test Case	Clause in FCC rules	Verdict
1	RF Power Output and Effective Isotropic Radiated Power	2.1046 24.232(c)	PASS
2	Occupied Bandwidth	2.1049	PASS
3	Band Edge Compliance	2.1051 /24.238(a)	PASS
4	Peak-to-Average Power Ratio	24.232/KDB 971168 D01(5.7)	PASS
5	Frequency Stability	2.1055 / 24.235	PASS
6	Spurious Emissions at Antenna Terminals	2.1051 / 24.238(a)	PASS
7	Radiates Spurious Emission	2.1053 / 24.238(a)	PASS

Date of Testing: November 28, 2019~ March 11, 2020

Note: PASS: The EUT complies with the essential requirements in the standard.

FAIL: The EUT does not comply with the essential requirements in the standard.

All indications of Pass/Fail in this report are opinions expressed by TA Technology (Shanghai) Co., Ltd. based on interpretations and/or observations of test results. Measurement Uncertainties were not taken into account and are published for informational purposes only.

**Note: This revised report (Report No.: R1909A0576-R2V1) supersedes and replaces the previously issued report (Report No.: R1909A0576-R2). Please discard or destroy the previously issued report and dispose of it accordingly.**



## 1. Test Laboratory

### 1.1. Notes of the test report

This report shall not be reproduced in full or partial, without the written approval of **TA technology (shanghai) co., Ltd.** The results documented in this report apply only to the tested sample, under the conditions and modes of operation as described herein. Measurement Uncertainties were not taken into account and are published for informational purposes only. This report is written to support regulatory compliance of the applicable standards stated above.

### 1.2. Test facility

#### **FCC (Designation number: CN1179, Test Firm Registration Number: 446626)**

TA Technology (Shanghai) Co., Ltd. has been listed on the US Federal Communications Commission list of test facilities recognized to perform electromagnetic emissions measurements.

#### **A2LA (Certificate Number: 3857.01)**

TA Technology (Shanghai) Co., Ltd. has been listed by American Association for Laboratory Accreditation to perform electromagnetic emission measurement.

### 1.3. Testing Location

Company: TA Technology (Shanghai) Co., Ltd.  
Address: No.145, Jintang Rd, Tangzhen Industry Park, Pudong  
City: Shanghai  
Post code: 201201  
Country: P. R. China  
Contact: Xu Kai  
Telephone: +86-021-50791141/2/3  
Fax: +86-021-50791141/2/3-8000  
Website: <http://www.ta-shanghai.com>  
E-mail: [xukai@ta-shanghai.com](mailto:xukai@ta-shanghai.com)

## 2. General Description of Equipment under Test

### 2.3. Applicant and Manufacturer Information

Applicant	Quectel Wireless Solutions Co., Ltd
Applicant address	Building 5, Shanghai Business Park Phase III (Area B), No.1016 Tianlin Road, Minhang District, Shanghai, China 200233
Manufacturer	Quectel Wireless Solutions Co., Ltd
Manufacturer address	Building 5, Shanghai Business Park Phase III (Area B), No.1016 Tianlin Road, Minhang District, Shanghai, China 200233

### 2.4. General information

EUT Description			
Model	BG77		
IMEI	866349040044541		
Hardware Version	R1.2		
Software Version	BG77LAR02A02		
Power Supply	External power supply		
Antenna Type	The EUT don't have standard Antenna, The Antenna used for testing in this report is the after-market accessory (Dipole Antenna)		
Antenna Gain	1.59dBi		
Test Mode(s)	NB-IOT Band 2/25;		
Test Modulation:	BPSK, QPSK		
Category	NB2		
Deployment:	stand-alone		
Sub-carrier spacing:	3.75KHz, 15KHz		
Ntones:	single-tone, multi-tone		
Maximum E.I.R.P	NB-IOT Band 2:	22.99dBm	
	NB-IOT Band 25:	23.34dBm	
Rated Power Supply Voltage	3.3V		
Extreme Voltage	Minimum: 2.6V    Maximum: 4.8V		
Extreme Temperature	Lowest: -40°C    Highest: +85°C		
Operating Frequency Range(s)	Band	Tx (MHz)	Rx (MHz)
	NB-IOT Band 2	1850 ~ 1910	1930 ~ 1990
	NB-IOT Band 25	1850 ~ 1915	1930 ~ 1995
Note: 1. The EUT is sent from the applicant to TA and the information of the EUT is declared by the applicant.			

### 3. Applied Standards

According to the specifications of the manufacturer, it must comply with the requirements of the following standards:

**Test standards:**

**FCC CFR 47 Part 24E (2019)**

**ANSI C63.26 (2015)**

**Reference standard:**

**FCC CFR47 Part 2 (2019)**

**KDB 971168 D01 Power Meas License Digital Systems v03r01**

### 4. Test Configuration

Radiated measurements are performed by rotating the EUT in three different orthogonal test planes. EUT stand-up position (Z axis), lie-down position (X, Y axis). Receiver antenna polarization (horizontal and vertical), the worst emission was found in position (X axis, horizontal polarization) and the worst case was recorded.

All modes as Subcarrier Spacing, mo

dulations, Channel were investigated.

Subsequently, only the worst case emissions are reported.

The following testing in NB-IOT is set based on the maximum RF Output Power.

The following testing in different mode is set to detail in the following table:

Test modes are chosen to be reported as the worst case configuration below for NB-IOT Band 2/25

Test items	Deployment mode	Subcarrier Spacing (kHz)		Modulation		Test Channel		
	Stand-alone	3.75	15	BPSK	QPSK	L	M	H
RF Power Output and Effective Isotropic Radiated Power	O	O	O	O	O	O	O	O
Occupied Bandwidth	O	O	O	O	O	O	O	O
Band Edge Compliance	O	O	O	O	O	O	-	O
Peak-to-Average Power Ratio	O	O	O	O	O	-	O	-
Frequency Stability	O	O	O	O	O	O	O	O
Conducted Spurious Emissions	O	-	O	-	O	O	O	O
Radiates Spurious Emission	O	-	O	-	O	O	O	O
<p>Note</p> <p>1. The mark "O" means that this configuration is chosen for testing.</p> <p>2. The mark "-" means that this configuration is not testing.</p>								

## 5. Test Case Results

### 5.1.RF Power Output and Effective Isotropic Radiated Power

#### Ambient condition

Temperature	Relative humidity	Pressure
23°C ~25°C	45%~50%	101.5kPa

#### Methods of Measurement

During the process of the testing, The EUT is controlled by the Base Station Simulator to ensure max power transmission and proper modulation.

The testing follows FCC KDB 971168 v03r01 Section 5.8 and ANSI C63.26 (2015).

- a) Connect the equipment as illustrated. Mount the equipment with the manufacturer specified antenna in a vertical orientation on a manufacturer specified mounting surface located on a non-conducting rotating platform of a RF anechoic chamber (preferred) or a standard radiation site.
- b) Key the transmitter, then rotate the EUT 360° azimuthally and record spectrum analyzer power level (LVL) measurements at angular increments that are sufficiently small to permit resolution of all peaks. If a standard radiation test site is used, raise and lower the test antenna to obtain a maximum reading at each angular increment. (Note: several batteries may be needed to offset the effect of battery voltage droop, which should not exceed 5% of the manufactured specified battery voltage during transmission).
- c) Replace the transmitter under test with a vertically polarized half-wave dipole (or an antenna whose gain is known relative to an ideal half-wave dipole). The center of the antenna should be at the same location as the center of the antenna under test.
- d) Connect the antenna to a signal generator with a known output power and record the path loss (in dB) as LOSS. If a standard radiation test site is used, raise and lower the test antenna to obtain a maximum reading.  $LOSS = \text{Generator Output Power (dBm)} - \text{Analyzer reading (dBm)}$
- e) Determine the effective radiated output power at each angular position from the readings in steps b) and d) using the following equation:  $ERP \text{ (dBm)} = \text{LVL (dBm)} + \text{LOSS (dB)}$
- f) The maximum ERP is the maximum value determined in the preceding step.
- g) When calculating ERP, in addition to knowing the antenna radiation and matching characteristics, it is necessary to know the loss values of all elements (e.g.transmission line attenuation, mismatches, filters, combiners) interposed between the point where transmitter output power is measured, and the point where power is applied to the antenna. ERP can then be calculated as follows:  
 $EIRP \text{ (dBm)} = \text{Output Power (dBm)} - \text{Losses (dB)} + \text{Antenna Gain (dBi)}$   
where:dBd refers to gain relative to an ideal dipole.  
 $EIRP \text{ (dBm)} = ERP \text{ (dBm)} + 2.15 \text{ (dB.)}$



The RB allocation refers to section 5.1, using the maximum output power configuration.

**Test Setup**

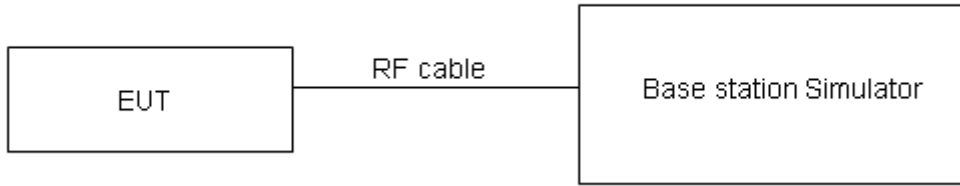

The loss between RF output port of the EUT and the input port of the tester has been taken into consideration.

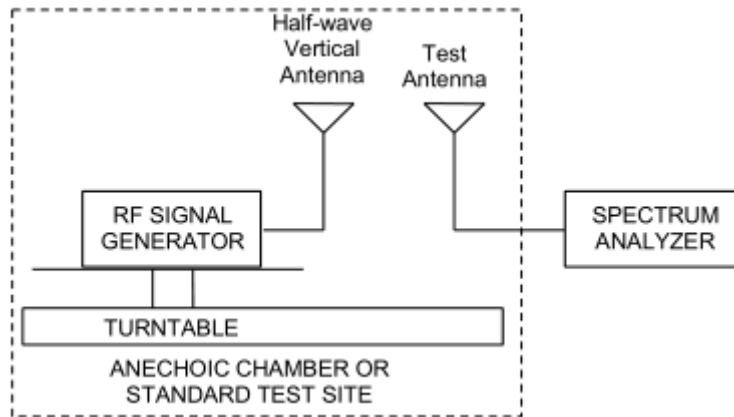
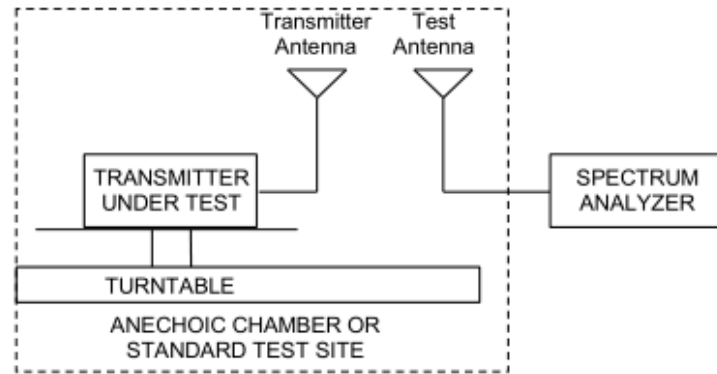

**Limits**

No specific RF power output requirements in part 2.1046.

Rule Part 24.232(c) Mobile and portable stations are limited to 2 watts EIRP.

Rule Part 24.232(e) Peak transmit power must be measured over any interval of continuous transmission using instrumentation calibrated in terms of an rms-equivalent voltage.

Limit	$\leq 2\text{ W}$ (33 dBm)
-------	----------------------------



## Measurement Uncertainty

The assessed measurement uncertainty to ensure 95% confidence level for the normal distribution is with the coverage factor  $k = 2$ ,  $U = 0.4$  dB for RF power output,  $k = 2$ ,  $U = 1.19$  dB for EIRP.

**Test Results**

Mode	Modulation	Sub-carrier spacing (KHz)	Ntones	Conducted Power (dBm) for low/mid/high channel			EIRP(dBm)		
				18601/1850.2	18900/1880.0	19199/1909.8	18601/1850.2	18900/1880.0	19199/1909.8
Band 2 Standalone	BPSK	3.75	1@0	21.15	21.13	21.36	22.40	22.51	22.95
			1@47	21.00	21.07	20.39	22.25	22.45	21.98
		15	1@0	21.17	21.19	21.40	22.42	22.57	22.99
			1@11	21.07	21.11	20.54	22.32	22.49	22.13
	QPSK	3.75	1@0	20.94	21.12	21.17	22.19	22.50	22.76
			1@47	20.97	21.11	20.45	22.22	22.49	22.04
		15	1@0	21.02	21.23	21.36	22.27	22.61	22.95
			1@11	21.15	21.17	20.53	22.40	22.55	22.12
		15	12@0	20.16	20.28	19.64	21.41	21.66	21.23

Mode	Modulation	Sub-carrier spacing (KHz)	Ntones	Conducted Power (dBm) for low/mid/high channel			EIRP(dBm)		
				26041/1850.2	26365/1882.5	26689/1914.8	26041/1850.2	26365/1882.5	26689/1914.8
Band 25 Standalone	BPSK	3.75	1@0	20.89	21.04	21.19	22.14	22.42	22.78
			1@47	20.84	21.00	20.87	22.09	22.38	22.46
		15	1@0	20.91	21.16	21.75	22.16	22.54	23.34
			1@11	20.93	21.07	21.03	22.18	22.45	22.62
	QPSK	3.75	1@0	20.83	21.05	21.74	22.08	22.43	23.33
			1@47	20.75	20.94	20.83	22.00	22.32	22.42
		15	1@0	20.89	21.11	21.69	22.14	22.49	23.28
			1@11	20.87	21.20	20.99	22.12	22.58	22.58
		15	12@0	20.09	20.24	19.96	21.34	21.62	21.55

## 5.2.Occupied Bandwidth

### Ambient condition

Temperature	Relative humidity	Pressure
23°C ~25°C	45%~50%	101.5kPa

### Method of Measurement

The EUT was connected to Spectrum Analyzer and Base Station Simulator via power Splitter. The occupied bandwidth is measured using spectrum analyzer.

RBW is set to 2kHz, VBW is set to 6.2kHz for NB-IOT Band 2/25.

99% power and -26dBc occupied bandwidths are recorded. Spectrum analyzer plots are included on the following pages.

### Test Setup

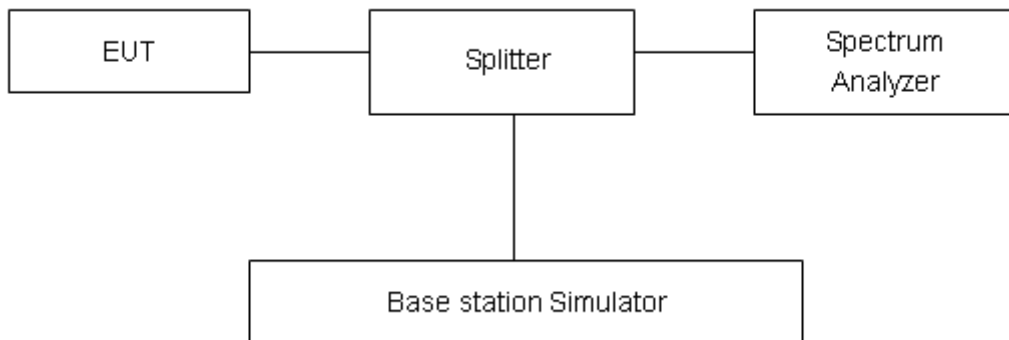

### Limits

No specific occupied bandwidth requirements in part 2.1049.

### Measurement Uncertainty

The assessed measurement uncertainty to ensure 95% confidence level for the normal distribution is with the coverage factor  $k = 2$ ,  $U = 624\text{Hz}$ .

**Test Result**

Mode	Modulation	Sub-carrier spacing (KHz)	Ntones	Bandwidth(KHz) for low/mid/high channel					
				18601/1850.2		18900/1880.0		19199/1909.8	
				99% Power	-26dBc	99% Power	-26dBc	99% Power	-26dBc
Band 2 Standalone	BPSK	3.75	1@0	62.21	41.55	62.83	40.91	63.18	41.45
	QPSK	3.75	1@0	70.06	40.05	67.70	40.25	73.42	42.25
	BPSK	15	1@0	129.92	117.40	127.91	113.10	128.91	103.80
	QPSK	15	1@0	117.91	116.20	118.63	117.00	121.06	104.30
	QPSK	15	12@0	184.55	251.00	185.16	239.80	184.09	237.30

Mode	Modulation	Sub-carrier spacing (KHz)	Ntones	Bandwidth(KHz) for low/mid/high channel					
				26041/1850.2		26365/1882.5		26689/1914.8	
				99% Power	-26dBc	99% Power	-26dBc	99% Power	-26dBc
Band 25 Standalone	BPSK	3.75	1@0	65.28	41.25	62.64	41.65	62.93	41.89
	QPSK	3.75	1@0	70.21	41.78	68.08	39.31	71.22	42.88
	BPSK	15	1@0	129.37	105.40	127.63	103.20	126.52	103.80
	QPSK	15	1@0	117.76	115.70	117.43	103.80	122.26	117.50
	QPSK	15	12@0	184.49	240.10	183.59	250.00	185.00	252.60

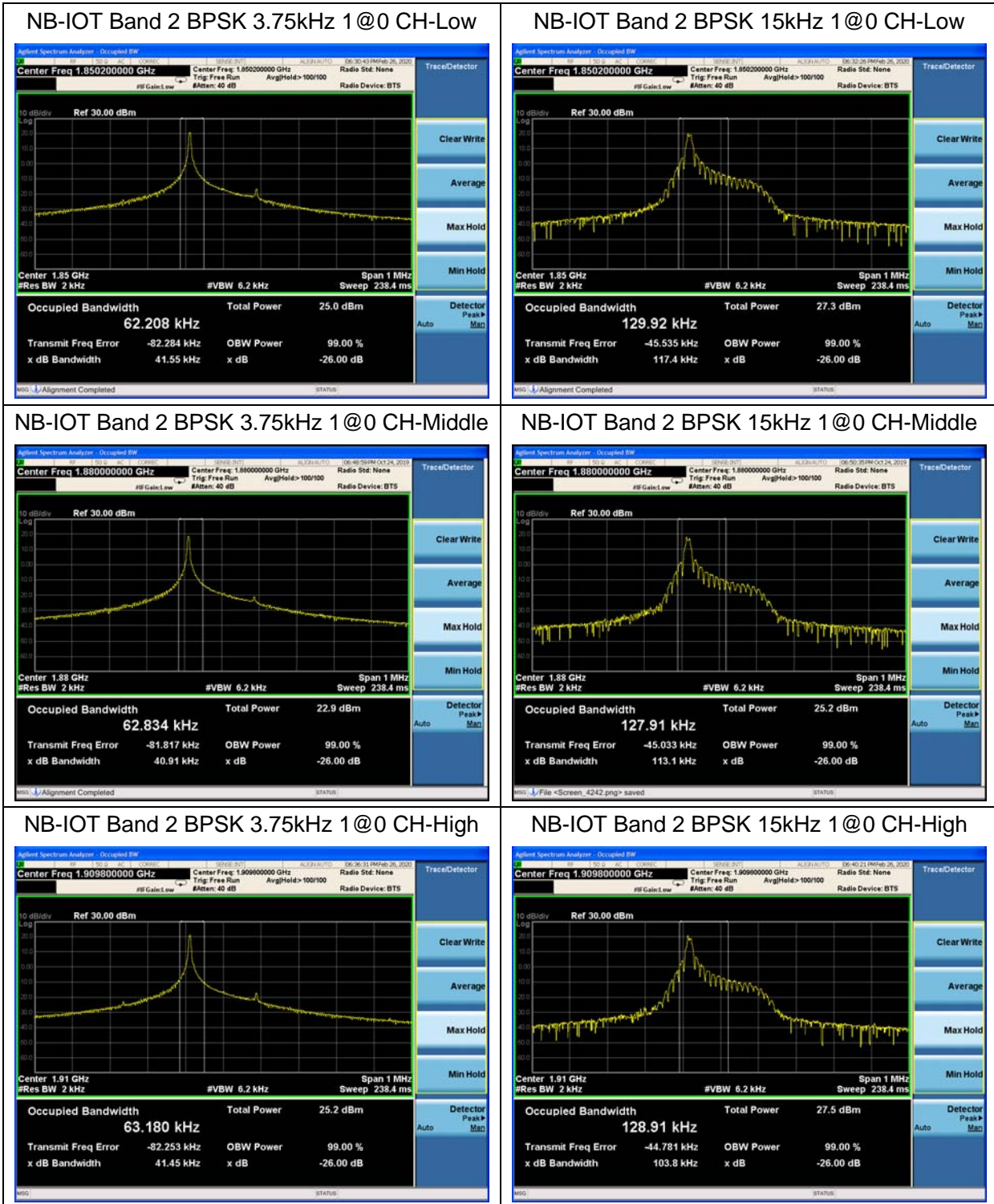

NB-IOT Band 2 QPSK 3.75kHz 1@0 CH-Low

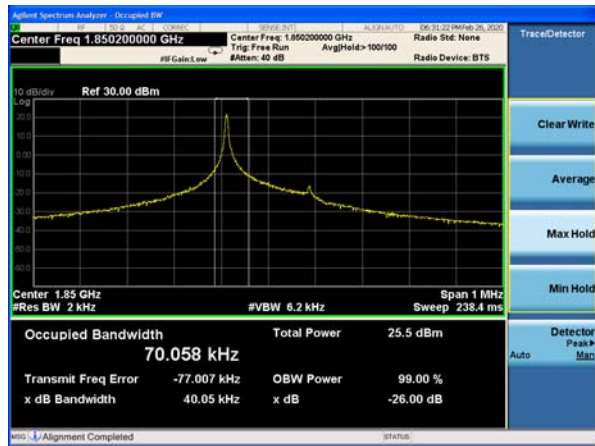

NB-IOT Band 2 QPSK 15kHz 1@0 CH-Low



NB-IOT Band 2 QPSK 3.75kHz 1@0 CH-Middle

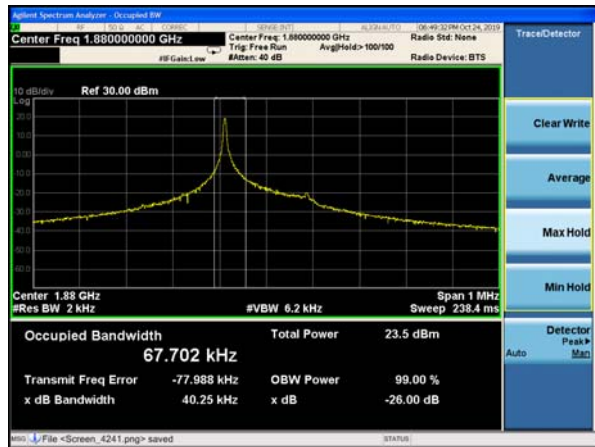

NB-IOT Band 2 QPSK 15kHz 1@0 CH-Middle

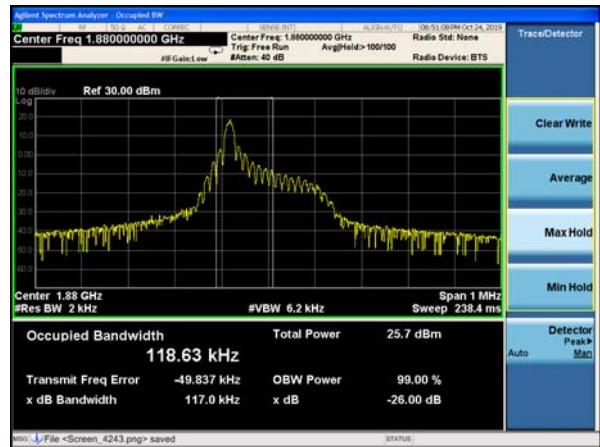

NB-IOT Band 2 QPSK 3.75kHz 1@0 CH-High

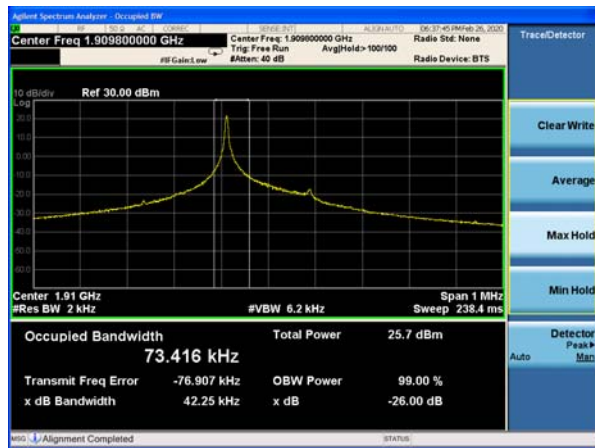

NB-IOT Band 2 QPSK 15kHz 1@0 CH-High

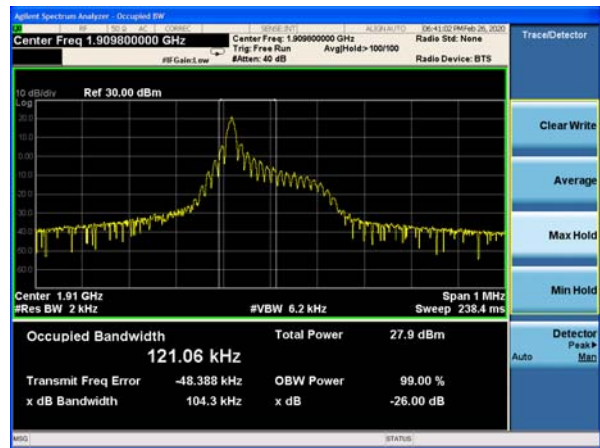

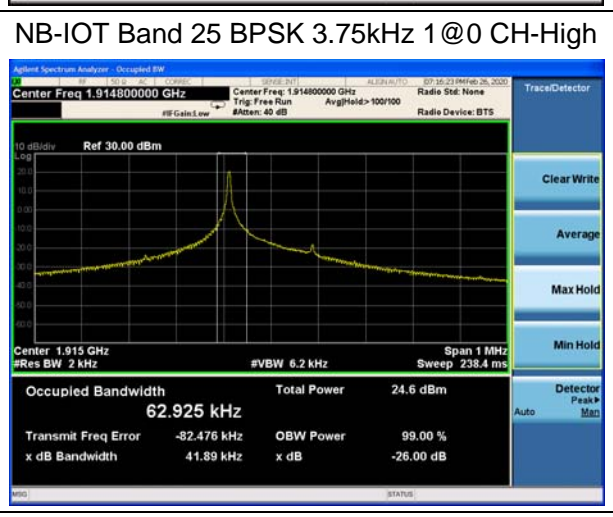
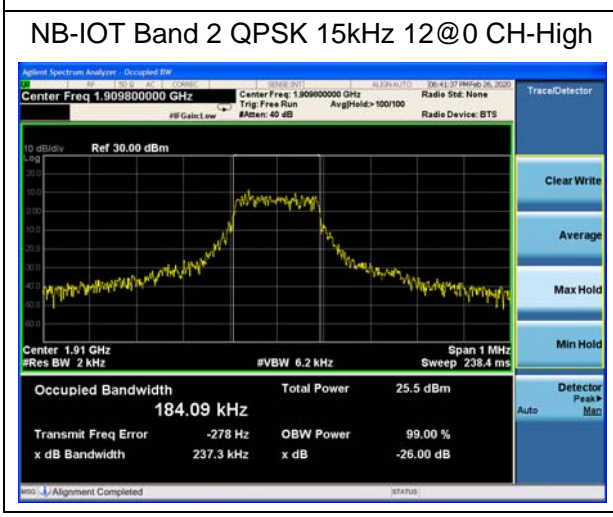
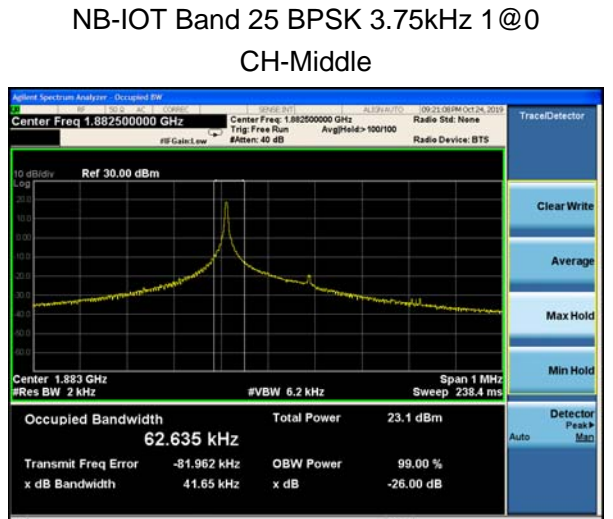
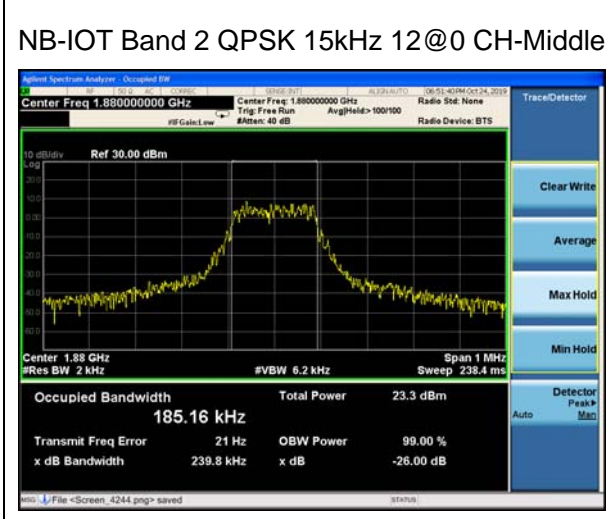
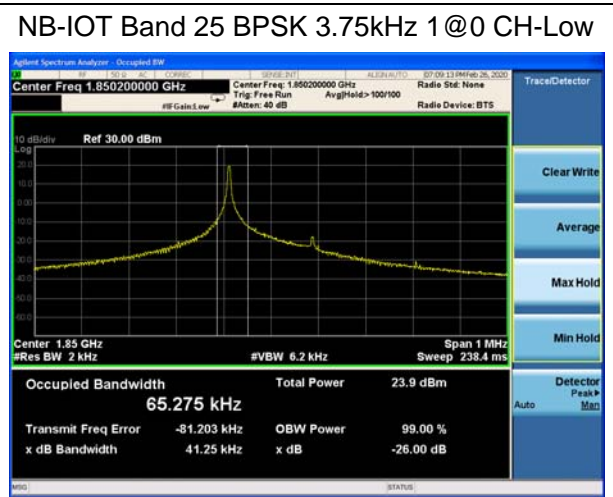
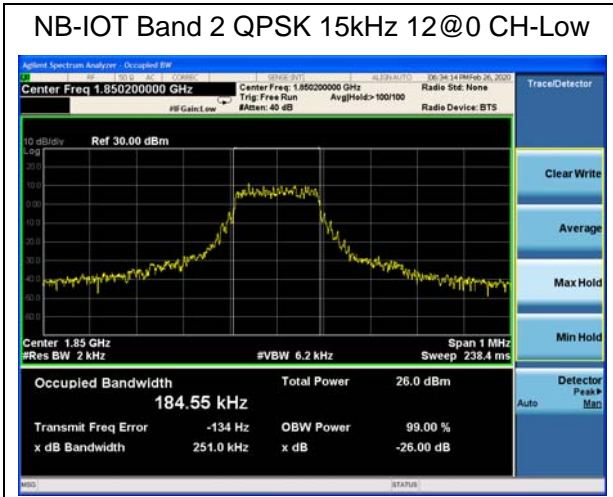



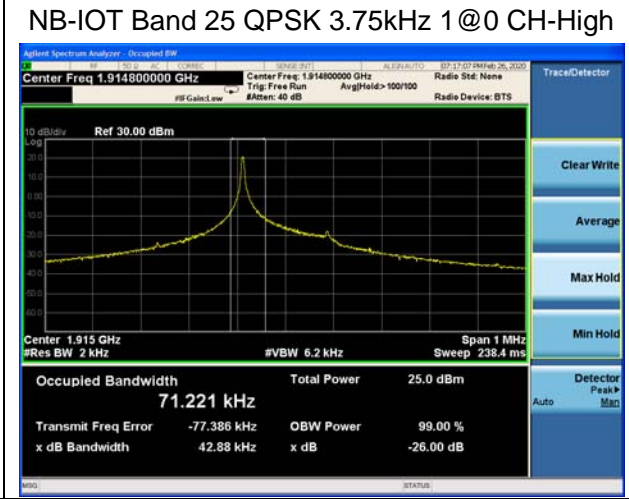
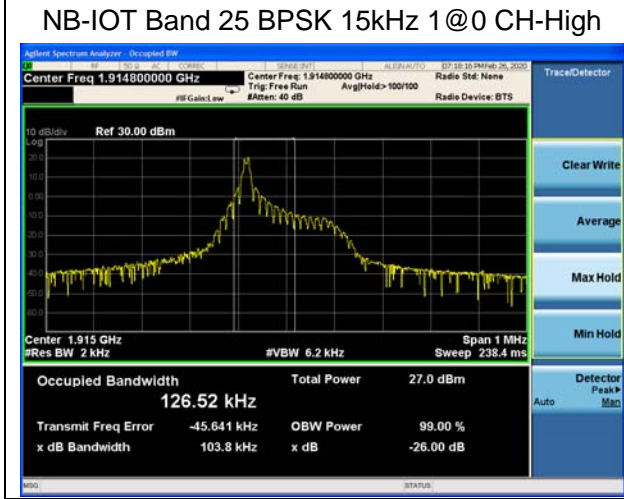
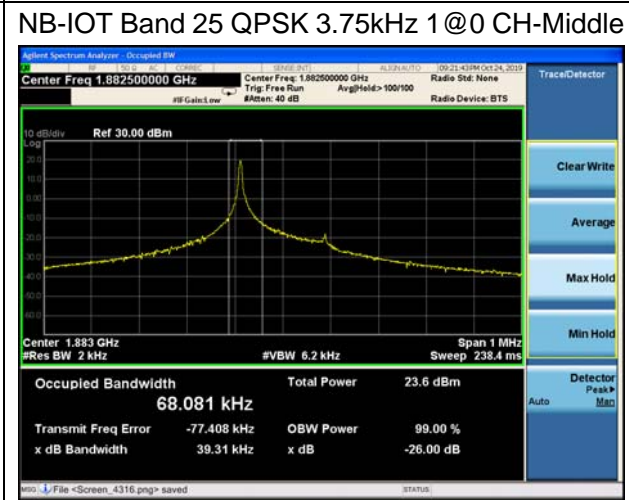
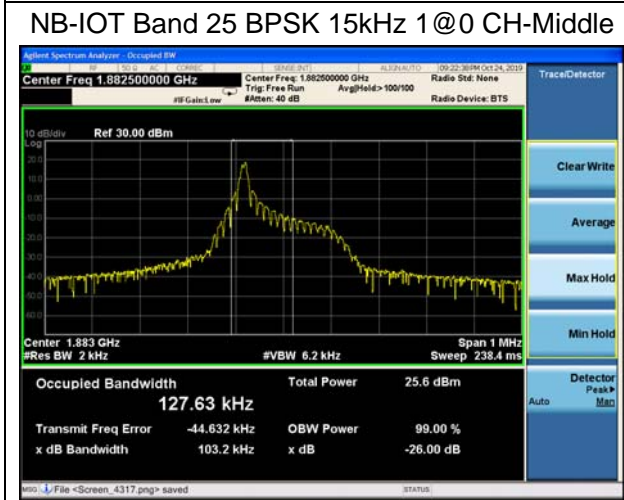
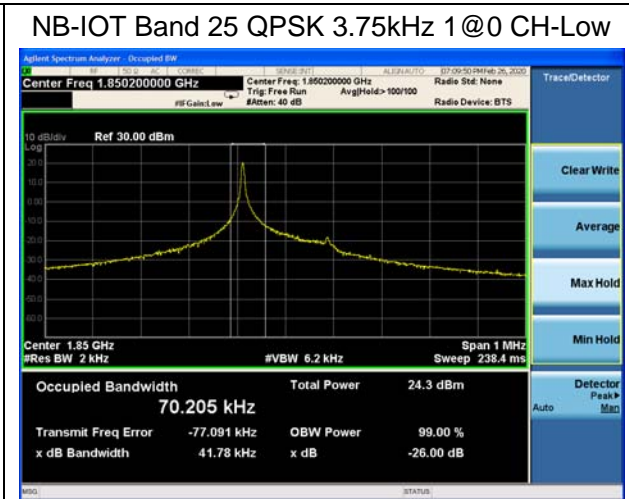
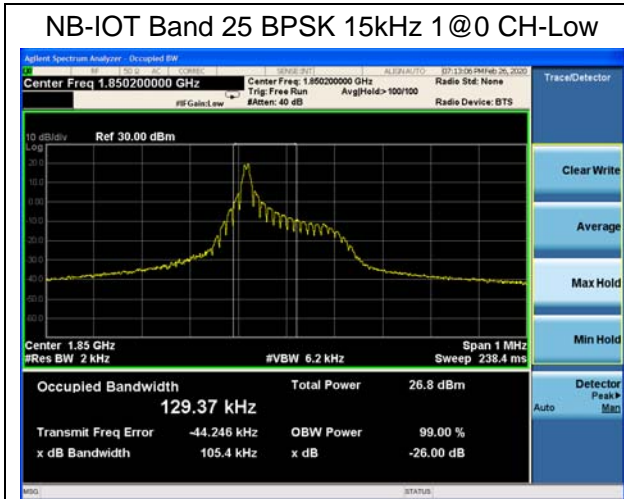

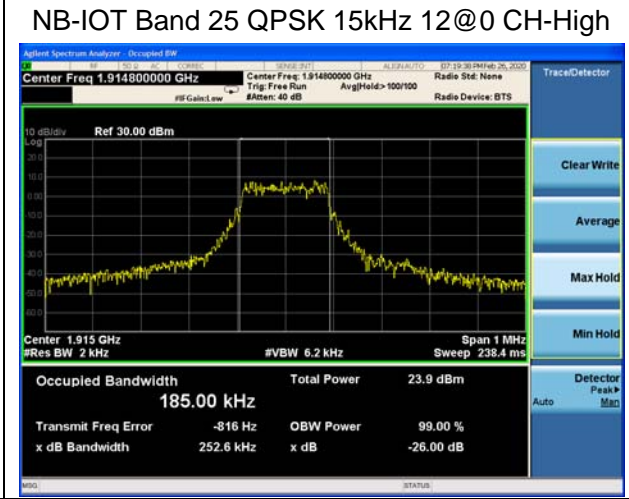
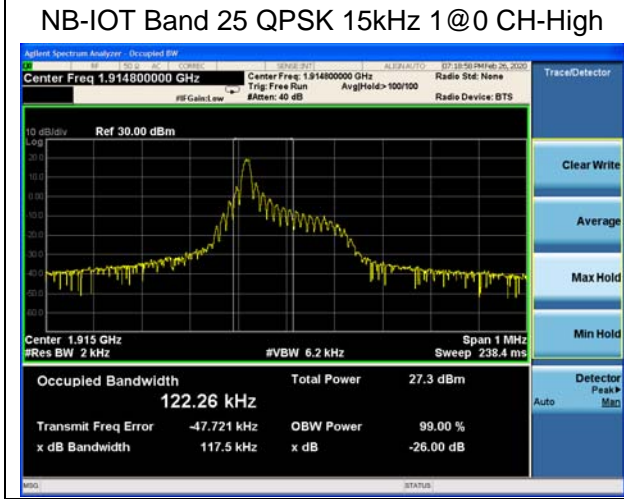
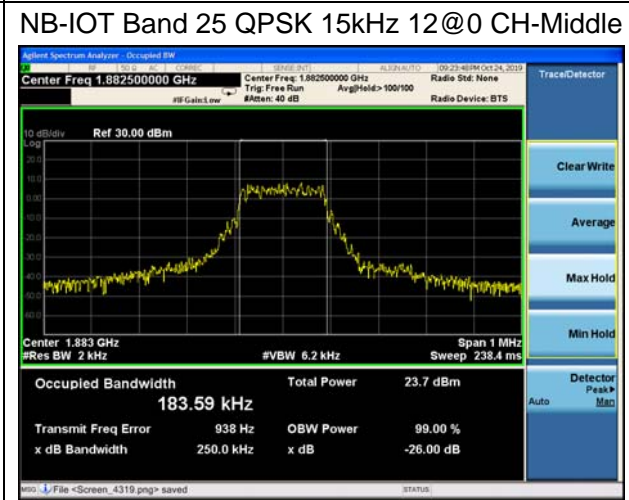
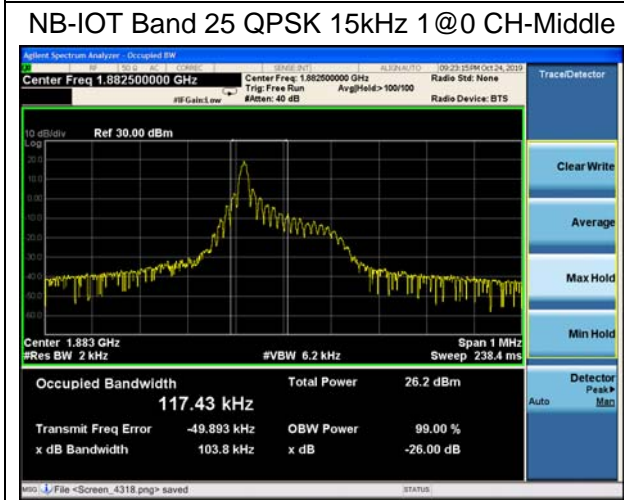
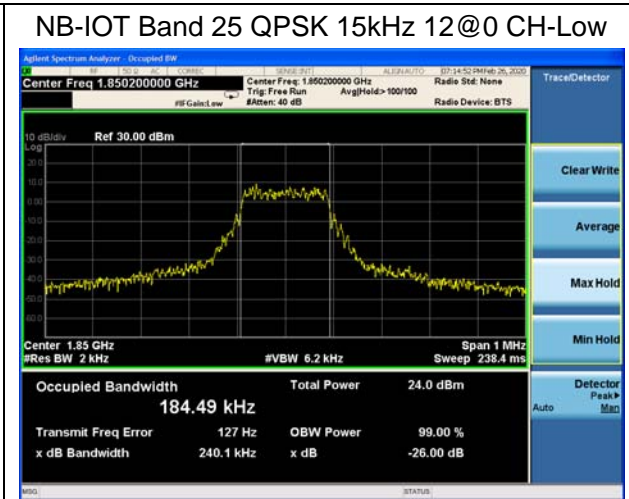
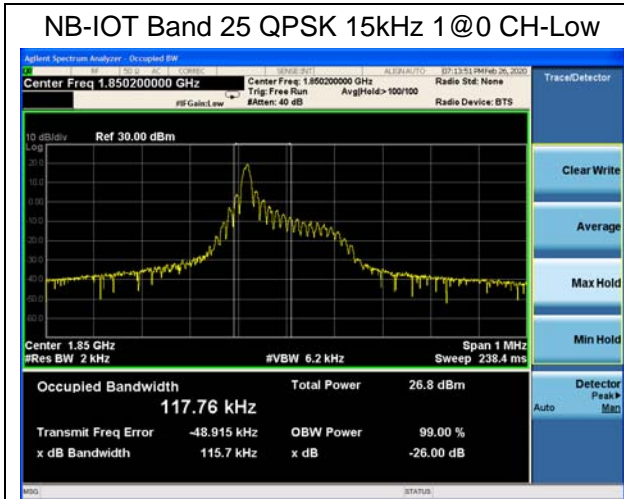

### 5.3. Band Edge Compliance

#### Ambient condition

Temperature	Relative humidity	Pressure
23°C ~25°C	45%~50%	101.5kPa

#### Method of Measurement

The EUT was connected to Spectrum Analyzer and Base Station Simulator via power Splitter. The band edge of the lowest and highest channels were measured. The Average detector is used and RBW is set to  $\geq 1\%EBW$ , VBW is set to 3x RBW.

Spectrum analyzer plots are included on the following pages.

#### Test Setup

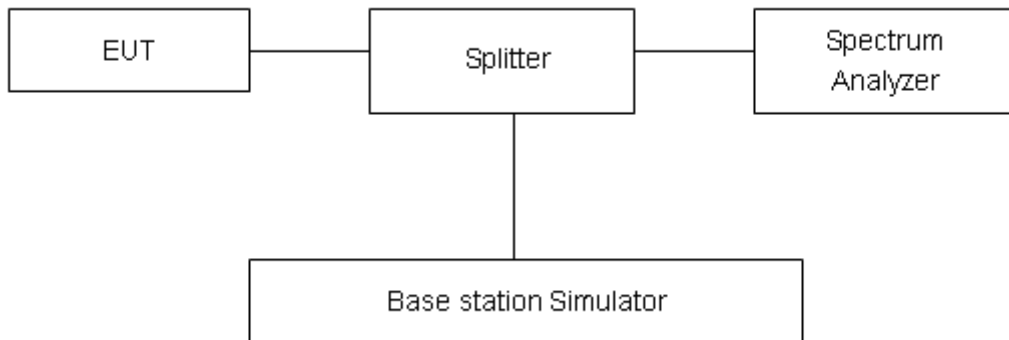

#### Limits

Rule Part 24.238(a) specifies that “on any frequency outside a licensee's frequency block, the power of any emission shall be attenuated below the transmitter power (P) by at least  $43 + 10 \log_{10} (P)$  dB.”

Limit	-13 dBm
-------	---------

#### Measurement Uncertainty

The assessed measurement uncertainty to ensure 95% confidence level for the normal distribution is with the coverage factor  $k = 1.96$ ,  $U=0.684\text{dB}$ .

Test Result:

NB-IOT Band 2 BPSK 3.75kHz 1@0 CH-Low

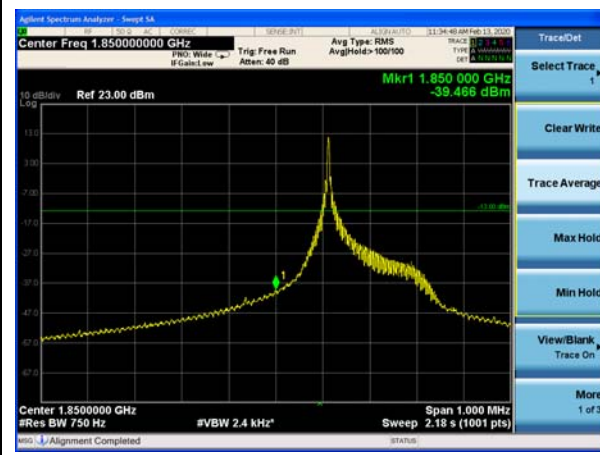

NB-IOT Band 2 BPSK 3.75kHz 1@47 CH-High

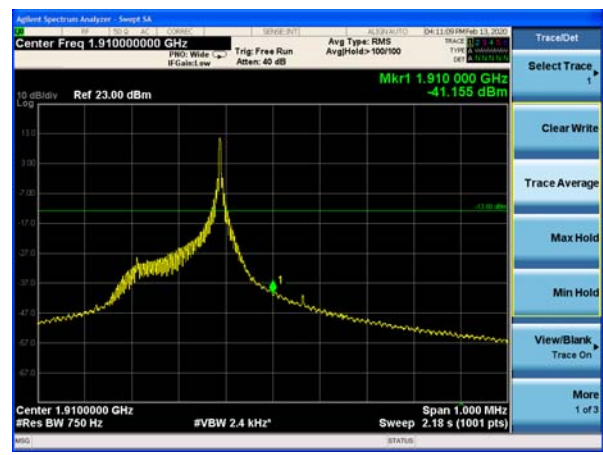

NB-IOT Band 2 BPSK 15kHz 1@0 CH-Low

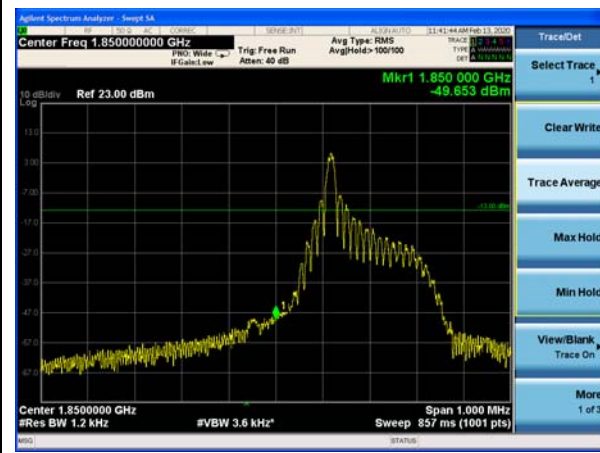

NB-IOT Band 2 BPSK 15kHz 1@11 CH-High

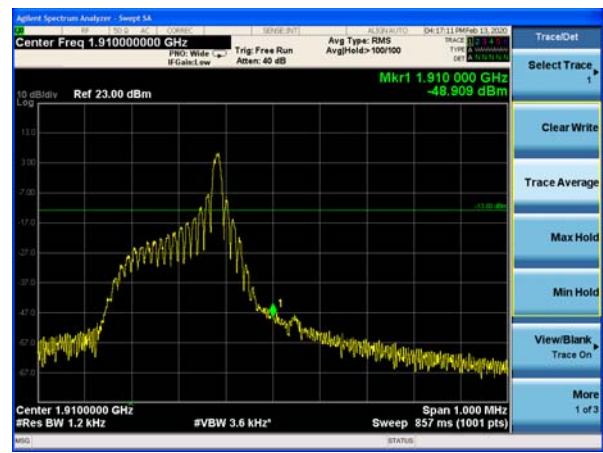

NB-IOT Band 2 QPSK 3.75kHz 1@0 CH-Low

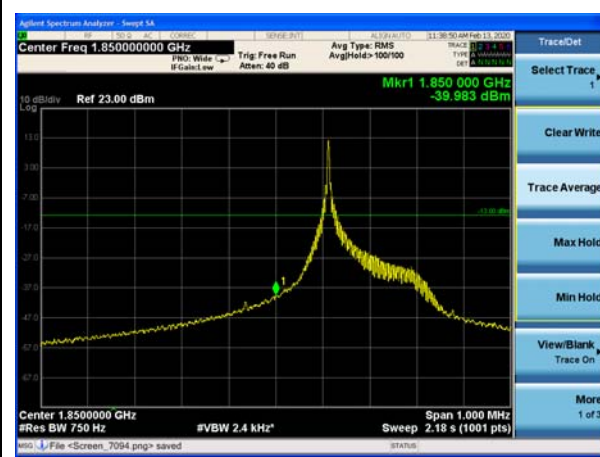

NB-IOT Band 2 QPSK 3.75kHz 1@47 CH-High

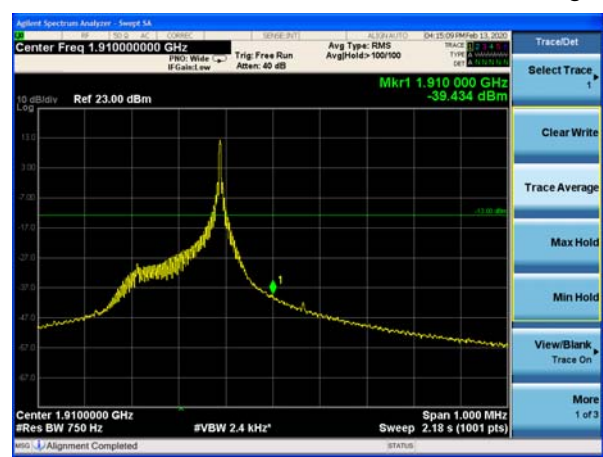

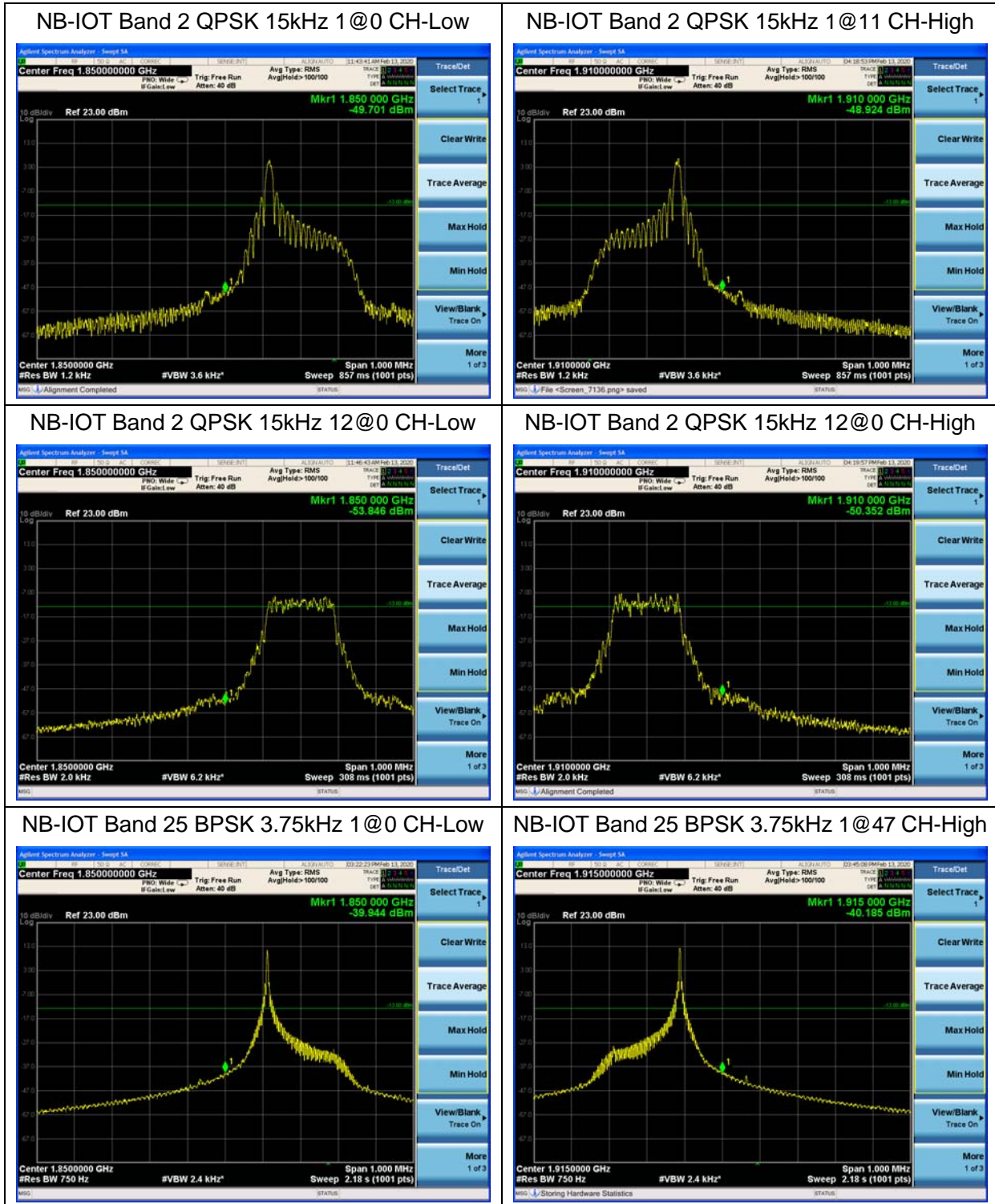

NB-IOT Band 25 BPSK 15kHz 1@0 CH-Low

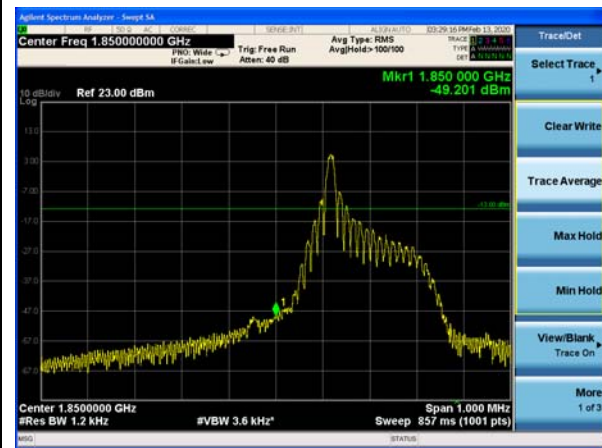

NB-IOT Band 25 BPSK 15kHz 1@11 CH-High

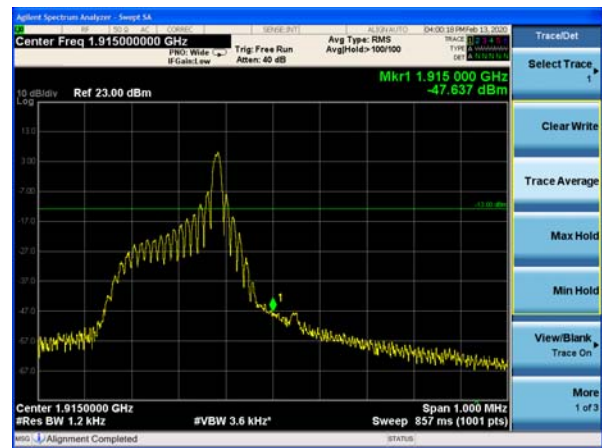

NB-IOT Band 25 QPSK 3.75kHz 1@0 CH-Low

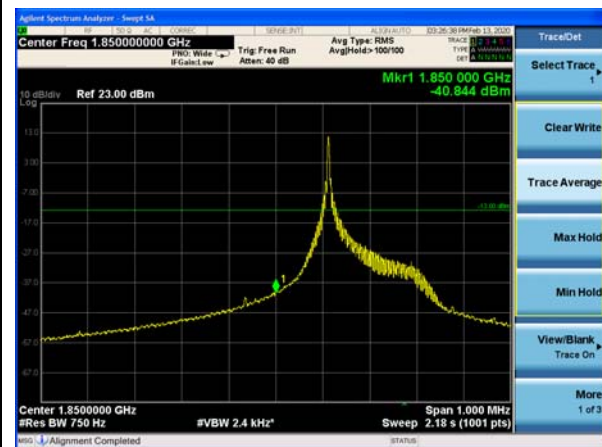

NB-IOT Band 25 QPSK 3.75kHz 1@47 CH-High

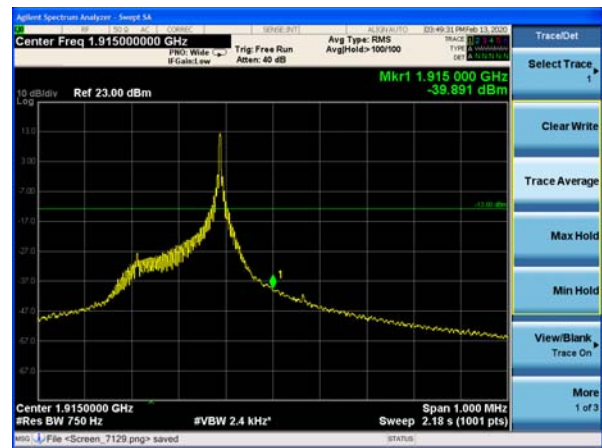

NB-IOT Band 25 QPSK 15kHz 1@0 CH-Low

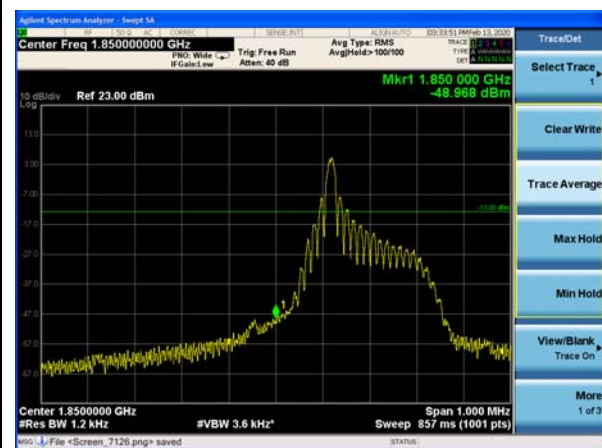

NB-IOT Band 25 QPSK 15kHz 1@11 CH-High

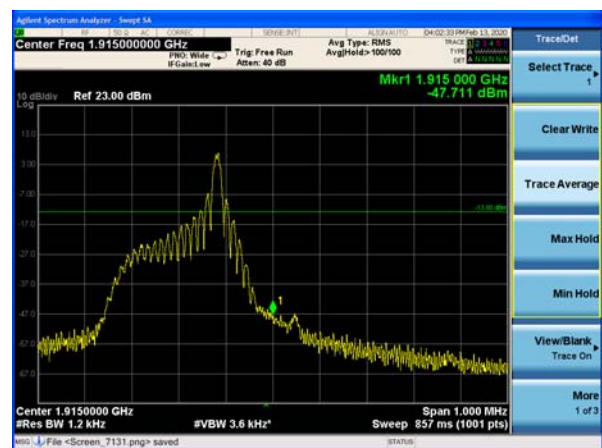

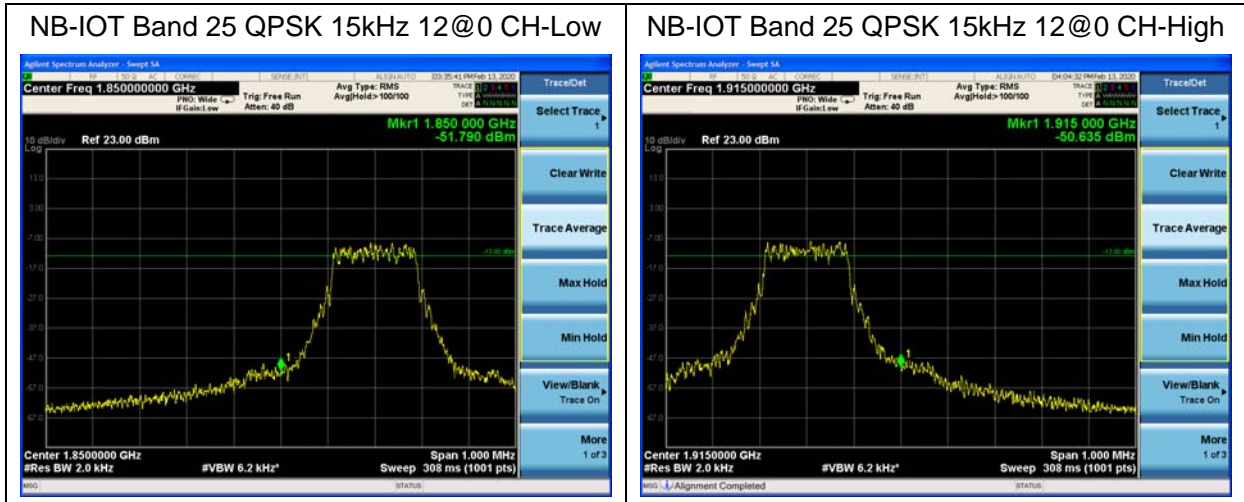

### 5.4. Peak-to-Average Power Ratio (PAPR)

**Ambient condition**

Temperature	Relative humidity	Pressure
23°C ~25°C	45%~50%	101.5kPa

**Methods of Measurement**

Measure the total peak power and record as PPk. And measure the total average power and record as PAvg. Both the peak and average power levels must be expressed in the same logarithmic units (e.g., dBm). Determine the PAPR from:

$$PAPR (dB) = PPk (dBm) - PAvg (dBm).$$

**Test Setup**

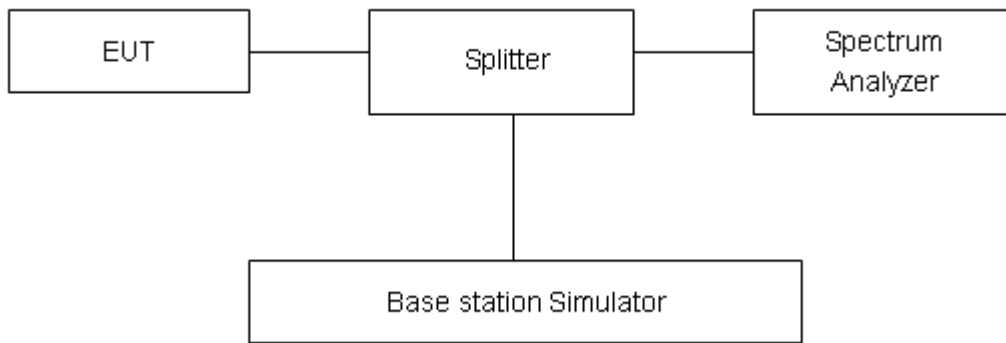

**Limits**

In measuring transmissions in this band using an average power technique, the peak-to-average ratio (PAR) of the transmission may not exceed 13 dB in 24.232(d).

**Measurement Uncertainty**

The assessed measurement uncertainty to ensure 95% confidence level for the normal distribution is with the coverage factor  $k = 2$ ,  $U = 0.4$  dB.



**Test Results**

Mode	Modulation	Sub-carrier spacing (KHz)	Channel/ Frequency(MHz)	Peak-to-Average Power Ratio (PAPR)		
				Peak(dBm)	Avg(dBm)	PAPR(dBm)
Band 2 Standalone	BPSK	3.75	18900/1880.0	20.79	16.94	3.85
	QPSK	3.75	18900/1880.0	20.39	16.94	3.45
	BPSK	15	18900/1880.0	20.59	14.11	6.48
	QPSK	15	18900/1880.0	20.57	14.12	6.45

Mode	Modulation	Sub-carrier spacing (KHz)	Channel/ Frequency(MHz)	Peak-to-Average Power Ratio (PAPR)		
				Peak(dBm)	Avg(dBm)	PAPR(dBm)
Band 25 Standalone	BPSK	3.75	26365/1882.5	20.64	16.78	3.86
	QPSK	3.75	26365/1882.5	20.20	16.75	3.45
	BPSK	15	26365/1882.5	20.54	14.11	6.43
	QPSK	15	26365/1882.5	20.49	14.06	6.43

## 5.5.Frequency Stability

### Ambient condition

Temperature	Relative humidity	Pressure
23°C ~25°C	45%~50%	101.5kPa

### Method of Measurement

#### Frequency Stability (Temperature Variation)

The temperature inside the climate chamber is varied from -40°C to +85°C in 10°C step size,

(1) With all power removed, the temperature was decreased to 0°C and permitted to stabilize for three hours.

(2) Measure the carrier frequency with the test equipment in a “call mode”. These measurements should be made within 1 minute of powering up the mobile station, to prevent significant self warming.

(3) Repeat the above measurements at 10°C increments from -40°C to +85°C. Allow at least 1.5 hours at each temperature, un-powered, before making measurements.

#### Frequency Stability (Voltage Variation)

The frequency stability shall be measured with variation of primary supply voltage as follows:

(1) Vary primary supply voltage from 85 to 115 percent of the nominal value for other than hand carried battery equipment.

(2) For hand carried, battery powered equipment, reduce primary supply voltage to the battery-operating end point which shall be specified by the manufacturer.

This transceiver is specified to operate with an input voltage of between 2.6 V and 4.8 V, with a nominal voltage of 3.3V.

### Test setup

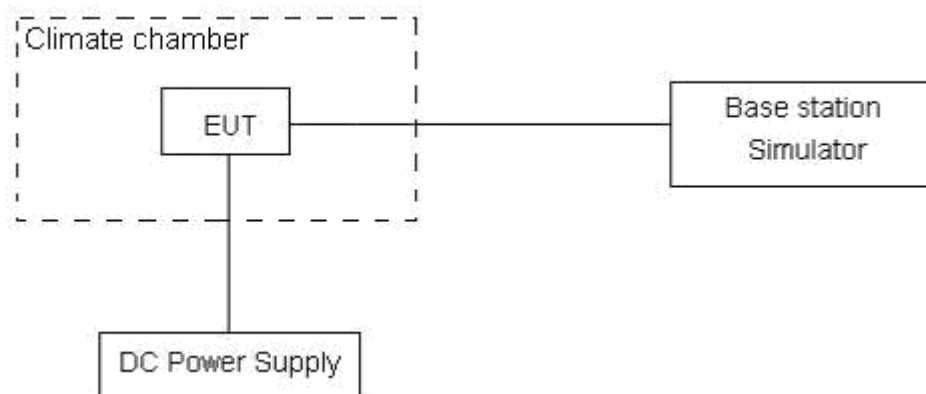

**Limits**

The frequency stability shall be sufficient to ensure that the fundamental emission stays within the authorized frequency block

**Measurement Uncertainty**

The assessed measurement uncertainty to ensure 99.75% confidence level for the normal distribution is with the coverage factor  $k = 3$ ,  $U = 0.01\text{ppm}$ .

**Test Result**

NB-IOT Band 2						
Condition		Freq.Error (Hz)	Freq.Error (Hz)	Frequency Stability (ppm)	Frequency Stability (ppm)	Verdict
Sub-carrier spacing (KHz)	3.75					
Temperature	Voltage	BPSK	QPSK	BPSK	QPSK	
Normal (25°C)	Normal	3.46	13.36	0.00184	0.00711	PASS
Extreme (85°C)		12.26	6.38	0.00652	0.00339	PASS
Extreme (80°C)		3.15	15.24	0.00168	0.00811	PASS
Extreme (70°C)		10.59	16.63	0.00563	0.00885	PASS
Extreme (60°C)		10.58	8.40	0.00563	0.00447	PASS
Extreme (50°C)		8.21	6.66	0.00436	0.00354	PASS
Extreme (40°C)		1.97	16.80	0.00105	0.00894	PASS
Extreme (30°C)		13.72	8.36	0.00730	0.00445	PASS
Extreme (20°C)		15.35	3.24	0.00816	0.00172	PASS
Extreme (10°C)		6.92	15.67	0.00368	0.00833	PASS
Extreme (0°C)		15.36	10.29	0.00817	0.00547	PASS
Extreme (-10°C)		8.34	10.33	0.00444	0.00549	PASS
Extreme (-20°C)		4.57	13.24	0.00243	0.00704	PASS
Extreme (-30°C)		11.85	14.88	0.00630	0.00792	PASS
Extreme (-40°C)		4.07	11.43	0.00216	0.00608	PASS
25°C	LV	16.90	17.53	0.00899	0.00932	PASS
	HV	7.33	5.17	0.00390	0.00275	PASS
Condition		Freq.Error (Hz)	Freq.Error (Hz)	Frequency Stability (ppm)	Frequency Stability (ppm)	Verdict
Sub-carrier spacing (KHz)	15					
Temperature	Voltage	BPSK	QPSK	BPSK	QPSK	
Normal (25°C)	Normal	17.69	10.90	0.00941	0.00580	PASS
Extreme (85°C)		5.31	17.86	0.00282	0.00950	PASS
Extreme (80°C)		16.43	13.23	0.00874	0.00704	PASS
Extreme (70°C)		5.07	5.01	0.00270	0.00267	PASS
Extreme (60°C)		13.49	10.31	0.00717	0.00548	PASS
Extreme (50°C)		11.42	5.72	0.00608	0.00304	PASS
Extreme (40°C)		9.62	14.67	0.00512	0.00780	PASS
Extreme (30°C)		7.91	8.84	0.00421	0.00470	PASS
Extreme (20°C)		13.20	8.36	0.00702	0.00445	PASS
Extreme (10°C)		1.93	7.80	0.00102	0.00415	PASS
Extreme (0°C)		10.10	15.18	0.00537	0.00808	PASS
Extreme (-10°C)		11.96	17.85	0.00636	0.00950	PASS



Extreme (-20°C)		5.21	16.53	0.00277	0.00879	PASS
Extreme (-30°C)		6.88	15.79	0.00366	0.00840	PASS
Extreme (-40°C)		16.22	2.87	0.00863	0.00152	PASS
25°C	LV	10.21	4.38	0.00543	0.00233	PASS
	HV	11.32	16.85	0.00602	0.00896	PASS

NB-IOT Band 25						
Condition		Freq.Error (Hz)	Freq.Error (Hz)	Frequency Stability (ppm)	Frequency Stability (ppm)	Verdict
Sub-carrier spacing (KHz)	3.75					
Temperature	Voltage	BPSK	QPSK	BPSK	QPSK	
Normal (25°C)	Normal	14.81	13.34	0.00788	0.00710	PASS
Extreme (85°C)		7.62	17.78	0.00405	0.00946	PASS
Extreme (80°C)		11.62	11.80	0.00618	0.00628	PASS
Extreme (70°C)		2.60	4.91	0.00138	0.00261	PASS
Extreme (60°C)		2.71	6.18	0.00144	0.00329	PASS
Extreme (50°C)		14.11	12.15	0.00750	0.00646	PASS
Extreme (40°C)		14.37	11.87	0.00764	0.00631	PASS
Extreme (30°C)		13.80	13.32	0.00734	0.00708	PASS
Extreme (20°C)		16.61	15.39	0.00883	0.00819	PASS
Extreme (10°C)		4.51	17.18	0.00240	0.00914	PASS
Extreme (0°C)		16.86	9.13	0.00897	0.00486	PASS
Extreme (-10°C)		10.71	5.39	0.00570	0.00287	PASS
Extreme (-20°C)		15.15	16.72	0.00806	0.00889	PASS
Extreme (-30°C)		10.97	5.87	0.00584	0.00312	PASS
Extreme (-40°C)		5.70	3.46	0.00303	0.00184	PASS
25°C	LV	11.98	8.53	0.00637	0.00454	PASS
	HV	17.35	13.98	0.00923	0.00744	PASS
Condition		Freq.Error (Hz)	Freq.Error (Hz)	Frequency Stability (ppm)	Frequency Stability (ppm)	Verdict
Sub-carrier spacing (KHz)	15					
Temperature	Voltage	BPSK	QPSK	BPSK	QPSK	
Normal (25°C)	Normal	10.47	15.23	0.00557	0.00810	PASS
Extreme (85°C)		1.61	10.53	0.00086	0.00560	PASS
Extreme (80°C)		11.75	14.71	0.00625	0.00783	PASS
Extreme (70°C)		3.32	17.38	0.00177	0.00925	PASS
Extreme (60°C)		6.13	3.27	0.00326	0.00174	PASS
Extreme (50°C)		14.22	16.36	0.00756	0.00870	PASS
Extreme (40°C)		8.83	9.51	0.00470	0.00506	PASS



Extreme (30°C)		12.10	11.72	0.00644	0.00623	PASS
Extreme (20°C)		10.44	9.45	0.00555	0.00503	PASS
Extreme (10°C)		13.33	3.91	0.00709	0.00208	PASS
Extreme (0°C)		15.02	11.85	0.00799	0.00630	PASS
Extreme (-10°C)		7.10	6.82	0.00378	0.00363	PASS
Extreme (-20°C)		17.72	14.15	0.00943	0.00752	PASS
Extreme (-30°C)		10.30	5.42	0.00548	0.00288	PASS
Extreme (-40°C)		4.24	7.47	0.00226	0.00397	PASS
25°C	LV	11.35	5.00	0.00604	0.00266	PASS
	HV	1.81	16.26	0.00096	0.00865	PASS

## 5.6. Spurious Emissions at Antenna Terminals

### Ambient condition

Temperature	Relative humidity	Pressure
23°C ~25°C	45%~50%	101.5kPa

### Method of Measurement

The EUT was connected to Spectrum Analyzer and Base Station Simulator via power Splitter. The measurement is carried out using a spectrum analyzer. The spectrum analyzer scans from 9kHz to the 10th harmonic of the carrier. The peak detector is used.

RBW is set to 100kHz, VBW is set to 300kHz for 30MHz~1GHz

RBW is set to 1MHz, VBW is set to 3MHz for above 1GHz, Sweep is set to ATUO.

The modulation mode and RB allocation refer to section 5.1, using the maximum output power configuration.

### Test setup

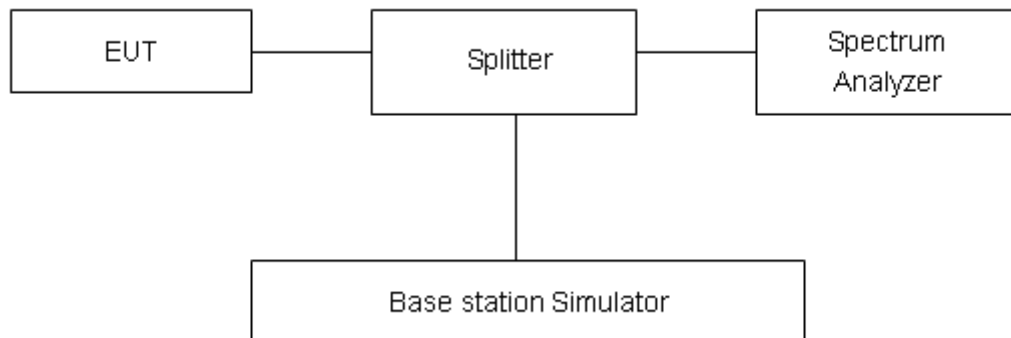

### Limits

Rule Part 24.238(a) specifies that “on any frequency outside a licensee's frequency block, the power of any emission shall be attenuated below the transmitter power (P) by at least 43 + 10 log<sub>10</sub> (P) dB.”

Limit	-13 dBm

### Measurement Uncertainty

The assessed measurement uncertainty to ensure 99.75% confidence level for the normal distribution is with the coverage factor  $k = 1.96$ .

Frequency	Uncertainty
9kHz-1GHz	0.684 dB
1GHz-20GHz	1.407 dB



### Test Result

Sweep the whole frequency band through the range from 9kHz to the 10th harmonic of the carrier, the emissions more than 20 dB below the limit are not reported.

The signal beyond the limit is carrier.

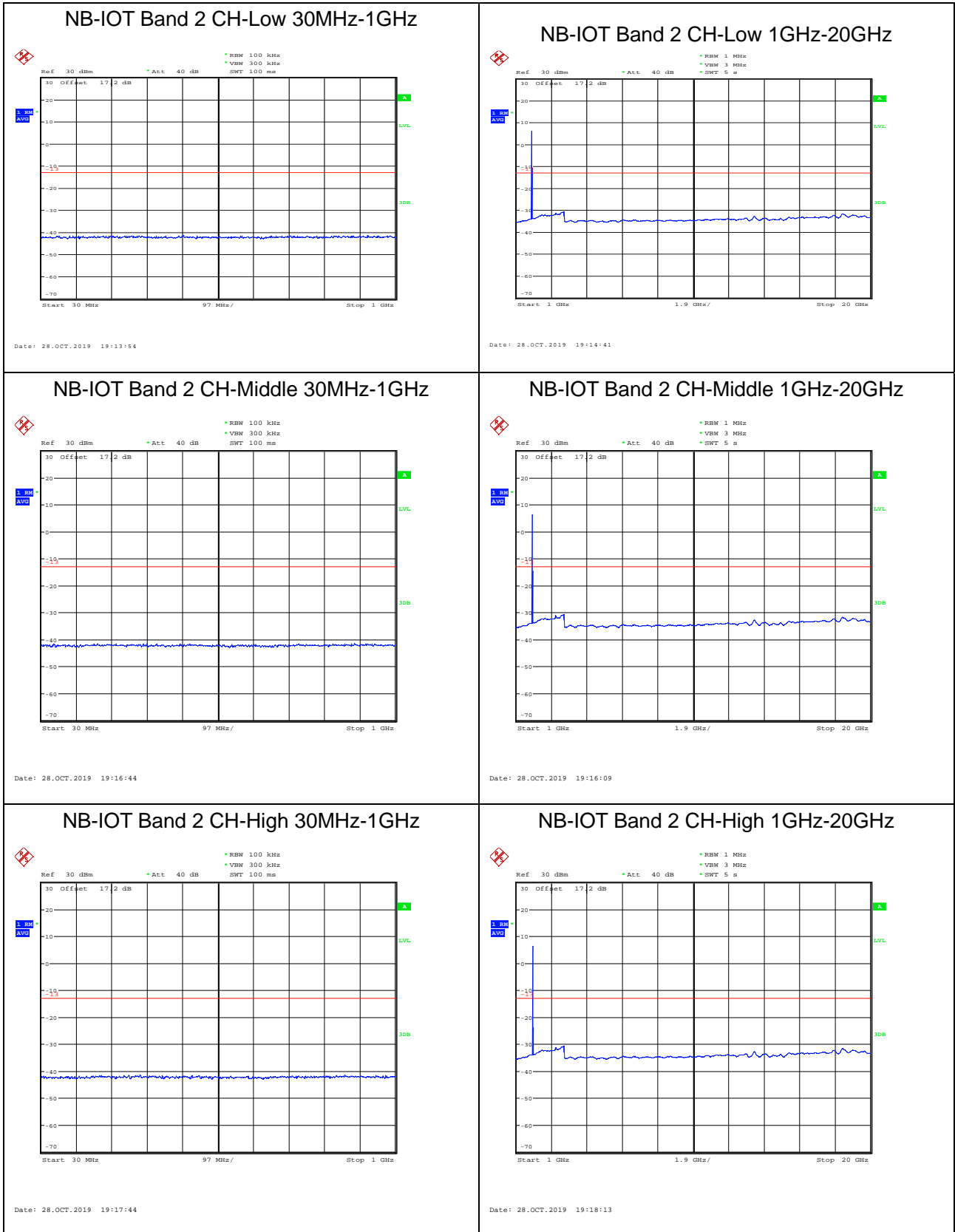





### NB-IOT Band 25 CH-Low 30MHz-1GHz

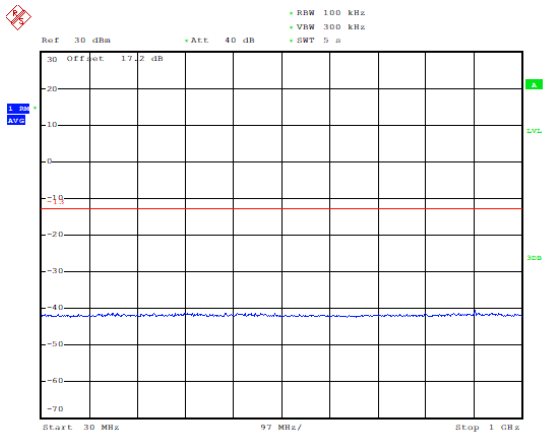

Date: 28.OCT.2019 20:00:47

### NB-IOT Band 25 CH-Low 1GHz~20GHz

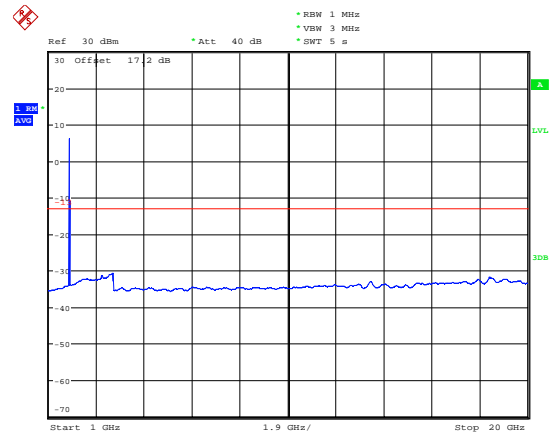

Date: 28.OCT.2019 20:02:31

### NB-IOT Band 25 CH-Middle 30MHz-1GHz

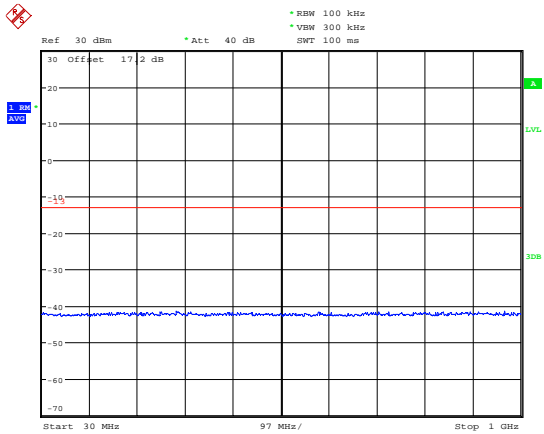

Date: 28.OCT.2019 20:05:02

### NB-IOT Band 25 CH-Middle 1GHz~20GHz

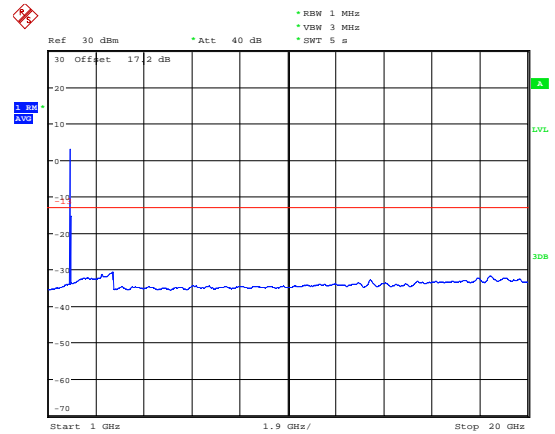

Date: 28.OCT.2019 20:04:38

### NB-IOT Band 25 CH-High 30MHz-1GHz

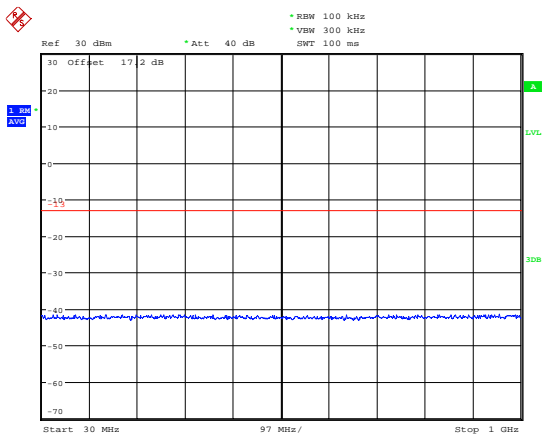

Date: 28.OCT.2019 20:06:31

### NB-IOT Band 25 CH-High 1GHz~20GHz

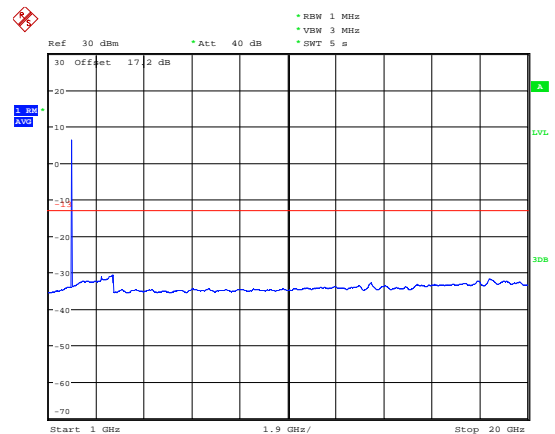

Date: 28.OCT.2019 20:07:46

## 5.7. Radiates Spurious Emission

### Ambient condition

Temperature	Relative humidity	Pressure
23°C ~25°C	45%~50%	101.5kPa

### Method of Measurement

1. The testing follows FCC KDB 971168 v03r01 Section 5.8 and ANSI C63.26 (2015).
2. Below 1GHz: The EUT is placed on a turntable 0.8 meters above the ground in the chamber, 3 meter away from the antenna. The maximal emission value is acquired by adjusting the antenna height, polarisation and turntable azimuth. Normally, the height range of antenna is 1 m to 4 m, the azimuth range of turntable is 0° to 360°, and the receive antenna has two polarizations Vertical (V) and Horizontal (H). Above 1GHz: (Note: the FCC's permission to use 1.5m as an alternative per TCBC Conf call of Dec. 2, 2014.) The EUT is placed on a turntable 1.5 meters above the ground in the chamber, 3 meter away from the antenna. The maximal emission value is acquired by adjusting the antenna height, polarisation and turntable azimuth. Normally, the height range of antenna is 1 m to 4 m, the azimuth range of turntable is 0° to 360°, and the receive antenna has two polarizations Vertical (V) and Horizontal (H).
3. A loop antenna, A log-periodic antenna or horn antenna shall be substituted in place of the EUT. The log-periodic antenna will be driven by a signal generator and the level will be adjusted till the same power value on the spectrum analyzer or receiver. The level of the spurious emissions can be calculated through the level of the signal generator, cable loss, the gain of the substitution antenna and the reading of the spectrum analyzer or receiver.
4. The EUT is then put into continuously transmitting mode at its maximum power level during the test. Set Test Receiver or Spectrum RBW=200Hz,VBW=600Hz for 9kHz150kHz , RBW=10kHz, VBW=30kHz 150kHz-30MHz , RBW=100kHz,VBW=300kHz for 30MHz to 1GHz and RBW=1MHz, VBW=3MHz for above 1GHz, And the maximum value of the receiver should be recorded as (Pr).
5. The EUT shall be replaced by a substitution antenna. In the chamber, an substitution antenna for the frequency band of interest is placed at the reference point of the chamber. An RF Signal source for the frequency band of interest is connected to the substitution antenna with a cable that has been constructed to not interfere with the radiation pattern of the antenna. A power (PMea) is applied to the input of the substitution antenna, and adjust the level of the signal generator output until the value of the receiver reach the previously recorded (Pr). The power of signal source (PMea) is recorded. The test should be performed by rotating the test item and adjusting the receiving antenna polarization.
6. A amplifier should be connected to the Signal Source output port. And the cable should be connect between the Amplifier and the Substitution Antenna. The cable loss (Pcl) ,the Substitution Antenna Gain (Ga) and the Amplifier Gain (PAg) should be recorded after test.
7. The measurement results are obtained as described below:  
Power(EIRP)=PMea- PAg - Pcl + Ga  
The measurement results are amend as described below:  
Power(EIRP)=PMea- Pcl + Ga
8. This value is EIRP since the measurement is calibrated using an antenna of known gain (2.15 dBi)

and known input power. ERP can be calculated from EIRP by subtracting the gain of the dipole,  $ERP = EIRP - 2.15\text{dBi}$ .

The modulation mode and RB allocation refer to section 5.1, using the maximum output power configuration.

**Test setup**

**9KHz ~ 30MHz**

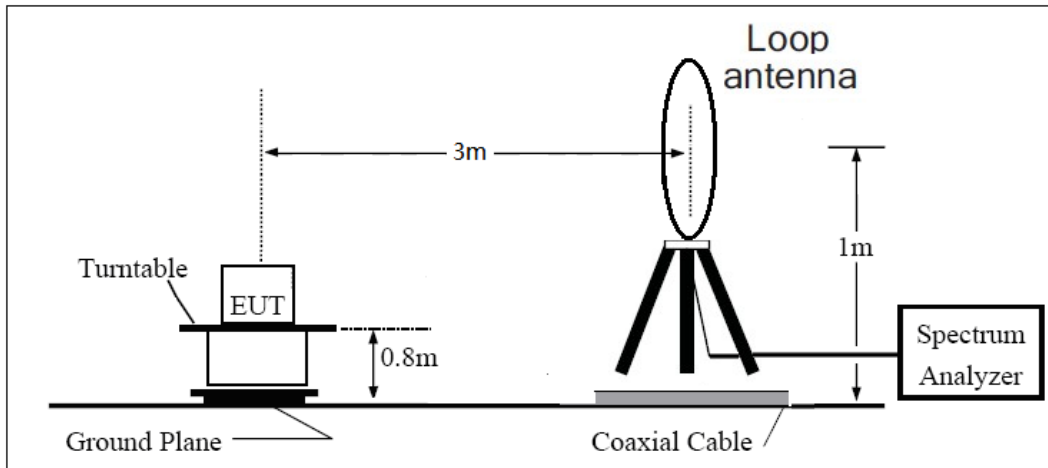

**30MHz ~ 1GHz**

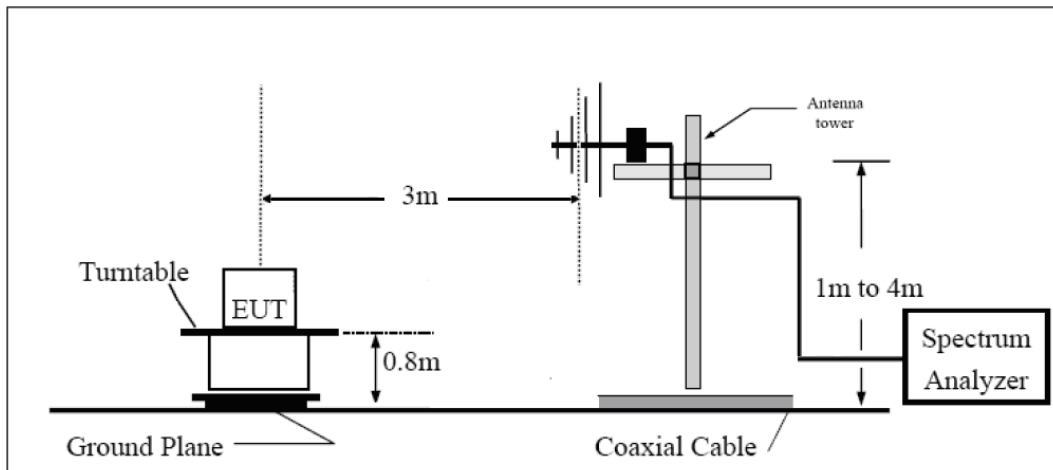

**Above 1GHz**

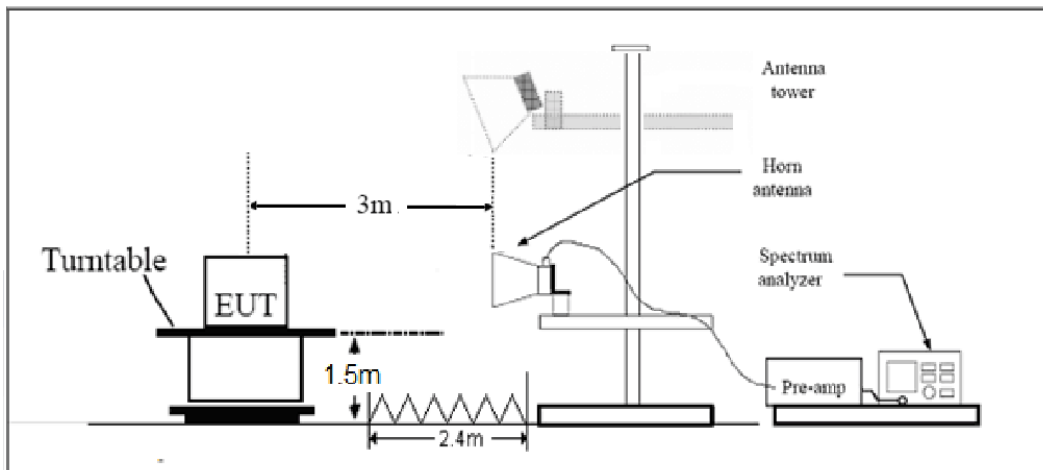



Note: Area side: 2.4mX3.6m

### Limits

Rule Part 24.238(a) specifies that “on any frequency outside a licensee's frequency block, the power of any emission shall be attenuated below the transmitter power (P) by at least  $43 + 10 \log_{10}(P)$  dB.”

Limit	-13 dBm
-------	---------

### Measurement Uncertainty

The assessed measurement uncertainty to ensure 95% confidence level for the normal distribution is with the coverage factor  $k = 1.96$ ,  $U = 3.55$  dB.

**Test Result**

Sweep the whole frequency band through the range from 9kHz to the 10th harmonic of the carrier, the emissions below the noise floor will not be recorded in the report.

NB-IOT Band 2 15KHz+BPSK CH-Low

Harmonic	Frequency (MHz)	SG (dBm)	Cable Loss (dB)	Gain (dBi)	Antenna Polarization	EIRP Level (dBm)	Limit (dBm)	Margin (dB)	Azimuth (deg)
2	3700.2	-58.19	5.10	11.05	Horizontal	-52.24	-13.00	39.24	270
3	5550.3	-56.18	5.42	12.65	Horizontal	-48.95	-13.00	35.95	180
4	7400.4	-55.66	6.70	13.85	Horizontal	-48.51	-13.00	35.51	90
5	9250.5	-53.63	7.01	14.75	Horizontal	-45.89	-13.00	32.89	0
6	11100.6	-53.15	7.48	15.95	Horizontal	-44.68	-13.00	31.68	45
7	12950.7	-52.00	7.51	16.55	Horizontal	-42.96	-13.00	29.96	135
8	14800.8	-48.57	8.24	15.35	Horizontal	-41.46	-13.00	28.46	225
9	16650.9	-46.07	8.41	14.95	Horizontal	-39.53	-13.00	26.53	315
10	18501.0	--	--	--	--	--	--	--	--

Note: 1.The other Spurious RF Radiated emissions level is no more than noise floor.  
 2. The worst emission was found in the antenna is Horizontal position.

NB-IOT Band 2 15KHz+BPSK CH-Middle

Harmonic	Frequency (MHz)	SG (dBm)	Cable Loss (dB)	Gain (dBi)	Antenna Polarization	EIRP Level (dBm)	Limit (dBm)	Margin (dB)	Azimuth (deg)
2	3759.8	-57.62	5.10	11.05	Horizontal	-51.67	-13.00	38.67	45
3	5638.9	-56.38	5.42	12.65	Horizontal	-49.15	-13.00	36.15	45
4	7520.0	-56.05	6.70	13.85	Horizontal	-48.90	-13.00	35.90	225
5	9400.0	-53.95	7.01	14.75	Horizontal	-46.21	-13.00	33.21	180
6	11280.0	-52.99	7.48	15.95	Horizontal	-44.52	-13.00	31.52	90
7	13160.0	-50.91	7.51	16.55	Horizontal	-41.87	-13.00	28.87	0
8	15040.0	-49.38	8.24	15.35	Horizontal	-42.27	-13.00	29.27	45
9	16920.0	-44.50	8.41	14.95	Horizontal	-37.96	-13.00	24.96	135
10	18800.0	--	--	--	--	--	--	--	--

Note: 1.The other Spurious RF Radiated emissions level is no more than noise floor.  
 2. The worst emission was found in the antenna is Horizontal position.

NB-IOT Band 2 15KHz+BPSK CH-High

Harmonic	Frequency (MHz)	SG (dBm)	Cable Loss (dB)	Gain (dBi)	Antenna Polarization	EIRP Level (dBm)	Limit (dBm)	Margin (dB)	Azimuth (deg)
2	3819.8	-52.81	5.10	11.05	Horizontal	-46.86	-13.00	33.86	180
3	5729.7	-56.56	5.42	12.65	Horizontal	-49.33	-13.00	36.33	225
4	7639.6	-55.17	6.70	13.85	Horizontal	-48.02	-13.00	35.02	135
5	9549.5	-53.03	7.01	14.75	Horizontal	-45.29	-13.00	32.29	90
6	11459.4	-52.45	7.48	15.95	Horizontal	-43.98	-13.00	30.98	45
7	13369.3	-52.01	7.51	16.55	Horizontal	-42.97	-13.00	29.97	0
8	15279.2	-48.66	8.24	15.35	Horizontal	-41.55	-13.00	28.55	45
9	17189.1	-44.84	8.41	14.95	Horizontal	-38.30	-13.00	25.30	135
10	19099.0	--	--	--	--	--	--	--	--

Note: 1.The other Spurious RF Radiated emissions level is no more than noise floor.  
 2. The worst emission was found in the antenna is Horizontal position.

NB-IOT Band 25 15KHz+BPSK CH-Low

Harmonic	Frequency (MHz)	SG (dBm)	Cable Loss (dB)	Gain (dBi)	Antenna Polarization	EIRP Level (dBm)	Limit (dBm)	Margin (dB)	Azimuth (deg)
2	3700.2	-57.62	5.10	11.05	Horizontal	-51.67	-13.00	38.67	0
3	5550.3	-55.37	5.42	12.65	Horizontal	-48.14	-13.00	35.14	90
4	7400.4	-55.53	6.70	13.85	Horizontal	-48.38	-13.00	35.38	135
5	9250.5	-51.42	7.01	14.75	Horizontal	-43.68	-13.00	30.68	225
6	11100.6	-52.58	7.48	15.95	Horizontal	-44.11	-13.00	31.11	0
7	12950.7	-52.22	7.51	16.55	Horizontal	-43.18	-13.00	30.18	315
8	14800.8	-49.42	8.24	15.35	Horizontal	-42.31	-13.00	29.31	180
9	16650.9	-46.30	8.41	14.95	Horizontal	-39.76	-13.00	26.76	45
10	18501.0	--	--	--	--	--	--	--	--

Note: 1.The other Spurious RF Radiated emissions level is no more than noise floor.  
 2. The worst emission was found in the antenna is Horizontal position.



## NB-IOT Band 25 15KHz+BPSK CH-Middle

Harmonic	Frequency (MHz)	SG (dBm)	Cable Loss (dB)	Gain (dBi)	Antenna Polarization	EIRP Level (dBm)	Limit (dBm)	Margin (dB)	Azimuth (deg)
2	3765.0	-57.64	5.10	11.05	Horizontal	-51.69	-13.00	38.69	180
3	5647.5	-55.41	5.42	12.65	Horizontal	-48.18	-13.00	35.18	45
4	7530.0	-54.37	6.70	13.85	Horizontal	-47.22	-13.00	34.22	315
5	9412.5	-53.69	7.01	14.75	Horizontal	-45.95	-13.00	32.95	90
6	11295.0	-52.45	7.48	15.95	Horizontal	-43.98	-13.00	30.98	315
7	13177.5	-51.15	7.51	16.55	Horizontal	-42.11	-13.00	29.11	180
8	15060.0	-48.74	8.24	15.35	Horizontal	-41.63	-13.00	28.63	0
9	16942.5	-46.22	8.41	14.95	Horizontal	-39.68	-13.00	26.68	45
10	18825.0	--	--	--	--	--	--	--	--

Note: 1.The other Spurious RF Radiated emissions level is no more than noise floor.

2. The worst emission was found in the antenna is Horizontal position.

## NB-IOT Band 25 15KHz+BPSK CH-High

Harmonic	Frequency (MHz)	SG (dBm)	Cable Loss (dB)	Gain (dBi)	Antenna Polarization	EIRP Level (dBm)	Limit (dBm)	Margin (dB)	Azimuth (deg)
2	3829.8	-53.20	5.10	11.05	Horizontal	-47.25	-13.00	34.25	180
3	5744.7	-56.13	5.42	12.65	Horizontal	-48.90	-13.00	35.90	90
4	7659.6	-54.35	6.70	13.85	Horizontal	-47.20	-13.00	34.20	45
5	9574.5	-53.40	7.01	14.75	Horizontal	-45.66	-13.00	32.66	315
6	11489.4	-52.12	7.48	15.95	Horizontal	-43.65	-13.00	30.65	0
7	13404.3	-51.55	7.51	16.55	Horizontal	-42.51	-13.00	29.51	225
8	15319.2	-48.84	8.24	15.35	Horizontal	-41.73	-13.00	28.73	90
9	17234.1	-45.17	8.41	14.95	Horizontal	-38.63	-13.00	25.63	45
10	19149.0	--	--	--	--	--	--	--	--

Note: 1.The other Spurious RF Radiated emissions level is no more than noise floor.

2. The worst emission was found in the antenna is Horizontal position.

## 6. Main Test Instruments

Name	Manufacturer	Type	Serial Number	Calibration Date	Expiration Date
Base Station Simulator	R&S	CMU200	118133	2019-05-19	2020-05-18
Base Station Simulator	R&S	CMW500	113824	2019-05-19	2020-05-18
Power Splitter	Hua Xiang	SHX-GF2-2-13	10120101	/	/
Spectrum Analyzer	Key sight	N9010A	MY50210259	2019-05-19	2020-05-18
Universal Radio Communication Tester	Key sight	E5515C	MY48367192	2019-05-19	2020-05-18
Signal Analyzer	R&S	FSV30	100815	2019-12-15	2020-12-14
Loop Antenna	SCHWARZBECK	FMZB1519	1519-047	2017-09-26	2020-09-25
Trilog Antenna	SCHWARZBECK	VUBL 9163	9163-201	2017-11-18	2020-11-17
Horn Antenna	R&S	HF907	100126	2018-07-07	2020-07-06
Horn Antenna	ETS-Lindgren	3160-09	00102643	2018-06-20	2020-06-19
Signal generator	R&S	SMB 100A	102594	2019-05-19	2020-05-18
Climatic Chamber	ESPEC	SU-242	93000506	2017-12-17	2020-12-16
Preamplifier	R&S	SCU18	102327	2019-05-19	2020-05-18
MOB COMMS DC SUPPLY	Keysight	66319D	MY43004105	2019-05-19	2020-05-18
RF Cable	Agilent	SMA 15cm	0001	2019-12-13	2020-6-12
Software	R&S	EMC32	9.26.0	/	/

\*\*\*\*\*END OF REPORT \*\*\*\*\*