

# DIGITAL PICTURE FRAME



## DIGITAL FRAME

PRODUCT INSTRUCTION MANUAL

**Dear customer**

Thankyou for purchasing the smart photo frame provided by our store

This product can be used to receive photos and videos and play the received photos/videos for you.

This product is pre-installed with the APP-frameo, which is simple to operate and easy to use, and can be connected to multiple mobile phones at a long distance.

In order to make you more satisfied with our products, please read our instruction manual and warranty terms carefully after purchase.

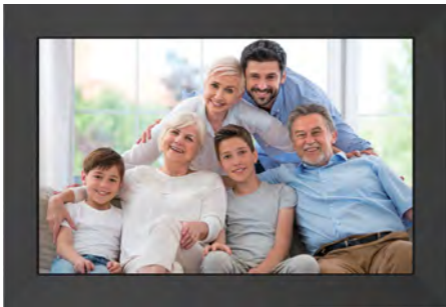

Package Contents & Hardware

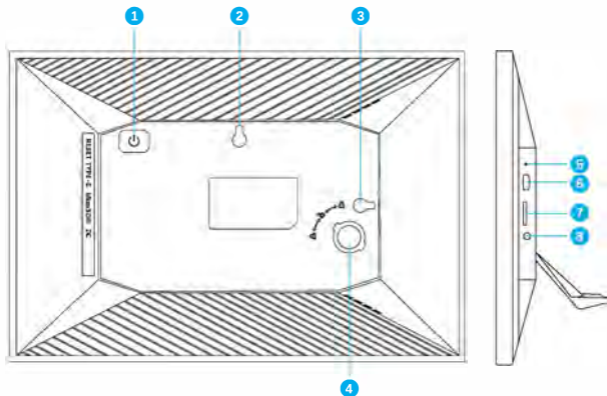

- 1** ON/OFF
- 2** Wall Hold-Horizontal
- 3** Wall Hold-Vertical
- 4** Bracket Hold
- 5** Reset
- 6** Type-C
- 7** Micro-SD
- 8** DC Input



#### 4 Display Modes

##### Landscape Mode & Portrait Mode

Auto-rotate

Wall Mounted

##### Product parameters

Motherboard specifications: A133

Display size: 10,1 inches

Display pixels: 800 X 1280

Network connection: WiFi

Data transmission: Bluetooth

Support: micro-SD

Frameo license: Frameo APP background license

Speaker: 8 ohm 2W \* 2PCS

US power adapter: 5V, cable length greater than 1,5 meters

Type-C interface: supports file copying, power support

The photo frame must be connected to the power supply during use and cannot be disconnected.

The screen of the photo frame is an LCD display. Please do not hit or drop it, which may cause the screen to break.

**Note:**

##### After-sales and Warranty:

For maintenance and operation of this product, please contact the customer service staff of the store through the sales platform according to the order information.

##### Commitment:

We provide free return and exchange service within 30 days due to quality problems

One year of after-sales repair service.

##### Please Note:

This digital photo frame needs to be used with APP-frameo. Please read the user manual of the APP carefully for specific usage steps.



## Getting started

Congratulations on your brand new Frameo photo frame!

If you are new to using Frameo then start by following the Frameo quick setup or follow the on-screen guide when powering it on for the first time.

Once you have set up your Frameo frame, you can start connecting it to your friends and family.

## Frameo app

To send photos to your frame, use the Frameo app for [iOS](#) or [Android](#).



Scan code to find the app

## Video tutorials

Check out our “Frameo Tutorials” playlist on YouTube with informative videos where we guide you on how to get started using Frameo. Scan the code to the right or use the link to find the playlist.



 YouTube



[bit.ly/3zKtzWX](https://bit.ly/3zKtzWX)



## Frameo quick setup

When starting your frame for the firsttime, you will need to set up the frame.

- Select a language. This will be the language used on the Frameo.
- Connect your frame to the internet by connecting it to Wi-Fi.
- Verify or correct the date and time.
- Frameo may ask you to update to the latest version. *It is recommended to update your frame before continuing if asked to.*
- Enter your name, and the location where you have placed your frame, e.g. "John Doe" and "Living room", "Kitchen" or "Office". Finally, set the timezone if not already correct.



## Start using Frameo

The next step is to connect Frameo with your friends and family by providing them with a code from your frame.

If you want to be able to send photos to the frame yourself, start by downloading the app for iOS or Android on [App Store](#) or [Google Play](#). Then use the code to connect your frame and app as described below.

### Connecting a new friend

Make sure that your friend has downloaded and installed the Frameo app.

Click the add friend icon on your frame . A dialog will appear showing a connection code, which is valid for 12 hours.

Now share this code in whatever fashion you prefer e.g. SMS, E-Mail, IM, phone call, to your friend.

Once your friends have added the code in their Frameo app, they will automatically appear on your frame and be able to send you photos.

Read chapter [Change options for a friend](#) to *allow* connected friends, to retrieve and share the connection code via the smartphone app.





## Navigating your Frameo

Swipe left or right to go through your photos.

To access the menu, simply tap once on the screen.

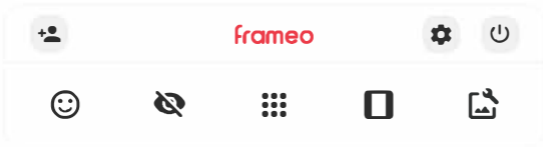

In the menu you will find the most used features.

### Add friend

This will generate a code that you can share with your friends and family so they can connect and send photos to your frame.

### Settings

Opens the [Settings](#).

### Power menu

Opens the [Power menu](#).

### React

Opens the [React menu](#).

**NB. The React menu can also be accessed by double-tapping on the screen.**

### Hide photo

Hides the current photo. This means that the photo will no longer be shown in the slideshow. If needed, the photo can be shown again through the [settings menu](#).

### Gallery

Opens a gallery which allows for easy and fast navigation through your photos.

### Fit to frame/Fill frame

This toggles how the photo is shown.



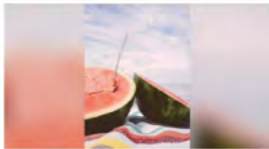

The *Fill frame* option is the default. The photo is scaled so that it fills the whole screen. It will be centered around what is selected as the most important part. See the first picture below.

*Fit to frame* will make sure that the entire photo is shown on the screen. See the second picture below.



### Adjust photo

Allows you to adjust the position of the photo in the frame for an even better fit. Here you can also use  to rotate your photo, and you can use  to edit the caption on imported photos. For received photos, please ask the sender to edit the caption in the Frameo app.

### Interacting with videos

When a video is shown, two additional controls are shown. One for play/pause of the video and one to control the volume level for video sounds.

Press  to start the video playback. Pressing  will pause the video playback.





Press  to open the volume slider. Use the slider to adjust the volume level for video sounds.

Pressing  will mute the video while pressing  will unmute the video.





### Power menu

Tap the power icon  to access the power menu. Here you can power off using , restart your frame using  or entersleep mode using .

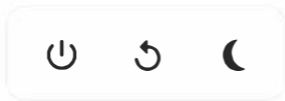



**NB. Make sure to always use the power off button on the device or in the power menu to turn Frameo off. Never disconnect power when Frameo is running.**

### React menu

Tap one of the reactions to let the sender know how it made you feel.



### External storage menu

When inserting an external storage (e.g. a microSD card) a menu will automatically appear with three options: Press  to play photos directly from the external storage, press  to import photos to the internal memory of your frame or press  to make a backup of your frame.



### **Clock and Weather widgets**

The current time and weather will appear in the upper-right corner of the frame when the frame has received at least one photo. Tapping either of these will open the weather menu.

### **Weather menu**

The weather menu contains more detailed weather forecasts and has shortcuts to weather-related settings.



Shows the weather location of your frame. Tap to access the weather location settings.

#### **1 DAY**

1-day forecast, which includes weather conditions for time periods of the day.

#### **4 DAY**

4-day forecast. Tap to see the weather forecast for the next four days.



Displays the frame's current time. Tap to access the time settings.



## Settings

Through the settings, you can personalize your frame to your needs.

### My frame

#### Frame name

Changes the name of your frame. This is also the name that connected friends and family will see in their list of connected frames in the smartphone app.

#### Frame location

Changes the location of your frame. This is the location displayed on your friends' and family's list of connected frames, which can help to distinguish frames from each other.

#### Set language

Sets the language used on the frame.

#### Weather location

Sets the location for the frame's weather feature, ensuring that your frame displays the appropriate weather forecast for you.

#### Temperature unit

Toggles between the Fahrenheit and Celsius temperature scales.

#### Date

Sets the date used on the frame.

#### Time

Sets the time used on the frame.

Frameo will automatically try to set the correct date and time when connected to the internet.

#### Time zone

Sets the time zone used on the frame.



### Set first day of week

Sets which day of the week is considered the first.

### Enable/Disable 24-hour format

Enables, and disables, 24-hour time format.

## Manage photos

In the manage photos menu, you can see how many photos are on your frame and the storage they use. You can also see the amount of storage left available on your device for storing new photos.



### Show/hide photos

Select which photos to hide by tapping them. Hidden photos will NOT be deleted from your frame, and you can always select them to be shown again.

Use  to hide or show all photos.

### Delete photos

Select photos that you want to permanently delete from your frame by tapping the photo.

Use  to select or deselect all and  to permanently delete the selected photos.

### Import photos

Allows you to import photos from an external storage (e.g. microSD card).

Before you try to import photos, make sure you have an external storage (e.g. microSD card) inserted into your frame with the photos you wish to import.

Start by selecting the photos that you want to import onto your frame. Once selected, tap the import button  to start the import process.

Use  to select or deselect all photos on the external storage (e.g. microSD card).

Use  to set the sort order of photos before import and  to order by ascending/descending.

**NB:** Please note, many frames will need a FAT32 formatted microSD card with a maximum of 32GB of storage. Please check with the brand of your frame for more information regarding compatibility for your specific device.



### Transfer from computer

Allows you to transfer photos from a computer using a USB cable. Enable the feature and then follow the on-screen guide for step-by-step instructions on how to transfer photos to your frame.

For more information, please visit our help center: [https://frameo.net/usb\\_faq](https://frameo.net/usb_faq)

### Export photos

Allows you to export photos from the frame to external storage (e.g. microSD card).

*The export function will export all photos on the frame as well as profile pictures.*

### Play from external storage

Enables / disables playback of photos and videos directly from an external storage (e.g. microSD card) without taking up space on the frame.

## My Friends

This list contains all the connected friends that are allowed to send photos to your frame.

### Change options for a friend

Click the options icon  to open the friend options menu.

From here, you can allow / disallow if a friend may share the code to the frame. If this is enabled, the friend can retrieve and share the code to the frame from his/her app.

You can also allow / disallow a friend to use the **Frameo** feature: Allow friend to see photos from this frame.

From the options menu you can also delete a friend, by pressing the DELETE FRIEND button. This will remove the friend from the list and thereby remove their permission to send photos to the frame. You will then be asked to confirm the removal and if you would like to remove all photos previously received from this friend.

### Add person

To allow a new person to send you photos, simply tap the add friend button  and share the presented code in whatever way you prefer.



## Display

### Brightness level

Adjust the brightness level of the screen.

### Sleep mode

Frameo offers a sleep mode which turns off the screen to reduce power consumption. The default setting is to turn off the screen at 23:00 and turn on the screen again at 07:00 every day.

This can be altered by changing your sleep schedule(s). It is possible to have multiple schedules active at once to e.g. have different settings for weekdays and the weekend or a separate schedule to turn off the frame while at work.

*Your frame is not powered down or in stand by, so you will still be able to receive photos during sleep mode.*

## Slideshow

### Timer

Set the duration that a photo should be displayed before showing the next photo.

### Fill frame

Set the default frame photo setting. Check to set default to fill which makes the photos fit the device screen according to the most important part of the photo. Uncheck to make the photo fit inside the screen of the device, adding background bars on the sides or top/bottom.

### Frame background

Choose between several different frame background options to be shown as bars if the photo does not fill the screen.

### Photo display order

Sets the order in which your photos are displayed on the frame.

- By date taken: Photos are shown in order of when it was taken.
- By date received: Photos are shown in order of when it was received.
- Shuffle: Photos are shuffled and shown in a random order.

### Reverse photo display order

Sets whether photos are displayed newest to oldest or oldest to newest.



**Show caption**

Set whether or not to display the captions that your friends have sent with the photo. Check to display captions. Uncheck to hide captions.

**Show clock**

Set whether or not to display the clock widget in the upper-right corner of the slideshow.

**Show weather**

Set whether or not to display the weather widget in the upper-right corner of the slideshow.

**Autoplay**

Enables/disables autoplay of videos in the slideshow. Videos can always be manually started regardless of this setting.

**Video playback**

Determines how videos should be played when autoplay is enabled.

- Loop videos: The video will loop until the slideshow timer is up.
- Play once: The video will play once and show its thumbnail until the timer is up.
- Play once and continue: The video will play once and continue to the next photo, or video, once it completes.

**Auto mute**

Enable to automatically mute the video volume after a short period of time of not interacting with the frame.

**Video volume**

Adjust the volume level for video sounds on the frames.

**Wi-Fi**

Set which Wi-Fi the frame connects to. If you are connecting to a network with a captive portal, Connection status will say that Wi-Fi login is required and show . Tap this to open a login screen where you can enter credentials to access the network.

**Wi-Fi details**

Use ⓘ to show details about the current connected Wi-Fi.

**Reset Wi-Fi**

Use ⚙ to delete all Wi-Fi information and restart your frame.

**Notifications****Show notifications**

Enables/disables whether notifications are shown in the slideshow (e.g. when a new photo is received).

**Notification volume**

Adjust the volume level for notification sounds.

**Storage space**

Enables/disables notifications shown when frame storage is low.

**Backup**

Enables/disables notifications shown if automatic backup has failed.

**Network connection**

Enables/disables notifications showing network connection status.

**New photos**

Enables/disables notifications shown when receiving new photos.

**New friends**

Enables/disables notifications shown when new friends are added.

**Software update**

Enables/disables notifications shown when a software update has been installed.

**Feature news**

Enables/disables notifications shown when new exciting features are added.

**Date and time**

Enables/disables notifications shown if time or date is not set correctly.





**Backup and Restore****Set up a cloud backup (Frameo+)**

 Tap *Set up cloud backup* and select a friend that has an active Frameo+ subscription, to initiate a cloud backup of your frame.

If you already have a backup set up, tap it to see more details.

Backup status will indicate what state your backup is in, with a symbol.

Cloud symbols and their meaning:

-  Backup complete and secured in the cloud
-  Cloud backup in progress
-  Frame is currently not backed up in the cloud
-  Waiting for other device to act (check the Frameo app on your phone)
-  Cloud backup failed



### External storage backup

#### Backup frame to external storage (e.g. microSD card)

Tap to make a backup of your photos, friends and settings. The time of the latest successful backup is also displayed here.

*Any existing backup on the external storage will be overridden!*

**NB:** Please note, many frames will need a FAT32 formatted microSD card with a maximum of 32GB of storage. Please check with the brand of your frame for more information regarding compatibility for your specific device.

### Automatic backup

If checked, your frame will automatically take a backup within 30 hours of receiving new photos or making changes to your frame.

### Restore from backup

*Before you attempt to restore your frame, start by confirming that your backup is up-to-date. This is done by confirming the date under "Backup frame to external storage (e.g. microSD card)". If e.g. the last backup is too old or if no backup is made, then press the "Backup frame to external storage (e.g. microSD card)" button to make a new backup.*

**NB:** *To keep both the old and the new frame operational at the same time after restoring from backup, please make sure that both frames are updated to the latest version beforehand.*

If you wish to restore a backup on a frame that has already been set up, then you must first reset the frame. This is done by pressing the "Reset frame" button. This will delete all data on the Frameo and reset the Frameo to its setup screen.

On the setup screen you can select the "Restore from backup" button which will restore your frame according to the backup.

If the "Restore from backup" button isn't visible, then confirm that the external storage (e.g. microSD card) is correctly mounted.

### Reset frame

Removes all data from your frame.

*This will permanently remove all your photos, friends/connections and settings.*

## Help

### Guide

Shows the quick start guide, which was shown when you first started the frame.

### Support

Find contact information for Frameo's support team, and find technical device information.

The menu features a special QR code that is there for our support staff to scan. It contains additional device details and information, enabling our support team to efficiently address your specific concerns and provide accurate assistance. Simply take a photo of the QR code and share it with our support staff.

## About

### Peer ID

This is a unique ID for your photo frame. When contacting our support, please provide this ID with your message.

### Frameo version

Shows what version of the Frameo software is currently installed on your frame.

### Check for update

Check if an update is available for your frame.

### Beta program

If checked, the device will join the Beta program, where it will receive updates more frequently and before normal release devices.

### Third party attributions

#### *Open source libraries*

Opens a list of open source libraries used in the app and their licenses



### Share anonymous analytics data

Sharing anonymous analytics data helps us tremendously to improve the Frameo software. We understand if you do not wish to share this data with us. Keep it checked if you wish to help us improve Frameo. Set unchecked to deny the sharing of anonymous analytics data.

## Privacy

For more information regarding privacy, please visit <http://privacyframeo.net>

## Support

Please visit <https://support.frameo.net/hc> for FAQ, support and to provide feedback.

## Warranty, Compliance, Support and Safety information

For more information regarding warranty, hardware compliance, support and safety, please refer to the material included in the package.

## FCC Statement

This equipment has been tested and found to comply with the limits for a Class B digital device, pursuant to Part 15 of the FCC Rules. These limits are designed to provide reasonable protection against harmful interference in a residential installation. This equipment generates uses and can radiate radio frequency energy and, if not installed and used in accordance with the instructions, may cause harmful interference to radio communications. However, there is no guarantee that interference will not occur in a particular installation. If this equipment does cause harmful interference to radio or television reception, which can be determined by turning the equipment off and on, the user is encouraged to try to correct the interference by one or more of the following measures:

- Reorient or relocate the receiving antenna.
- Increase the separation between the equipment and receiver.
- Connect the equipment into an outlet on a circuit different from that to which the receiver is connected.
- Consult the dealer or an experienced radio/TV technician for help.

This device complies with part 15 of the FCC Rules. Operation is subject to the following two conditions: (1) This device may not cause harmful interference, and (2) this device must accept any interference received, including interference that may cause undesired operation.

Changes or modifications not expressly approved by the party responsible for compliance could void the user's authority to operate the equipment.

This equipment complies with FCC radiation exposure limits set forth for an uncontrolled environment. This equipment should be installed and operated with minimum distance 20cm between the radiator & your body.

### - English:

This device complies with Industry Canada licence-exempt RSS standard(s).

Operation is subject to the following two conditions: (1) This device may not cause interference, and (2) This device must accept any interference, including interference that may cause undesired operation of the device.

### - French:

Le présent appareil est conforme aux CNR d'Industrie Canada applicables aux appareils radio exempts de licence. L'exploitation est autorisée aux deux conditions suivantes:

- (1) l'appareil ne doit pas produire de brouillage, et
- (2) l'utilisateur de l'appareil doit accepter tout brouillage radioélectrique subi, même si le brouillage est susceptible d'en compromettre le fonctionnement.

L'équipement est conforme aux limites d'exposition aux rayonnements définies par la FCC pour les environnements non contrôlés. La distance minimale entre le dissipateur de chaleur et votre corps doit être de 20 cm lors de l'installation et de l'utilisation du matériel.