



# FCC Test Report

**Test Report  
On Behalf of  
Nanning Tuli Electronic Technology Co Ltd  
For  
EDIMAEG HERO-800 Amplifier Bluetooth with Earpiece  
Model No.: HERO-800, A780  
FCC ID: 2BL9L-HERO-800**

**Prepared For:** Nanning Tuli Electronic Technology Co Ltd  
Daxue Road 41 hao, Jia hui xin yuan xiao qu 10 hao lou A zuo 501 fang,  
Nanning, Guangxi, 530012, China

**Prepared By:** Shenzhen HUAK Testing Technology Co., Ltd.  
1-2/F., Building B2, Junfeng Zhongcheng Zhizao Innovation Park, Heping, Fuhai  
Street, Bao'an District, Shenzhen, Guangdong, China

**Date of Test:** Oct. 30, 2024 ~ Nov. 12, 2024

**Date of Report:** Nov. 12, 2024

**Report Number:** HK2410306418-E



### Test Result Certification

**Applicant's Name**.....: Nanning Tuli Electronic Technology Co Ltd  
**Address** .....: Daxue Road 41 hao, Jia hui xin yuan xiao qu 10 hao lou A zuo 501 fang, Nanning, Guangxi, 530012, China  
**Manufacturer's Name** .....: Nanning Tuli Electronic Technology Co Ltd  
**Address** .....: Daxue Road 41 hao, Jia hui xin yuan xiao qu 10 hao lou A zuo 501 fang, Nanning, Guangxi, 530012, China

### Product Description

**Trade Mark** .....: EDIMAEG  
**Product Name** .....: EDIMAEG HERO-800 Amplifier Bluetooth with Earpiece  
**Model and/or Type Reference**...: HERO-800, A780

**Standards** .....: **47 CFR FCC Part 15 Subpart C 15.247**

This publication may be reproduced in whole or in part for non-commercial purposes as long as the Shenzhen HUAK Testing Technology Co., Ltd. is acknowledged as copyright owner and source of the material. Shenzhen HUAK Testing Technology Co., Ltd. takes no responsibility for and will not assume liability for damages resulting from the reader's interpretation of the reproduced material due to its placement and context.

### Date of Test

**Date (s) of Performance of Tests** ..... **Oct. 30, 2024 ~ Nov. 12, 2024**  
**Date of Issue**..... **Nov. 12, 2024**  
**Test Result**..... **Pass**

Testing Engineer

Len Liao

Technical Manager

Sliver Wan

Authorized Signatory

Jason Zhou



Table of Contents

Page

- 1. Summary..... 5
  - 1.1. Test Standards .....5
  - 1.2. Test Description .....5
  - 1.3. Information of the Test Laboratory ..... 6
  - 1.4. Statement of the Measurement Uncertainty ..... 6
- 2. General Information ..... 7
  - 2.1. Environmental Conditions .....7
  - 2.2. General Description of EUT .....7
  - 2.3. Description of Test Modes and Test Frequency .....8
  - 2.4. Equipments Used during the Test .....9
  - 2.5. Related Submittal(s) / Grant (s) .....10
  - 2.6. Modifications .....10
  - 2.7. Description of Test Setup .....10
  - 2.8. Description of Support Units .....11
- 3. Test Conditions and Results..... 12
  - 3.1. Conducted Emissions Test .....12
  - 3.2. Radiated Emissions and Band Edge .....15
  - 3.3. Maximum Peak Conducted Output Power .....26
  - 3.4. 20dB Bandwidth .....27
  - 3.5. Frequency Separation .....30
  - 3.6. Number of Hopping Frequency .....32
  - 3.7. Time of Occupancy (Dwell Time) .....34
  - 3.8. Out-of-Band Emissions .....37
  - 3.9. Pseudorandom Frequency Hopping Sequence .....44
  - 3.10. Antenna Requirement .....45
- 4. Test Setup Photos of the EUT ..... 46
- 5. Photos of the EUT ..... 48

The results shown in this test report refer only to the sample(s) tested unless otherwise stated and the sample(s) are retained for 30 days only. The document is issued by HUAK, this document cannot be reproduced except in full with our prior written permission. The more details and the authenticity of the report will be confirmed at <http://www.cer-mark.com>.

TEL : +86-755 2302 9901 FAX : +86-755 2302 9901 E-mail : [service@cer-mark.com](mailto:service@cer-mark.com)

Add: 1-2F., Building B2, Junfeng Zhongcheng Zhizao Innovation Park, Heping Community, Fuhai Street, Bao'an District, Shenzhen, Guangdong, China



**\*\* Modified History \*\***

<b>Revision</b>	<b>Description</b>	<b>Issued Data</b>	<b>Remark</b>
Revision 1.0	Initial Test Report Release	Nov. 12, 2024	Jason Zhou





# 1. Summary

## 1.1. Test Standards

The tests were performed according to following standards:

**FCC Rules Part 15.247:** Frequency Hopping, Direct Spread Spectrum and Hybrid Systems that are in operation within the bands of 902-928 MHz, 2400-2483.5 MHz, and 5725-5850 MHz

**ANSI C63.10:2013:** American National Standard for Testing Unlicensed Wireless Devices

## 1.2. Test Description

FCC PART 15.247		
FCC Part 15.207	AC Power Conducted Emission	PASS
FCC Part 15.215	20dB Bandwidth& 99% Bandwidth	PASS
FCC Part 15.247(d)	Spurious RF Conducted Emission	PASS
FCC Part 15.247(b)	Maximum Peak Output Power	PASS
FCC Part 15.247 (a) (1)	Pseudorandom Frequency Hopping Sequence	PASS
FCC Part 15.247(a)(1)(iii)	Number of Hopping Frequency& Time of Occupancy	PASS
FCC Part 15.247(a)(1)	Frequency Separation	PASS
FCC Part 15.205/15.209	Radiated Emissions	PASS
FCC Part 15.247(d)	Band Edge Compliance of RF Emission	PASS



### 1.3. Information of the Test Laboratory

Shenzhen HUAK Testing Technology Co., Ltd.  
Add.: 1-2/F., Building B2, Junfeng Zhongcheng Zhizao Innovation Park, Heping, Fuhai Street, Bao'an District, Shenzhen, Guangdong, China

Testing Laboratory Authorization :

A2LA Accreditation Code is 4781.01.  
FCC Designation Number is CN1229.  
Canada IC CAB identifier is CN0045.  
CNAS Registration Number is L9589.

### 1.4. Statement of the Measurement Uncertainty

The data and results referenced in this document are true and accurate. The reader is cautioned that there may be errors within the calibration limits of the equipment and facilities. The measurement uncertainty was calculated for all measurements listed in this test report acc. to CISPR 16 - 4 "Specification for radio disturbance and immunity measuring apparatus and methods – Part 4: Uncertainty in EMC Measurements" and is documented in the Shenzhen HUAK Testing Technology Co., Ltd. quality system acc. to DIN EN ISO/IEC 17025. Furthermore, component and process variability of devices similar to that tested may result in additional deviation. The manufacturer has the sole responsibility of continued compliance of the device.

Hereafter the best measurement capability for HUAK laboratory is reported:

Test	Measurement Uncertainty	Notes
Transmitter power conducted	±0.37dB	(1)
Transmitter power Radiated	±3.35dB	(1)
Conducted spurious emission 9KHz-40 GHz	±2.20dB	(1)
Occupied Bandwidth	±3.68%	(1)
Radiated Emission 30~1000MHz	±3.90dB	(1)
Radiated Emission Above 1GHz	±4.28dB	(1)
Conducted Disturbance0.15~30MHz	±2.71dB	(1)

(1) This uncertainty represents an expanded uncertainty expressed at approximately the 95% confidence level using a coverage factor of k=2.



## 2. General Information

### 2.1. Environmental Conditions

During the measurement the environmental conditions were within the listed ranges:

Normal Temperature:	25°C
Relative Humidity:	55 %
Air Pressure:	101 kPa

### 2.2. General Description of EUT

Product Name:	EDIMAEG HERO-800 Amplifier Bluetooth with Earpiece
Model/Type Reference:	HERO-800
Series Model:	A780
Model Difference:	All model's the function, software and electric circuit are the same, only with product model named different. Test sample model: HERO-800.
Power Supply:	DC5V From Micro USB or DC3.7V From Battery
Version:	Supported EDR
Modulation:	GFSK, π/4DQPSK
Operation Frequency:	2402MHz~2480MHz
Channel Number:	79
Channel Separation:	1MHz
Antenna Type:	PCB Antenna
Antenna Gain:	1.9dBi
Hardware Version:	V1.0
Software Version:	V1.0

Note:

1. For a more detailed features description, please refer to the manufacturer's specifications or the User's Manual.
2. Antenna gain Refer to the antenna specifications.
3. The cable loss data is obtained from the supplier.
4. The test results in the report only apply to the tested sample.



### 2.3. Description of Test Modes and Test Frequency

The Applicant provides communication tools software to control the EUT for staying in continuous transmitting and receiving mode for testing.

There are 79 channels provided to the EUT and Channel 00/39/78 was selected for testing.

#### Operation Frequency:

Channel	Frequency (MHz)
00	2402
01	2403
:	:
38	2440
39	2441
40	2442
:	:
77	2479
78	2480

Note: The line display in grey were the channel selected for testing

Preliminary tests were performed in each mode and packet length of BT, and found worst case as bellow, finally test were conducted at those mode and recorded in this report.

Test Items	Worst Case
Conducted Emissions	Charging mode
Radiated Emissions and Band Edge	DH5 low channel
Maximum Conducted Output Power	DH5/2DH5
20dB Bandwidth & 99% Bandwidth	DH5/2DH5
Frequency Separation	DH5/2DH5 Middle channel
Number of hopping frequency	DH5/2DH5
Time of Occupancy (Dwell Time)	DH1/DH3/DH5 Middle channel 2DH1/2DH3/2DH5 Middle channel
Out-of-band Emissions	DH5/2DH5





### 2.4. Equipments Used during the Test

Item	Equipment	Manufacturer	Model No.	Serial No.	Last Cal.	Cal. Interval
1.	L.I.S.N.	R&S	ENV216	HKE-002	2024/02/20	1 Year
2	L.I.S.N.	R&S	ENV216	HKE-059	2024/02/20	1 Year
3	EMI Test Receiver	R&S	ESR	HKE-005	2024/02/20	1 Year
4	Spectrum analyzer	Agilent	N9020A	HKE-025	2024/02/20	1 Year
5	Spectrum analyzer	R&S	FSV3044	HKE-126	2024/02/20	1 Year
6	Preamplifier	EMCI	EMC05184 5S	HKE-006	2024/02/20	1 Year
7	Preamplifier	Schwarzbeck	BBV 9743	HKE-016	2024/02/20	1 Year
8	Preamplifier	A.H. Systems	SAS-574	HKE-182	2024/02/20	1 Year
9	6dB Attenuator	Pasternack	6db	HKE-184	2024/02/20	1 Year
10	EMI Test Receiver	Rohde & Schwarz	ESR-7	HKE-010	2024/02/20	1 Year
11	Broadband Antenna	Schwarzbeck	VULB9168	HKE-167	2024/02/21	2 Year
12	Loop Antenna	COM-POWER	AL-130R	HKE-014	2024/02/21	2 Year
13	Horn Antenna	Schwarzbeck	9120D	HKE-013	2024/02/21	2 Year
14	EMI Test Software	Tonscend	JS32-CE 2.5.0.6	HKE-081	/	/
15	EMI Test Software	Tonscend	JS32-RE 5.0.0	HKE-082	/	/
16	RF Automatic control unit	Tonscend	JS0806-2	HKE-060	2024/02/20	1 Year
17	High pass filter unit	Tonscend	JS0806-F	HKE-055	2024/02/20	1 Year
18	Wireless Communication Test Set	R&S	CMU200	HKE-026	2024/02/20	1 Year
19	Wireless Communication Test Set	R&S	CMW500	HKE-027	2024/02/20	1 Year
20	High-low temperature chamber	Guangke	HT-80L	HKE-118	2024/06/10	1 Year
21	Temperature and humidity meter	Boyang	HTC-1	HKE-075	2024/06/10	1 Year
22	RF Test Software	Tonscend	JS1120-3 Version 3.3.23	HKE-083	/	/
23	10dB Attenuator	Schwarzbeck	VTSD9561F	HKE-153	2024/02/20	1 Year
24	RSE Test Software	Tonscend	JS36-RSE 5.0.0	HKE-184	/	/

The results shown in this test report refer only to the sample(s) tested unless otherwise stated and the sample(s) are retained for 30 days only. The document is issued by HUAK, this document cannot be reproduced except in full with our prior written permission. The more details and the authenticity of the report will be confirmed at <http://www.cer-mark.com>.

TEL : +86-755 2302 9901 FAX : +86-755 2302 9901 E-mail : [service@cer-mark.com](mailto:service@cer-mark.com)

Add: 1-2F., Building B2, Junfeng Zhongcheng Zhizao Innovation Park, Heping Community, Fuhai Street, Bao'an District, Shenzhen, Guangdong, China



## 2.5. Related Submittal(s) / Grant (s)

This submittal(s) (test report) is intended to comply with Section 15.247 of the FCC Part 15, Subpart C Rules.

## 2.6. Modifications

No modifications were implemented to meet testing criteria.

## 2.7. Description of Test Setup

Operation of EUT during Conducted testing and below 1GHz Radiation testing:

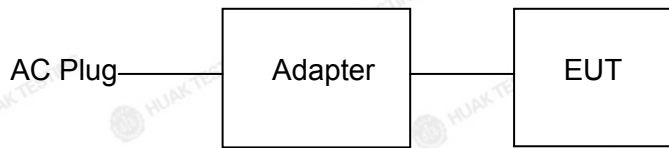

Operation of EUT during above 1GHz Radiation testing:



The sample was placed (0.8m below 1GHz, 1.5m above 1GHz) above the ground plane of 3m chamber. Measurements in both horizontal and vertical polarities were performed. During the test, each emission was maximized by: having the EUT continuously working, investigated all operating modes, rotated about all 3 axis (X, Y & Z) and considered typical configuration to obtain worst position, manipulating interconnecting cables, rotating the turntable, varying antenna height from 1m to 4m in both horizontal and vertical polarizations. The emissions worst-case are shown in Test Results of the following pages. The worst case is X position.



### 2.8. Description of Support Units

The EUT has been tested as an independent unit together with other necessary accessories or support units. The following support units or accessories were used to form a representative test configuration during the tests.

Item	Equipment	Trade Mark	Model/Type No.	Specification	Note
1	EDIMAEG HERO-800 Amplifier Bluetooth with Earpiece	EDIMAEG	HERO-800	N/A	EUT
2	USB Cable	N/A	N/A	Length: 25cm	Accessory
3	Adapter	N/A	HB-99IC	Input: AC110-240V, 50-60Hz, 0.1A Output: DC5V±0.5V, 1000mA±50mA	Accessory

**Note:**

1. All the equipment/cables were placed in the worst-case configuration to maximize the emission during the test.
2. Grounding was established in accordance with the manufacturer's requirements and conditions for the intended use.
3. For conducted measurements (Output Power, 6dB Emission Bandwidth, Power Spectral Density, Spurious Emissions), the antenna of EUT is connected to the test equipment via temporary antenna connector, the antenna connector is soldered on the antenna port of EUT, and the temporary antenna connector is listed in the Test Instruments.



### 3. Test Conditions and Results

#### 3.1. Conducted Emissions Test

##### Limit

According to FCC CFR Title 47 Part 15 Subpart C Section 15.207 and RSS Gen 8.8, AC Power Line Conducted Emissions Limits for License-Exempt Radio Apparatus as below:

Frequency range (MHz)	Limit (dBuV)	
	Quasi-peak	Average
0.15-0.5	66 to 56*	56 to 46*
0.5-5	56	46
5-30	60	50

\* Decreases with the logarithm of the frequency.

##### Test Configuration

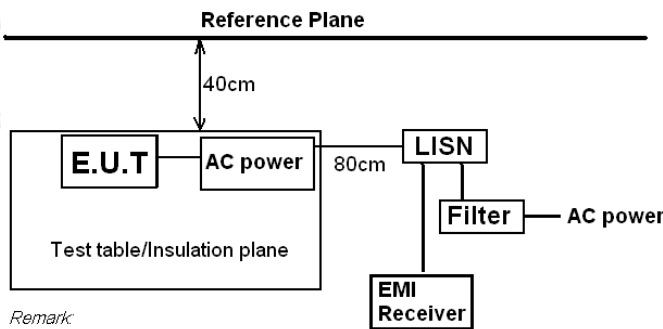

Remark  
 E.U.T: Equipment Under Test  
 LISN: Line Impedance Stabilization Network  
 Test table height=0.8m

##### Test Procedure

1. The equipment was set up as per the test configuration to simulate typical actual usage per the user’s manual. The EUT is a tabletop system; a wooden table with a height of 0.8 meters is used and is placed on the ground plane as per ANSI C63.10.
2. Support equipment, if needed, was placed as per ANSI C63.10.
3. All I/O cables were positioned to simulate typical actual usage as per ANSI C63.10.
4. The adapter received AC120V/60Hz power through a Line Impedance Stabilization Network (LISN) which supplied power source and was grounded to the ground plane.
5. All support equipments received AC power from a second LISN, if any.
6. The EUT test program was started. Emissions were measured on each current carrying line of the EUT using a spectrum Analyzer / Receiver connected to the LISN powering the EUT. The LISN has two monitoring points: Line 1 (Hot Side) and Line 2 (Neutral Side). Two scans were taken: one with Line 1 connected to Analyzer / Receiver and Line 2 connected to a 50 ohm load; the second scan had Line 1 connected to a 50 ohm load and Line 2 connected to the Analyzer / Receiver.
7. Analyzer / Receiver scanned from 150 KHz to 30MHz for emissions in each of the test modes.
8. During the above scans, the emissions were maximized by cable manipulation.





Test Results

All modes have been tested, only the worst result was reported as below:

Test Specification: Line

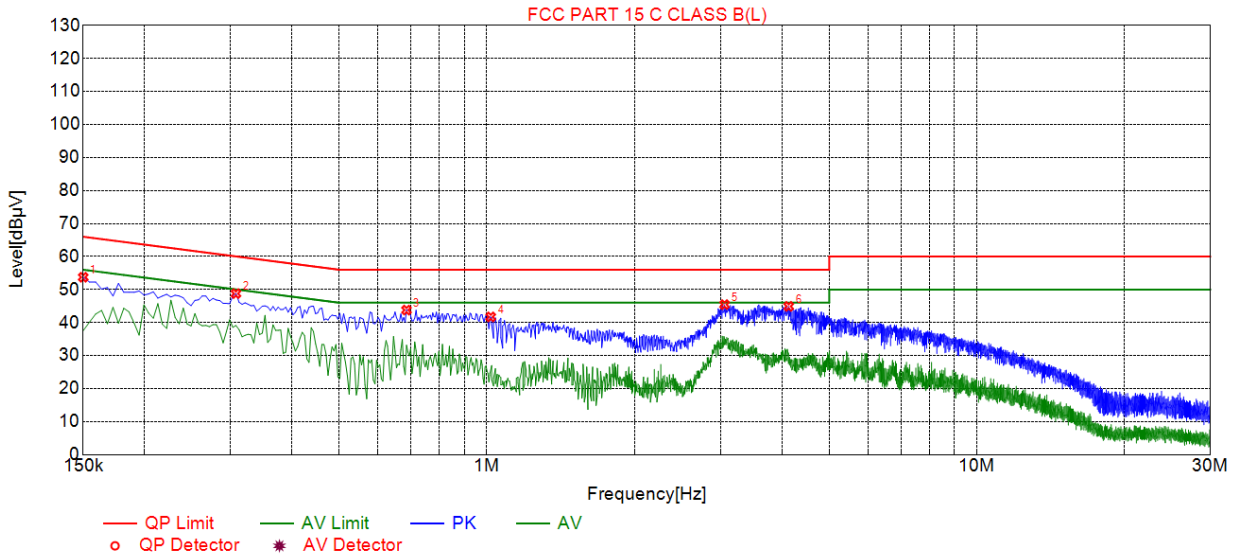

Suspected List								
NO.	Freq. [MHz]	Level [dBµV]	Factor [dB]	Limit [dBµV]	Margin [dB]	Reading [dBµV]	Detector	Type
1	0.1500	53.73	19.83	66.00	12.27	33.90	PK	L
2	0.3075	48.78	19.85	60.04	11.26	28.93	PK	L
3	0.6855	43.79	19.86	56.00	12.21	23.93	PK	L
4	1.0185	41.72	19.88	56.00	14.28	21.84	PK	L
5	3.0570	45.44	20.05	56.00	10.56	25.39	PK	L
6	4.1325	44.90	20.09	56.00	11.10	24.81	PK	L

Remark: Margin = Limit – Level

Correction factor = Cable lose + LISN insertion loss

Level=Test receiver reading + correction factor



Test Specification: Neutral

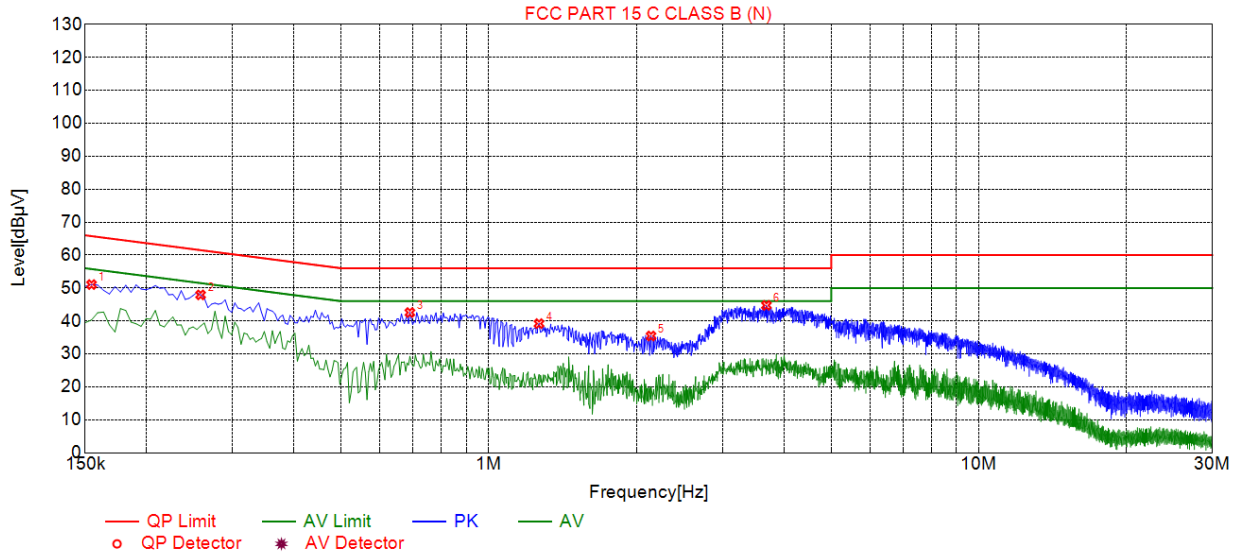

Suspected List								
NO.	Freq. [MHz]	Level [dBµV]	Factor [dB]	Limit [dBµV]	Margin [dB]	Reading [dBµV]	Detector	Type
1	0.1545	51.05	19.73	65.75	14.70	31.32	PK	N
2	0.2580	47.93	19.73	61.50	13.57	28.20	PK	N
3	0.6900	42.55	19.74	56.00	13.45	22.81	PK	N
4	1.2680	39.20	19.77	56.00	16.80	19.43	PK	N
5	2.1435	35.45	19.85	56.00	20.55	15.60	PK	N
6	3.6870	44.74	19.97	56.00	11.26	24.77	PK	N

Remark: Margin = Limit – Level

Correction factor = Cable lose + LISN insertion loss

Level=Test receiver reading + correction factor

### 3.2. Radiated Emissions and Band Edge

#### Limit

For intentional device, according to § 15.209(a), the general requirement of field strength of radiated emission out of authorized band shall not exceed the following table at a 3 meters measurement distance.

In addition, radiated emissions which fall in the restricted bands, as defined in §15.205(a), must also comply with the radiated emission limits specified in §15.209(a)

Except when the requirements applicable to a given device state otherwise, emissions from License-Exempt transmitters shall comply with the field strength limits shown in table below. Additionally, the level of any transmitter emission shall not exceed the level of the transmitter's fundamental emission

Unwanted emissions that fall into restricted bands shall comply with the limits specified in RSS-Gen; and Unwanted emissions that do not fall within the restricted frequency bands shall comply either with the limits specified in the applicable RSS or with those specified in this RSS-Gen.

Radiated Emission Limits

Frequency (MHz)	Distance (Meters)	Radiated (dBµV/m)	Radiated (µV/m)
0.009-0.49	3	$20\log(2400/F(\text{KHz}))+40\log(300/3)$	$2400/F(\text{KHz})$
0.49-1.705	3	$20\log(24000/F(\text{KHz}))+40\log(30/3)$	$24000/F(\text{KHz})$
1.705-30	3	$20\log(30)+40\log(30/3)$	30
30-88	3	40.0	100
88-216	3	43.5	150
216-960	3	46.0	200
Above 960	3	54.0	500

#### Test Configuration

(A) Radiated Emission Test Set-Up, Frequency Below 30MHz

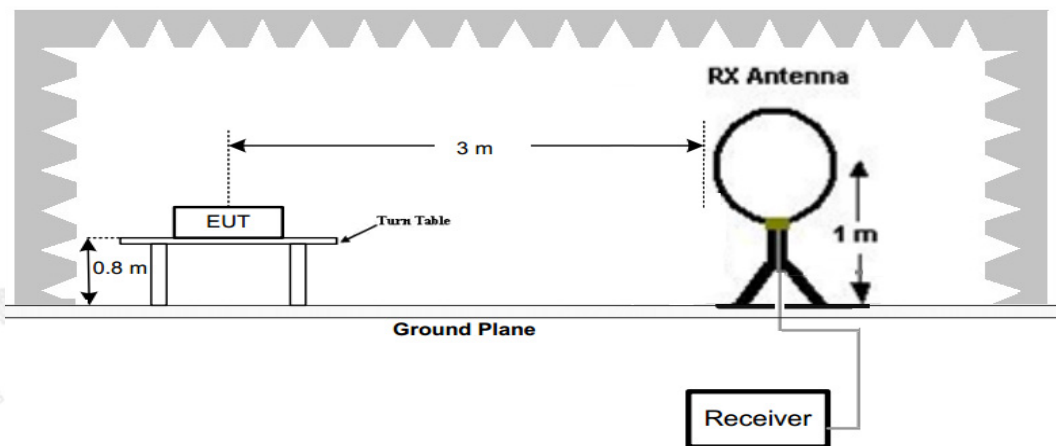

(B) Radiated Emission Test Set-Up, Frequency below 1000MHz

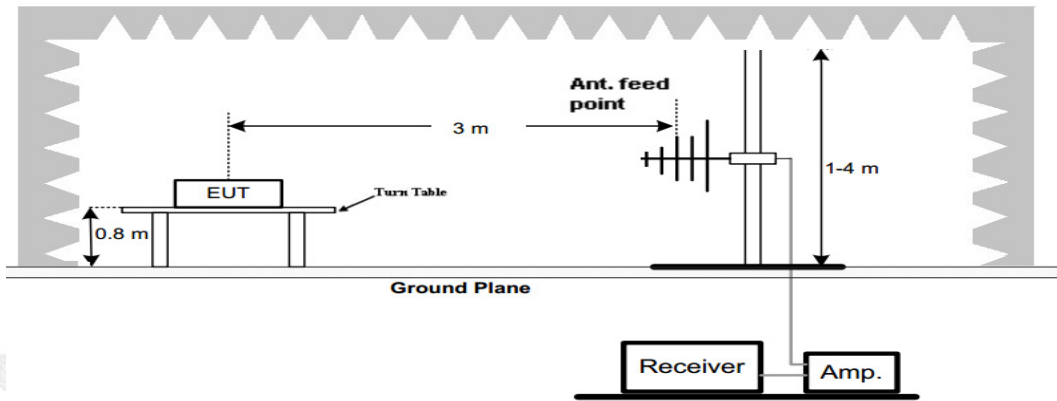

(C) Radiated Emission Test Set-Up, Frequency above 1000MHz

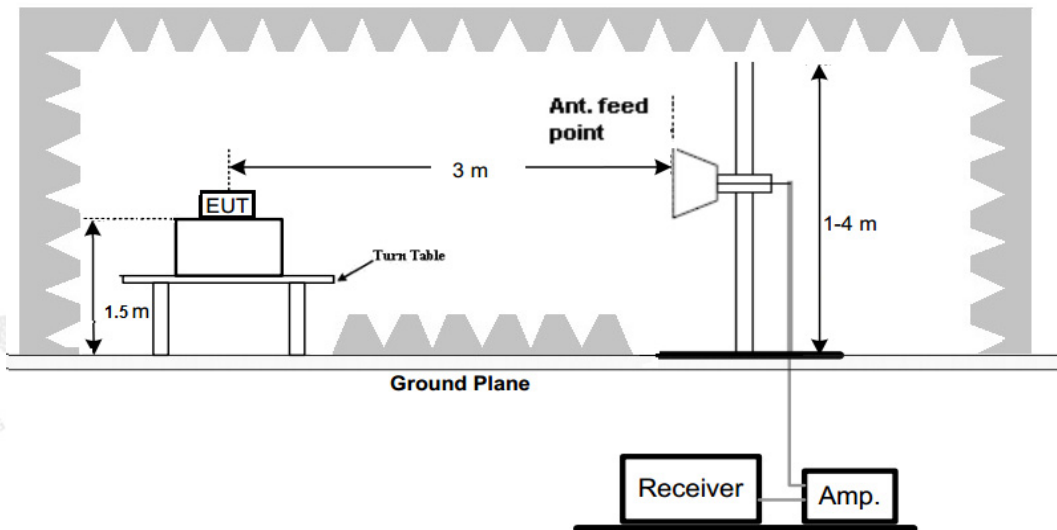

### Test Procedure

1. The EUT was placed on turn table which is 0.8m above ground plane for below 1GHz test, and on a low permittivity and low loss tangent turn table which is 1.5m above ground plane for above 1GHz test.
2. Maximum procedure was performed by raising the receiving antenna from 1m to 4m and rotating the turn table from 0 degrees to 360 degrees to acquire the highest emissions from EUT.
3. And also, each emission was to be maximized by changing the polarization of receiving antenna both horizontal and vertical.
4. Repeat above procedures until all frequency measurements have been completed.





Test Results

Remark:

1. Radiated Emission measured at GFSK, π/4 DQPSK mode from 9 KHz to 10th harmonic of fundamental and recorded worst case at GFSK DH5 mode.
2. There is no emission found except system noise floor in 9 KHz to 30MHz and not recorded in this report.
3. For below 1GHz testing recorded worst at GFSK DH5 low channel.

Below 1GHz Test Results:

Antenna polarity: H

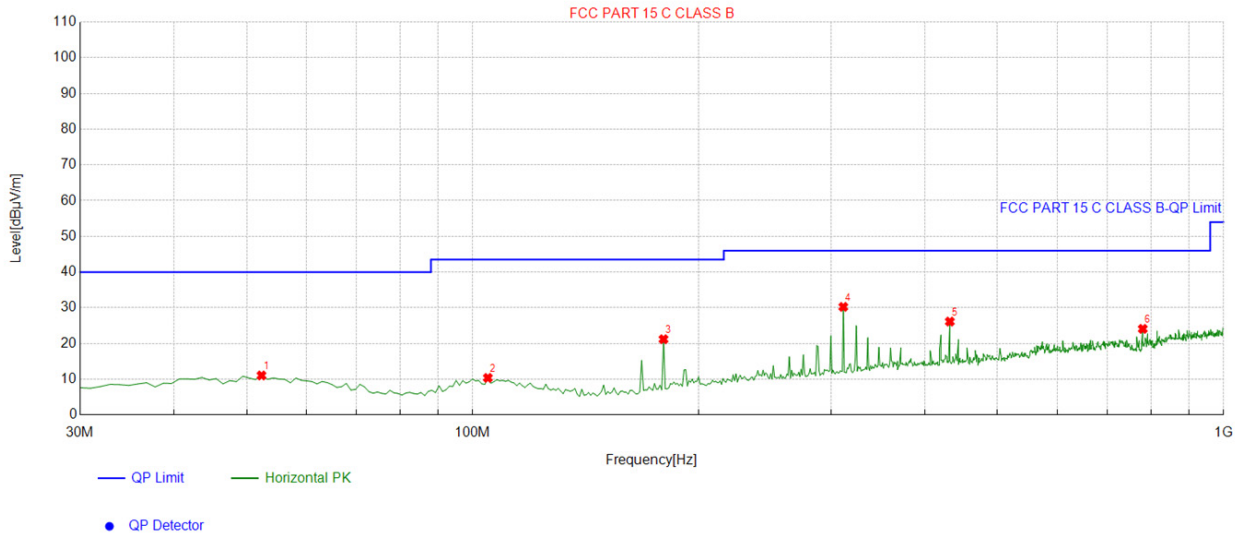

Suspected List									
NO.	Freq. [MHz]	Factor [dB]	Reading [dBμV/m]	Level [dBμV/m]	Limit [dBμV/m]	Margin [dB]	Height [cm]	Angle [°]	Polarity
1	52.332332	-13.35	24.41	11.06	40.00	28.94	100	179	Horizontal
2	104.76476	-14.69	25.07	10.38	43.50	33.12	100	33	Horizontal
3	179.52953	-16.59	37.79	21.20	43.50	22.30	100	359	Horizontal
4	311.58158	-11.70	41.96	30.26	46.00	15.74	100	22	Horizontal
5	431.98198	-8.85	34.99	26.14	46.00	19.86	100	110	Horizontal
6	780.56056	-3.92	28.02	24.10	46.00	21.90	100	93	Horizontal

Remark: Factor = Cable loss + Antenna factor + Attenuator – Preamplifier; Level = Reading + Factor; Margin = Limit – Level;



Antenna polarity: V

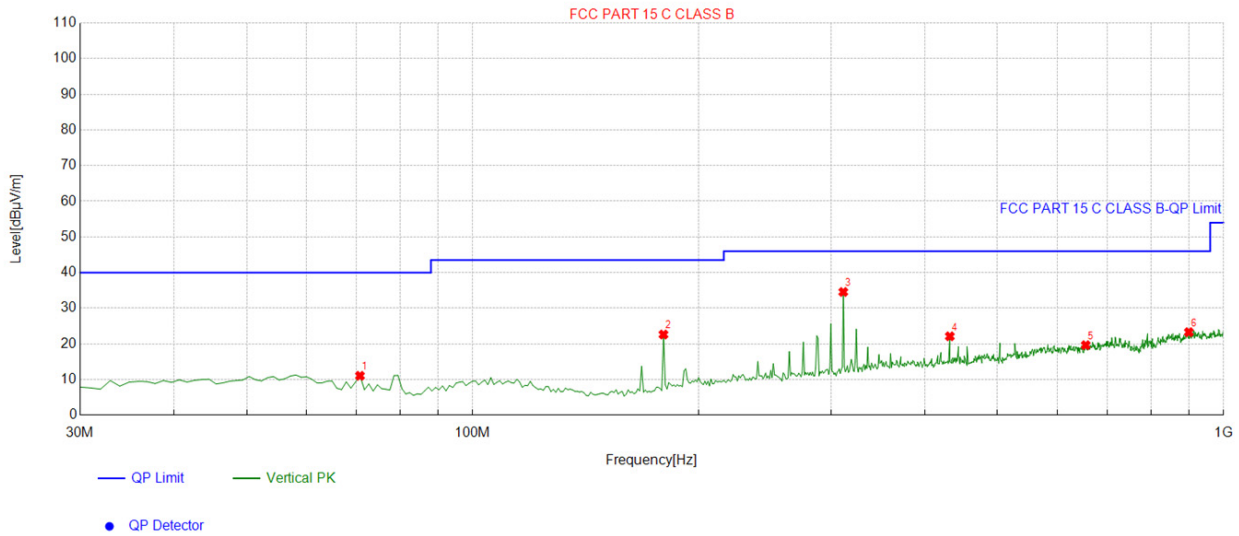

Suspected List									
NO.	Freq. [MHz]	Factor [dB]	Reading [dBµV/m]	Level [dBµV/m]	Limit [dBµV/m]	Margin [dB]	Height [cm]	Angle [°]	Polarity
1	70.780781	-16.89	27.94	11.05	40.00	28.95	100	155	Vertical
2	179.52953	-16.59	39.22	22.63	43.50	20.87	100	83	Vertical
3	311.58158	-11.70	46.26	34.56	46.00	11.44	100	285	Vertical
4	431.98198	-8.85	30.97	22.12	46.00	23.88	100	260	Vertical
5	655.30530	-4.79	24.43	19.64	46.00	26.36	100	199	Vertical
6	899.01901	-1.03	24.31	23.28	46.00	22.72	100	47	Vertical

Remark: Factor = Cable loss + Antenna factor + Attenuator – Pre-amplifier; Level = Reading + Factor; Margin = Limit – Level;

### Harmonics and Spurious Emissions

#### Frequency Range (9 kHz-30MHz)

Frequency (MHz)	Level@3m (dBµV/m)	Limit@3m (dBµV/m)
--	--	--
--	--	--
--	--	--
--	--	--

**Note:** 1. Emission Level=Reading+ Cable loss+ Antenna factor-Amp factor  
 2. The emission levels are 20 dB below the limit value, which are not reported. It is deemed to comply with the requirement



For 1GHz to 25GHz

CH Low (2402MHz)

Horizontal:

Frequency (MHz)	Meter Reading (dBμV)	Factor (dB)	Emission Level (dBμV/m)	Limits (dBμV/m)	Margin (dB)	Detector Type
4804.00	49.18	-3.65	45.53	74.00	-28.47	peak
4804.00	44.49	-3.65	40.84	54.00	-13.16	AVG
7206.00	50.51	-0.95	49.56	74.00	-24.44	peak
7206.00	42.07	-0.95	41.12	54.00	-12.88	AVG

Remark: Factor = Cable loss + Antenna factor + Attenuator – Preamplifier; Level = Reading + Factor; Margin = Level - Limit.

Vertical:

Frequency (MHz)	Meter Reading (dBμV)	Factor (dB)	Emission Level (dBμV/m)	Limits (dBμV/m)	Margin (dB)	Detector Type
4804.00	51.75	-3.65	48.10	74.00	-25.90	peak
4804.00	46.82	-3.65	43.17	54.00	-10.83	AVG
7206.00	50.49	-0.95	49.54	74.00	-24.46	peak
7206.00	40.76	-0.95	39.81	54.00	-14.19	AVG

Remark: Factor = Cable loss + Antenna factor + Attenuator – Preamplifier; Level = Reading + Factor; Margin = Level - Limit.



CH Middle (2441MHz)

Horizontal:

Frequency (MHz)	Meter Reading (dBμV)	Factor (dB)	Emission Level (dBμV/m)	Limits (dBμV/m)	Margin (dB)	Detector Type
4882.00	51.82	-3.54	48.28	74.00	-25.72	peak
4882.00	42.18	-3.54	38.64	54.00	-15.36	AVG
7323.00	53.25	-0.81	52.44	74.00	-21.56	peak
7323.00	42.24	-0.81	41.43	54.00	-12.57	AVG

Remark: Factor = Cable loss + Antenna factor + Attenuator – Preamplifier; Level = Reading + Factor; Margin = Level - Limit.

Vertical:

Frequency (MHz)	Meter Reading (dBμV)	Factor (dB)	Emission Level (dBμV/m)	Limits (dBμV/m)	Margin (dB)	Detector Type
4882.00	51.49	-3.54	47.95	74.00	-26.05	peak
4882.00	43.14	-3.54	39.60	54.00	-14.40	AVG
7323.00	52.85	-0.81	52.04	74.00	-21.96	peak
7323.00	40.58	-0.81	39.77	54.00	-14.23	AVG

Remark: Factor = Cable loss + Antenna factor + Attenuator – Preamplifier; Level = Reading + Factor; Margin = Level - Limit.





CH High (2480MHz)

Horizontal:

Frequency (MHz)	Meter Reading (dBµV)	Factor (dB)	Emission Level (dBµV/m)	Limits (dBµV/m)	Margin (dB)	Detector Type
4960.00	52.38	-3.43	48.95	74.00	-25.05	peak
4960.00	45.75	-3.43	42.32	54.00	-11.68	AVG
7440.00	51.86	-0.77	51.09	74.00	-22.91	peak
7440.00	39.40	-0.77	38.63	54.00	-15.37	AVG

Remark: Factor = Cable loss + Antenna factor + Attenuator – Pre-amplifier; Level = Reading + Factor; Margin = Level - Limit.

Vertical:

Frequency (MHz)	Meter Reading (dBµV)	Factor (dB)	Emission Level (dBµV/m)	Limits (dBµV/m)	Margin (dB)	Detector Type
4960.00	50.18	-3.43	46.75	74.00	-27.25	peak
4960.00	43.37	-3.43	39.94	54.00	-14.06	AVG
7440.00	48.45	-0.77	47.68	74.00	-26.32	peak
7440.00	41.65	-0.77	40.88	54.00	-13.12	AVG

Remark: Factor = Cable loss + Antenna factor + Attenuator – Pre-amplifier; Level = Reading + Factor; Margin = Level - Limit.

Remark :

- (1) Measuring frequencies from 1 GHz to the 25 GHz.
- (2) "F" denotes fundamental frequency; "H" denotes spurious frequency. "E" denotes band edge frequency.
- (3) \* denotes emission frequency which appearing within the Restricted Bands specified in provision of 15.205, then the general radiated emission limits in 15.209 apply.
- (4) The emissions are attenuated more than 20dB below the permissible limits are not recorded in the report.
- (5) The IF bandwidth of EMI Test Receiver between 30MHz to 1GHz was 120KHz, 1 MHz for measuring above 1 GHz, below 30MHz was 10KHz. The resolution bandwidth of test receiver/spectrum analyzer is 1MHz and video bandwidth is 3MHz for peak measurement with peak detector at frequency above 1GHz. The resolution bandwidth of test receiver/spectrum analyzer is 1MHz and video bandwidth is 10Hz for Average measurement with peak detection at frequency above 1GHz.
- (6) When the test results of Peak Detected below the limits of Average Detected, the Average Detected is not need completed. For example: Top Channel at Fundamental 73.16dBuV/m (PK Value) <93.98(AV Limit), at harmonic 53.20 dBuV/m (PK Value) <54 dBuV/m (AV Limit), the Average Detected not need to completed.
- (7) All modes of operation were investigated and the worst-case emissions are reported.



Radiated Band Edge Test:

Hopping

Horizontal (Worst case):

Frequency	Meter Reading	Factor	Emission Level	Limits	Margin	Detector Type
(MHz)	(dBμV)	(dB)	(dBμV/m)	(dBμV/m)	(dB)	
2310.00	50.72	-5.81	44.91	74	-29.09	peak
2310.00	/	-5.81	/	54	/	AVG
2390.00	53.76	-5.84	47.92	74	-26.08	peak
2390.00	/	-5.84	/	54	/	AVG

Remark: Factor = Cable loss + Antenna factor + Attenuator – Preamplifier; Level = Reading + Factor; Margin = Level - Limit.

Vertical:

Frequency	Meter Reading	Factor	Emission Level	Limits	Margin	Detector Type
(MHz)	(dBμV)	(dB)	(dBμV/m)	(dBμV/m)	(dB)	
2310.00	51.36	-5.81	45.55	74	-28.45	peak
2310.00	/	-5.81	/	54	/	AVG
2390.00	53.19	-5.84	47.35	74	-26.65	peak
2390.00	/	-5.84	/	54	/	AVG

Remark: Factor = Cable loss + Antenna factor + Attenuator – Preamplifier; Level = Reading + Factor; Margin = Level - Limit.



Horizontal (Worst case):

Frequency	Meter Reading	Factor	Emission Level	Limits	Margin	Detector Type
(MHz)	(dBμV)	(dB)	(dBμV/m)	(dBμV/m)	(dB)	
2483.50	54.59	-5.81	48.78	74	-25.22	peak
2483.50	/	-5.81	/	54	/	AVG
2500.00	53.91	-6.06	47.85	74	-26.15	peak
2500.00	/	-6.06	/	54	/	AVG

Remark: Factor = Cable loss + Antenna factor + Attenuator – Preamplifier; Level = Reading + Factor; Margin = Level - Limit.

Vertical:

Frequency	Meter Reading	Factor	Emission Level	Limits	Margin	Detector Type
(MHz)	(dBμV)	(dB)	(dBμV/m)	(dBμV/m)	(dB)	
2483.50	54.39	-5.81	48.58	74	-25.42	peak
2483.50	/	-5.81	/	54	/	AVG
2500.00	53.85	-6.06	47.79	74	-26.21	peak
2500.00	/	-6.06	/	54	/	AVG

Remark: Factor = Cable loss + Antenna factor + Attenuator – Preamplifier; Level = Reading + Factor; Margin = Level - Limit.

Remark: All the other emissions not reported were too low to read and deemed to comply with FCC limit.



NO Hopping

Operation Mode: TX CH Low (2402MHz)

Horizontal (Worst case):

Frequency	Meter Reading	Factor	Emission Level	Limits	Margin	Detector Type
(MHz)	(dBμV)	(dB)	(dBμV/m)	(dBμV/m)	(dB)	
2310.00	53.27	-5.81	47.46	74	-26.54	peak
2310.00	/	-5.81	/	54	/	AVG
2390.00	51.68	-5.84	45.84	74	-28.16	peak
2390.00	/	-5.84	/	54	/	AVG

Remark: Factor = Cable loss + Antenna factor + Attenuator – Preamplifier; Level = Reading + Factor; Margin = Level - Limit.

Vertical:

Frequency	Meter Reading	Factor	Emission Level	Limits	Margin	Detector Type
(MHz)	(dBμV)	(dB)	(dBμV/m)	(dBμV/m)	(dB)	
2310.00	53.04	-5.81	47.23	74	-26.77	peak
2310.00	/	-5.81	/	54	/	AVG
2390.00	51.95	-5.84	46.11	74	-27.89	peak
2390.00	/	-5.84	/	54	/	AVG

Remark: Factor = Cable loss + Antenna factor + Attenuator – Preamplifier; Level = Reading + Factor; Margin = Level - Limit.





Operation Mode: TX CH High (2480MHz)

Horizontal (Worst case):

Frequency	Meter Reading	Factor	Emission Level	Limits	Margin	Detector Type
(MHz)	(dBμV)	(dB)	(dBμV/m)	(dBμV/m)	(dB)	
2483.50	52.62	-5.81	46.81	74	-27.19	peak
2483.50	/	-5.81	/	54	/	AVG
2500.00	51.38	-6.06	45.32	74	-28.68	peak
2500.00	/	-6.06	/	54	/	AVG

Remark: Factor = Cable loss + Antenna factor + Attenuator – Preamplifier; Level = Reading + Factor; Margin = Level - Limit.

Vertical:

Frequency	Meter Reading	Factor	Emission Level	Limits	Margin	Detector Type
(MHz)	(dBμV)	(dB)	(dBμV/m)	(dBμV/m)	(dB)	
2483.50	51.83	-5.81	46.02	74	-27.98	peak
2483.50	/	-5.81	/	54	/	AVG
2500.00	52.78	-6.06	46.72	74	-27.28	peak
2500.00	/	-6.06	/	54	/	AVG

Remark: Factor = Cable loss + Antenna factor + Attenuator – Preamplifier; Level = Reading + Factor; Margin = Level - Limit.

Remark: All the other emissions not reported were too low to read and deemed to comply with FCC limit.

Remark:

1. If the PK measured levels comply with average limit, then the average level were deemed to comply with average limit.
2. In restricted bands of operation, the spurious emissions below the permissible value more than 20dB.
3. The amplitude of spurious emissions which are attenuated by more than 20dB below the permissible value has no need to be reported.



### 3.3. Maximum Peak Conducted Output Power

#### Limit

Frequency hopping systems shall have hopping channel carrier frequencies separated by a minimum of 25 kHz or the 20 dB bandwidth of the hopping channel, whichever is greater. Alternatively, frequency hopping systems operating in the 2400-2483.5 MHz band may have hopping channel carrier frequencies that are separated by 25 kHz or two-thirds of the 20 dB bandwidth of the hopping channel, whichever is greater, provided the systems operate with an output power no greater than 125mW. The system shall hop to channel frequencies that are selected at the system hopping rate from a pseudo randomly ordered list of hopping frequencies. Each frequency must be used equally on the average by each transmitter. The system receivers shall have input bandwidths that match the hopping channel bandwidths of their corresponding transmitters and shall shift frequencies in synchronization with the transmitted signals.

#### Test Procedure

Remove the antenna from the EUT and then connect a low loss RF cable from the antenna port to the power sensor.

#### Test Configuration

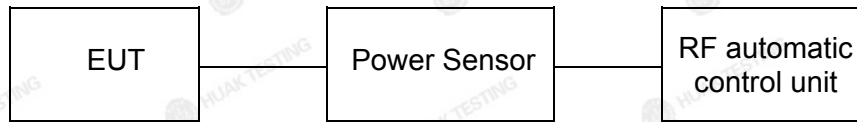

#### Test Results

Type	Channel	Maximum Peak Conducted Output Power (dBm)	Limit (dBm)	Result
GFSK	00	2.68	21.00	Pass
	39	2.11		
	78	1.51		
π/4DQPSK	00	3.12	21.00	Pass
	39	2.61		
	78	2.00		

Note: The test results including the cable loss.



### 3.4. 20dB Bandwidth

#### Limit

For frequency hopping systems operating in the 2400MHz-2483.5MHz no limit for 20dB bandwidth.

#### Test Procedure

The transmitter output was connected to the spectrum analyzer through an attenuator. The bandwidth of the fundamental frequency was measured by spectrum analyzer with 30 KHz RBW and 100 KHz VBW.

The 20dB bandwidth is defined as the total spectrum the power of which is higher than peak power minus 20dB.

The occupied bandwidth is the frequency bandwidth such that, below its lower and above its upper frequency limits, the mean powers are each equal to 0.5% of the total mean power of the given emission. The following procedure shall be used for measuring 99% power bandwidth:

- RBW=1% to 5% of the OBW
- VBW=approximately 3 X RBW
- Detector=Peak
- Trace Mode: Max Hold

Use the 99% power bandwidth function of the instrument to measure the Occupied Bandwidth and recorded.

#### Test Configuration



#### Test Results

Modulation	Channel	20dB Bandwidth (MHz)	Result
GFSK	CH00	0.960	Pass
	CH39	0.960	
	CH78	0.951	
π/4DQPSK	CH00	1.323	
	CH39	1.383	
	CH78	1.323	

The results shown in this test report refer only to the sample(s) tested unless otherwise stated and the sample(s) are retained for 30 days only. The document is issued by HUAKE, this document cannot be reproduced except in full with our prior written permission. The more details and the authenticity of the report will be confirmed at <http://www.cer-mark.com>.



Test plot as follows:  
20dB Bandwidth

### GFSK Modulation



### CH00

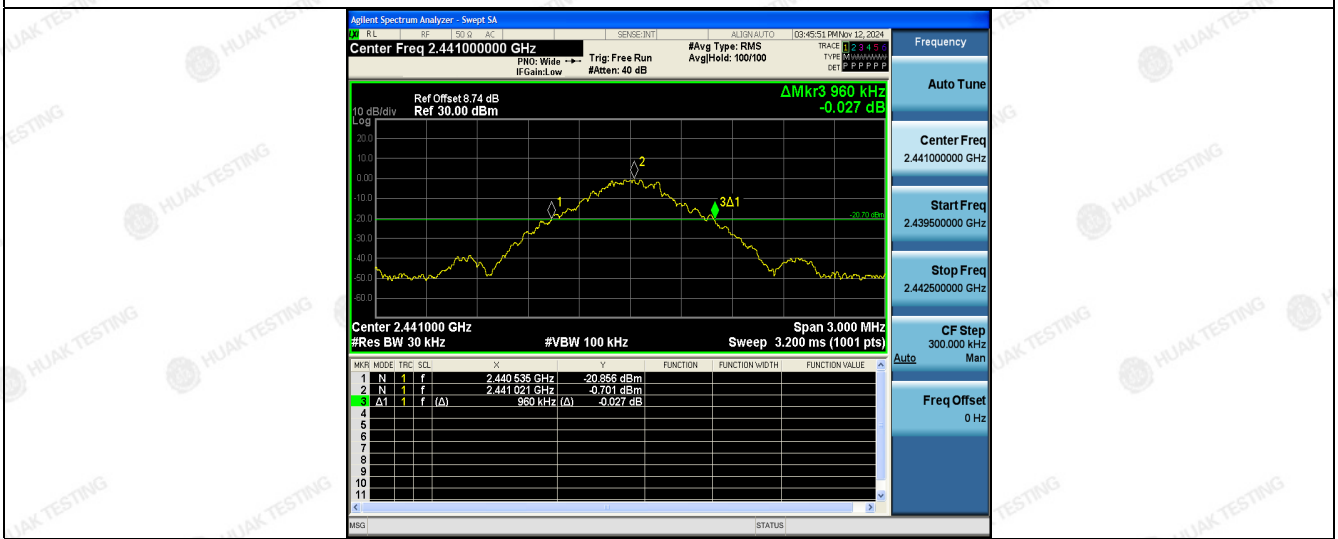

### CH39



### CH78

The results shown in this test report refer only to the sample(s) tested unless otherwise stated and the sample(s) are retained for 30 days only. The document is issued by HUAJ, this document cannot be reproduced except in full with our prior written permission. The more details and the authenticity of the report will be confirmed at <http://www.cer-mark.com>.

TEL : +86-755 2302 9901 FAX : +86-755 2302 9901 E-mail : service@cer-mark.com

Add: 1-2F., Building B2, Junfeng Zhongcheng Zhizao Innovation Park, Heping Community, Fuhai Street, Bao'an District, Shenzhen, Guangdong, China





$\pi/4$ DQPSK Modulation

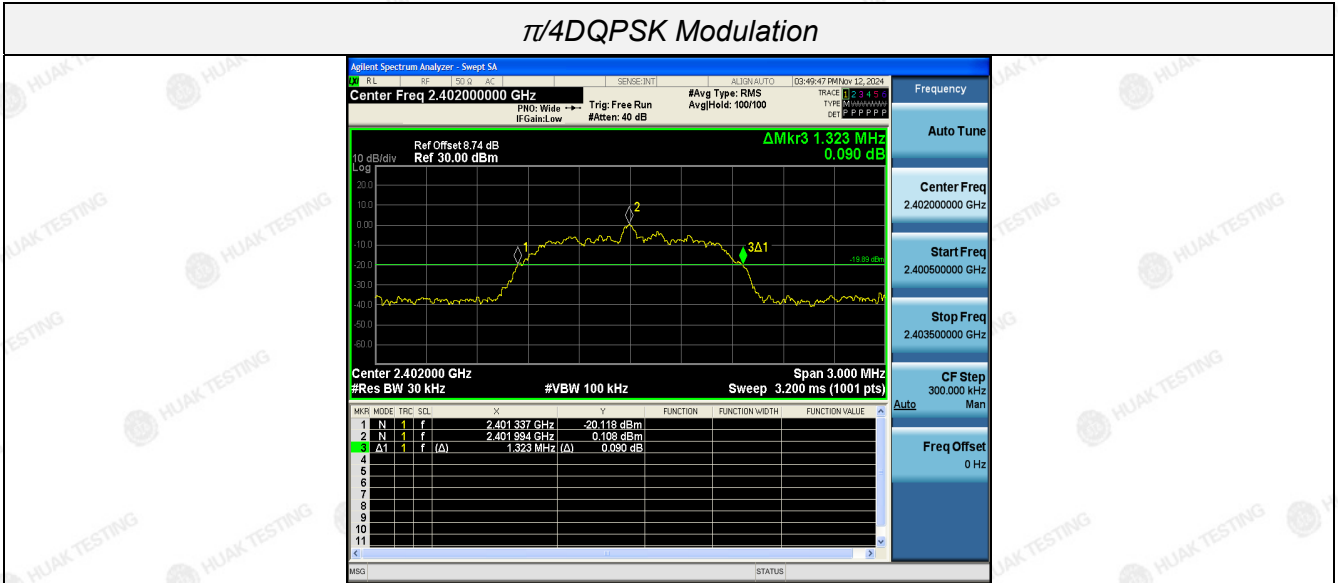

CH00

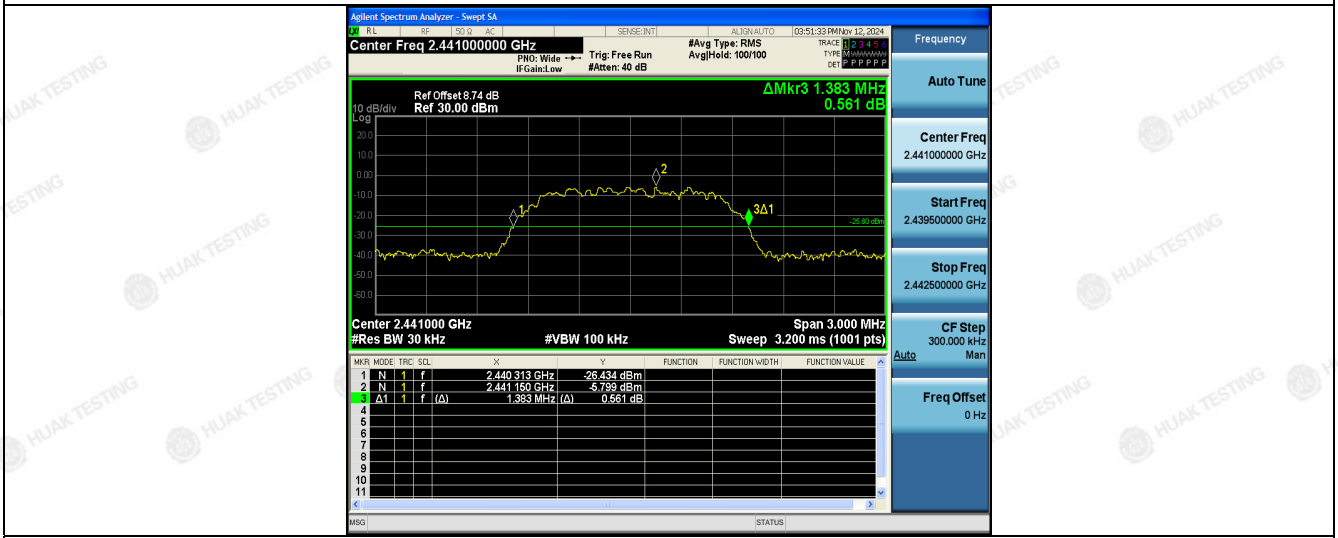

CH39



CH78

The results shown in this test report refer only to the sample(s) tested unless otherwise stated and the sample(s) are retained for 30 days only. The document is issued by HUAJ, this document cannot be reproduced except in full with our prior written permission. The more details and the authenticity of the report will be confirmed at <http://www.cer-mark.com>.

TEL : +86-755 2302 9901 FAX : +86-755 2302 9901 E-mail : service@cer-mark.com

Add: 1-2F., Building B2, Junfeng Zhongcheng Zhizao Innovation Park, Heping Community, Fuhai Street, Bao'an District, Shenzhen, Guangdong, China



### 3.5. Frequency Separation

#### Limit

Frequency hopping systems shall have hopping channel carrier frequencies separated by minimum of 25 KHz or the  $2/3 \times 20\text{dB}$  bandwidth of the hopping channel, whichever is greater.

#### Test Procedure

The transmitter output was connected to the spectrum analyzer through an attenuator. The bandwidth of the fundamental frequency was measured by spectrum analyzer with 30 KHz RBW and 100 KHz VBW.

#### Test Configuration



#### Test Results

Modulation	Channel	Channel Separation (MHz)	Limit(MHz)	Result
GFSK	CH39	1.000	0.640	Pass
	CH40			
$\pi/4$ DQPSK	CH39	1.000	0.922	Pass
	CH40			

Note: We have tested all mode at high, middle and low channel, and recorded worst case at middle

#### Test plot as follows:



### Frequency Separation

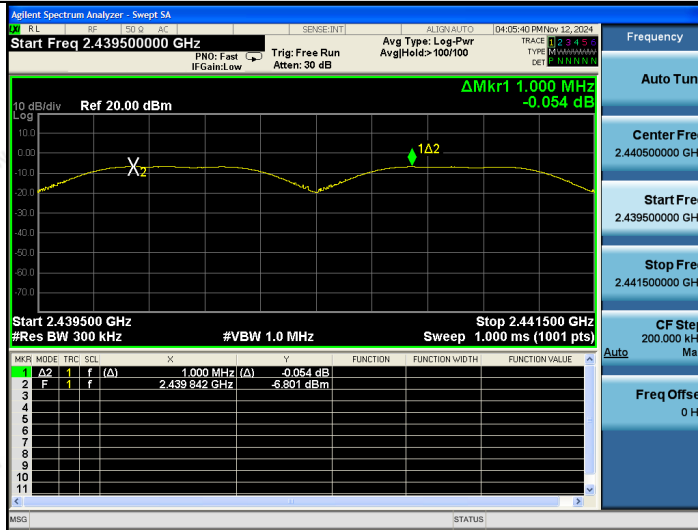

### GFSK

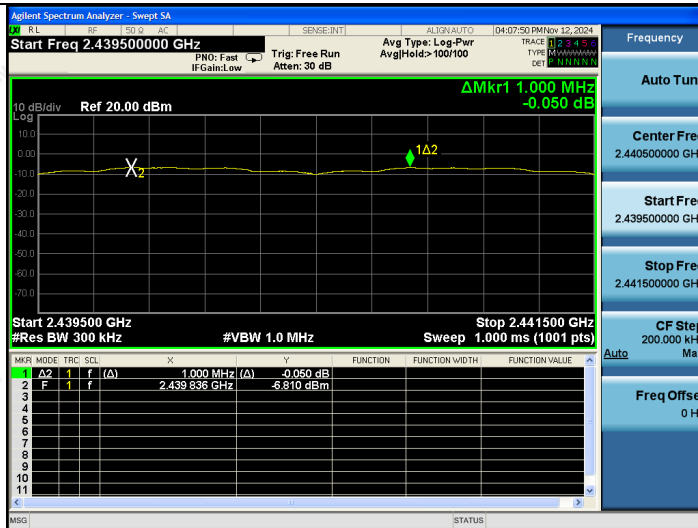

### π/4DQPSK

The results shown in this test report refer only to the sample(s) tested unless otherwise stated and the sample(s) are retained for 30 days only. The document is issued by HUAKE, this document cannot be reproduced except in full with our prior written permission. The more details and the authenticity of the report will be confirmed at <http://www.cer-mark.com>.

TEL : +86-755 2302 9901 FAX : +86-755 2302 9901 E-mail : service@cer-mark.com

Add: 1-2F., Building B2, Junfeng Zhongcheng Zhizao Innovation Park, Heping Community, Fuhai Street, Bao'an District, Shenzhen, Guangdong, China



### 3.6. Number of Hopping Frequency

#### Limit

Frequency hopping systems in the 2400–2483.5 MHz band shall use at least 15 channels.

#### Test Procedure

The transmitter output was connected to the spectrum analyzer through an attenuator. Set spectrum analyzer start 2400MHz to 2483.5MHz.

#### Test Configuration



#### Test Results

Modulation	Number of Hopping Channel	Limit	Result
GFSK	79	≥15	Pass
π/4DQPSK	79		

Test plot as follows:





### GFSK Modulation

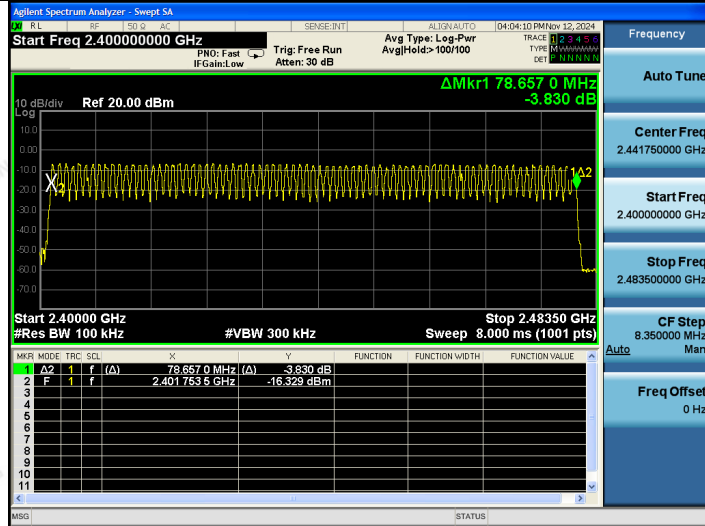

### $\pi/4$ QPSK Modulation

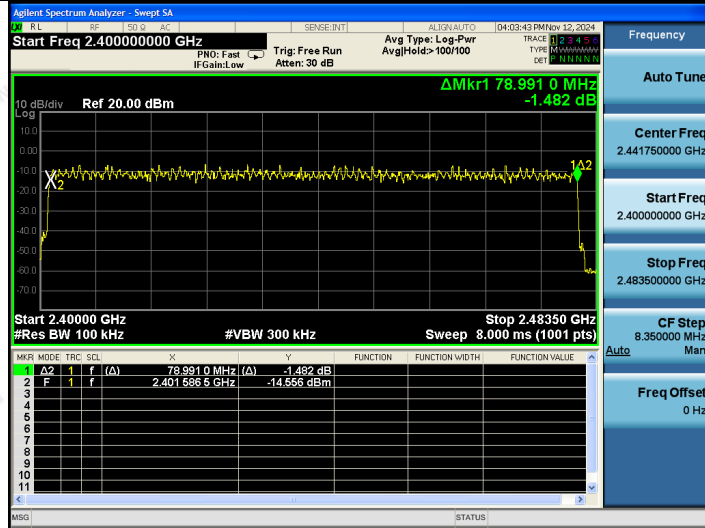

The results shown in this test report refer only to the sample(s) tested unless otherwise stated and the sample(s) are retained for 30 days only. The document is issued by HUAJ, this document cannot be reproduced except in full with our prior written permission. The more details and the authenticity of the report will be confirmed at <http://www.cer-mark.com>.

TEL : +86-755 2302 9901 FAX : +86-755 2302 9901 E-mail : service@cer-mark.com

Add: 1-2F., Building B2, Junfeng Zhongcheng Zhizao Innovation Park, Heping Community, Fuhai Street, Bao'an District, Shenzhen, Guangdong, China



### 3.7. Time of Occupancy (Dwell Time)

#### Limit

The average time of occupancy on any channel shall not be greater than 0.4 seconds within a period of 0.4 seconds multiplied by the number of hopping channels employed.

#### Test Procedure

The transmitter output was connected to the spectrum analyzer through an attenuator. Set center frequency of spectrum analyzer=operating frequency with 1MHz RBW and 3MHz VBW, Span 0Hz.

#### Test Configuration



#### Test Results

Modulation	Packet	Pulse time (ms)	Dwell time (second)	Limit (second)	Result
GFSK	DH1	0.380	0.122	0.40	Pass
	DH3	1.638	0.262		
	DH5	2.885	0.308		
π/4DQPSK	2-DH1	0.391	0.125	0.40	Pass
	2-DH3	1.643	0.263		
	2-DH5	2.892	0.308		

Note:

- We have tested all mode at high,middle and low channel,and recoreded worst case at middle channel.
- Dwell time=Pulse time (ms) × (1600 ÷ 2 ÷ 79) ×31.6 Second for DH1, 2-DH1  
 Dwell time=Pulse time (ms) × (1600 ÷ 4 ÷ 79) ×31.6 Second for DH3, 2-DH3  
 Dwell time=Pulse time (ms) × (1600 ÷ 6 ÷ 79) ×31.6 Second for DH5, 2-DH5

Test plot as follows:





$\pi$ /4DQPSK Modulation

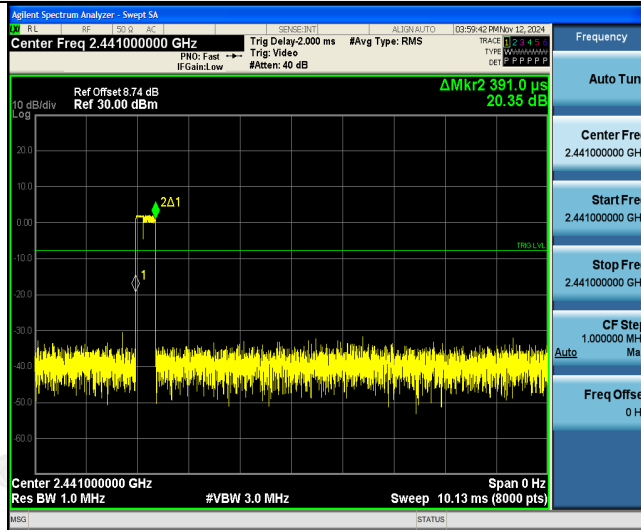

2-DH1

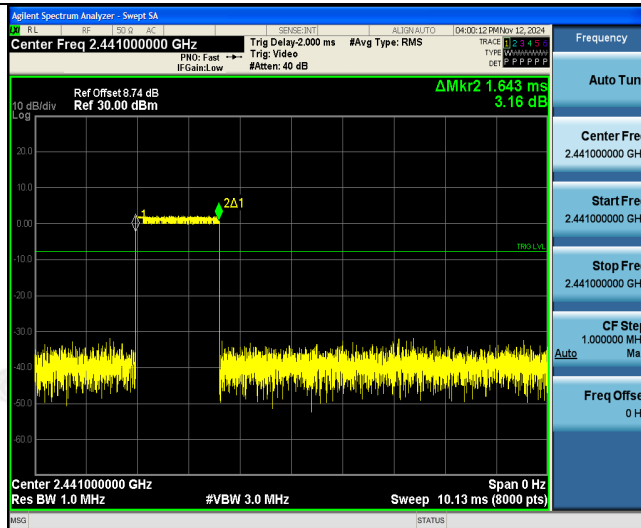

2-DH3

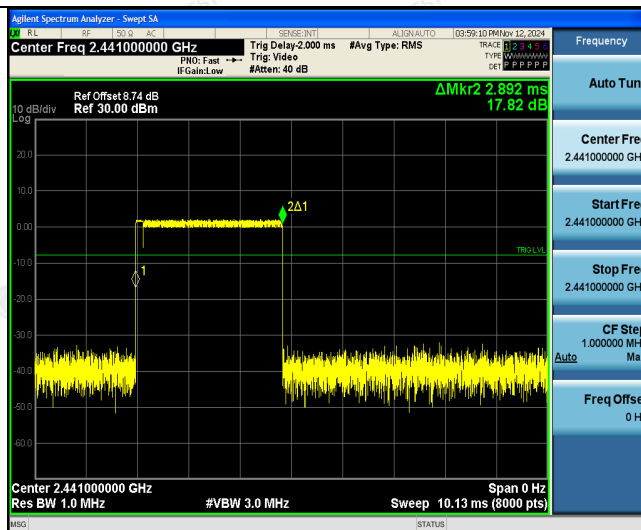

2-DH5

The results shown in this test report refer only to the sample(s) tested unless otherwise stated and the sample(s) are retained for 30 days only. The document is issued by HUAKE, this document cannot be reproduced except in full with our prior written permission. The more details and the authenticity of the report will be confirmed at <http://www.cer-mark.com>.

TEL : +86-755 2302 9901    FAX : +86-755 2302 9901    E-mail : [service@cer-mark.com](mailto:service@cer-mark.com)

Add: 1-2F., Building B2, Junfeng Zhongcheng Zhizao Innovation Park, Heping Community, Fuhai Street, Bao'an District, Shenzhen, Guangdong, China





### 3.8. Out-of-Band Emissions

#### Limit

In any 100 kHz bandwidth outside the frequency band in which the spread spectrum or digitally modulated intentional radiator is operating, the radio frequency power that is produced by the intentional radiator shall be at least 20 dB below that in the 100 kHz bandwidth within the band that contains the highest level of the desired power, based on either an RF conducted or a radiated measurement, provided the transmitter demonstrates compliance with the peak conducted power limits. If the transmitter complies with the conducted power limits based on the use of RMS averaging over a time interval, as permitted under paragraph (b)(3) of this section, the attenuation required under this paragraph shall be 30 dB instead of 20 dB. Attenuation below the general limits specified in §15.209(a) is not required.

In any 100 kHz bandwidth outside the frequency band in which the spread spectrum or digitally modulated device is operating, the RF power that is produced shall be at least 20 dB below that in the 100 kHz bandwidth within the band that contains the highest level of the desired power, based on either an RF conducted or a radiated measurement, provided that the transmitter demonstrates compliance with the peak conducted power limits. If the transmitter complies with the conducted power limits based on the use of root-mean-square averaging over a time interval, as permitted under Section 5.4(4), the attenuation required shall be 30 dB instead of 20 dB. Attenuation below the general field strength limits specified in RSS-Gen is not required.

#### Test Procedure

Connect the transmitter output to spectrum analyzer using a low loss RF cable, and set the spectrum analyzer to RBW=100 kHz, VBW= 300 kHz, peak detector , and max hold. Measurements utilizing these setting are made of the in-band reference level, band edge and out-of-band emissions.

#### Test Configuration



#### Test Results

Remark: The measurement frequency range is from 30MHz to the 10th harmonic of the fundamental frequency. The lowest, middle and highest channels are tested to verify the spurious emissions and bandage measurement data.

We measured all conditions (DH1, DH3, DH5) and recorded worst case at DH5 and 2DH5

Test plot as follows:



GFSK

CH00

CH39

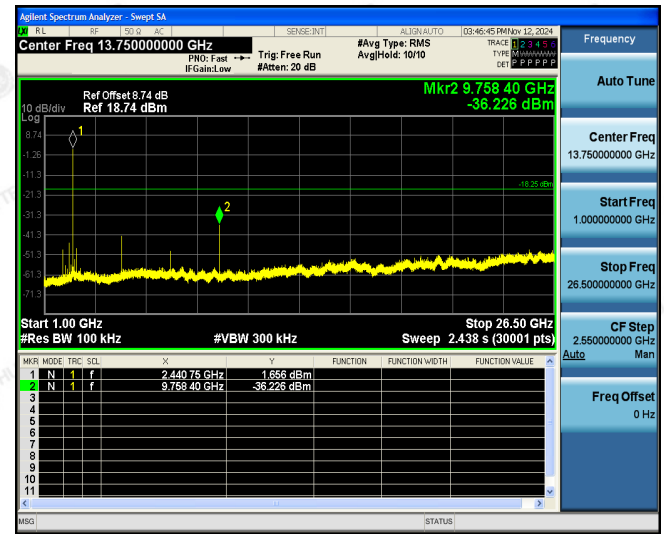
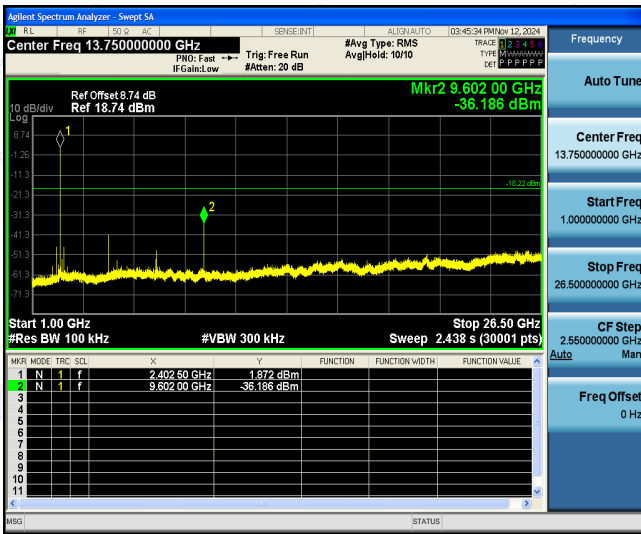
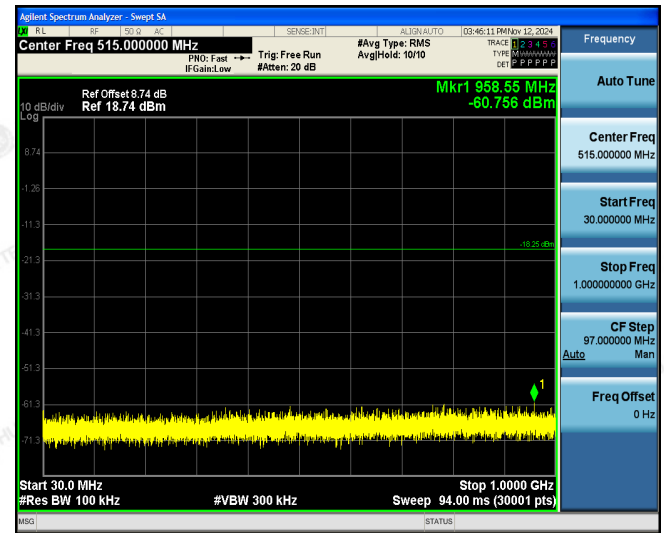
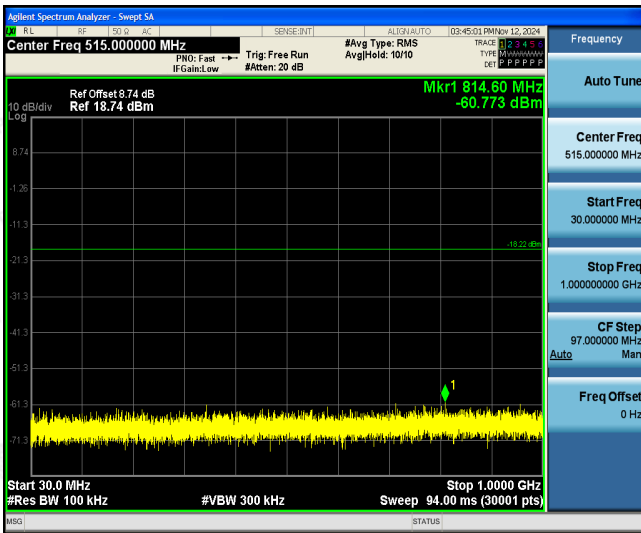

The results shown in this test report refer only to the sample(s) tested unless otherwise stated and the sample(s) are retained for 30 days only. This document is issued by HUAJ, this document cannot be reproduced except in full with our prior written permission. The more details and the authenticity of the report will be confirmed at <http://www.cer-mark.com>.

TEL : +86-755 2302 9901 FAX : +86-755 2302 9901 E-mail : service@cer-mark.com

Add: 1-2F., Building B2, Junfeng Zhongcheng Zhizao Innovation Park, Heping Community, Fuhai Street, Bao'an District, Shenzhen, Guangdong, China



CH78

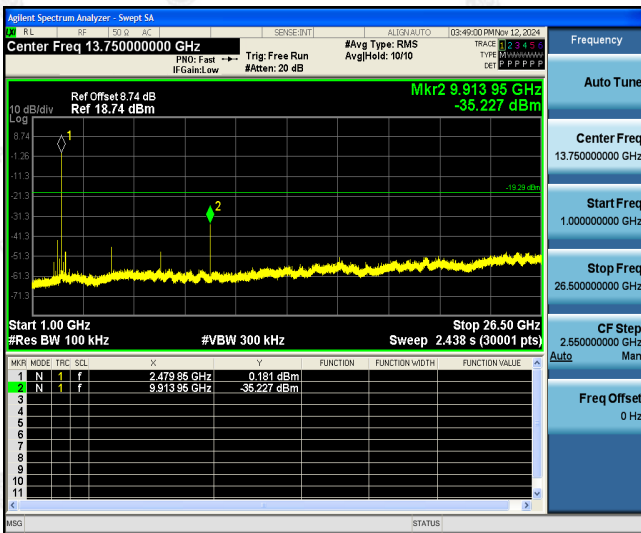
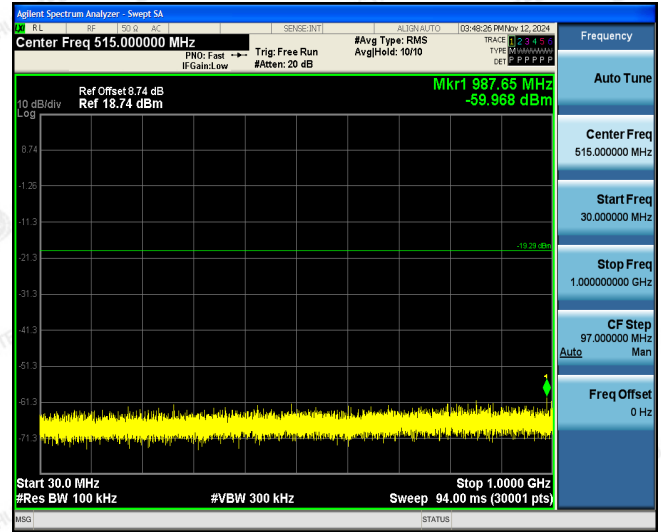

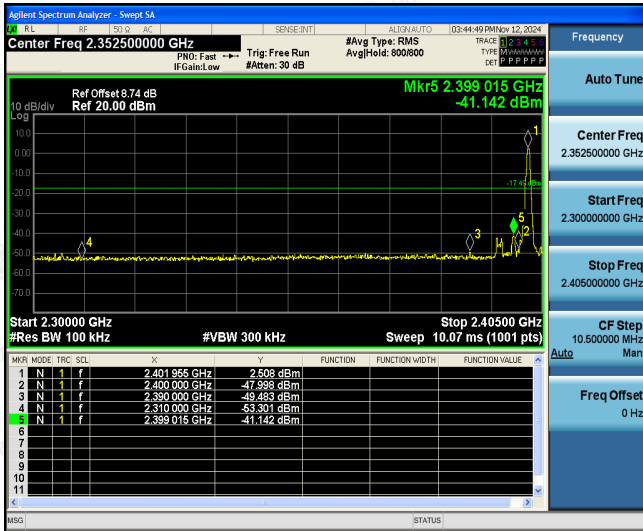

Left Band edge hopping off

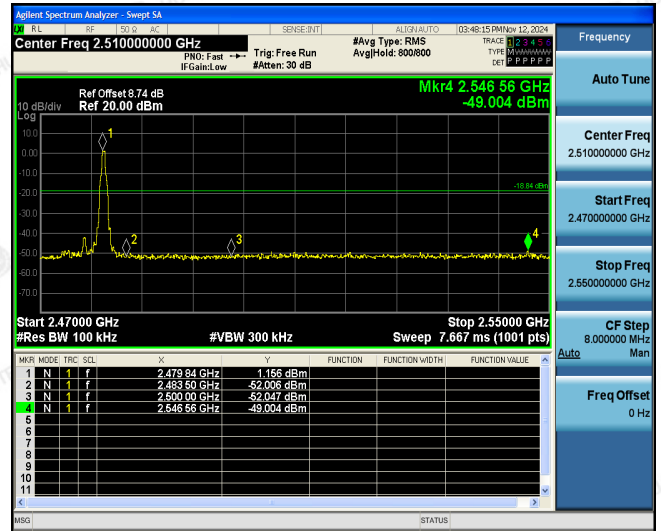

Right Band edge hopping off

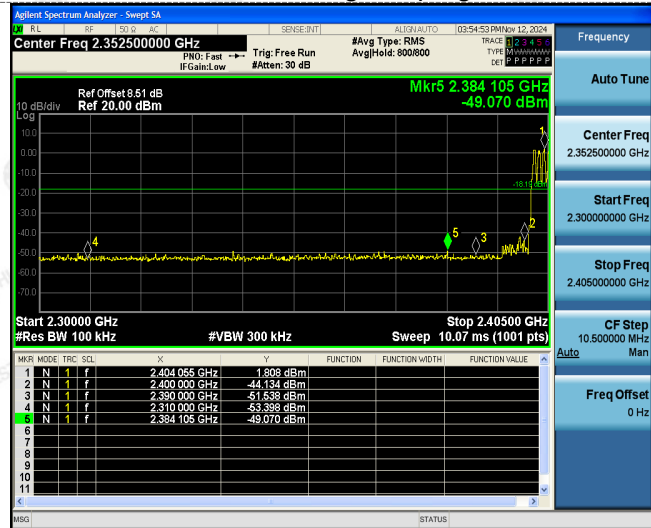

Left Band edge hopping on

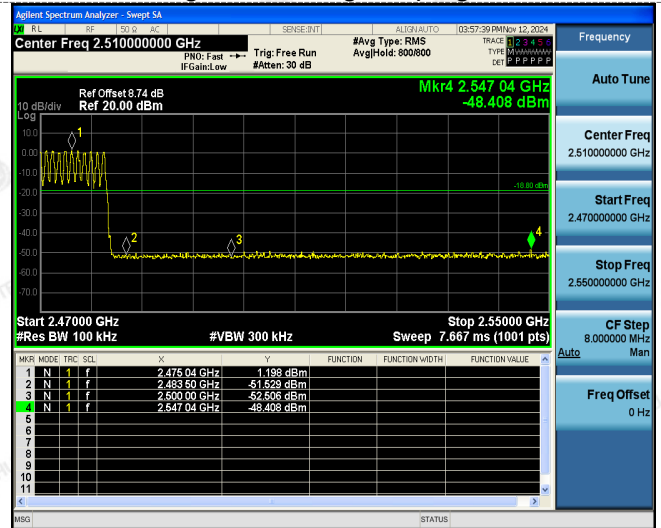

Right Band edge hopping on

The results shown in this test report refer only to the sample(s) tested unless otherwise stated and the sample(s) are retained for 30 days only. The document is issued by HUAJ, this document cannot be reproduced except in full with our prior written permission. The more details and the authenticity of the report will be confirmed at <http://www.cer-mark.com>.

TEL : +86-755 2302 9901 FAX : +86-755 2302 9901 E-mail : service@cer-mark.com

Add: 1-2F., Building B2, Junfeng Zhongcheng Zhizao Innovation Park, Heping Community, Fuhai Street, Bao'an District, Shenzhen, Guangdong, China





$\pi/4$ DQPSK

CH00

CH39

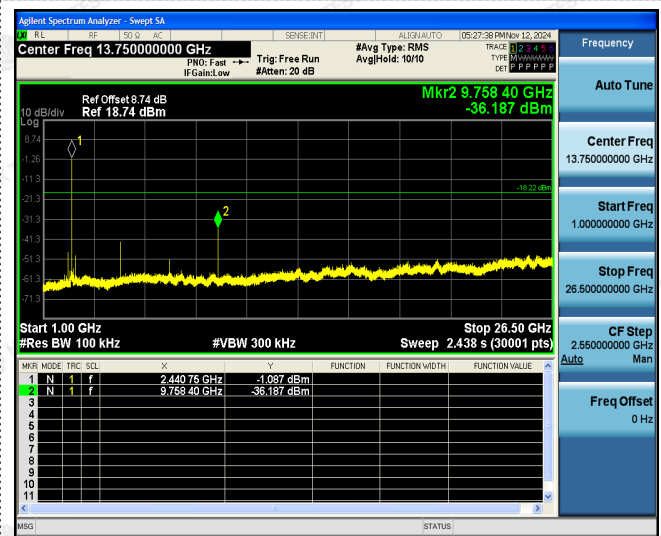
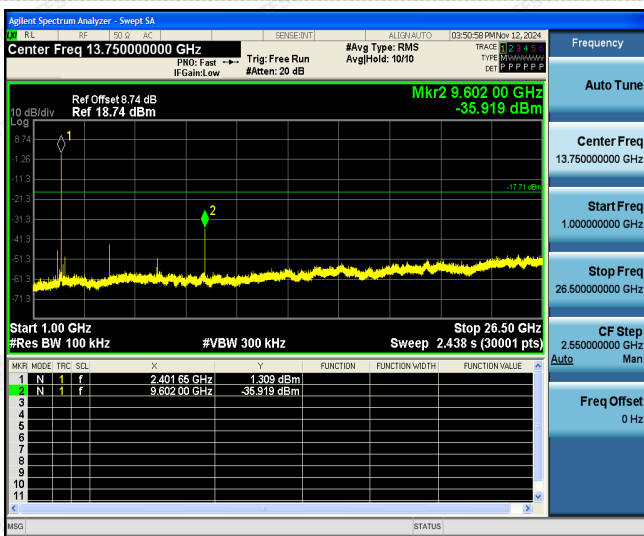
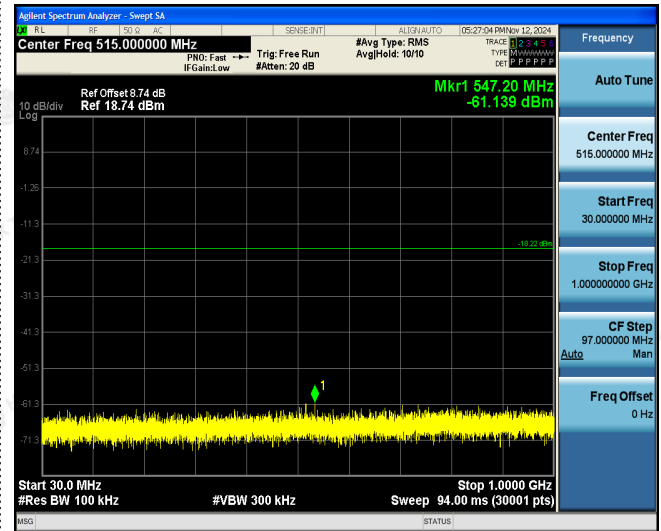
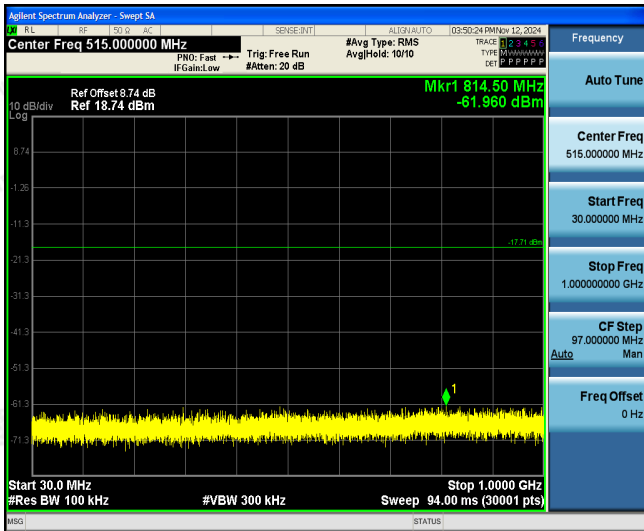
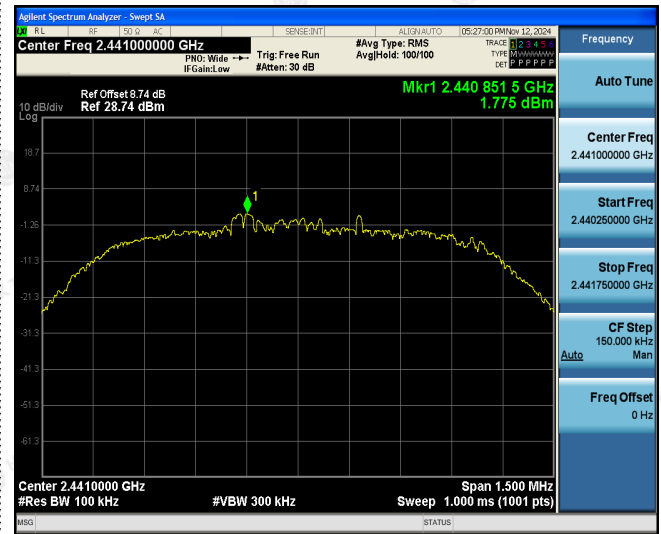

The results shown in this test report refer only to the sample(s) tested unless otherwise stated and the sample(s) are retained for 30 days only. The document is issued by HUAK, this document cannot be reproduced except in full with our prior written permission. The more details and the authenticity of the report will be confirmed at <http://www.cer-mark.com>.

TEL : +86-755 2302 9901 FAX : +86-755 2302 9901 E-mail : service@cer-mark.com

Add: 1-2F., Building B2, Junfeng Zhongcheng Zhizao Innovation Park, Heping Community, Fuhai Street, Bao'an District, Shenzhen, Guangdong, China



CH78

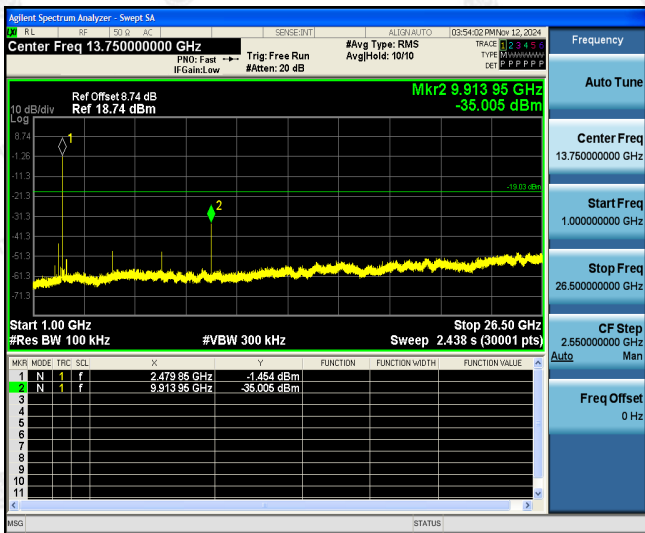
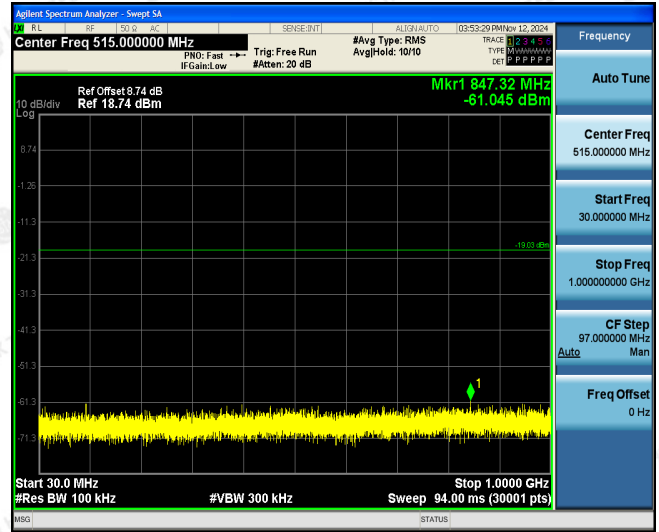

The results shown in this test report refer only to the sample(s) tested unless otherwise stated and the sample(s) are retained for 30 days only. The document is issued by HUAKE, this document cannot be reproduced except in full with our prior written permission. The more details and the authenticity of the report will be confirmed at <http://www.cer-mark.com>.

TEL : +86-755 2302 9901 FAX : +86-755 2302 9901 E-mail : service@cer-mark.com

Add: 1-2F., Building B2, Junfeng Zhongcheng Zhizao Innovation Park, Heping Community, Fuhai Street, Bao'an District, Shenzhen, Guangdong, China

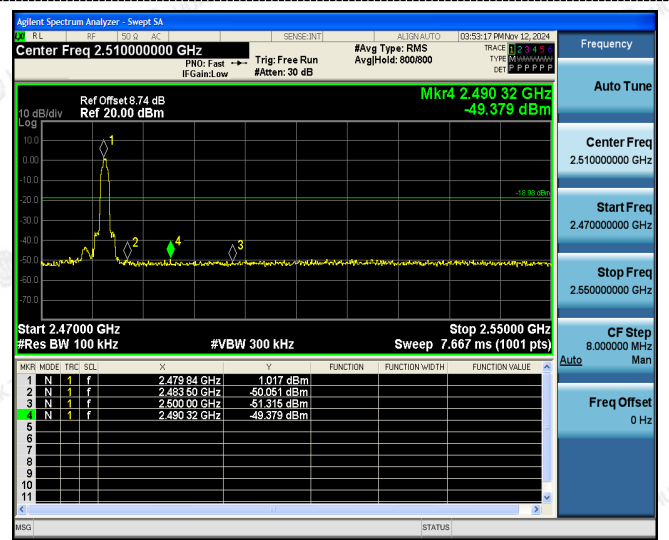
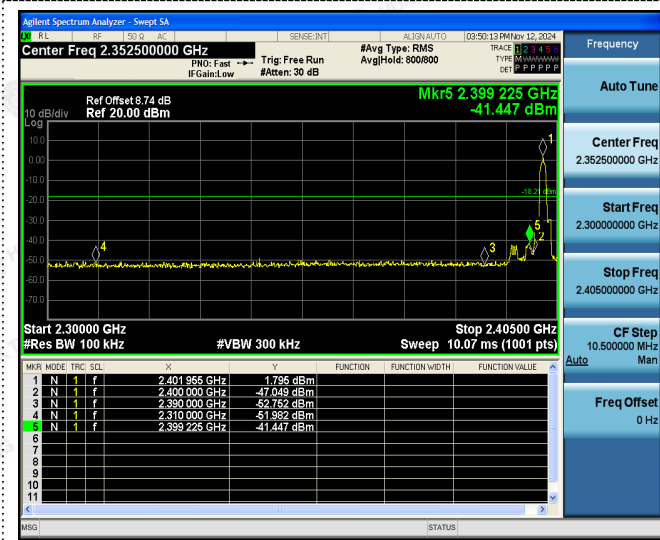

Left Band edge hopping off

Right Band edge hopping off

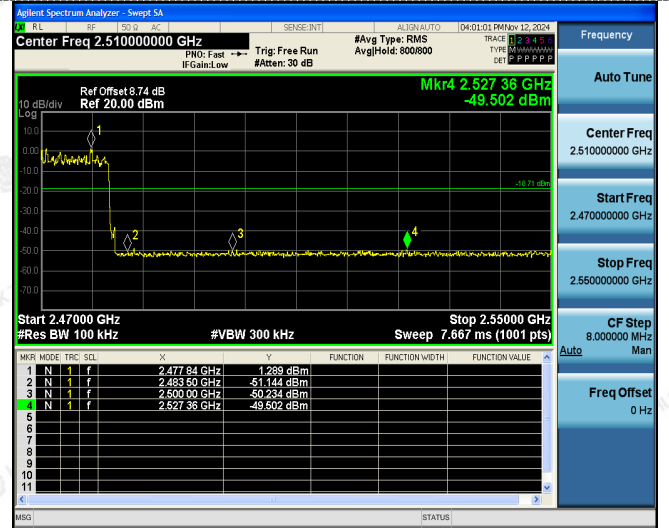
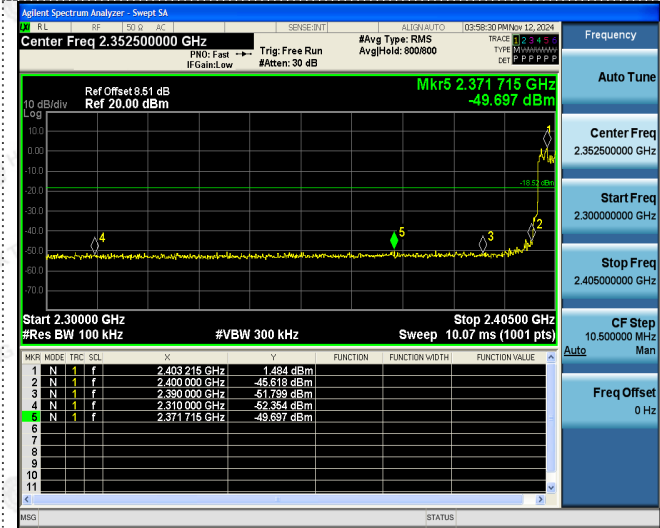

Left Band edge hopping on

Right Band edge hopping on

The results shown in this test report refer only to the sample(s) tested unless otherwise stated and the sample(s) are retained for 30 days only. This document is issued by HUAJAK, this document cannot be reproduced except in full with our prior written permission. The more details and the authenticity of the report will be confirmed at <http://www.cer-mark.com>.

TEL : +86-755 2302 9901 FAX : +86-755 2302 9901 E-mail : service@cer-mark.com

Add: 1-2F., Building B2, Junfeng Zhongcheng Zhizao Innovation Park, Heping Community, Fuhai Street, Bao'an District, Shenzhen, Guangdong, China

### 3.9. Pseudorandom Frequency Hopping Sequence

#### Test Applicable

##### **For 47 CFR Part 15C section 15.247 (a) (1):**

Frequency hopping systems shall have hopping channel carrier frequencies separated by a minimum of 25 kHz or the 20 dB bandwidth of the hop-ping channel, whichever is greater. Alternatively, frequency hopping systems operating in the 2400–2483.5 MHz band may have hopping channel carrier frequencies that are separated by 25 kHz or two-thirds of the 20 dB bandwidth of the hopping channel, whichever is greater, provided the systems operate with an output power no greater than 125 mW. The system shall hop to channel frequencies that are selected at the system hopping rate from a pseudo randomly ordered list of hopping frequencies. Each frequency must be used equally on the average by each transmitter. The system receivers shall have input bandwidths that match the hop-ping channel bandwidths of their corresponding transmitters and shall shift frequencies in synchronization with the transmitted signals.

#### EUT Pseudorandom Frequency Hopping Sequence Requirement

The pseudorandom frequency hopping sequence may be generated in a nine-stage shift register whose 5<sup>th</sup> and 9<sup>th</sup> stage outputs are added in a modulo-two addition stage. And the result is fed back to the input of the first stage. The sequence begins with the first one of 9 consecutive ones, for example: the shift register is initialized with nine ones.

- Number of shift register stages:9
- Length of pseudo-random sequence:29-1=511 bits
- Longest sequence of zeros:8(non-inverted signal)

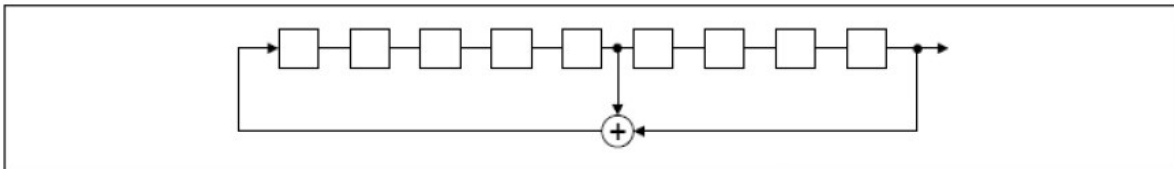

*Linear Feedback Shift Register for Generation of the PRBS sequence*

An example of pseudorandom frequency hopping sequence as follows:

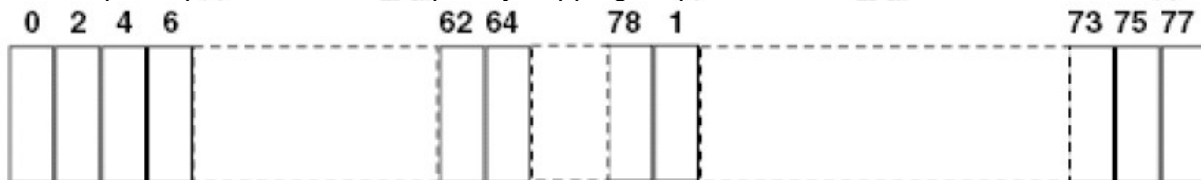

Each frequency used equally one the average by each transmitter.

The system receiver have input bandwidths that match the hopping channel bandwidths of their corresponding transmitter and shift frequencies in synchronization with the transmitted signals.



### 3.10. Antenna Requirement

#### Standard Applicable

For intentional device, according to FCC 47 CFR Section 15.203, an intentional radiator shall be designed to ensure that no antenna other than that furnished by the responsible party shall be used with the device. And according to FCC 47 CFR Section 15.247, if transmitting antennas of directional gain greater than 6dBi are used, the power shall be reduced by the amount in dB that the directional gain of the antenna exceeds 6dBi.

#### Refer to Statement below for Compliance

The manufacturer may design the unit so that the user can replace a broken antenna, but the use of a standard antenna jack or electrical connector is prohibited. Further, this requirement does not apply to intentional radiators that must be professionally installed.

#### Antenna Connected Construction

The antenna used in this product is a PCB Antenna, is a permanently attached antenna on the PCB. It conforms to the standard requirements. The directional gains of antenna used for transmitting is 1.9dBi.

#### Antenna

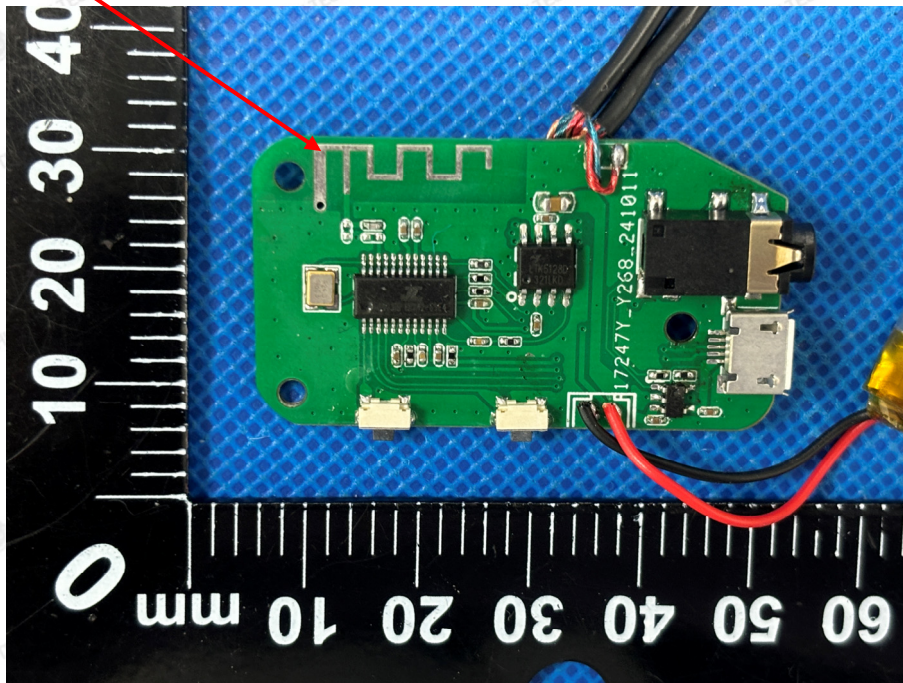



## 4. Test Setup Photos of the EUT

### Radiated Emission

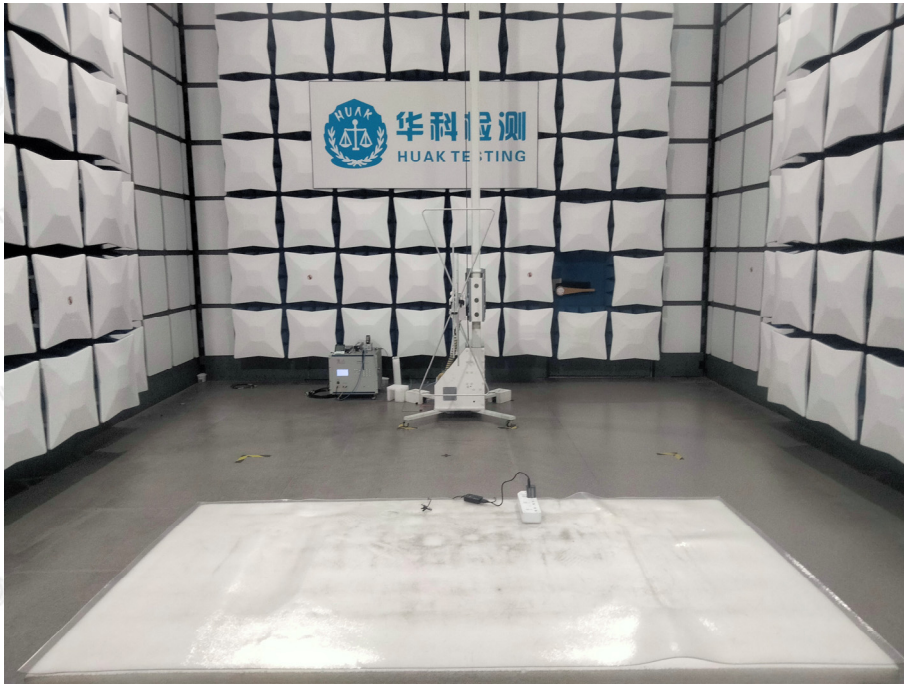

The results shown in this test report refer only to the sample(s) tested unless otherwise stated and the sample(s) are retained for 30 days only. The document is issued by HUAK, this document cannot be reproduced except in full with our prior written permission. The more details and the authenticity of the report will be confirmed at <http://www.cer-mark.com>.

TEL : +86-755 2302 9901 FAX : +86-755 2302 9901 E-mail : [service@cer-mark.com](mailto:service@cer-mark.com)

Addr: 1-2F., Building B2, Junfeng Zhongcheng Zhizao Innovation Park, Heping Community, Fuhai Street, Bao'an District, Shenzhen, Guangdong, China





**Conducted Emission**



The results shown in this test report refer only to the sample(s) tested unless otherwise stated and the sample(s) are retained for 30 days only. The document is issued by HUAK, this document cannot be reproduced except in full with our prior written permission. The more details and the authenticity of the report will be confirmed at <http://www.cer-mark.com>.

TEL : +86-755 2302 9901 FAX : +86-755 2302 9901 E-mail : [service@cer-mark.com](mailto:service@cer-mark.com)

Addr: 1-2F., Building B2, Junfeng Zhongcheng Zhizao Innovation Park, Heping Community, Fuhai Street, Bao'an District, Shenzhen, Guangdong, China



## 5. Photos of the EUT

Reference to the report: ANNEX A of external photos and ANNEX B of internal photos

-----End of test report-----