

TEST REPORT

Report No.	CISRR241105029
Project No.	CISR241105029
FCC ID	2BL5P-TG-415
Applicant	Dongguan Changxian Electronics Co., Ltd
Address	91 Shipai Puxin 1st Road, Shipai Town, Dongguan City, Guangdong Province, China
Manufacturer	Dongguan Changxian Electronics Co., Ltd
Address	91 Shipai Puxin 1st Road, Shipai Town, Dongguan City, Guangdong Province, China
Product Name	Bluetooth Speaker
Trade Mark	N/A
Model/Type reference	TG-415
Listed Model(s)	N/A
Standard	47 CFR Part 15.247
Test date	November 5, 2024 to November 11, 2024
Issue date	November 13, 2024
Test result	Complied

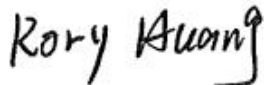

Prepared by: Rory Huang



Approved by: Genry Long

The test results relate only to the tested samples.

The test report should not be reproduced except in full without the written approval of Shenzhen Bangce Testing Technology Co., Ltd.

Contents

1. REPORT VERSION	3
2. TEST DESCRIPTION	4
3. SUMMARY	5
3.1. Product Description *	5
3.2. Radio Specification Description *	5
3.3. Modification of EUT	6
3.4. Deviation from standards	6
3.5. Testing Site	6
4. TEST CONFIGURATION	7
4.1. Test frequency list	7
4.2. Descriptions of test mode	7
4.3. Support unit used in test configuration	7
4.4. Test sample information	7
4.5. Environmental conditions	7
4.6. Equipment Used during the Test	8
5. TEST RESULTS	10
5.1. Evaluation Results (Evaluation)	10
5.1.1. Antenna Requirement	10
5.2. Radio Spectrum Matter Test Results (RF)	11
5.2.1. Conducted Emission at AC power line	11
5.2.2. 20dB Bandwidth	15
5.2.3. Maximum Conducted Output Power	17
5.2.4. Channel Separation	18
5.2.5. Number of Hopping Frequencies	19
5.2.6. Dwell Time	20
5.2.7. Conducted band edge and spurious emission	22
5.2.8. Radiated band edge emission	24
5.2.9. Radiated Spurious Emission	30
6. TEST SETUP PHOTOS	40
7. EXTERNAL AND INTERNAL PHOTOS	42
7.1. External Photos	42
7.2. Internal Photos	46

1. REPORT VERSION

Version No.	Issue date	Description
00	November 13, 2024	Original

2. TEST DESCRIPTION

No.	Test Item	Standard Requirement	Result
1	Antenna Requirement	47 CFR 15.203	Pass
2	Conducted Emission at AC power line	47 CFR 15.207(a)	Pass
3	20dB Bandwidth	47 CFR 15.247(a)(1)	Pass
4	Maximum Conducted Output Power	47 CFR 15.247(b)(1)	Pass
5	Channel Separation	47 CFR 15.247(a)(1)	Pass
6	Number of Hopping Frequencies	47 CFR 15.247(a)(1)(iii)	Pass
7	Dwell Time	47 CFR 15.247(a)(1)(iii)	Pass
8	Conducted band edge and spurious emission	47 CFR 15.247(d), 15.209, 15.205	Pass
9	Radiated band edge emission	47 CFR 15.247(d), 15.209, 15.205	Pass
10	Radiated Spurious Emission	47 CFR 15.247(d), 15.209, 15.205	Pass

Note:

- The measurement uncertainty is not included in the test result.

3. SUMMARY

3.1. Product Description *

Main unit information:	
Product Name:	Bluetooth Speaker
Trade Mark:	N/A
Model No.:	TG-415
Listed Model(s):	N/A
Power supply:	DC 5V
Hardware version:	V1.0
Software version:	V1.0
Accessory unit (AU) information:	
Battery	DC 3.7V

3.2. Radio Specification Description *

Modulation type:	GFSK, $\pi/4$ DQPSK, 8DPSK
Operation frequency:	2402MHz to 2480MHz
Channel number:	79
Channel separation:	1MHz
Antenna type:	PCB
Antenna gain:	-0.58 dBi

Note:

- 1) *: Since the above information is provided by the applicant relevant results or conclusions of this report are only made for these information, Bangce is not responsible for the authenticity, integrity and results of the information and/or the validity of the conclusion.
- 2) Operation frequency list as follow:

Channel	Frequency (MHz)	Channel	Frequency (MHz)	Channel	Frequency (MHz)	Channel	Frequency (MHz)
0	2402	20	2422	40	2442	60	2462
1	2403	21	2423	41	2443	61	2463
2	2404	22	2424	42	2444	62	2464
3	2405	23	2425	43	2445	63	2465
4	2406	24	2426	44	2446	64	2466
5	2407	25	2427	45	2447	65	2467
6	2408	26	2428	46	2448	66	2468
7	2409	27	2429	47	2449	67	2469

8	2410	28	2430	48	2450	68	2470
9	2411	29	2431	49	2451	69	2471
10	2412	30	2432	50	2452	70	2472
11	2413	31	2433	51	2453	71	2473
12	2414	32	2434	52	2454	72	2474
13	2415	33	2435	53	2455	73	2475
14	2416	34	2436	54	2456	74	2476
15	2417	35	2437	55	2457	75	2477
16	2418	36	2438	56	2458	76	2478
17	2419	37	2439	57	2459	77	2479
18	2420	38	2440	58	2460	78	2480
19	2421	39	2441	59	2461	-	-

3.3. Modification of EUT

No modifications are made to the EUT during all test items.

3.4. Deviation from standards

None

3.5. Testing Site

Laboratory Name	Shenzhen Bangce Testing Technology Co., Ltd.
Laboratory Location	101, building 10, Yunli Intelligent Park, Shutianpu community, Matian Street, Guangming District, Shenzhen, Guangdong, China
Contact information	Tel: 86-755-2319 6848, email: service@cis-cn.net Website: http://www.cis-cn.net/
FCC registration number	736346
FCC designation number	CN1372

4. TEST CONFIGURATION

4.1. Test frequency list

Bandwidth (MHz)	Lowest Channel (LCH) (MHz)	Middle Channel (MCH) (MHz)	Highest Channel (HCH) (MHz)
1	2402	2441	2480

4.2. Descriptions of test mode

No	Test mode	Description
TM1	TX-GFSK (Non-Hopping)	Keep the EUT in continuously transmitting mode (non-hopping) with GFSK modulation at lowest, middle and highest channel.
TM2	TX-Pi/4DQPSK (Non-Hopping)	Keep the EUT in continuously transmitting mode (non-hopping) with Pi/4DQPSK modulation at lowest, middle and highest channel.
TM3	TX-8DPSK (Non-Hopping)	Keep the EUT in continuously transmitting mode (non-hopping) with 8DPSK modulation at lowest, middle and highest channel.
TM4	TX-GFSK (Hopping)	Keep the EUT in continuously transmitting mode (hopping) with GFSK modulation,.
TM5	TX-Pi/4DQPSK (Hopping)	Keep the EUT in continuously transmitting mode (hopping) with Pi/4DQPSK modulation.
TM6	TX-8DPSK (Hopping)	Keep the EUT in continuously transmitting mode (hopping) with 8DPSK modulation.
TM7	Link mode	Keep the EUT in Bluetooth linking mode with AE.
TM8	Charging mode	Keep the EUT in charging status

4.3. Support unit used in test configuration

The EUT has been associated with peripherals and configuration operated in a manner tended to maximize its emission characteristics in a typical application.

The following peripheral devices and interface cables were connected during the measurement:

Item	Equipment name	Trade Name	Model No.
1	Adapter	Guangdong Sangu Technology Co. Ltd	SG-0501000AU
2	Phone	Huawei	NZONE S7

4.4. Test sample information

Type	Sample No.
Engineer sample	CISR241105029-S01
Normal sample	CISR241105029-S02

4.5. Environmental conditions

Type	Requirement
Temperature:	15~35°C
Relative Humidity:	25~75%
Air Pressure:	860~1060mbar

4.6. Equipment Used during the Test

Conducted Emission at AC power line						
Item	Equipment name	Manufacturer	Model	Serial No.	Calibration date	Due date
1	EMI Test Receiver	Rohde&schwarz	ESC17	100853	2024-01-08	2025-01-07
2	Artificial power network	Schwarzbeck	NSLK812 7	8127-01096	2024-01-08	2025-01-07
3	8-wire Impedance Stabilization Network	Schwarzbeck	NTFM 8158	8158-00337	2024-01-08	2025-01-07
4	Artificial power network	Schwarzbeck	ENV216	/	2024-01-08	2025-01-07

20dB Bandwidth Maximum Conducted Output Power Channel Separation Number of Hopping Frequencies Dwell Time Emissions in non-restricted frequency bands						
Item	Equipment name	Manufacturer	Model	Serial No.	Calibration date	Due date
1	MXG RF Signal Generator	Agilent	N5181A	MY50145362	2024-01-08	2025-01-07
2	Spectrum analyzer	R&S	FSV-40N	102130	2024-01-08	2025-01-07
3	Vector Signal Generator	Agilent	N5182A	MY50142364	2024-06-14	2025-06-13
4	Power Meter	WCS	WCS-PM	WCSPM23040 5A	2024-01-08	2025-01-07

Band edge emissions (Radiated) Emissions in frequency bands (below 1GHz) Emissions in frequency bands (above 1GHz)						
Item	Equipment name	Manufacturer	Model	Serial No.	Calibration date	Due date
1	EMI Test Receiver	Rohde&schwarz	ESC17	100853	2024-01-08	2025-01-07
2	Amplifier	Tonscend	TAP9K3G 40	AP23A806027 0	2024-01-08	2025-01-07
3	Prime amplifier	Tonscend	TAP0101 8050	AP23A806028 0	2024-01-08	2025-01-07
4	9*6*6 anechoic chamber	SKET	9.3*6.3*6	N/A	2024-09-02	2027-09-01
5	Spectrum analyzer	Agilent	N9020A	MY50530263	2024-01-08	2025-01-07
6	Spectrum analyzer	R&S	FSV-40N	102130	2024-01-08	2025-01-07
7	Bilog Antenna	Schwarzbeck	VULB 9163	1463	2023-01-09	2025-01-08
8	Horn Antenna	SCHWARZBECK	BBHA 9120 D	2487	2023-01-09	2025-01-08

9	Active Loop Antenna	SCHWARZBECK	FMZB 1519B	/	2023-01-09	2025-01-08
10	RF Cable	Tonscend	Cable 1	/	2024-01-08	2025-01-07
11	RF Cable	Tonscend	Cable 2	/	2024-01-08	2025-01-07
12	RF Cable	SKET	Cable 3	/	2024-01-08	2025-01-07
13	L.I.S.N.#1	Schwarzbeck	NSLK812 7	/	2024-01-08	2025-01-07
14	L.I.S.N.#2	ROHDE&SCHWARZ	ENV216	/	2024-01-08	2025-01-07
15	Horn Antenna	SCHWARZBECK	BBHA917 0	1130	2023-01-09	2025-01-08
16	Preamplifier	Tonscend	TAP1804 0048	AP21C806126	2024-01-08	2025-01-07
17	Variable-frequency power source	Pinhong	PH1110	/	2024-01-08	2025-01-07
18	6dB Attenuator	SKET	DC-6G	/	/	/
19	Antenna tower	SKT	Bk-4AT-BS	AT202104010 1-V1	2024-06-14	2025-06-13

5. TEST RESULTS

5.1. Evaluation Results (Evaluation)

5.1.1. Antenna Requirement

Test Requirement:

Refer to 47 CFR Part 15.203, an intentional radiator shall be designed to ensure that no antenna other than that furnished by the responsible party shall be used with the device. The use of a permanently attached antenna or of an antenna that uses a unique coupling to the intentional radiator shall be considered sufficient to comply with the provisions of this section.

5.1.1.1. Test Result

Pass

5.1.1.2. Conclusion:

The EUT antenna is PCB(1.9dBi), the directional gain of the antenna less than 6dBi. It comply with the standard requirement. In case of replacement of broken antenna the same antenna type must be used. Antenna structure please refer to the EUT internal photographs antenna photo.

5.2. Radio Spectrum Matter Test Results (RF)

5.2.1. Conducted Emission at AC power line

Test Requirement:	Refer to 47 CFR 15.207(a), Except as shown in paragraphs (b) and (c) of this section, for an intentional radiator that is designed to be connected to the public utility (AC) power line, the radio frequency voltage that is conducted back onto the AC power line on any frequency or frequencies, within the band 150 kHz to 30 MHz, shall not exceed the limits in the following table, as measured using a 50 μ H/50 ohms line impedance stabilization network (LISN).		
Test Limit:	Frequency of emission (MHz)	Conducted limit (dB μ V)	
		Quasi-peak	Average
	0.15-0.5	66 to 56*	56 to 46*
	0.5-5	56	46
	5-30	60	50
*Decreases with the logarithm of the frequency.			
Test Method:	ANSI C63.10-2020 section 6.2		
Procedure:	<ol style="list-style-type: none"> The EUT was setup according to ANSI C63.10 requirements. The EUT was placed on a platform of nominal size, 1 m by 1.5 m, raised 80 cm above the conducting ground plane. The vertical conducting plane was located 40 cm to the rear of the EUT. All other surfaces of EUT were at least 80 cm from any other grounded conducting surface. The EUT and simulators are connected to the main power through a line impedances stabilization network (LISN). The LISN provides a 50 ohm /50μH coupling impedance for the measuring equipment. The peripheral devices are also connected to the main power through a LISN. (Refer to the block diagram of the test setup and photographs) Each current-carrying conductor of the EUT power cord, except the ground (safety) conductor, was individually connected through a LISN to the input power source. The excess length of the power cord between the EUT and the LISN receptacle were folded back and forth at the center of the lead to form a bundle not exceeding 40 cm in length. Conducted emissions were investigated over the frequency range from 0.15MHz to 30MHz using a receiver bandwidth of 9 kHz. During the above scans, the emissions were maximized by cable manipulation. 		

5.2.1.1. E.U.T. Operation

Operating Environment:					
Temperature:	22.6 °C	Humidity:	55.3 %	Atmospheric Pressure:	102 kPa
Pre test mode:	TM7				
Final test mode:	TM7				

5.2.1.2. Test Setup Diagram

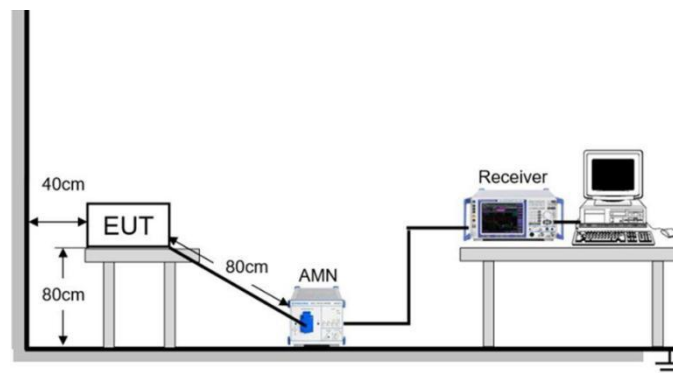

5.2.1.3. Test Result

Pass

5.2.1.4. Test Data

Mode7 / Line: Line

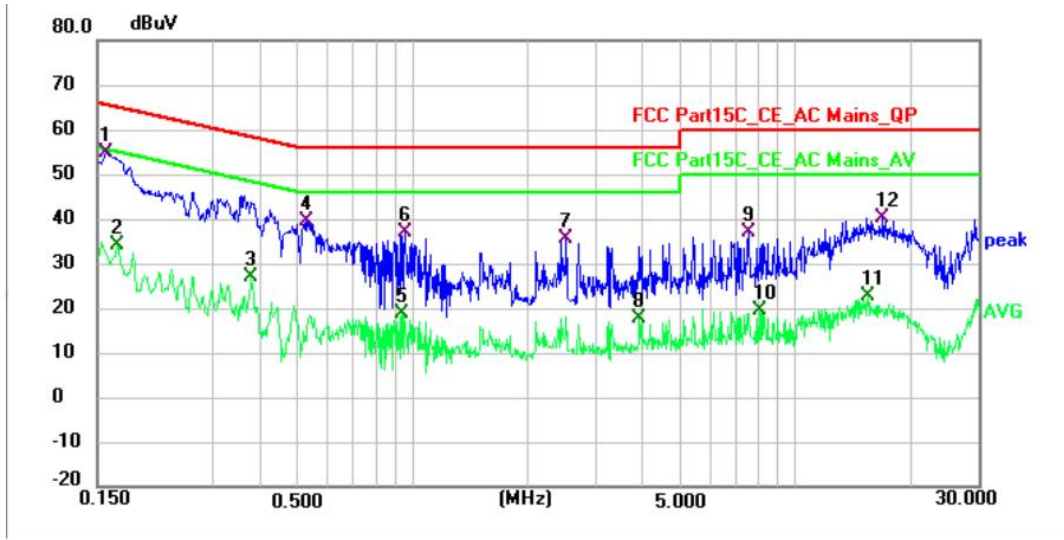

No.	Frequency (MHz)	Reading (dBuV)	Factor (dB)	Level (dBuV)	Limit (dBuV)	Margin (dB)	Detector	P/F	Remark
1 *	0.158	54.46	0.32	54.78	65.57	-10.79	QP	P	
2	0.169	33.70	0.32	34.02	55.01	-20.99	AVG	P	
3	0.378	26.81	0.32	27.13	48.32	-21.19	AVG	P	
4	0.530	39.10	0.38	39.48	56.00	-16.52	QP	P	
5	0.934	18.47	0.42	18.89	46.00	-27.11	AVG	P	
6	0.962	36.49	0.43	36.92	56.00	-19.08	QP	P	
7	2.522	34.55	0.85	35.40	56.00	-20.60	QP	P	
8	3.918	16.34	1.34	17.68	46.00	-28.32	AVG	P	
9	7.562	34.12	2.91	37.03	60.00	-22.97	QP	P	
10	8.034	16.39	3.05	19.44	50.00	-30.56	AVG	P	
11	15.486	16.61	6.17	22.78	50.00	-27.22	AVG	P	
12	16.870	34.26	5.99	40.25	60.00	-19.75	QP	P	

Mode7 / Line: Neutral

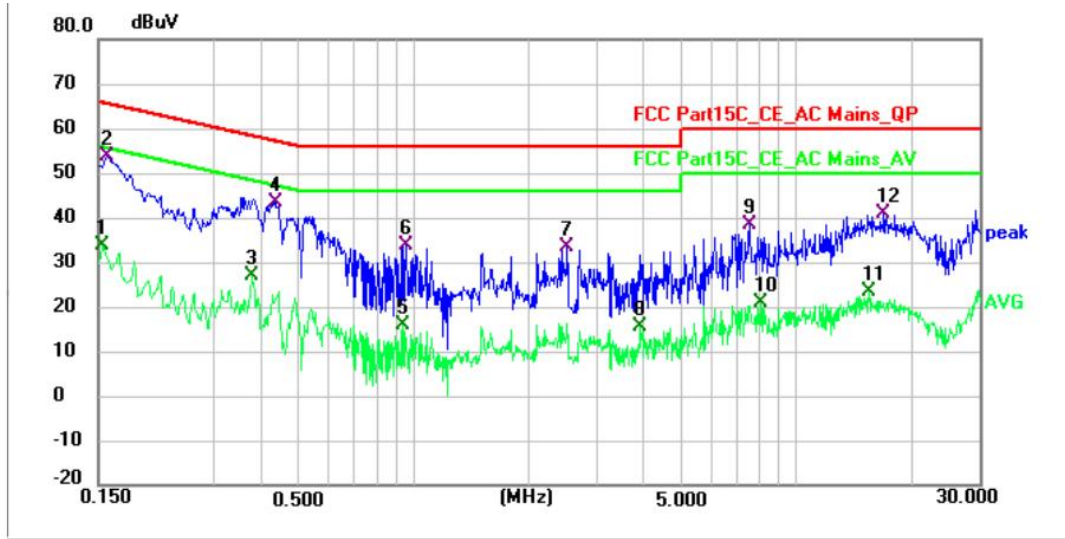

No.	Frequency (MHz)	Reading (dBuV)	Factor (dB)	Level (dBuV)	Limit (dBuV)	Margin (dB)	Detector	P/F	Remark
1	0.154	33.42	0.33	33.75	55.79	-22.04	AVG	P	
2 *	0.158	53.46	0.33	53.79	65.57	-11.78	QP	P	
3	0.378	26.81	0.33	27.14	48.32	-21.18	AVG	P	
4	0.434	43.12	0.35	43.47	57.18	-13.71	QP	P	
5	0.934	15.47	0.42	15.89	46.00	-30.11	AVG	P	
6	0.962	33.49	0.42	33.91	56.00	-22.09	QP	P	
7	2.522	32.55	0.85	33.40	56.00	-22.60	QP	P	
8	3.918	14.34	1.35	15.69	46.00	-30.31	AVG	P	
9	7.562	35.62	2.93	38.55	60.00	-21.45	QP	P	
10	8.034	17.89	3.07	20.96	50.00	-29.04	AVG	P	
11	15.486	17.61	5.74	23.35	50.00	-26.65	AVG	P	
12	16.870	35.26	5.81	41.07	60.00	-18.93	QP	P	

Note:

- 1). Result = Reading +Correct (Insertion Loss + Cable Loss + Attenuator Factor)
- 2). Margin = Result - Limit

5.2.2. 20dB Bandwidth

Test Requirement:	47 CFR 15.247(a)(1)
Test Limit:	Refer to 47 CFR 15.215(c), intentional radiators operating under the alternative provisions to the general emission limits, as contained in §§ 15.217 through 15.257 and in subpart E of this part, must be designed to ensure that the 20 dB bandwidth of the emission, or whatever bandwidth may otherwise be specified in the specific rule section under which the equipment operates, is contained within the frequency band designated in the rule section under which the equipment is operated.
Test Method:	ANSI C63.10-2020, section 7.8.6, For occupied bandwidth measurements, use the procedure in 6.9.3. Frequency hopping shall be disabled for this test.
Procedure:	<p>The occupied bandwidth is the frequency bandwidth such that, below its lower and above its upper frequency limits, the mean powers are each equal to 0.5% of the total mean power of the given emission. The following procedure shall be used for measuring 99% power bandwidth:</p> <p>a) The instrument center frequency is set to the nominal EUT channel center frequency. The frequency span for the spectrum analyzer shall be between 1.5 times and 5.0 times the OBW.</p> <p>b) The nominal IF filter bandwidth (3 dB RBW) shall be in the range of 1% to 5% of the OBW, and VBW shall be at least three times the RBW, unless otherwise specified by the applicable requirement.</p> <p>c) Set the reference level of the instrument as required, keeping the signal from exceeding the maximum input mixer level for linear operation. In general, the peak of the spectral envelope shall be more than $[10 \log (OBW/RBW)]$ below the reference level. Specific guidance is given in 4.1.6.2.</p> <p>d) Step a) through step c) might require iteration to adjust within the specified range.</p> <p>e) Video averaging is not permitted. Where practical, a sample detection and single sweep mode shall be used. Otherwise, peak detection and max-hold mode (until the trace stabilizes) shall be used.</p> <p>f) Use the 99% power bandwidth function of the instrument (if available) and report the measured bandwidth.</p> <p>g) If the instrument does not have a 99% power bandwidth function, then the trace data points are recovered and directly summed in linear power terms. The recovered amplitude data points, beginning at the lowest frequency, are placed in a running sum until 0.5% of the total is reached; that frequency is recorded as the lower frequency. The process is repeated until 99.5% of the total is reached; that frequency is recorded as the upper frequency. The 99% power bandwidth is the difference between these two frequencies.</p> <p>h) The occupied bandwidth shall be reported by providing spectral plot(s) of the measuring instrument display; the plot axes and the scale units per division shall be clearly labeled. Tabular data may be reported in addition to the plot(s).</p>

5.2.2.1. E.U.T. Operation

Operating Environment:					
Temperature:	22.1 °C	Humidity:	56.6 %	Atmospheric Pressure:	102 kPa
Pre test mode:	TM1, TM2, TM3				
Final test mode:	TM1, TM2, TM3				

5.2.2.2. Test Setup Diagram

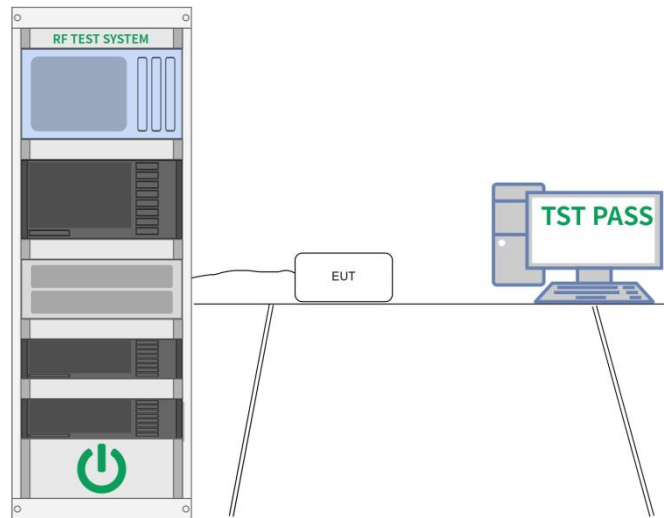

5.2.2.3. Test Result

Pass

5.2.2.4. Test Data

Please Refer to Appendix for Details.

5.2.3. Maximum Conducted Output Power

Test Requirement:	47 CFR 15.247(b)(1)
Test Limit:	Refer to 47 CFR 15.247(b)(1), For frequency hopping systems operating in the 2400-2483.5 MHz band employing at least 75 non-overlapping hopping channels, and all frequency hopping systems in the 5725-5850 MHz band: 1 watt. For all other frequency hopping systems in the 2400-2483.5 MHz band: 0.125 watts.
Test Method:	ANSI C63.10-2020, section 7.8.5
Procedure:	<p>This is an RF-conducted test to evaluate maximum peak output power. Use a direct connection between the antenna port of the unlicensed wireless device and the spectrum analyzer, through suitable attenuation. Frequency hopping shall be disabled for this test. Use the following spectrum analyzer settings:</p> <ul style="list-style-type: none"> a) Span: Approximately five times the 20 dB bandwidth, centered on a hopping channel. b) RBW > 20 dB bandwidth of the emission being measured. c) VBW ≥ RBW. d) Sweep: No faster than coupled (auto) time. e) Detector function: Peak. f) Trace: Max-hold. g) Allow trace to stabilize. h) Use the marker-to-peak function to set the marker to the peak of the emission. i) The indicated level is the peak output power, after any corrections for external attenuators and cables. j) A spectral plot of the test results and setup description shall be included in the test report. <p>NOTE—A peak responding power meter may be used, where the power meter and sensor system video bandwidth is greater than the occupied bandwidth of the unlicensed wireless device, rather than a spectrum analyzer.</p>

5.2.3.1. E.U.T. Operation

Operating Environment:					
Temperature:	23.1 °C	Humidity:	55.3 %	Atmospheric Pressure:	102 kPa
Pre test mode:	TM1, TM2, TM3				
Final test mode:	TM1, TM2, TM3				

5.2.3.2. Test Setup Diagram



5.2.3.3. Test Result

Pass

5.2.3.4. Test Data

Please Refer to Appendix for Details.

5.2.4. Channel Separation

Test Requirement:	47 CFR 15.247(a)(1)
Test Limit:	Refer to 47 CFR 15.247(a)(1), Frequency hopping systems shall have hopping channel carrier frequencies separated by a minimum of 25 kHz or the 20 dB bandwidth of the hopping channel, whichever is greater. Alternatively, frequency hopping systems operating in the 2400-2483.5 MHz band may have hopping channel carrier frequencies that are separated by 25 kHz or two-thirds of the 20 dB bandwidth of the hopping channel, whichever is greater, provided the systems operate with an output power no greater than 125 mW.
Test Method:	ANSI C63.10-2020, section 7.8.2
Procedure:	<p>The EUT shall have its hopping function enabled. Use the following spectrum analyzer settings:</p> <ul style="list-style-type: none"> a) Span: Wide enough to capture the peaks of two adjacent channels. b) RBW: Start with the RBW set to approximately 30% of the channel spacing; adjust as necessary to best identify the center of each individual channel. c) Video (or average) bandwidth (VBW) \geq RBW. d) Sweep: No faster than coupled (auto) time. e) Detector function: Peak. f) Trace: Max-hold. g) Allow the trace to stabilize. <p>Use the marker-delta function to determine the separation between the peaks of the adjacent channels. Compliance of an EUT with the appropriate regulatory limit shall be determined. A spectral plot of the data shall be included in the test report.</p>

5.2.4.1. E.U.T. Operation

Operating Environment:					
Temperature:	23.1 °C	Humidity:	55.3 %	Atmospheric Pressure:	102 kPa
Pre test mode:	TM4, TM5, TM6				
Final test mode:	TM4, TM5, TM6				

5.2.4.2. Test Setup Diagram



5.2.4.3. Test Result

Pass

5.2.4.4. Test Data

Please Refer to Appendix for Details.

5.2.5. Number of Hopping Frequencies

Test Requirement:	47 CFR 15.247(a)(1)(iii)
Test Limit:	Refer to 47 CFR 15.247(a)(1)(iii), Frequency hopping systems in the 2400-2483.5 MHz band shall use at least 15 channels. The average time of occupancy on any channel shall not be greater than 0.4 seconds within a period of 0.4 seconds multiplied by the number of hopping channels employed. Frequency hopping systems may avoid or suppress transmissions on a particular hopping frequency provided that a minimum of 15 channels are used.
Test Method:	ANSI C63.10-2020, section 7.8.3
Procedure:	<p>The EUT shall have its hopping function enabled. Use the following spectrum analyzer settings:</p> <ul style="list-style-type: none"> a) Span: The frequency band of operation. Depending on the number of channels the device supports, it could be necessary to divide the frequency range of operation across multiple spans, to allow the individual channels to be clearly seen. b) RBW: To identify clearly the individual channels, set the RBW to less than 30% of the channel spacing or the 20 dB bandwidth, whichever is smaller. c) VBW \geq RBW. d) Sweep: No faster than coupled (auto) time. e) Detector function: Peak. f) Trace: Max-hold. g) Allow the trace to stabilize. <p>It might prove necessary to break the span up into subranges to show clearly all of the hopping frequencies. Compliance of an EUT with the appropriate regulatory limit shall be determined for the number of hopping channels. A spectral plot of the data shall be included in the test report.</p>

5.2.5.1. E.U.T. Operation

Operating Environment:					
Temperature:	23.1 °C	Humidity:	55.3 %	Atmospheric Pressure:	102 kPa
Pre test mode:	TM4, TM5, TM6				
Final test mode:	TM4, TM5, TM6				

5.2.5.2. Test Setup Diagram



5.2.5.3. Test Result

Pass

5.2.5.4. Test Data

Please Refer to Appendix for Details.

5.2.6. Dwell Time

Test Requirement:	47 CFR 15.247(a)(1)(iii)
Test Limit:	Refer to 47 CFR 15.247(a)(1)(iii), Frequency hopping systems in the 2400-2483.5 MHz band shall use at least 15 channels. The average time of occupancy on any channel shall not be greater than 0.4 seconds within a period of 0.4 seconds multiplied by the number of hopping channels employed. Frequency hopping systems may avoid or suppress transmissions on a particular hopping frequency provided that a minimum of 15 channels are used.
Test Method:	ANSI C63.10-2020, section 7.8.4
Procedure:	<p>The dwell time per hop on a channel is the time from the start of the first transmission to the end of the last transmission for that hop. If the device has a single transmission per hop then the dwell time is the duration of that transmission. If the device has a multiple transmissions per hop then the dwell time is measured from the start of the first transmission to the end of the last transmission.</p> <p>The time of occupancy is the total time that the device dwells on a channel over an observation period specified in the regulatory requirement. To determine the time of occupancy the spectrum analyzer will be configured to measure both the dwell time per hop and the number of times the device transmits on a specific channel in a given period.</p> <p>The EUT shall have its hopping function enabled. Compliance with the requirements shall be made with the minimum and with the maximum number of channels enabled. If the dwell time per channel does not vary with the number of channels than compliance with the requirements may be based on the minimum number of channels. If the device supports different dwell times per channel (example Bluetooth devices can dwell on a channel for 1, 3 or 5 time slots) then measurements can be limited to the longest dwell time with the minimum number of channels.</p> <p>Use the following spectrum analyzer settings to determine the dwell time per hop:</p> <ul style="list-style-type: none"> a) Span: Zero span, centered on a hopping channel. b) RBW shall be \leq channel spacing and where possible RBW should be set $\gg 1 / T$, where T is the expected transmission time per hop. c) Sweep time: Set so that the start of the first transmission and end of the last transmission for the hop are clearly captured. Setting the sweep time to be slightly longer than the hopping period per channel (hopping period = $1/\text{hopping rate}$) should achieve this. d) Use a video trigger, where possible with a trigger delay, so that the start of the transmission is clearly observed. The trigger level might need adjustment to reduce the chance of triggering when the system hops on an adjacent channel. e) Detector function: Peak. f) Trace: Clear-write, single sweep. g) Place markers at the start of the first transmission on the channel and at the end of the last transmission. The dwell time per hop is the time between these two markers. <p>To determine the number of hops on a channel in the regulatory observation period repeat the measurement using a longer sweep time. When the device uses a single hopping sequence the period of measurement should be sufficient to capture at least 2 hops. When the device uses a dynamic hopping sequence, or the sequence varies, the period of measurement may need to capture multiple hops to better determine the average time of occupancy. Count the number of hops on the channel across the sweep time.</p> <p>The average number of hops on the same channel within the regulatory observation period is calculated from the number of hops on the channel divided by the spectrum analyzer sweep time multiplied by the regulatory observation period. For example, if three hops are counted with an analyzer sweep time of 500 ms and</p>

the regulatory observation period is 10 s, then the number of hops in that ten seconds is $3 / 0.5 \times 10$, or 60 hops.

The average time of occupancy is calculated by multiplying the dwell time per hop by the number of hops in the observation period.

5.2.6.1. E.U.T. Operation

Operating Environment:					
Temperature:	23.1 °C	Humidity:	55.3 %	Atmospheric Pressure:	102 kPa
Pre test mode:	TM4, TM5, TM6				
Final test mode:	TM4, TM5, TM6				

5.2.6.2. Test Setup Diagram



5.2.6.3. Test Result

Pass

5.2.6.4. Test Data

Please Refer to Appendix for Details.

5.2.7. Conducted band edge and spurious emission

Test Requirement:	47 CFR 15.247(d), 15.209, 15.205
Test Limit:	<p>Refer to 47 CFR 15.247(d), In any 100 kHz bandwidth outside the frequency band in which the spread spectrum or digitally modulated intentional radiator is operating, the radio frequency power that is produced by the intentional radiator shall be at least 20 dB below that in the 100 kHz bandwidth within the band that contains the highest level of the desired power, based on either an RF conducted or a radiated measurement, provided the transmitter demonstrates compliance with the peak conducted power limits. If the transmitter complies with the conducted power limits based on the use of RMS averaging over a time interval, as permitted under paragraph (b)(3) of this section, the attenuation required under this paragraph shall be 30 dB instead of 20 dB. Attenuation below the general limits specified in § 15.209(a) is not required.</p>
Test Method:	ANSI C63.10-2020 section 7.8.7
Procedure:	<p>7.8.7.1 General considerations To demonstrate compliance with the relative out-of-band emissions requirements conducted spurious emissions shall be measured for the transmit frequencies, per 5.5 and 5.6, and at the maximum transmit powers. Frequency hopping shall be disabled for this test with the exception of measurements at the allocated band-edges which shall be repeated with hopping enabled.</p> <p>Connect the primary antenna port through an attenuator to the spectrum analyzer input; in the results, account for all losses between the unlicensed wireless device output and the spectrum analyzer. The frequency range of testing shall span 30 MHz to 10 times the operating frequency and this may be done in a single sweep or, to aid resolution, across a number of sweeps. The resolution bandwidth shall be 100 kHz, video bandwidth 300 kHz, and a coupled sweep time with a peak detector.</p> <p>The limit is based on the highest in-band level across all channels measured using the same instrument settings (resolution bandwidth of 100 kHz, video bandwidth of 300 kHz, and a coupled sweep time with a peak detector). To help clearly demonstrate compliance a display line may be set at the required offset (typically 20 dB) below the highest in-band level. Where the highest in-band level is not clearly identified in the out-of-band measurements a separate spectral plot showing the in-band level shall be provided.</p> <p>When conducted measurements cannot be made (for example a device with integrated, non-removable antenna) radiated measurements shall be used. The reference level for determining the limit shall be established by maximizing the field strength from the highest power channel and measuring using the resolution and video bandwidth settings and peak detector as described above. The field strength limit for spurious emissions outside of restricted-bands shall then be set at the required offset (typically 20 dB) below the highest in-band level. Radiated measurements will follow the standards measurement procedures described in Clause 6 with the exception that the resolution bandwidth shall be 100 kHz, video bandwidth 300 kHz, and a coupled sweep time with a peak detector. Note that use of wider measurement bandwidths are acceptable for measuring the spurious emissions provided that the peak detector is used and that the measured value of spurious emissions are compared to the highest in-band level measured with the 100 kHz / 300 kHz bandwidth settings to determine compliance.</p> <p>7.8.7.2 Band-edges Compliance with a relative limit at the band-edges (e.g., -20 dBc) shall be made on the lowest and on the highest channels with frequency hopping disabled and repeated with frequency hopping enabled. For the latter test the hopping sequence shall include the lowest and highest channels.</p> <p>For measurements with the hopping disabled the analyzer screen shall clearly show compliance with the requirement within 10 MHz of the allocated band-edge.</p>

	For measurements with the hopping enabled the analyzer screen shall clearly show compliance with the requirement within 10 MHz of both of the allocated band-edges. This could require separate spectral plots for each band-edge.
--	--

5.2.7.1. E.U.T. Operation

Operating Environment:					
Temperature:	23.1 °C	Humidity:	55.3 %	Atmospheric Pressure:	102 kPa
Pre test mode:	TM1, TM2, TM3, TM4, TM5, TM6				
Final test mode:	TM1, TM2, TM3, TM4, TM5, TM6				

5.2.7.2. Test Setup Diagram



5.2.7.3. Test Result

Pass

5.2.7.4. Test Data

Please Refer to Appendix for Details.

5.2.8. Radiated band edge emission

Test Requirement:	Refer to 47 CFR 15.247(d), In addition, radiated emissions which fall in the restricted bands, as defined in § 15.205(a), must also comply with the radiated emission limits specified in § 15.209(a)(see § 15.205(c)).`		
Test Limit:	Frequency (MHz)	Field strength (microvolts/meter)	Measurement distance (meters)
	0.009-0.490	2400/F(kHz)	300
	0.490-1.705	24000/F(kHz)	30
	1.705-30.0	30	30
	30-88	100 **	3
	88-216	150 **	3
	216-960	200 **	3
	Above 960	500	3
<p>** Except as provided in paragraph (g), fundamental emissions from intentional radiators operating under this section shall not be located in the frequency bands 54-72 MHz, 76-88 MHz, 174-216 MHz or 470-806 MHz. However, operation within these frequency bands is permitted under other sections of this part, e.g., §§ 15.231 and 15.241.</p> <p>In the emission table above, the tighter limit applies at the band edges. The emission limits shown in the above table are based on measurements employing a CISPR quasi-peak detector except for the frequency bands 9–90 kHz, 110–490 kHz and above 1000 MHz. Radiated emission limits in these three bands are based on measurements employing an average detector.</p>			
Test Method:	ANSI C63.10-2020 section 6.10		
Procedure:	<ol style="list-style-type: none"> 1. EUT was setup and tested according to ANSI C63.10 . 2. The EUT is placed on a turn table which is 1.5 meter above ground. The turn table is rotated 360 degrees to determine the position of the maximum emission level. 3. The EUT was positioned such that the distance from antenna to the EUT was 3 meters. 4. The antenna is scanned from 1 meter to 4 meters to find out the maximum emission level. This is repeated for both horizontal and vertical polarization of the antenna. In order to find the maximum emission, all of the interface cables were manipulated according to ANSI C63.10 on radiated measurement. 5. Use the following spectrum analyzer settings: <ol style="list-style-type: none"> a) Span shall wide enough to fully capture the emission being measured b) Set RBW=1MHz, VBW=3MHz for >1GHz, Sweep time=auto, Detector=peak, Trace=max hold for Peak measurement For average measurement: use duty cycle correction factor method (DCCF), Averager level = Peak level + DCCF 		

5.2.8.1. E.U.T. Operation

Operating Environment:					
Temperature:	23.1 °C	Humidity:	56.6 %	Atmospheric Pressure:	102 kPa
Pre test mode:	TM1, TM2, TM3, TM4, TM5, TM6, TM7, TM8				
Final test mode:	TM1, TM2, TM3, TM4, TM5, TM6, TM7, TM8				

5.2.8.2. Test Setup Diagram

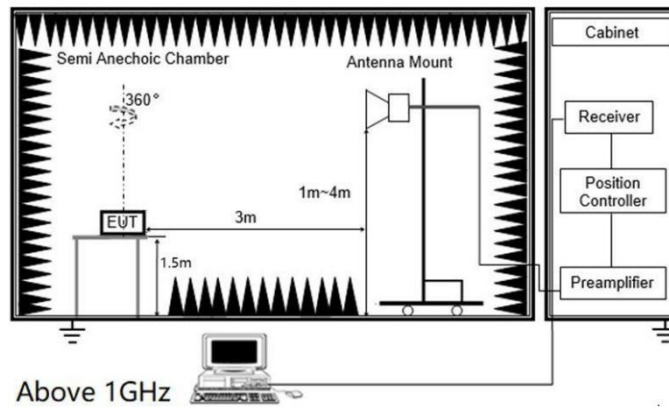

5.2.8.3. Test Result

Pass

5.2.8.4. Test Data

Note:

- 1) Level= Reading + Factor; Factor =Antenna Factor+ Cable Loss- Preamp Factor
- 2) Margin = Limit - Level
- 3) Average measurement was not performed if peak level is lower than average limit
- 4) Have pre-scan all test mode, found TM1 mode which it was worst case, so only show the worst case' s data on this report.
- 5) The other emission levels were very low against the limit.

Mode1 / Polarization: Horizontal / CH: L

Test Graph

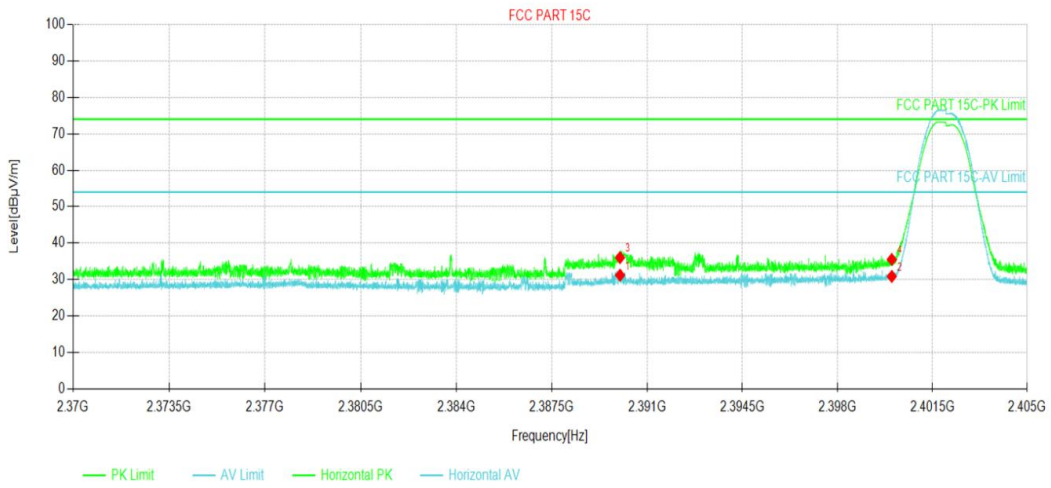

Suspected Data List

NO.	Freq. [MHz]	Reading [dBµV/m]	Level [dBµV/m]	Factor [dB]	Limit [dBµV/m]	Margin [dB]	Polarity	Verdict
1	2390.00	48.76	31.21	-17.55	54.00	22.79	Horizontal	PASS
2	2400.00	48.40	30.87	-17.53	54.00	23.13	Horizontal	PASS
3	2390.00	53.58	36.03	-17.55	74.00	37.97	Horizontal	PASS
4	2400.00	53.06	35.53	-17.53	74.00	38.47	Horizontal	PASS

Mode1 / Polarization: Vertical / CH: L

Test Graph

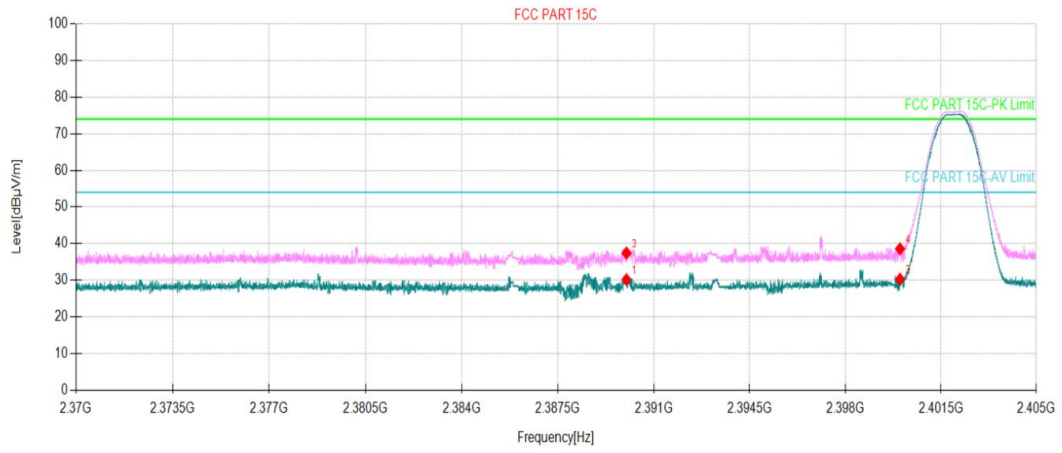

Suspected Data List

NO.	Freq. [MHz]	Reading [dBµV/m]	Level [dBµV/m]	Factor [dB]	Limit [dBµV/m]	Margin [dB]	Polarity	Verdict
1	2390.00	47.71	30.16	-17.55	54.00	23.84	Vertical	PASS
2	2400.00	47.82	30.29	-17.53	54.00	23.71	Vertical	PASS
3	2390.00	54.98	37.43	-17.55	74.00	36.57	Vertical	PASS
4	2400.00	56.11	38.58	-17.53	74.00	35.42	Vertical	PASS

Mode1 / Polarization: Horizontal / CH: H

Test Graph

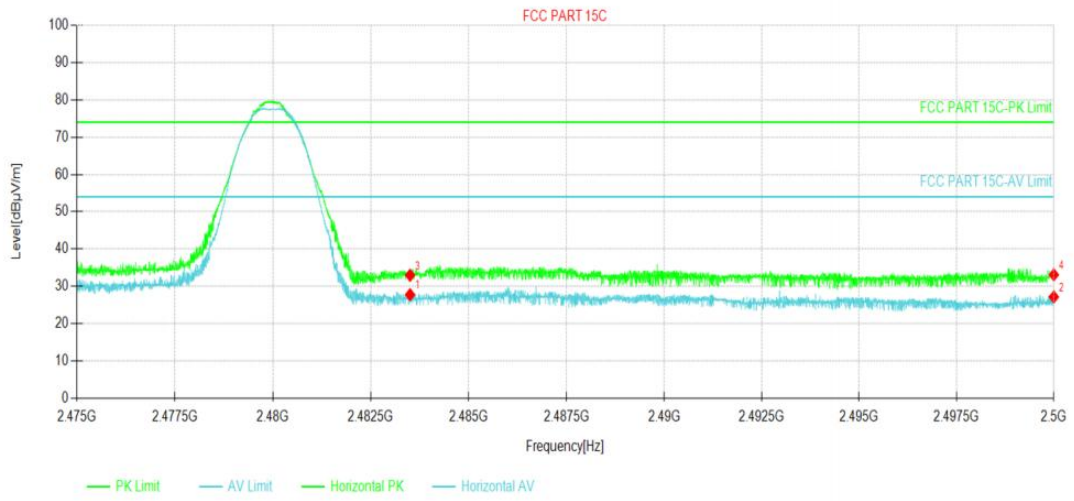

Suspected Data List

NO.	Freq. [MHz]	Reading [dBµV/m]	Level [dBµV/m]	Factor [dB]	Limit [dBµV/m]	Margin [dB]	Polarity	Verdict
1	2483.5	44.79	27.77	-17.02	54.00	26.23	Horizontal	PASS
2	2500	44.09	27.17	-16.92	54.00	26.83	Horizontal	PASS
3	2483.5	49.98	32.96	-17.02	74.00	41.04	Horizontal	PASS
4	2500	50.02	33.10	-16.92	74.00	40.90	Horizontal	PASS

Mode1 / Polarization: Vertical / CH: H

Test Graph

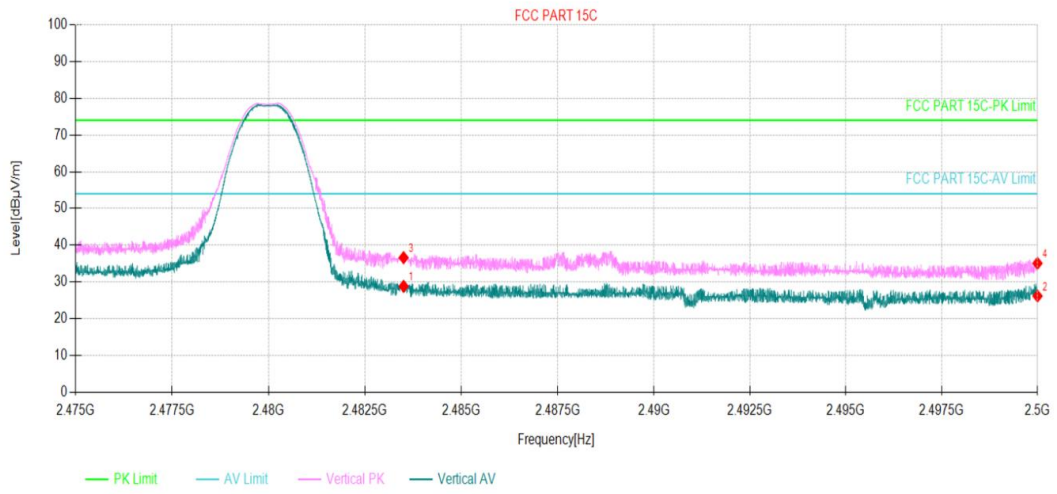

Suspected Data List

NO.	Freq. [MHz]	Reading [dBµV/m]	Level [dBµV/m]	Factor [dB]	Limit [dBµV/m]	Margin [dB]	Polarity	Verdict
1	2483.5	45.84	28.82	-17.02	54.00	25.18	Vertical	PASS
2	2500	43.08	26.16	-16.92	54.00	27.84	Vertical	PASS
3	2483.5	53.64	36.62	-17.02	74.00	37.38	Vertical	PASS
4	2500	52.00	35.08	-16.92	74.00	38.92	Vertical	PASS

5.2.9. Radiated Spurious Emission

Test Requirement:	Refer to 47 CFR 15.247(d), In addition, radiated emissions which fall in the restricted bands, as defined in § 15.205(a), must also comply with the radiated emission limits specified in § 15.209(a)(see § 15.205(c)).`		
Test Limit:	Frequency (MHz)	Field strength (microvolts/meter)	Measurement distance (meters)
	0.009-0.490	2400/F(kHz)	300
	0.490-1.705	24000/F(kHz)	30
	1.705-30.0	30	30
	30-88	100 **	3
	88-216	150 **	3
	216-960	200 **	3
	Above 960	500	3
<p>** Except as provided in paragraph (g), fundamental emissions from intentional radiators operating under this section shall not be located in the frequency bands 54-72 MHz, 76-88 MHz, 174-216 MHz or 470-806 MHz. However, operation within these frequency bands is permitted under other sections of this part, e.g., §§ 15.231 and 15.241.</p> <p>In the emission table above, the tighter limit applies at the band edges.</p> <p>The emission limits shown in the above table are based on measurements employing a CISPR quasi-peak detector except for the frequency bands 9–90 kHz, 110–490 kHz and above 1000 MHz. Radiated emission limits in these three bands are based on measurements employing an average detector.</p>			
Test Method:	ANSI C63.10-2020 section 6.6.4		
Procedure:	<ol style="list-style-type: none"> 1. The EUT was setup and tested according to ANSI C63.10. 2. The EUT is placed on a turn table which is 0.8 meter above ground for below 1 GHz, and 1.5 m for above 1 GHz. The turn table is rotated 360 degrees to determine the position of the maximum emission level. 3. The EUT was set 3 meters from the receiving antenna, which was mounted on the top of a variable height antenna tower. 4. For each suspected emission, the EUT was arranged to its worst case and then tune the Antenna tower (from 1 m to 4 m) and turntable (from 0 degree to 360 degrees) to find the maximum reading. A pre-amp and a high pass filter are used for the test in order to get better signal level to comply with the guidelines. 5. Set to the maximum power setting and enable the EUT transmit continuously. 6. Use the following spectrum analyzer settings <ol style="list-style-type: none"> a) Span shall wide enough to fully capture the emission being measured; b) RBW=120 kHz, VBW=300 kHz, Sweep=auto, Detector function=peak, Trace=max hold; <p>If the emission level of the EUT measured by the peak detector is 3 dB lower than the applicable limit, the peak emission level will be reported. Otherwise, the emission measurement will be repeated using the quasi-peak detector and reported.</p>		

5.2.9.1. E.U.T. Operation

Operating Environment:					
Temperature:	23.1 °C	Humidity:	56.6 %	Atmospheric Pressure:	102 kPa
Pre test mode:	TM1, TM2, TM3, TM4, TM5, TM6, TM7, TM8				
Final test mode:	TM1, TM2, TM3, TM4, TM5, TM6, TM7, TM8				

5.2.9.2. Test Setup Diagram

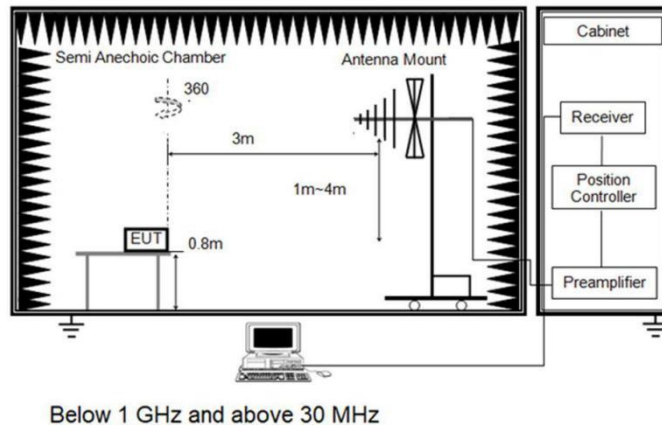

5.2.9.3. Test Result

Pass

5.2.9.4. Test Data

Note:

- 1) Level= Reading + Factor/Transd; Factor/Transd =Antenna Factor+ Cable Loss- Preamp Factor
- 2) Margin = Limit – Level
- 3) Average measurement was not performed if peak level is lower than average limit(54 dBuV/m) for above 1GHz.
- 4) The other emission levels were very low against the limit.
- 5) This test was performed with EUT in X, Y, Z position and the worse case was found when EUT in X position.

For 9 kHz ~ 30 MHz

The EUT was pre-scanned this frequency band, found the radiated level 20dB lower than the limit, so don't show data on this report.

For 30 MHz ~ 1000 MHz

Have pre-scan all test mode, found TM1 mode CH00 which it was worst case, so only show the worst case's data on this report.

Mode1 / Polarization: Horizontal / CH: L



No.	Frequency (MHz)	Reading (dBuV)	Factor (dB/m)	Level (dBuV/m)	Limit (dBuV/m)	Margin (dB)	Detector	Height (cm)	Azimuth (deg.)	P/F	Remark
1 *	33.917	46.00	-32.76	13.24	40.00	-26.76	QP	100	255	P	
2	48.672	33.25	-30.15	3.10	40.00	-36.90	QP	100	165	P	
3	87.418	32.91	-35.06	-2.15	40.00	-42.15	QP	100	187	P	
4	168.414	39.37	-34.21	5.16	43.50	-38.34	QP	100	313	P	
5	378.584	22.64	-28.33	-5.69	46.00	-51.69	QP	100	97	P	
6	848.056	22.94	-20.05	2.89	46.00	-43.11	QP	100	60	P	

Mode1 / Polarization: Vertical / CH: L



No.	Frequency (MHz)	Reading (dBuV)	Factor (dB/m)	Level (dBuV/m)	Limit (dBuV/m)	Margin (dB)	Detector	Height (cm)	Azimuth (deg.)	P/F	Remark
1	34.156	28.74	-32.76	-4.02	40.00	-44.02	QP	100	17	P	
2	48.672	28.99	-30.15	-1.16	40.00	-41.16	QP	100	133	P	
3	112.920	27.87	-32.61	-4.74	43.50	-48.24	QP	100	264	P	
4 *	165.487	39.19	-34.69	4.50	43.50	-39.00	QP	100	275	P	
5	296.184	23.20	-29.69	-6.49	46.00	-52.49	QP	100	328	P	
6	711.673	23.77	-20.89	2.88	46.00	-43.12	QP	100	133	P	

For 1 GHz ~ 25 GHz

Have pre-scan all test mode, found TM1 mode which it was worst case, so only show the worst case's data on this report.

Note:

1. In order to prevent the amplifier from saturating, we add a band-stop filter that filters out the main frequency.
2. 18GHz-25GHz is the background of the site, there is no radiated spurious.

Mode1 /Polarity: Horizontal / CH: 00

Test Graph

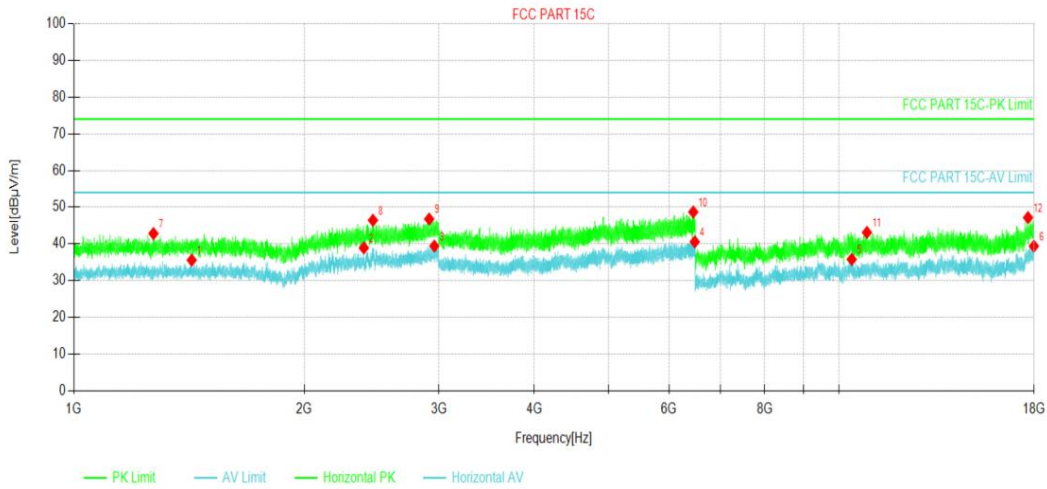

Suspected Data List

NO.	Freq. [MHz]	Reading [dBµV/m]	Level [dBµV/m]	Factor [dB]	Limit [dBµV/m]	Margin [dB]	Polarity	Verdict
1	1425.8	32.58	35.59	3.01	54.00	18.41	Horizontal	PASS
2	2393.6	31.98	38.94	6.96	54.00	15.06	Horizontal	PASS
3	2959.8	29.80	39.43	9.63	54.00	14.57	Horizontal	PASS
4	6480.75	34.07	40.60	6.53	54.00	13.40	Horizontal	PASS
5	10396.2	31.69	35.82	4.13	54.00	18.18	Horizontal	PASS
6	17987.3	25.97	39.42	13.45	54.00	14.58	Horizontal	PASS
7	1271	40.62	42.84	2.22	74.00	31.16	Horizontal	PASS
8	2460.2	39.02	46.46	7.44	74.00	27.54	Horizontal	PASS
9	2914	37.56	46.80	9.24	74.00	27.20	Horizontal	PASS
10	6452.05	42.18	48.71	6.53	74.00	25.29	Horizontal	PASS
11	10882.6	38.37	43.15	4.78	74.00	30.85	Horizontal	PASS
12	17675.7	35.19	47.18	11.99	74.00	26.82	Horizontal	PASS

Mode1 /Polarity: Vertical / CH: 00

Test Graph

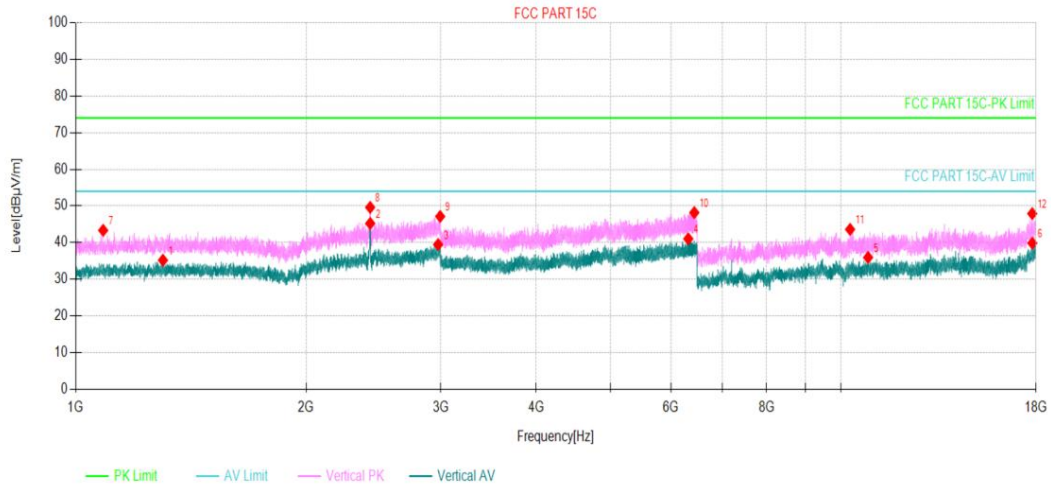

Suspected Data List

NO.	Freq. [MHz]	Reading [dBµV/m]	Level [dBµV/m]	Factor [dB]	Limit [dBµV/m]	Margin [dB]	Polarity	Verdict
1	1300.4	32.79	35.20	2.41	54.00	18.80	Vertical	PASS
2	2426.4	38.06	45.25	7.19	54.00	8.75	Vertical	PASS
3	2976.4	29.70	39.47	9.77	54.00	14.53	Vertical	PASS
4	6319.05	35.04	41.04	6.00	54.00	12.96	Vertical	PASS
5	10857.3	31.13	35.95	4.82	54.00	18.05	Vertical	PASS
6	17798.7	26.75	39.87	13.12	54.00	14.13	Vertical	PASS
7	1086.2	42.43	43.35	0.92	74.00	30.65	Vertical	PASS
8	2426	42.43	49.62	7.19	74.00	24.38	Vertical	PASS
9	2995	37.22	47.15	9.93	74.00	26.85	Vertical	PASS
10	6435.25	41.66	48.19	6.53	74.00	25.81	Vertical	PASS
11	10284.6	39.48	43.62	4.14	74.00	30.38	Vertical	PASS
12	17795.3	34.84	47.91	13.07	74.00	26.09	Vertical	PASS

Mode1 /Polarity: Horizontal / CH: 39

Test Graph

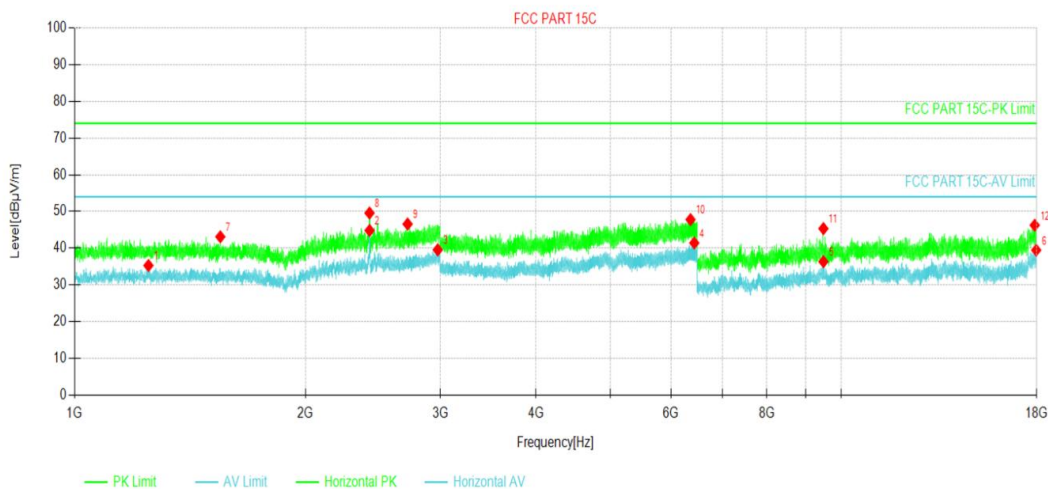

Suspected Data List

NO.	Freq. [MHz]	Reading [dBµV/m]	Level [dBµV/m]	Factor [dB]	Limit [dBµV/m]	Margin [dB]	Polarity	Verdict
1	1248.2	33.22	35.30	2.08	54.00	18.70	Horizontal	PASS
2	2425.4	37.66	44.84	7.18	54.00	9.16	Horizontal	PASS
3	2976.6	29.80	39.57	9.77	54.00	14.43	Horizontal	PASS
4	6433.85	34.90	41.43	6.53	54.00	12.57	Horizontal	PASS
5	9484.25	33.19	36.34	3.15	54.00	17.66	Horizontal	PASS
6	17973.5	26.12	39.48	13.36	54.00	14.52	Horizontal	PASS
7	1549.2	39.90	43.13	3.23	74.00	30.87	Horizontal	PASS
8	2425.2	42.41	49.59	7.18	74.00	24.41	Horizontal	PASS
9	2719	38.67	46.59	7.92	74.00	27.41	Horizontal	PASS
10	6361.75	41.53	47.81	6.28	74.00	26.19	Horizontal	PASS
11	9483.1	42.20	45.35	3.15	74.00	28.65	Horizontal	PASS
12	17893.0	33.36	46.27	12.91	74.00	27.73	Horizontal	PASS

Mode1 /Polarity: Vertical / CH: 39

Test Graph

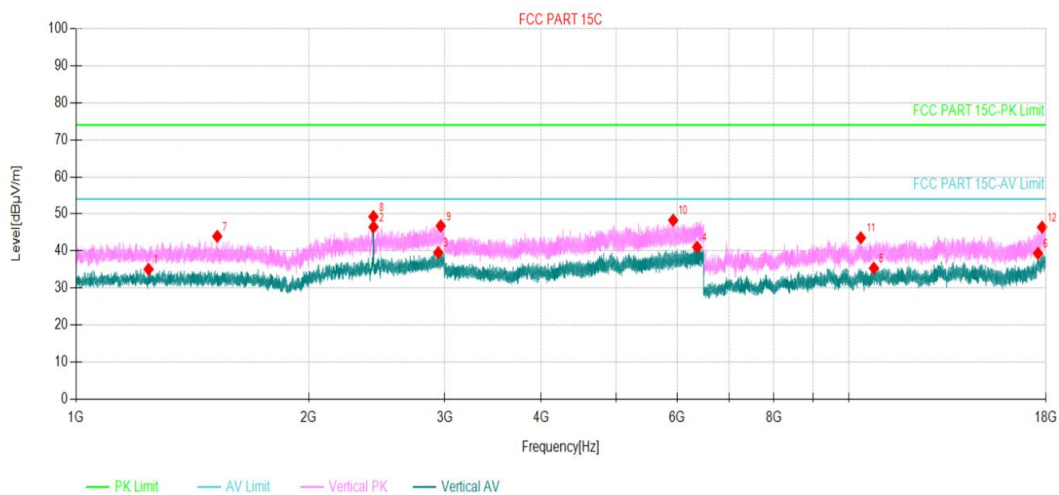

Suspected Data List								
NO.	Freq. [MHz]	Reading [dBµV/m]	Level [dBµV/m]	Factor [dB]	Limit [dBµV/m]	Margin [dB]	Polarity	Verdict
1	1241.4	33.04	35.07	2.03	54.00	18.93	Vertical	PASS
2	2426.6	39.29	46.48	7.19	54.00	7.52	Vertical	PASS
3	2943.2	30.06	39.55	9.49	54.00	14.45	Vertical	PASS
4	6365.6	34.72	41.03	6.31	54.00	12.97	Vertical	PASS
5	10779.1	30.56	35.36	4.80	54.00	18.64	Vertical	PASS
6	17580.2	27.27	39.36	12.09	54.00	14.64	Vertical	PASS
7	1523.2	40.73	43.96	3.23	74.00	30.04	Vertical	PASS
8	2426.4	42.08	49.27	7.19	74.00	24.73	Vertical	PASS
9	2965	37.09	46.76	9.67	74.00	27.24	Vertical	PASS
10	5927.05	43.33	48.30	4.97	74.00	25.70	Vertical	PASS
11	10368.6	39.41	43.57	4.16	74.00	30.43	Vertical	PASS
12	17791.8	33.40	46.42	13.02	74.00	27.58	Vertical	PASS

Mode1 /Polarity: Horizontal / CH: 78

Test Graph

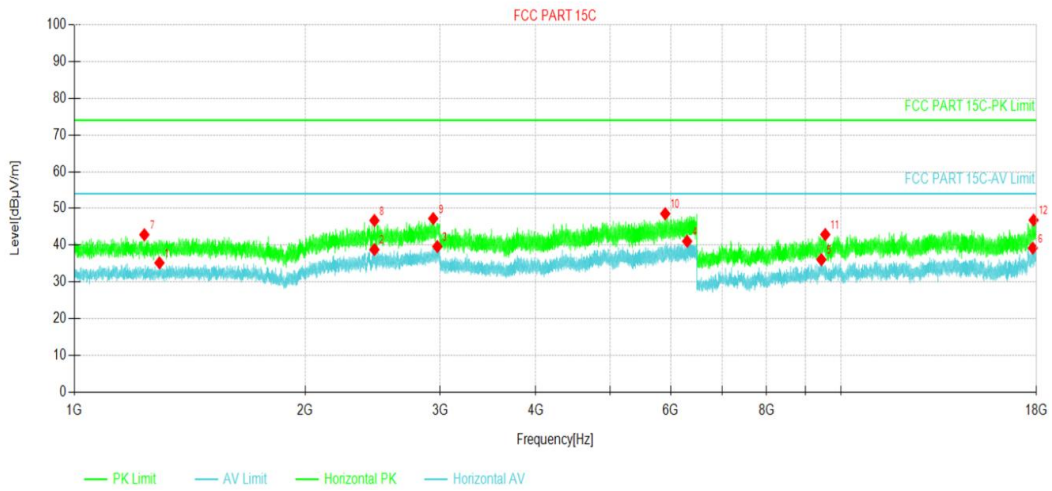

Suspected Data List

NO.	Freq. [MHz]	Reading [dBµV/m]	Level [dBµV/m]	Factor [dB]	Limit [dBµV/m]	Margin [dB]	Polarity	Verdict
1	1291.2	32.85	35.20	2.35	54.00	18.80	Horizontal	PASS
2	2463	31.36	38.82	7.46	54.00	15.18	Horizontal	PASS
3	2975.2	29.88	39.64	9.76	54.00	14.36	Horizontal	PASS
4	6301.9	35.18	41.07	5.89	54.00	12.93	Horizontal	PASS
5	9432.5	33.00	36.08	3.08	54.00	17.92	Horizontal	PASS
6	17799.9	26.08	39.21	13.13	54.00	14.79	Horizontal	PASS
7	1234	40.87	42.86	1.99	74.00	31.14	Horizontal	PASS
8	2462.8	39.28	46.74	7.46	74.00	27.26	Horizontal	PASS
9	2939.2	37.80	47.25	9.45	74.00	26.75	Horizontal	PASS
10	5900.45	43.72	48.58	4.86	74.00	25.42	Horizontal	PASS
11	9544.05	39.75	42.91	3.16	74.00	31.09	Horizontal	PASS
12	17844.7	33.80	46.83	13.03	74.00	27.17	Horizontal	PASS

Mode1 /Polarity: Vertical / CH: 78

Test Graph

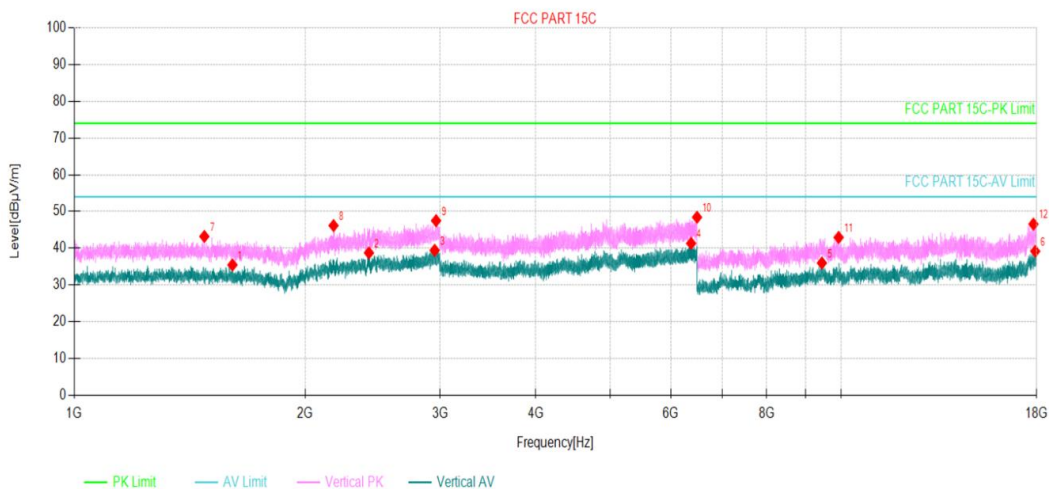

Suspected Data List

NO.	Freq. [MHz]	Reading [dBµV/m]	Level [dBµV/m]	Factor [dB]	Limit [dBµV/m]	Margin [dB]	Polarity	Verdict
1	1608.2	32.21	35.47	3.26	54.00	18.53	Vertical	PASS
2	2423	31.58	38.74	7.16	54.00	15.26	Vertical	PASS
3	2951.8	29.88	39.44	9.56	54.00	14.56	Vertical	PASS
4	6376.1	34.96	41.33	6.37	54.00	12.67	Vertical	PASS
5	9442.85	32.89	35.99	3.10	54.00	18.01	Vertical	PASS
6	17922.9	26.15	39.19	13.04	54.00	14.81	Vertical	PASS
7	1478	40.04	43.21	3.17	74.00	30.79	Vertical	PASS
8	2178.6	40.20	46.18	5.98	74.00	27.82	Vertical	PASS
9	2964.2	37.84	47.51	9.67	74.00	26.49	Vertical	PASS
10	6490.55	41.91	48.44	6.53	74.00	25.56	Vertical	PASS
11	9931.6	39.56	42.95	3.39	74.00	31.05	Vertical	PASS
12	17826.3	33.51	46.58	13.07	74.00	27.42	Vertical	PASS

6. TEST SETUP PHOTOS

Conducted Emission at AC power line



Radiated Spurious Emission (Above 1GHz)

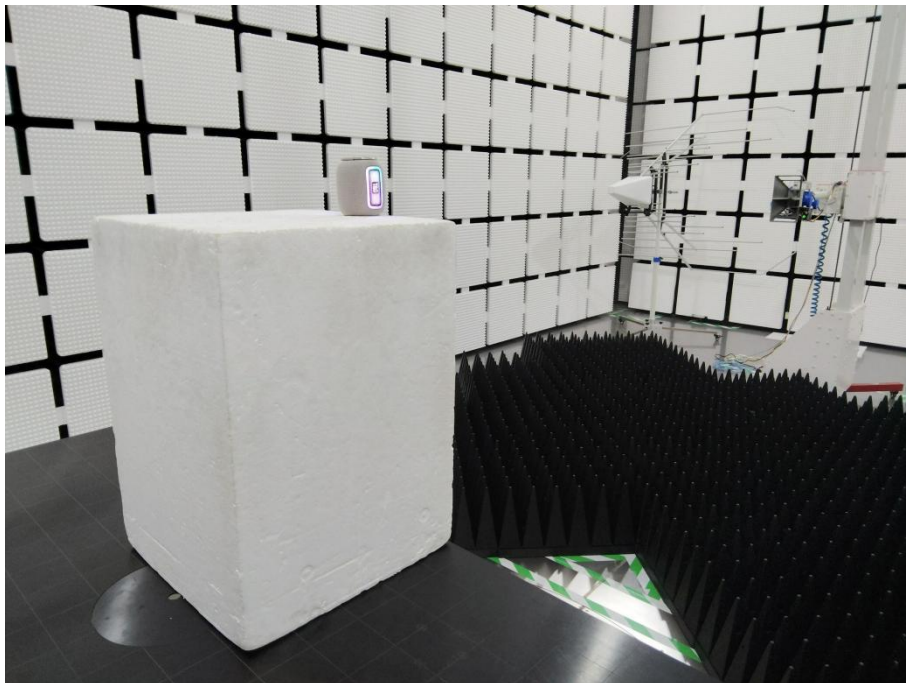

Radiated Spurious Emission (below 1GHz)

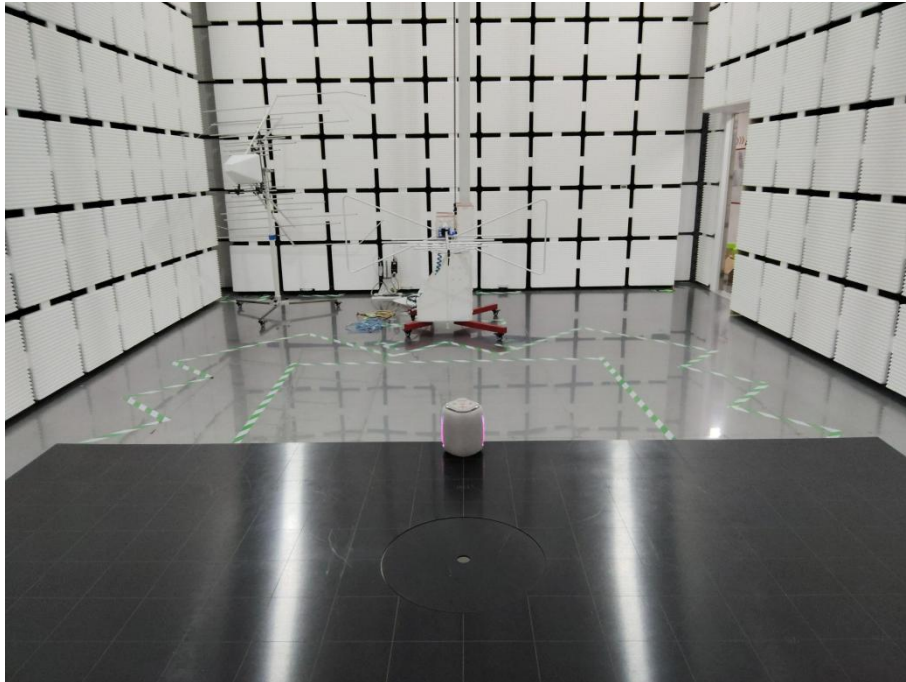

7. EXTERNAL AND INTERNAL PHOTOS

7.1. External Photos

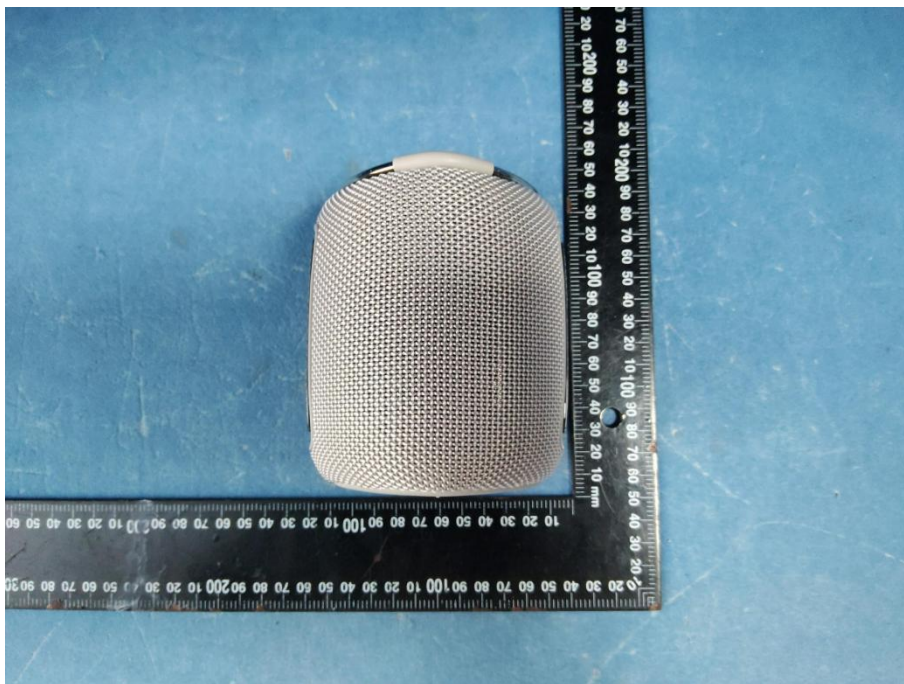







7.2. Internal Photos

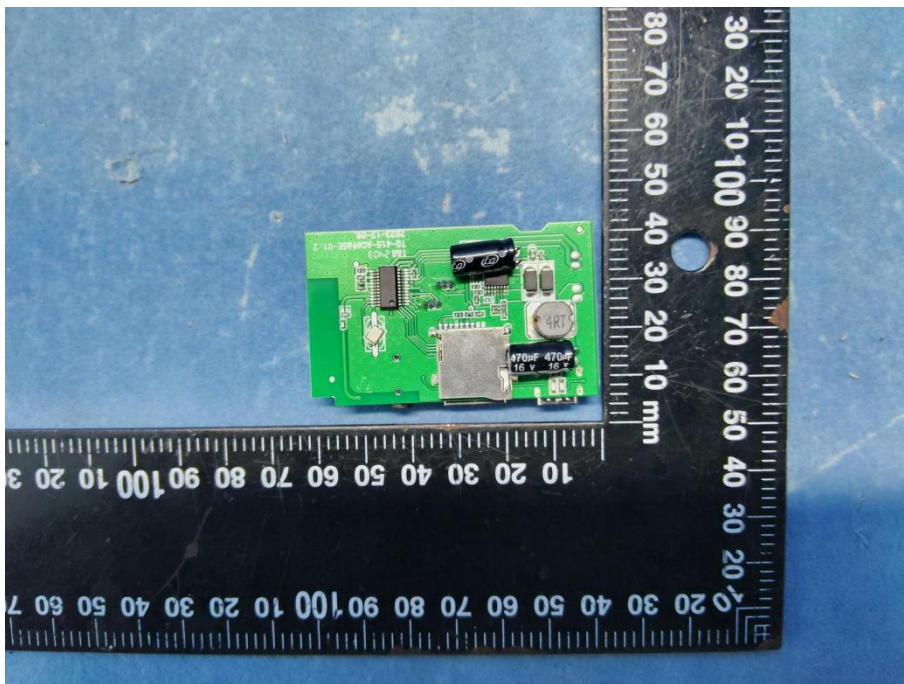
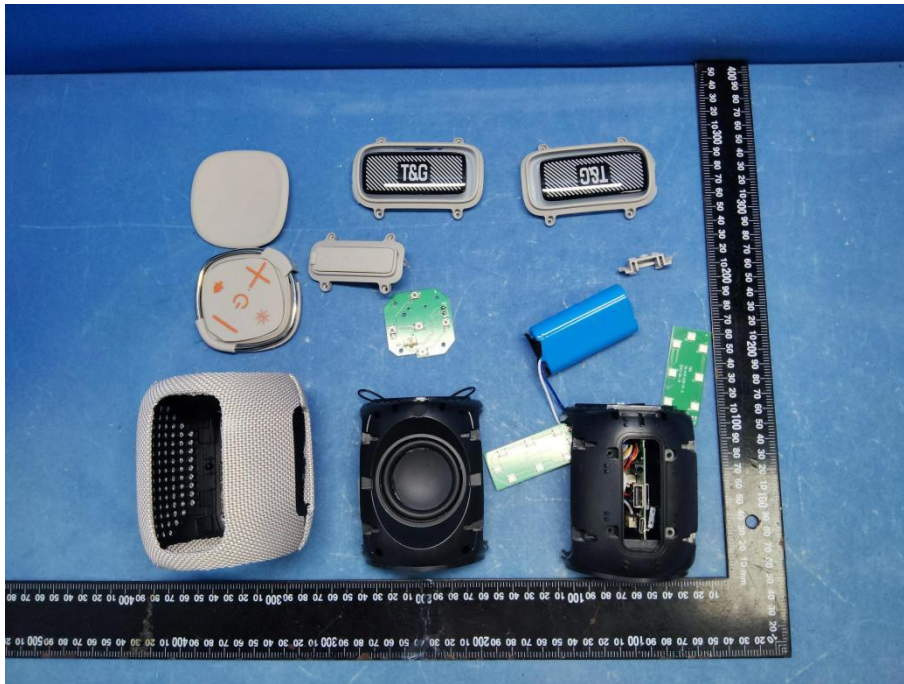

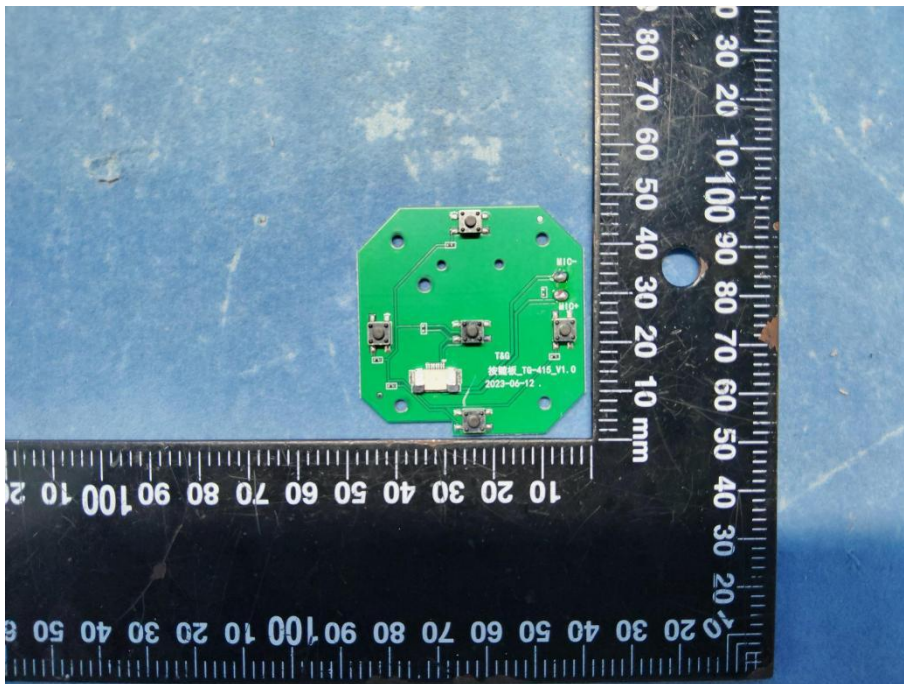
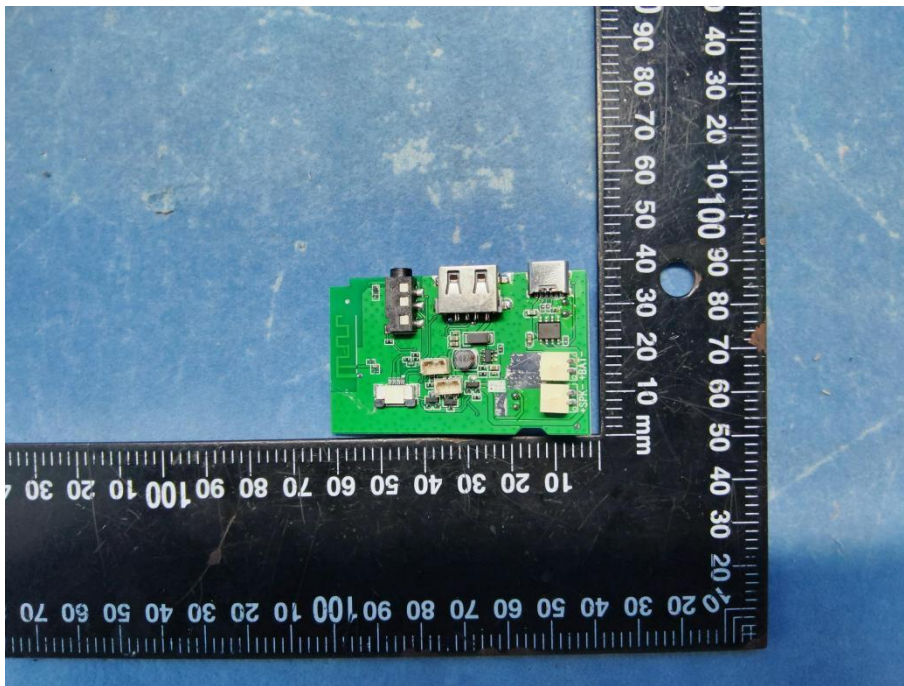

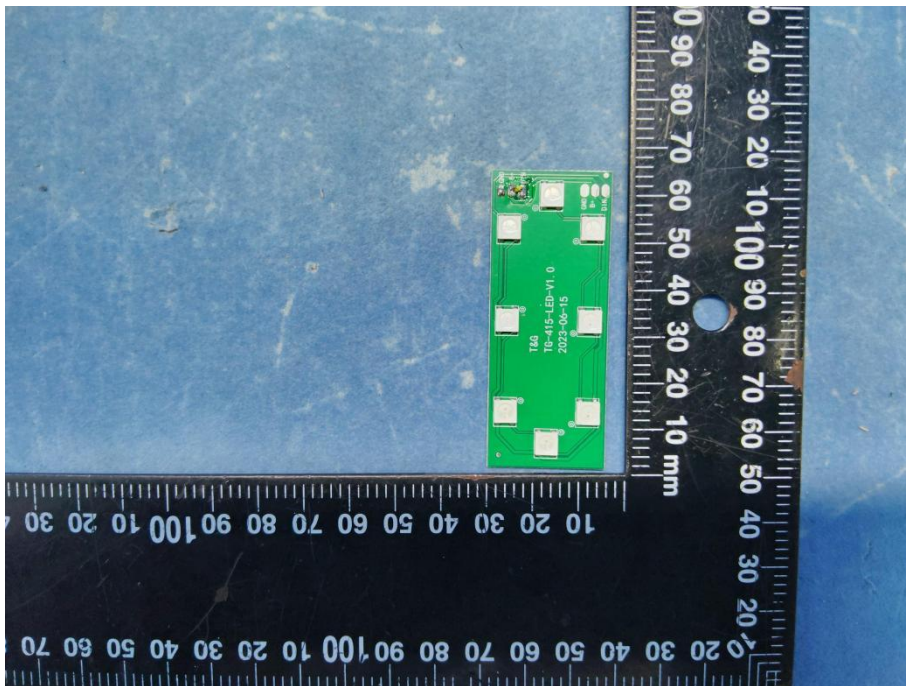

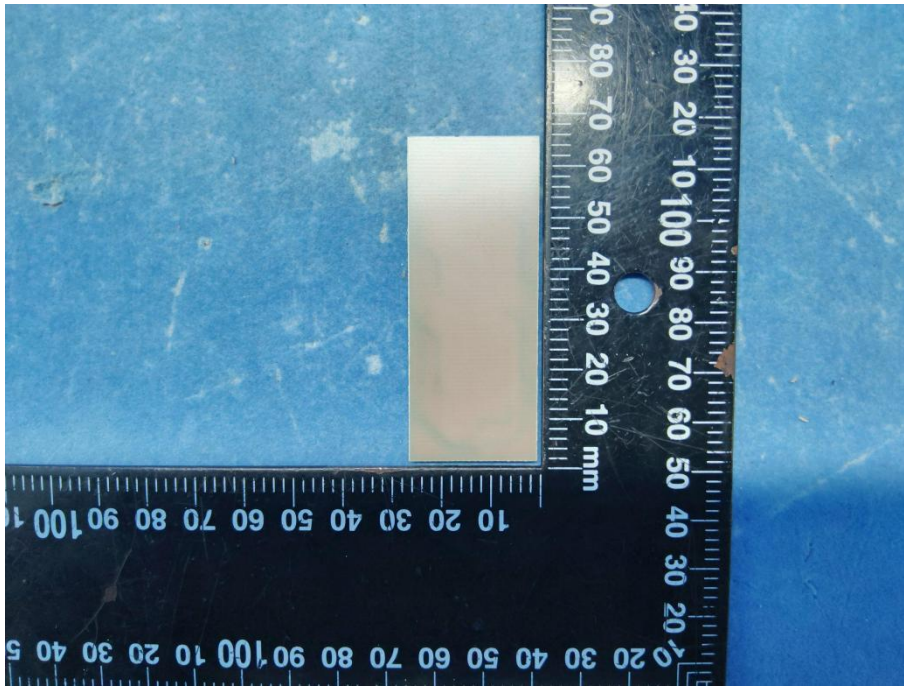

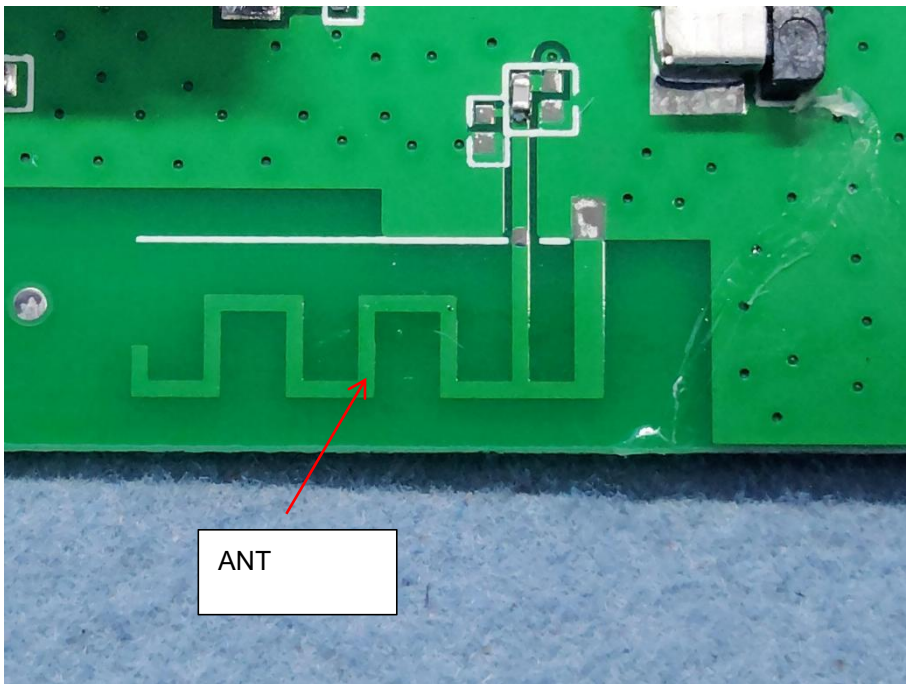
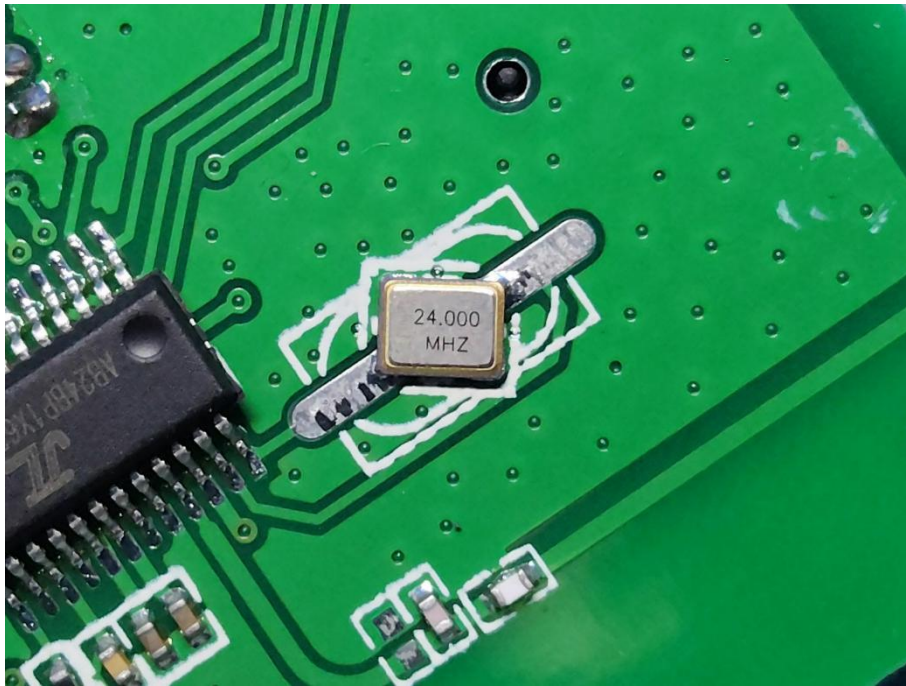

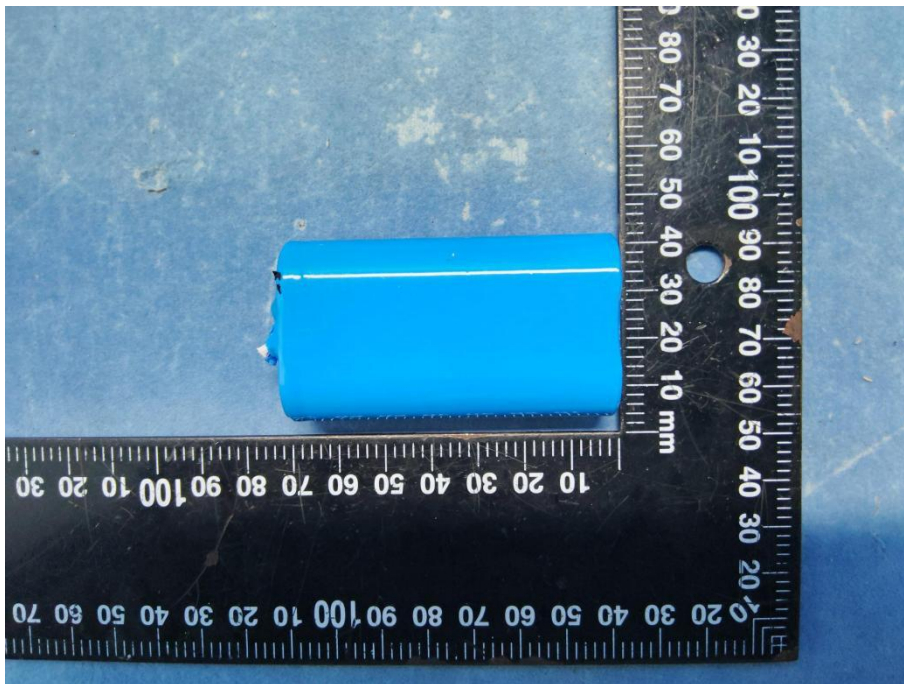
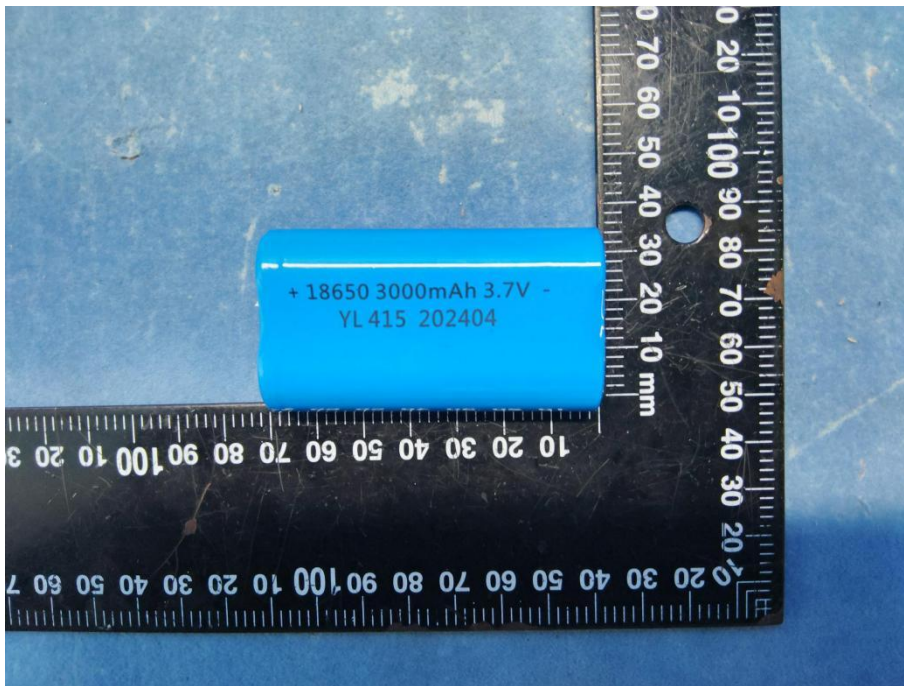

-----End of the report-----