



FCC - TEST REPORT

Report Number : **68.912.24.0029.01** Date of Issue: 2024-09-30

Model : **WL432-DB**

Product Type : IoT Gateway

Applicant : Suzhou Inovance Technology Co., Ltd.

Address : No. 52, Tian E Dang Road, Wuzhong District, 215104, Suzhou City,
Jiangsu Province, P.R. China

Manufacturer : Suzhou Inovance Technology Co., Ltd.

Address : No. 52, Tian E Dang Road, Wuzhong District, 215104, Suzhou City,
Jiangsu Province, P.R. China

Test Result : **Positive** **Negative**

Total pages including Appendices : **63**

Any use for advertising purposes must be granted in writing. This technical report may only be quoted in full. This report is the result of a single examination of the object in question and is not generally applicable evaluation of the quality of other products in regular production. For further details, please see testing and certification regulation chapter A-3.4.



1 Table of Contents

1	Table of Contents	2
2	Details about the Test Laboratory	3
3	Description of the Equipment under Test.....	4
4	Summary of Test Standards	5
5	Summary of Test Results.....	6
6	General Remarks.....	7
7	Test Setups.....	8
7.1	Radiated test setups	8
7.2	Conducted RF test setups	9
7.3	AC Power Line Conducted Emission test setups.....	9
8	Systems test configuration.....	10
9	Technical Requirement.....	11
9.1	Conducted Emission.....	11
9.2	Conducted output power.....	14
9.3	6dB bandwidth.....	15
9.4	Power spectral density.....	22
9.5	Spurious RF conducted emissions	29
9.6	Band edge	43
9.7	Spurious radiated emissions for transmitter.....	48
10	Test Equipment List	62
11	System Measurement Uncertainty	63

2 Details about the Test Laboratory

Details about the Test Laboratory

Test Site 1

Company name: TÜV SÜD Certification and Testing (China) Co., Ltd. Shenzhen Branch
Building 12 & 13, Zhiheng Wisdomland Business Park,
Guankou Erlu, Nantou, Nanshan District,
Shenzhen, Guangdong, China

Telephone: 86 755 8828 6998

Fax: 86 755 8828 5299

FCC Registration No.: 514049

FCC Designation Number: CN5009

3 Description of the Equipment under Test

Product:	IoT Gateway
Model no.:	WL432-DB
FCC ID:	2BKRZ-WL432EG25G-T
Ratings:	DC 12-24V, 800mA
RF Transmission Frequency:	2412MHz-2462MHz
No. of Operated Channel:	11 for 802.11b/g/n20 9 for n40
Modulation:	802.11b: CCK, DSSS 802.11g/n20/n40: BPSK, QPSK, 16-QAM, 64-QAM
Antenna Type:	Linear antenna
Antenna Gain:	2.53 dBi
Description of the EUT:	The EUT is a IoT Gateway supports 2.4GHz Wi-Fi and GSM/WCDMA/LTE function, the GSM/WCDMA/LTE module has been approved under FCC ID: XMR201903EG25G, grant date: March 29, 2019, this report is for 2.4GHz Wi-Fi only.

NOTE 1: The above EUT's information is declared by manufacturer. Please refer to the specifications or user's manual for more detailed description.

NOTE 2: The EUT has been tested under 12VDC and 24VDC, only the worst case 24VDC test results are listed in the report for RF tests.



4 Summary of Test Standards

Test Standards	
FCC Part 15 Subpart C 10-1-2023 Edition	PART 15 - RADIO FREQUENCY DEVICES Subpart C - Intentional Radiators

All the test methods were according to KDB 558074 D01 15.247 Meas Guidance v05r02 Measurement Guidance and ANSI C63.10-2020.

5 Summary of Test Results

Technical Requirements			
FCC Part 15 Subpart C 10-1-2023 Edition			
Test Condition		Test Result	Test Site
§15.207	Conducted emission AC power port	Pass	Site 1
§15.247 (b) (3)	Conducted output power	Pass	Site 1
§15.247(e)	Power spectral density	Pass	Site 1
§15.247(a)(2)	6dB bandwidth	Pass	Site 1
§15.247(a)(1)	20dB Occupied bandwidth	N/A	--
§15.247(a)(1)	Carrier frequency separation	N/A	--
§15.247(a)(1)(iii)	Number of hopping frequencies	N/A	--
§15.247(a)(1)(iii)	Dwell Time	N/A	--
§15.247(d)	Spurious RF conducted emissions	Pass	Site 1
§15.247(d)	Band edge	Pass	Site 1
§15.247(d) & §15.209 & §15.205	Spurious radiated emissions for transmitter	Pass	Site 1
§15.203	Antenna requirement	Pass See note 1	--

Remark 1: N/A – Not Applicable.

Note 1: The EUT uses a Linear antenna, which gain is 2.53dBi. In accordance to §15.203, it is considered sufficiently to comply with the provisions of this section.



6 General Remarks

Remarks

This submittal(s) (test report) is intended for FCC ID: 2BKRZ-WL432EG25G-T, complies with Section 15.207, 15.209, 15.205, 15.247 of the FCC Part 15 Subpart C rules.

SUMMARY:

All tests according to the regulations cited on page 6 were

■ - Performed

□ - **Not** Performed

The Equipment under Test

■ - **Fulfills** the general approval requirements.

□ - **Does not** fulfill the general approval requirements.

Sample Received Date: 2024-08-30

Testing Start Date: 2024-08-30

Testing End Date: 2024-09-19

- TÜV SÜD Certification and Testing (China) Co., Ltd. Shenzhen Branch –

Reviewed by:

Prepared by:

Tested by:



Laurent Yuan
Section Manager

Alan Xiong
Project Manger

Carry Cai
Test Engineer

7 Test Setups

7.1 Radiated test setups

9kHz - 30MHz

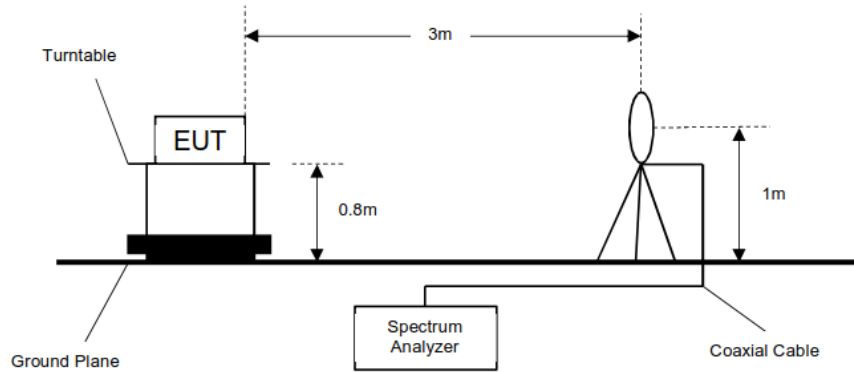

Below 1GHz

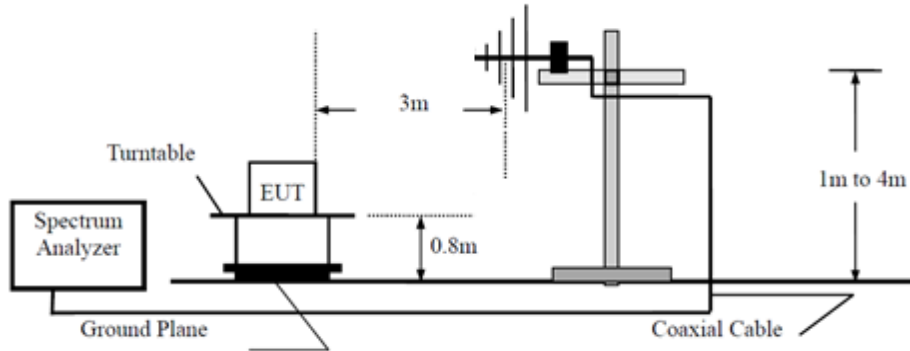

Above 1GHz

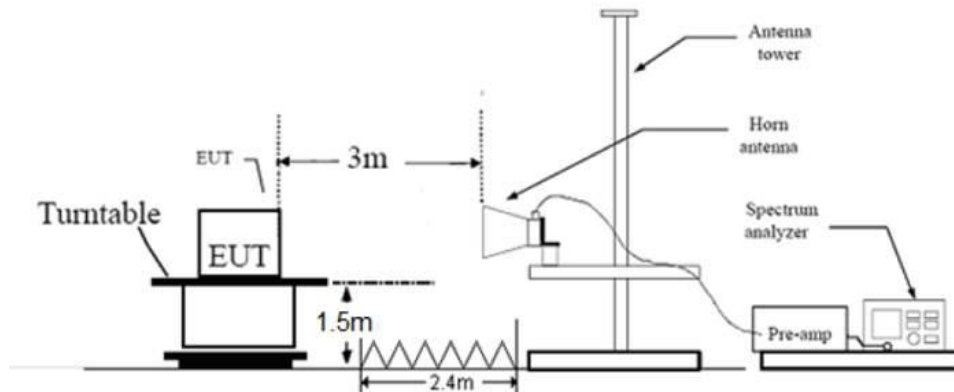

7.2 Conducted RF test setups

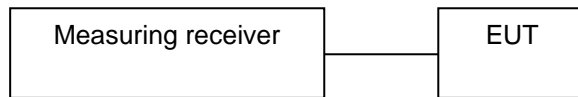

7.3 AC Power Line Conducted Emission test setups

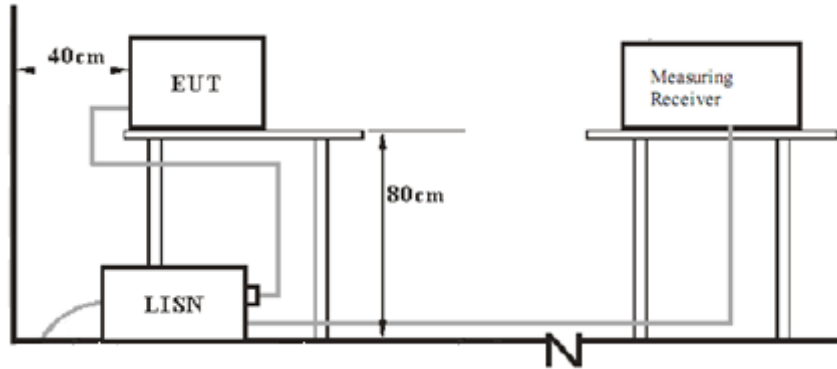

8 Systems test configuration

Auxiliary Equipment Used during Test:

DESCRIPTION	MANUFACTURER	MODEL NO.	S/N
LAPTOP	LENOVO	X240	L34015282

The system was configured to channel 1, 6, and 11 for 802.11b/g/n20 and 3, 6 and 9 for n40.

Test Software Information:

Test Software Version	Telnet	
Mode	Setting TX Power	Packet Type
802.11b	Default	11b 1 Mbps
802.11g	Default	11g 6 Mbps
802.11n HT20	Default	MCS0 6.5 Mbps
802.11n HT40	Default	MCS0 13.5 Mbps

9 Technical Requirement

9.1 Conducted Emission

Test Method

1. The EUT was placed 0.4 meter from the conducting wall of the shielding room was kept at least 80 centimeters from any other grounded conducting surface.
2. Connect EUT to the power mains through a line impedance stabilization network (LISN).
3. All the support units are connecting to the other LISN.
4. The LISN provides 50 ohm coupling impedance for the measuring instrument.
5. Both sides of AC line were checked for maximum conducted interference.
6. The frequency range from 150 kHz to 30 MHz was searched.
7. Set the test-receiver system to Peak Detect Function and specified bandwidth (IF Bandwidth = 9kHz) with Maximum Hold Mode. Then measurement is also conducted by Average Detector and Quasi-Peak Detector Function respectively.

Limit

According to §15.207, conducted emissions limit as below:

Frequency MHz	QP Limit dB μ V	AV Limit dB μ V
0.150-0.500	66-56*	56-46*
0.500-5	56	46
5-30	60	50

*Decreasing linearly with logarithm of the frequency

Conducted Emission

Product Type : IoT Gateway
 M/N : WL432-DB
 Operating Condition : WIFI transmission
 Test Specification : Power Line, Positive
 Comment : 24VDC

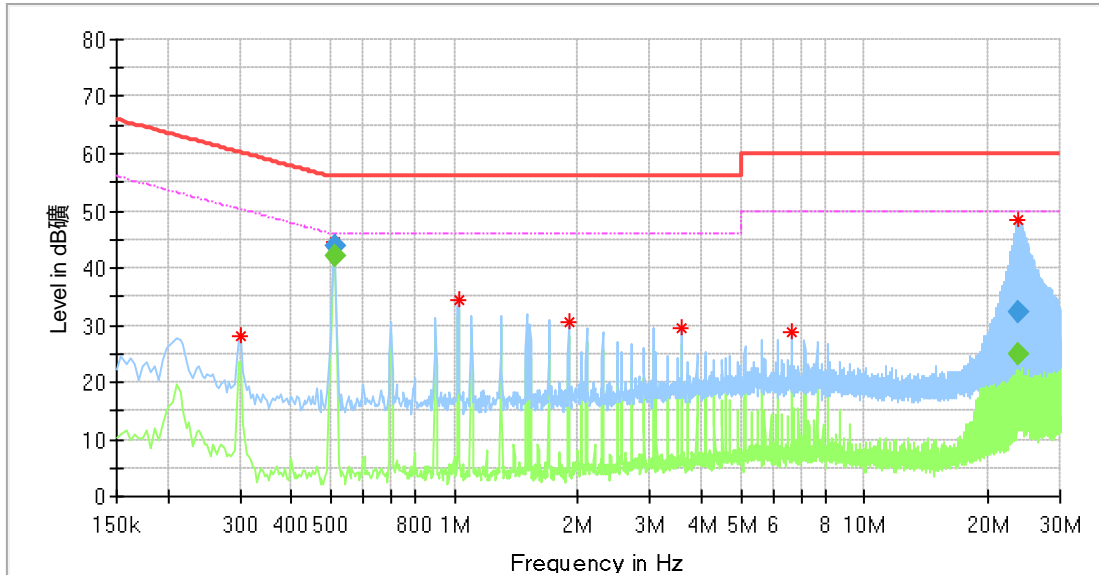

Critical Freqs

Frequency (MHz)	MaxPeak (dBµV)	Average (dBµV)	Limit (dBµV)	Margin (dB)	Line	Corr. (dB)
0.302000	28.17	---	60.19	32.02	L1	10.31
0.509500	44.61	---	56.00	11.39	L1	10.31
1.022000	34.25	---	56.00	21.75	L1	10.32
1.898000	30.37	---	56.00	25.63	L1	10.36
3.570000	29.33	---	56.00	26.67	L1	10.41
6.634000	28.87	---	60.00	31.13	L1	10.53
23.754500	48.33	---	60.00	11.67	L1	12.12

Final Result

Frequency (MHz)	QuasiPeak (dBµV)	Average (dBµV)	Limit (dBµV)	Margin (dB)	Line	Corr. (dB)
0.509500	---	42.08	46.00	3.92	L1	10.31
0.509500	43.92	---	56.00	12.08	L1	10.31
23.754500	---	24.91	50.00	25.09	L1	12.12
23.754500	32.34	---	60.00	27.66	L1	12.12

Remark:

Level=Reading Level + Correction Factor

Correction Factor=Cable Loss + LISN Factor

(The Reading Level is recorded by software which is not shown in the sheet)

Conducted Emission

Product Type : IoT Gateway
M/N : WL432-DB
Operating Condition : WIFI transmission
Test Specification : Power Line, Negative
Comment : 24VDC

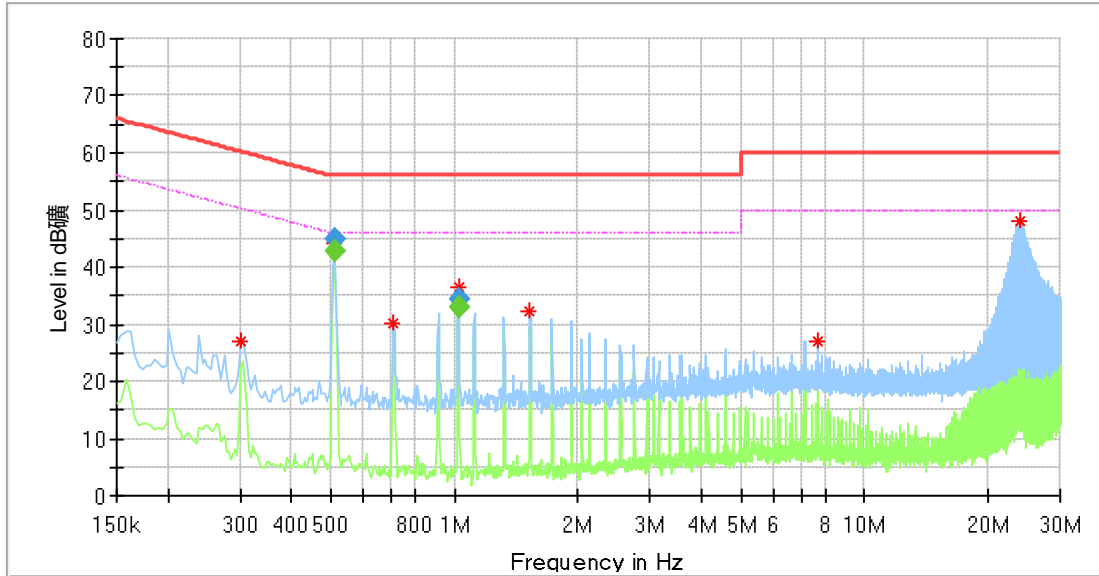

Critical_Freqs

Frequency (MHz)	MaxPeak (dBµV)	Average (dBµV)	Limit (dBµV)	Margin (dB)	Line	Corr. (dB)
0.302000	26.99	---	60.19	33.19	N	10.33
0.509500	44.25	---	56.00	11.75	N	10.34
0.710000	30.28	---	56.00	25.72	N	10.34
1.021500	36.53	---	56.00	19.47	N	10.36
1.530000	32.17	---	56.00	23.83	N	10.39
7.658000	27.05	---	60.00	32.95	N	10.74
23.822000	48.24	---	60.00	11.76	N	11.90

Final_Result

Frequency (MHz)	QuasiPeak (dBµV)	Average (dBµV)	Limit (dBµV)	Margin (dB)	Line	Corr. (dB)
0.509500	44.92	---	56.00	11.08	N	10.34
0.509500	---	42.77	46.00	3.23	N	10.34
1.021500	---	32.81	46.00	13.19	N	10.36
1.021500	34.52	---	56.00	21.48	N	10.36

Remark:

Level=Reading Level + Correction Factor

Correction Factor=Cable Loss + LISN Factor

(The Reading Level is recorded by software which is not shown in the sheet)

9.2 Conducted output power

Test Method

- 1) The EUT is configured to transmit continuously, or to transmit with a constant duty cycle.
- 2) At all times when the EUT is transmitting, it shall be transmitting at its maximum power control level.
- 3) The integration period of the power meter exceeds the repetition period of the transmitted signal by at least a factor of five.
- 4) Measure the peak power of the transmitter. This measurement is a peak over both the ON and OFF periods of the transmitter.

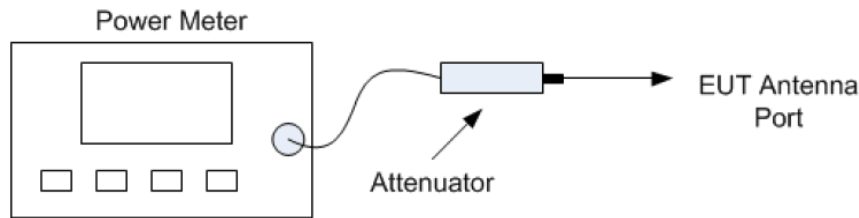

Power meter conducted test setup

Limits

According to §15.247 (b) (3), conducted output power limit as below:

Frequency Range MHz	Limit W	Limit dBm
2400-2483.5	≤1	≤30

Test results

Mode	TX Type	Frequency (MHz)	Maximum Peak Conducted Output Power (dBm)		Verdict
			ANT1	Limit	
802.11b	SISO	2412	18.48	≤30	Pass
		2437	18.44	≤30	Pass
		2462	18.03	≤30	Pass
802.11g	SISO	2412	17.96	≤30	Pass
		2437	18.09	≤30	Pass
		2462	17.84	≤30	Pass
802.11n (HT20)	SISO	2412	17.63	≤30	Pass
		2437	17.73	≤30	Pass
		2462	17.44	≤30	Pass
802.11n (HT40)	SISO	2422	16.26	≤30	Pass
		2437	16.32	≤30	Pass
		2452	16.25	≤30	Pass

9.3 6dB bandwidth

Test Method

1. The RF output of EUT was connected to the spectrum analyzer. The path loss was compensated to the results for each measurement.
2. Set to the maximum power setting, the instrument center frequency is set to the nominal EUT channel center frequency enable the EUT transmit continuously.
3. Use the following spectrum analyzer settings:
RBW=1% to 5% of the occupied bandwidth but not less than 100kHz, VBW \geq 3RBW, Sweep = auto, Detector function = peak, Trace = max hold
4. Use the automatic bandwidth measurement capability of an instrument, use the X dB bandwidth mode with X set to 6 dB.
5. Allow the trace to stabilize, record the 6 dB Bandwidth value.

Limit

Limit [kHz]

≥500

Test results

Mode	TX Type	Frequency (MHz)	ANT	6dB Bandwidth (MHz)		Verdict
				Result	Limit	
802.11b	SISO	2412	1	10.286	≥0.5	Pass
		2437	1	10.275	≥0.5	Pass
		2462	1	10.284	≥0.5	Pass
802.11g	SISO	2412	1	15.359	≥0.5	Pass
		2437	1	15.540	≥0.5	Pass
		2462	1	15.421	≥0.5	Pass
802.11n (HT20)	SISO	2412	1	15.823	≥0.5	Pass
		2437	1	15.753	≥0.5	Pass
		2462	1	15.489	≥0.5	Pass
802.11n (HT40)	SISO	2422	1	34.139	≥0.5	Pass
		2437	1	34.766	≥0.5	Pass
		2452	1	34.848	≥0.5	Pass

Test Graphs

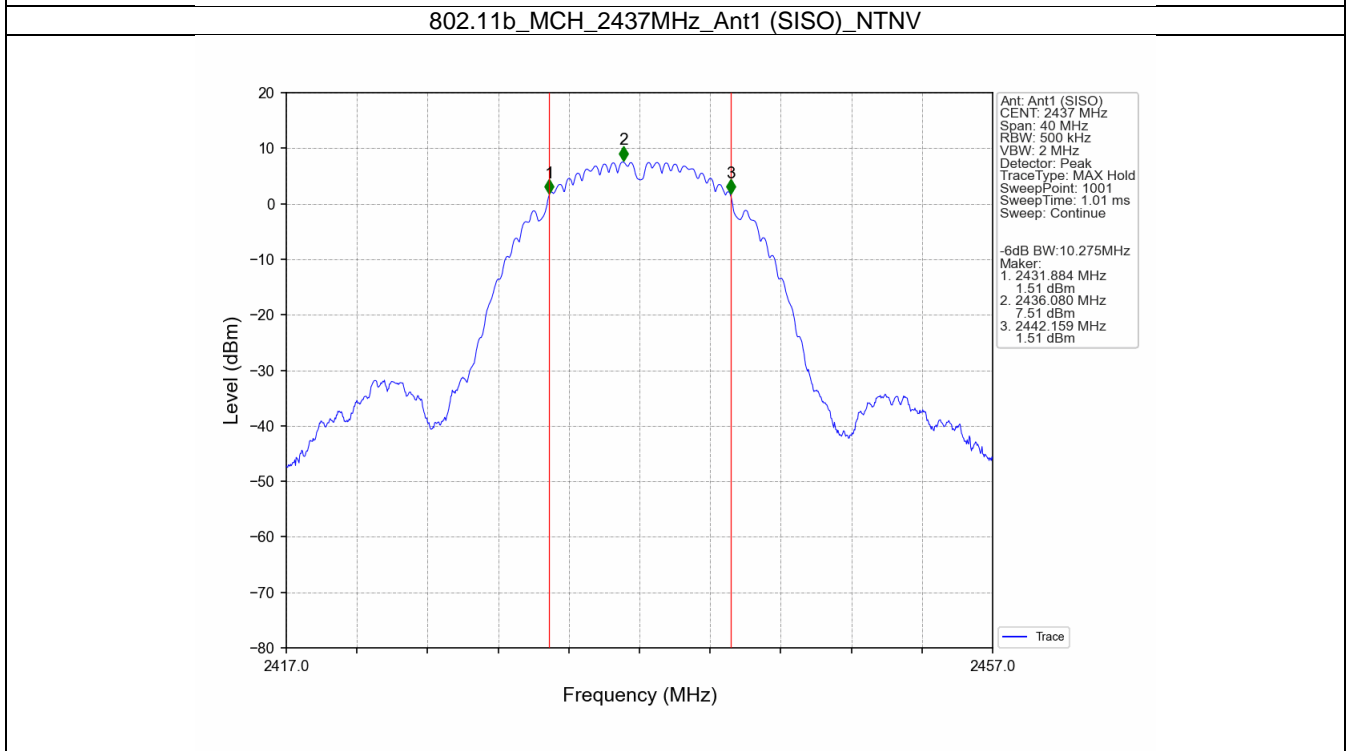
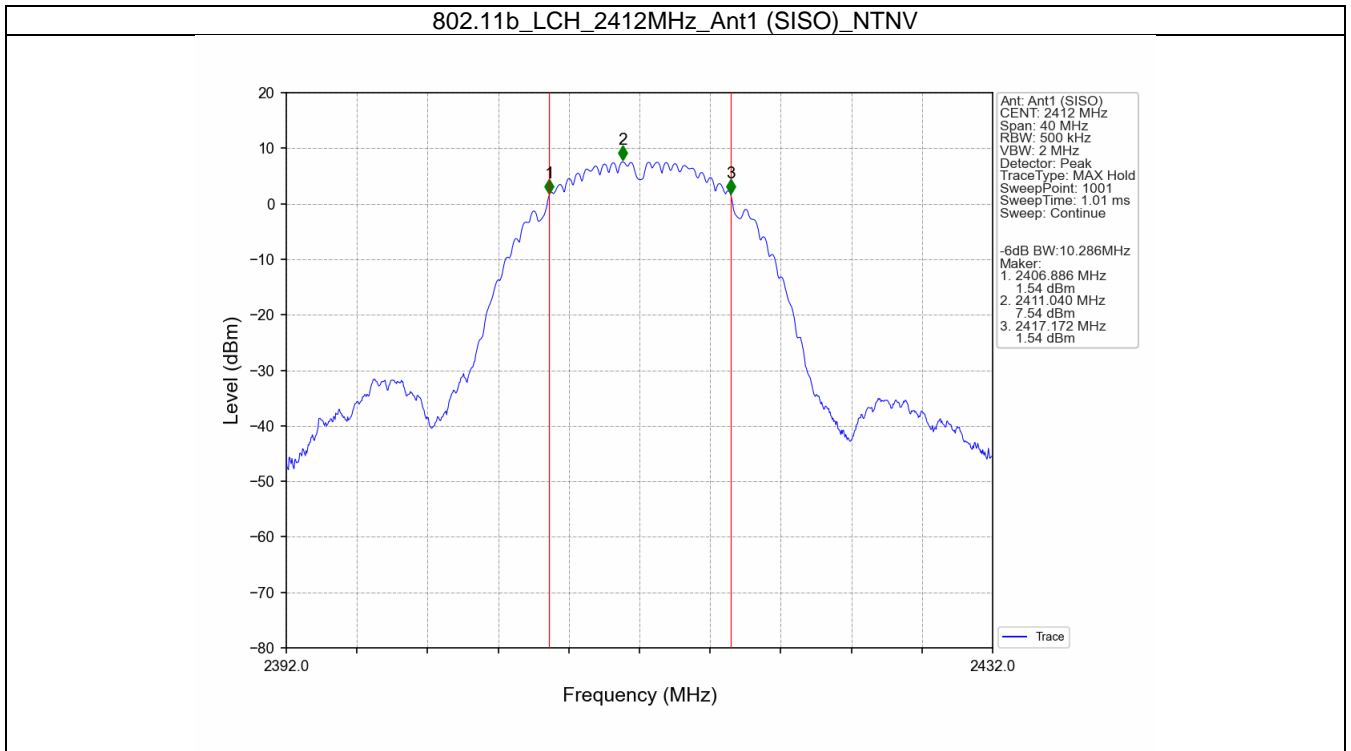

802.11b_HCH_2462MHz_Ant1 (SISO)_NTNV

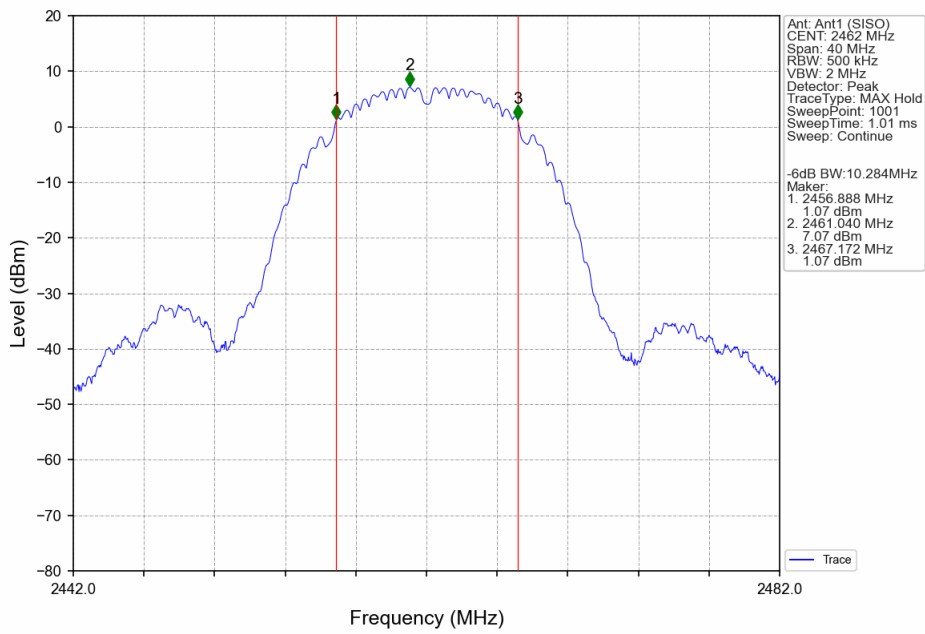

802.11g_LCH_2412MHz_Ant1 (SISO)_NTNV

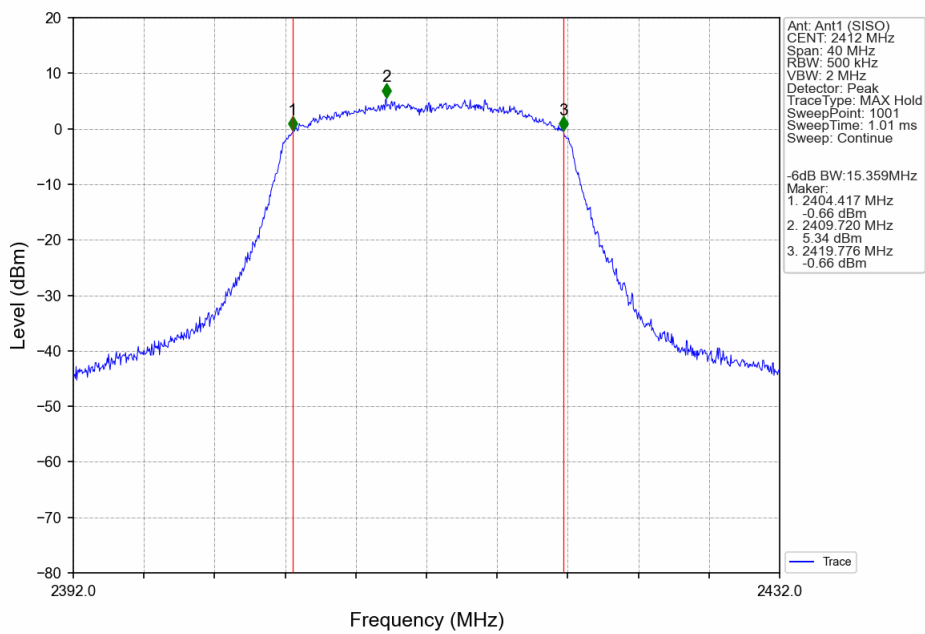

802.11g_MCH_2437MHz_Ant1 (SISO)_NTNV

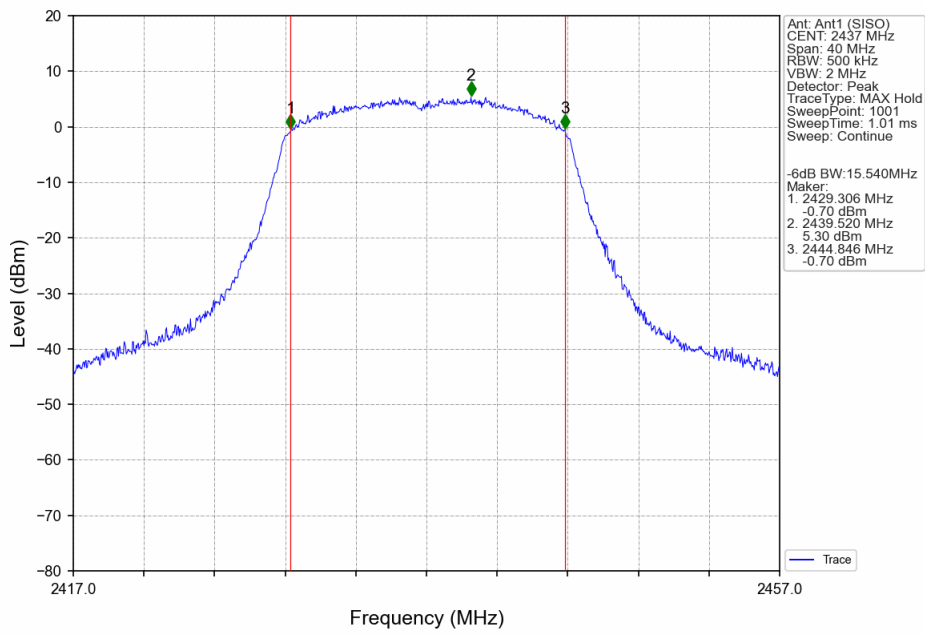

802.11g_HCH_2462MHz_Ant1 (SISO)_NTNV

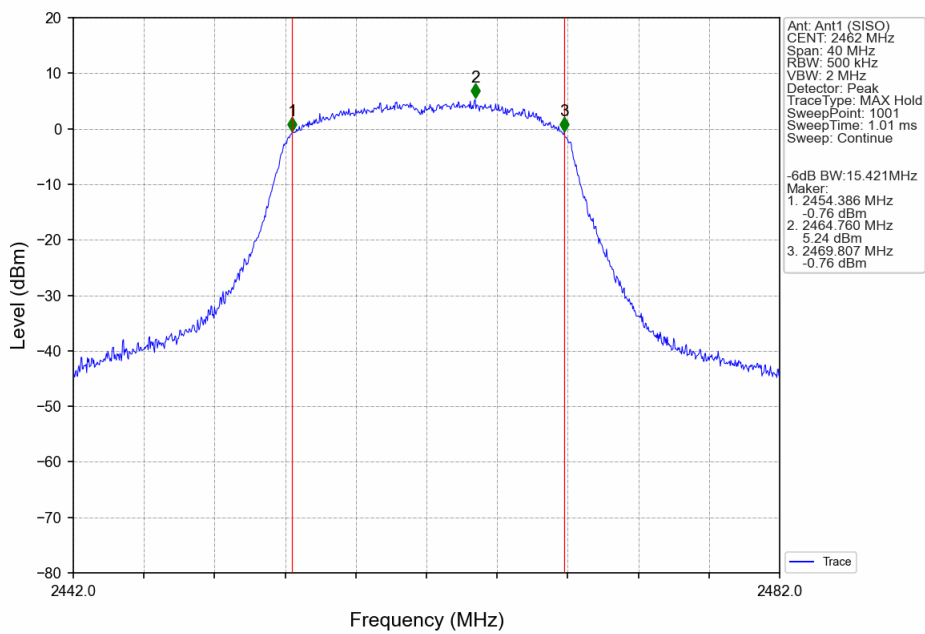



802.11n(HT20)_LCH_2412MHz_Ant1 (SISO)_NTNV

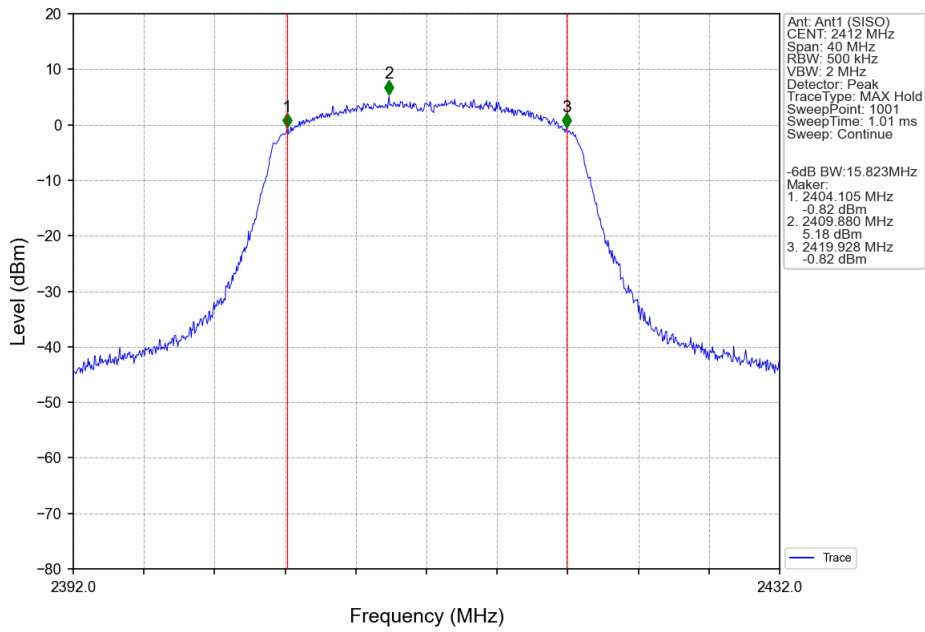

802.11n(HT20)_MCH_2437MHz_Ant1 (SISO)_NTNV

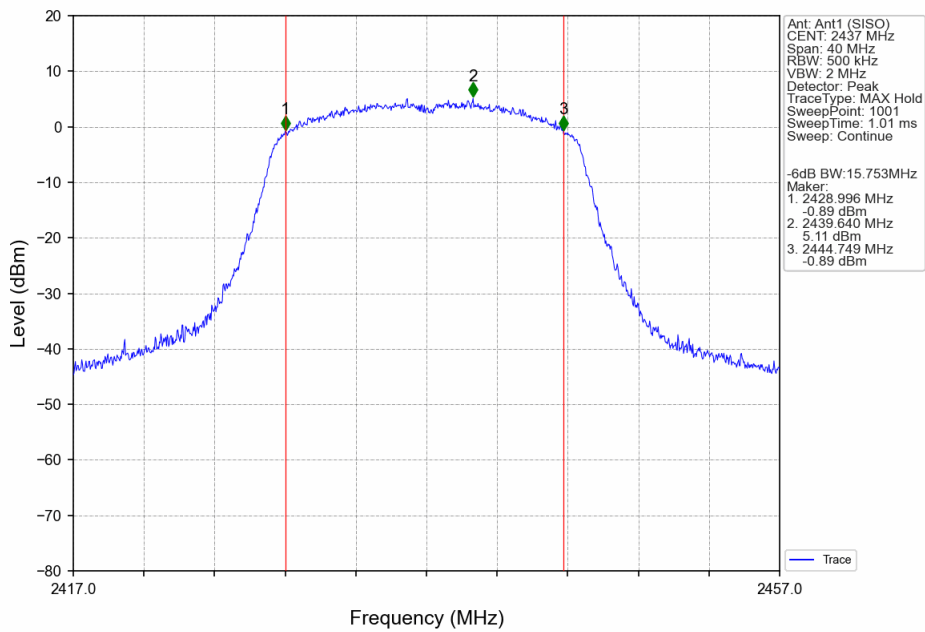



802.11n(HT20)_HCH_2462MHz_Ant1 (SISO)_NTNV

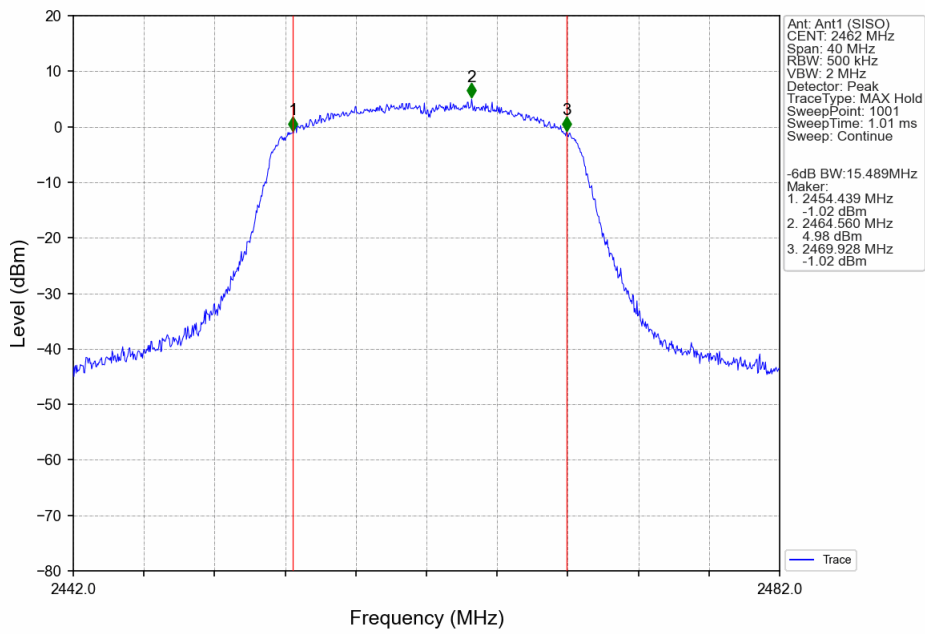

802.11n(HT40)_LCH_2422MHz_Ant1 (SISO)_NTNV

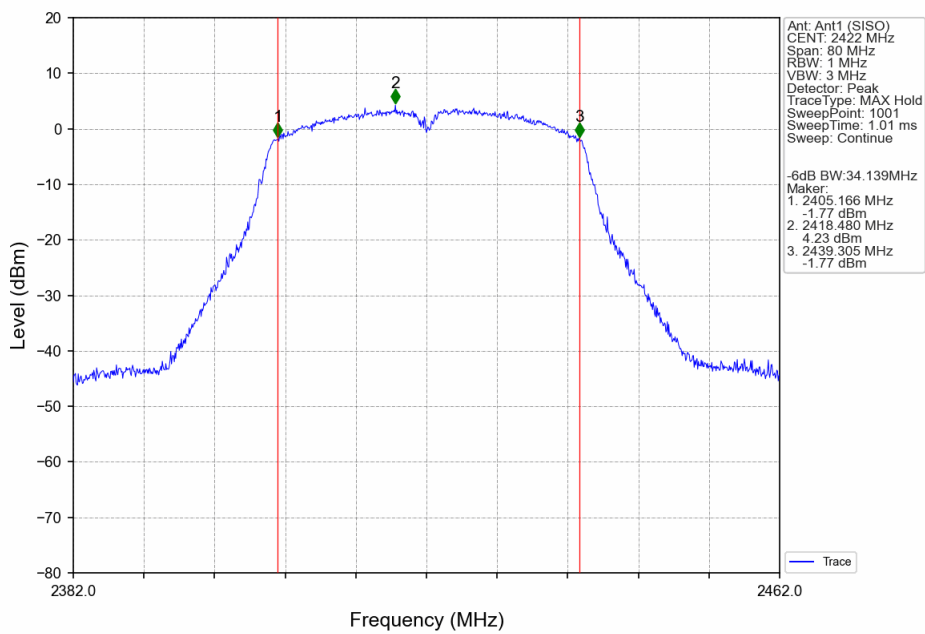



802.11n(HT40)_MCH_2437MHz_Ant1 (SISO)_NTNV

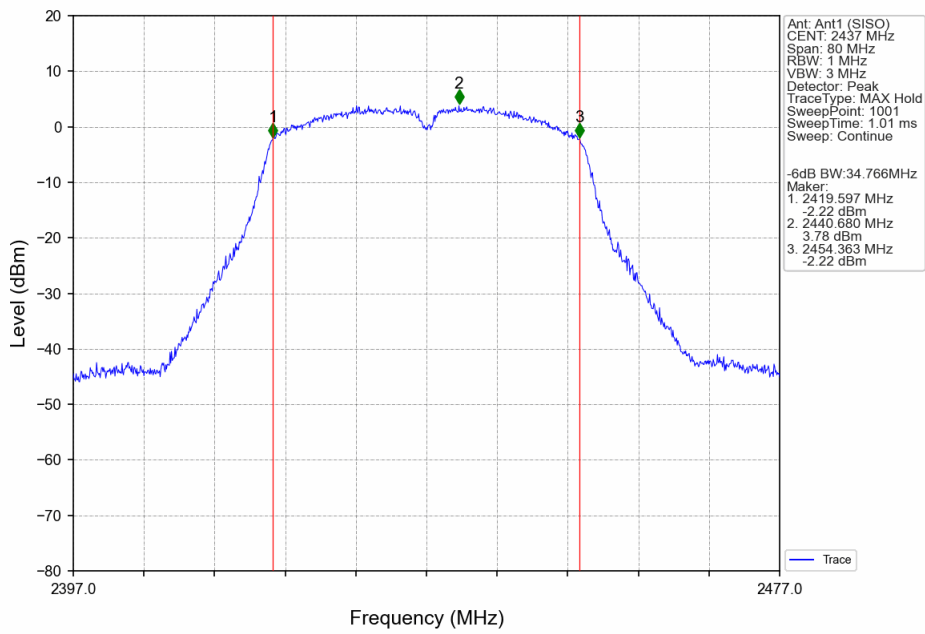

802.11n(HT40)_HCH_2452MHz_Ant1 (SISO)_NTNV

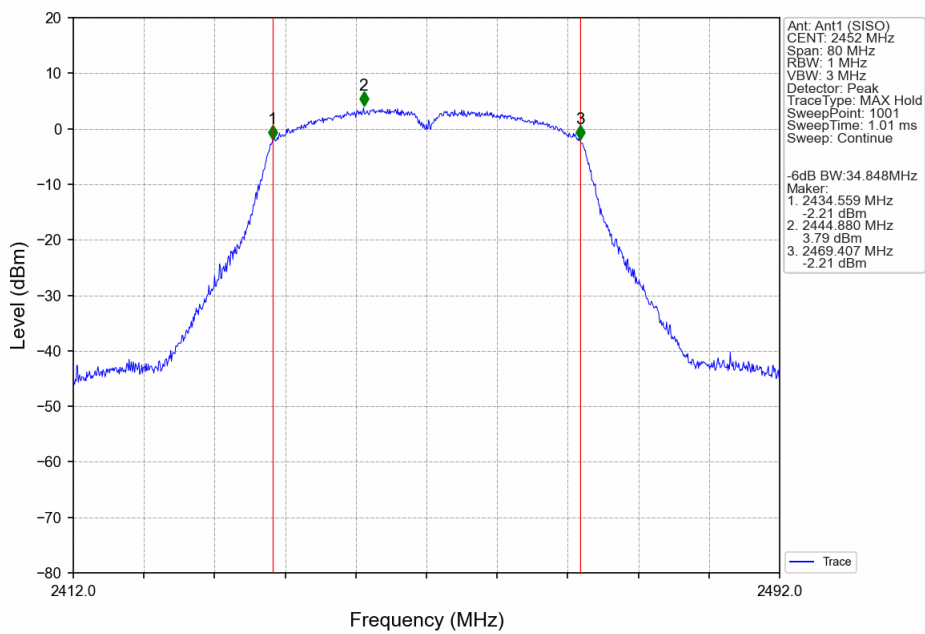

9.4 Power spectral density

Test Method

This procedure shall be used if maximum peak conducted output power was used to demonstrate compliance:

1. The RF output of EUT was connected to the spectrum analyzer. The path loss was compensated to the results for each measurement.
2. Set to the maximum power setting, the instrument center frequency is set to the nominal EUT channel center frequency enable the EUT transmit continuously.
3. Use the following spectrum analyzer settings:
4. Set analyzer center frequency to DTS channel center frequency. RBW=3kHz, VBW \geq 3RBW, Span=1.5 times DTS bandwidth, Detector=Peak, Sweep=auto, Trace= max hold.
5. Allow trace to fully stabilize, use the peak marker function to determine the maximum amplitude level within the RBW.
6. Repeat above procedures until other frequencies measured were completed.

Limit

Limit [dBm/3kHz]

≤8

Test results

Mode	TX Type	Frequency (MHz)	Maximum PSD (dBm/3kHz)		Verdict
			ANT1	Limit	
802.11b	SISO	2412	-7.44	≤8	Pass
		2437	-7.77	≤8	Pass
		2462	-7.52	≤8	Pass
802.11g	SISO	2412	-14.50	≤8	Pass
		2437	-13.78	≤8	Pass
		2462	-14.73	≤8	Pass
802.11n (HT20)	SISO	2412	-15.32	≤8	Pass
		2437	-15.08	≤8	Pass
		2462	-15.57	≤8	Pass
802.11n (HT40)	SISO	2422	-20.55	≤8	Pass
		2437	-20.00	≤8	Pass
		2452	-20.19	≤8	Pass

Test Graphs

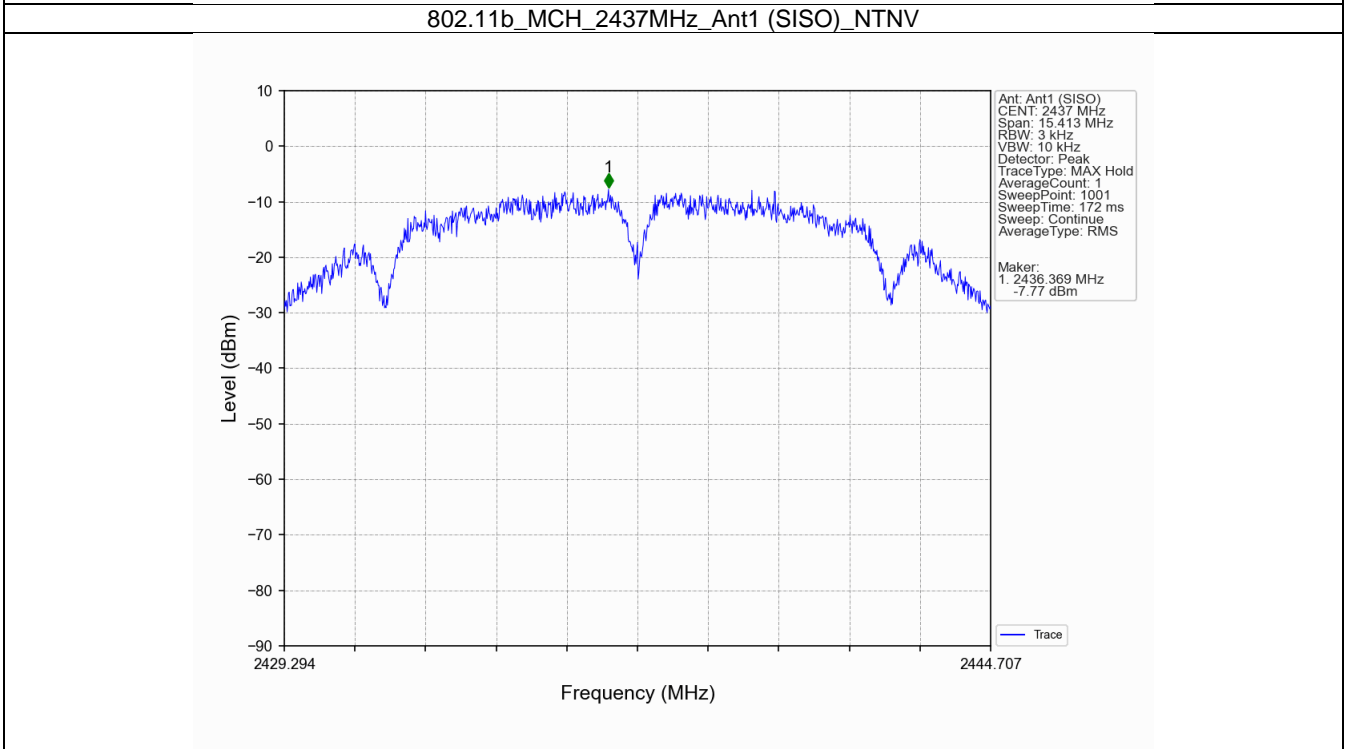
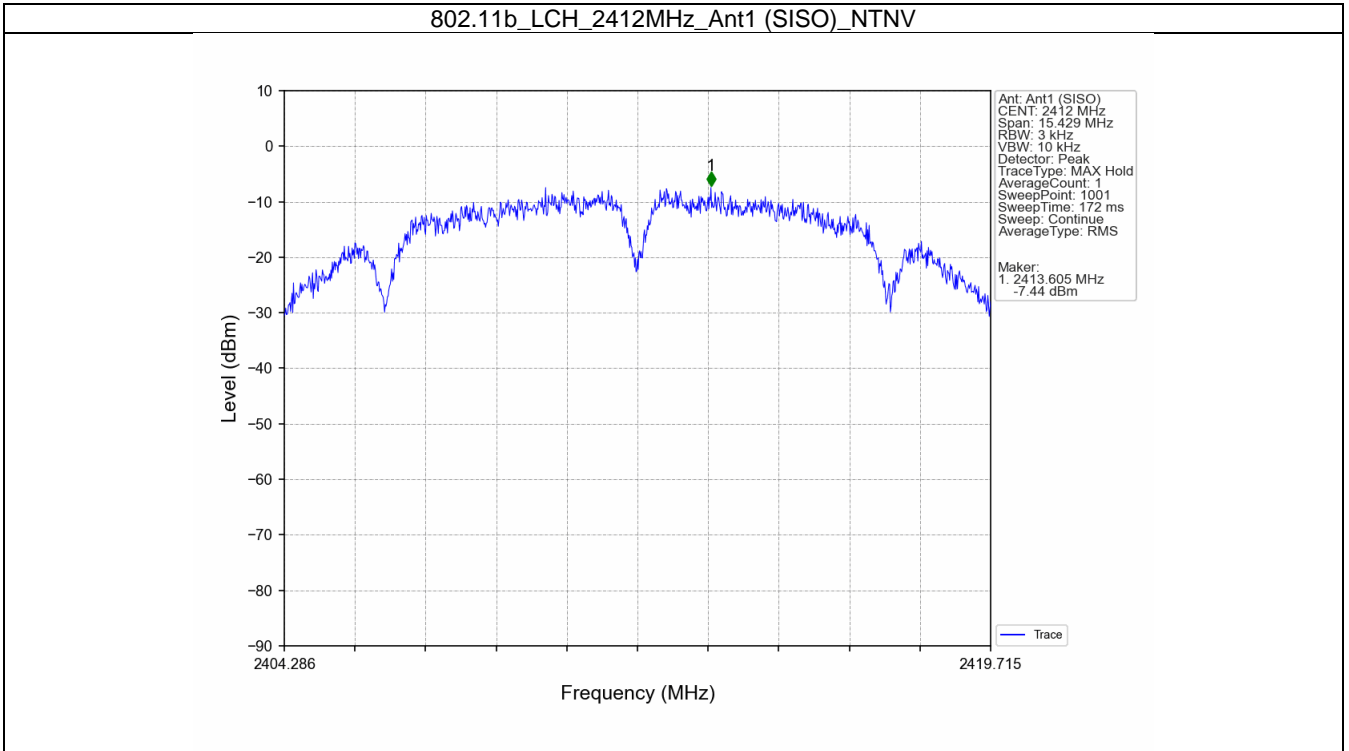

802.11b_HCH_2462MHz_Ant1 (SISO)_NTNV

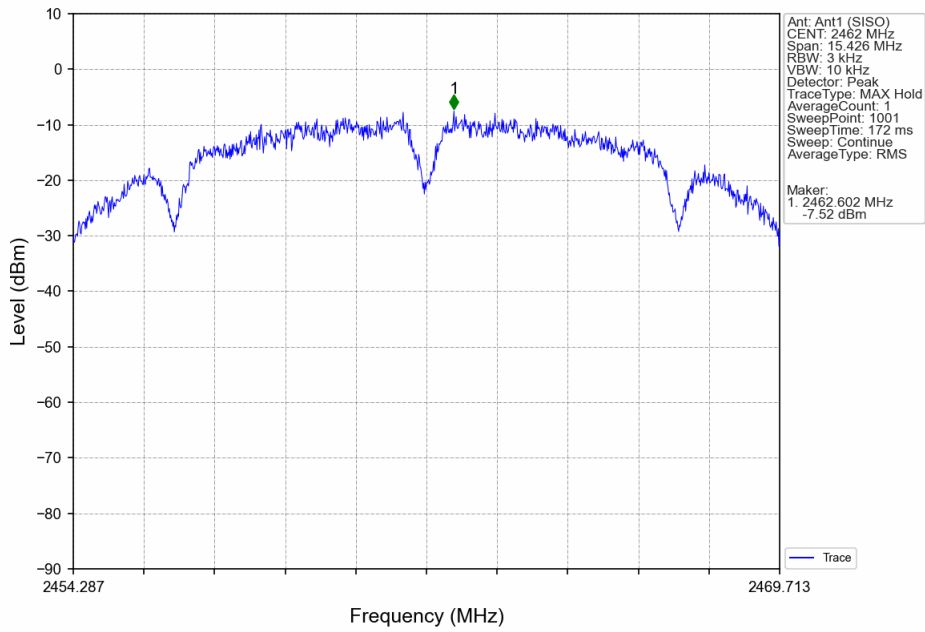

802.11g_LCH_2412MHz_Ant1 (SISO)_NTNV

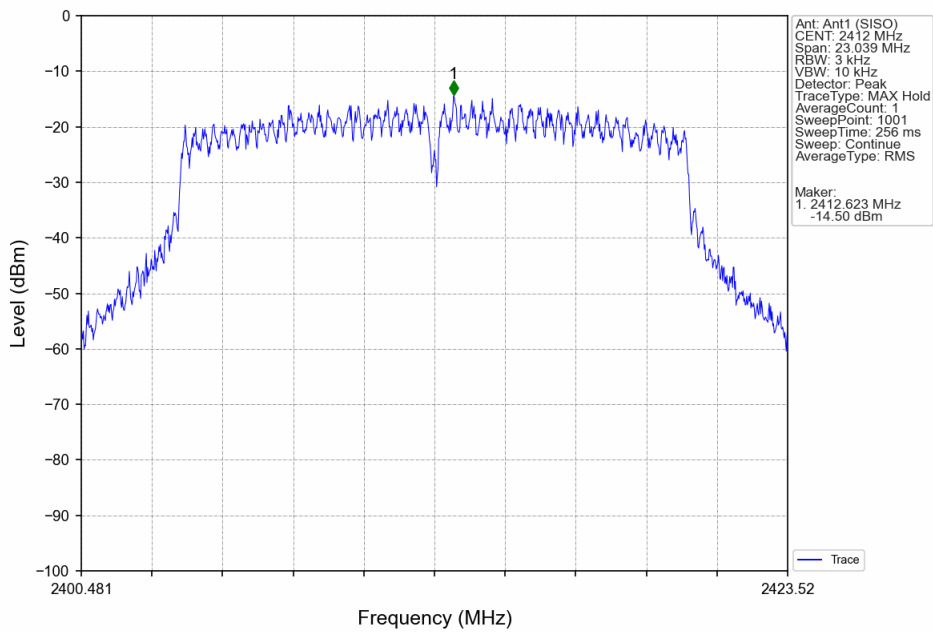

802.11g_MCH_2437MHz_Ant1 (SISO)_NTNV

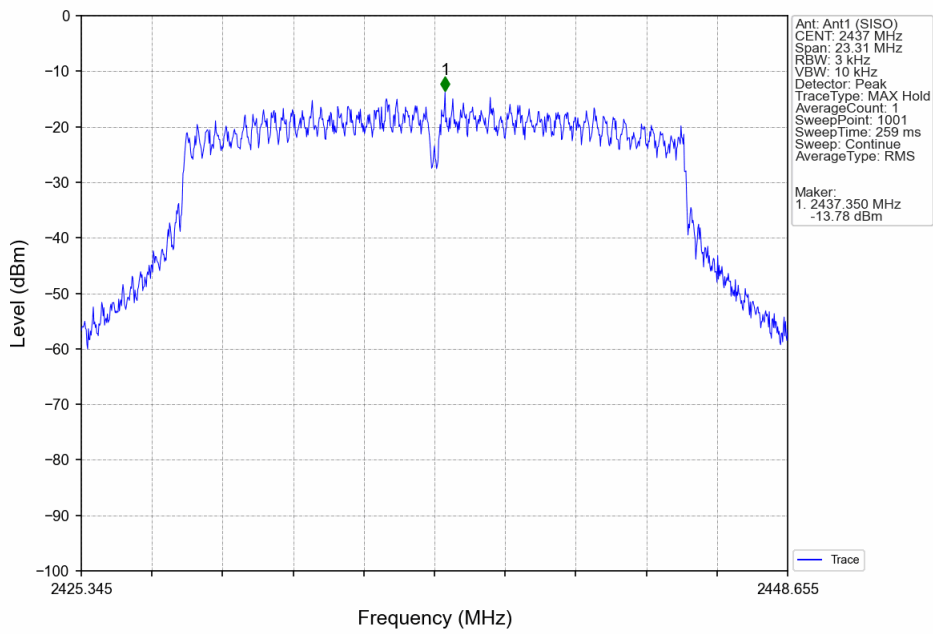

802.11g_HCH_2462MHz_Ant1 (SISO)_NTNV

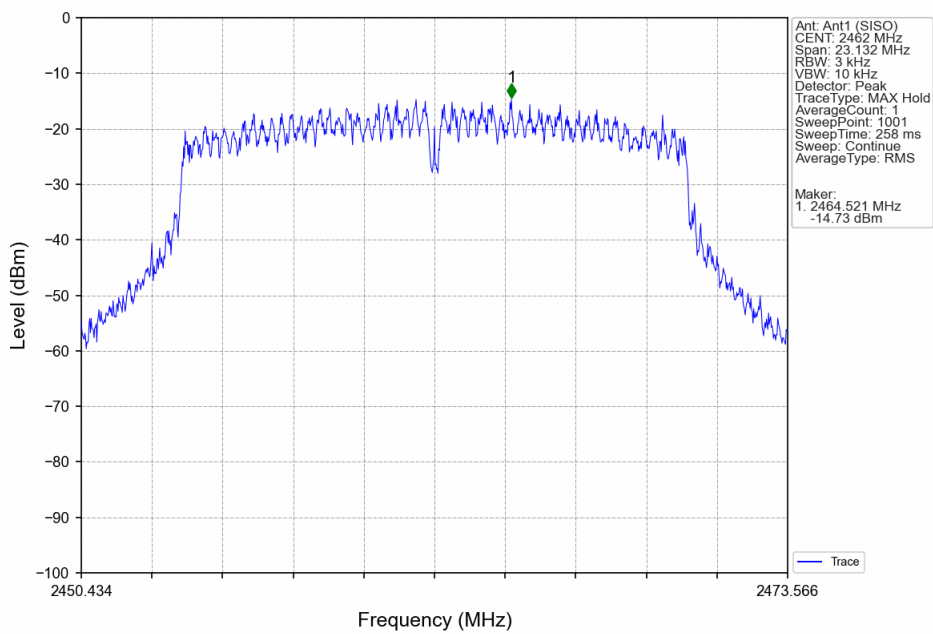



802.11n(HT20)_LCH_2412MHz_Ant1 (SISO)_NTNV

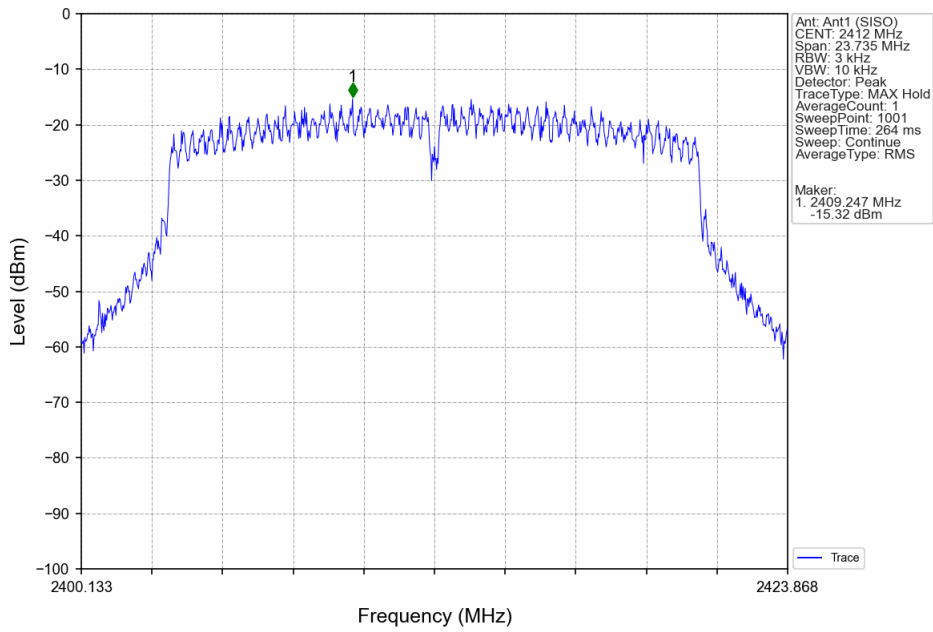

802.11n(HT20)_MCH_2437MHz_Ant1 (SISO)_NTNV

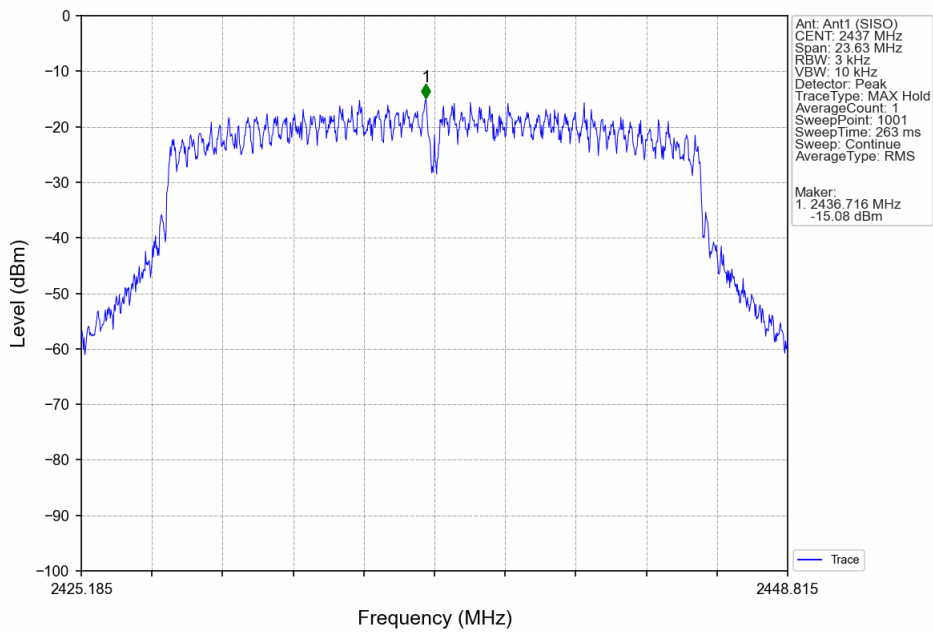



802.11n(HT20)_HCH_2462MHz_Ant1 (SISO)_NTNV

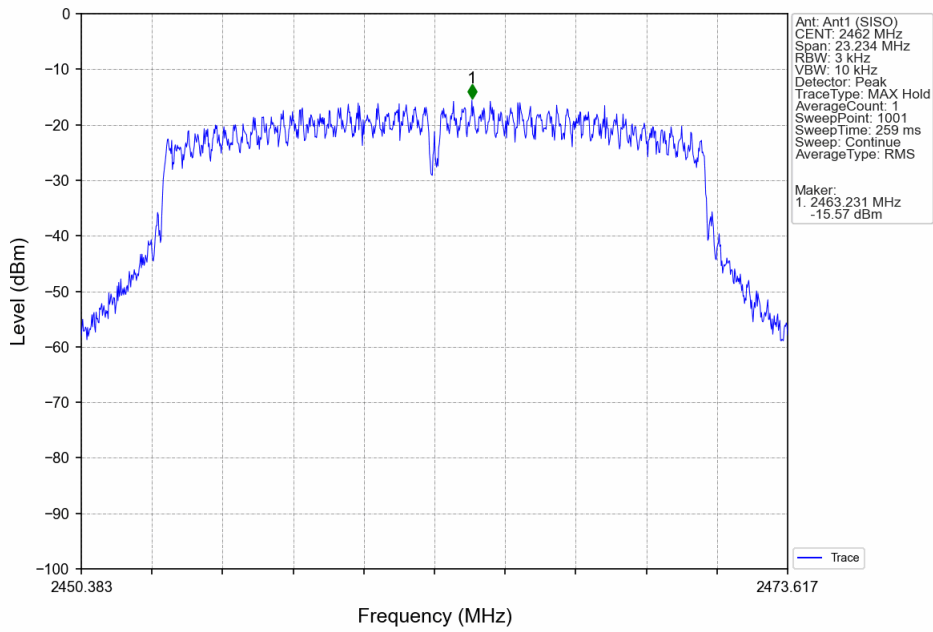

802.11n(HT40)_LCH_2422MHz_Ant1 (SISO)_NTNV

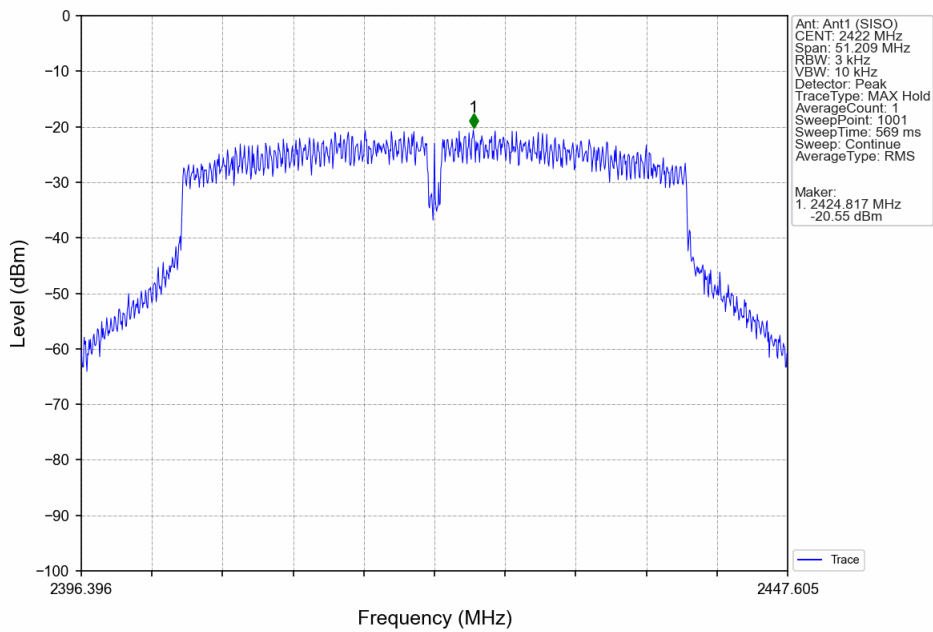

802.11n(HT40)_MCH_2437MHz_Ant1 (SISO)_NTNV

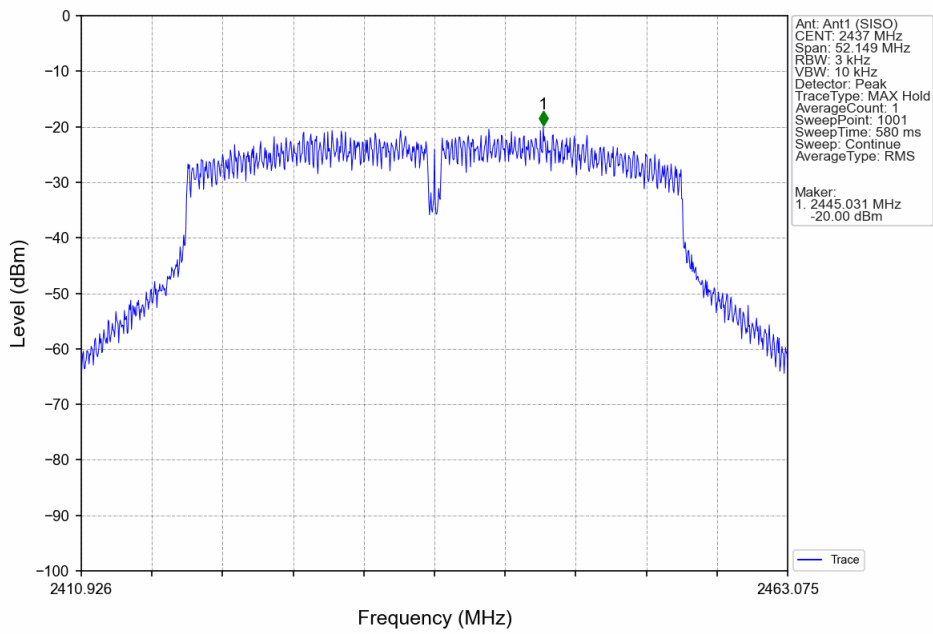

802.11n(HT40)_HCH_2452MHz_Ant1 (SISO)_NTNV

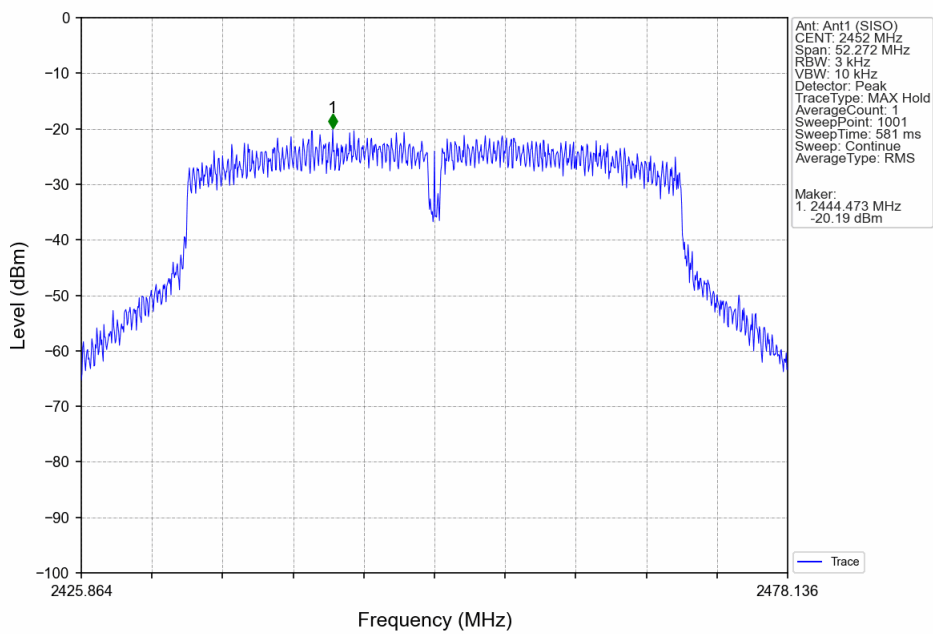

9.5 Spurious RF conducted emissions

Test Method

1. The RF output of EUT was connected to the spectrum analyzer by RF cable. The path loss was compensated to the results for each measurement.
2. Set to the maximum power setting, the instrument center frequency is set to the nominal EUT channel center frequency enable the EUT transmit continuously.
3. Use the following spectrum analyzer settings:
Span = wide enough to capture the peak level of the in-band emission and all spurious emissions (e.g., harmonics) from the lowest frequency generated in the EUT up through the 10th harmonic. Typically, several plots are required to cover this entire span.
RBW = 100 kHz, VBW \geq 3RBW, Sweep = auto, Detector function = peak, Trace = max hold
4. Allow the trace to stabilize. Set the marker on the peak of any spurious emission recorded.
5. The level displayed must comply with the limit specified in this Section. Submit these plots.
6. Repeat above procedures until all frequencies measured were complete.

Limit

Frequency Range MHz	Limit (dBc)
30-25000	-20

Test results

Reference:

Mode	TX Type	Frequency (MHz)	ANT	Level of Reference (dBm)
802.11b	SISO	2412	1	6.72
		2437	1	6.62
		2462	1	6.27
802.11g	SISO	2412	1	-0.20
		2437	1	-0.12
		2462	1	-0.35
802.11n (HT20)	SISO	2412	1	-0.04
		2437	1	-0.90
		2462	1	-0.29
802.11n (HT40)	SISO	2422	1	-4.71
		2437	1	-4.70
		2452	1	-4.73

Note1: Refer to FCC Part 15.247 (d) and ANSI C63.10-2013, the channel contains the maximum PSD level was used to establish the reference level.

Conducted spurious emission:

Mode	TX Type	Frequency (MHz)	ANT	Level of Reference (dBm)	Limit (dBm)	Verdict
802.11b	SISO	2412	1	6.72	-13.28	Pass
		2437	1	6.62	-13.38	Pass
		2462	1	6.27	-13.73	Pass
802.11g	SISO	2412	1	-0.20	-20.20	Pass
		2437	1	-0.12	-20.12	Pass
		2462	1	-0.35	-20.35	Pass
802.11n (HT20)	SISO	2412	1	-0.04	-20.04	Pass
		2437	1	-0.90	-20.90	Pass
		2462	1	-0.29	-20.29	Pass
802.11n (HT40)	SISO	2422	1	-4.71	-24.71	Pass
		2437	1	-4.70	-24.70	Pass
		2452	1	-4.73	-24.73	Pass

Note1: Refer to FCC Part 15.247 (d) and ANSI C63.10-2013, the channel contains the maximum PSD level was used to establish the reference level.

Test Graphs

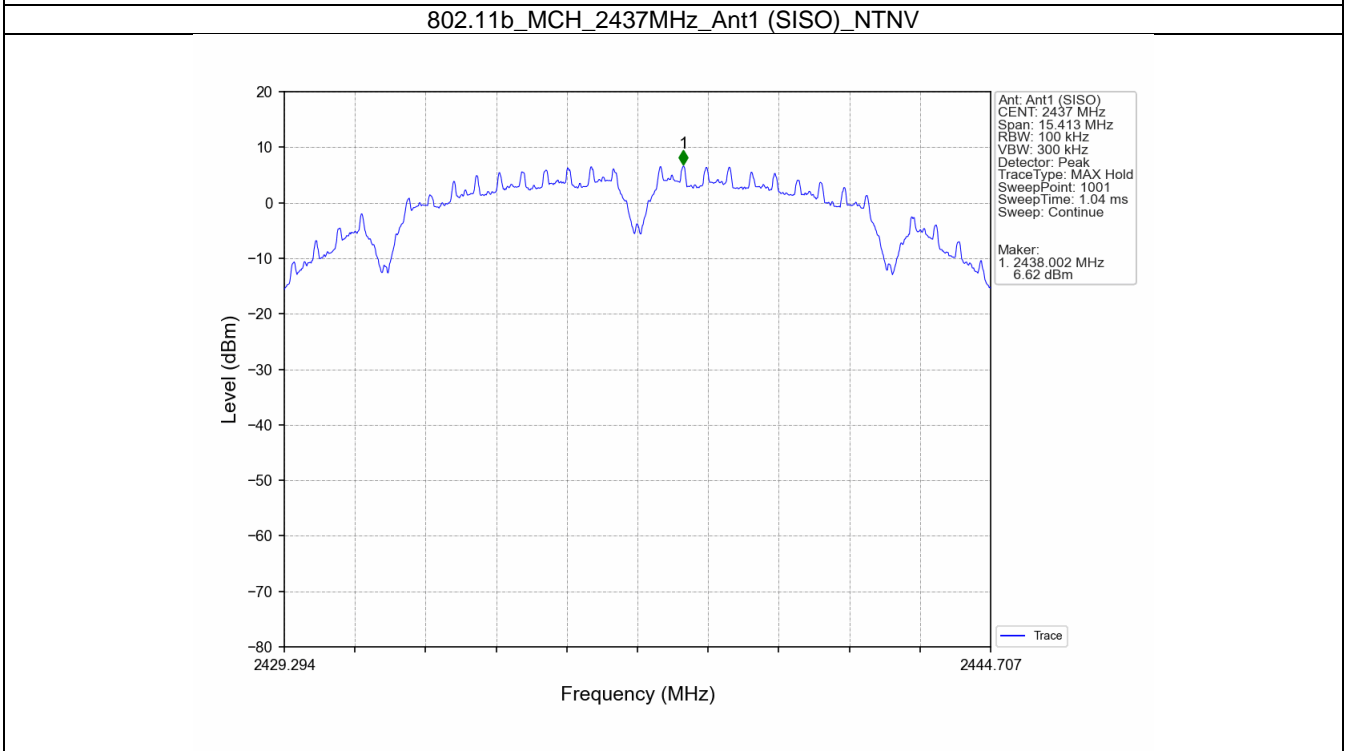
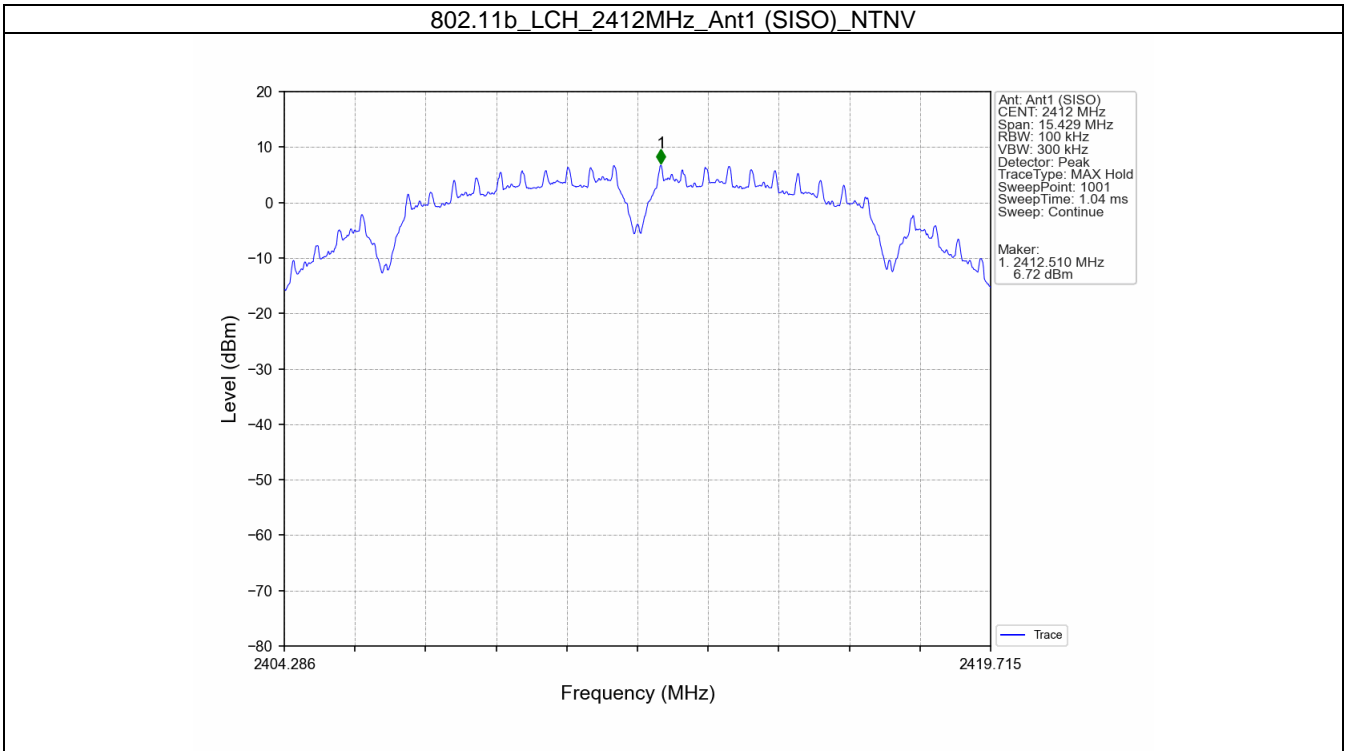

802.11b_HCH_2462MHz_Ant1 (SISO)_NTNV

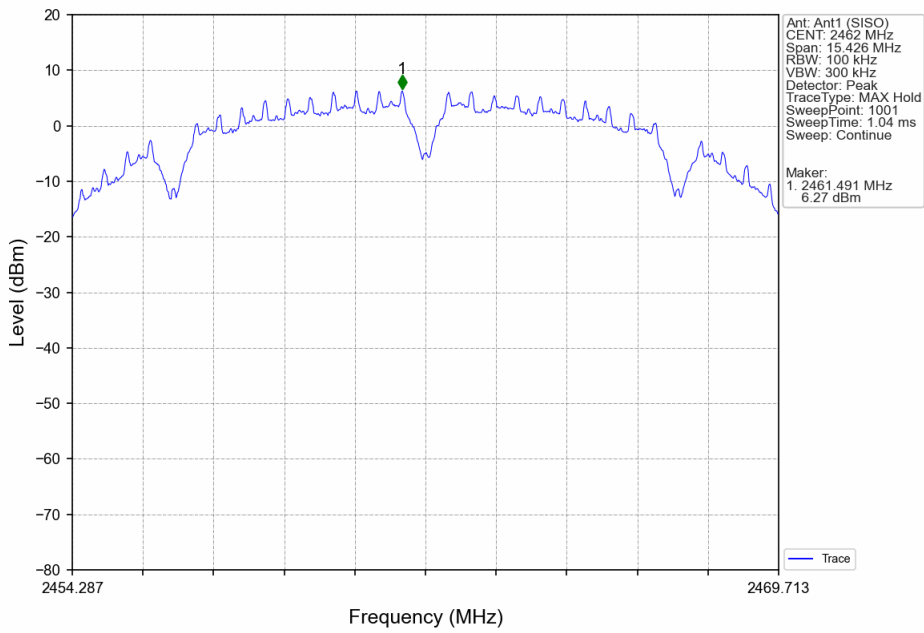

802.11g_LCH_2412MHz_Ant1 (SISO)_NTNV

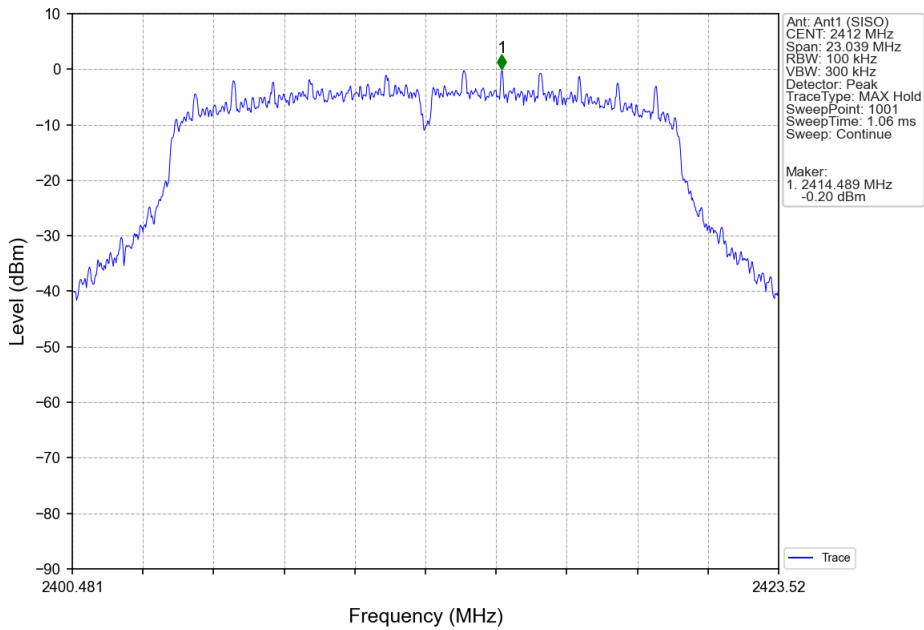

802.11g_MCH_2437MHz_Ant1 (SISO)_NTNV

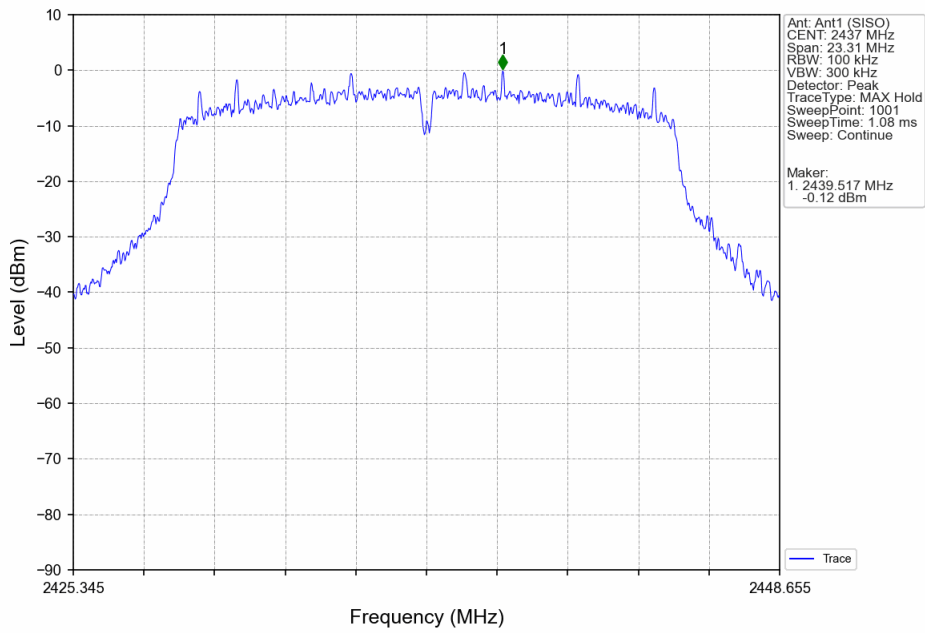

802.11g_HCH_2462MHz_Ant1 (SISO)_NTNV

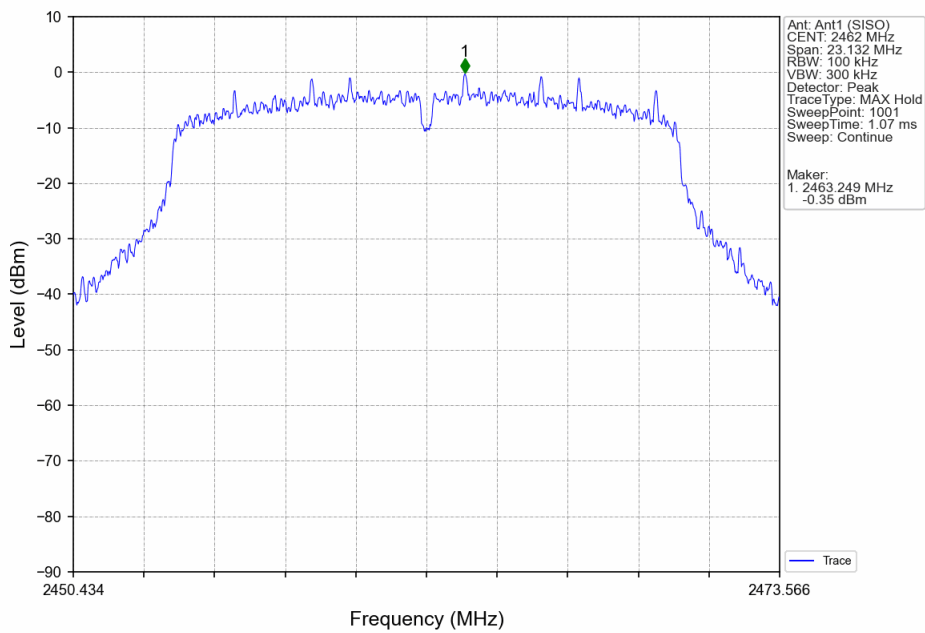

802.11n(HT20)_LCH_2412MHz_Ant1 (SISO)_NTNV

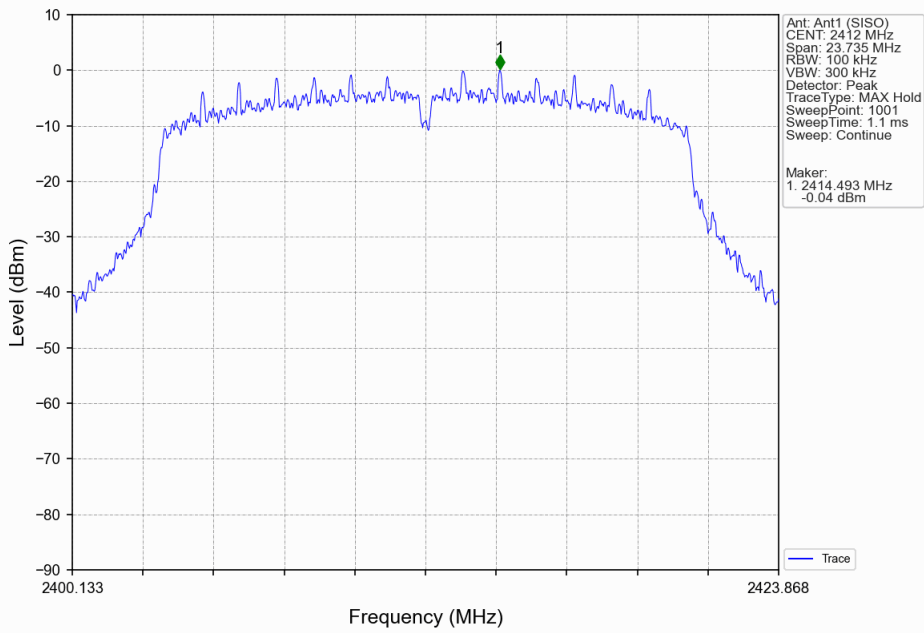

802.11n(HT20)_MCH_2437MHz_Ant1 (SISO)_NTNV

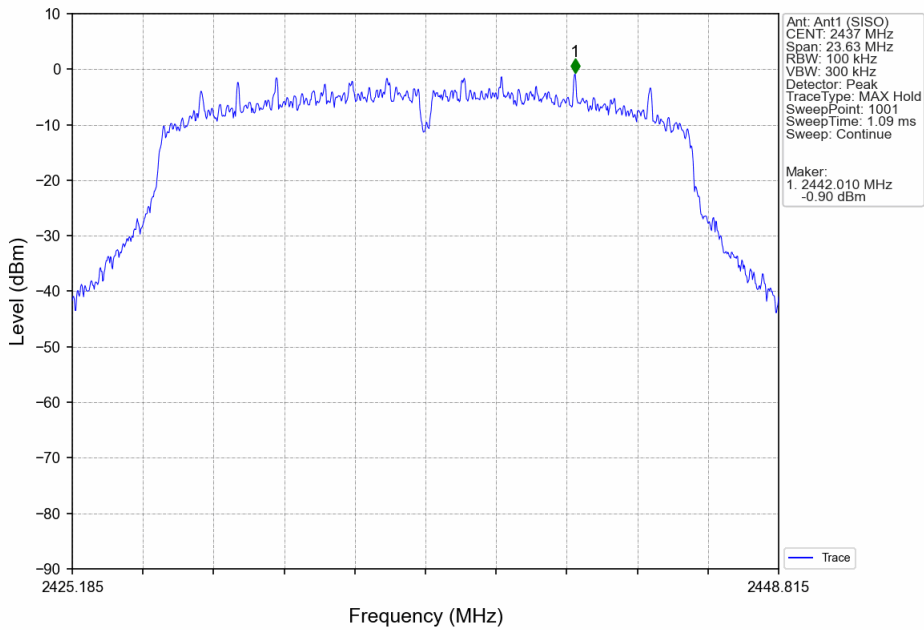

802.11n(HT20)_HCH_2462MHz_Ant1 (SISO)_NTNV

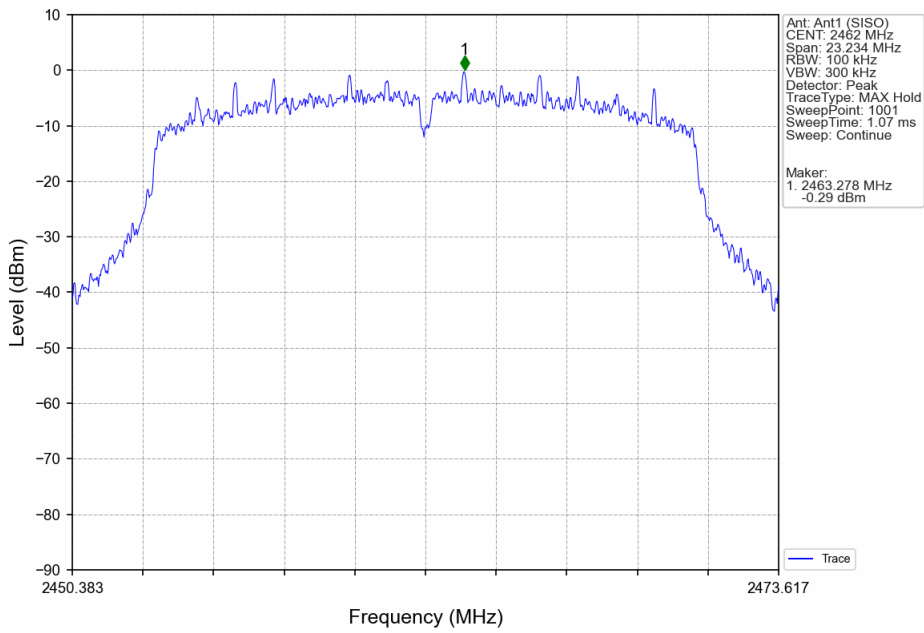

802.11n(HT40)_LCH_2422MHz_Ant1 (SISO)_NTNV

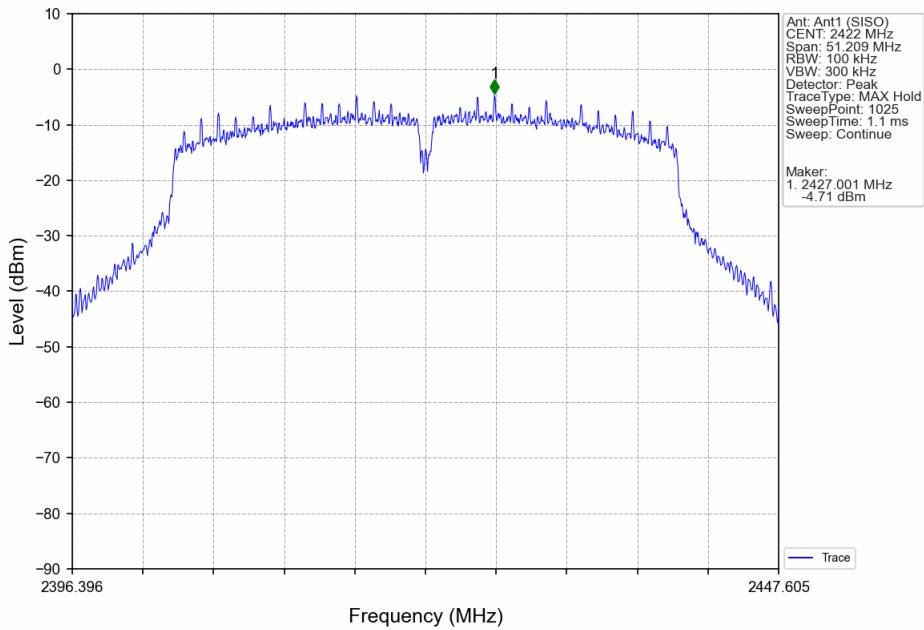

802.11n(HT40)_MCH_2437MHz_Ant1 (SISO)_NTNV

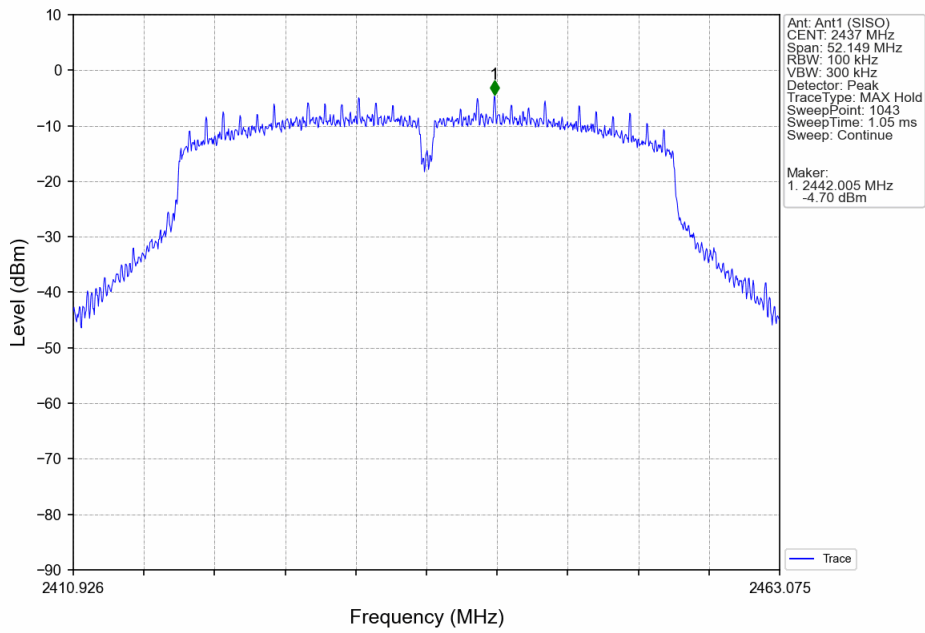

802.11n(HT40)_HCH_2452MHz_Ant1 (SISO)_NTNV

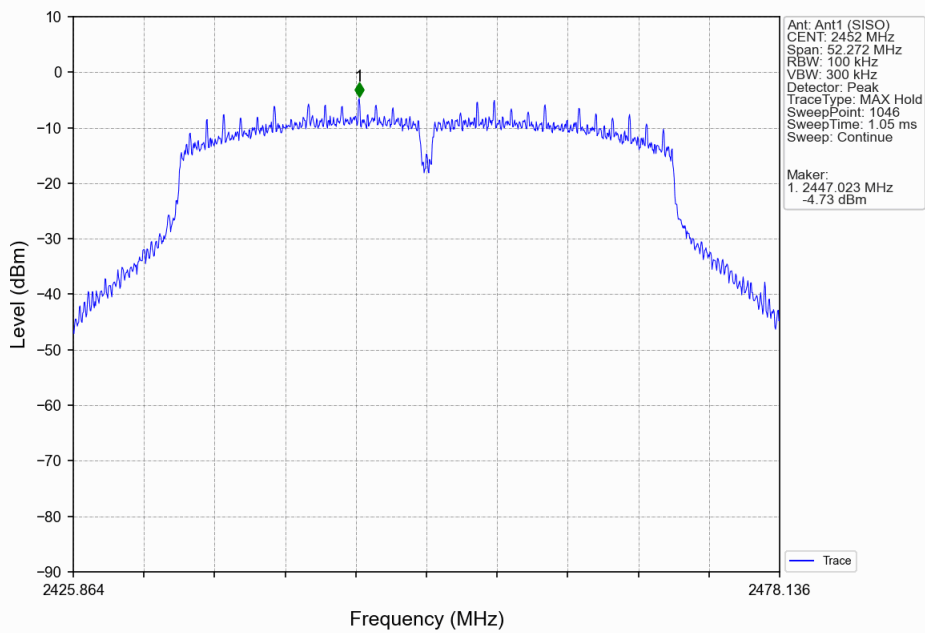

802.11b_LCH_2412MHz_Ant1 (SISO)_NTNV

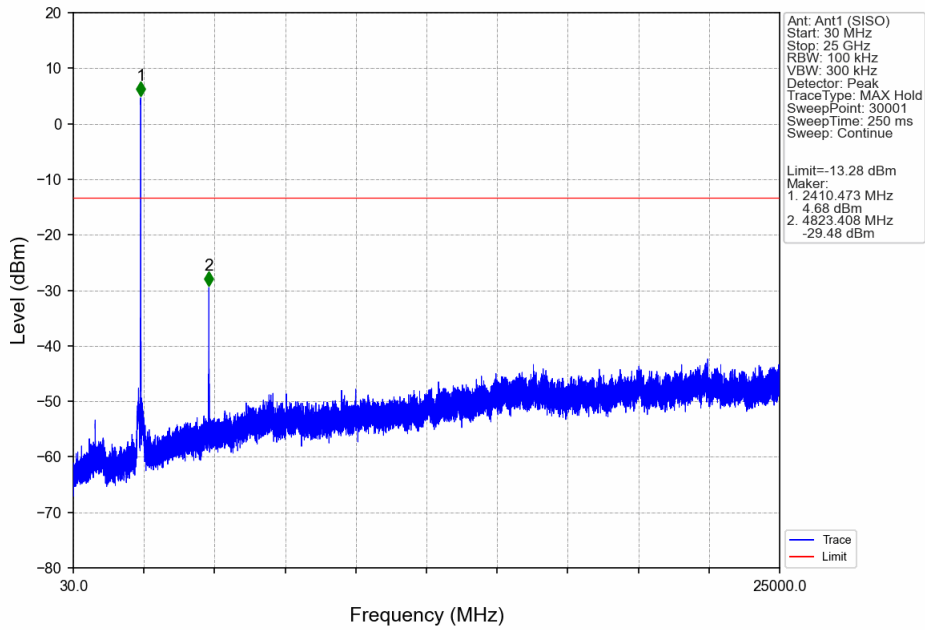

802.11b_MCH_2437MHz_Ant1 (SISO)_NTNV

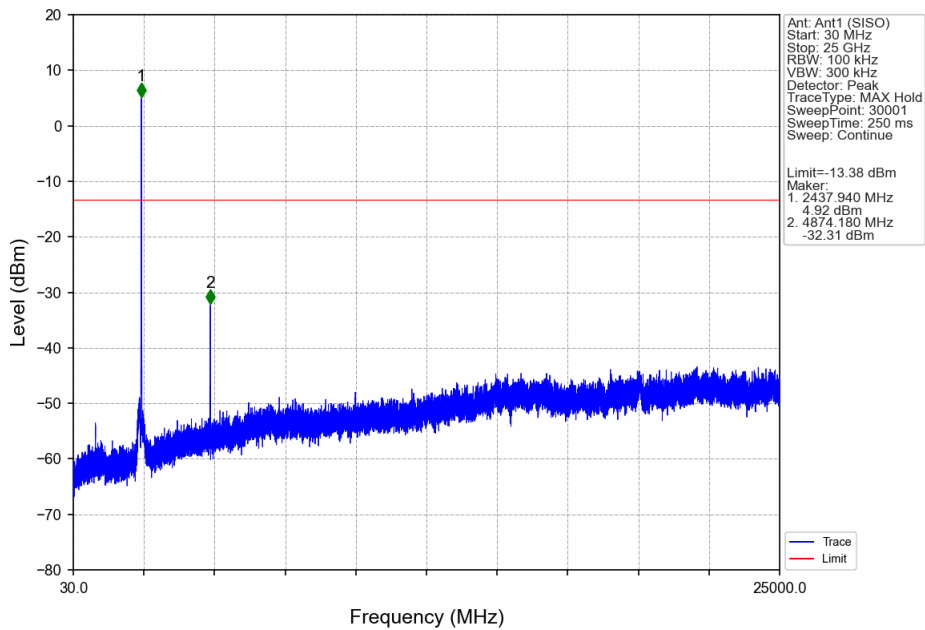



802.11b_HCH_2462MHz_Ant1 (SISO)_NTNV

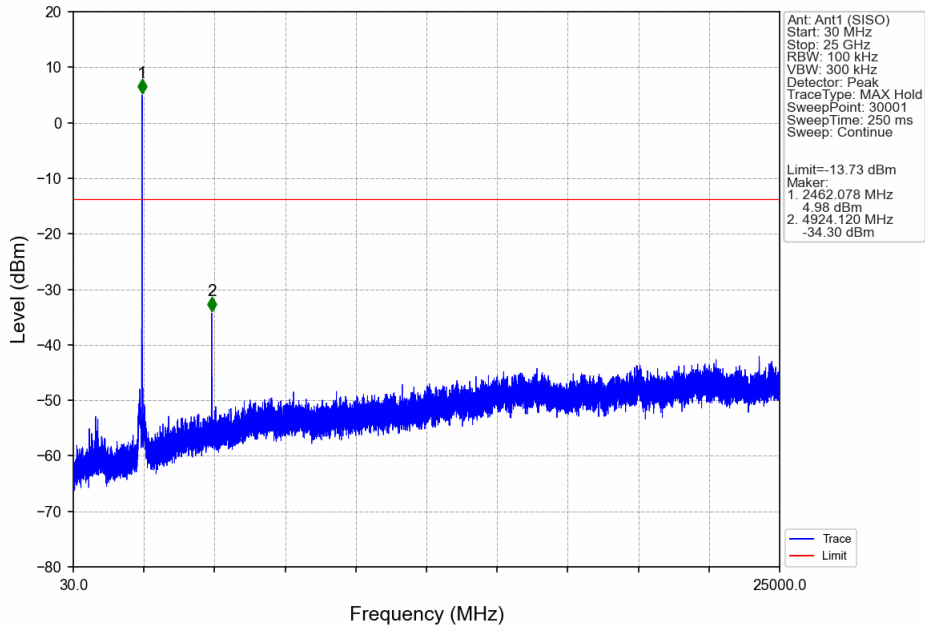

802.11g_LCH_2412MHz_Ant1 (SISO)_NTNV

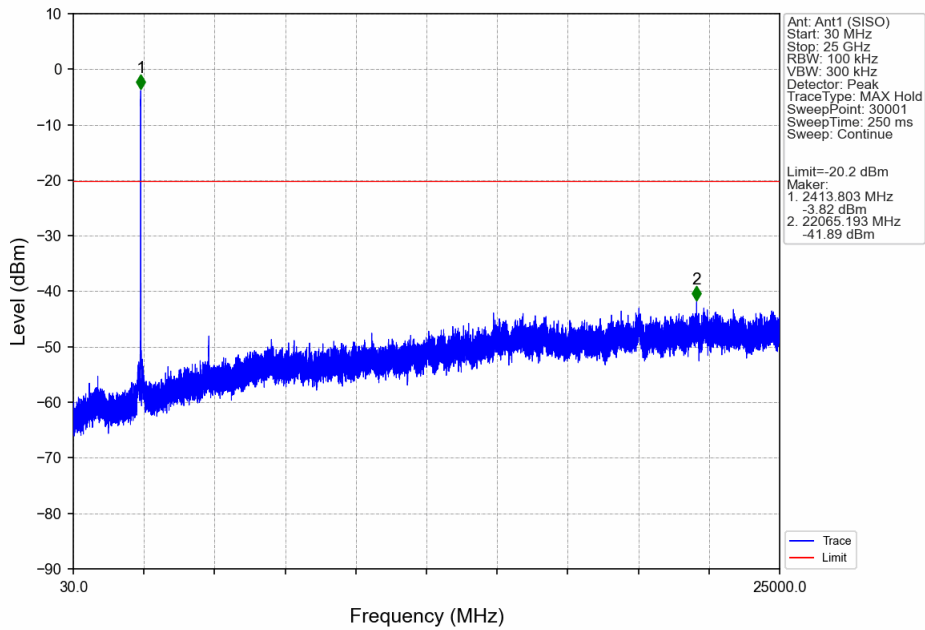

802.11g_MCH_2437MHz_Ant1 (SISO)_NTNV

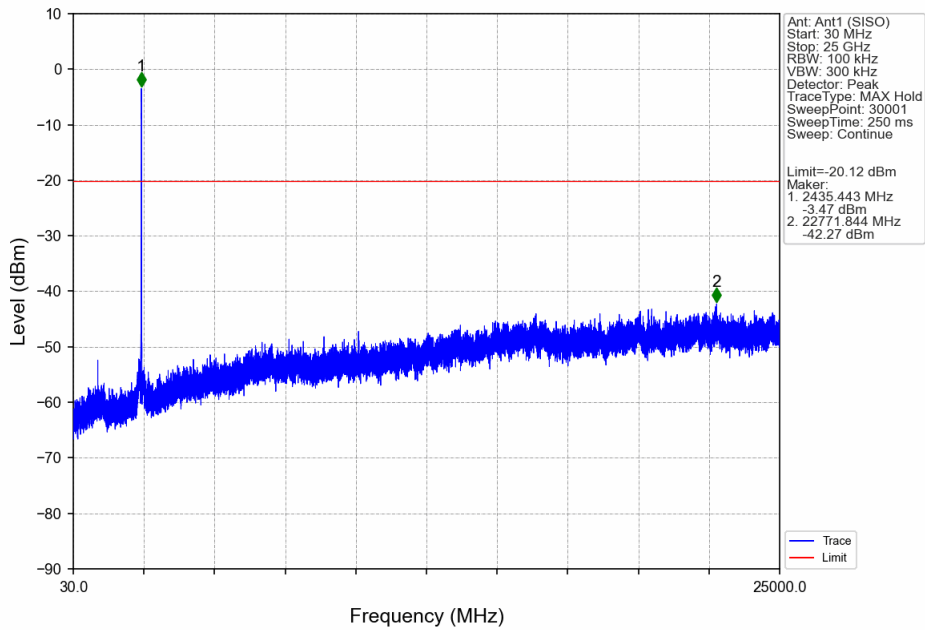

802.11g_HCH_2462MHz_Ant1 (SISO)_NTNV

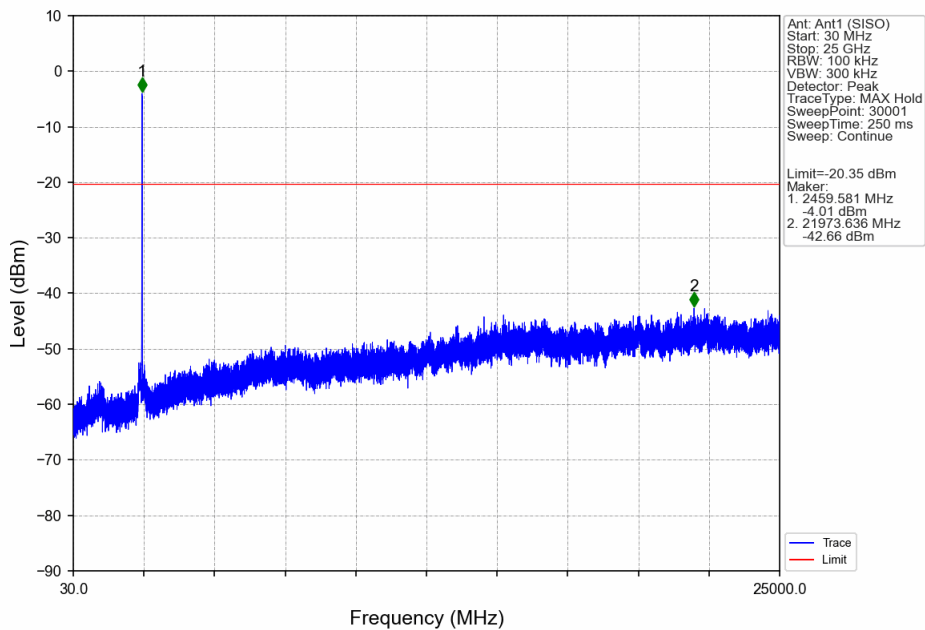



802.11n(HT20)_LCH_2412MHz_Ant1 (SISO)_NTNV

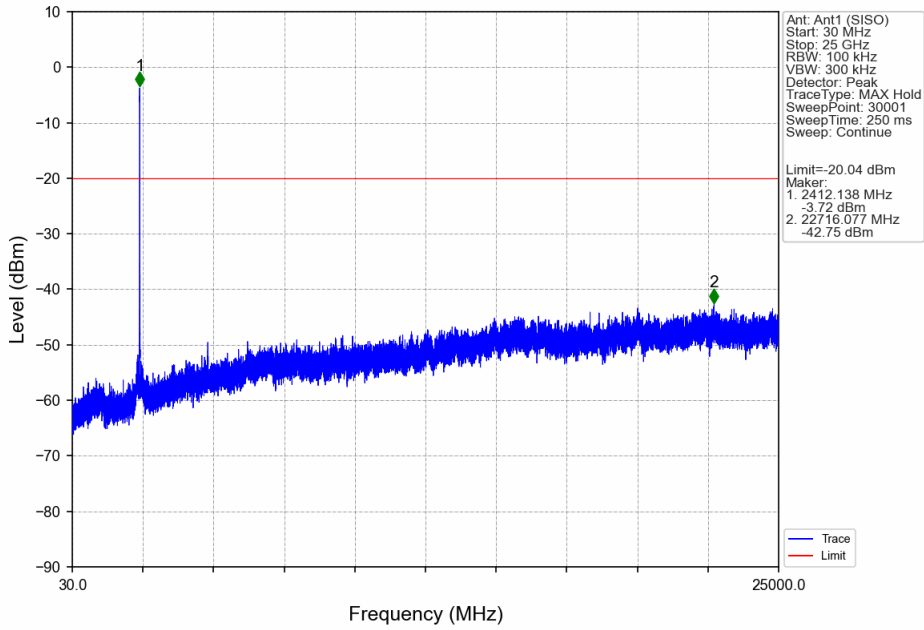

802.11n(HT20)_MCH_2437MHz_Ant1 (SISO)_NTNV

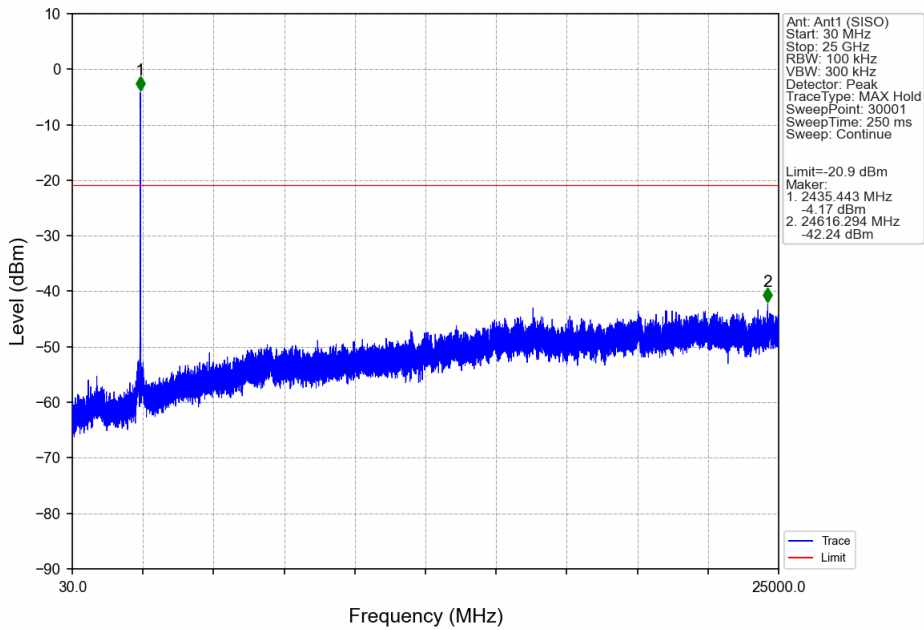

802.11n(HT20)_HCH_2462MHz_Ant1 (SISO)_NTNV

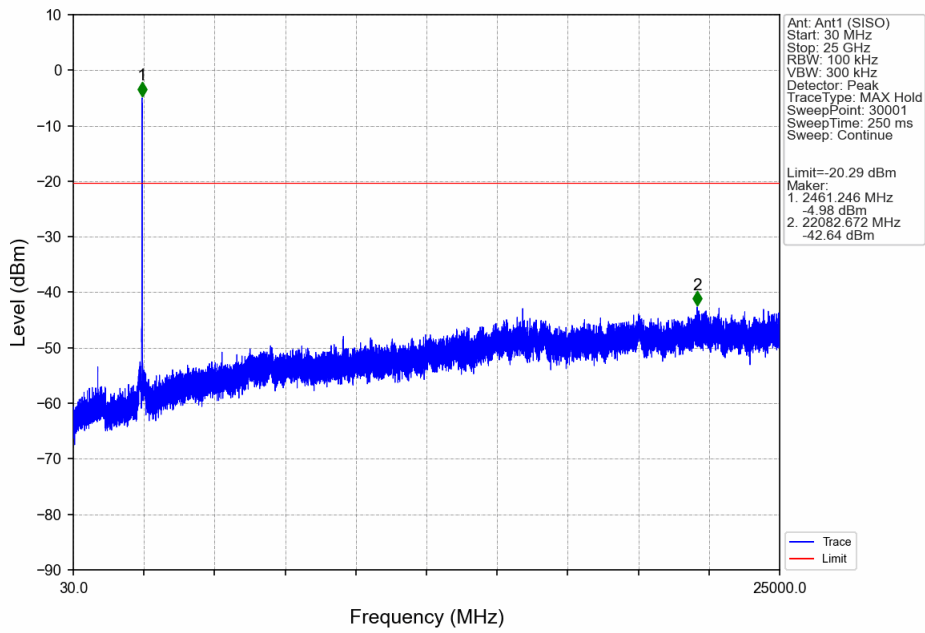

802.11n(HT40)_LCH_2422MHz_Ant1 (SISO)_NTNV

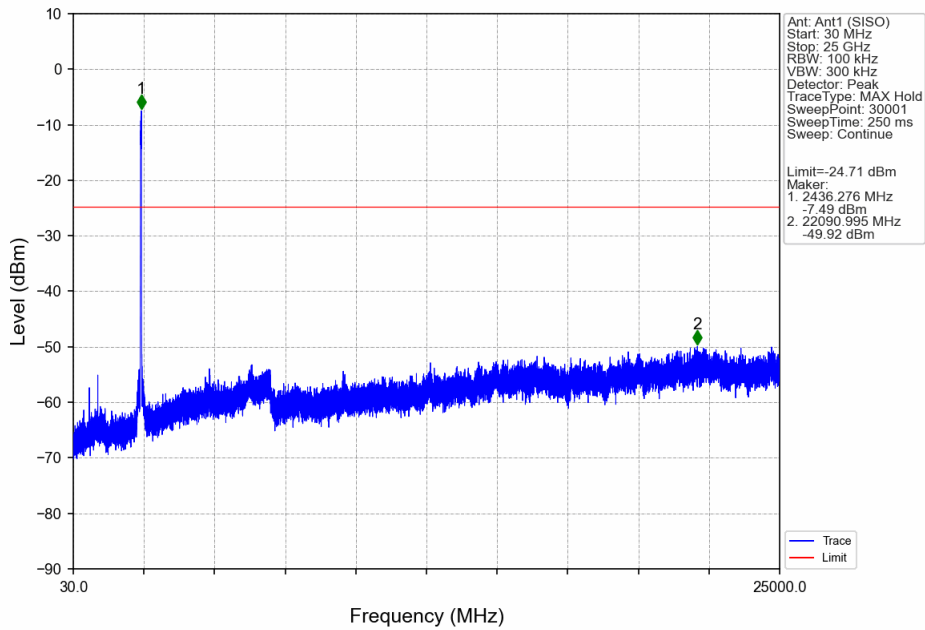

802.11n(HT40)_MCH_2437MHz_Ant1 (SISO)_NTNV

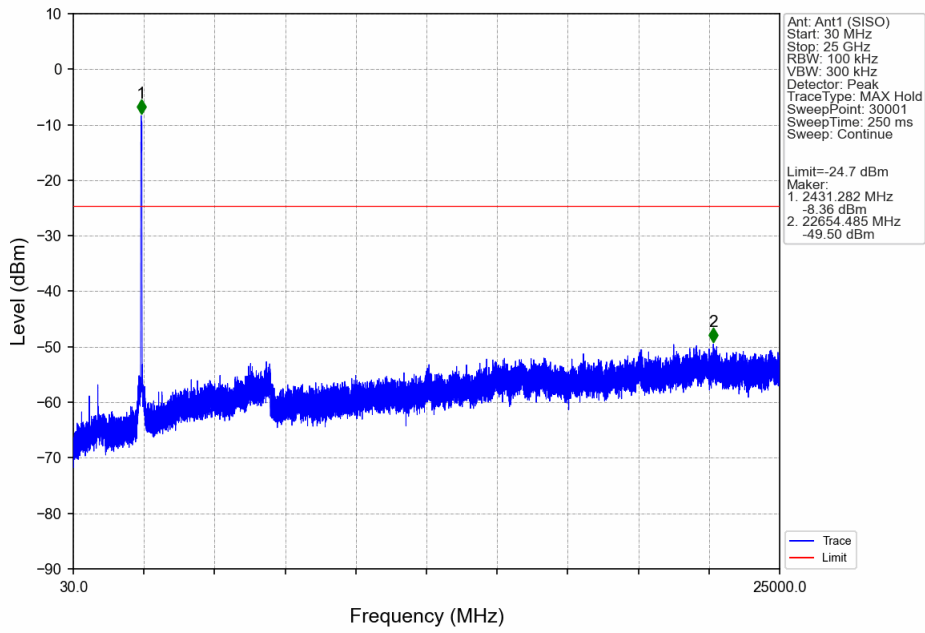

802.11n(HT40)_HCH_2452MHz_Ant1 (SISO)_NTNV

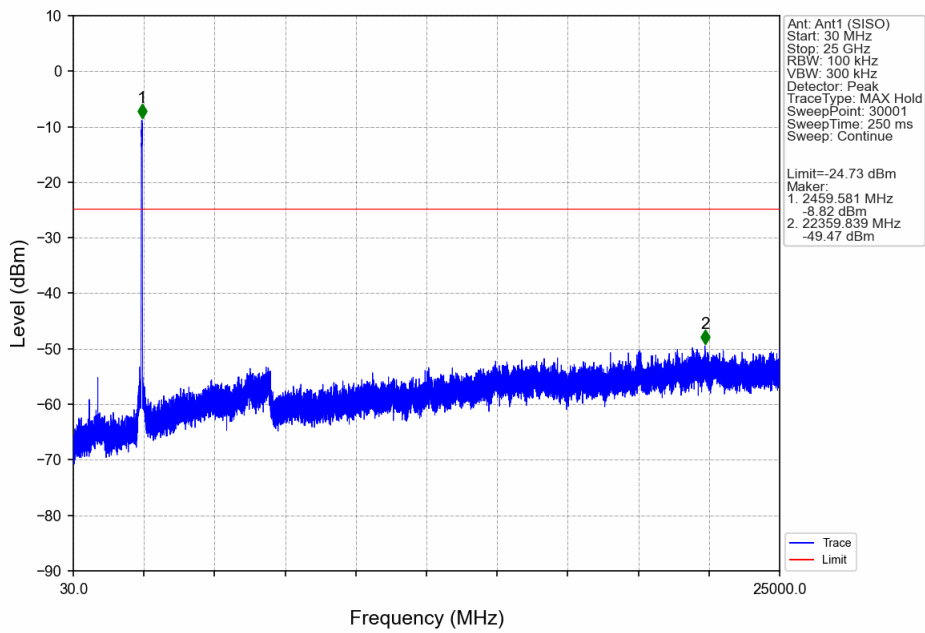

9.6 Band edge

Test Method

1. The RF output of EUT was connected to the spectrum analyzer by RF cable. The path loss was compensated to the results for each measurement.
2. Set to the maximum power setting, the instrument center frequency is set to the nominal EUT channel center frequency enable the EUT transmit continuously.
3. Use the following spectrum analyzer settings:
Span = wide enough to capture the peak level of the in-band emission and all spurious
RBW = 100 kHz, VBW \geq 3RBW, Sweep = auto, Detector function = peak, Trace = max hold
4. Allow the trace to stabilize, use the peak and delta measurement to record the result.
5. The level displayed must comply with the limit specified in this Section.
6. Repeat above procedures until all frequencies measured were complete and submit all the plots.

Limit:

In any 100 kHz bandwidth outside the frequency band in which the spread spectrum or digitally modulated device is operating, the RF power that is produced shall be at least 20 dB below that in the 100 kHz bandwidth within the band that contains the highest level of the desired power, based on either an RF conducted or a radiated measurement, provided that the transmitter demonstrates compliance with the peak conducted power limits. If the transmitter complies with the conducted power limits based on the use of RMS averaging over a time interval, as permitted under § 15.247(b)(3) and RSS-247 section 5.4(d), the attenuation required shall be 30 dB instead of 20 dB.

Frequency Range MHz	Limit (dBc)
30-25000	-20

Test results

Mode	TX Type	Frequency (MHz)	ANT	Level of Reference (dBm)	Limit (dBm)	Verdict
802.11b	SISO	2412	1	6.72	-13.28	Pass
		2437	1	6.62	-13.38	Pass
		2462	1	6.27	-13.73	Pass
802.11g	SISO	2412	1	-0.20	-20.20	Pass
		2437	1	-0.12	-20.12	Pass
		2462	1	-0.35	-20.35	Pass
802.11n (HT20)	SISO	2412	1	-0.04	-20.04	Pass
		2437	1	-0.90	-20.90	Pass
		2462	1	-0.29	-20.29	Pass
802.11n (HT40)	SISO	2422	1	-4.71	-24.71	Pass
		2437	1	-4.70	-24.70	Pass
		2452	1	-4.73	-24.73	Pass

Note1: Refer to FCC Part 15.247 (d) and ANSI C63.10-2013, the channel contains the maximum PSD level was used to establish the reference level.

Test Graphs

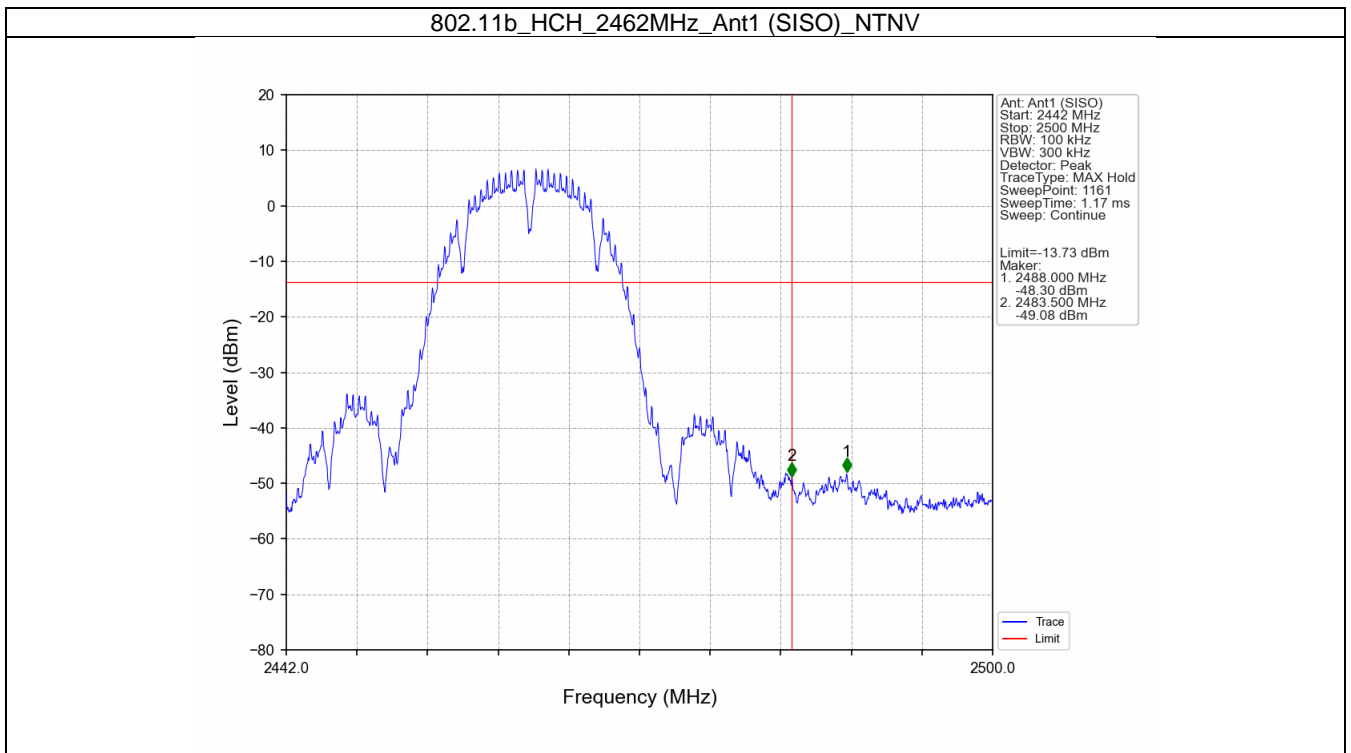
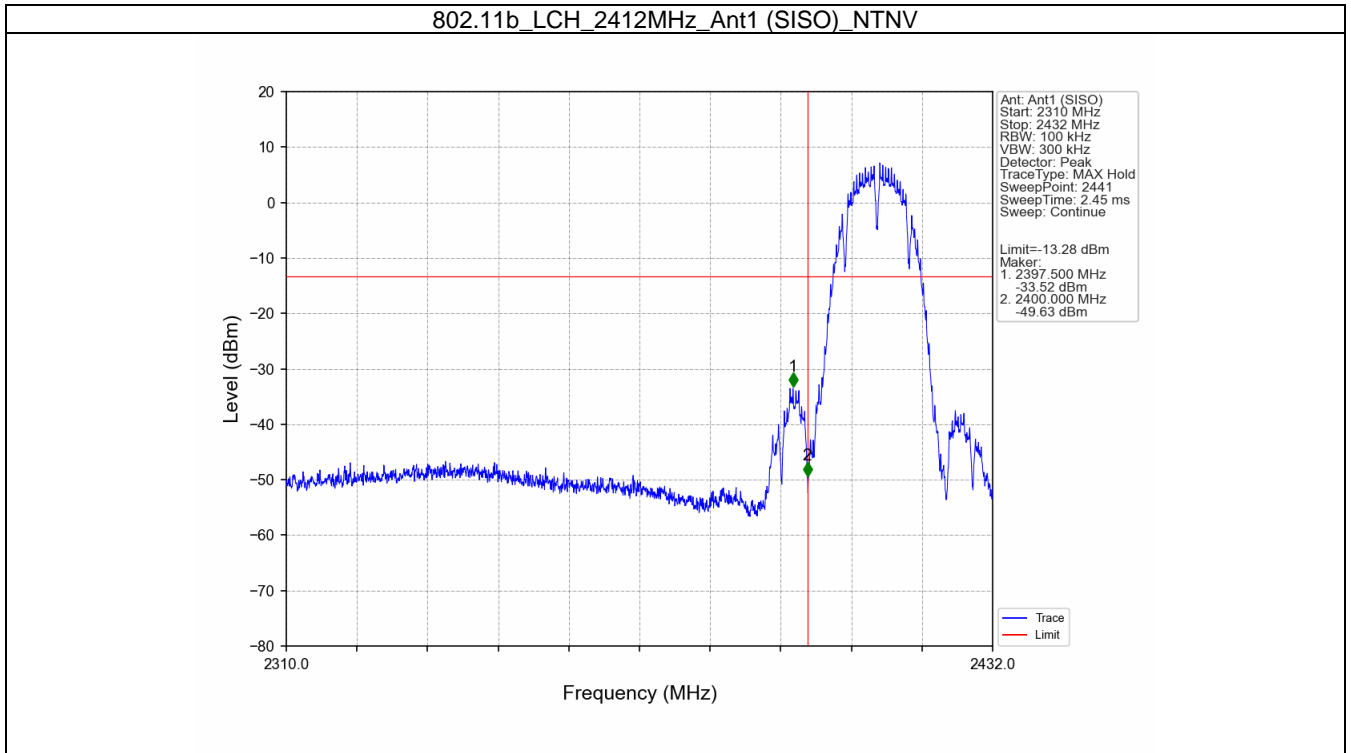

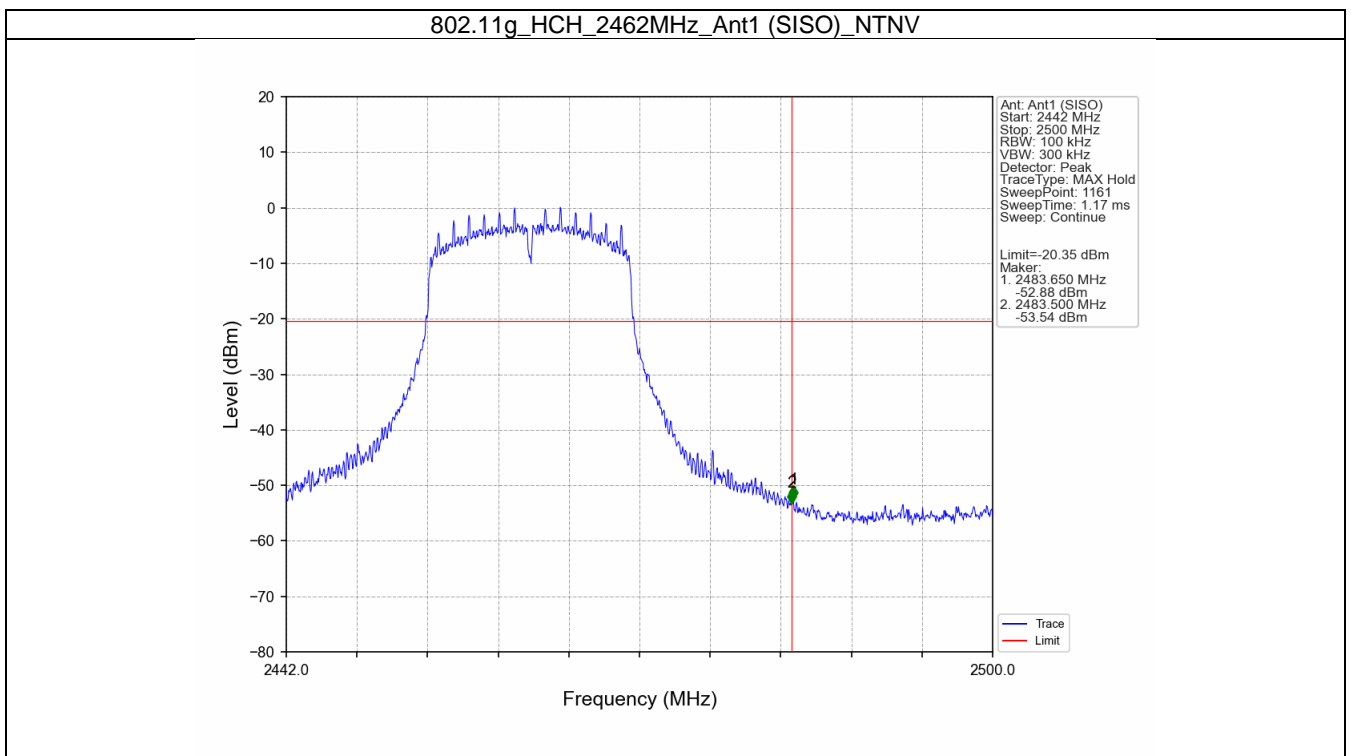
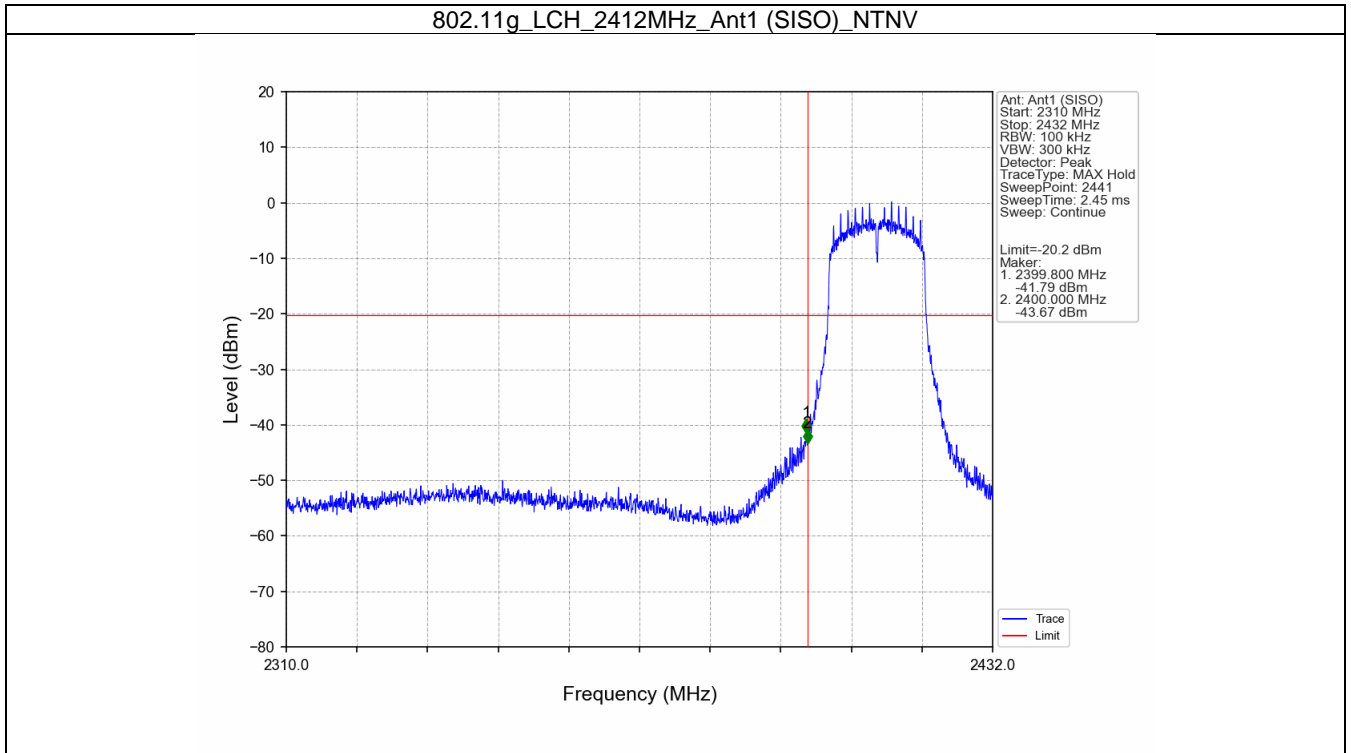

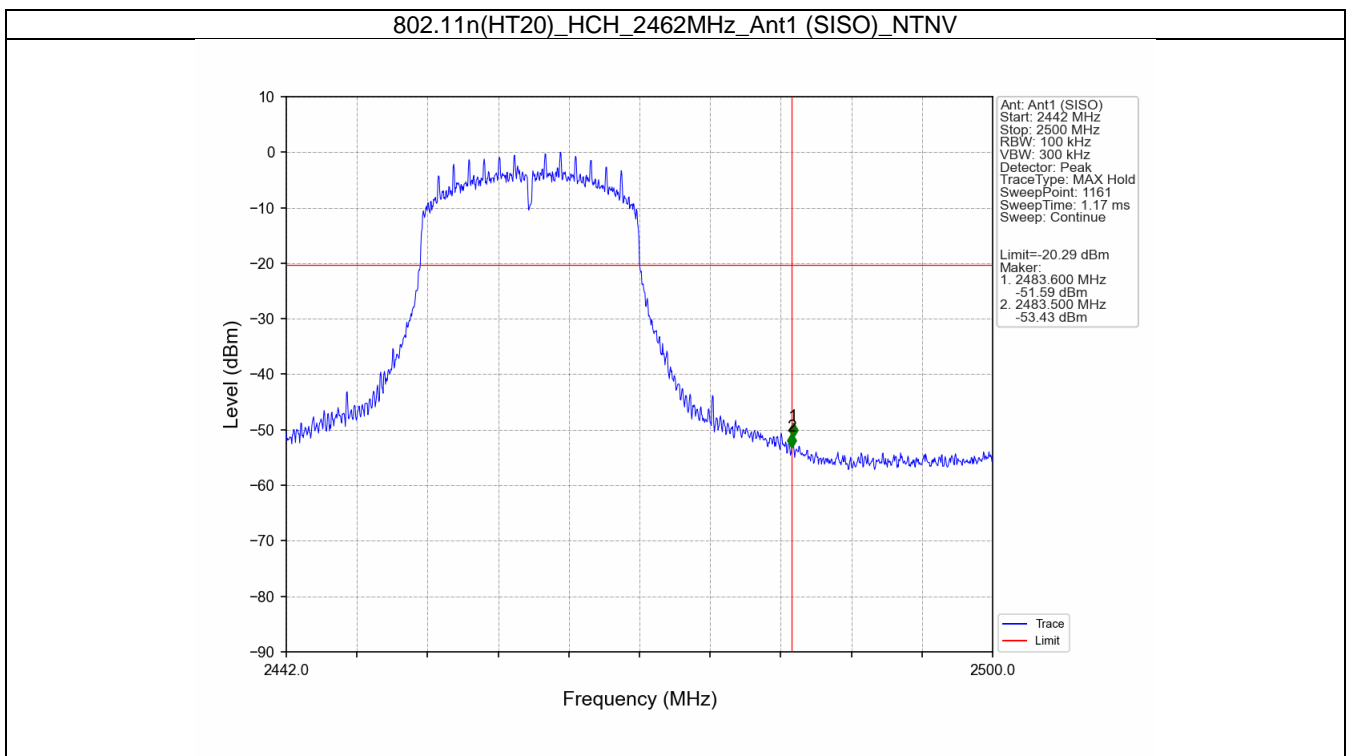
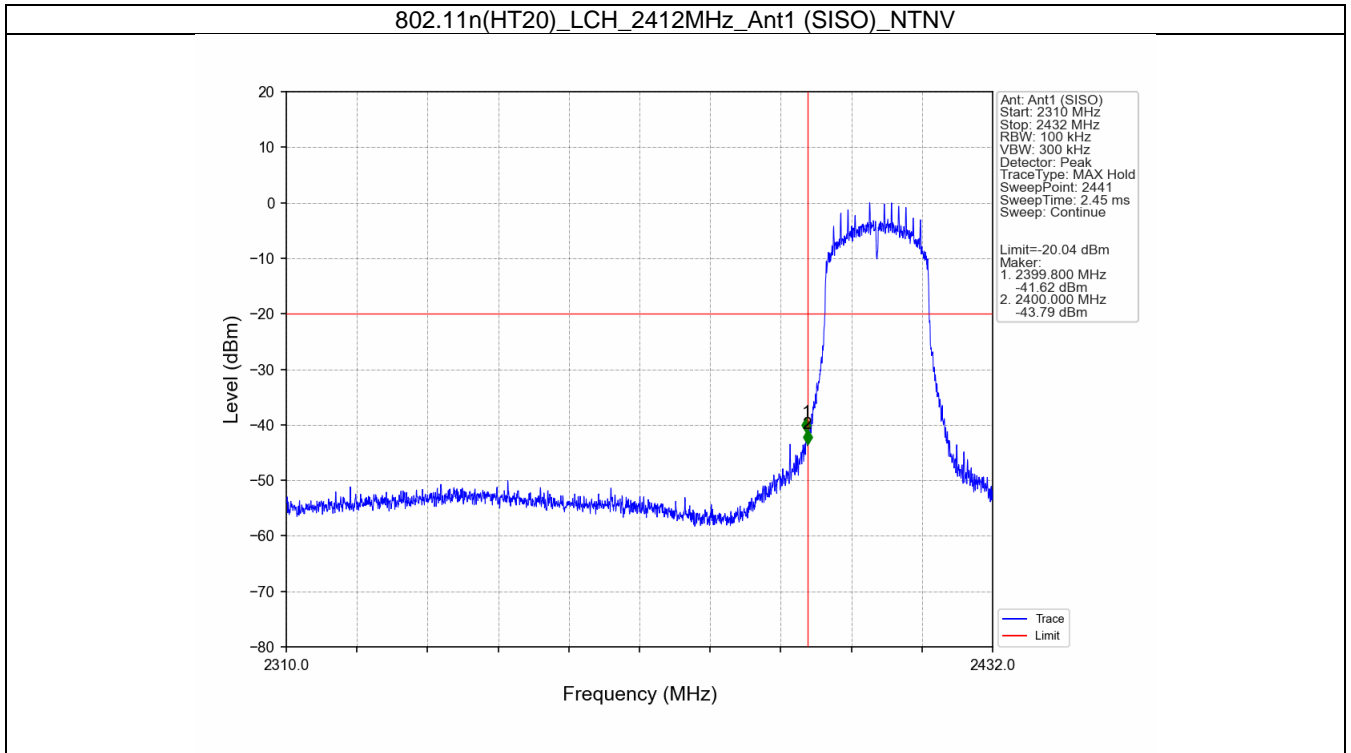

802.11n(HT40)_LCH_2422MHz_Ant1 (SISO)_NTNV

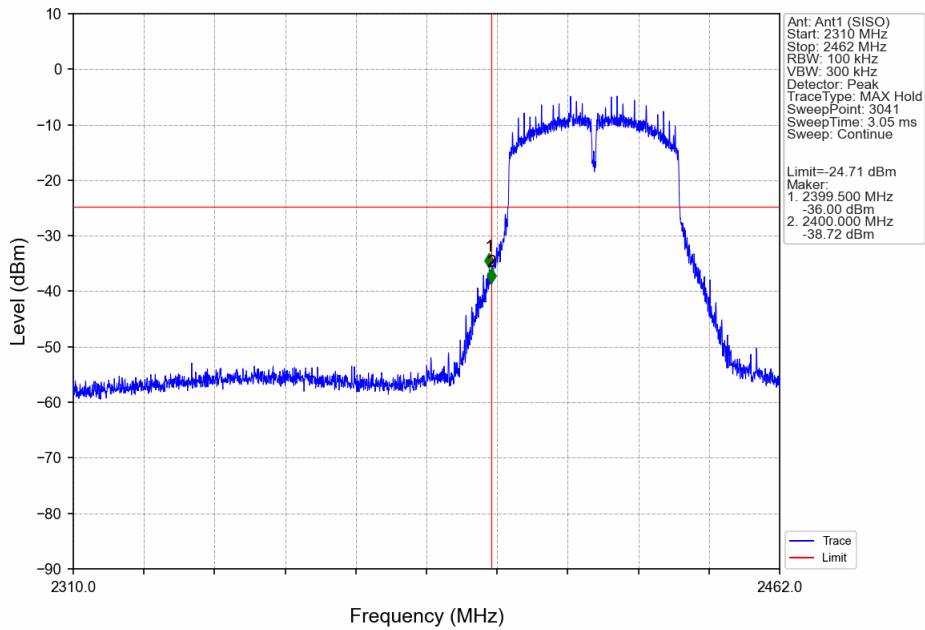

802.11n(HT40)_HCH_2452MHz_Ant1 (SISO)_NTNV

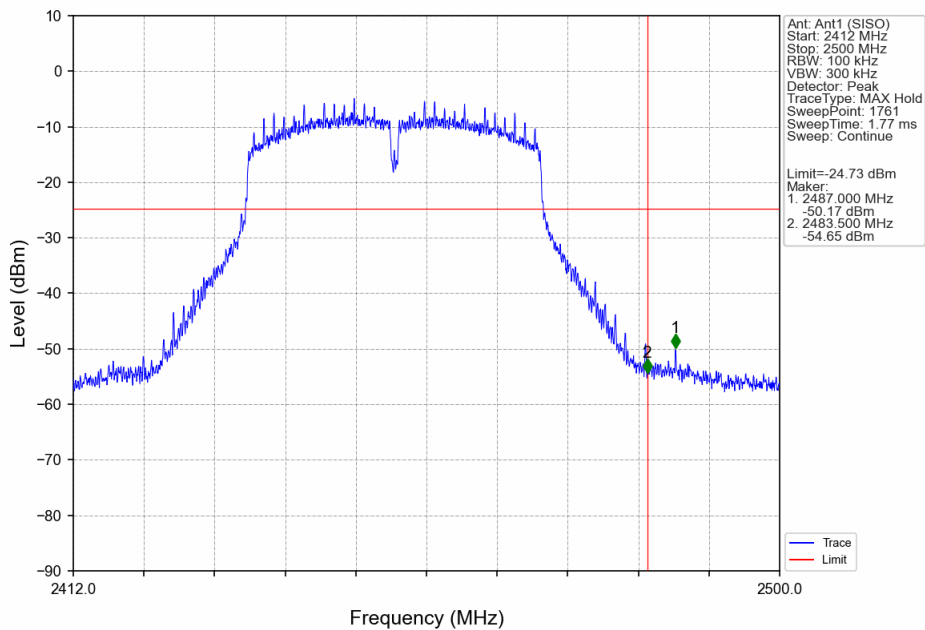

9.7 Spurious radiated emissions for transmitter

Test Method

1. The EUT was placed on a turn table which is 1.5m above ground plane for above 1GHz and 0.8m above ground for below 1GHz at 3 meter chamber room for test. The table was rotated 360 degrees to determine the position of the highest radiation.
2. The EUT was set 3 meters away from the interference – receiving antenna, which was mounted on the top of a variable – height antenna tower.
3. The height of antenna is varied from one meter to four meters above the ground to determine the maximum value of the field strength. Both horizontal and vertical polarizations of the antenna are set to make the measurement.
4. For each suspected emission, the EUT was arranged to its worst case and then the antenna was tuned to heights from 1 meter to 4 meters and the rotatable table was turned from 0 degrees to 360 degrees to find the maximum reading.
5. Use the following spectrum analyzer settings According to C63.10:
 - 1) Procedure for Unwanted Emissions Measurements Below 1000 MHz
Span = wide enough to capture the peak level of the in-band emission and all spurious
RBW = 100 KHz to 120KHz, VBW \geq RBW for peak measurement, Sweep = auto, Detector function = peak, Trace = max hold.
 - 2) For Peak unwanted emissions Above 1GHz:
Span = wide enough to capture the peak level of the in-band emission and all spurious
RBW = 1MHz, VBW \geq RBW for peak measurement, Sweep = auto, Detector function = peak, Trace = max hold.
 - 3) Procedures for average unwanted emissions measurements above 1000 MHz
 - a) RBW = 1MHz.
 - b) VBW \ [3 \times RBW].
 - c) Detector = RMS (power averaging), if [span / (# of points in sweep)] \ RBW / 2. Satisfying this condition can require increasing the number of points in the sweep or reducing the span. If the condition is not satisfied, then the detector mode shall be set to peak.
 - d) Averaging type = power (i.e., rms) (As an alternative, the detector and averaging type may be set for linear voltage averaging. Some instruments require linear display mode to use linear voltage averaging. Log or dB averaging shall not be used.)
 - e) Sweep time = auto.
 - f) Perform a trace average of at least 100 traces if the transmission is continuous. If the transmission is not continuous, then the number of traces shall be increased by a factor of 1 / D, where D is the duty cycle. For example, with 50% duty cycle, at least 200 traces shall be averaged. (If a specific emission is demonstrated to be continuous—i.e., 100% duty cycle—then rather than turning ON and OFF with the transmit cycle, at least 100 traces shall be averaged.)
 - g) If tests are performed with the EUT transmitting at a duty cycle less than 98%, then a correction factor shall be added to the measurement results prior to comparing with the emission limit, to compute the emission level that would have been measured had the test been performed at 100% duty cycle. The correction factor is computed as follows:
 - 1) If power averaging (rms) mode was used in the preceding step e), then the correction

factor is $[10 \log (1 / D)]$, where D is the duty cycle. For example, if the transmit duty cycle was 50%, then 3 dB shall be added to the measured emission levels.

2) If linear voltage averaging mode was used in the preceding step e), then the correction factor is $[20 \log (1 / D)]$, where D is the duty cycle. For example, if the transmit duty cycle was 50%, then 6 dB shall be added to the measured emission levels.

3) If a specific emission is demonstrated to be continuous (100% duty cycle) rather than turning ON and OFF with the transmit cycle, then no duty cycle correction is required for that emission(AV) at frequency above 1GHz.

Limit

In any 100 kHz bandwidth outside the frequency band in which the spread spectrum or digitally modulated device is operating, the RF power that is produced shall be at least 20 dB below that in the 100 kHz bandwidth within the band that contains the highest level of the desired power, based on either an RF conducted or a radiated measurement, provided that the transmitter demonstrates compliance with the peak conducted power limits. If the transmitter complies with the conducted power limits based on the use of RMS averaging over a time interval, as permitted under § 15.247(b)(3), the attenuation required shall be 30 dB instead of 20 dB. Attenuation below the general field strength limits specified in § 15.209(a) is not required. In addition, radiated emissions which fall in the restricted bands, as defined in § 15.205(a), must also comply with the radiated emission limits specified in § 15.209(a).

Frequency MHz	Field Strength $\mu\text{V/m}$	Field Strength $\text{dB}\mu\text{V/m}$	Detector	Measurement distance meters
0.009-0.490	2400/F(kHz)	48.5-13.8	AV	300
0.490-1.705	24000/F(kHz)	33.8-23.0	QP	30
1.705-30	30	29.5	QP	30
30-88	100	40	QP	3
88-216	150	43.5	QP	3
216-960	200	46	QP	3
960-1000	500	54	QP	3
Above 1000	500	54	AV	3
Above 1000	5000	74	PK	3

Note 1: Limit 3m(dB $\mu\text{V/m}$)=Limit 300m(dB $\mu\text{V/m}$)+40Log(300m/3m) (Below 30MHz)

Note 2: Limit 3m(dB $\mu\text{V/m}$)=Limit 30m(dB $\mu\text{V/m}$)+40Log(30m/3m) (Below 30MHz)

Spurious radiated emissions for transmitter

According to C63.10, if the peak (or quasi-peak) measured value complies with the average limit, it is unnecessary to perform an average measurement, so AV emission value did not show in below table if the peak value complies with average limit.

Only the worst case (802.11b) test result is listed in the report.

Transmitting spurious emission test result as below:

For 30-1000MHz:

802.11b SISO 2412MHZ - Horizontal

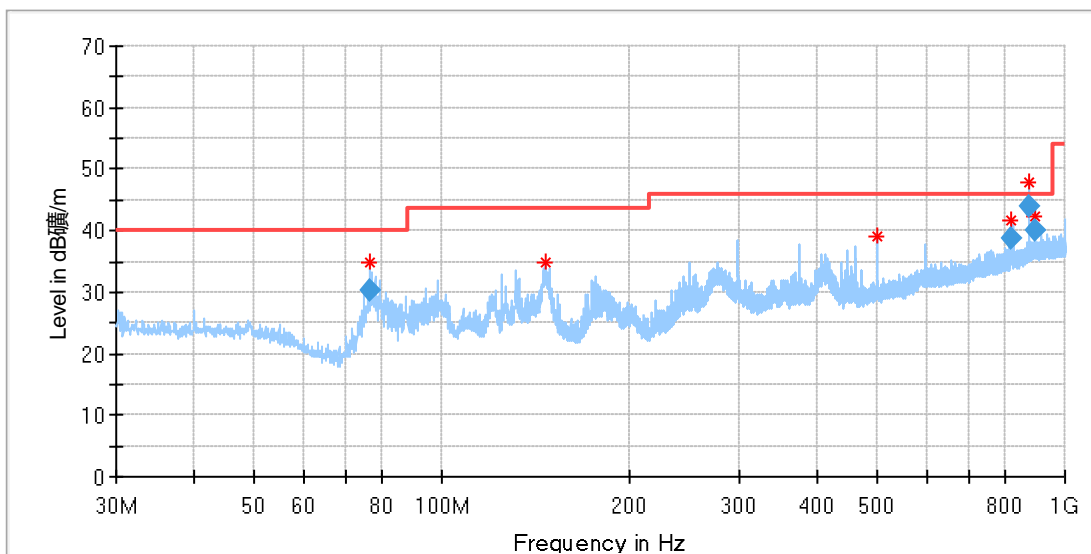

Critical Freqs

Frequency (MHz)	MaxPeak (dBµV/m)	Limit (dBµV/m)	Margin (dB)	Height (cm)	Pol	Azimuth (deg)	Corr. (dB/m)
76.499375	34.85	40.00	5.15	200.0	H	0.0	14.64
146.824375	34.91	43.50	8.59	200.0	H	338.0	15.55
500.025625	38.96	46.00	7.04	100.0	H	71.0	26.02
822.247500	41.71	46.00	4.29	100.0	H	0.0	30.82
875.051875	47.78	46.00	-1.78	100.0	H	156.0	31.80
896.391875	42.47	46.00	3.53	100.0	H	0.0	32.26

Final Result

Frequency (MHz)	QuasiPeak (dBµV/m)	Limit (dBµV/m)	Margin (dB)	Height (cm)	Pol	Azimuth (deg)	Corr. (dB/m)
76.499375	30.20	40.00	9.80	200.0	H	0.0	14.64
822.247500	38.90	46.00	8.10	100.0	H	0.0	30.82
875.051875	43.80	46.00	2.20	100.0	H	156.0	31.80
896.391875	40.20	46.00	6.80	100.0	H	0.0	32.26

802.11b SISO 2412MHZ - Vertical

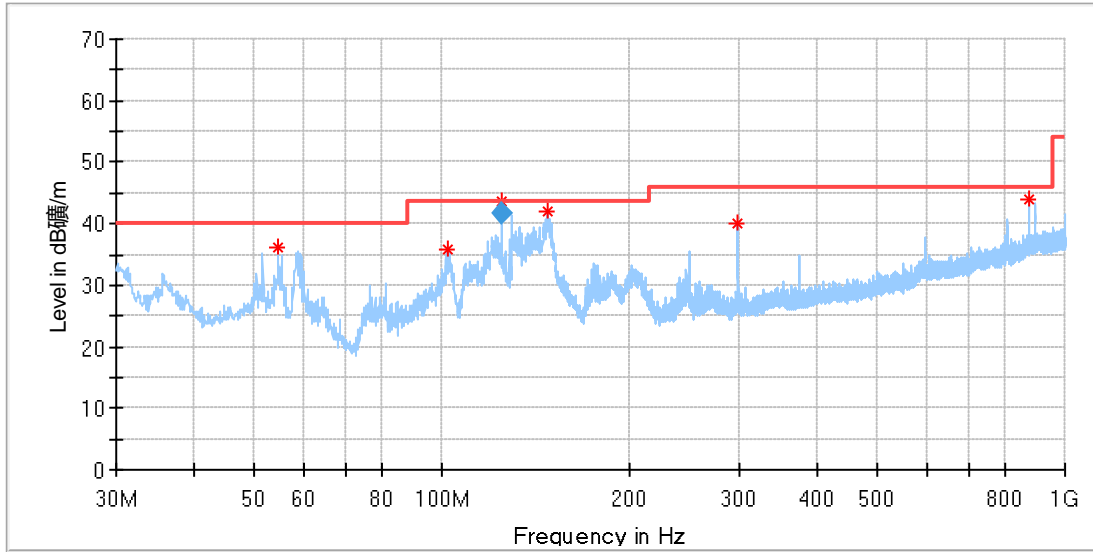

Critical Freqs

Frequency (MHz)	MaxPeak (dBµV/m)	Limit (dBµV/m)	Margin (dB)	Height (cm)	Pol	Azimuth (deg)	Corr. (dB/m)
54.674375	36.00	40.00	4.00	100.0	V	124.0	20.12
101.840625	35.72	43.50	7.78	100.0	V	73.0	19.88
124.999375	43.74	43.50	-0.24	100.0	V	290.0	16.92
147.309375	41.84	43.50	1.66	100.0	V	247.0	15.54
298.568750	40.19	46.00	5.81	200.0	V	208.0	21.60
875.051875	43.99	46.00	2.01	200.0	V	0.0	31.80

Final Result

Frequency (MHz)	QuasiPeak (dBµV/m)	Limit (dBµV/m)	Margin (dB)	Height (cm)	Pol	Azimuth (deg)	Corr. (dB/m)
124.999375	41.70	43.50	1.80	100.0	V	290.0	16.92

For 1000-18000MHz:

802.11b SISO 2412MHZ - Horizontal

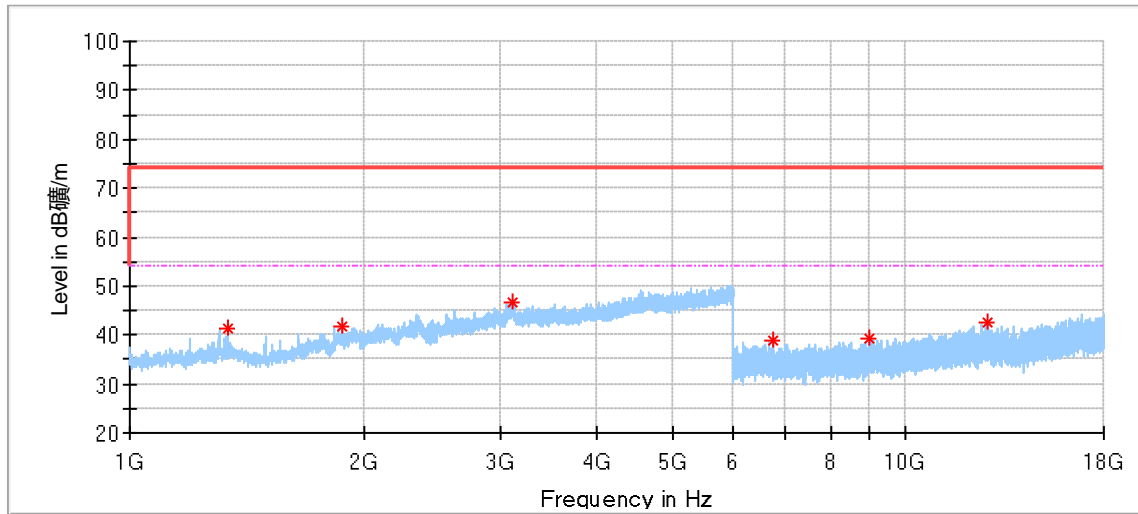

Critical Freqs

Frequency (MHz)	MaxPeak (dBµV/m)	Limit (dBµV/m)	Margin (dB)	Height (cm)	Pol	Azimuth (deg)	Corr. (dB/m)
1338.000000	41.53	74.00	32.47	150.0	H	33.0	-7.82
1880.000000	41.54	74.00	32.46	150.0	H	306.0	-4.82
3112.000000	46.69	74.00	27.31	150.0	H	156.0	1.15
6751.500000	39.04	74.00	34.96	150.0	H	346.0	5.23
8999.000000	39.26	74.00	34.74	150.0	H	152.0	7.63
12742.000000	42.62	74.00	31.38	150.0	H	319.0	11.31

802.11b SISO 2412MHZ - Vertical

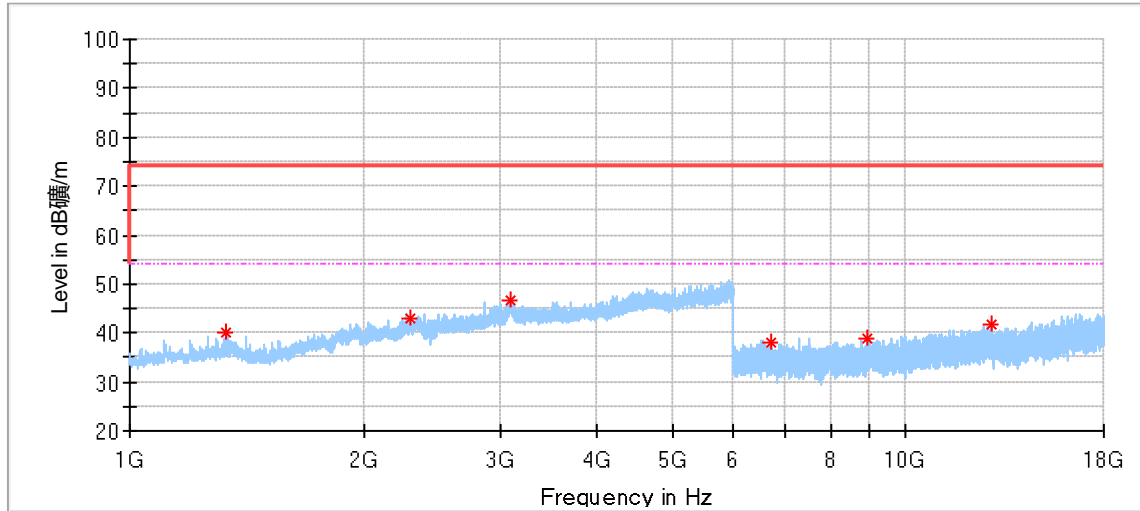

Critical Freqs

Frequency (MHz)	MaxPeak (dBµV/m)	Limit (dBµV/m)	Margin (dB)	Height (cm)	Pol	Azimuth (deg)	Corr. (dB/m)
1334.000000	40.08	74.00	33.92	150.0	V	265.0	-7.86
2300.000000	42.94	74.00	31.06	150.0	V	251.0	-3.25
3090.000000	46.57	74.00	27.43	150.0	V	115.0	1.19
6707.000000	38.26	74.00	35.74	150.0	V	265.0	5.25
8925.000000	38.83	74.00	35.17	150.0	V	237.0	7.61
12864.000000	41.60	74.00	32.40	150.0	V	61.0	11.38

802.11b SISO 2437MHz – Horizontal

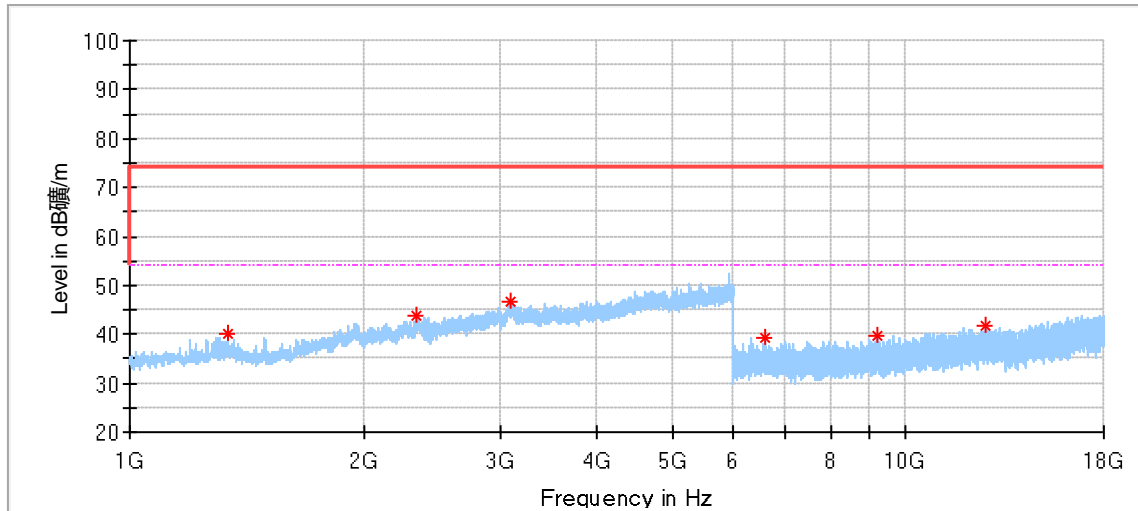

Critical_Freqs

Frequency (MHz)	MaxPeak (dBµV/m)	Limit (dBµV/m)	Margin (dB)	Height (cm)	Pol	Azimuth (deg)	Corr. (dB/m)
1338.000000	40.25	74.00	33.75	150.0	H	19.0	-7.82
2339.500000	43.64	74.00	30.36	150.0	H	169.0	-2.91
3103.000000	46.80	74.00	27.20	150.0	H	347.0	1.48
6589.500000	39.25	74.00	34.75	150.0	H	61.0	5.25
9198.500000	39.84	74.00	34.16	150.0	H	260.0	7.76
12663.000000	41.72	74.00	32.28	150.0	H	232.0	11.27

802.11b SISO 2437MHz – Vertical

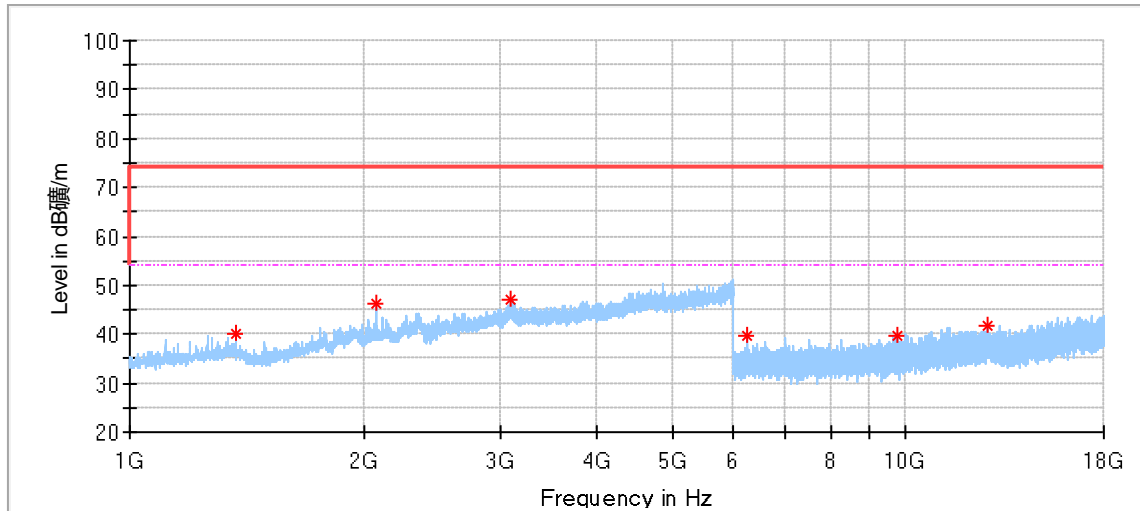

Critical_Freqs

Frequency (MHz)	MaxPeak (dBµV/m)	Limit (dBµV/m)	Margin (dB)	Height (cm)	Pol	Azimuth (deg)	Corr. (dB/m)
1368.000000	40.15	74.00	33.85	150.0	V	251.0	-8.03
2076.000000	46.16	74.00	27.84	150.0	V	224.0	-4.37
3095.500000	47.13	74.00	26.87	150.0	V	320.0	1.41
6258.500000	39.51	74.00	34.49	150.0	V	91.0	5.21
9749.500000	39.59	74.00	34.41	150.0	V	358.0	8.16
12724.000000	41.62	74.00	32.38	150.0	V	61.0	11.30

802.11b SISO 2462MHz – Horizontal

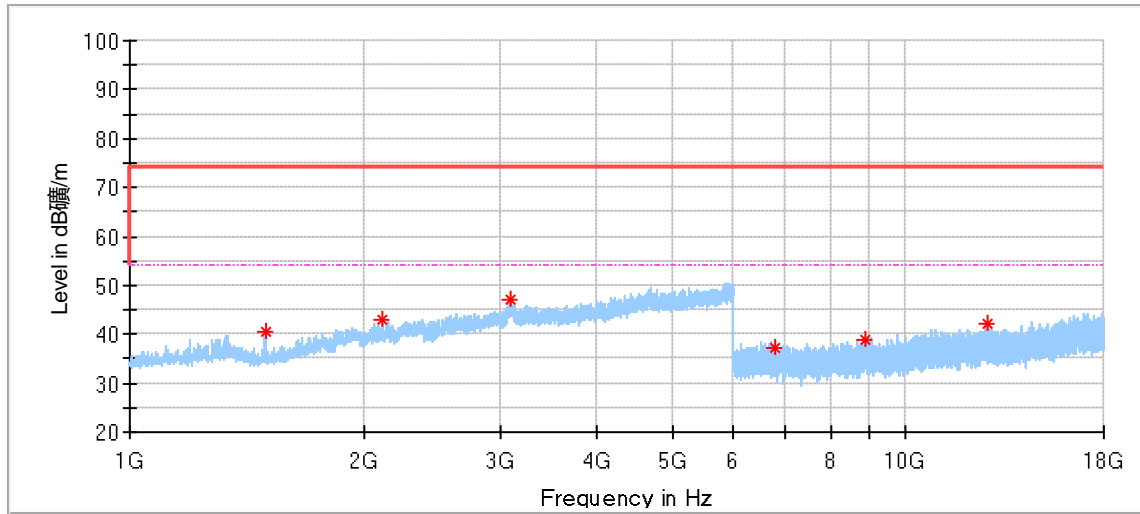

Critical_Freqs

Frequency (MHz)	MaxPeak (dBµV/m)	Limit (dBµV/m)	Margin (dB)	Height (cm)	Pol	Azimuth (deg)	Corr. (dB/m)
1494.500000	40.59	74.00	33.41	150.0	H	235.0	-9.42
2111.000000	42.78	74.00	31.22	150.0	H	29.0	-4.08
3100.500000	47.25	74.00	26.75	150.0	H	111.0	1.56
6772.000000	37.37	74.00	36.63	150.0	H	120.0	5.23
8866.000000	39.04	74.00	34.96	150.0	H	91.0	7.55
12735.000000	42.17	74.00	31.83	150.0	H	207.0	11.30

802.11b SISO 2462MHz – Vertical

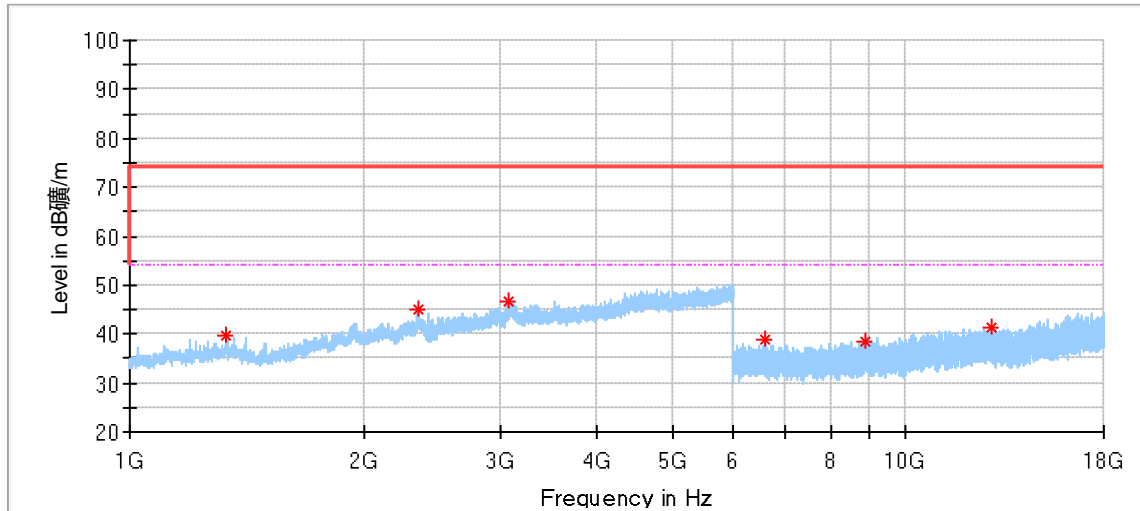

Critical Freqs

Frequency (MHz)	MaxPeak (dBμV/m)	Limit (dBμV/m)	Margin (dB)	Height (cm)	Pol	Azimuth (deg)	Corr. (dB/m)
1332.500000	39.89	74.00	34.11	150.0	V	251.0	-7.88
2353.500000	44.94	74.00	29.06	150.0	V	137.0	-2.75
3078.500000	46.60	74.00	27.40	150.0	V	156.0	0.74
6569.500000	38.71	74.00	35.29	150.0	V	176.0	5.32
8864.000000	38.48	74.00	35.52	150.0	V	32.0	7.55
12895.500000	41.24	74.00	32.76	150.0	V	148.0	11.41

Band edge in restricted frequency bands:

802.11b SISO 2412MHZ – Horizontal

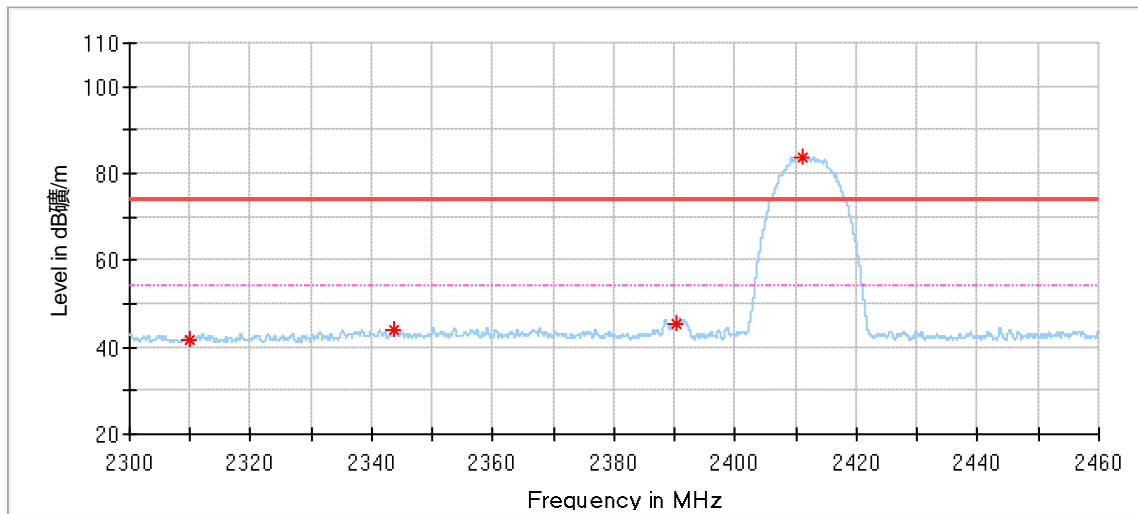

Critical Freqs

Frequency (MHz)	MaxPeak (dBµV/m)	Limit (dBµV/m)	Margin (dB)	Height (cm)	Pol	Azimuth (deg)	Corr. (dB/m)
2310.064000	41.76	74.00	32.24	150.0	H	123.0	-3.74
2343.728000	44.22	74.00	29.78	150.0	H	31.0	-3.49
2390.240000	45.26	74.00	28.74	150.0	H	217.0	-3.05
2411.136000	83.81	74.00	-9.81	150.0	H	236.0	-3.01

802.11b SISO 2412MHZ - Vertical

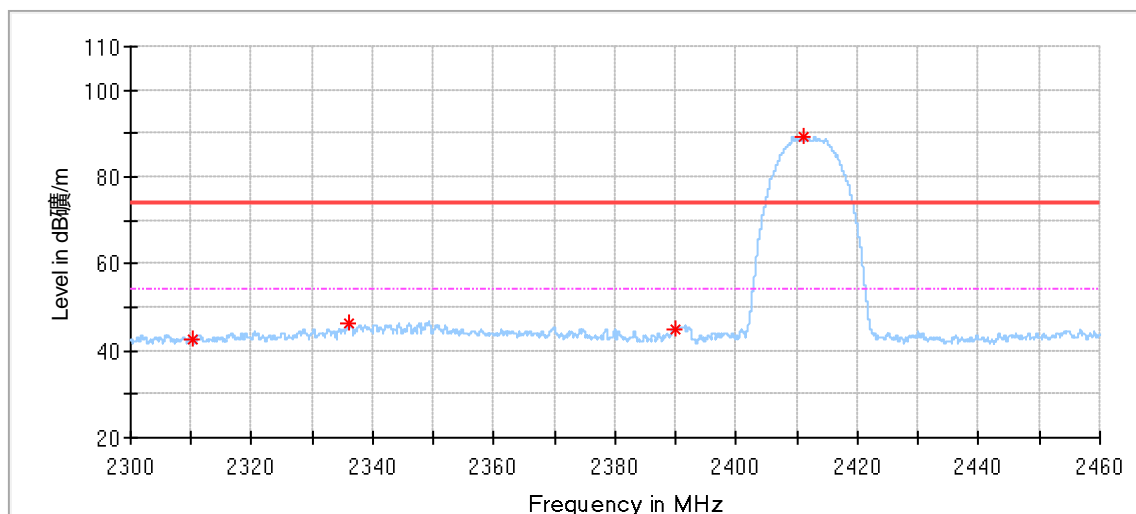

Critical Freqs

Frequency (MHz)	MaxPeak (dBµV/m)	Limit (dBµV/m)	Margin (dB)	Height (cm)	Pol	Azimuth (deg)	Corr. (dB/m)
2310.288000	42.71	74.00	31.29	150.0	V	112.0	-3.74
2336.064000	46.32	74.00	27.68	150.0	V	213.0	-3.57
2390.032000	45.01	74.00	28.99	150.0	V	134.0	-3.05
2411.120000	89.20	74.00	-15.20	150.0	V	213.0	-3.01

802.11b SISO 2462MHZ - Horizontal

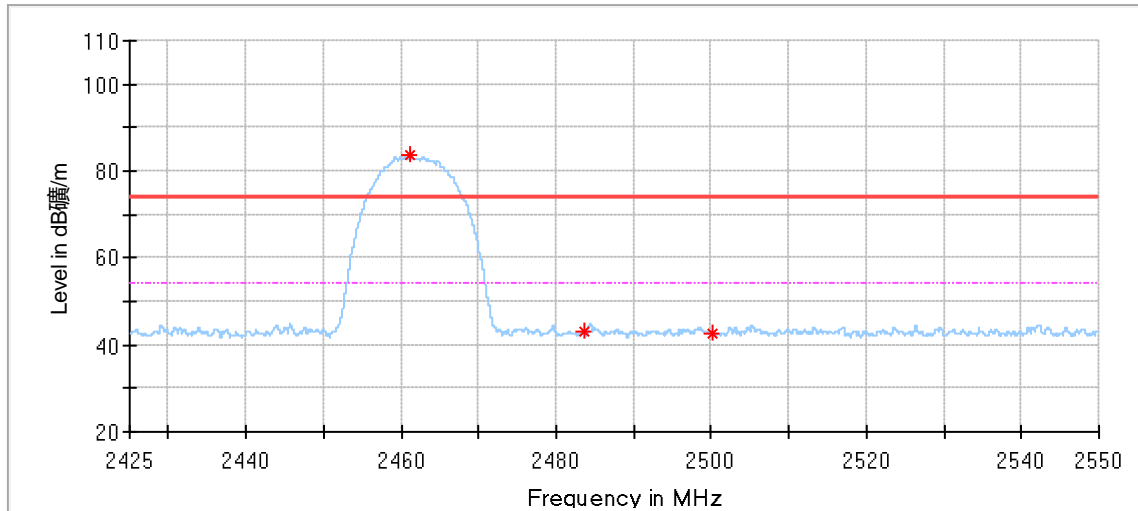

Critical Freqs

Frequency (MHz)	MaxPeak (dBμV/m)	Limit (dBμV/m)	Margin (dB)	Height (cm)	Pol	Azimuth (deg)	Corr. (dB/m)
2461.112500	83.47	74.00	-9.47	150.0	H	51.0	-2.97
2483.600000	43.12	74.00	30.88	150.0	H	142.0	-3.06
2500.137500	42.78	74.00	31.22	150.0	H	0.0	-3.16

802.11b SISO 2462MHZ - Vertical

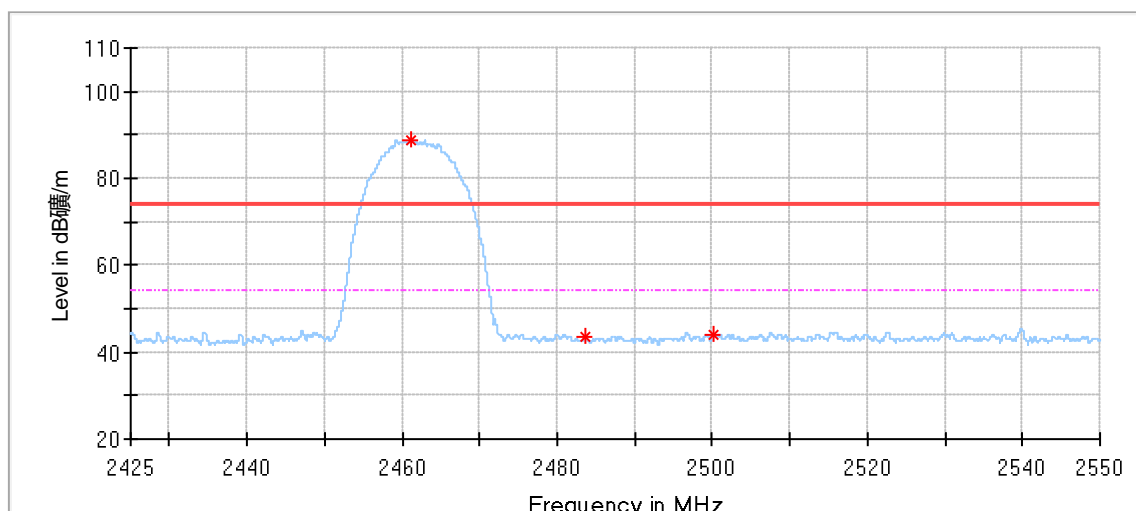

Critical Freqs

Frequency (MHz)	MaxPeak (dBμV/m)	Limit (dBμV/m)	Margin (dB)	Height (cm)	Pol	Azimuth (deg)	Corr. (dB/m)
2461.125000	88.87	74.00	-14.87	150.0	V	216.0	-2.97
2483.600000	43.41	74.00	30.59	150.0	V	207.0	-3.06
2500.037500	43.83	74.00	30.17	150.0	V	225.0	-3.16

Remark:

- (1) "*" means the emission(s) appear within the restrict bands shall follow the requirement of § 15.205.
- (2) Data of measurement within frequency ranges 9kHz-30MHz and 18-26GHz are the noise floor or attenuated more than 20dB below the permissible limits or the field strength is too small to be measured, so test data does not present in this report,
- (3) Level= Reading Level + Correction Factor
- (4) Above 1GHz: Corrector factor = Antenna Factor + Cable Loss- Amplifier Gain
 Below 1GHz: Corrector factor = Antenna Factor + Cable Loss
 (The Reading Level is recorded by software which is not shown in the sheet)

10 Test Equipment List

Conducted Emission Test (AMN)(CSR #2)

DESCRIPTION	MANUFACTURER	MODEL NO.	EQUIPMENT ID	SERIAL NO.	CAL INTERVAL (YEAR)	CAL. DUE DATE
EMI Test Receiver	Rohde & Schwarz	ESR 3	68-4-74-19-002	102590	1	2025-5-13
LISN	Rohde & Schwarz	ENV216	68-4-87-19-001	102472	1	2025-5-12
LISN	Rohde & Schwarz	ENV4200	68-4-87-14-001	100249	1	2025-5-13
Attenuator	Shanghai Huaxiang	TS2-26-3	68-4-81-16-003	080928189	1	2025-5-11
Cable	OUQIAO	RG142	68-4-90-19-005-A20	----	----	----
Test software	Rohde & Schwarz	EMC32	68-4-90-19-005-A01	Version10.35.02	N/A	N/A
Shielding Room	TDK	CSR #2	68-4-90-19-005	----	3	2025-10-15

Radiated Emission Test (30MHz-1GHz) (SAC-3 #1)

DESCRIPTION	MANUFACTURER	MODEL NO.	EQUIPMENT ID	SERIAL NO.	CAL INTERVAL (YEAR)	CAL. DUE DATE
EMI Test Receiver	Rohde & Schwarz	ESR 7	68-4-74-19-001	102176	1	2025-5-13
Trilog Super Broadband Test Antenna	Schwarzbeck	VULB 9163	68-4-80-14-002	707	1	2025-7-2
Attenuator	Mini-circuits	UNAT-6+	68-4-81-21-001	15542	1	2025-5-11
Cable	HUBER-SUHNER	RG214	68-4-90-14-001-A20	----	----	----
3m Semi-anechoic chamber	TDK	SAC-3 #1	68-4-90-14-001	----	3	2026-10-25
Test software	Rohde & Schwarz	EMC32	68-4-90-14-001-A10	Version10.35.02	N/A	N/A

Radiated Emission Test (1GHz-18GHz) (SAC-3 #2)

DESCRIPTION	MANUFACTURER	MODEL NO.	EQUIPMENT ID	SERIAL NO.	CAL INTERVAL (YEAR)	CAL. DUE DATE
EMI Test Receiver	Rohde & Schwarz	ESR 26	68-4-74-14-002	101269	1	2025-5-13
Wave Guide Antenna	ETS	3117	68-4-80-19-001	00218954	1	2025-4-10
Pre-amplifier	Rohde & Schwarz	SCU 18F	68-4-29-19-001	100745	1	2025-5-11
Pre-amplifier	Rohde & Schwarz	SCU 18F	68-4-29-19-002	100746	1	2025-5-11
Cable	OUQIAO	18DLB5-NMNM-7000	68-4-90-19-006-A22	----	----	----
3m Semi-anechoic chamber	TDK	SAC-3 #2	68-4-90-19-006	----	3	2026-10-25
Test software	Rohde & Schwarz	EMC32	68-4-90-19-006-A01	Version10.35.02	N/A	N/A

Radiated Emission Test (18GHz-40GHz) (SAC-3 #2)

DESCRIPTION	MANUFACTURER	MODEL NO.	EQUIPMENT ID	SERIAL NO.	CAL INTERVAL (YEAR)	CAL. DUE DATE
EMI Test Receiver	Rohde & Schwarz	ESR 26	68-4-74-14-002	101269	1	2025-5-13
Sideband Horn Antenna	Q-PAR	QWH-SL-18-40-K-SG	68-4-80-14-008	12827	1	2025-7-2
Pre-amplifier	Rohde & Schwarz	SCU 40A	68-4-29-14-002	100432	1	2025-7-17
Cable	JUNFLON	MWX241	68-4-90-19-006-A21	----	----	----
3m Semi-anechoic chamber	TDK	SAC-3 #2	68-4-90-19-006	----	3	2026-10-25
Test software	Rohde & Schwarz	EMC32	68-4-90-19-006-A01	Version10.35.02	N/A	N/A

11 System Measurement Uncertainty

For a 95% confidence level, the measurement expanded uncertainties for defined systems, in accordance with the recommendations of ISO 17025 were:

System Measurement Uncertainty	
Test Items	Extended Uncertainty
Uncertainty for Conducted Emission in new shielding room (68-4-90-19-005) 150kHz-30MHz (for test using AMN ENV216)	3.14dB
Uncertainty for Radiated Emission in 3m chamber (68-4-90-14-001) 9kHz-30MHz	4.69dB
Uncertainty for Radiated Emission in 3m chamber (68-4-90-14-001) 30MHz-1000MHz	Horizontal: 4.78dB; Vertical: 5.85dB;
Uncertainty for Radiated Emission in new 3m chamber (68-4-90-19-006) 1000MHz-18000MHz	Horizontal: 5.40dB; Vertical: 5.40dB;
Uncertainty for Radiated Spurious Emission 18000MHz-40000MHz	5.10dB;
Uncertainty for Conducted RF test with TS 8997	RF Power Conducted: 1.31dB

Measurement Uncertainty Decision Rule

Determination of conformity with the specification limits is based on the decision rule according to IEC Guide 115: 2023, clause 4.3.3 and 4.3.4

---END OF REPORT---