

TEST REPORT

FCC Test for IT109B016CA
Certification

APPLICANT
DKK North America, Inc.

REPORT NO.
HCT-RF-2408-FC018

DATE OF ISSUE
October 2, 2024

Tested by
Kyung Soo Kang



Technical Manager
Jong Seok Lee



HCT CO., LTD.
Bongjai Huh
BongJai Huh / CEO



HCT CO.,LTD.

2-6, 73, 74, Seoicheon-ro 578beon-gil, Majang-myeon, Icheon-si, Gyeonggi-do, Republic of Korea
Tel. +82 31 645 6300 Fax. +82 31 645 6401

TEST REPORT

REPORT NO.
HCT-RF-2408-FC018

DATE OF ISSUE
October 02, 2024

Applicant **DKK North America, Inc.**
8105 Razor Blvd, Suite 222, Plano, TX USA 75024

Product Name 700/800 0.5W Public Safety BDA
Model Name IT109B016CA

FCC ID 2BKJD-IT109B016-UA

Output Power Uplink: 24 dBm, Downlink: 27 dBm

Date of Test July 10, 2024 ~ September 09, 2024

Location of Test Permanent Testing Lab On Site Testing
(Address: 74, Seoicheon-ro 578beon-gil, Majang-myeon, Icheon-si, Gyeonggi-do, Republic of Korea)

Test Standard Used CFR 47 Part 2, Part 90

Test Results PASS

Manufacturer **innertron**
301, Harmony-ro, Yeonsu-gu, Incheon City 22014 Korea

REVISION HISTORY

The revision history for this test report is shown in table.

Revision No.	Date of Issue	Description
0	October 02, 2024	Initial Release

Notice

Content

Engineering Statement:

The measurements shown in this report were made in accordance with the procedures indicated, and the emissions from this equipment were found to be within the limits applicable. I assume full responsibility for the accuracy and completeness of these measurements, and for the qualifications of all persons taking them. It is further stated that upon the basis of the measurements made, the equipment tested is capable of operation in accordance with the requirements of the FCC Rules under normal use and maintenance.

The results shown in this test report only apply to the sample(s), as received, provided by the applicant, unless otherwise stated.

The test results have only been applied with the test methods required by the standard(s).

The laboratory is not accredited for the test results marked *.

Information provided by the applicant is marked **.

Test results provided by external providers are marked ***.

When confirmation of authenticity of this test report is required, please contact www.hct.co.kr

The test results in this test report are not associated with the ((KS Q) ISO/IEC 17025) accreditation by KOLAS (Korea Laboratory Accreditation Scheme) / A2LA (American Association for Laboratory Accreditation) that are under the ILAC (International Laboratory Accreditation Cooperation) Mutual Recognition Agreement (MRA).

CONTENTS

1. GENERAL INFORMATION	5
1.1. APPLICANT INFORMATION	5
1.2. PRODUCT INFORMATION	5
1.3. TEST INFORMATION	5
2. FACILITIES AND ACCREDITATIONS	6
2.1. FACILITIES	6
2.2. EQUIPMENT	6
3. TEST SPECIFICATIONS	7
3.1. STANDARDS	7
3.2. ADDITIONAL DESCRIPTIONS ABOUT TEST	8
3.3. MEASUREMENT UNCERTAINTY	10
3.4. STANDARDS ENVIRONMENTAL TEST CONDITIONS	10
3.5. TEST DIAGRAMS	11
4. TEST EQUIPMENTS	13
5. TEST RESULT	14
5.1. AGC THRESHOLD	14
5.2. OUT-OF-BAND REJECTION	15
5.3. OCCUPIED BANDWIDTH	18
5.4. INPUT-VERSUS-OUTPUT SIGNAL COMPARISON	39
5.5. INPUT/OUTPUT POWER AND AMPLIFIER/BOOSTER GAIN	58
5.6. NOISE FIGURE	61
5.7. OUT-OF-BAND/OUT-OF-BLOCK EMISSIONS AND SPURIOUS EMISSIONS	65
5.8. RADIATED SPURIOUS EMISSIONS	83
5.9. FREQUENCY STABILITY	86
6. Annex A_EUT AND TEST SETUP PHOTO	93

1. GENERAL INFORMATION

1.1. APPLICANT INFORMATION

Company Name	DKK North America, Inc.
Company Address	8105 Razor Blvd, Suite 222, Plano, TX USA 75024

1.2. PRODUCT INFORMATION

EUT Type	700/800 0.5W Public Safety BDA		
EUT Serial Number	24IT08000000		
Power Supply	100-240 VAC, 50/60 Hz		
Frequency Range	Band Name	Uplink (MHz)	Downlink (MHz)
	Public Safety Narrowband	799 ~ 805	769 ~ 775
	NPSPAC	806 ~ 809	851 ~ 854
	B/ILT; SMR	809 ~ 816	854 ~ 861
	ESMR	817 ~ 824	862 ~ 869
Tx Output Power	Uplink: 24 dBm, Downlink: 27 dBm		
Antenna Peak Gain	Uplink: 9.0 dBi, Downlink: 8.0 dBi		

1.3. TEST INFORMATION

FCC Rule Parts	CFR 47 Part 90
Measurement Standards	KDB 935210 D05 v01r04, KDB 971168 D01 v03r01, ANSI C63.26-2015
Test Location	74, Seoicheon-ro 578beon-gil, Majang-myeon, Icheon-si, Gyeonggi-do, Republic of Korea

2. FACILITIES AND ACCREDITATIONS

2.1. FACILITIES

The SAC(Semi-Anechoic Chamber) and conducted measurement facility used to collect the radiated data are located at the 74, Seoicheon-ro 578beon-gil, Majang-myeon, Icheon-si, Gyeonggi-do, 17383, Rep. of KOREA. The site is constructed in conformance with the requirements of ANSI C63.4. (Version :2014) and CISPR Publication22. Detailed description of test facility was submitted to the Commission and accepted dated March 11, 2024 (CAB identifier: KR0032).

2.2. EQUIPMENT

Radiated emissions are measured with one or more of the following types of linearly polarized antennas: tuned dipole, bi-conical, log periodic, bi-log, and/or ridged waveguide, horn. Spectrum analyzers with pre-selectors and quasi-peak detectors are used to perform radiated measurements.

Calibrated wideband preamplifiers, coaxial cables, and coaxial attenuators are also used for making measurements.

All receiving equipment conforms to CISPR Publication 16-1, "Radio Interference Measuring Apparatus and Measurement Methods."

3. TEST SPECIFICATIONS

3.1. STANDARDS

The following tests were conducted on a sample of the equipment for the purpose of demonstrating compliance with FCC CFR 47 Part 2, Part 90.

Description	Reference	Results
AGC threshold	KDB 935210 D05 v01r04 4.2	Compliant
Out-of-band rejection	KDB 935210 D05 v01r04 4.3	Compliant
Occupied Bandwidth	§ 2.1049 § 90.209, § 90.219(e)(4)(ii)	Compliant
Input-versus-output signal comparison	§ 90.210, § 90.219(e)(4)(iii)	Compliant
Input/output power and amplifier/booster gain	§ 2.1046, § 90.219(e)(1)	Compliant
Noise figure	§ 90.219(e)(2)	Compliant
Out-of-band/out-of-block emissions and spurious emissions	§ 2.1051, § 90.219(e)(3), § 90.543(f)	Compliant
Spurious emissions radiated	§ 2.1053	Compliant
Frequency Stability	§ 90.213	Compliant

3.2. ADDITIONAL DESCRIPTIONS ABOUT TEST

- Except for the following cases, EUT was tested under normal operating conditions.
: Out-of-band rejection test requires maximum gain condition without AGC.
- The test was generally based on the method of KDB 935210 D05 v01r04 and only followed ANSI C63.26-2015 if there was no test method in KDB standard.

- EUT was tested with following modulated signals provide by applicant.

Band Name	Uplink (MHz)	Downlink (MHz)
Public Safety Narrowband	799 ~ 805	769 ~ 775
NPSPAC	806 ~ 809	851 ~ 854
B/ILT; SMR	809 ~ 816	854 ~ 861
ESMR	817 ~ 824	862 ~ 869

- Simultaneous transmission band condition

700 MHz band	800 MHz band
Public Safety Narrowband	NPSPAC, B/ILT; SMR, ESMR

The tests results included actual loss value for attenuator and cable combination as shown in the table below.

: Input Path

Correction factor table			
Frequency (MHz)	Factor (dB)	Frequency (MHz)	Factor (dB)
600	0.873	800	0.891
650	0.872	850	0.877
700	0.855	900	0.947
750	0.895	950	1.005

: Output Path

Correction factor table			
Frequency (MHz)	Factor (dB)	Frequency (MHz)	Factor (dB)
2	29.800	2 000	32.469
10	29.497	2 100	32.463
30	29.808	2 200	32.532
50	31.279	2 300	32.542
100	30.008	2 400	32.699
200	30.403	2 500	32.713
300	30.641	2 600	32.872
400	30.762	2 700	32.914
500	30.970	2 800	32.942
600	31.105	2 900	33.033
700	31.163	3 000	33.048
800	31.279	4 000	33.704
900	31.383	5 000	34.081
1 000	31.491	6 000	33.279
1 100	31.602	7 000	33.543
1 200	31.711	8 000	34.023
1 300	31.770	9 000	34.324
1 400	31.763	10 000	35.259
1 500	31.919	-	-
1 600	32.047	-	-
1 700	32.068	-	-
1 800	32.130	-	-
1 900	32.341	-	-

3.3. MEASUREMENT UNCERTAINTY

Description	Condition	Uncertainty
Radiated Disturbance	9 kHz ~ 30 MHz	± 4.36 dB
	30 MHz ~ 1 GHz	± 5.70 dB
	1 GHz ~ 18 GHz	± 5.52 dB
	18 GHz ~ 40 GHz	± 5.66 dB

Coverage factor $k=2$, Confidence levels of 95 %

3.4. STANDARDS ENVIRONMENTAL TEST CONDITIONS

Temperature	+15 °C to +35 °C
Relative humidity	30 % to 60 %
Air pressure	860 mbar to 1 060 mbar

3.5. TEST DIAGRAMS

Conducted Test

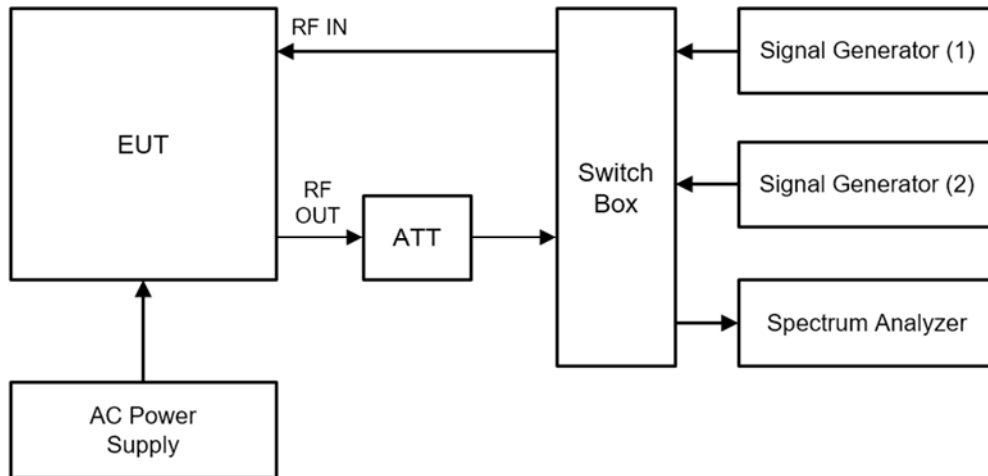

Radiated Test

30 MHz ~ 1 GHz

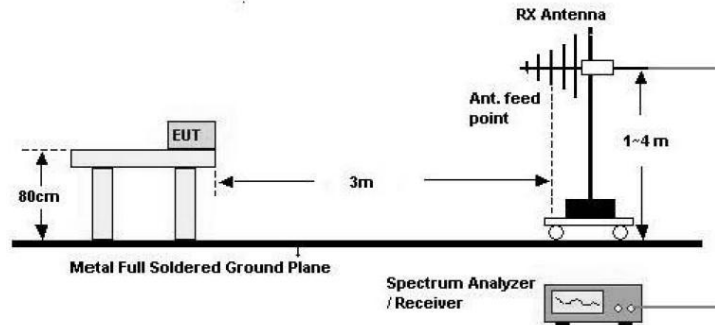

Above 1 GHz

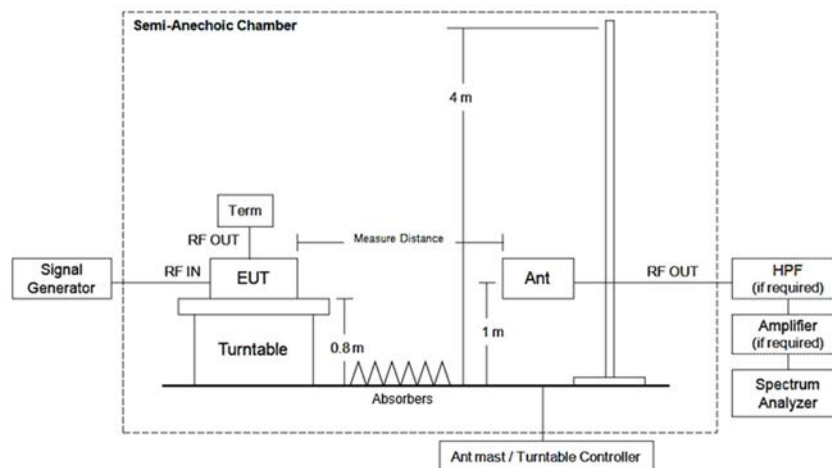

Note: Measure distance for Above 1 GHz is 3 m.

Frequency Stability

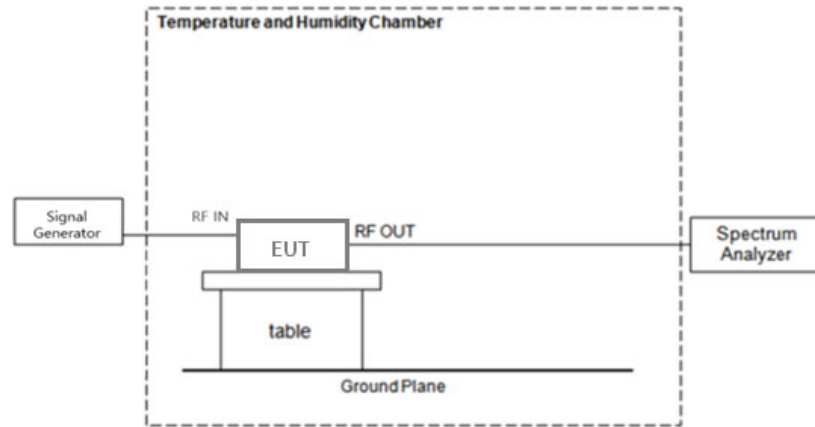

4. TEST EQUIPMENTS

Equipment	Model	Manufacturer	Serial No.	Due to Calibration	Calibration Interval
MXA Signal Analyzer	N9030A	Keysight	MY52350879	04/05/2025	Annual
# MXG Vector Signal Generator	N5182A	Agilent	MY50141649	08/12/2025	Annual
# 30 dB Attenuator	WA93-30-33	Weinschel Associates	0155	11/20/2024	Annual
AC Power Supply	PCR2000MA	KIKUSUI	ZL002530	12/29/2024	Annual
Switch	S46-SV11	KEITHLEY	1088025	N/A	N/A
# 50Ω Termination	908A	H.P.	N/A	N/A	N/A
Temperature and Humidity Chamber	NY-THR18750	NANGYEAL	NY-200912201A	01/04/2025	Annual
Amp & Filter Bank Switch Controller	FBSM-01B	TNM system	TM20090002	N/A	N/A
Controller(Antenna Mast & Turn Table)	CO3000	Innco systems	CO3000/1251/48920320/P	N/A	N/A
Antenna Position Tower	MA4640/800-XP-EP	Innco systems	N/A	N/A	N/A
Turn Table	DS2000-S	Innco systems	N/A	N/A	N/A
Turn Table	N/A	Ets	N/A	N/A	N/A
Loop Antenna	FMZB 1513	Rohde & Schwarz	1513-333	03/07/2026	Biennial
Hybrid Antenna	VULB 9160-31	Schwarzbeck	9168-0895	03/09/2025	Biennial
Horn Antenna	BBHA 9120D	Schwarzbeck	9120D-937	02/13/2025	Biennial
Horn Antenna	BBHA9170	Schwarzbeck	BBHA9170124	03/28/2025	Biennial
RF Switching System	FBSR-04C	TNM system	S4L1	04/11/2025	Annual
Low Noise Amplifier	TK-PA1840H	TESTEK	170011-L	10/20/2024	Annual
High Pass Filter	WHKX10-900-1000-15000-40SS	WAINWRIGHT INSTRUMENTS	16	07/24/2025	Annual

This equipment has been used to each port or each band, but we only listed one equipment for simplicity.

Note:

1. Equipment listed above that calibrated during the testing period was set for test after the calibration.
2. Equipment listed above that has a calibration due date during the testing period, the testing is completed before equipment expiration date.

5. TEST RESULT

5.1. AGC THRESHOLD

Test Requirement:

KDB 935210 D05 v01r04

Testing at and above the AGC threshold is required.

Test Procedures:

Measurements were in accordance with the test methods section 4.2 of KDB 935210 D05 v01r04.

Testing at and above the AGC threshold will be required. The AGC threshold shall be determined by applying the procedure of 3.2, but with the signal generator configured to produce a test signal defined in Table 1, a CW input signal, or a digitally modulated signal, consistent with the discussion about signal types in 4.1.

Measurement were in accordance with the test methods in subclause 7.2.3.1 of ANSI C63.26.

- a) Connect a signal generator to the input of the EUT.
- b) Connect a spectrum analyzer or power meter to the output of the EUT using appropriate attenuation.
- c) The signal generator must be set for CW operation.
- d) While monitoring the output of the EUT, increase the input level until a 1 dB increase in the input signal no longer causes a 1 dB increase in the output signal.
- e) This is the AGC threshold level of the EUT.

Test Results:

Test Band	Link	Signal	Center Frequency (MHz)	AGC Threshold Level (dBm)	Output Level (dBm)
Public Safety Narrowband	Uplink	P25 Phase 1	802.00	-56	23.62
	Downlink		772.00	-63	27.19
NPSPAC	Uplink		807.50	-56	23.17
	Downlink		852.50	-63	26.79
B/ILT; SMR	Uplink		812.50	-56	23.49
	Downlink		857.50	-63	26.98
ESMR	Uplink		820.50	-56	23.68
	Downlink		865.50	-63	26.48

5.2. OUT-OF-BAND REJECTION

Test Requirement:

KDB 935210 D05 v01r04

Out-of-band rejection required.

Test Procedures:

Measurements were in accordance with the test methods section 4.3 of KDB 935210 D05 v01r04.

A signal booster shall reject amplification of other signals outside of its passband. Adjust the internal gain control of the EUT to the maximum gain for which equipment certification is sought.

- a) Connect a signal generator to the input of the EUT.
- b) Configure a swept CW signal with the following parameters:
 - 1) Frequency range = ± 250 % of the manufacturer's specified pass band.
 - 2) The CW amplitude shall be 3 dB below the AGC threshold (see 4.2), and shall not activate the AGC threshold throughout the test.
 - 3) Dwell time = approximately 10 ms.
 - 4) Frequency step = 50 kHz.
- c) Connect a spectrum analyzer to the output of the EUT using appropriate attenuation.
- d) Set the RBW of the spectrum analyzer to between 1 % and 5 % of the manufacturer's rated passband, and VBW = $3 \times$ RBW.
- e) Set the detector to Peak and the trace to Max-Hold.
- f) After the trace is completely filled, place a marker at the peak amplitude, which is designated as f_0 , and with two additional markers (use the marker-delta method) at the 20 dB bandwidth (i.e., at the points where the level has fallen by 20 dB).
- g) Capture the frequency response plot for inclusion in the test report.

Test Results:

Public Safety Narrowband(799 ~ 805 MHz) / Uplink

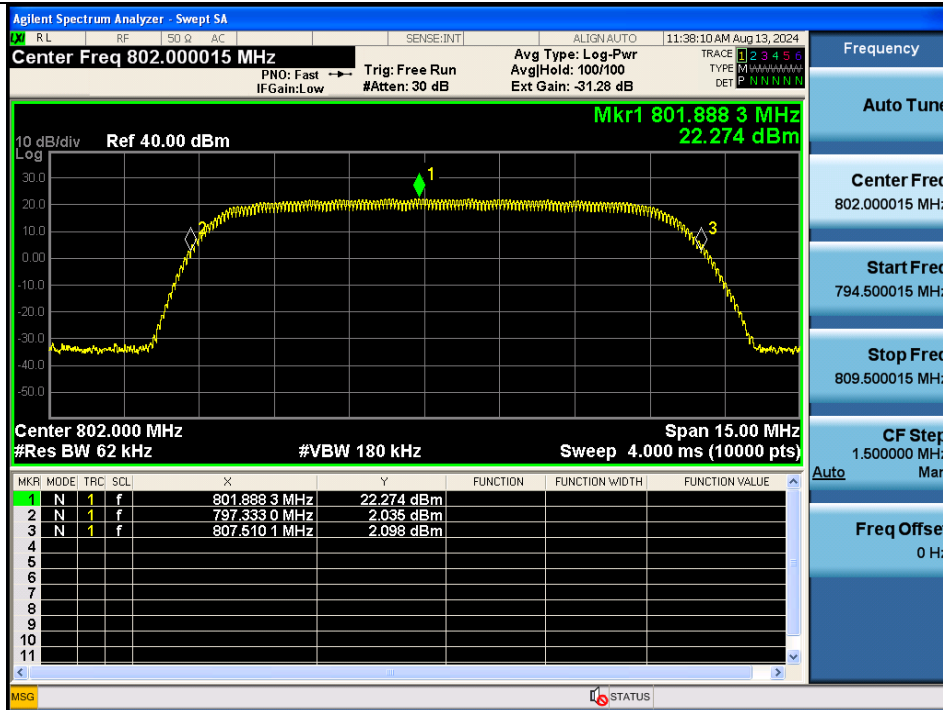

Note: The EUT is amplified over a frequency range of 788 ~ 806 MHz, but this test report uses the results for the frequency range of 799 ~ 805 MHz.

800 MHz (NPSPAC, B/ILT; SMR, ESMR) / Uplink

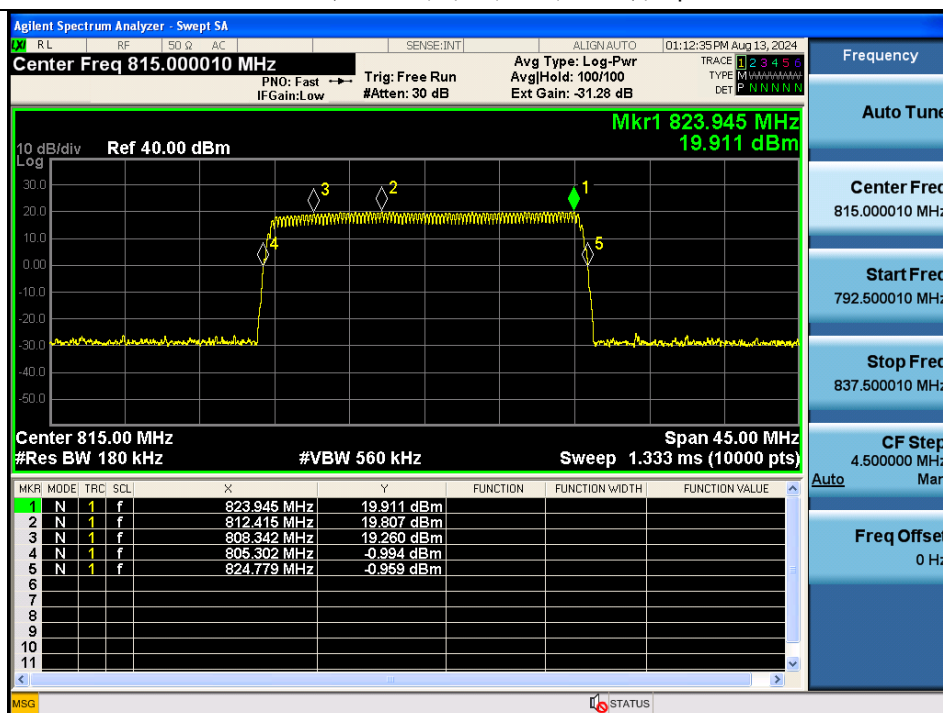

Note: The EUT is amplified over a frequency range of 806 ~ 824 MHz, but this test report uses the results for the frequency range of 806 ~ 809 MHz, 809 ~ 816 MHz, 817 ~ 824 MHz.

Public Safety Narrowband / Downlink

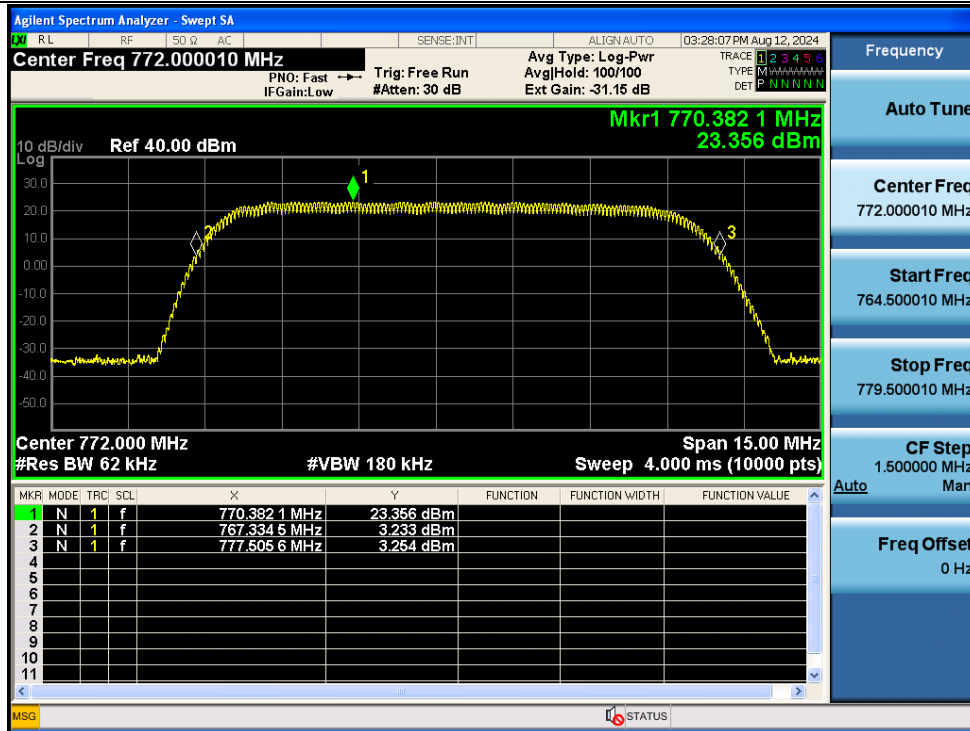

Note: The EUT is amplified over a frequency range of 758 ~ 776 MHz, but this test report uses the results for the frequency range of 769 ~ 775 MHz.

800 MHz (NPSPAC, B/ILT; SMR, ESMR) / Downlink

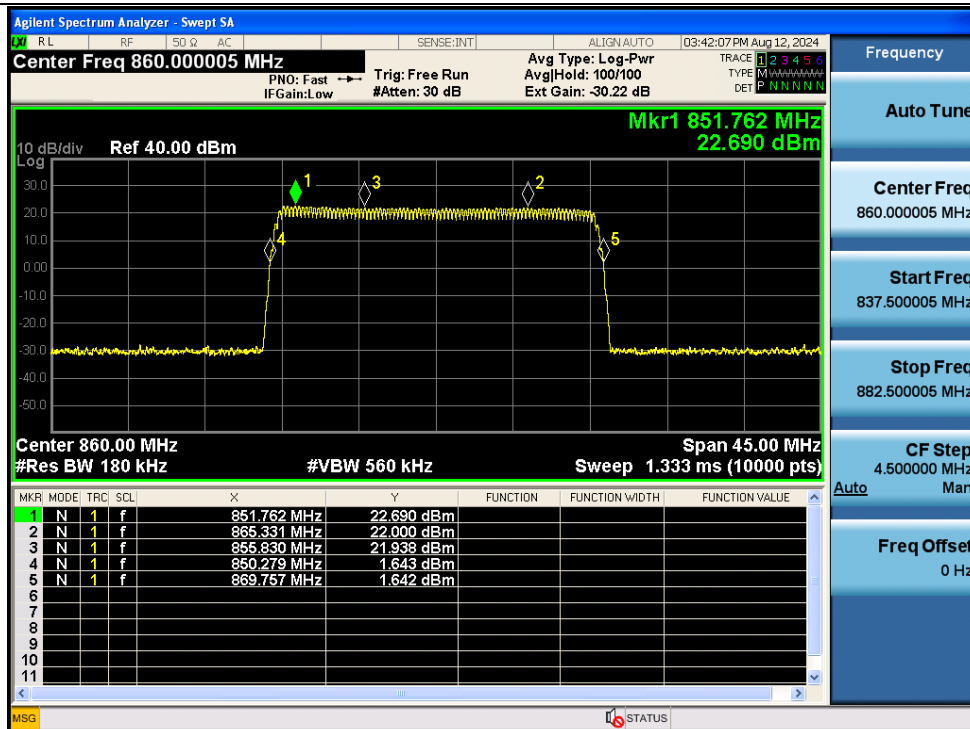

Note: The EUT is amplified over a frequency range of 851 ~ 869 MHz, but this test report uses the results for the frequency range of 851 ~ 854 MHz, 854 ~ 861 MHz, 862 ~ 869 MHz.

5.3. OCCUPIED BANDWIDTH

Test Requirement:

§ 2.1049 Measurements required: Occupied bandwidth.

The occupied bandwidth, that is the frequency bandwidth such that, below its lower and above its upper frequency limits, the mean powers radiated are each equal to 0.5 percent of the total mean power radiated by a given emission shall be measured under the specified conditions of § 2.1049 (a) through (i) as applicable.

§ 90.209 Bandwidth limitations.

Table 1 to § 90.209(b)(5) - Standard Channel Spacing/Bandwidth

Frequency band (MHz)	Channel spacing (kHz)	Authorized bandwidth (kHz)
Below 25		
25-50	20	20
72-76	20	20
150-174	7.5	¹ 20/11.25/6
216-220	6.25	20/11.25/6
220-222	5	4
406-512	6.25	20/11.25/6
806-809/851-854 [#]	12.5	20
809-817/854-862	12.5	20/11.25
817-824/862-869	25	20
896-901/935-940	12.5	13.6
902-928		
929-930	25	20
1427-1432	12.5	12.5
2450-2483.5		
Above 2500		

§ 90.219 Use of signal boosters.

(e) Device Specifications. In addition to the general rules for equipment certification in § 90.203(a)(2) and part 2, subpart J of this chapter, a signal booster must also meet the rules in this paragraph.

(4) A signal booster must be designed such that all signals that it retransmits meet the following requirements:

(ii) There is no change in the occupied bandwidth of the retransmitted signals.

Test Procedures:

Measurements were in accordance with the test methods section 5.4.4 of ANSI C63.26-2015.

- a) The spectrum analyzer center frequency is set to the nominal EUT channel center frequency. The frequency span for the spectrum analyzer shall be set wide enough to capture all modulation products including the emission skirts (typically a span of $1.5 \times \text{OBW}$ is sufficient).
- b) The nominal IF filter 3 dB bandwidth (RBW) shall be in the range of 1% to 5% of the anticipated OBW, and the VBW shall be set $\geq 3 \times \text{RBW}$.
- c) Set the reference level of the instrument as required to prevent the signal amplitude from exceeding the maximum spectrum analyzer input mixer level for linear operation. See guidance provided in 4.2.3.
NOTE—Step a), step b), and step c) may require iteration to adjust within the specified tolerances.
- d) Set the detection mode to peak, and the trace mode to max-hold.
- e) Omit
- f) The OBW shall be reported and plot(s) of the measuring instrument display shall be provided with the test report. The frequency and amplitude axis and scale shall be clearly labeled. Tabular data can be reported in addition to the plot(s).

Test Results:

Tabular data of Input Occupied Bandwidth

Test Band	Link	Signal	No. of Carriers	Center Frequency (MHz)	99 % OBW (kHz)	26 dB OBW (kHz)
Public Safety Narrowband	Uplink	P25 Phase 1	1	802.00	8.2914	11.292
	Downlink		1	772.00	8.2197	11.123
NPSPAC	Uplink		1	807.50	8.2387	10.919
	Downlink		1	852.50	8.3164	11.886
B/ILT; SMR	Uplink		1	812.50	8.2111	10.786
	Downlink		1	857.50	8.2031	11.459
ESMR	Uplink		1	820.50	8.2956	11.091
	Downlink		1	865.50	8.1897	11.264

Tabular data of Output Occupied Bandwidth

Test Band	Link	Signal	No. of Carriers	Center Frequency (MHz)	99 % OBW (kHz)	26 dB OBW (kHz)
Public Safety Narrowband	Uplink	P25 Phase 1	1	802.00	8.2623	11.388
	Downlink		1	772.00	8.2418	10.987
NPSPAC	Uplink		1	807.50	8.1743	11.367
	Downlink		1	852.50	8.4028	11.869
B/ILT; SMR	Uplink		1	812.50	8.2841	11.253
	Downlink		1	857.50	8.3647	11.141
ESMR	Uplink		1	820.50	8.1100	11.006
	Downlink		1	865.50	8.2577	10.946

Tabular data of 3 dB above the AGC threshold Input Occupied Bandwidth

Test Band	Link	Signal	No. of Carriers	Center Frequency (MHz)	99 % OBW (kHz)	26 dB OBW (kHz)
Public Safety Narrowband	Uplink	P25 Phase 1	1	802.00	8.2388	10.771
	Downlink		1	772.00	8.2504	10.949
NPSPAC	Uplink		1	807.50	8.2167	11.219
	Downlink		1	852.50	8.2599	10.479
B/ILT; SMR	Uplink		1	812.50	8.3289	11.074
	Downlink		1	857.50	8.3859	11.171
ESMR	Uplink		1	820.50	8.2653	11.059
	Downlink		1	865.50	8.2348	11.491

Tabular data of 3 dB above the AGC threshold Output Occupied Bandwidth

Test Band	Link	Signal	No. of Carriers	Center Frequency (MHz)	99 % OBW (kHz)	26 dB OBW (kHz)
Public Safety Narrowband	Uplink	P25 Phase 1	1	802.00	8.2182	10.698
	Downlink		1	772.00	8.3098	11.030
NPSPAC	Uplink		1	807.50	8.2202	11.102
	Downlink		1	852.50	8.2476	10.399
B/ILT; SMR	Uplink		1	812.50	8.1613	11.438
	Downlink		1	857.50	8.1126	11.406
ESMR	Uplink		1	820.50	8.3220	11.063
	Downlink		1	865.50	8.1928	11.376

Measured Occupied Bandwidth Comparison

Test Band	Link	Signal	No. of Carriers	Variant of Input and output Occupied Bandwidth (%)	Variant of Input and 3 dB above the AGC threshold output Occupied Bandwidth (%)
Public Safety Narrowband	Uplink	P25 Phase 1	1	0.85	-0.68
	Downlink		1	-1.22	0.74
NPSPAC	Uplink		1	4.10	-1.04
	Downlink		1	-0.14	-0.76
B/ILT; SMR	Uplink		1	4.33	3.29
	Downlink		1	-2.78	2.10
ESMR	Uplink		1	-0.77	0.04
	Downlink		1	-2.82	-1.00

Change in input-output OBW is less than $\pm 5\%$.

Plot data of Occupied Bandwidth

Input / Public Safety Narrowband / 1 Carrier / Uplink / P25 Phase 1

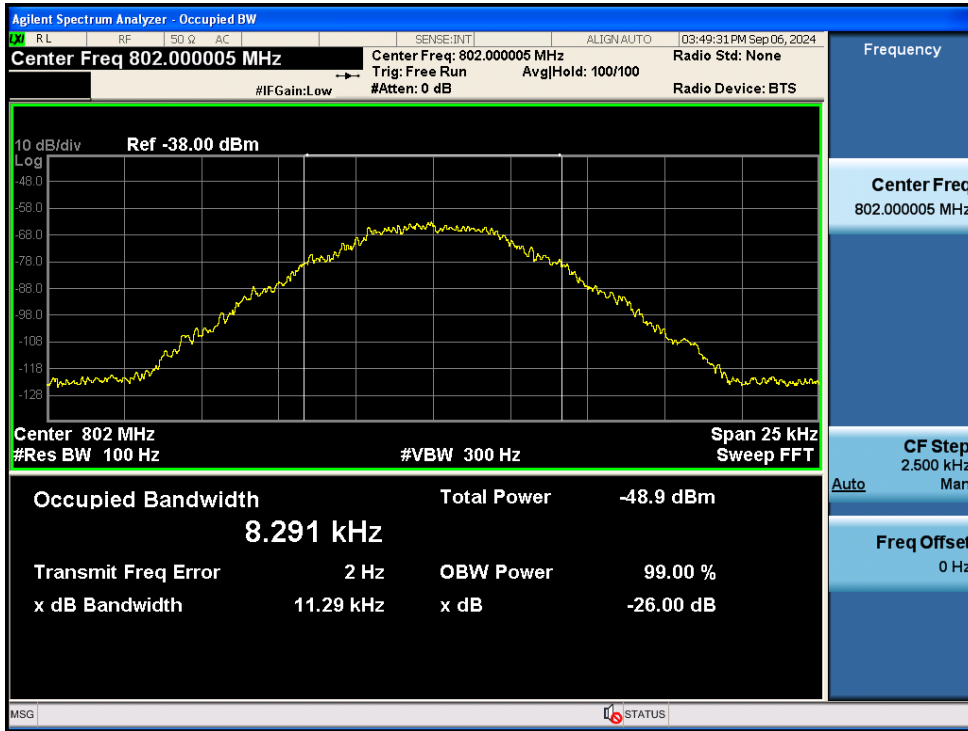

Output / Public Safety Narrowband / 1 Carrier / Uplink / P25 Phase 1

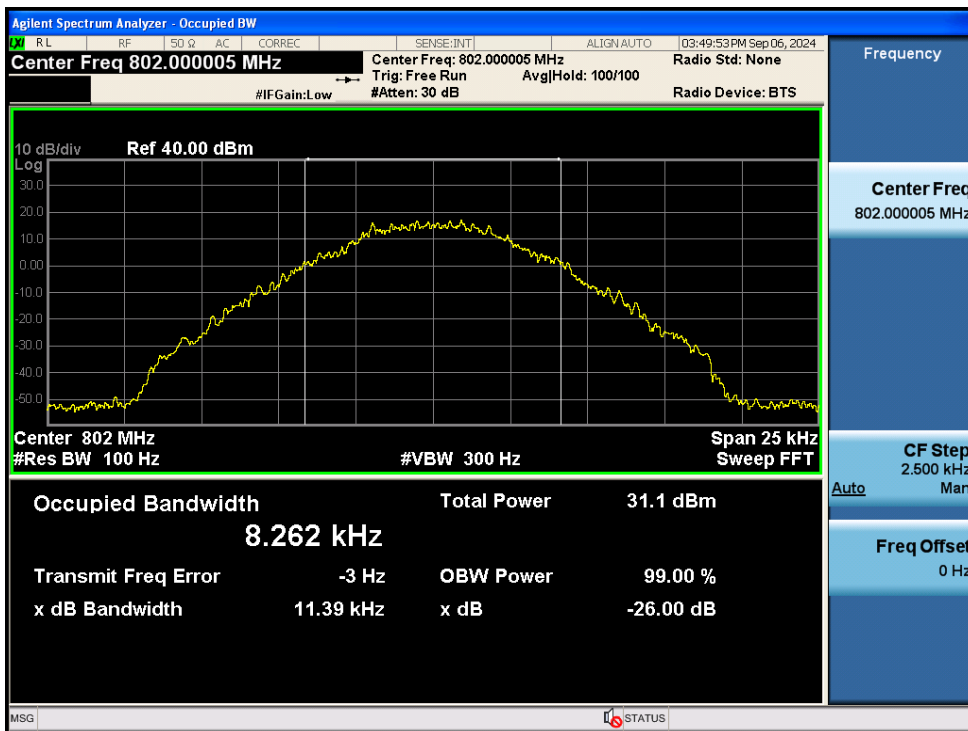

3 dB above the AGC threshold Input / Public Safety Narrowband / 1 Carrier / Uplink / P25 Phase 1

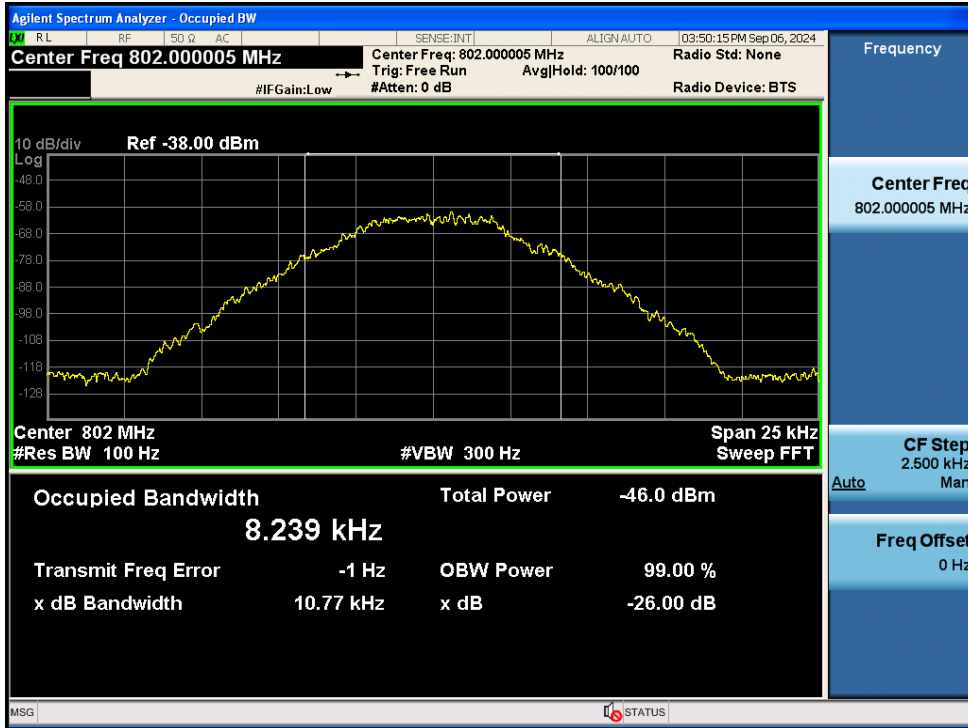

3 dB above the AGC threshold output / Public Safety Narrowband / 1 Carrier / Uplink / P25 Phase 1

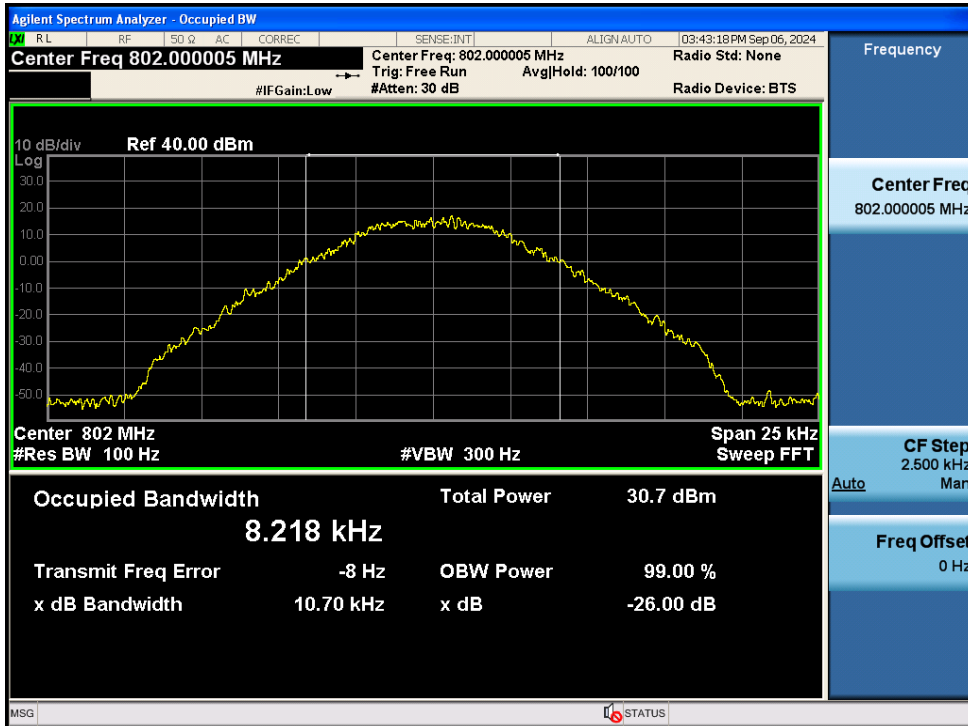

Input / NPSPAC / 1 Carrier / Uplink / P25 Phase 1

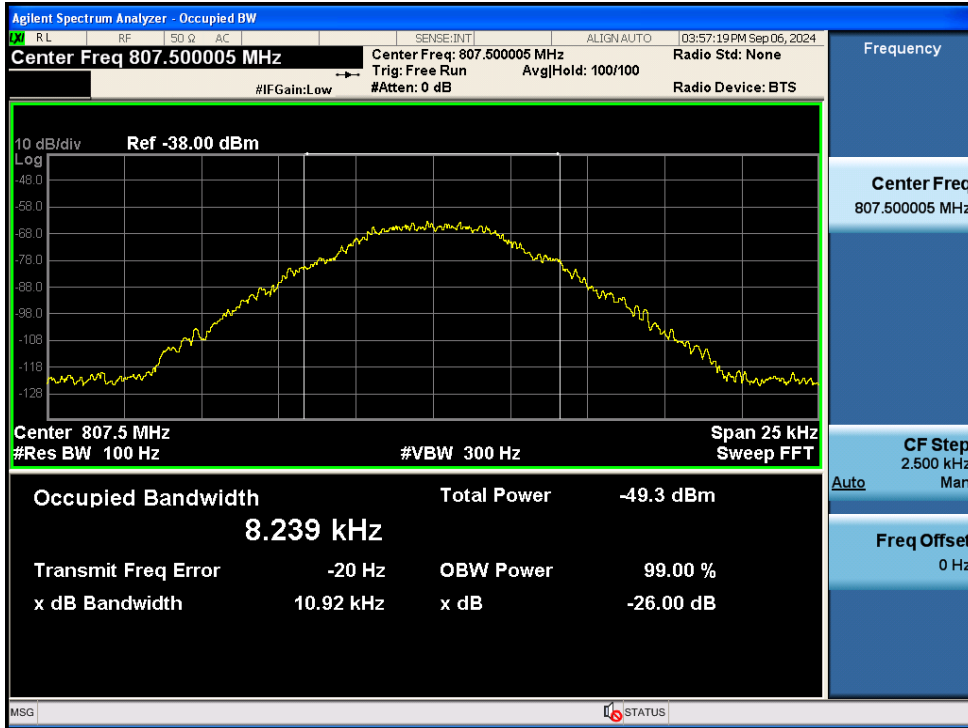

Output / NPSPAC / 1 Carrier / Uplink / P25 Phase 1

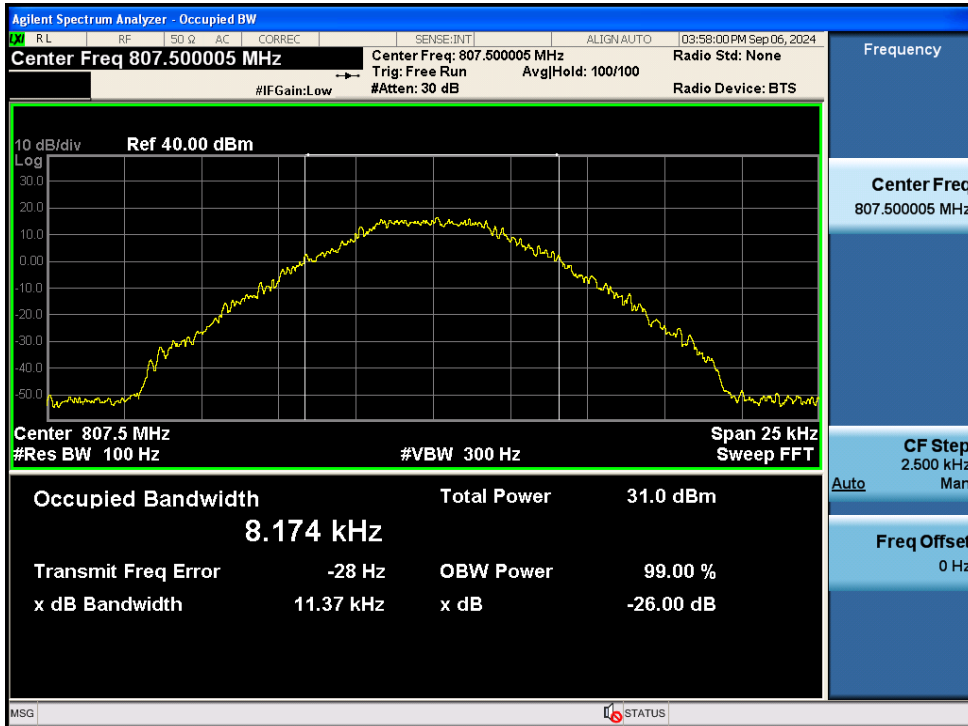

3 dB above the AGC threshold Input / NPSPAC / 1 Carrier / Uplink / P25 Phase 1

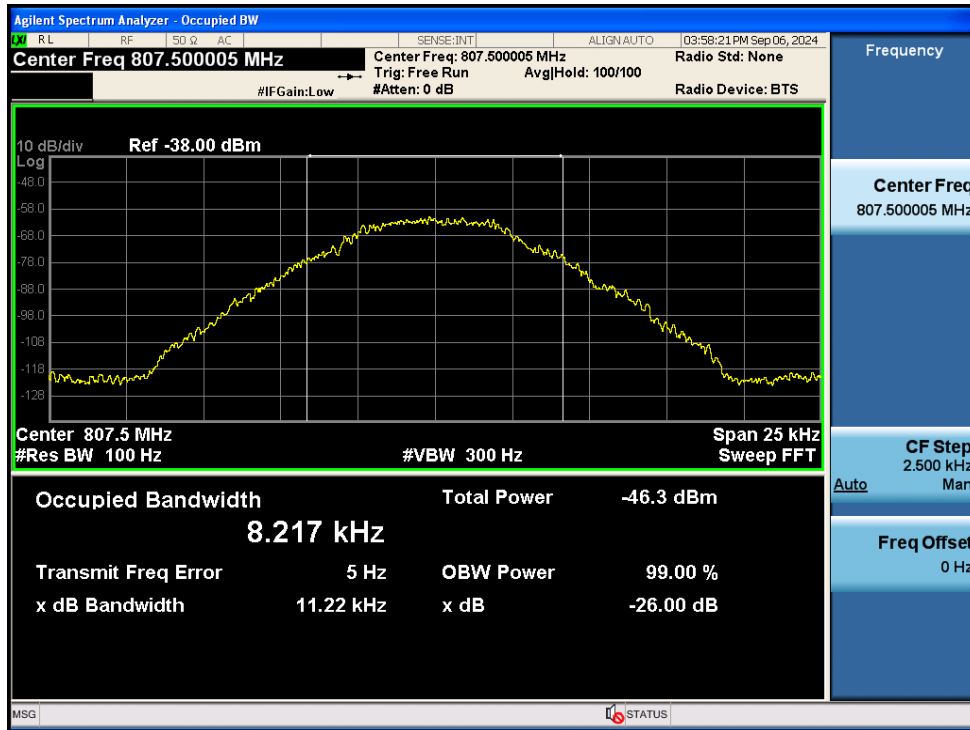

3 dB above the AGC threshold output / NPSPAC / 1 Carrier / Uplink / P25 Phase 1



Input / B/ILT; SMR / 1 Carrier / Uplink / P25 Phase 1

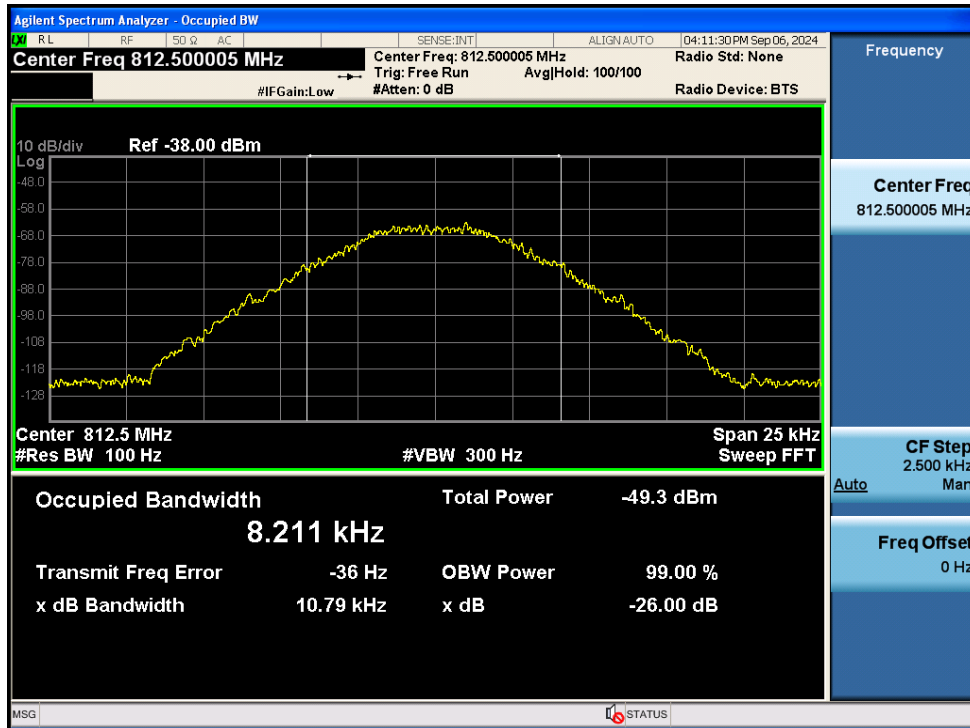

Output / B/ILT; SMR / 1 Carrier / Uplink / P25 Phase 1

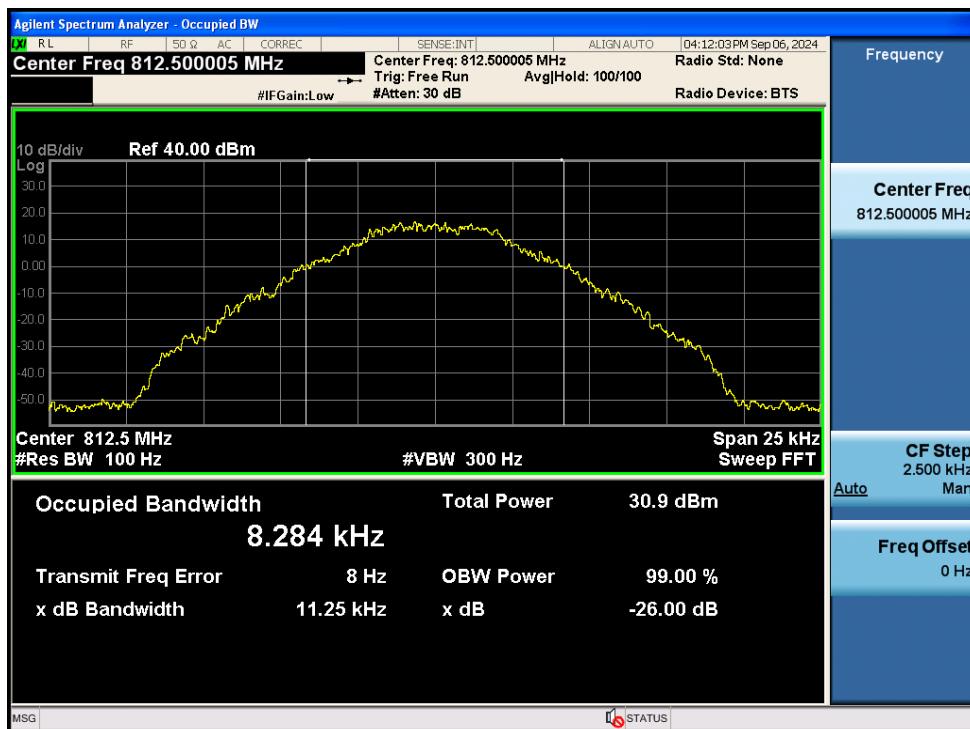

3 dB above the AGC threshold Input / B/ILT; SMR / 1 Carrier / Uplink / P25 Phase 1

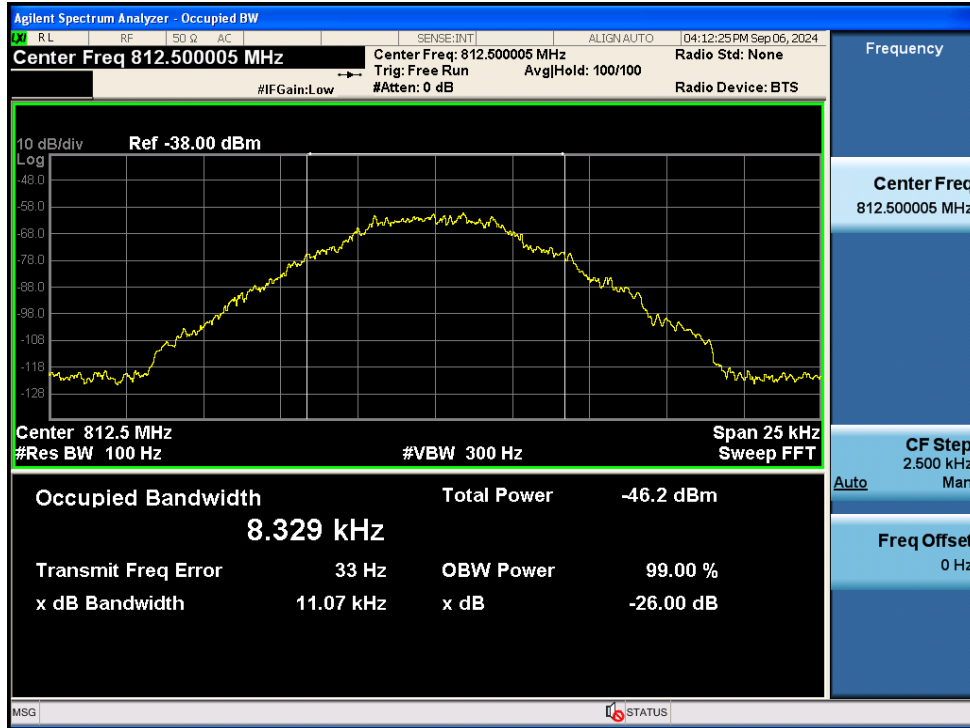

3 dB above the AGC threshold output / B/ILT; SMR / 1 Carrier / Uplink / P25 Phase 1

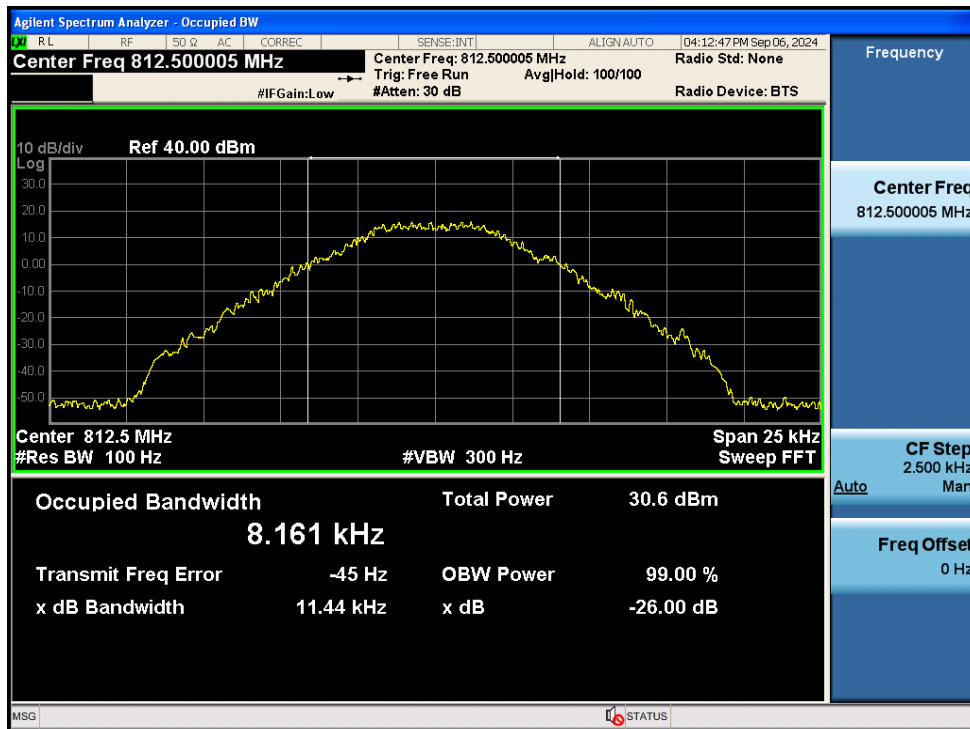

Input / ESMR / 1 Carrier / Uplink / P25 Phase 1

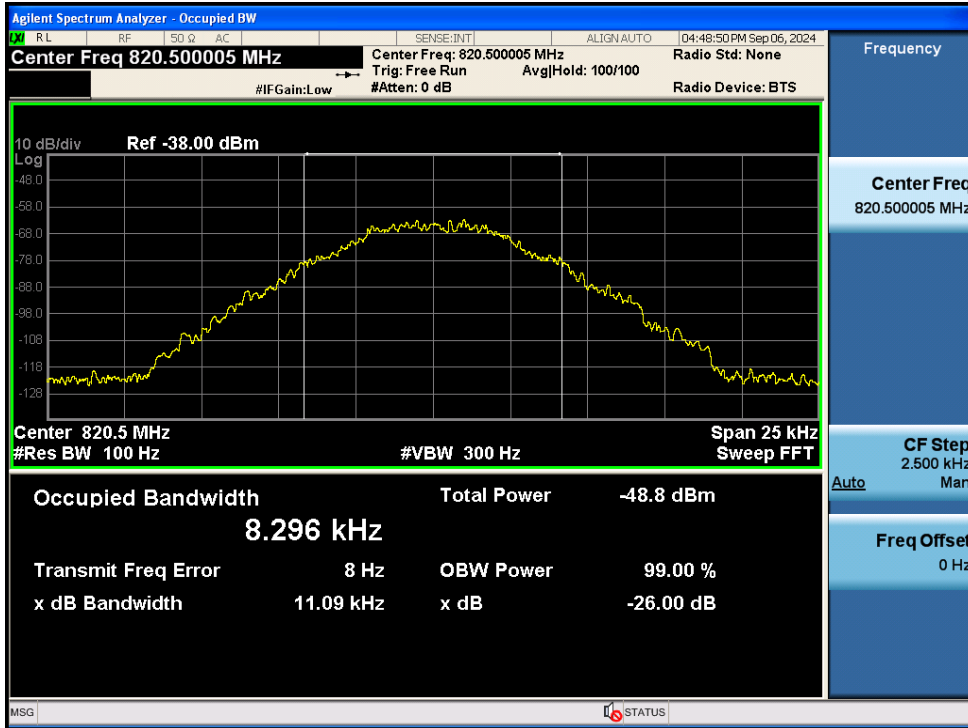

Output / ESMR / 1 Carrier / Uplink / P25 Phase 1

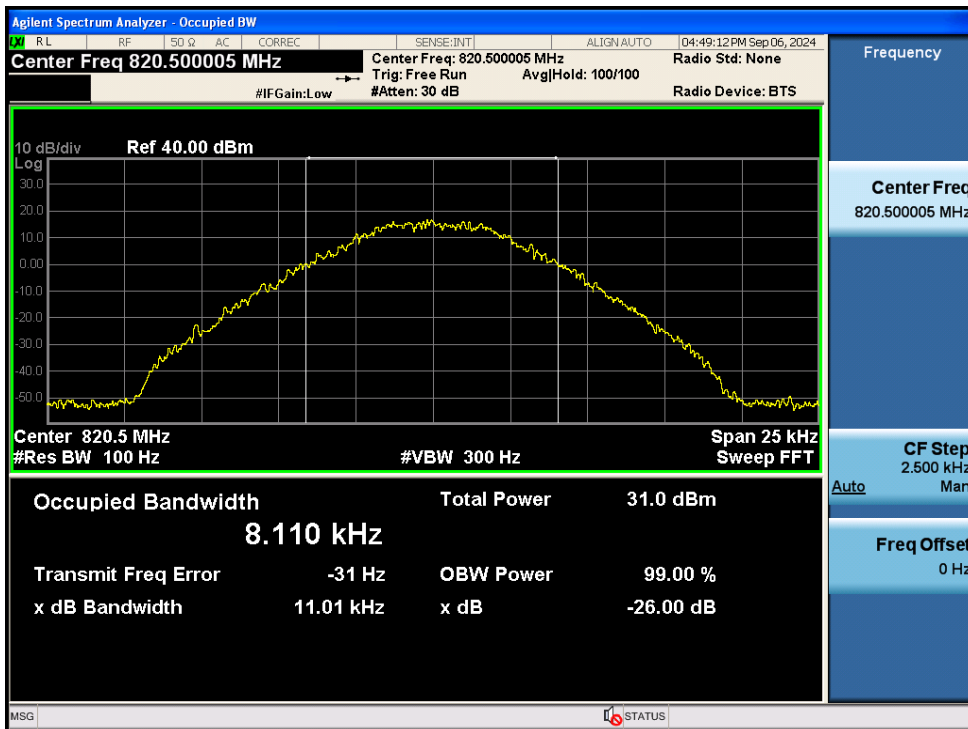

3 dB above the AGC threshold Input / ESMR / 1 Carrier / Uplink / P25 Phase 1

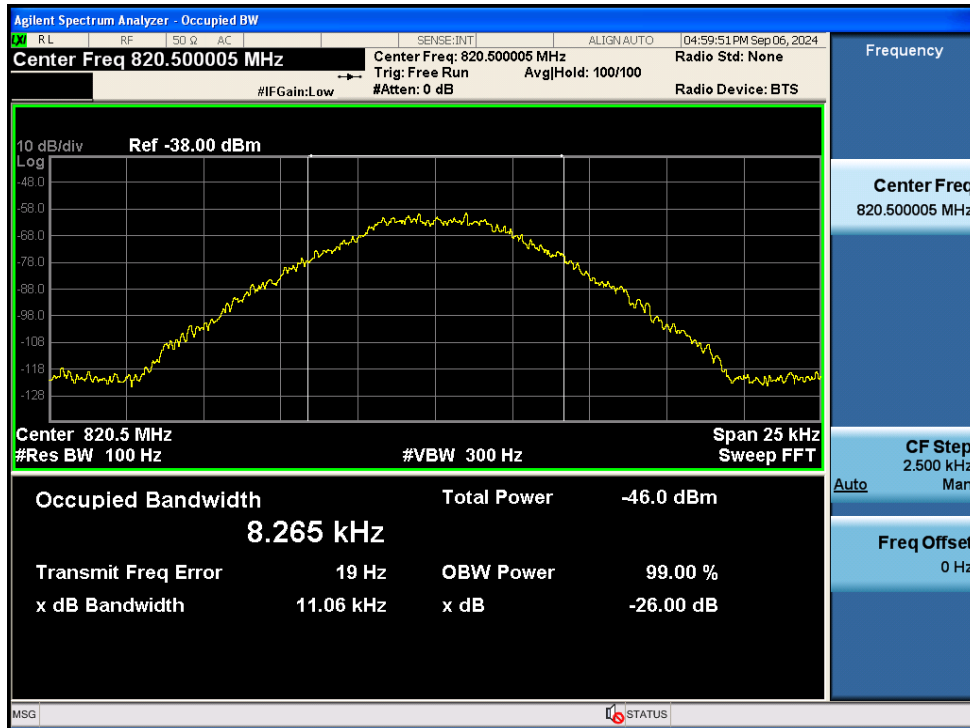

3 dB above the AGC threshold output / ESMR / 1 Carrier / Uplink / P25 Phase 1

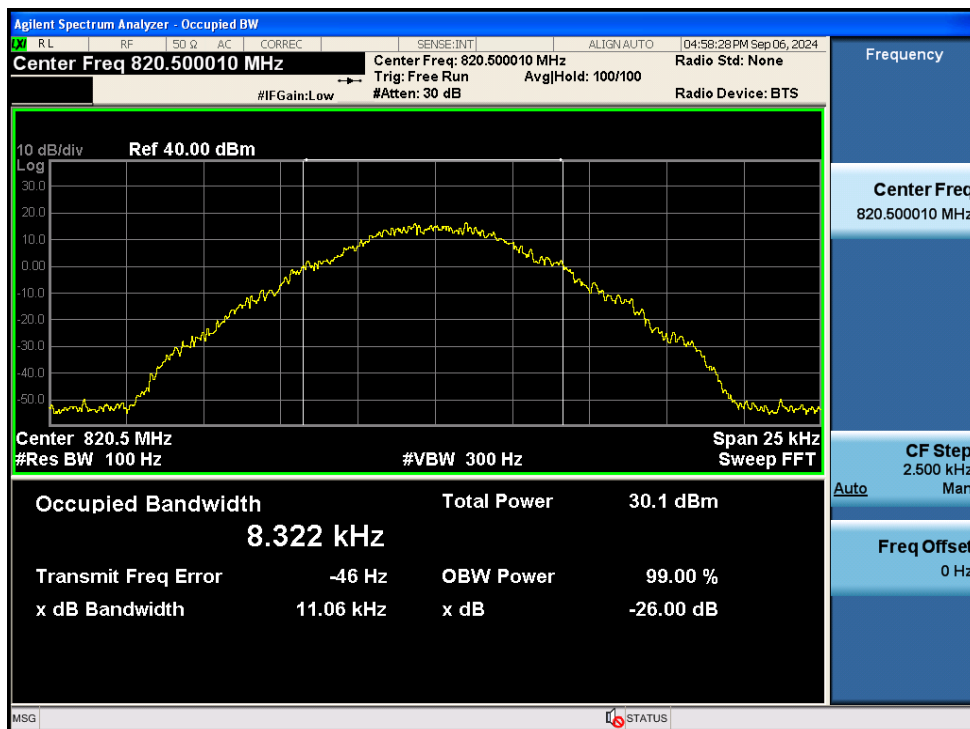

Input / Public Safety Narrowband / 1 Carrier / Downlink / P25 Phase 1

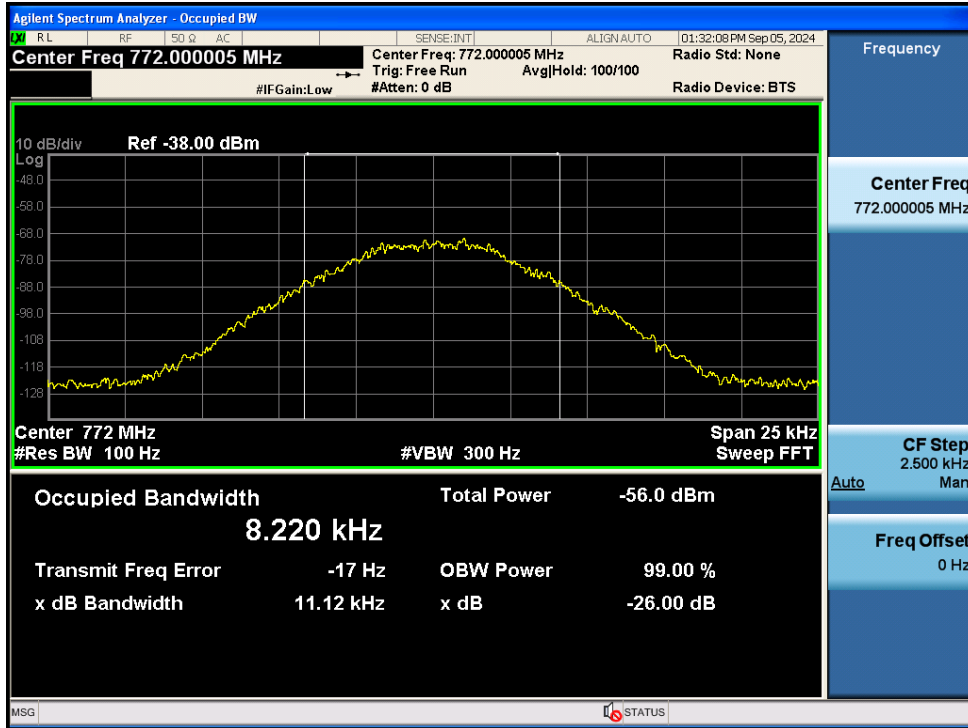

Output / Public Safety Narrowband / 1 Carrier / Downlink / P25 Phase 1

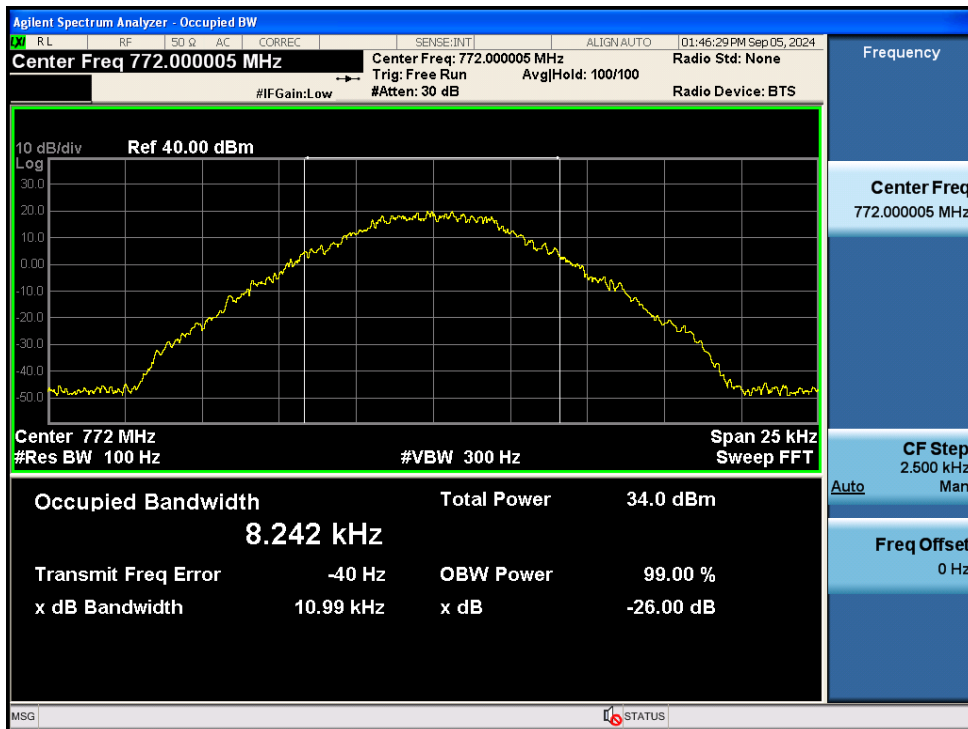

3 dB above the AGC threshold Input / Public Safety Narrowband / 1 Carrier / Downlink / P25 Phase 1

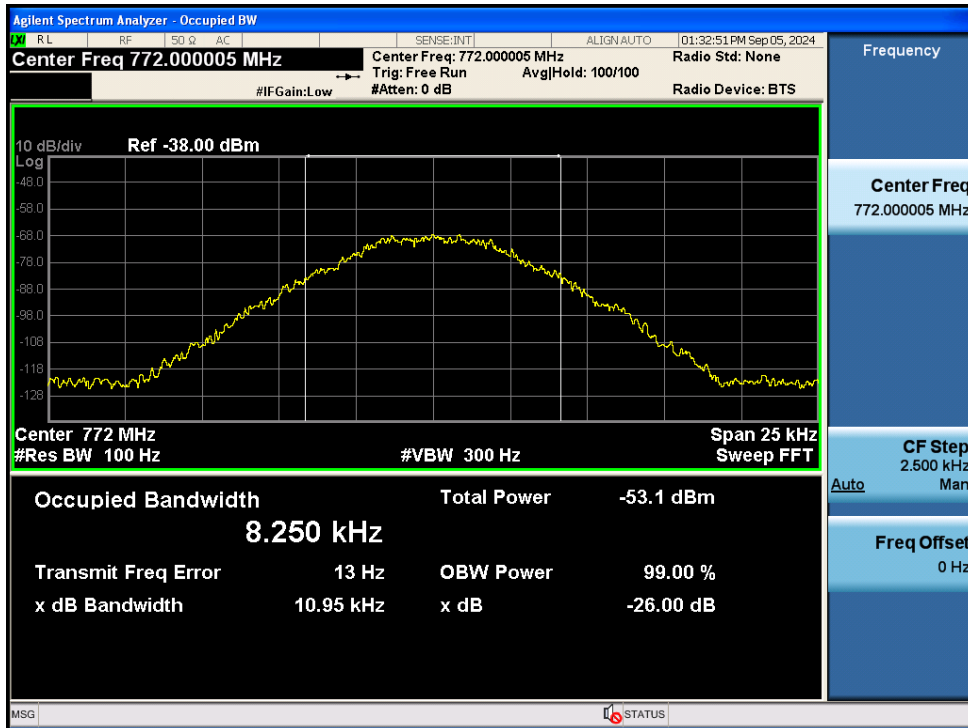

3 dB above the AGC threshold output / Public Safety Narrowband / 1 Carrier / Downlink / P25 Phase 1

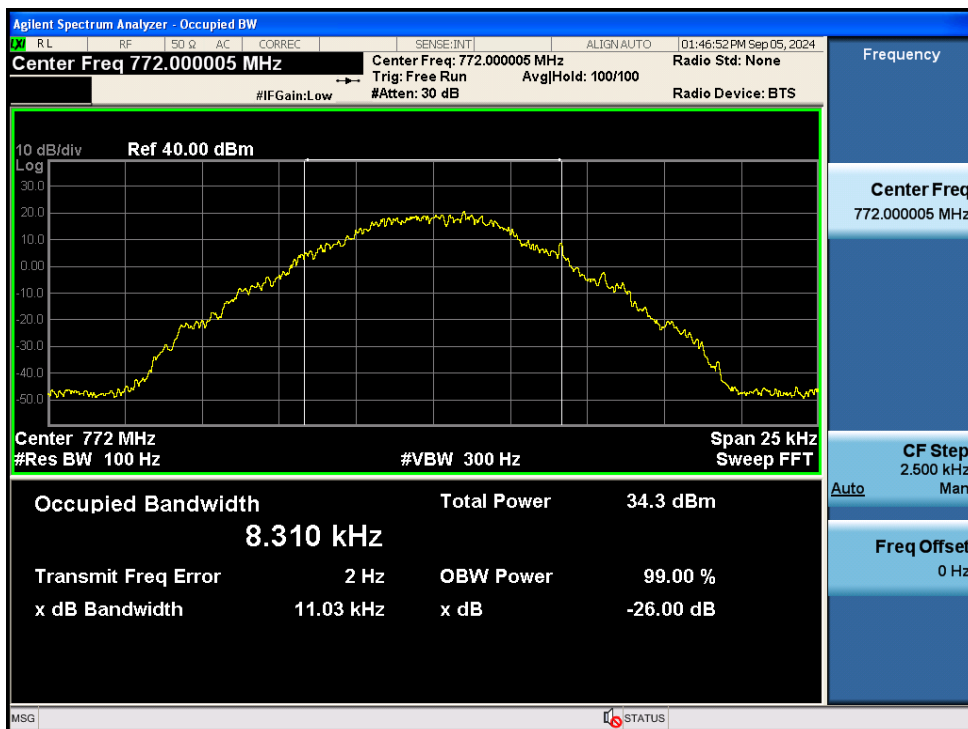

Input / NPSPAC / 1 Carrier / Downlink / P25 Phase 1

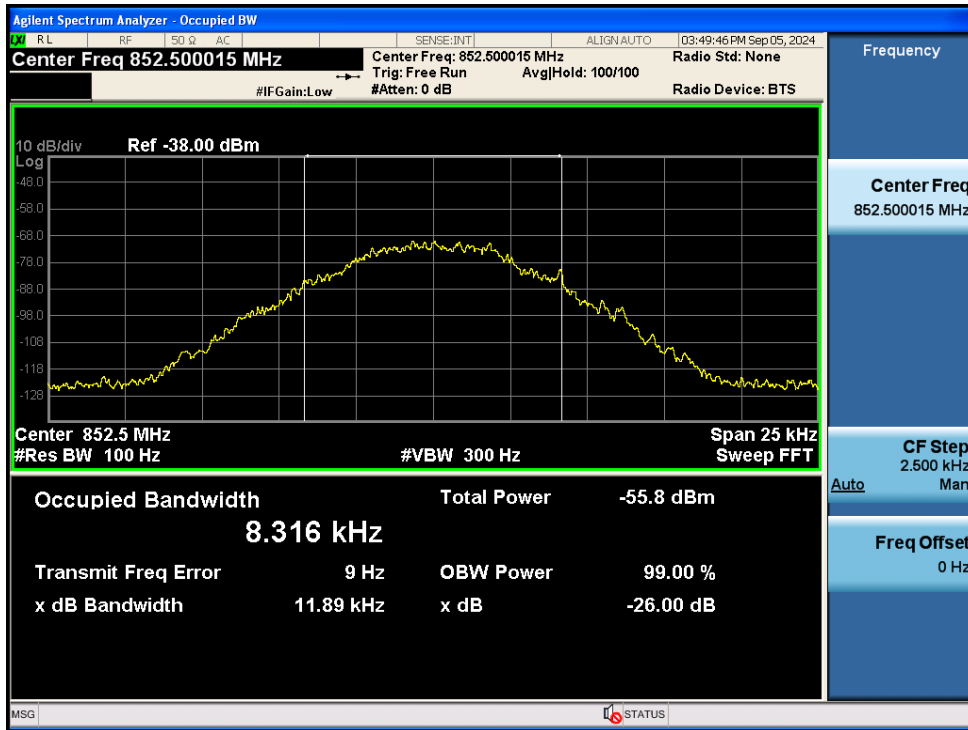

Output / NPSPAC / 1 Carrier / Downlink / P25 Phase 1

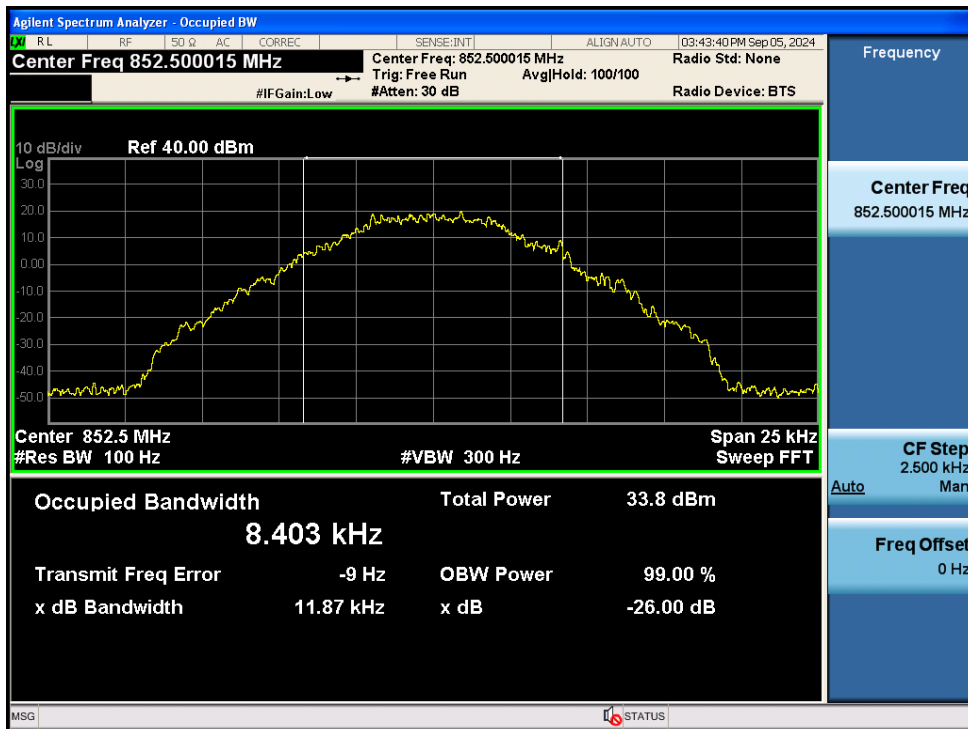

3 dB above the AGC threshold Input / NPSPAC / 1 Carrier / Downlink / P25 Phase 1

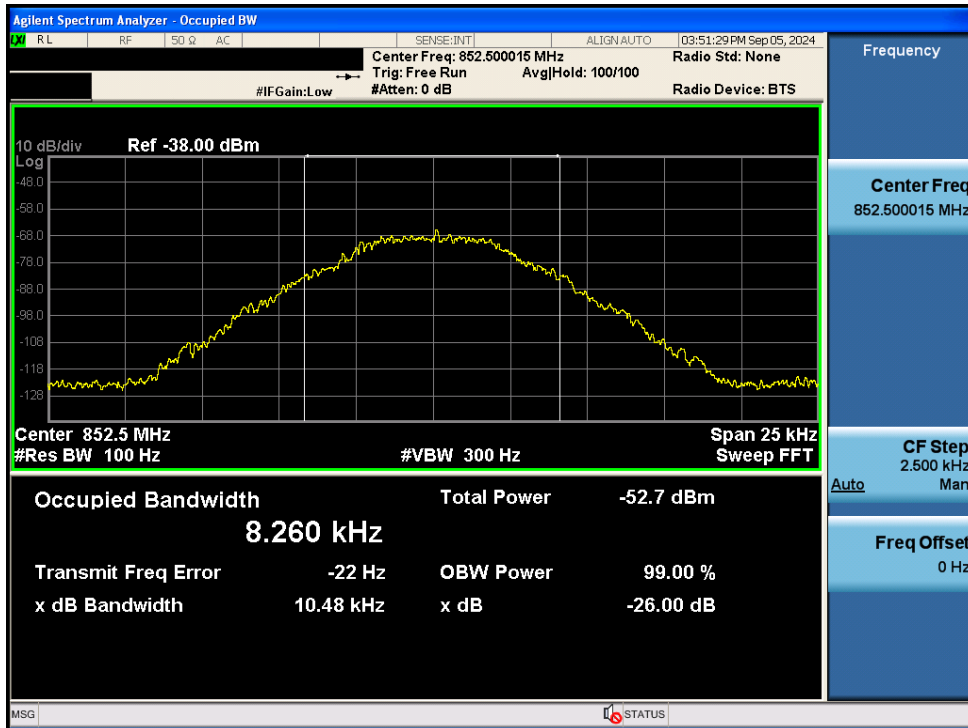

3 dB above the AGC threshold output / NPSPAC / 1 Carrier / Downlink / P25 Phase 1

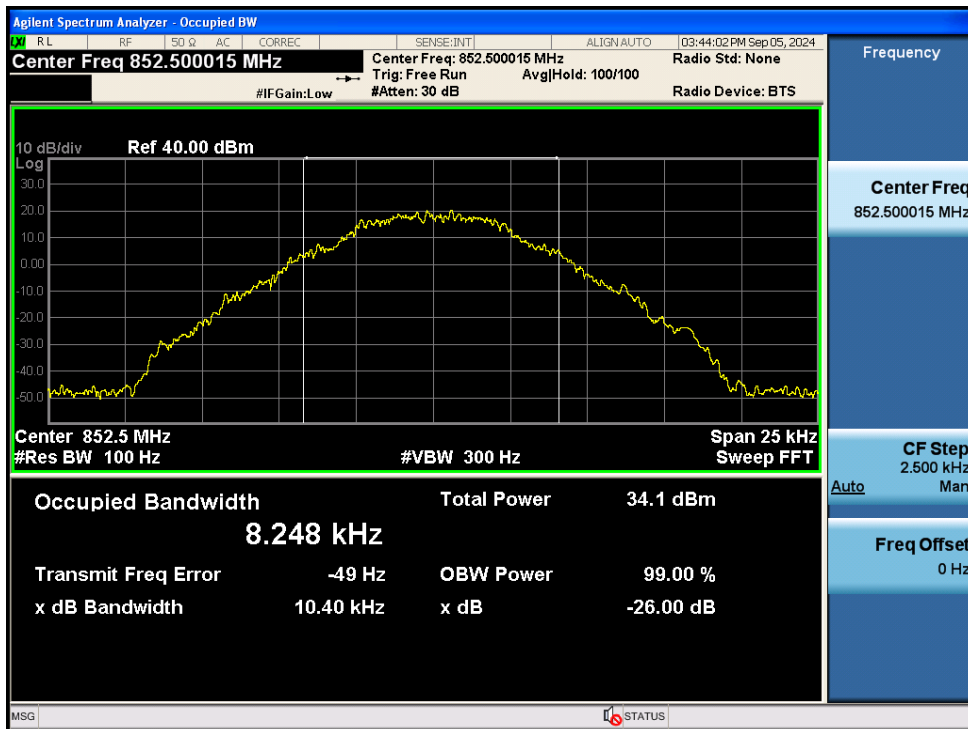

Input / B/ILT; SMR / 1 Carrier / Downlink / P25 Phase 1

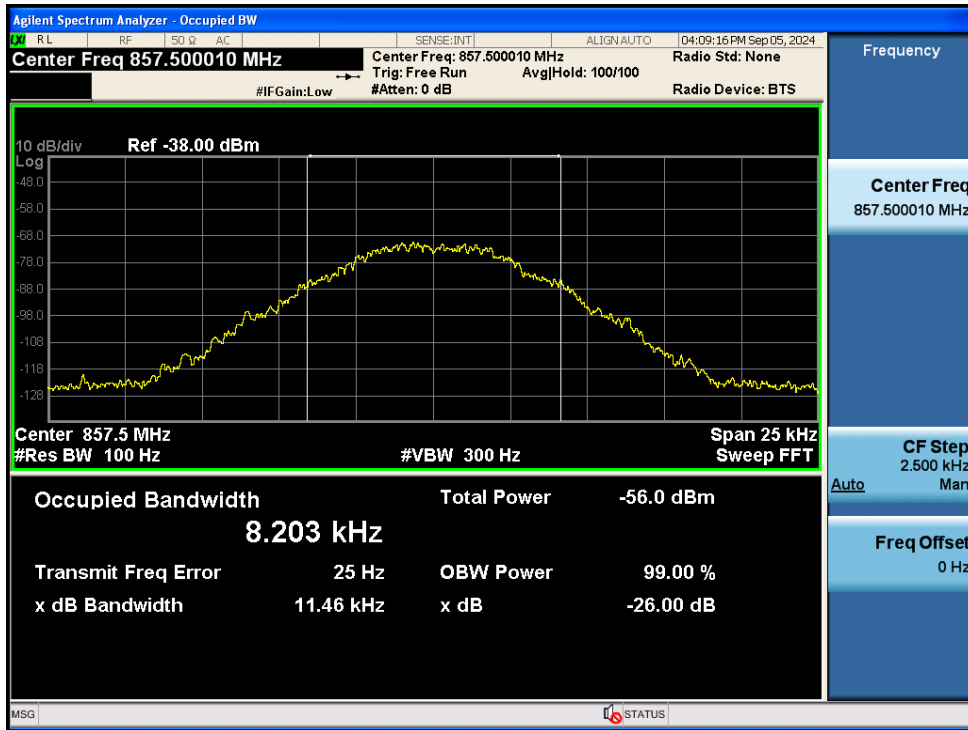

Output / B/ILT; SMR / 1 Carrier / Downlink / P25 Phase 1

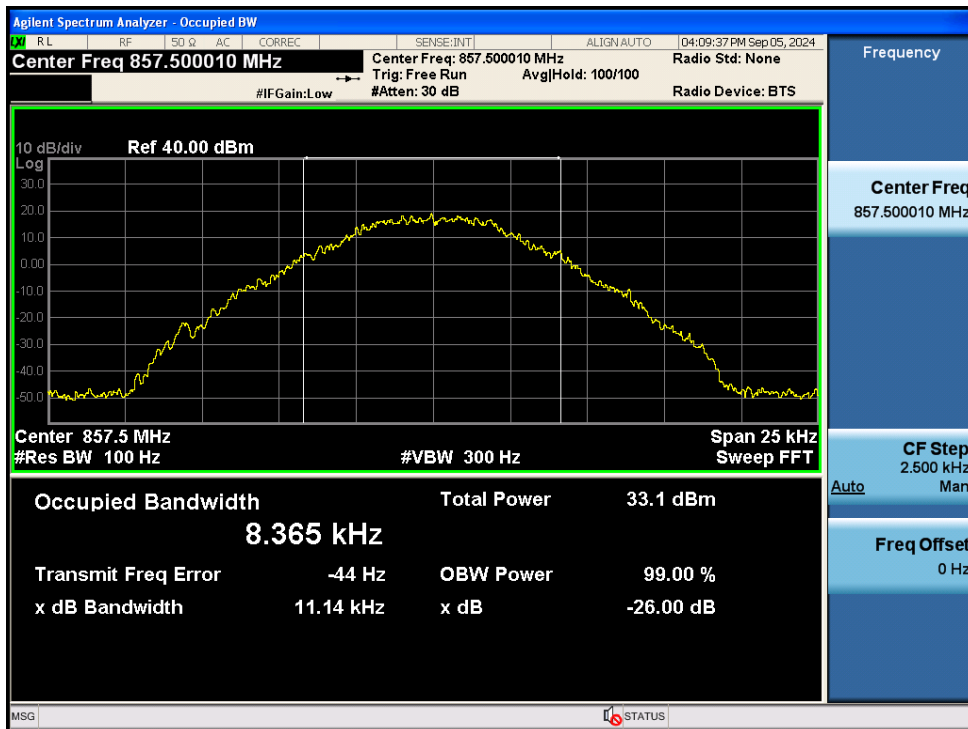

3 dB above the AGC threshold Input / B/ILT; SMR / 1 Carrier / Downlink / P25 Phase 1

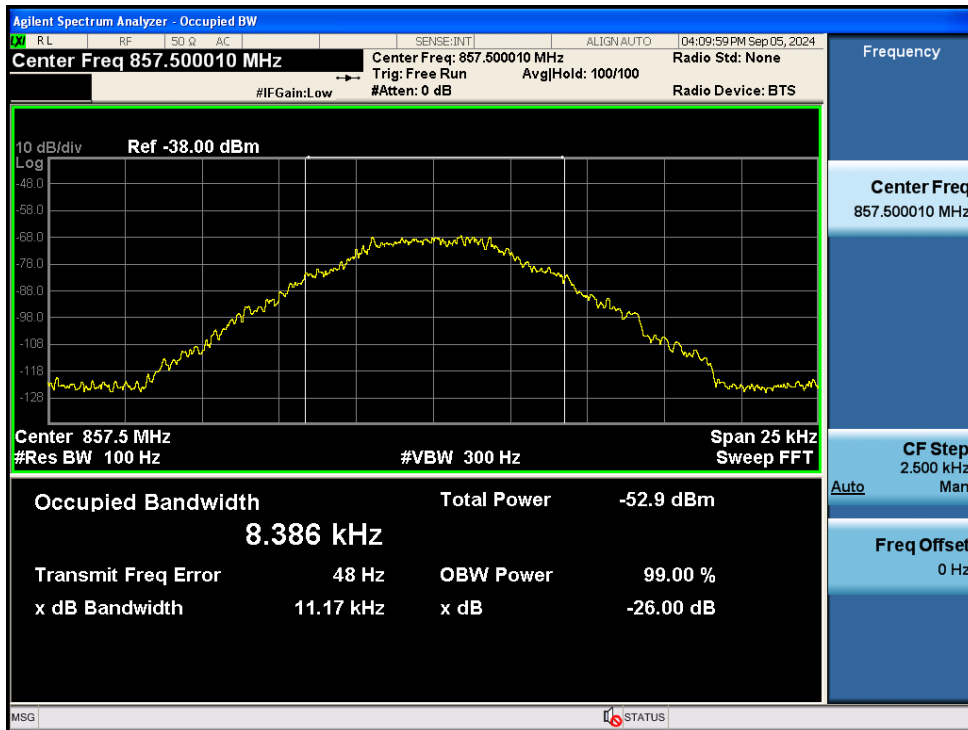

3 dB above the AGC threshold output / B/ILT; SMR / 1 Carrier / Downlink / P25 Phase 1

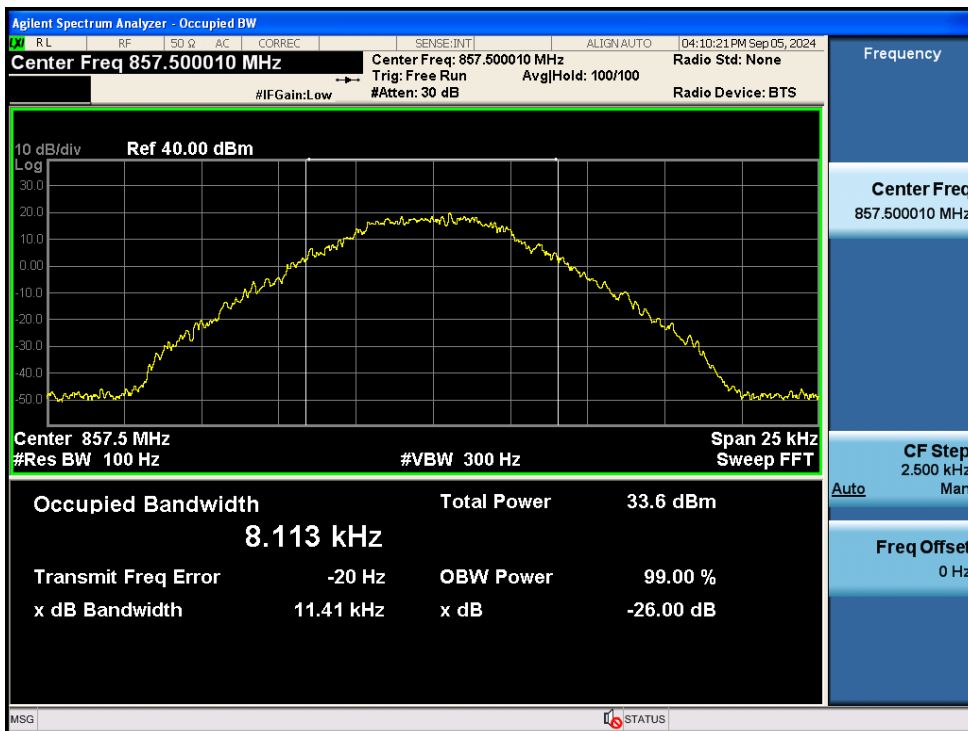

Input / ESMR / 1 Carrier / Downlink / P25 Phase 1

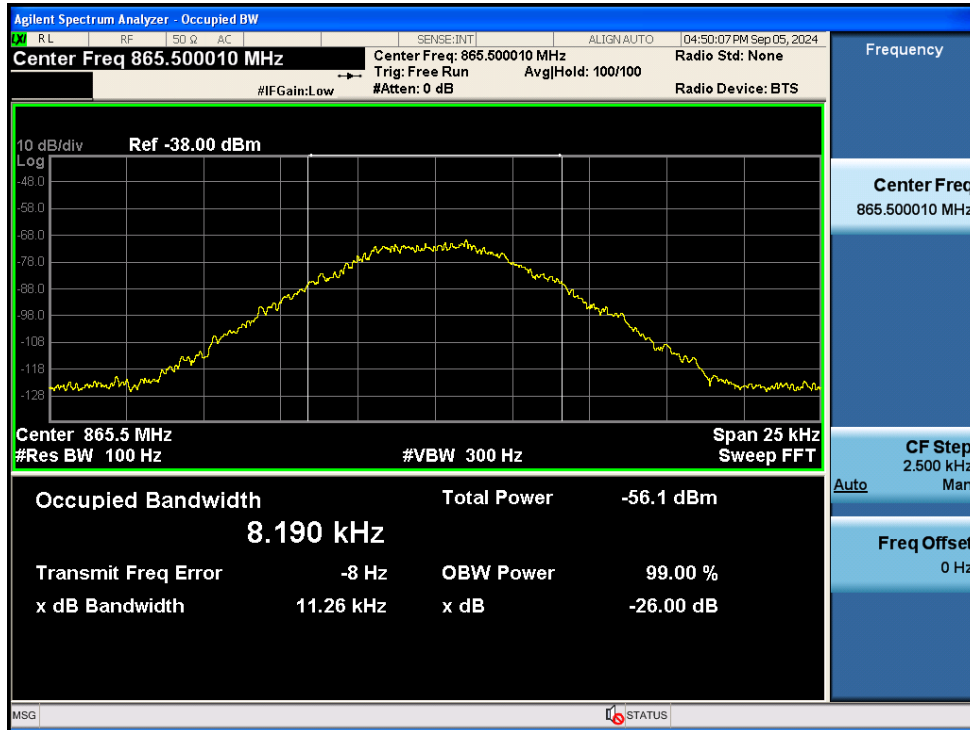

Output / ESMR / 1 Carrier / Downlink / P25 Phase 1



3 dB above the AGC threshold Input / ESMR / 1 Carrier / Downlink / P25 Phase 1

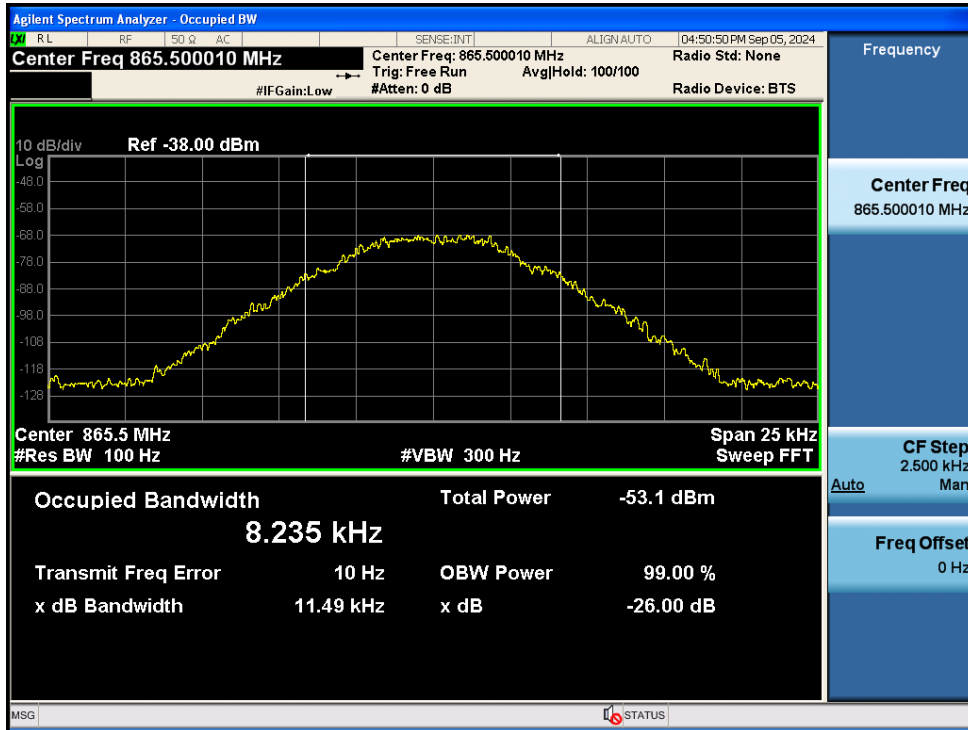

3 dB above the AGC threshold output / ESMR / 1 Carrier / Downlink / P25 Phase 1



5.4. INPUT-VERSUS-OUTPUT SIGNAL COMPARISON

Test Requirement:

§ 90.210 Emission masks.

Except as indicated elsewhere in this part, transmitters used in the radio services governed by this part must comply with the emission masks outlined in this section. Unless otherwise stated, per paragraphs (d)(4), (e)(4), and (o) of this section, measurements of emission power can be expressed in either peak or average values provided that emission powers are expressed with the same parameters used to specify the unmodulated transmitter carrier power. For transmitters that do not produce a full power unmodulated carrier, reference to the unmodulated transmitter carrier power refers to the total power contained in the channel bandwidth. Unless indicated elsewhere in this part, the table in this section specifies the emission masks for equipment operating under this part.

Applicable Emission Masks

Frequency band (MHz)	Mask for equipment with audio low pass filter	Mask for equipment without audio low pass filter
Below 25	A or B	A or C
25-50	B	C
72-76	B	C
150-174	B, D, or E	C, D or E
150 paging only	B	C
220-222	F	F
421-512	B, D, or E	C, D, or E
450 paging only	B	G
806-809/851-854	B	H
809-824/854-869 [#]	B, D	D, G.
896-901/935-940	I	J
902-928	K	K
929 ~ 930	B	G
4940-4990 MHz	L or M	L or M
5850-5925		
All other bands	B	C

[#] Equipment designed to operate with a 25 kHz channel bandwidth must meet the requirements of Emission Mask B or C, as applicable. Equipment designed to operate with a 12.5 kHz channel bandwidth must meet the requirements of Emission Mask D, and equipment designed to operate with a 6.25 kHz channel bandwidth must meet the requirements of Emission Mask E.

- (c) Emission Mask C. For transmitters that are not equipped with an audio low-pass filter, the power of any emission must be attenuated below the unmodulated carrier output power (P) as follows:
- (1) On any frequency removed from the center of the authorized bandwidth by a displacement frequency (f_d in kHz) of more than 5 kHz, but not more than 10 kHz: At least $83 \log (f_d/5)$ dB;
 - (2) On any frequency removed from the center of the authorized bandwidth by a displacement frequency (f_d in kHz) of more than 10 kHz, but not more than 250 percent of the authorized bandwidth: At least $29 \log (f_d/11)$ dB or 50 dB, whichever is the lesser attenuation;
 - (3) On any frequency removed from the center of the authorized bandwidth by more than 250 percent of the authorized bandwidth: At least $43 + 10 \log (P)$ dB.
 - (4) In the 1427-1432 MHz band, licensees are encouraged to take all reasonable steps to ensure that unwanted emissions power does not exceed the following levels in the 1400-1427 MHz band:
 - (i) For stations of point-to-point systems in the fixed service: -45 dBW/27 MHz.
 - (ii) For stations in the mobile service: -60 dBW/27 MHz.
- (d) Emission Mask D—12.5 kHz channel bandwidth equipment. For transmitters designed to operate with a 12.5 kHz channel bandwidth, any emission must be attenuated below the power (P) of the highest emission contained within the authorized bandwidth as follows:
- (1) On any frequency from the center of the authorized bandwidth f_0 to 5.625 kHz removed from f_0 : Zero dB.
 - (2) On any frequency removed from the center of the authorized bandwidth by a displacement frequency (f_d in kHz) of more than 5.625 kHz but no more than 12.5 kHz: At least $7.27(f_d - 2.88 \text{ kHz})$ dB.
 - (3) On any frequency removed from the center of the authorized bandwidth by a displacement frequency (f_d in kHz) of more than 12.5 kHz: At least $50 + 10 \log (P)$ dB or 70 dB, whichever is the lesser attenuation.
 - (4) The reference level for showing compliance with the emission mask shall be established using a resolution bandwidth sufficiently wide (usually two or three times the channel bandwidth) to capture the true peak emission of the equipment under test. In order to show compliance with the emission mask up to and including 50 kHz removed from the edge of the authorized bandwidth, adjust the resolution bandwidth to 100 Hz with the measuring instrument in a peak hold mode. A sufficient number of sweeps must be measured to insure that the emission profile is developed. If video filtering is used, its bandwidth must not be less than the instrument resolution bandwidth. For emissions beyond 50 kHz from the edge of the authorized bandwidth, see paragraph (o) of this section. If it can be shown that use of the above instrumentation settings do not accurately represent the true interference potential of the equipment under test, an alternate procedure may be used provided prior Commission approval is obtained.
- (h) Emission Mask H. For transmitters that are not equipped with an audio low-pass filter, the power of any emission must be attenuated below the unmodulated carrier power (P) as follows:
- (1) On any frequency removed from the center of the authorized bandwidth by a displacement frequency (f_d in kHz) of 4 kHz or less: Zero dB.
 - (2) On any frequency removed from the center of the authorized bandwidth by a displacement frequency (f_d in kHz) of more than 4 kHz, but no more than 8.5 kHz: At least $107 \log (f_d/4)$ dB;
 - (3) On any frequency removed from the center of the authorized bandwidth by a displacement frequency (f_d in kHz) of more than 8.5 kHz, but no more than 15 kHz: At least $40.5 \log (f_d/1.16)$ dB;
 - (4) On any frequency removed from the center of the authorized bandwidth by a displacement frequency (f_d in kHz) of more than 15 kHz, but no more than 25 kHz: At least $116 \log (f_d/6.1)$ dB;
 - (5) On any frequency removed from the center of the authorized bandwidth by more than 25 kHz: At least $43 + 10 \log (P)$ dB.

§ 90.219 Use of signal boosters.

- (e) Device Specifications. In addition to the general rules for equipment certification in § 90.203(a)(2) and part 2, subpart J of this chapter, a signal booster must also meet the rules in this paragraph.
 - (4) A signal booster must be designed such that all signals that it retransmits meet the following requirements:
 - (iii) The retransmitted signals continue to meet the unwanted emissions limits of § 90.210 applicable to the corresponding received signals (assuming that these received signals meet the applicable unwanted emissions limits by a reasonable margin).

Test Procedures:

Measurements were in accordance with the test methods section 4.4 of KDB 935210 D05 v01r03.

- a) Connect a signal generator to the input of the EUT.
- b) Configure the signal generator to transmit the appropriate test signal associated with the public safety emission designation.
- c) Configure the signal level to be just below the AGC threshold.
- d) Connect a spectrum analyzer to the output of the EUT using appropriate attenuation as necessary.
- e) Set the spectrum analyzer center frequency to the nominal EUT channel center frequency. The span range for the spectrum analyzer shall be between 2 times to 5 times the EBW (or OBW).
- f) The nominal RBW shall be 300 Hz for 16K0F3E, and 100 Hz for all other emissions types.
- g) Set the reference level of the spectrum analyzer to accommodate the maximum input amplitude level, i.e., the level at f_0 per Out-of-band rejection test.
- h) Set spectrum analyzer detection mode to peak, and trace mode to max hold.
- i) Allow the trace to fully stabilize.
- j) Confirm that the signal is contained within the appropriate emissions mask.
- k) Use the marker function to determine the maximum emission level and record the associated frequency.
- l) Capture the emissions mask plot for inclusion in the test report (output signal spectra).
- m) Measure the EUT input signal power (signal generator output signal) directly from the signal generator using power measurement guidance provided in KDB Publication 971168 [R8] (input signal spectra).
- n) Compare the spectral plot of the output signal (determined in step k), to the input signal (determined in step l) to affirm they are similar (in passband and rolloff characteristic features and relative spectral locations).
- o) Repeat steps d) to n) with the input signal amplitude set 3 dB above the AGC threshold.
- p) Repeat steps b) to o) for all authorized operational bands and emissions types (see applicable regulatory specifications, e.g., Section 90.210).
- q) Include all accumulated spectral plots depicting EUT input signal and EUT output signal in the test report, and note any observed dissimilarities.

Plot data of Emission mask

Input / Public Safety Narrowband / 1 Carrier / Uplink / Mask C

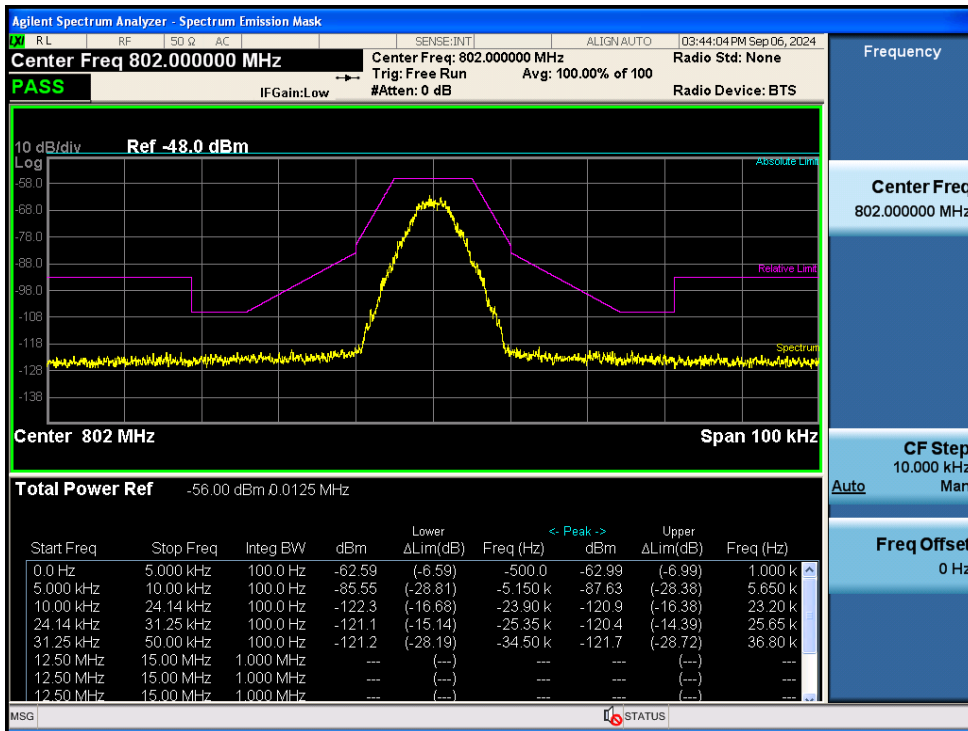

Output / Public Safety Narrowband / 1 Carrier / Uplink / Mask C

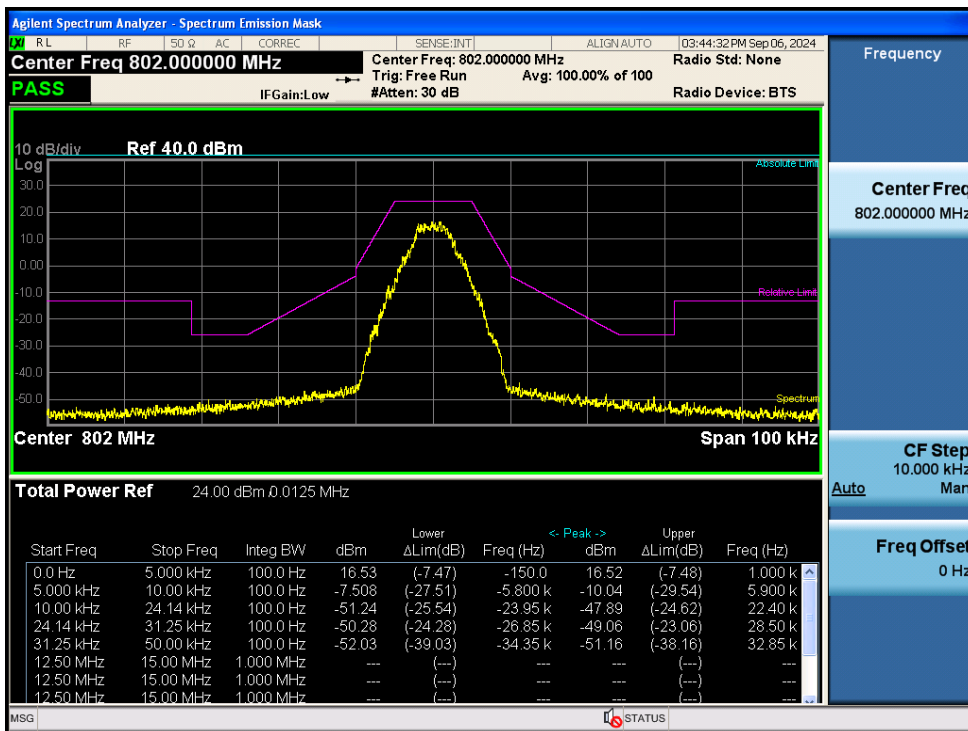

3 dB above the AGC threshold Input / Public Safety Narrowband / 1 Carrier / Uplink / Mask C

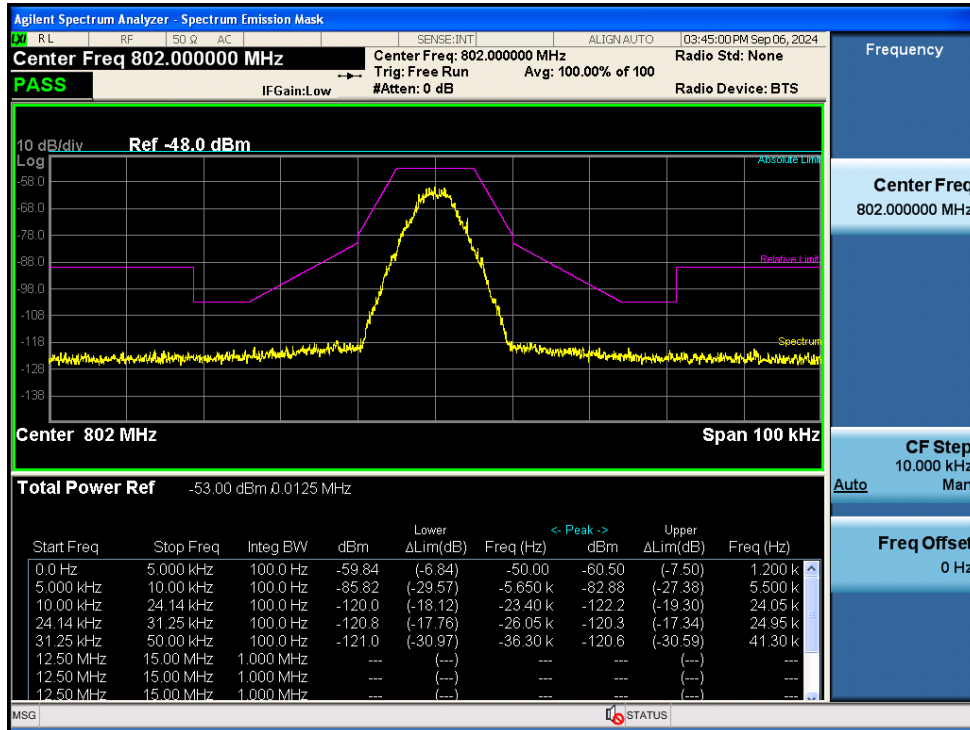

3 dB above the AGC threshold output / Public Safety Narrowband / 1 Carrier / Uplink / Mask C

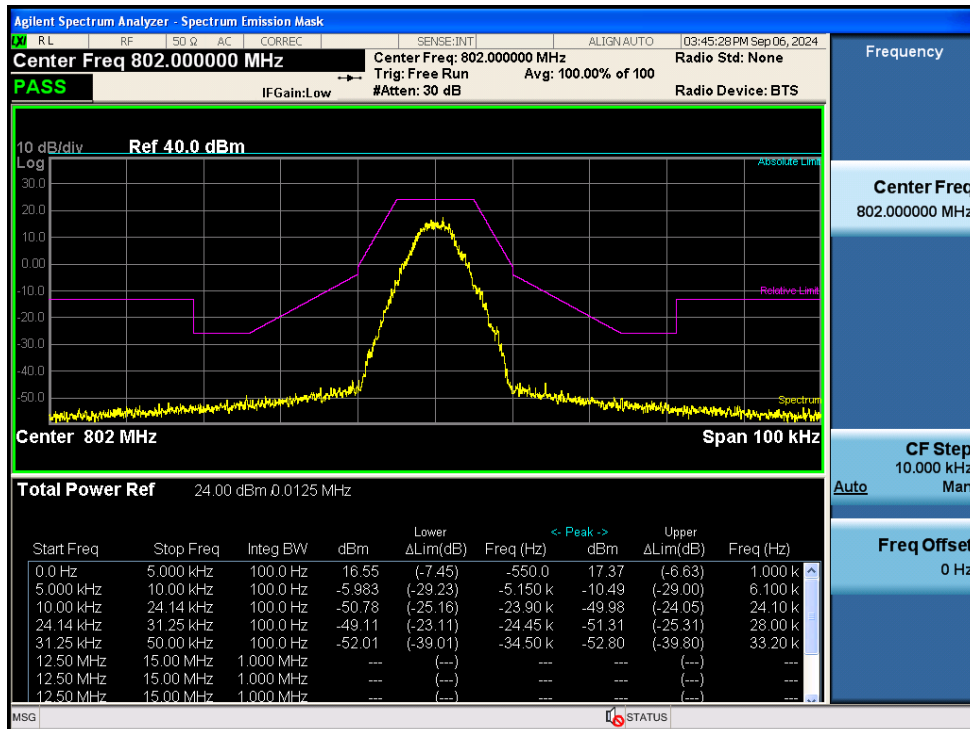

Input / NPSPAC / 1 Carrier / Uplink / Mask H

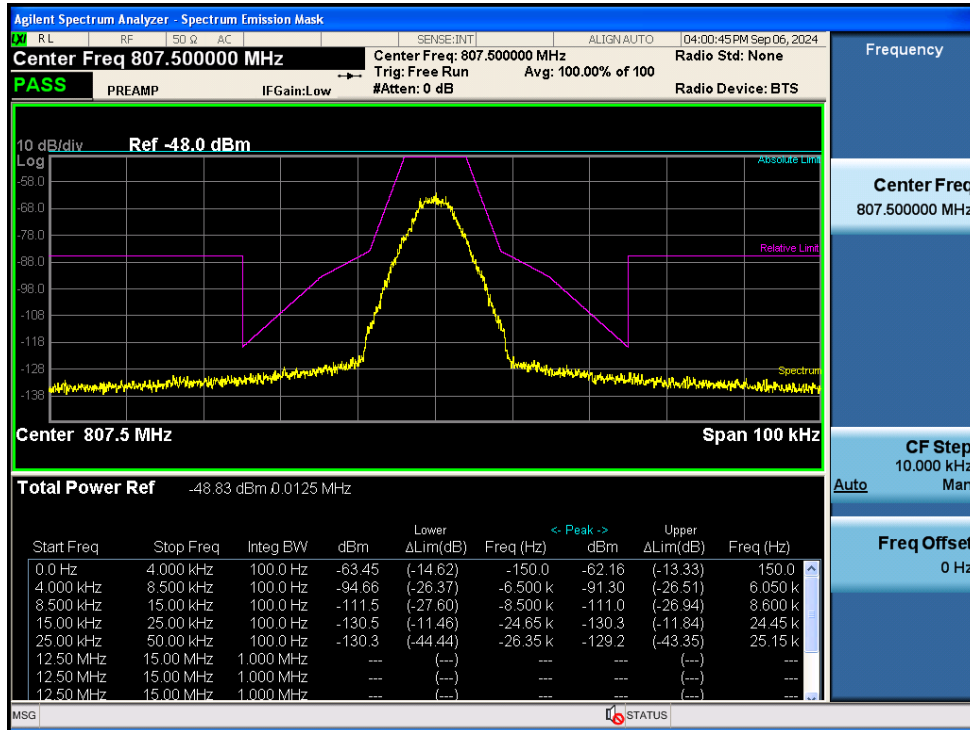

Output / NPSPAC / 1 Carrier / Uplink / Mask H

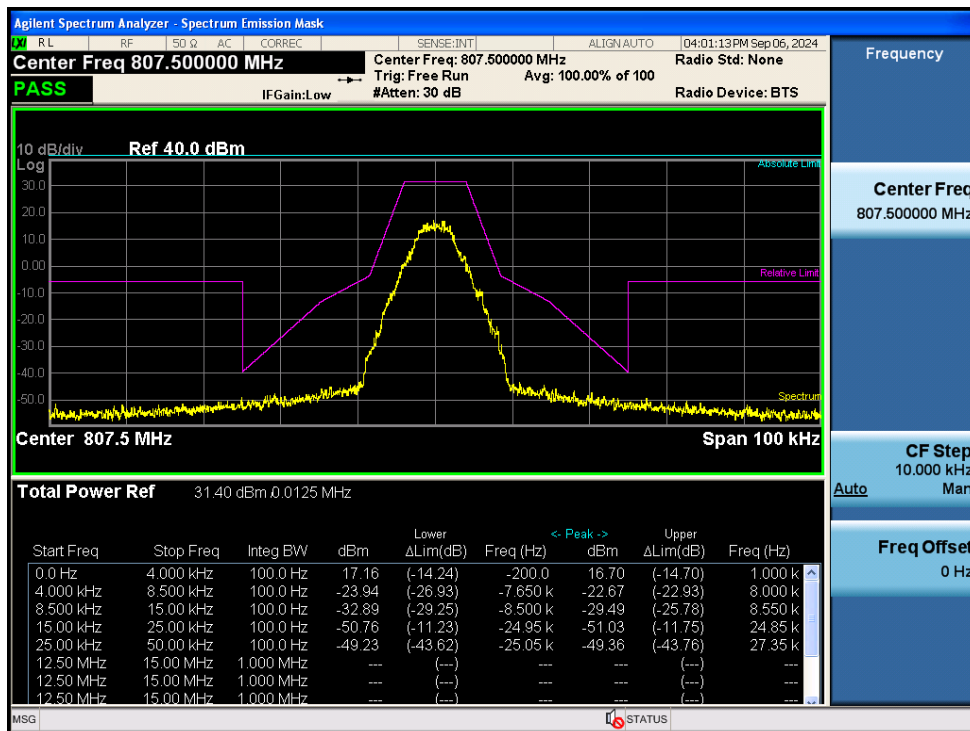

3 dB above the AGC threshold Input / NPSPAC / 1 Carrier / Uplink / Mask H

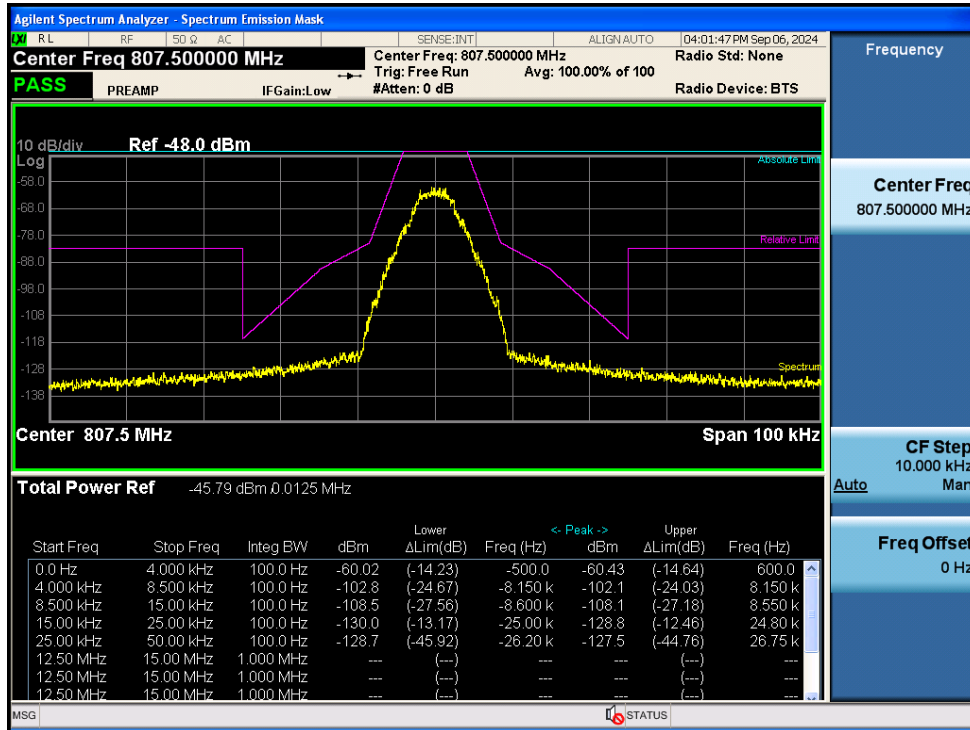

3 dB above the AGC threshold output / NPSPAC / 1 Carrier / Uplink / Mask H

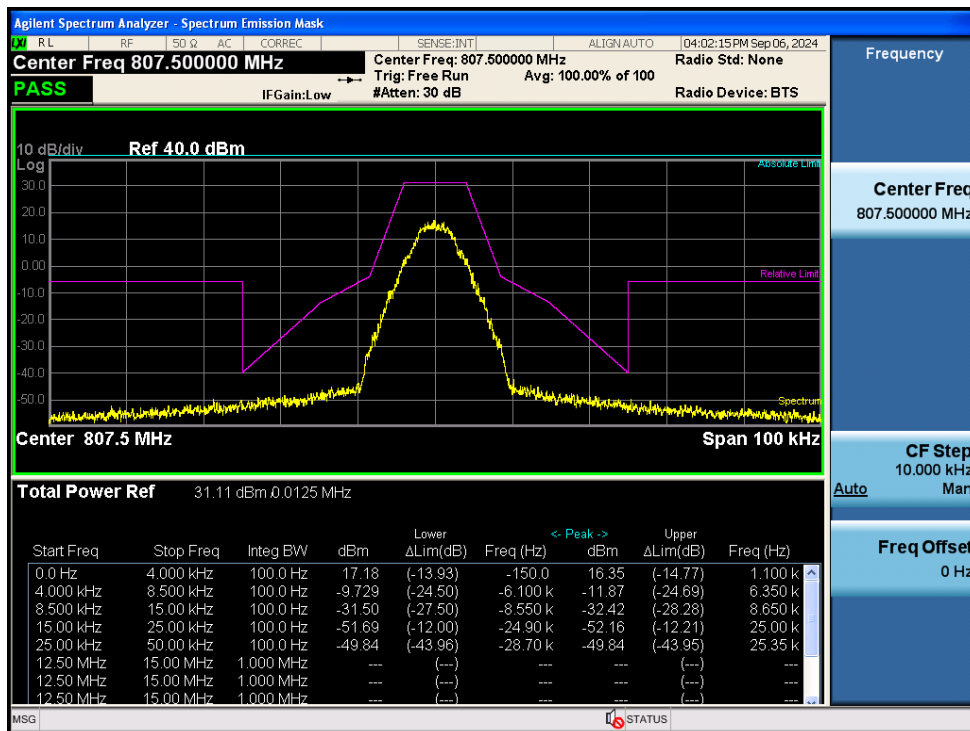

Input / B/ILT; SMR / 1 Carrier / Uplink / Mask D

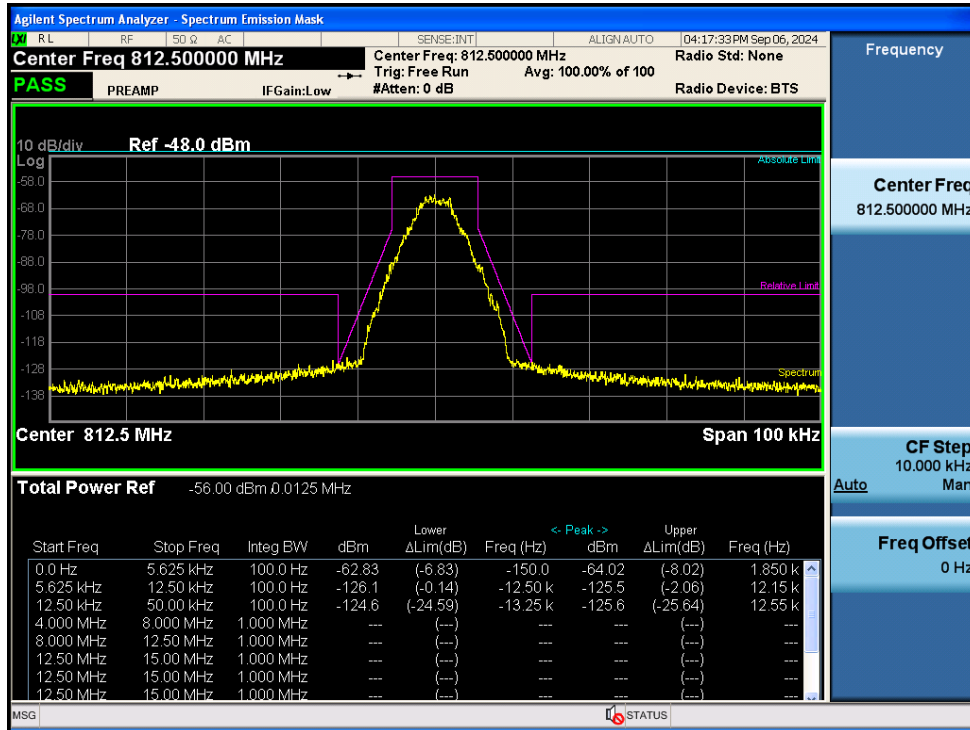

Output / B/ILT; SMR / 1 Carrier / Uplink / Mask D

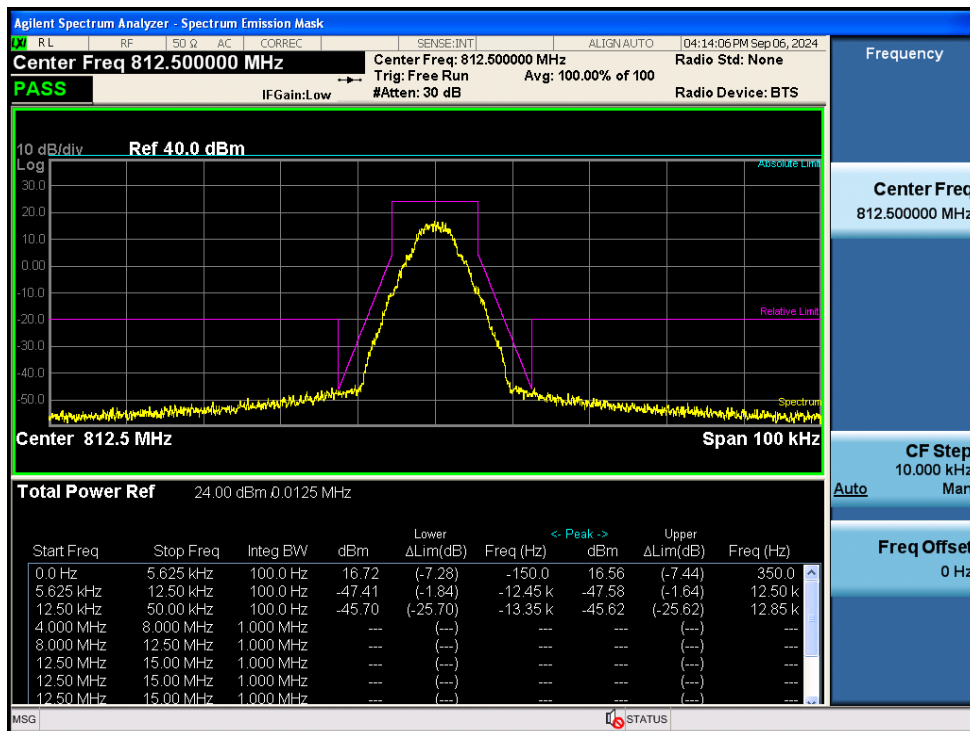

3 dB above the AGC threshold Input / B/ILT; SMR / 1 Carrier / Uplink / Mask D

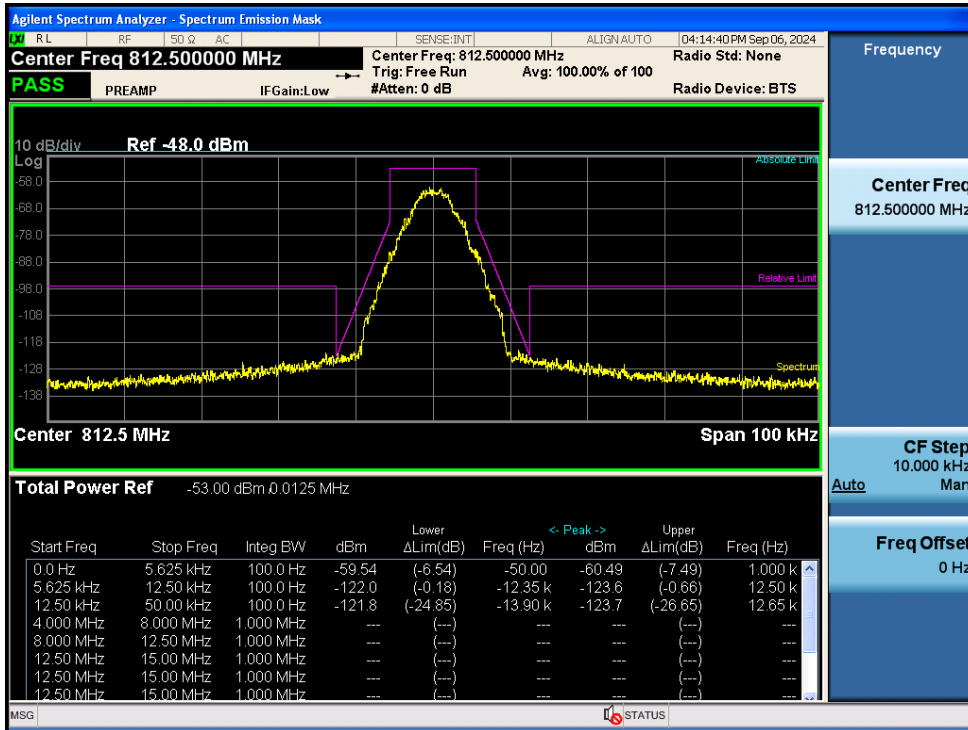

3 dB above the AGC threshold output / B/ILT; SMR / 1 Carrier / Uplink / Mask D

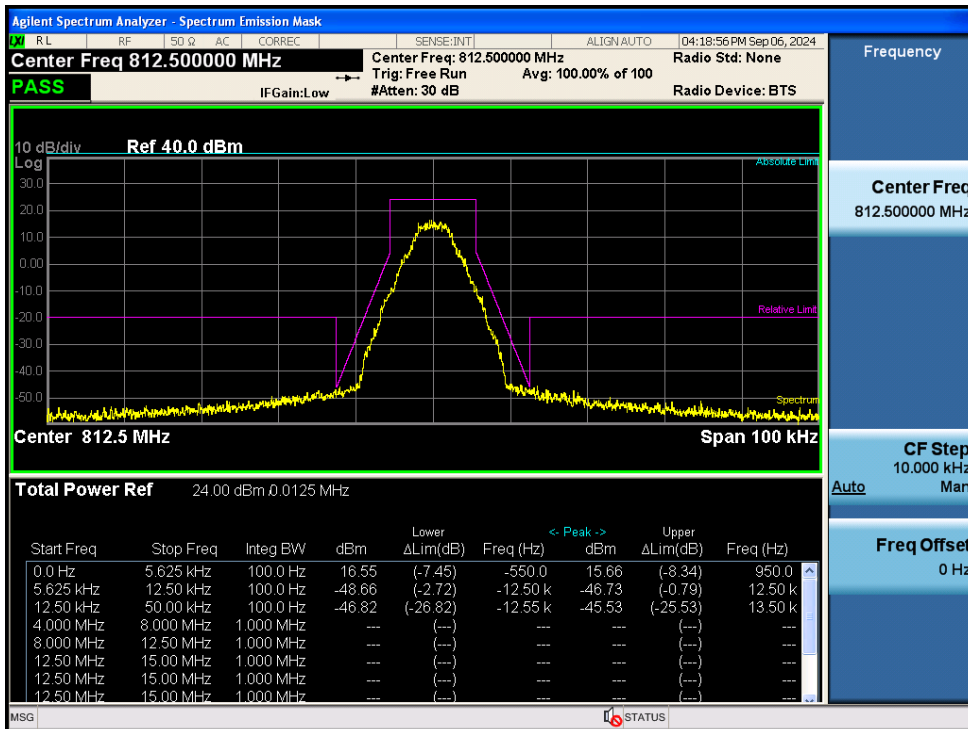

Input / ESMR / 1 Carrier / Uplink / Mask D

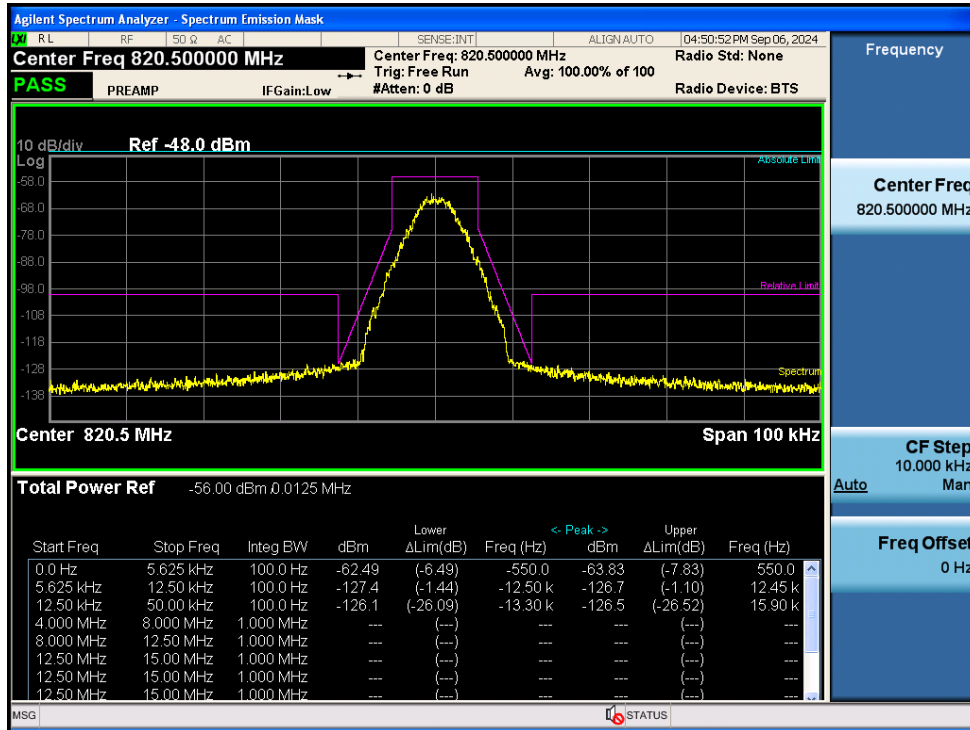

Output / ESMR / 1 Carrier / Uplink / Mask D

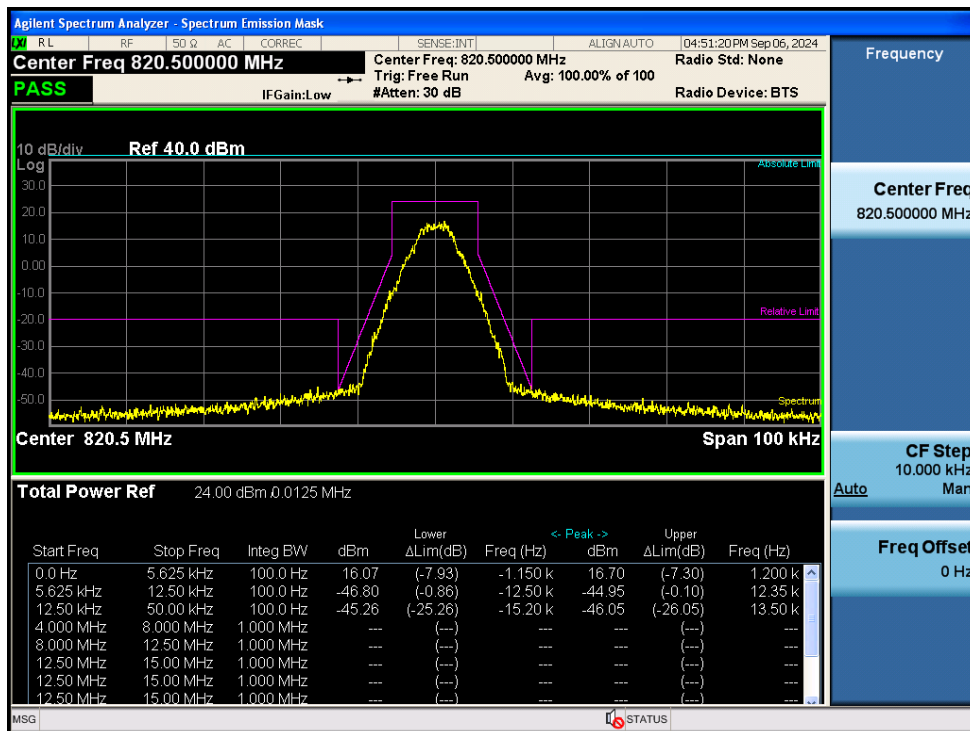

3 dB above the AGC threshold Input / ESMR / 1 Carrier / Uplink / Mask D

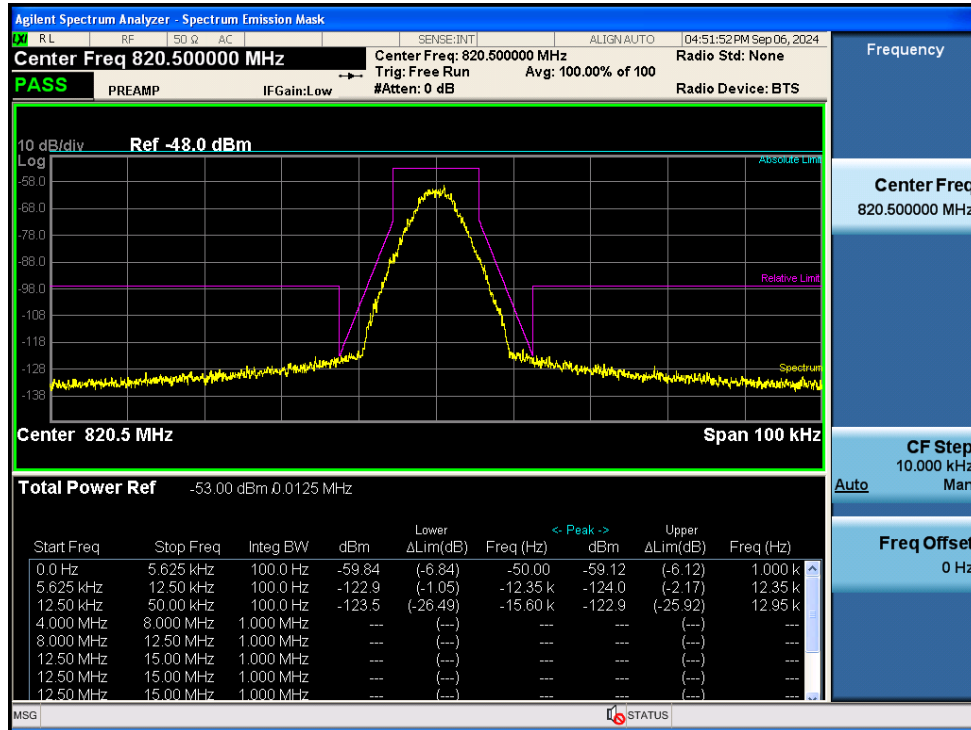

3 dB above the AGC threshold output / ESMR / 1 Carrier / Uplink / Mask D

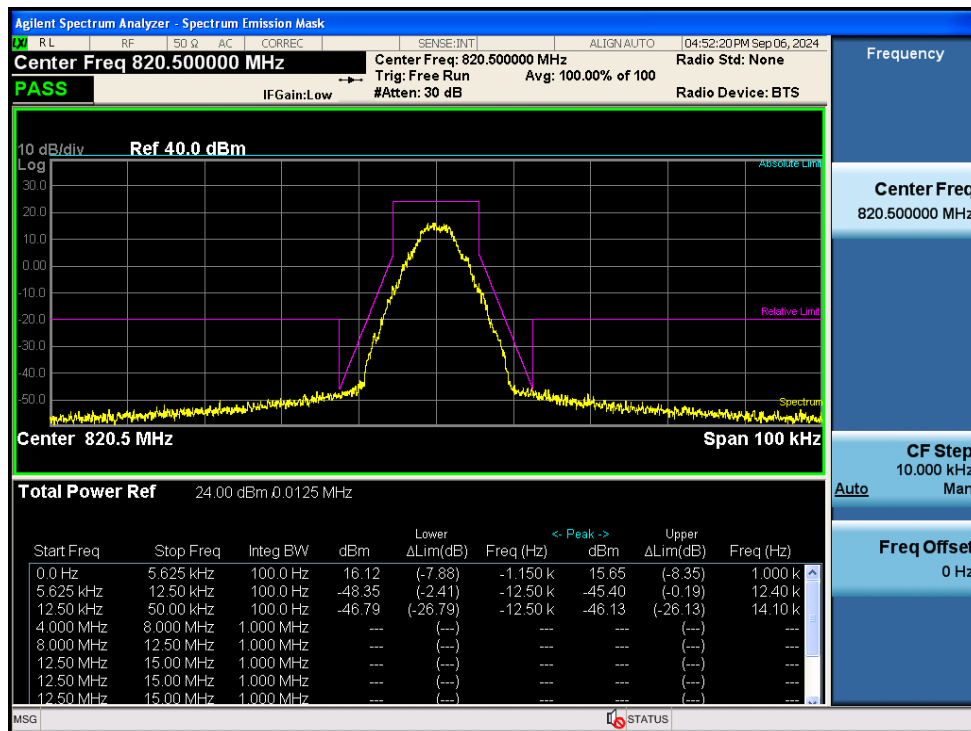

Input / Public Safety Narrowband / 1 Carrier / Downlink / Mask C

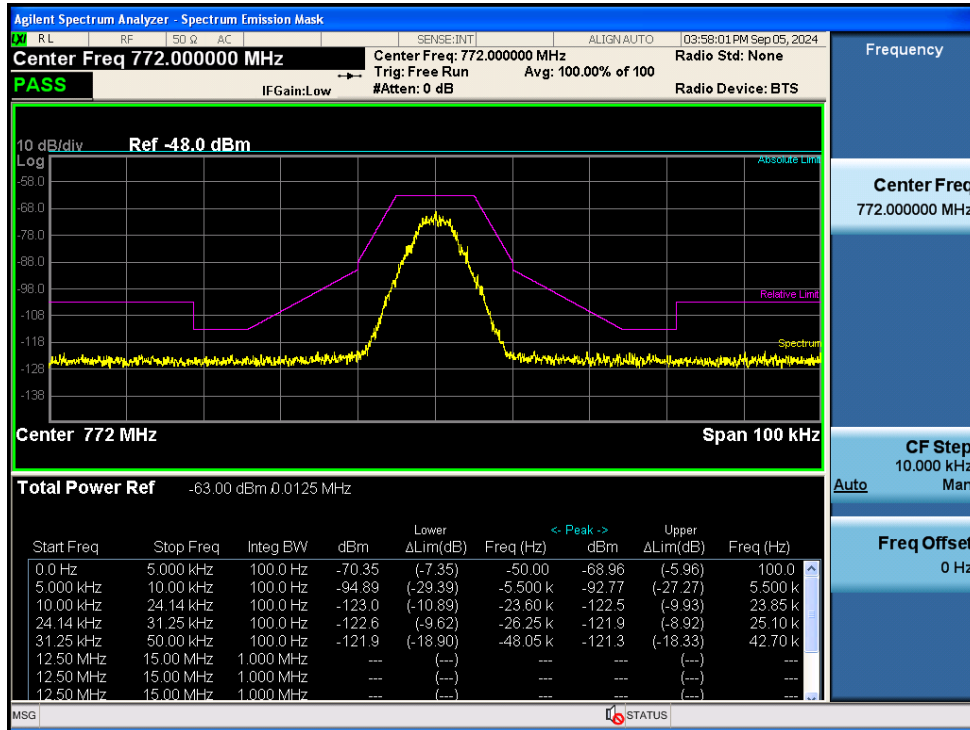

Output / Public Safety Narrowband / 1 Carrier / Downlink / Mask C

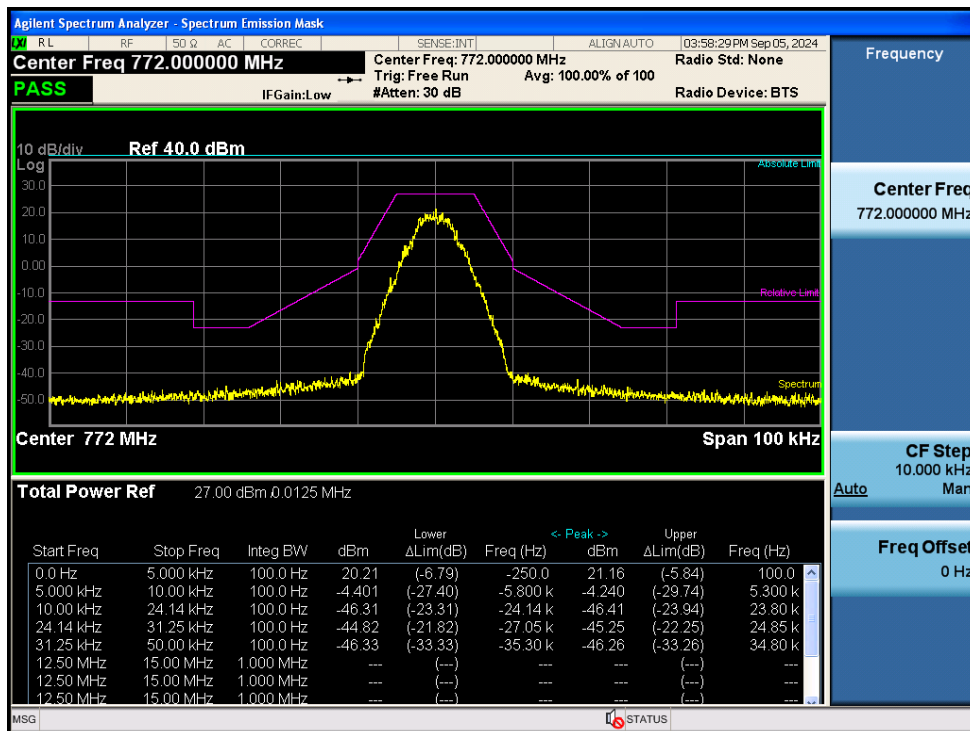

3 dB above the AGC threshold Input / Public Safety Narrowband / 1 Carrier / Downlink / Mask C

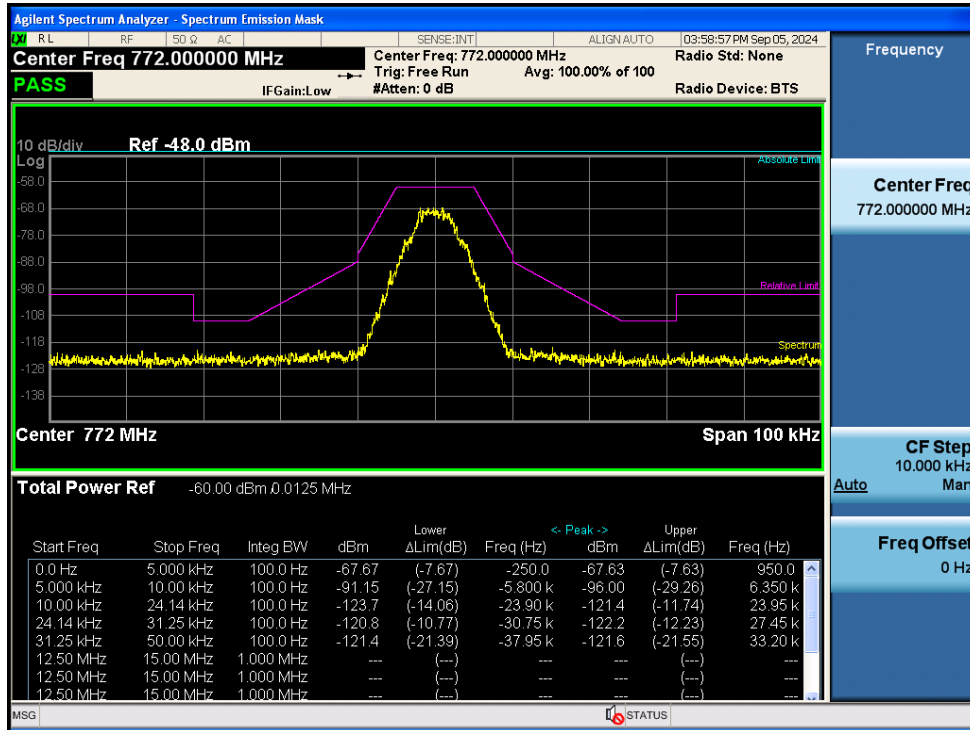

3 dB above the AGC threshold output / Public Safety Narrowband / 1 Carrier / Downlink / Mask C

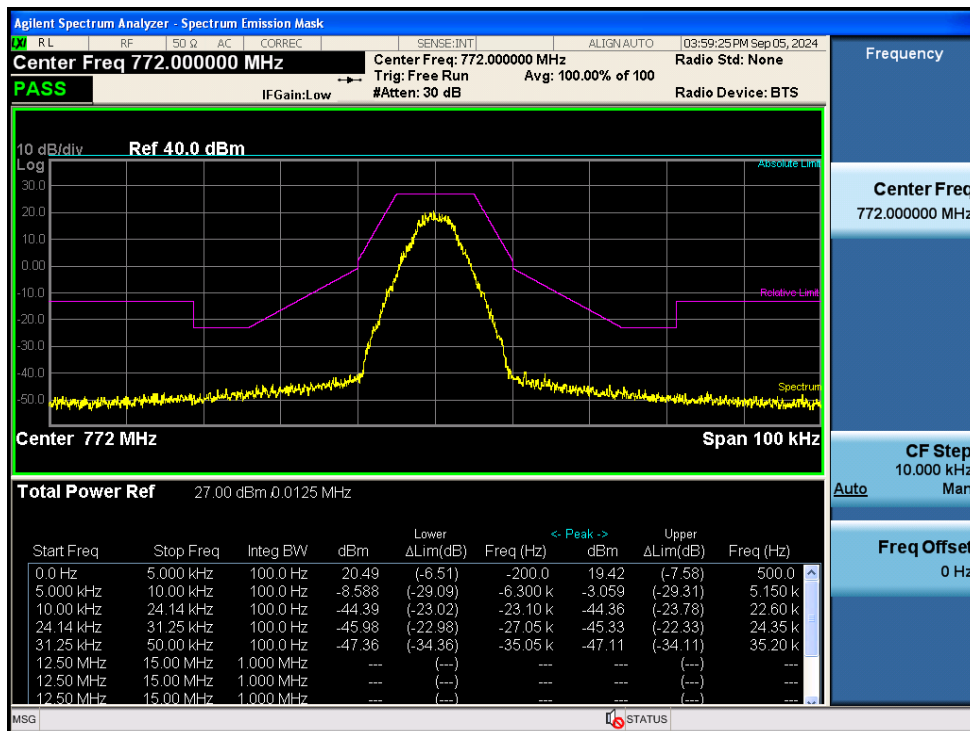

Input / NPSPAC / 1 Carrier / Downlink / Mask H

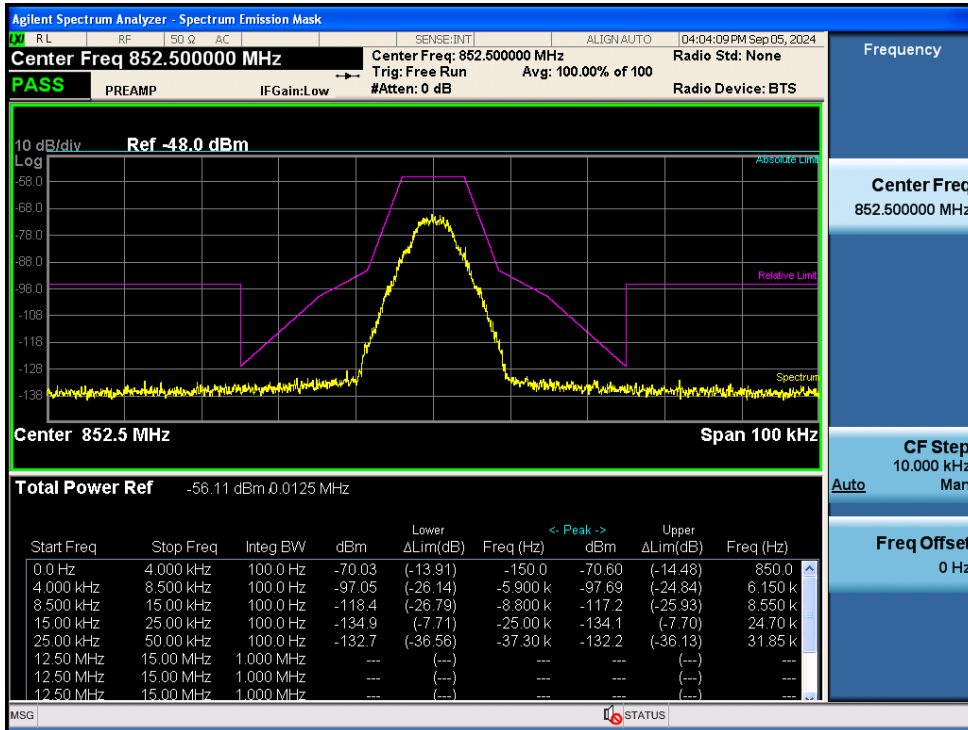

Output / NPSPAC / 1 Carrier / Downlink / Mask H

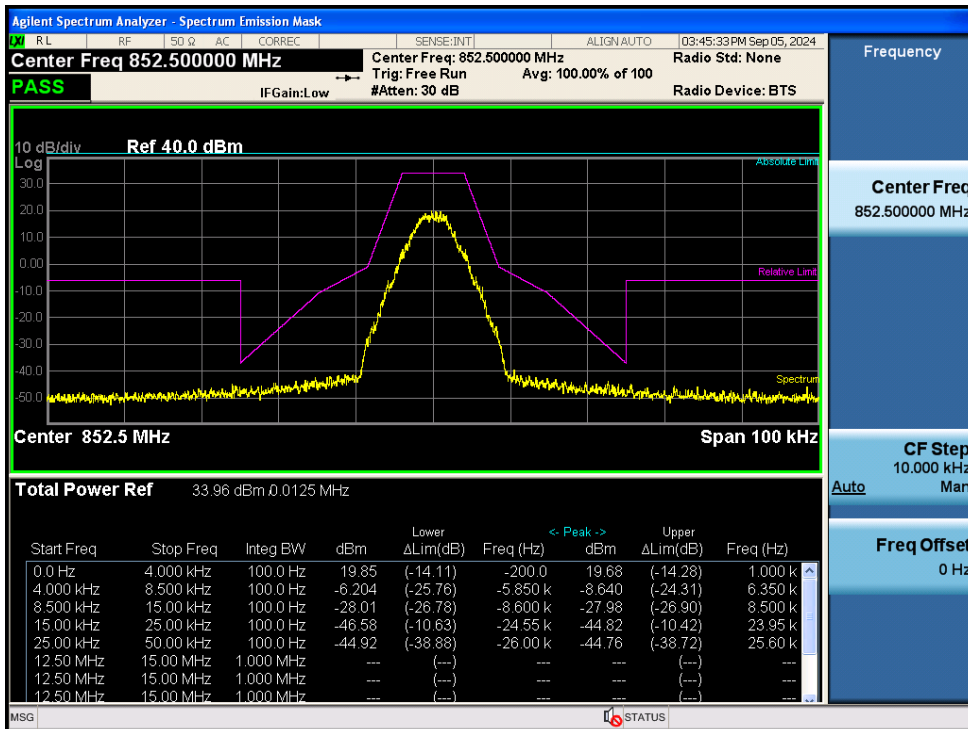

3 dB above the AGC threshold Input / NPSPAC / 1 Carrier / Downlink / Mask H

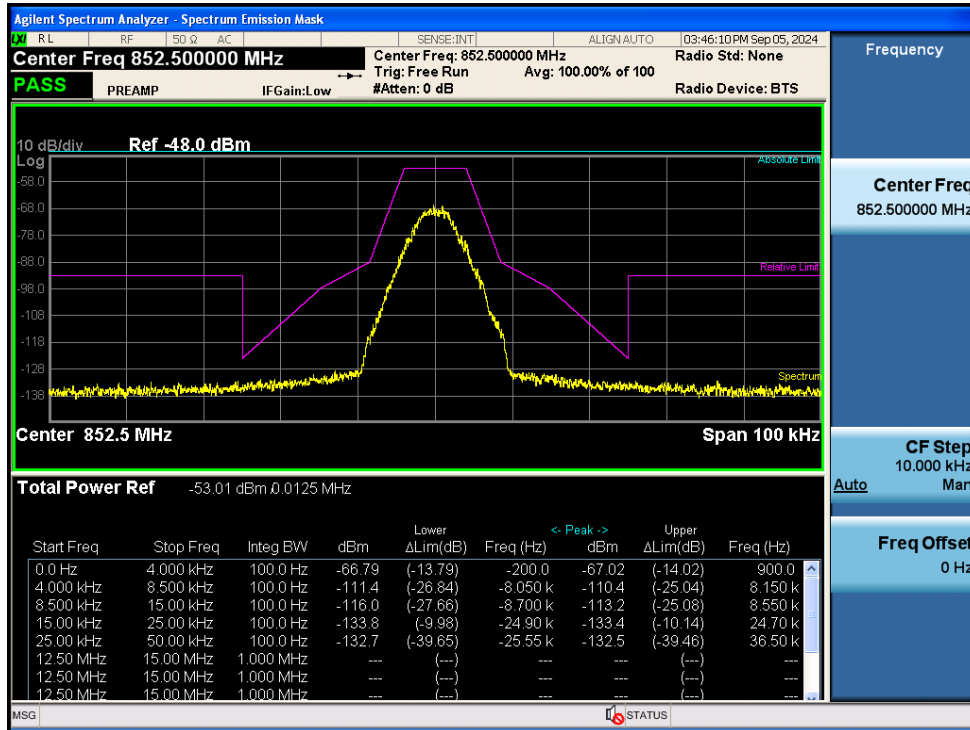

3 dB above the AGC threshold output / NPSPAC / 1 Carrier / Downlink / Mask H

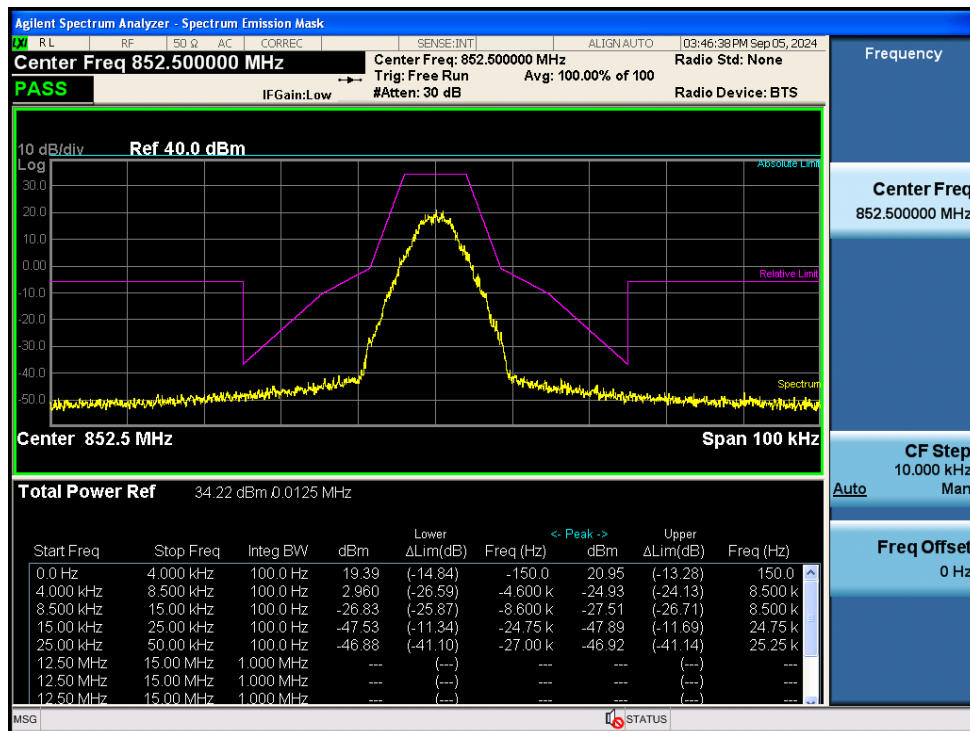

Input / B/ILT; SMR / 1 Carrier / Downlink / Mask D

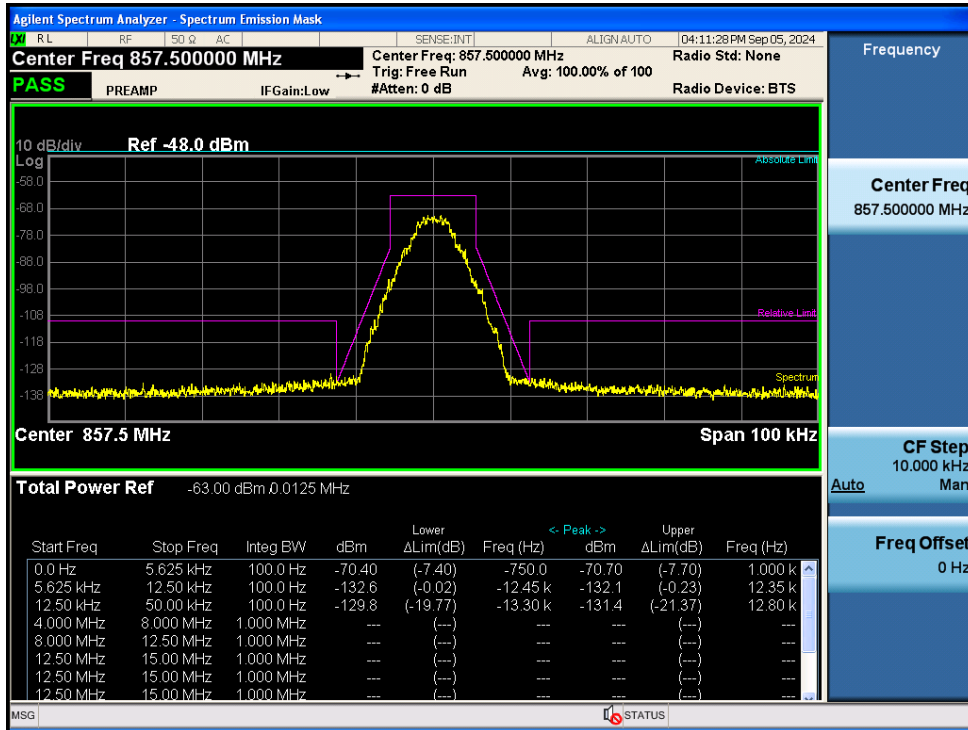

Output / B/ILT; SMR / 1 Carrier / Downlink / Mask D

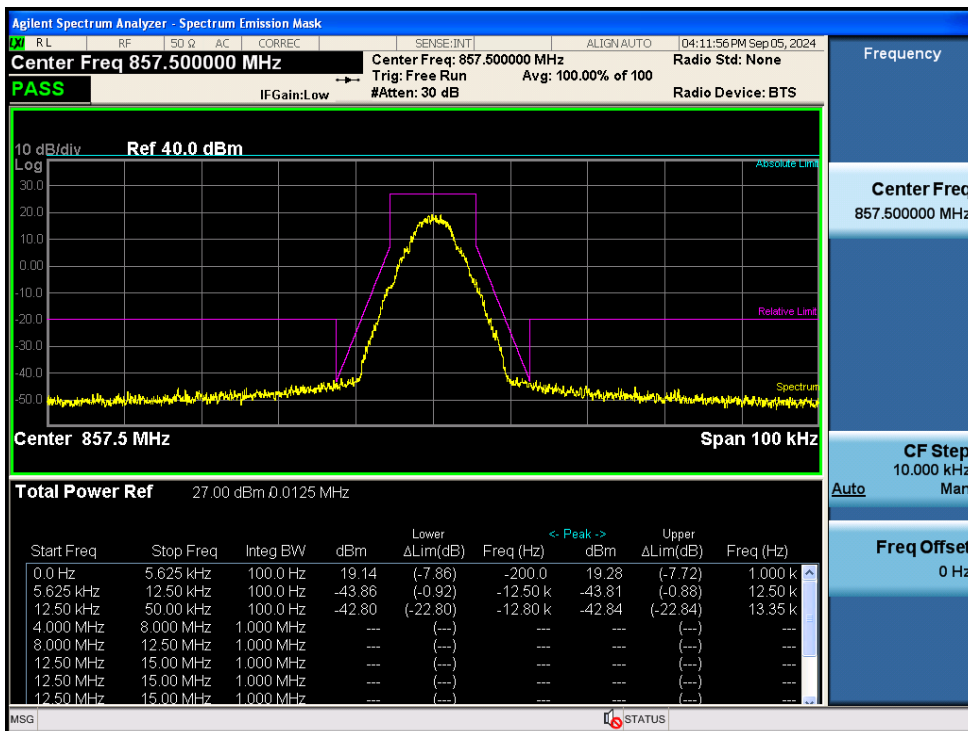

3 dB above the AGC threshold Input / B/ILT; SMR / 1 Carrier / Downlink / Mask D

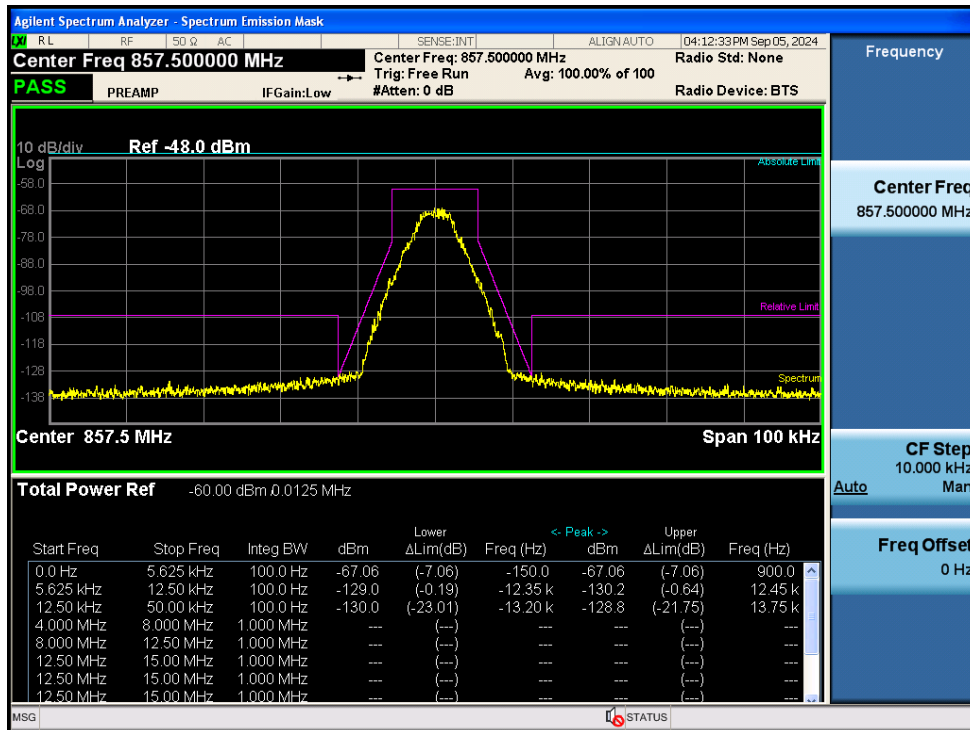

3 dB above the AGC threshold output / B/ILT; SMR / 1 Carrier / Downlink / Mask D

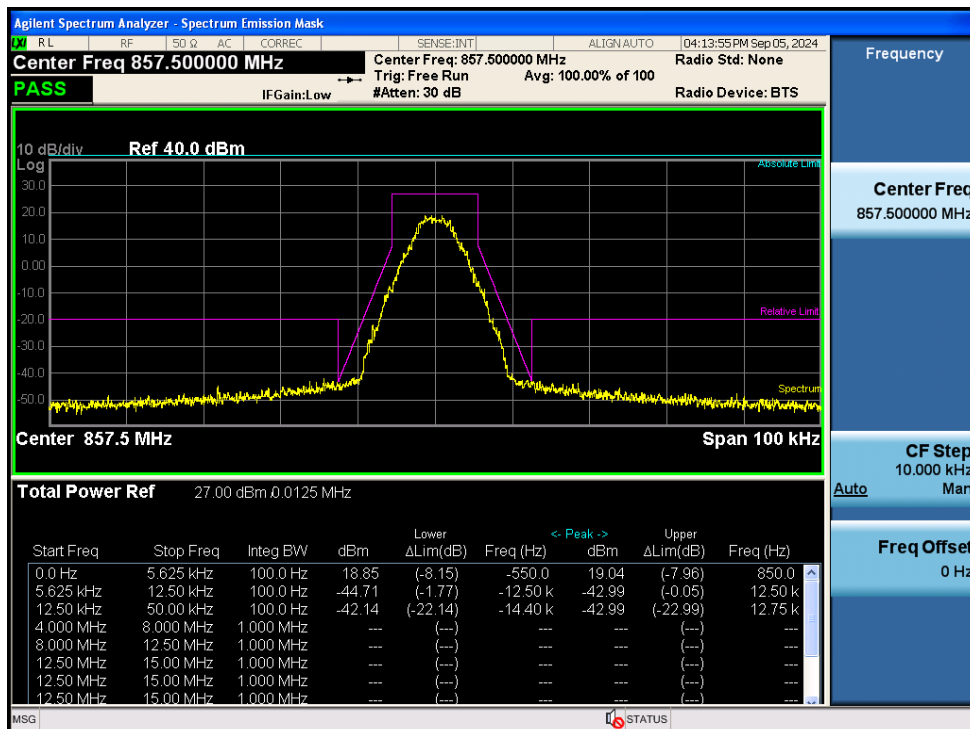

Input / ESMR / 1 Carrier / Downlink / Mask D

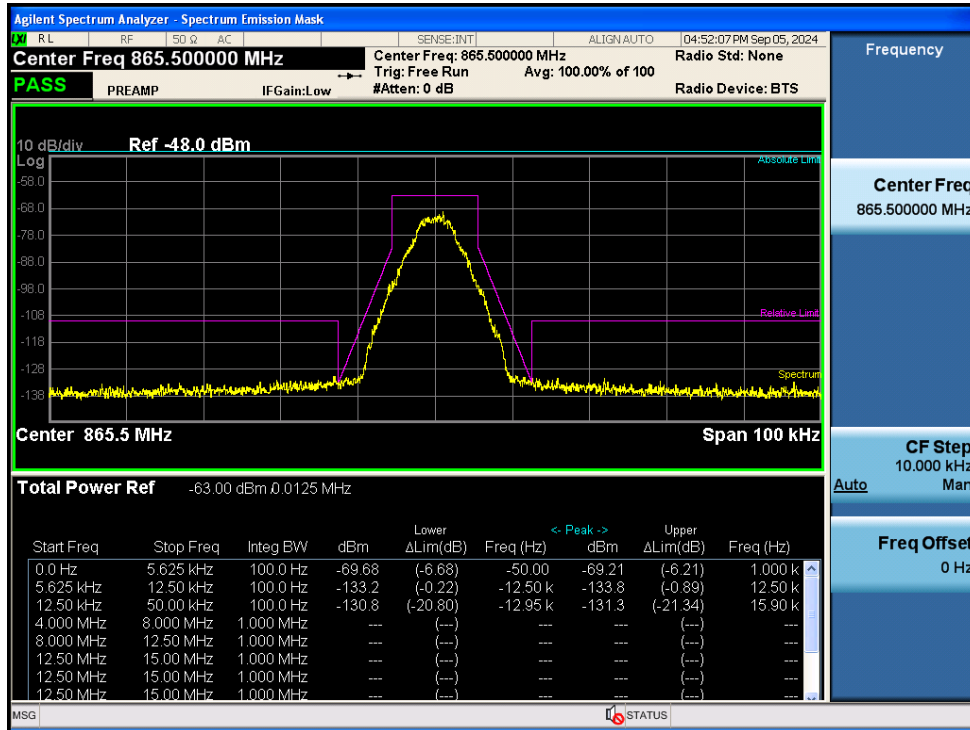

Output / ESMR / 1 Carrier / Downlink / Mask D

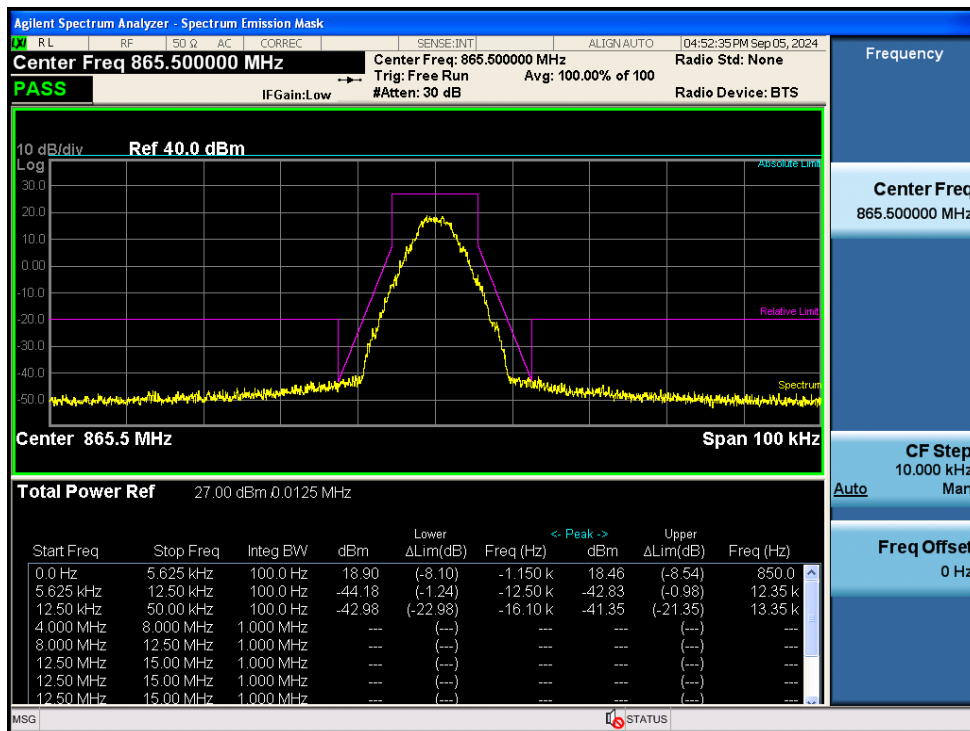

3 dB above the AGC threshold Input / ESMR / 1 Carrier / Downlink / Mask D

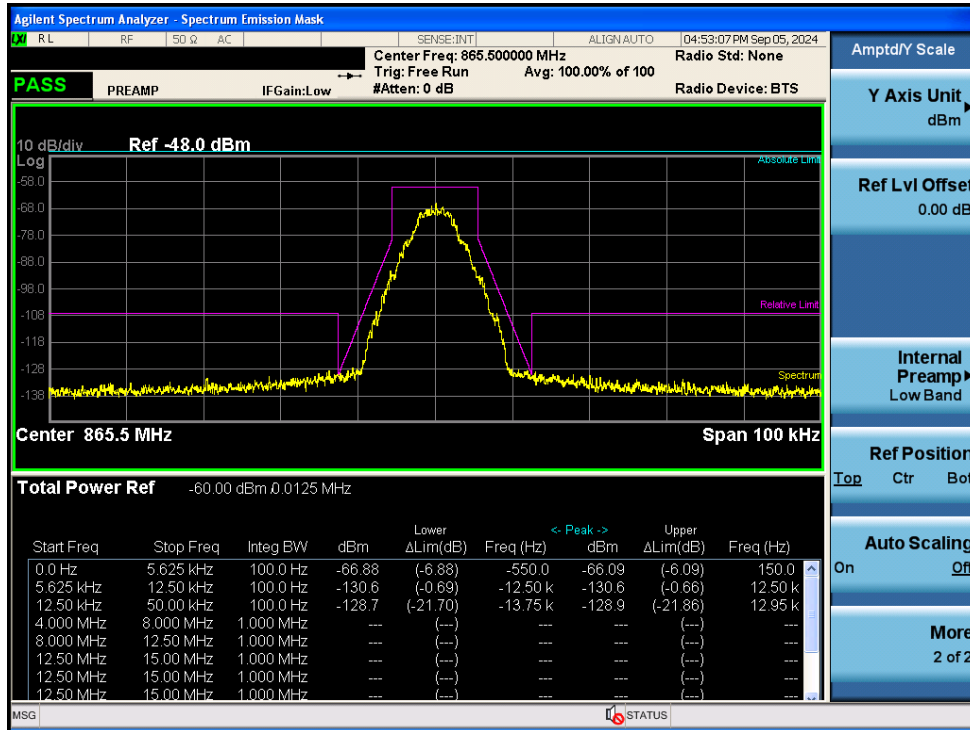

3 dB above the AGC threshold output / ESMR / 1 Carrier / Downlink / Mask D

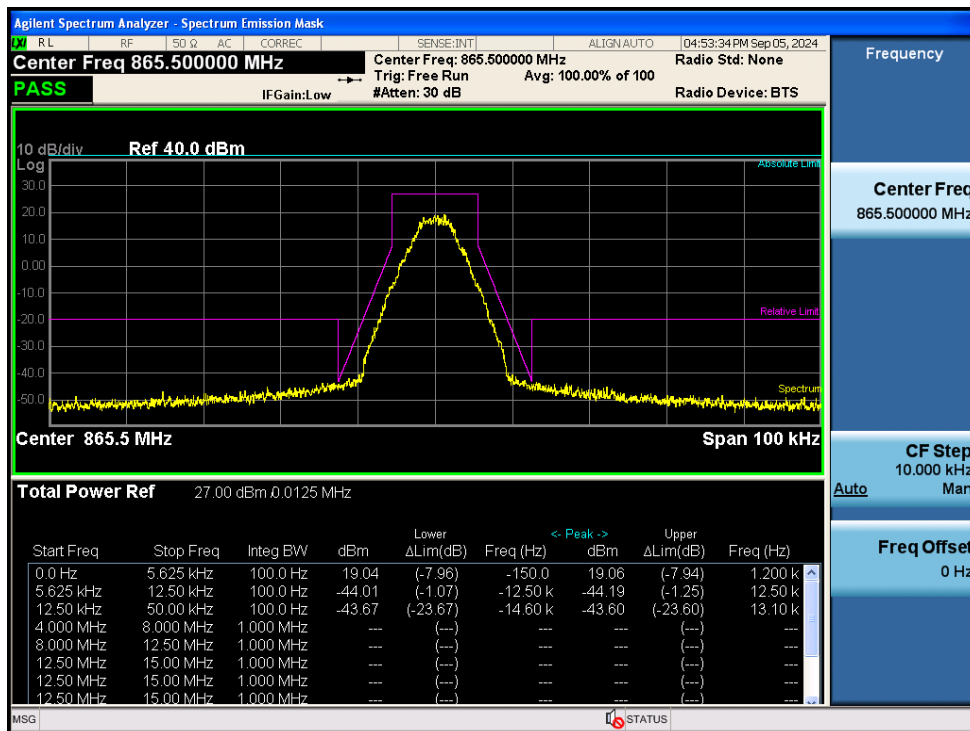

5.5. INPUT/OUTPUT POWER AND AMPLIFIER/BOOSTER GAIN

Test Requirement:

§ 2.1046 Measurements required: RF power output.

- (a) For transmitters other than single sideband, independent sideband and controlled carrier radiotelephone, power output shall be measured at the RF output terminals when the transmitter is adjusted in accordance with the tune-up procedure to give the values of current and voltage on the circuit elements specified in § 2.1033(c)(8). The electrical characteristics of the radio frequency load attached to the output terminals when this test is made shall be stated.
- (b) For single sideband, independent sideband, and single channel, controlled carrier radiotelephone transmitters the procedure specified in paragraph (a) of this section shall be employed and, in addition, the transmitter shall be modulated during the test as specified and applicable in § 2.1046 (b) (1-5). In all tests, the input level of the modulating signal shall be such as to develop rated peak envelope power or carrier power, as appropriate, for the transmitter.
- (c) For measurements conducted pursuant to paragraphs (a) and (b) of this section, all calculations and methods used by the applicant for determining carrier power or peak envelope power, as appropriate, on the basis of measured power in the radio frequency load attached to the transmitter output terminals shall be shown. Under the test conditions specified, no components of the emission spectrum shall exceed the limits specified in the applicable rule parts as necessary for meeting occupied bandwidth or emission limitations.

§ 90.219 Use of signal boosters.

- (e) Device Specifications. In addition to the general rules for equipment certification in § 90.203(a)(2) and part 2, subpart J of this chapter, a signal booster must also meet the rules in this paragraph.
 - (1) The output power capability of a signal booster must be designed for deployments providing a radiated power not exceeding 5 Watts ERP for each retransmitted channel.

Test Procedures:

Measurements were in accordance with the test methods section 4.5 of KDB 935210 D05 v01r04.

4.5.2 Measuring input and output power levels for determining amplifier/booster gain

Apply the same guidance as in 3.5.2 to measure the maximum input and output power levels necessary for computing the mean EUT gain, but with the following modifications:

- a) Configure the signal generator for CW operation, instead of AWGN,
- b) Select the spectrum analyzer positive peak detector, instead of the power averaging (rms) detector,
- c) Activate the max hold function, instead of the trace averaging function,
- d) Use in conjunction with the guidance in 4.5.3.

4.5.3 Power measurement Method 1: using a spectrum or signal analyzer

- a) Set the span to at least 1 MHz.
- b) Set the RBW 100 kHz.
- c) Set the VBW to $\geq 3 \times$ RBW.
- d) Set the detector to PEAK with the trace to MAX HOLD.
- e) Place a marker on the peak of the signal, and record the value as the maximum power.
- f) Repeat step e) but with the EUT in place.
- g) EUT gain may be calculated as described in 4.5.5.

4.5.5 Calculating amplifier, repeater, or industrial booster gain

After the input and output power levels have been measured as described in the preceding subclauses, the gain of the EUT can be determined from:

$$\text{Gain (dB)} = \text{output power (dBm)} - \text{input power (dBm)}.$$

Report the gain for each authorized operating frequency band, and each test signal stimulus.

Note:

1. If f_0 that determined from out-of-band rejection test is smaller or greater than difference of test signal's center frequency and operation band block, test is performed at the lowest or the highest frequency that test signals can be passed.
2. The Uplink/Downlink ERP is calculated as follows.
ex) ERP = Downlink Output Power + Peak Antenna Gain(dBi \rightarrow dBd)
 $= 27.12 \text{ dBm} + (8.00 \text{ dBi} - 2.15 \text{ dB}) = 32.97 \text{ dBm}$

Test Results:

Tabular data of Input / Output Power and Gain

Test Band	Link	Signal	No. of Carriers	f ₀ Frequency	Input Power	Output Power	Gain	E.R.P.	
				(MHz)	(dBm)		(dB)	(dBm)	(W)
Public Safety Narrowband	Uplink	P25 Phase 1	1	801.89	-56.07	24.15	80.22	31.00	1.26
	Downlink		1	770.38	-62.75	26.84	89.59	32.69	1.86
NPSPAC	Uplink		1	808.34	-56.28	23.12	79.40	29.97	0.99
	Downlink		1	851.76	-62.67	26.89	89.56	32.74	1.88
B/ILT; SMR	Uplink		1	812.41	-56.26	23.69	79.95	30.54	1.13
	Downlink		1	855.83	-62.71	27.12	89.83	32.97	1.98
ESMR	Uplink		1	823.95	-55.88	23.79	79.67	30.64	1.16
	Downlink		1	865.33	-62.08	27.09	89.17	32.94	1.97

- Peak Antenna Gain: Uplink: 9.0 dBi(6.85 dBd), Downlink: 8.0 dBi(5.85 dBd)

5.6. NOISE FIGURE

Test Requirements:

§ 90.219 Use of signal boosters.

- (e) Device Specifications. In addition to the general rules for equipment certification in § 90.203(a)(2) and part 2, subpart J of this chapter, a signal booster must also meet the rules in this paragraph.
- (2) The noise figure of a signal booster must not exceed 9 dB in either direction.

Test Procedures:

Measurements were in accordance with Agilent Application Note 57-1, 'The Direct Noise Measurement Method'. The output power of the device is measured with an input termination at a temperature of approximately 290K. If the gain of the device and noise bandwidth of the measurement system is known, the noise factor can be determined.

$$F_{sys} = \frac{N_o}{kT_oBG}$$

F_{sys} = System Noise Factor

N_o = Output Noise Power

k = Boltzmann's Constant

T_o = Standard Noise Temperature (290K)

B = Noise Bandwidth

G = Gain

' kT_oB ' calculation result for 1 MHz noise bandwidth is -114 dBm/MHz.

'Gain' value can be obtained from the test performed previously.

For measure the 'output noise power', perform the following procedure.

- Remove a signal generator from the input port of EUT then terminate it.
- Turn off the AGC function in EUT.
- Connect a spectrum analyzer to output port of EUT.
- Set the RBW 1 MHz. and set the VBW to $\geq 3 \times$ RBW.
- Measure the maximum output noise power for EUT pass band.

After the measurement, calculate the noise figure according to the following formular.

$$\text{Noise Figure} = \text{Noise Output Power} - kT_oB - \text{Gain}$$

Test Results:

Test Band	Link	Input Power (dBm)	Output Power (dBm)	Gain (dB)	kT ₀ B (dBm/MHz)	Measured Value (dBm)	Noise Figure (dB)
Public Safety Narrowband	Uplink	-56.07	24.15	80.22	-114	-29.43	4.36
	Downlink	-62.75	26.84	89.59	-114	-19.19	5.22
NPSPAC	Uplink	-56.28	23.12	79.40	-114	-30.11	4.49
	Downlink	-62.67	26.89	89.56	-114	-17.97	6.47
B/ILT; SMR	Uplink	-56.26	23.69	79.95	-114	-29.40	4.65
	Downlink	-62.71	27.12	89.83	-114	-18.12	6.05
ESMR	Uplink	-55.88	23.79	79.67	-114	-28.60	5.73
	Downlink	-62.08	27.09	89.17	-114	-17.92	6.90

Plot data of Noise Figure

Noise Figure / Public Safety Narrowband / Uplink

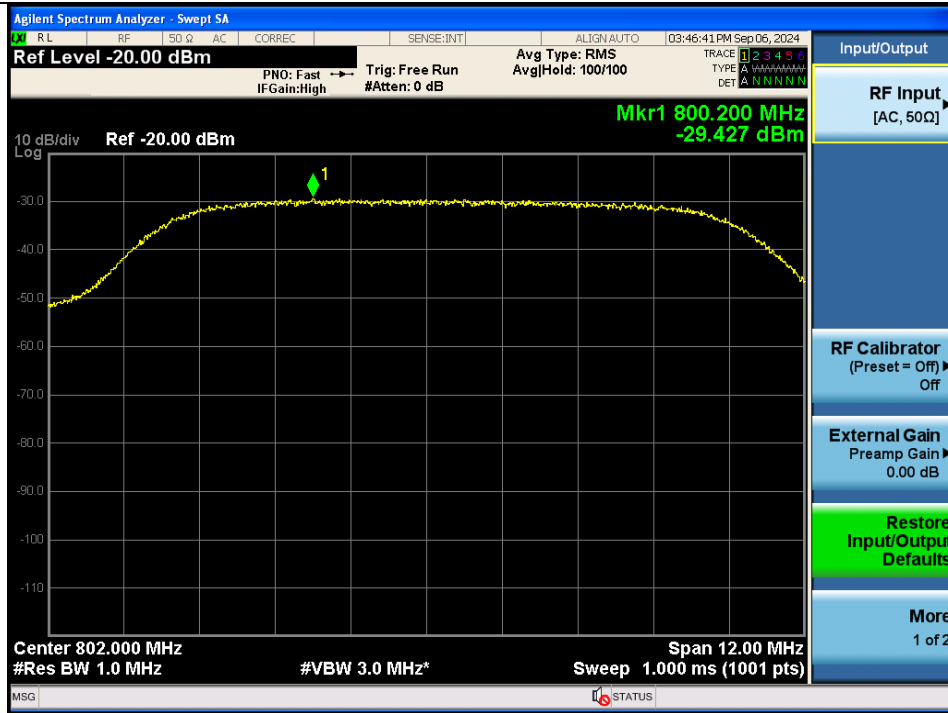

Note: The EUT is amplified over a frequency range of 788 ~ 806 MHz, but this test report uses the results for the frequency range of 799 ~ 805 MHz.

Noise Figure / 800 MHz (806 ~ 809, 809 ~ 816, 817 ~ 824) / Uplink

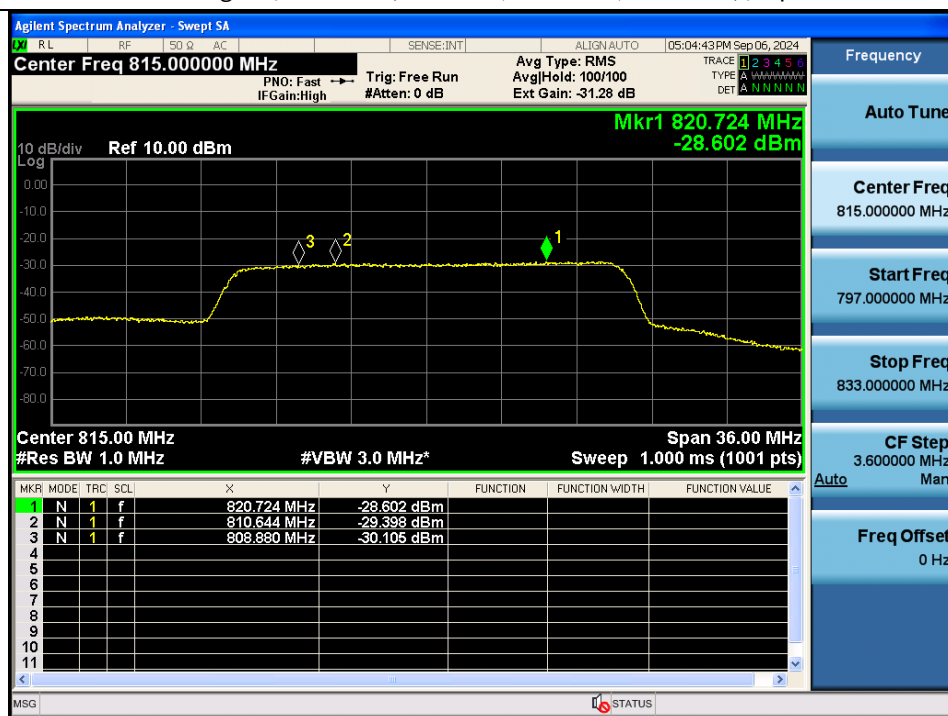

Note: The EUT is amplified over a frequency range of 806 ~ 824 MHz, but this test report uses the results for the frequency range of 806 ~ 809 MHz, 809 ~ 816 MHz, 817 ~ 824 MHz.

Noise Figure / Public Safety Narrowband / Downlink

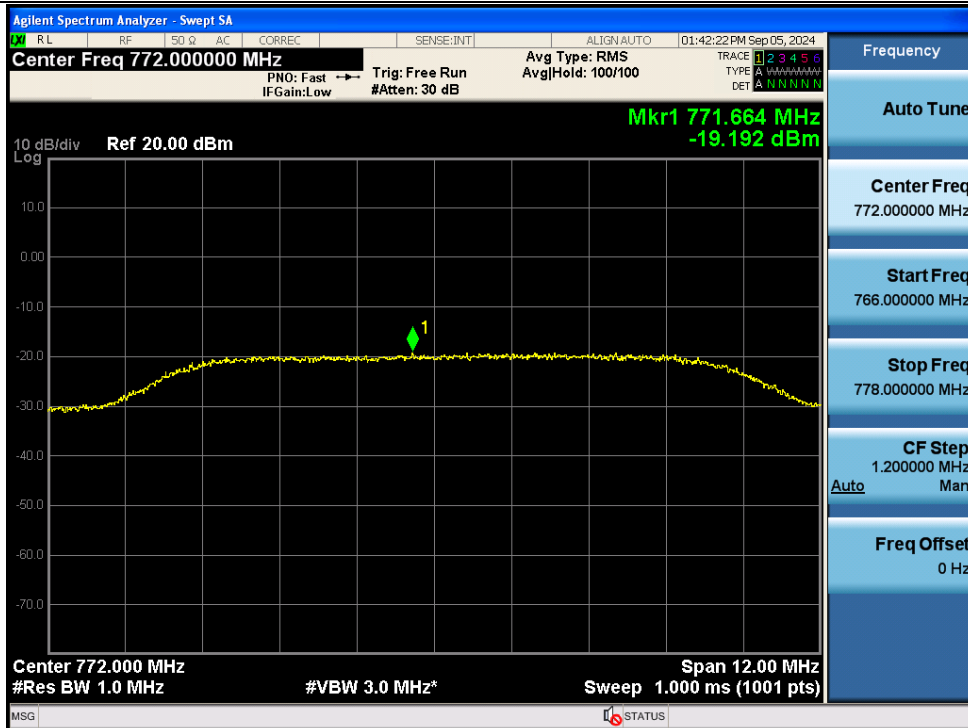

Note: The EUT is amplified over a frequency range of 758 ~ 776 MHz, but this test report uses the results for the frequency range of 769 ~ 775 MHz.

Noise Figure / 800 MHz (806 ~ 809, 809 ~ 816, 817 ~ 824) / Downlink

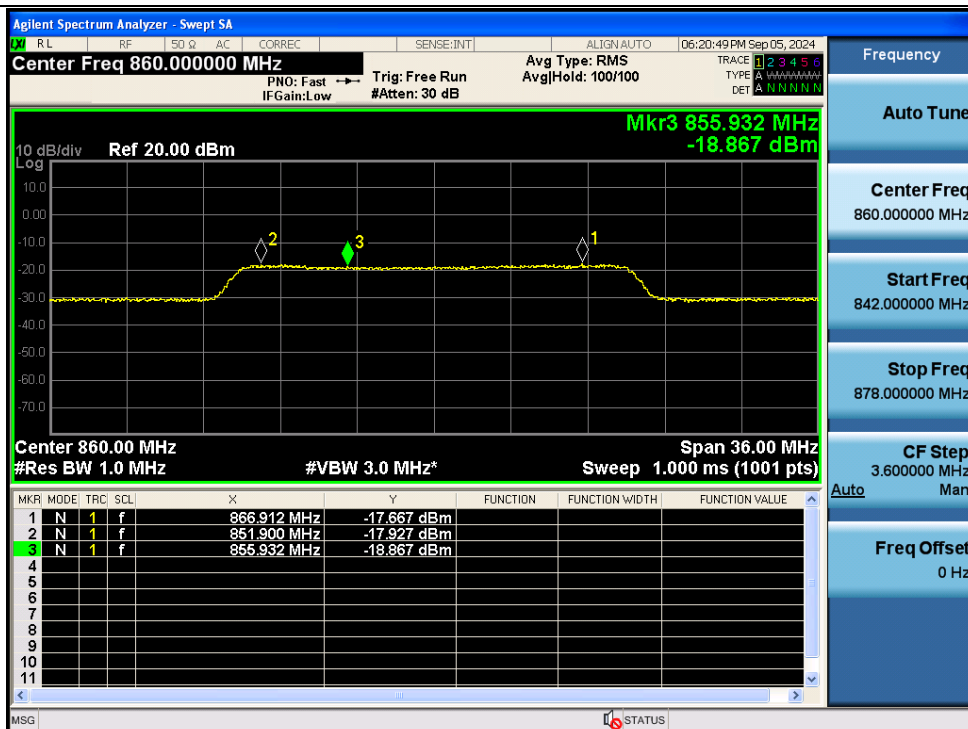

Note: The EUT is amplified over a frequency range of 851 ~ 869 MHz, but this test report uses the results for the frequency range of 851 ~ 854 MHz, 854 ~ 861 MHz, 862 ~ 869 MHz.

5.7. OUT-OF-BAND/OUT-OF-BLOCK EMISSIONS AND SPURIOUS EMISSIONS

§ 2.1051 Measurements required: Spurious emissions at antenna terminals.

The radio frequency voltage or powers generated within the equipment and appearing on a spurious frequency shall be checked at the equipment output terminals when properly loaded with a suitable artificial antenna. Curves or equivalent data shall show the magnitude of each harmonic and other spurious emission that can be detected when the equipment is operated under the conditions specified in § 2.1049 as appropriate. The magnitude of spurious emissions which are attenuated more than 20 dB below the permissible value need not be specified.

§ 90.219 Use of signal boosters.

- (e) Device Specifications. In addition to the general rules for equipment certification in § 90.203(a)(2) and part 2, subpart J of this chapter, a signal booster must also meet the rules in this paragraph.
 - (3) Spurious emissions from a signal booster must not exceed -13 dBm within any 100 kHz measurement bandwidth.

§ 90.543 Emission limitations.

- (f) For operations in the 758–775 MHz and 788–805 MHz bands, all emissions including harmonics in the band 1559–1610 MHz shall be limited to -70 dBW/MHz equivalent isotropically radiated power (EIRP) for wideband signals, and -80 dBW EIRP for discrete emissions of less than 700 Hz bandwidth. For the purpose of equipment authorization, a transmitter shall be tested with an antenna that is representative of the type that will be used with the equipment in normal operation.

Test Procedures:

Measurements were in accordance with the test methods section 4.7 of KDB 935210 D05 v01r04.

Spurious emissions shall be measured using a single test signal sequentially tuned to frequencies within each authorized frequency band of operation.

Intermodulation products shall be measured using two CW signals with all available channel spacing with the center between these channels being equal to the center frequency f_0 as determined from Out-of-band rejection test.

4.7.2 Out-of-band/out-of-block emissions conducted measurements

- a) Connect a signal generator to the input of the EUT.
- b) If the signal generator is not capable of producing two independent modulated carriers simultaneously, then two discrete signal generators can be connected, with an appropriate combining network to support the two-signal test.
- c) Configure the two signal generators to produce CW on frequencies spaced consistent with f_0 , with amplitude

levels set to just below the AGC threshold.

- d) Connect a spectrum analyzer to the EUT output.
- e) Set the span to 100 kHz.
- f) Set RBW = 300 Hz with VBW $\geq 3 \times$ RBW.
- g) Set the detector to power averaging (rms).
- h) Place a marker on highest intermodulation product amplitude.
- i) Capture the plot for inclusion in the test report.
- j) Repeat steps c) to h) with the composite input power level set to 3 dB above the AGC threshold.
- k) Repeat steps b) to i) for all operational bands.

4.7.3 EUT spurious emissions conducted measurements

- a) Connect a signal generator to the input of the EUT.
- b) Configure the signal generator to produce a CW signal.
- c) Set the frequency of the CW signal to the center channel of the EUT passband.
- d) Set the output power level so that the resultant signal is just below the AGC threshold.
- e) Connect a spectrum analyzer to the output of the EUT, using appropriate attenuation as necessary.
- f) Set the RBW = 100 kHz. (i.e., for 30 MHz to 1 GHz PLMRS and/or PSRS booster devices)
- g) Set the VBW = $3 \times$ RBW.
- h) Set the Sweep time = auto-couple.
- i) Set the detector to PEAK.
- j) Set the spectrum analyzer start frequency to 30 MHz (or the lowest radio frequency signal generated in the EUT, without going below 9 kHz if the EUT has additional internal clock frequencies), and the stop frequency to 10 times the highest allowable frequency of the EUT passband.
- k) Select MAX HOLD, and use the marker peak function to find the highest emission(s) outside the passband. (This could be either at a frequency lesser or greater than the passband frequencies.)
- l) Capture a plot for inclusion in the test report.
- m) Repeat steps c) to l) for each authorized frequency band/block of operation.

Test Results: Plot data of Out-of-band/out-of-block emissions

Out-of-band (two adjacent test signals) / Public Safety Narrowband / Uplink

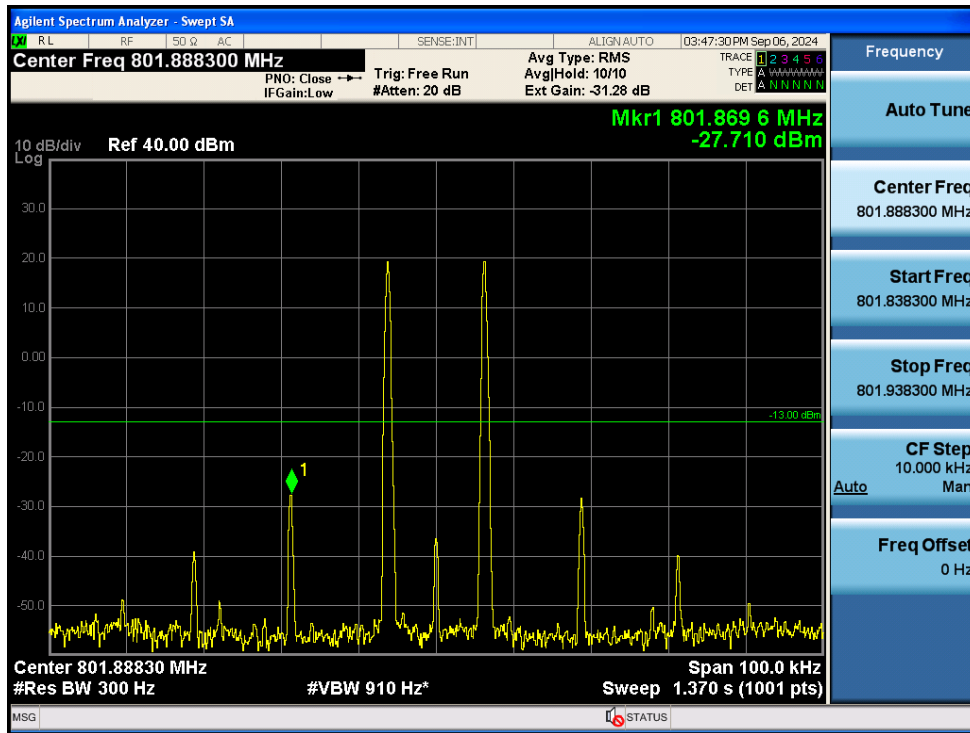

+3 dB above Out-of-band (two adjacent test signals) / Public Safety Narrowband / Uplink

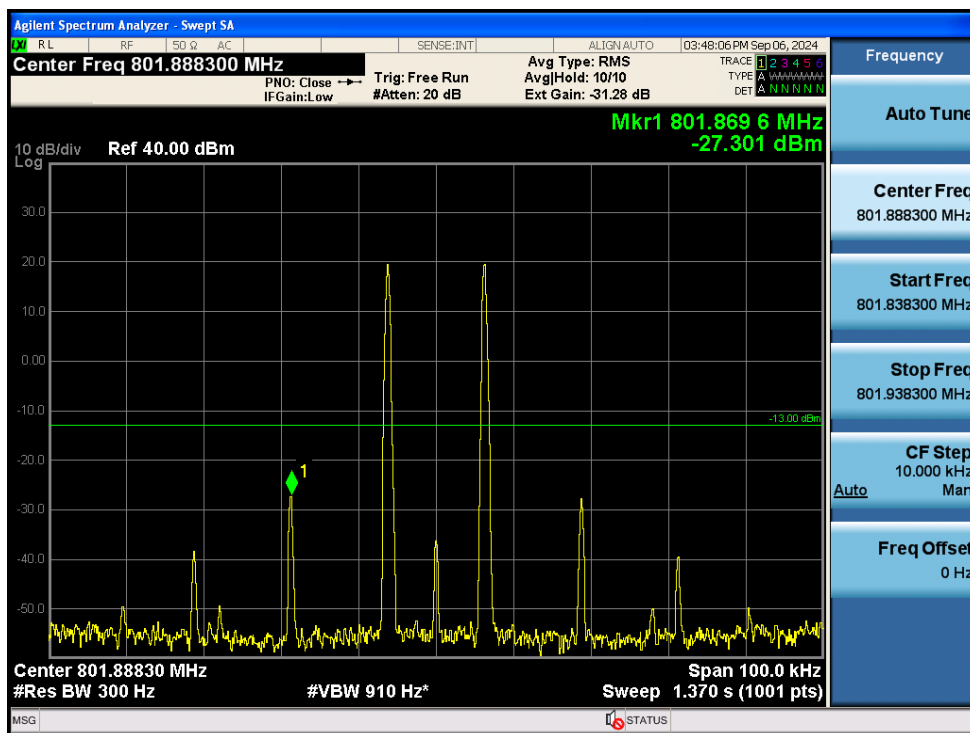

Out-of-band (two adjacent test signals) / NPSPAC / Uplink

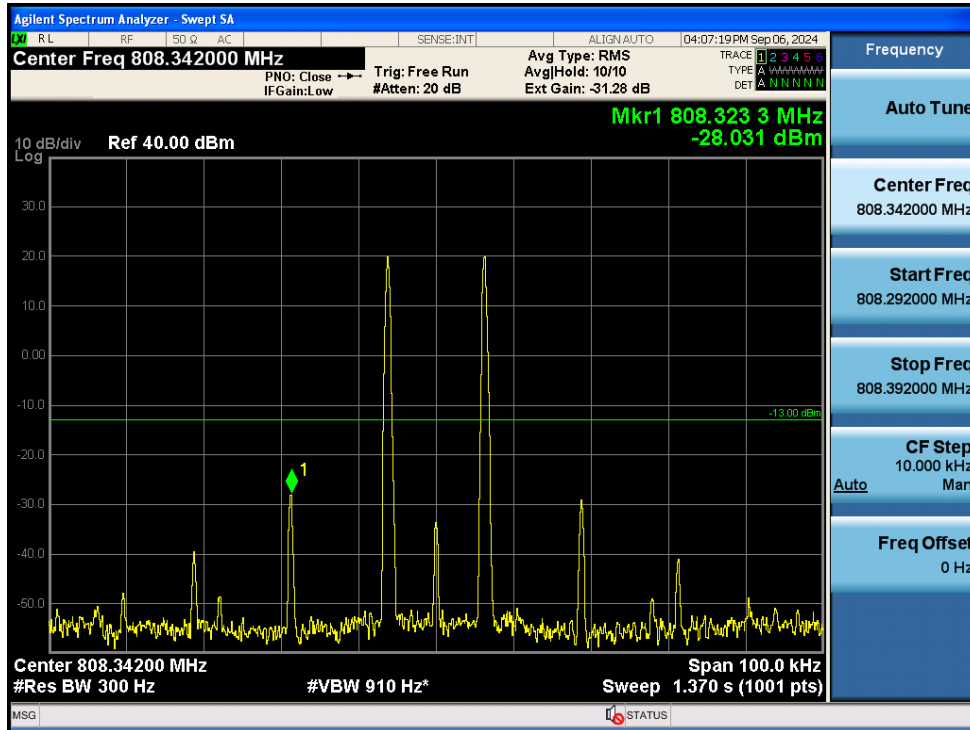

+3 dB above Out-of-band (two adjacent test signals) / NPSPAC / Uplink

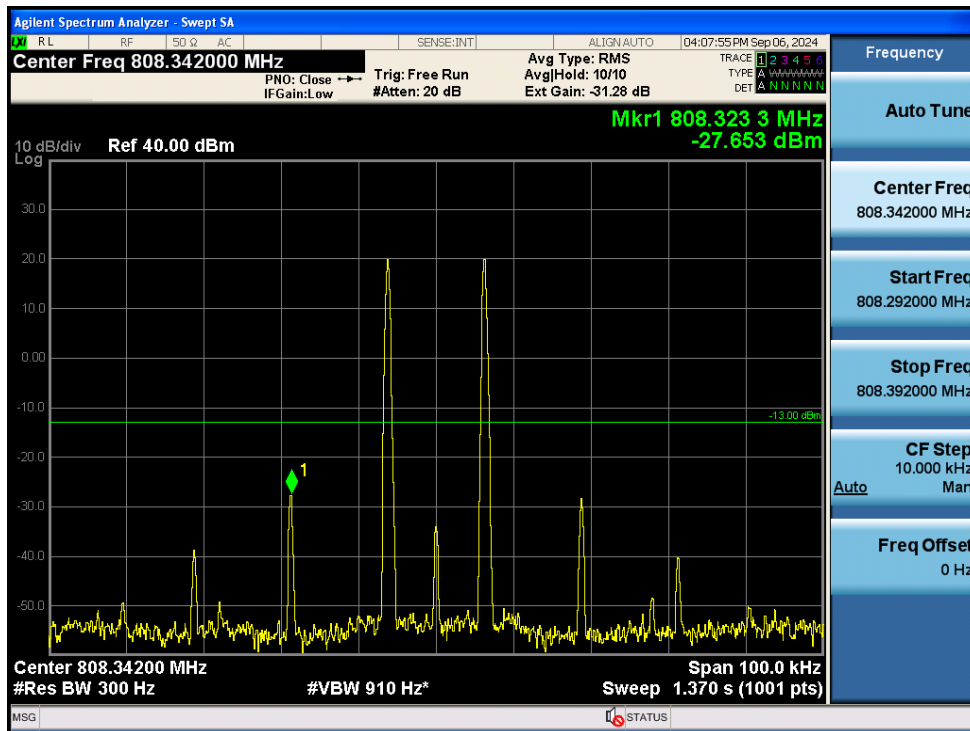

Out-of-band (two adjacent test signals) / B/ILT; SMR / Uplink

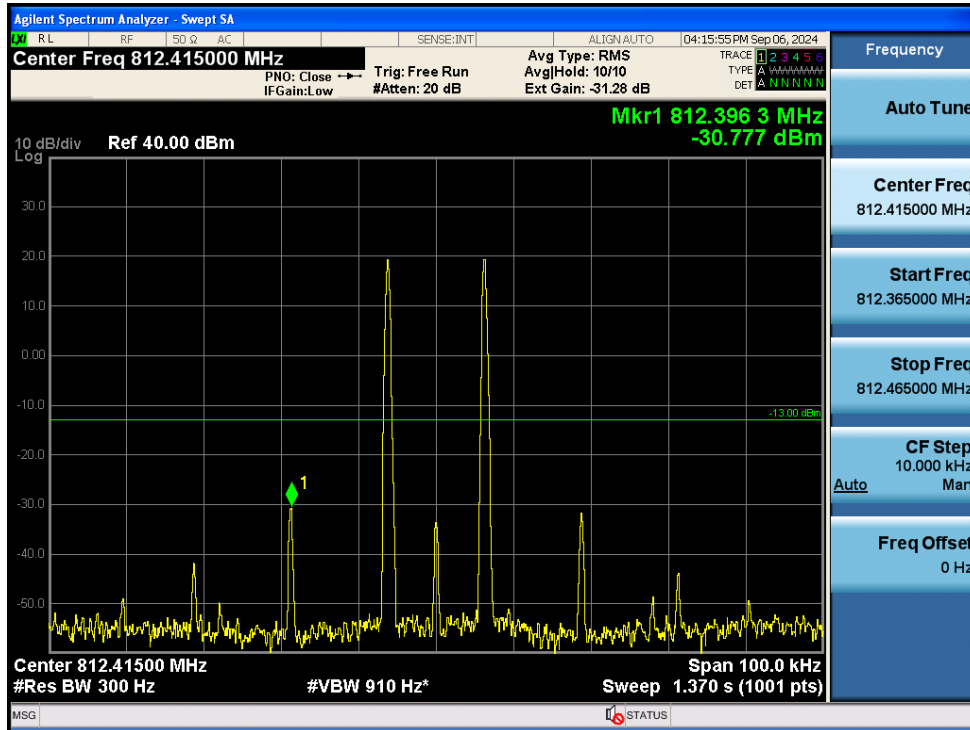

+3 dB above Out-of-band (two adjacent test signals) / B/ILT; SMR / Uplink

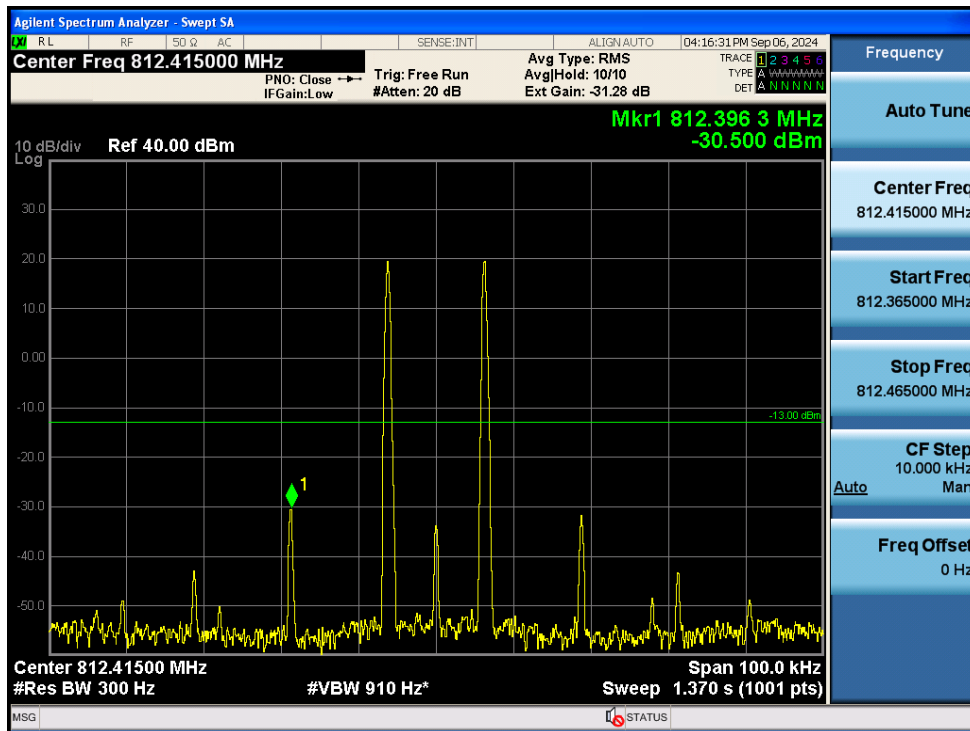

Out-of-band (two adjacent test signals) / ESMR / Uplink

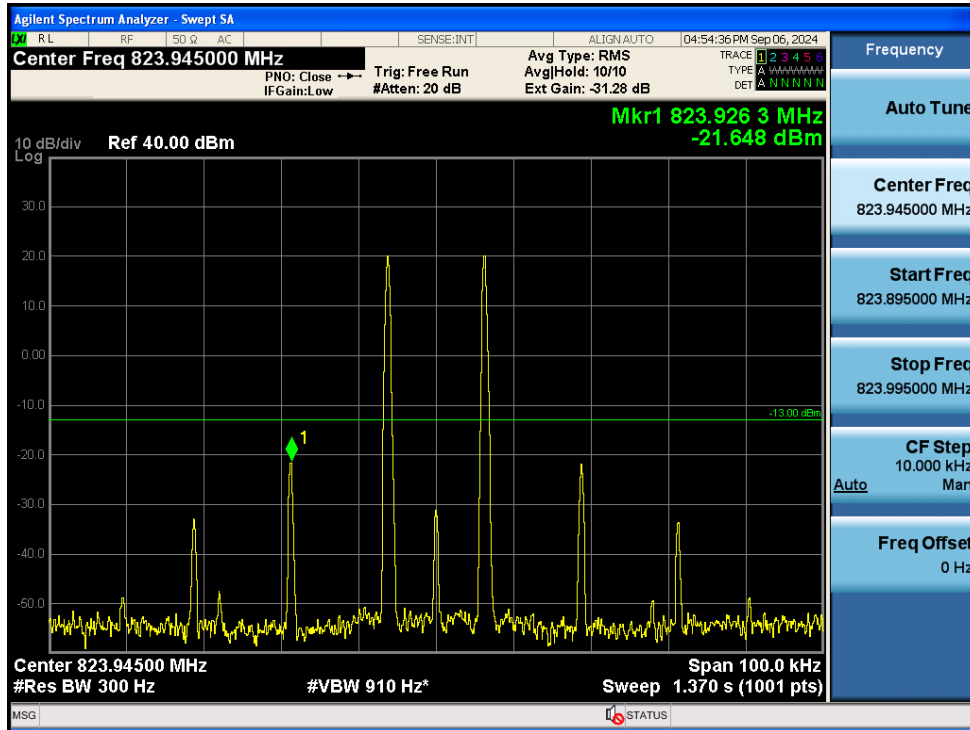

+3 dB above Out-of-band (two adjacent test signals) / ESMR / Uplink

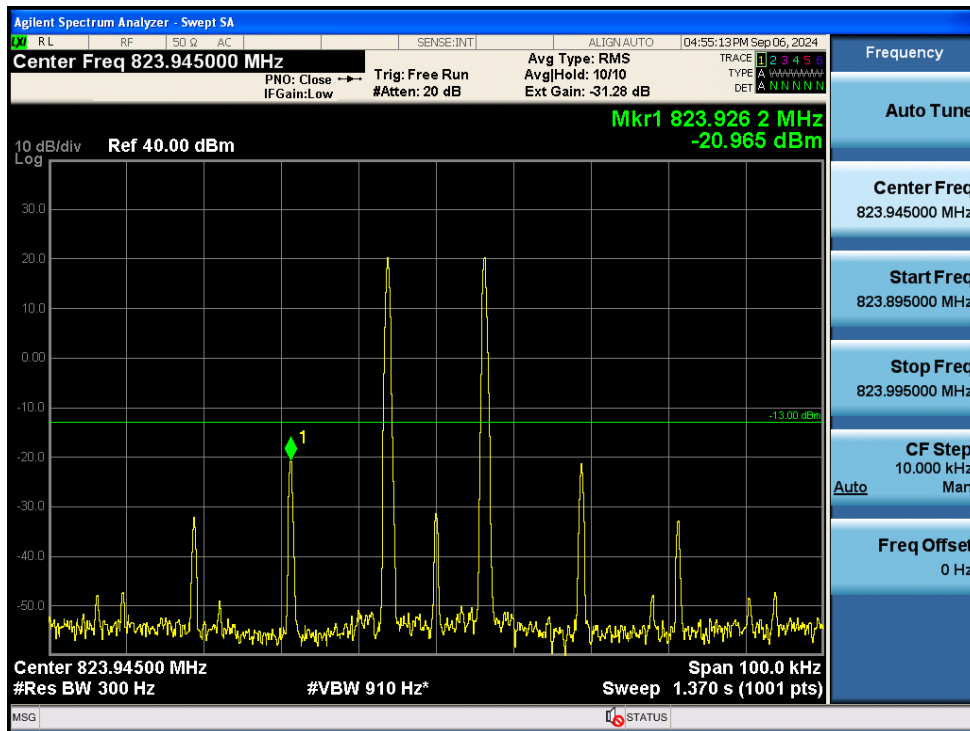

Out-of-band (two adjacent test signals) / Public Safety Narrowband / Downlink

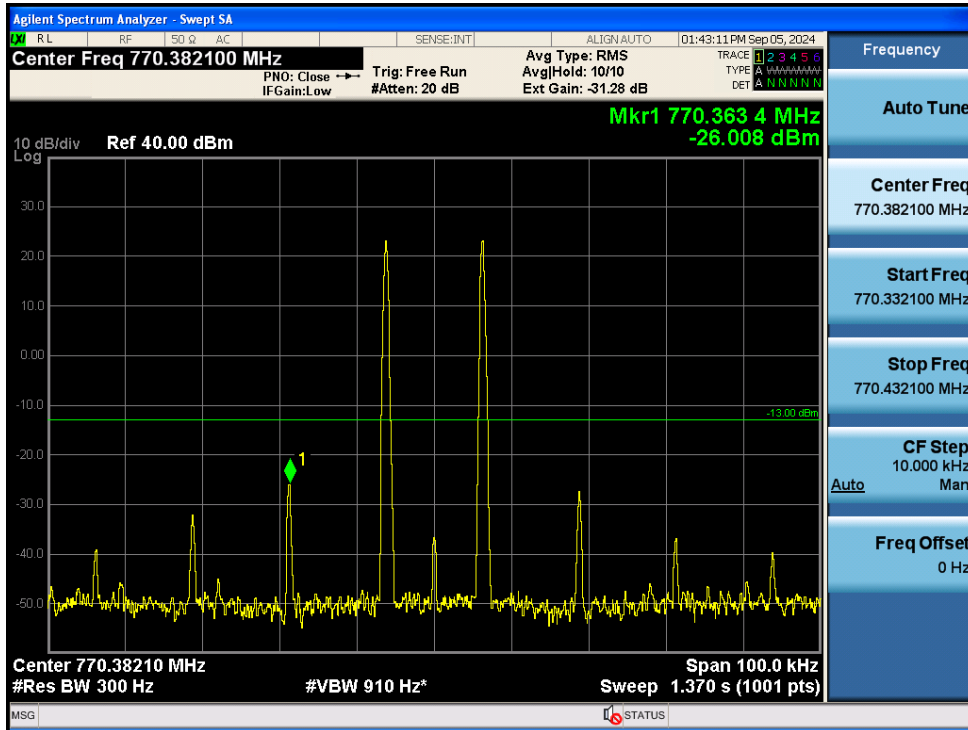

+3 dB above Out-of-band (two adjacent test signals) / Public Safety Narrowband / Downlink

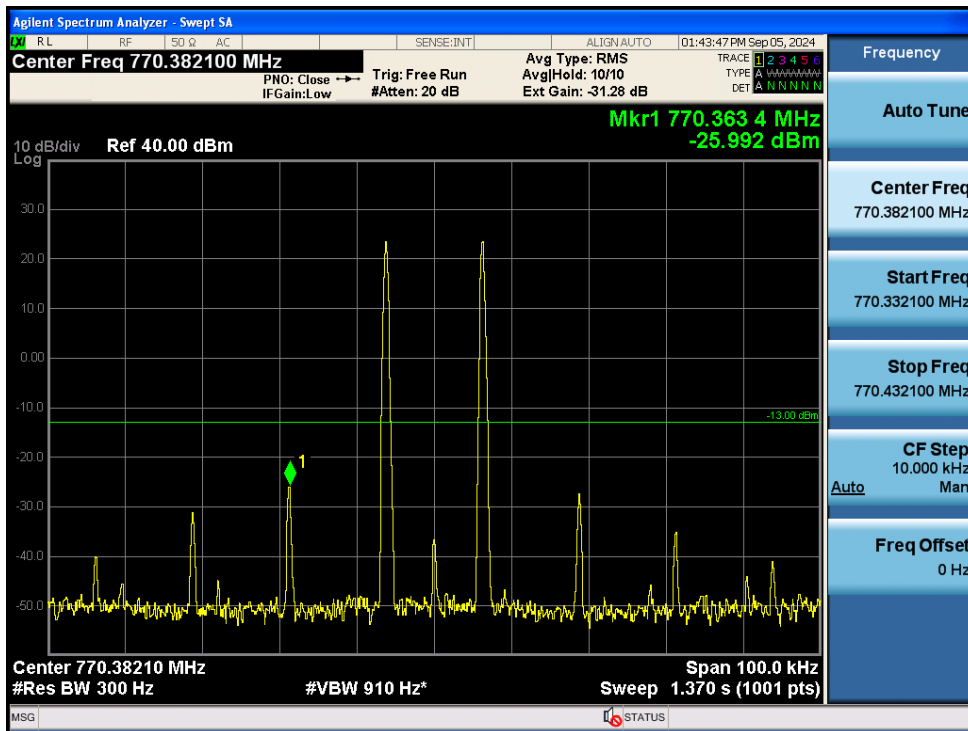

Out-of-band (two adjacent test signals) / NPSPAC / Downlink

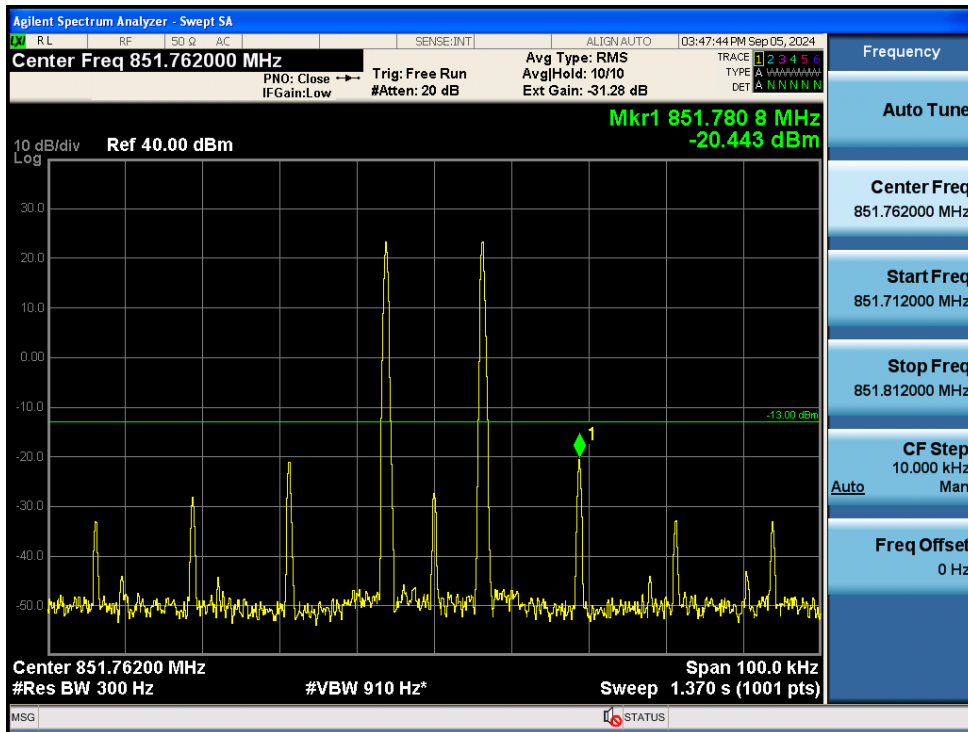

+3 dB above Out-of-band (two adjacent test signals) / NPSPAC / Downlink

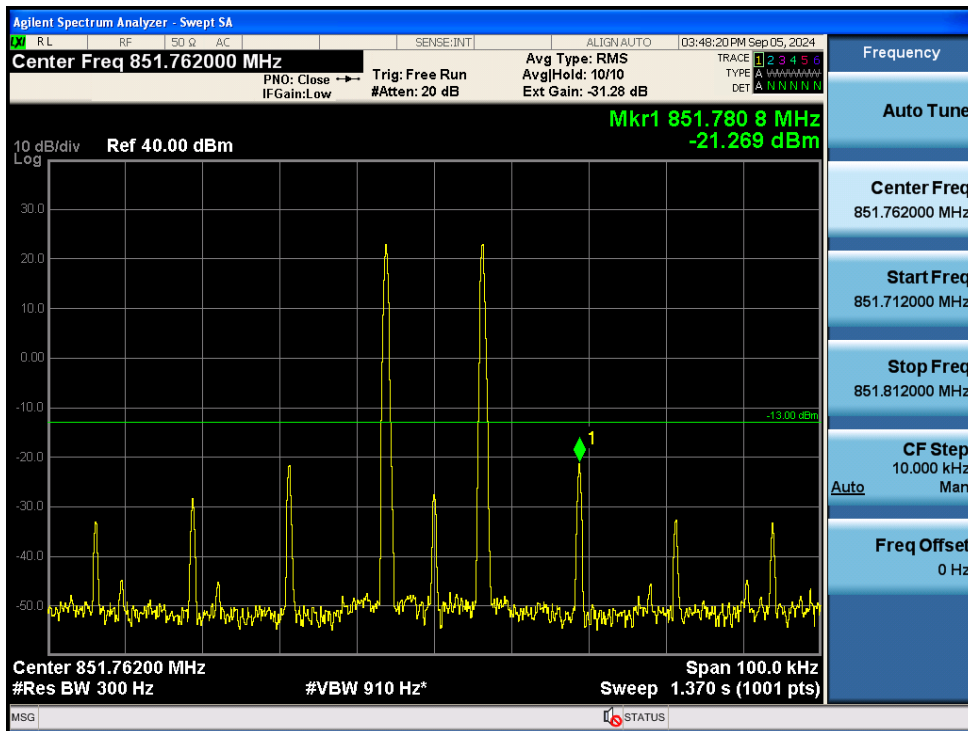

Out-of-band (two adjacent test signals) / B/ILT; SMR / Downlink

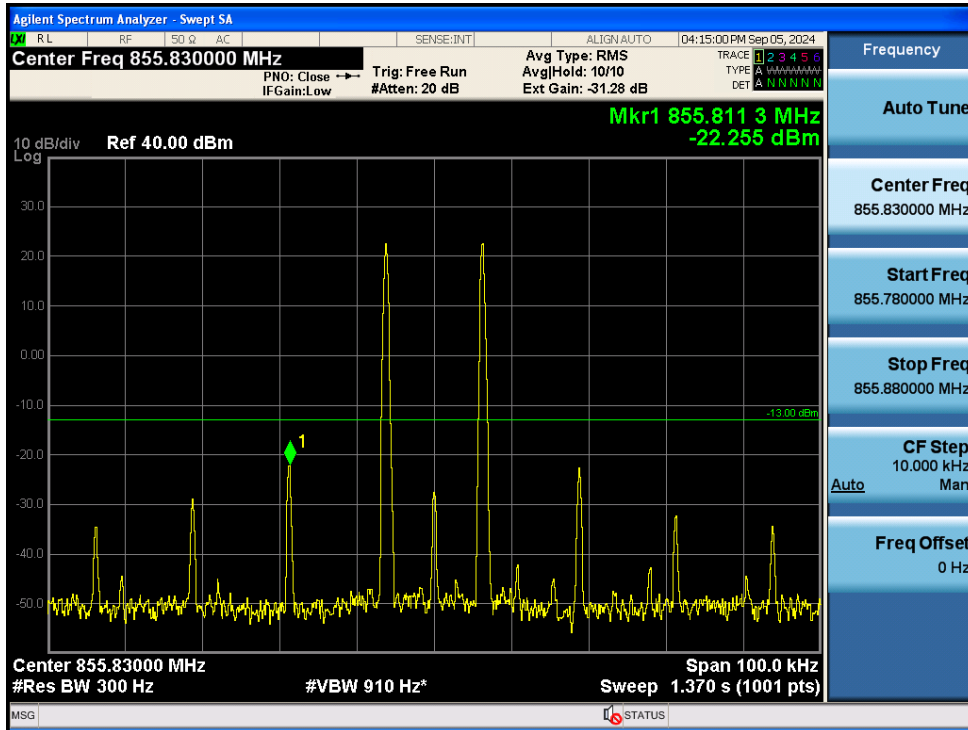

+3 dB above Out-of-band (two adjacent test signals) / B/ILT; SMR / Downlink

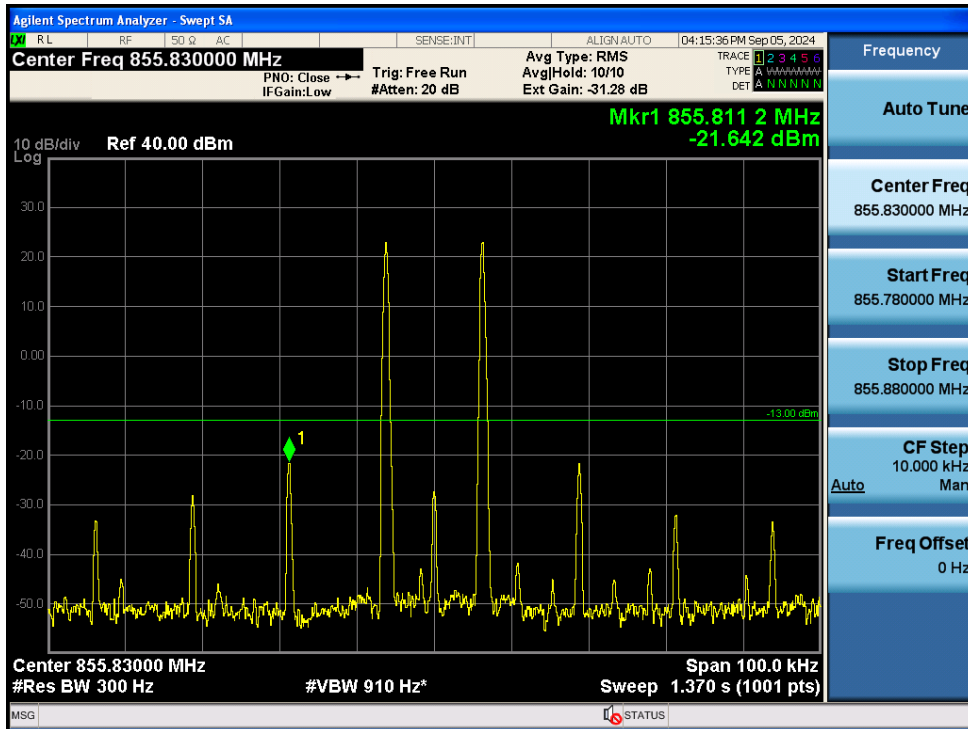

Out-of-band (two adjacent test signals) / ESMR / Downlink

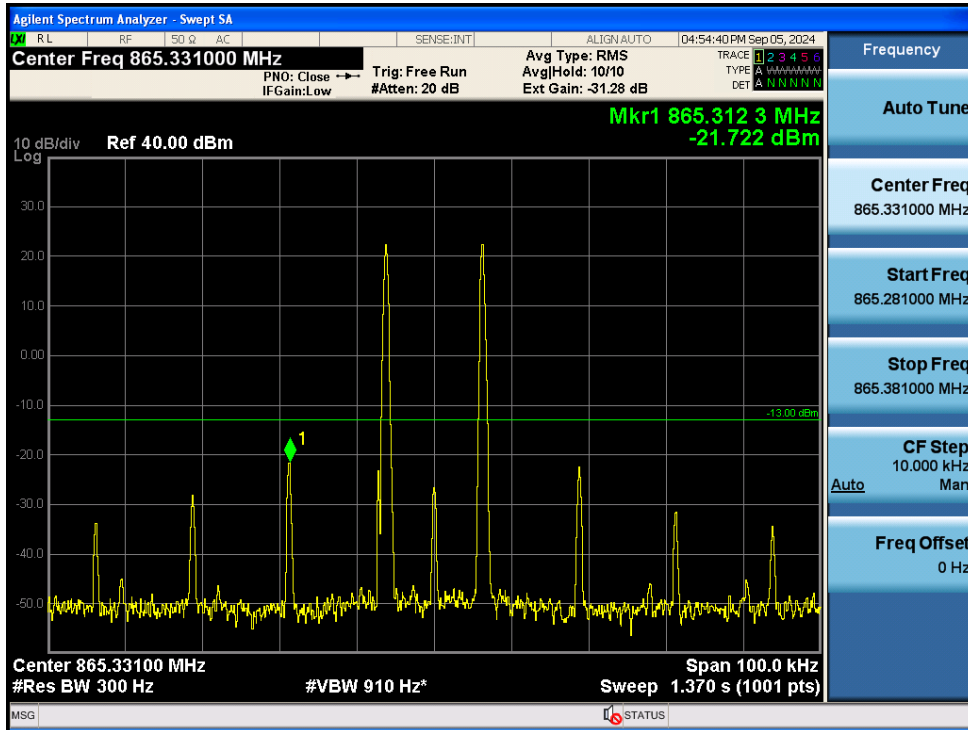

+3 dB above Out-of-band (two adjacent test signals) / ESMR / Downlink

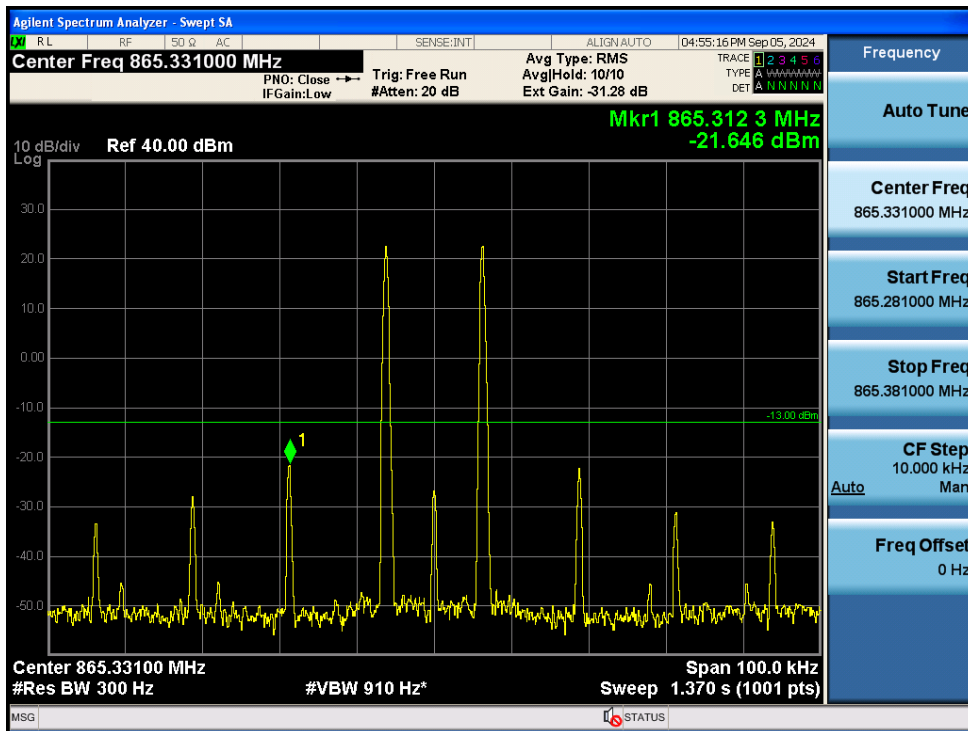

Plot data of Spurious Emissions

Spurious / Public Safety Narrowband / Uplink / 1 Carrier



Spurious / Public Safety Narrowband / Uplink / 1 Carrier / Additional 1559 ~ 1610 MHz

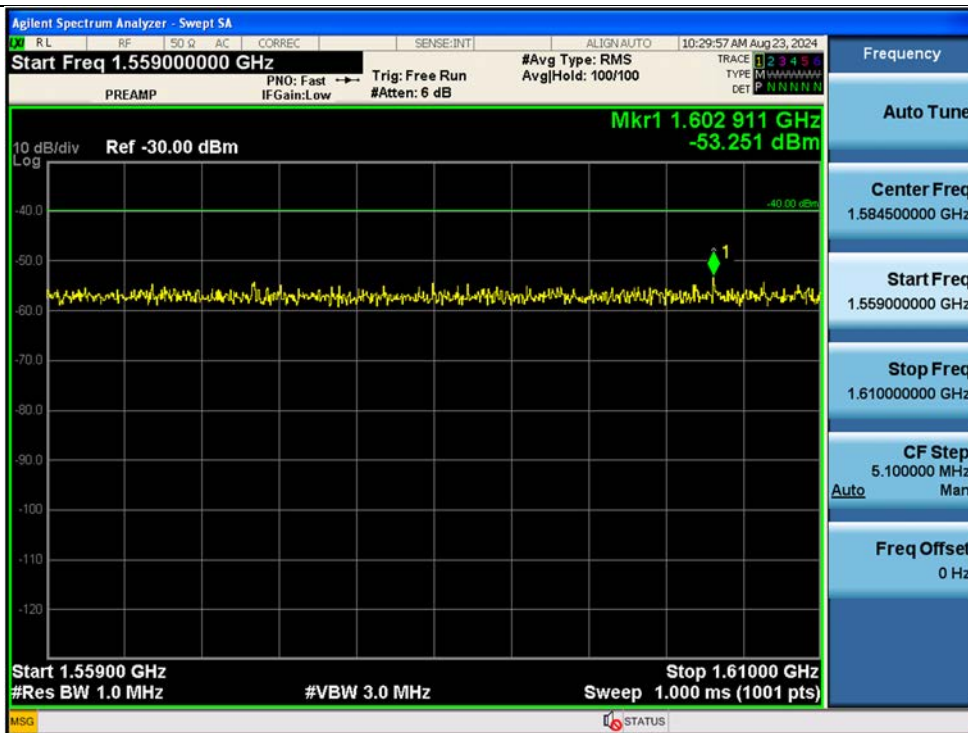

Measured Level + Ant. Gain = -53.251 dBm + 9 dBi = -44.251 dBm(E.I.R.P.) complies with the limit 90.543(f).

Spurious / NPSPAC / Uplink / 1 Carrier

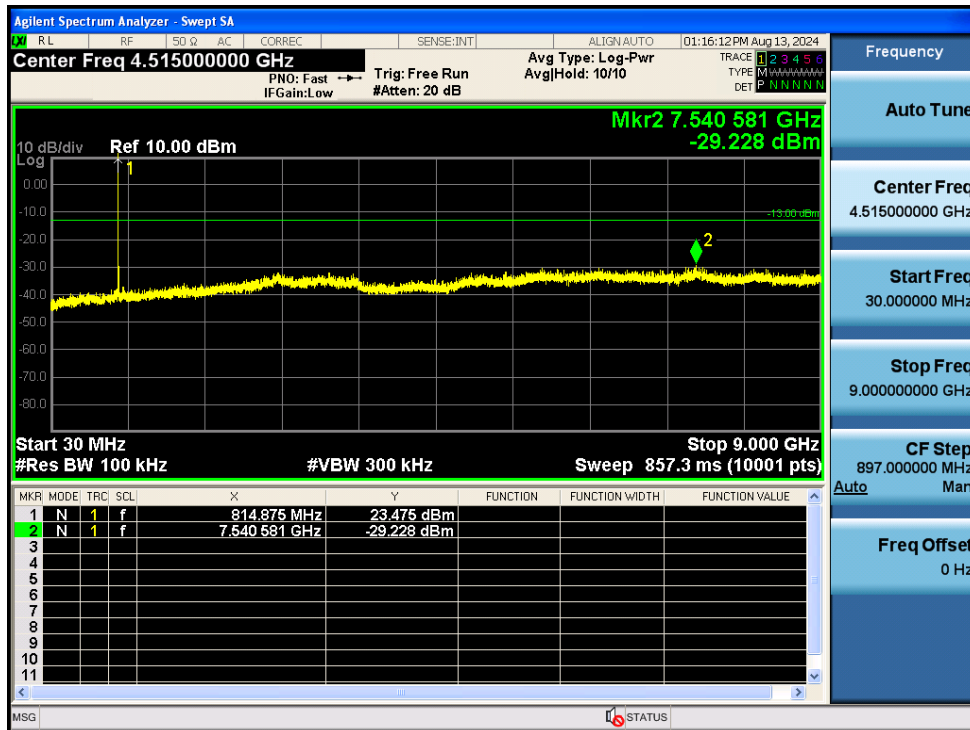

Spurious / B/ILT; SMR / Uplink / 1 Carrier

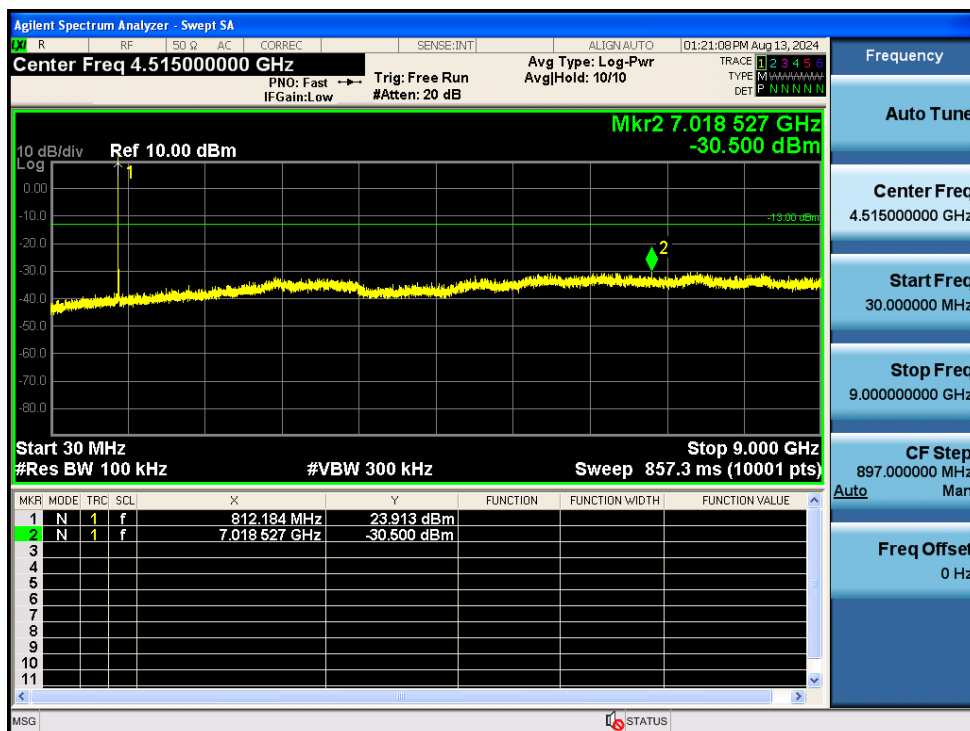

Spurious / ESMR / Uplink / 1 Carrier

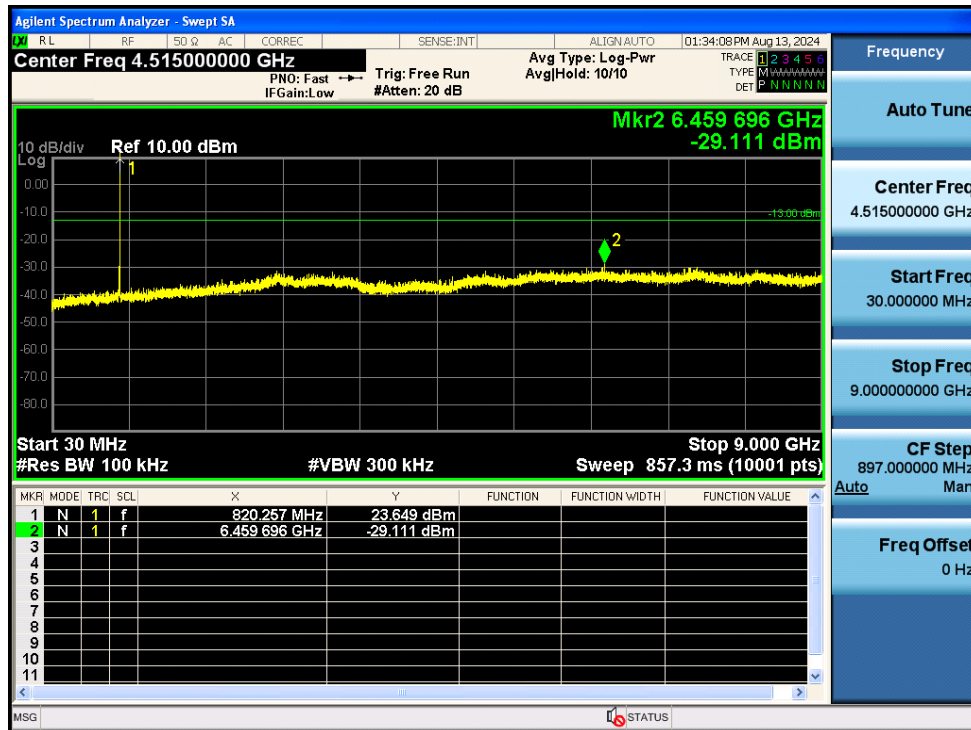

Simultaneous / Spurious / Public Safety Narrowband + ESMR / Uplink

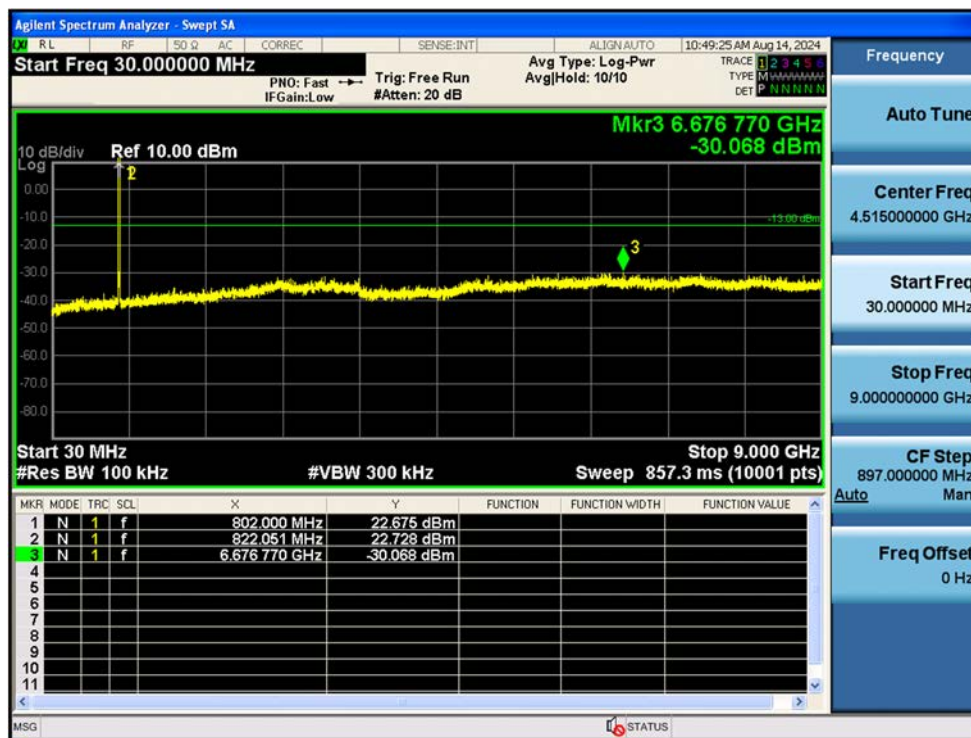

Note: Only the worst case plots for simultaneous spurious emissions.

Simultaneous / Spurious / Public Safety Narrowband + ESMR / Uplink / 1 Carrier / Additional 1559 MHz ~ 1610 MHz

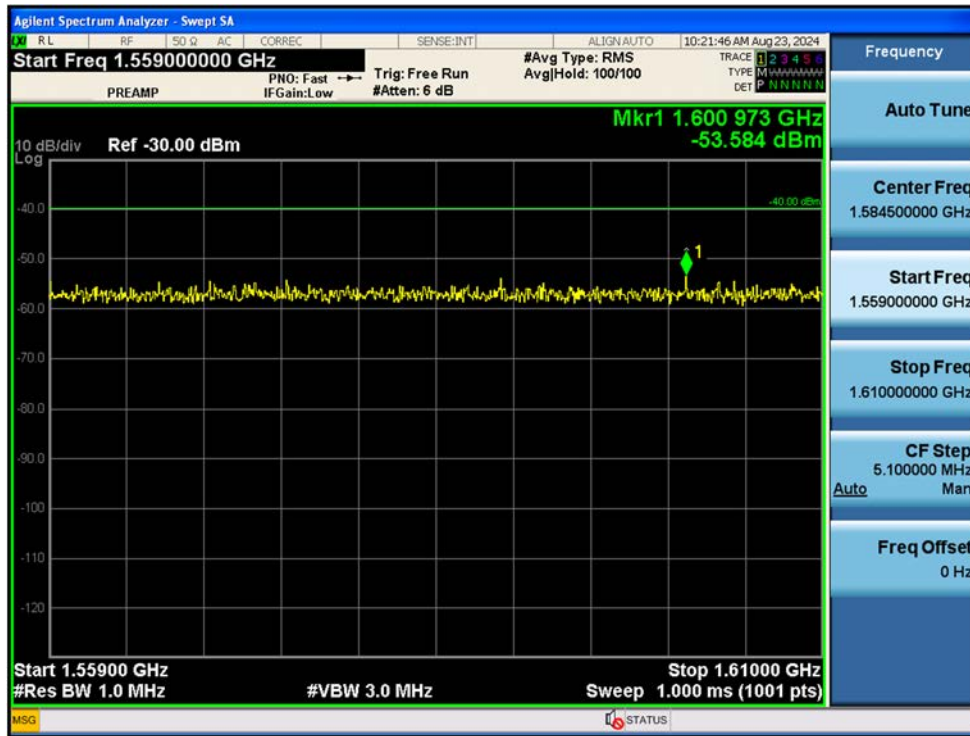

Measured Level + Ant. Gain = -53.584 dBm + 9 dBi = -44.584 dBm(E.I.R.P.) complies with the limit 90.543(f).

Spurious / Public Safety Narrowband / Downlink / 1 Carrier

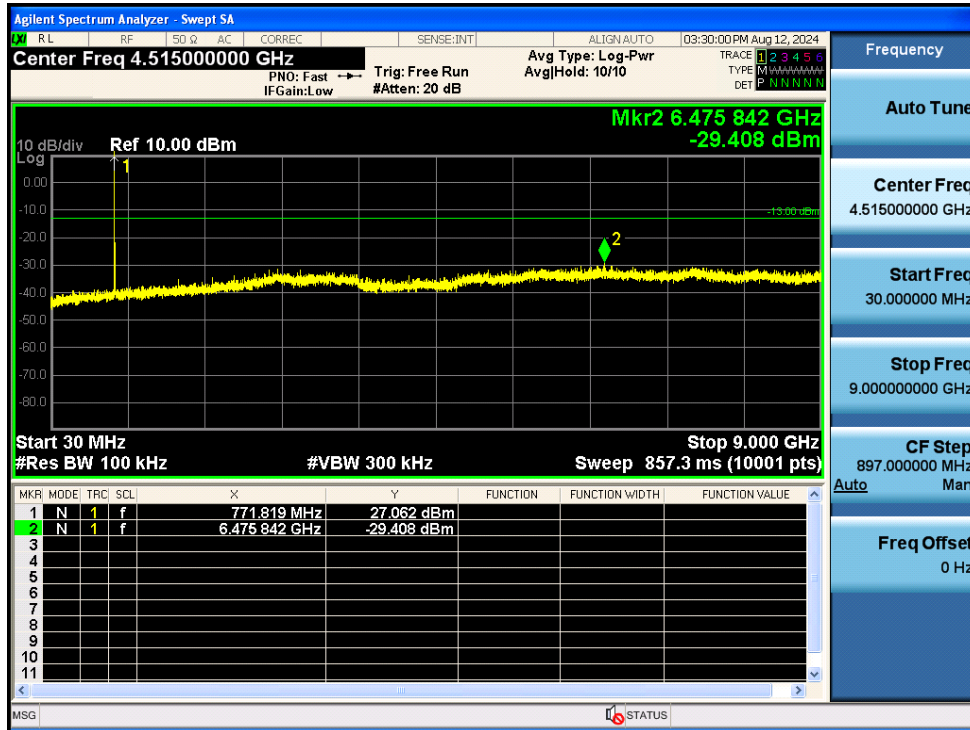

Spurious / Public Safety Narrowband / Downlink / 1 Carrier / Additional 1559 MHz ~ 1610 MHz

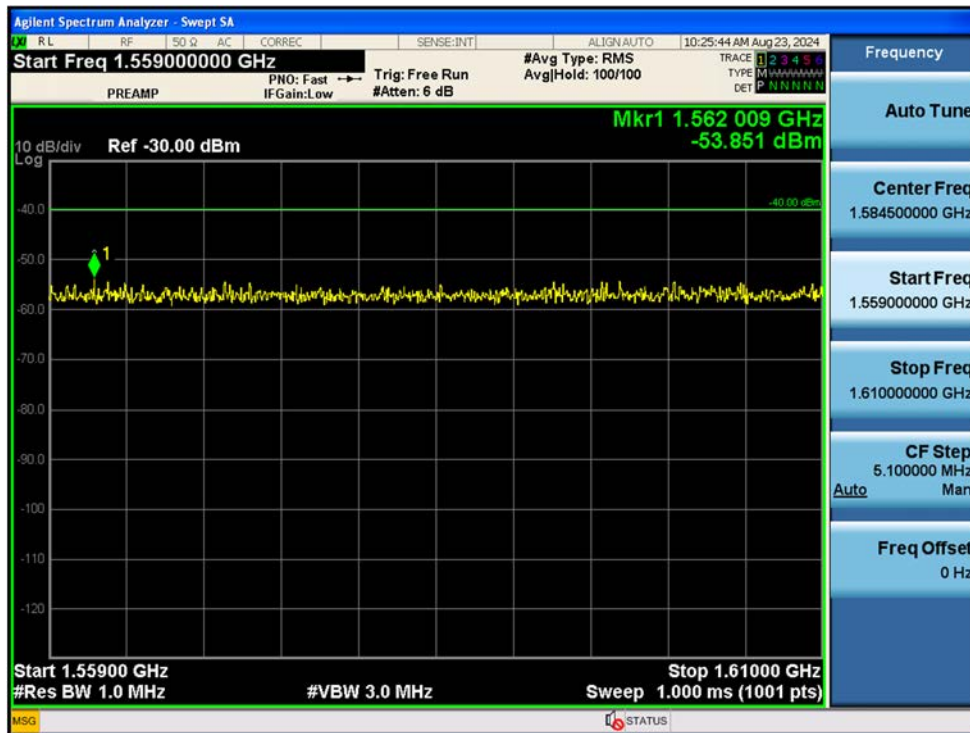

Measured Level + Ant. Gain = -53.851 dBm + 8 dBi = -45.851 dBm(E.I.R.P.) complies with the limit 90.543(f).

Spurious / NPSPAC / Downlink / 1 Carrier

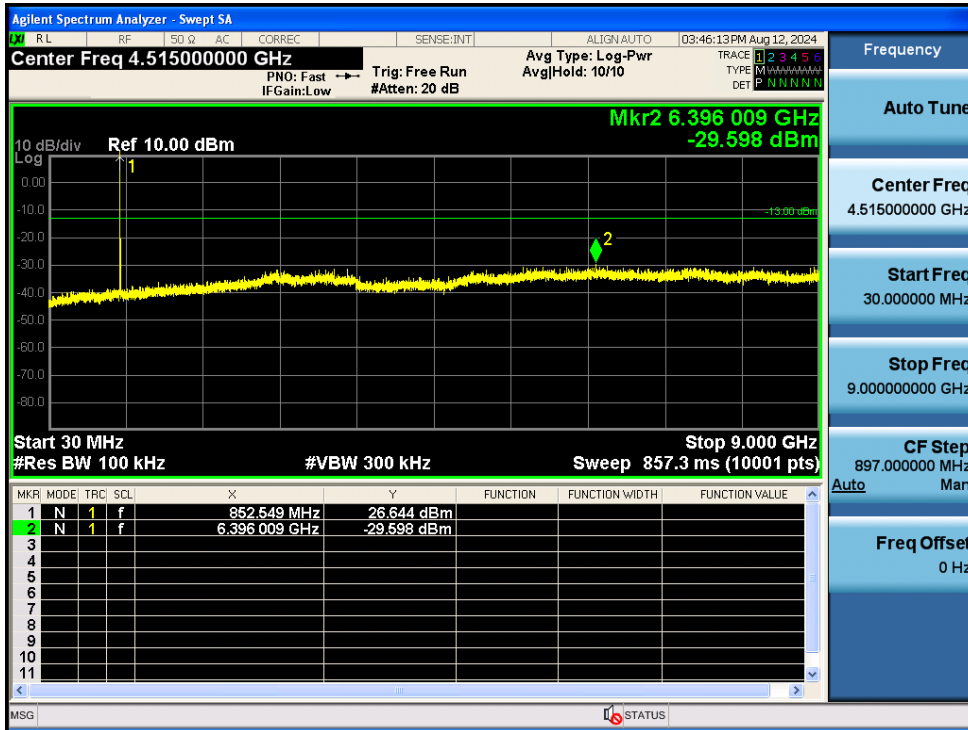

Spurious / B/ILT; SMR / Downlink / 1 Carrier

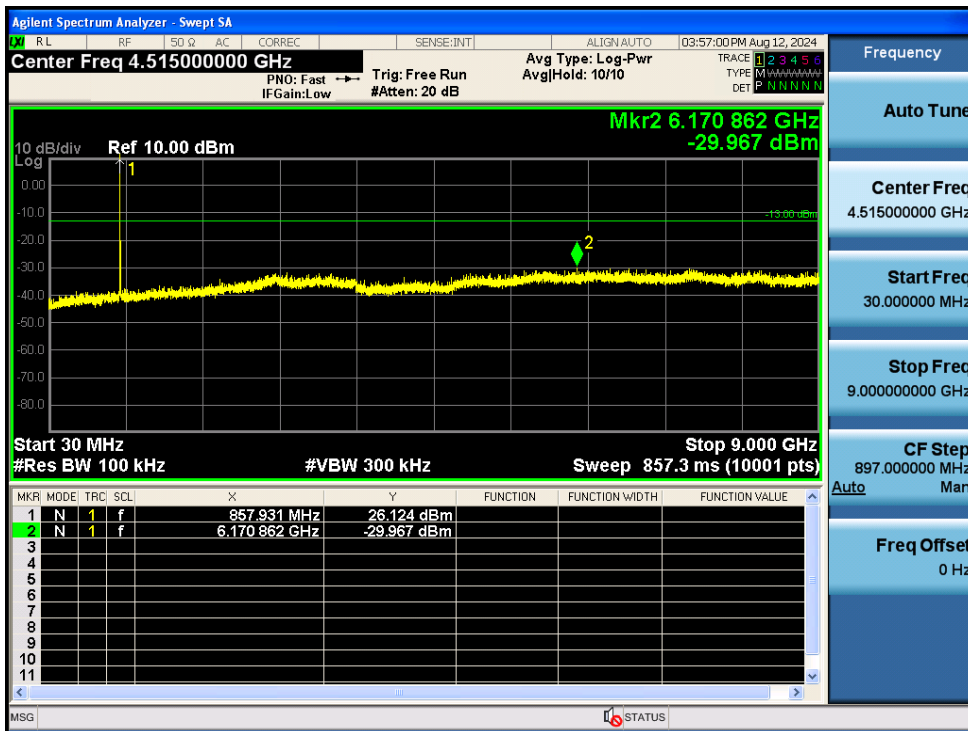

Spurious / ESMR / Downlink / 1 Carrier

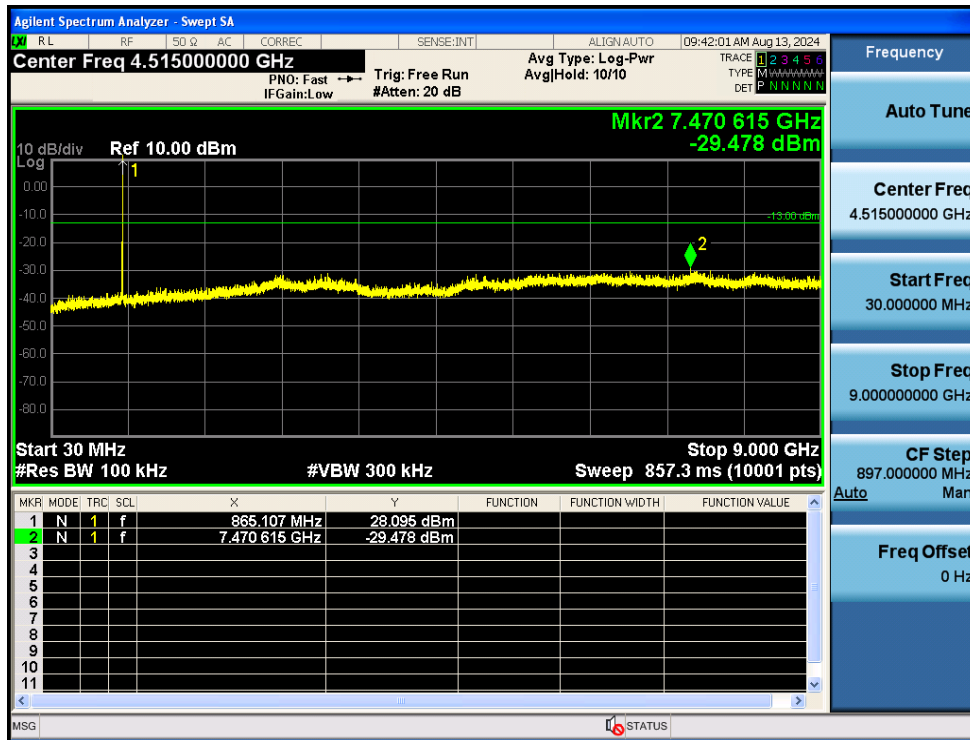

Simultaneous / Spurious / Public Safety Narrowband + NPSAC / Downlink

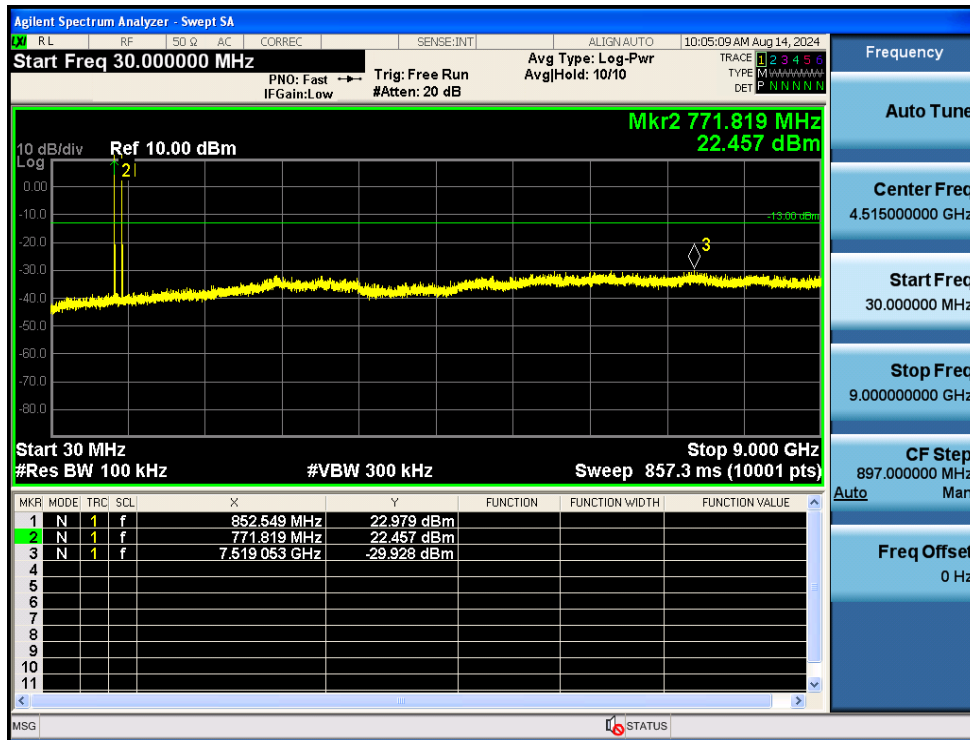

Note: Only the worst case plots for simultaneous spurious emissions.

Simultaneous / Spurious / Public Safety Narrowband + NPSAC / Downlink / 1 Carrier / Additional 1559 MHz ~ 1610 MHz

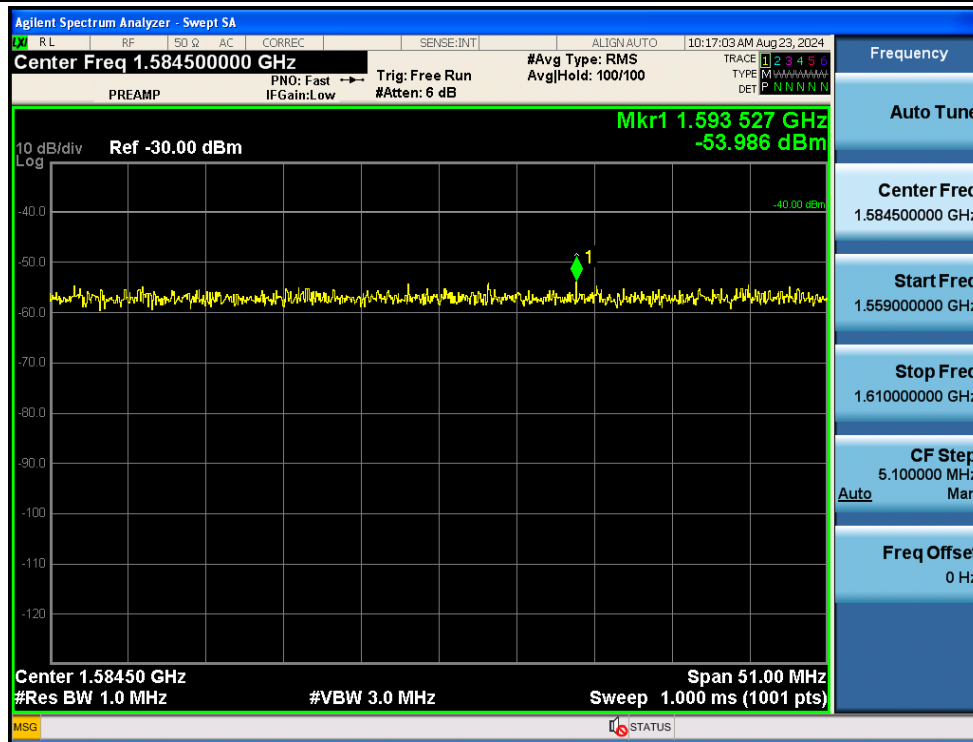

Measured Level + Ant. Gain = -53.986 dBm + 8 dBi = -45.986 dBm(E.I.R.P.) complies with the limit 90.543(f).

5.8. RADIATED SPURIOUS EMISSIONS

Test Requirements:

§ 2.1053 Measurements required: Field strength of spurious radiation.

- (a) Measurements shall be made to detect spurious emissions that may be radiated directly from the cabinet, control circuits, power leads, or intermediate circuit elements under normal conditions of installation and operation. Curves or equivalent data shall be supplied showing the magnitude of each harmonic and other spurious emission. For this test, single sideband, independent sideband, and controlled carrier transmitters shall be modulated under the conditions specified in paragraph (c) of § 2.1049, as appropriate. For equipment operating on frequencies below 890 MHz, an open field test is normally required, with the measuring instrument antenna located in the far-field at all test frequencies. In the event it is either impractical or impossible to make open field measurements (e.g. a broadcast transmitter installed in a building) measurements will be accepted of the equipment as installed. Such measurements must be accompanied by a description of the site where the measurements were made showing the location of any possible source of reflections which might distort the field strength measurements. Information submitted shall include the relative radiated power of each spurious emission with reference to the rated power output of the transmitter, assuming all emissions are radiated from halfwave dipole antennas.
- (b) The measurements specified in paragraph (a) of this section shall be made for the following equipment:
 - (1) Those in which the spurious emissions are required to be 60 dB or more below the mean power of the transmitter.
 - (2) All equipment operating on frequencies higher than 25 MHz.
 - (3) All equipment where the antenna is an integral part of, and attached directly to the transmitter.
 - (4) Other types of equipment as required, when deemed necessary by the Commission.

Test Procedures:

Because KDB 935210 D05 procedure does not provide this requirement, measurements were in accordance with the test methods section 5.5 of ANSI C63.26-2015

- a) Place the EUT in the center of the turntable. The EUT shall be configured to transmit into the standard non-radiating load (for measuring radiated spurious emissions), connected with cables of minimal length unless specified otherwise. If the EUT uses an adjustable antenna, the antenna shall be positioned to the length that produces the worst case emission at the fundamental operating frequency.
- b) Each emission under consideration shall be evaluated:
 - 1) Raise and lower the measurement antenna in accordance 5.5.2, as necessary to enable detection of the maximum emission amplitude relative to measurement antenna height.
 - 2) Rotate the EUT through 360° to determine the maximum emission level relative to the axial position.
 - 3) Return the turntable to the azimuth where the highest emission amplitude level was observed.
 - 4) Vary the measurement antenna height again through 1 m to 4 m again to find the height associated with the maximum emission amplitude.
 - 5) Record the measured emission amplitude level and frequency using the appropriate RBW.
- c) Repeat step b) for each emission frequency with the measurement antenna oriented in both the horizontal and vertical polarizations to determine the orientation that gives the maximum emissions amplitude.

Test Result(Uplink):

Mode	Frequency (MHz)	Measured Level (dBuV)	Ant. Factor (dB/m)	A.G.+C.L.+H.P.F. (dB)	Pol.	Measured Power (dBm)	Result (dBm/m)
------	-----------------	-----------------------	--------------------	-----------------------	------	----------------------	----------------

No Critical Peaks Found.

Test Result(Downlink):

Mode	Frequency (MHz)	Measured Level (dBuV)	Ant. Factor (dB/m)	A.G.+C.L.+H.P.F. (dB)	Pol.	Measured Power (dBm)	Result (dBm/m)
------	-----------------	-----------------------	--------------------	-----------------------	------	----------------------	----------------

No Critical Peaks Found.

C.L.: Cable Loss / A.G.: Amp. Gain / H.P.F.: High Pass Filter

Note:

1. We have done horizontal and vertical polarization in detecting antenna.
2. Measure distance = 3 m
3. The amplitude of the spurious domain emission attenuated by more than 20 dB over the permissible value was not recorded according to ANSI C63.26, clause 5.1.1., c).
4. Test data were only the worst case.
5. Among the data of simultaneous and single band emission conditions, the single emission condition is the worst.

Plot data of radiated spurious emissions

Uplink / ESMR / 1 Carrier

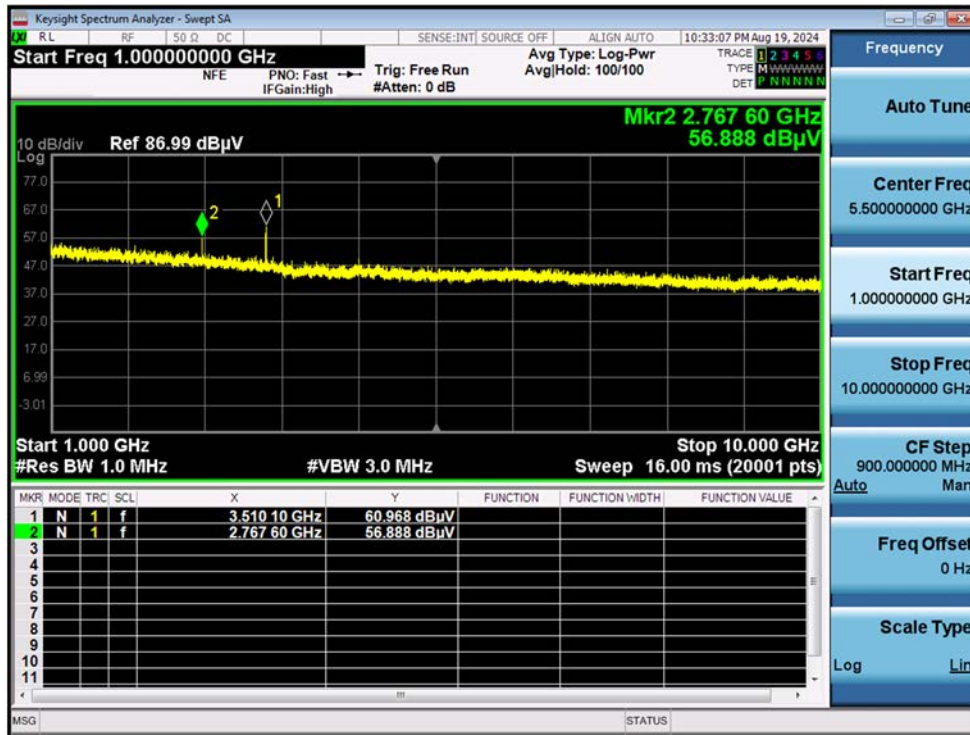

Downlink / ESMR / 1 Carrier

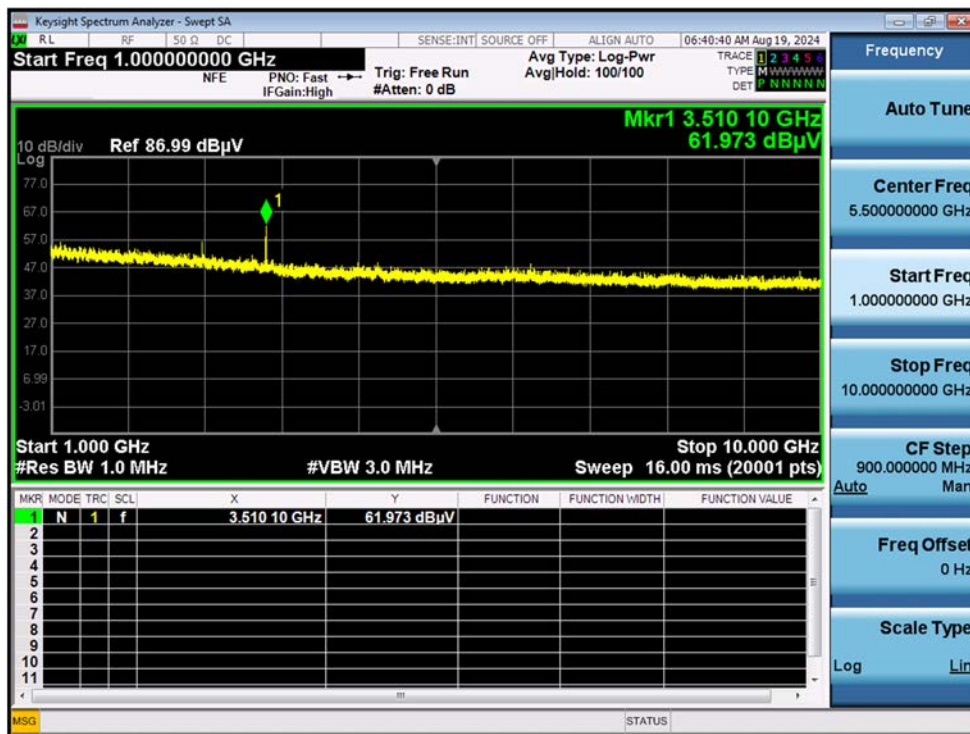

Note : Only the worst case plots for Radiated Spurious Emissions.

5.9. FREQUENCY STABILITY

Test Requirements:

§ 90.213 Frequency stability.

- (a) Unless noted elsewhere, transmitters used in the services governed by this part must have a minimum frequency stability as specified in the following table.

Table 1 to § 90.213(a)—Minimum Frequency Stability
[Parts per million (ppm)]

Frequency range (MHz)	Fixed and base stations	Mobile stations	
		Over 2 watts output power	2 watts or less output power
Below 25	100	100	200
25-50	20	20	50
72-76	5		50
150-174	5	5	50
216-220	1.0		1.0
220-222	0.1	1.5	1.5
421-512	2.5	5	5
806-809	1.0	1.5	1.5
809-824	1.5	2.5	2.5
851-854	1.0	1.5	1.5
854-869	1.5	2.5	2.5
896-901	0.1	1.5	1.5
902-928	2.5	2.5	2.5
902-928	2.5	2.5	2.5
929-930	1.5		
935-940	0.1	1.5	1.5
1427-1435	300	300	300
Above 2450			

Test Procedures:

The measurement is performed in accordance with Section 5.6.3, 5.6.4 and 5.6.5 of ANSI C63.26.

5.6.3 Procedure for frequency stability testing

Frequency stability is a measure of the frequency drift due to temperature and supply voltage variations, with reference to the frequency measured at +20 °C and rated supply voltage.

The operating carrier frequency shall be set up in accordance with the manufacturer’s published operation and instruction manual prior to the commencement of these tests. No adjustment of any frequency determining circuit element shall be made subsequent to this initial set-up. Frequency stability is tested:

- a) At 10 °C intervals of temperatures between –30 °C and +50 °C at the manufacturer’s rated supply voltage, and
- b) At +20 °C temperature and $\pm 15\%$ supply voltage variations. If a product is specified to operate over a range of input voltage then the –15% variation is applied to the lowermost voltage and the +15% is applied to the uppermost voltage.

During the test all necessary settings, adjustments and control of the EUT have to be performed without disturbing the test environment, i.e., without opening the environmental chamber. The frequency stabilities can be maintained to a lesser temperature range provided that the transmitter is automatically inhibited from operating outside the lesser temperature range. For handheld equipment that is only capable of operating from internal batteries and the supply voltage cannot be varied, the frequency stability tests shall be performed at the nominal battery voltage and the battery end point voltage specified by the manufacturer. An external supply voltage can be used and set at the internal battery nominal voltage, and again at the battery operating end point voltage which shall be specified by the equipment manufacturer.

If an unmodulated carrier is not available, the mean frequency of a modulated carrier can be obtained by using a frequency counter with gating time set to an appropriately large multiple of bit periods (gating time depending on the required accuracy). Full details on the choice of values shall be included in the test report.

5.6.4 Frequency stability over variations in temperature

- a) Supply the EUT with a nominal 60 Hz ac voltage, dc voltage, or install a new or fully charged battery in the EUT.
- b) If possible a dummy load should be connected to the EUT because an antenna near the metallic walls of an environmental test chamber could affect the output frequency of the EUT. If the EUT is equipped with a permanently attached, adjustable-length antenna, the EUT should be placed in the center of the chamber with the antenna adjusted to the shortest length possible.
- c) Turn on the EUT, and tune it to the center frequency of the operating band.
- d) Couple the transmitter output to the measuring instrument through a suitable attenuator and coaxial cable. If connection to the EUT output is not possible, make the measurement by connecting an antenna to the measuring instrument with a suitable length of coaxial cable and placing the measuring antenna near the EUT (e.g., 15 cm away).

NOTE—An instrument that has an adequate level of accuracy as specified by the procuring or regulatory authority is the recommended measuring instrument.

- e) Adjust the location of the measurement antenna and the controls on the measurement instrument to obtain a suitable signal level (i.e., a level that will not overload the measurement instrument, but is strong enough to allow measurement of the operating or fundamental frequency of the EUT). Adjust the detector bandwidth and span settings to achieve a resolution capable of accurate frequency measurements over the applicable frequency stability limits.
- f) Turn the EUT off, and place it inside the environmental temperature chamber. For devices that have oscillator heaters, energize only the heater circuit.
- g) Set the temperature control on the chamber to the Highest temperature specified in the regulatory requirements for the type of device, and allow the oscillator heater and the chamber temperature to stabilize. Unless otherwise instructed by the regulatory authority, this temperature should be 50 °C.
- h) While maintaining a constant temperature inside the environmental chamber, turn on the EUT and allow sufficient time for the EUT temperature to stabilize.
- i) Measure the frequency.
- j) Switch off the EUT, but do not switch off the oscillator heater.

- k) Lower the chamber temperature to the next level that is required by the standard and allow the temperature inside the chamber to stabilize. Unless otherwise instructed by the regulators, this temperature step should be 10 °C.
- l) Repeat step h) through step k) down to the lowest specified temperature. Unless otherwise instructed by the regulators, this temperature should be –30 °C. When the frequency stability limit is stated as being sufficient such that the fundamental emissions stay within the authorized bands of operation, a reference point shall be established at the applicable unwanted emissions limit using a RBW equal to the RBW required by the unwanted emissions specification of the applicable regulatory standard. These reference points measured using the lowest and Highest channel of operation shall be identified as f_L and f_H respectively. The worst-case frequency offset determined in the above methods shall be added or subtracted from the values of f_L and f_H and the resulting frequencies must remain within the band.
- m) Omitted

5.6.5 Frequency stability when varying supply voltage

- a) Couple the transmitter output to the measuring instrument through a suitable attenuator and coaxial cable. If connection to the EUT output is not possible make the measurement by connecting an antenna to the measuring instrument with a suitable length of coaxial cable and placing the measuring antenna near the EUT (e.g., 15 cm away)
- b) Supply the EUT with nominal ac or dc voltage. The supply voltage shall be measured at the input to the cable normally provided with the equipment, or at the power supply terminals if cables are not normally provided. Effects on frequency of transmitter keying (except for broadcast transmitters) and any heating element cycling at the nominal supply voltage and at each extreme also shall be shown.
- c) Turn on the EUT, and couple its output to a frequency counter or other frequency-measuring instrument.
- d) Tune the EUT to the center frequency of the operating band. Adjust the location of the measurement antenna and the controls on the measurement instrument to obtain a suitable signal level (i.e., a level that will not overload the measurement instrument, but is strong enough to allow measurement of the operating or fundamental frequency of the EUT). Adjust the detector bandwidth and span settings to achieve a resolution capable of accurate frequency measurements over the applicable frequency stability limits.
NOTE—An instrument that has an adequate level of accuracy as specified by the procuring or regulatory authority is the recommended measuring instrument.
- e) Measure the frequency.
- f) Unless otherwise specified, vary primary supply voltage from 85% to 115% of the nominal value for other than hand carried battery equipment.
- g) For hand carried, battery powered equipment, reduce the primary ac or dc supply voltage to the battery operating end point, which shall be specified by the manufacturer.
- h) Repeat the frequency measurement.
NOTE—For band-edge compliance, it can be required to make these measurements at the low and High channel of the operating band.

Note: The results of the frequency stability test shown above the frequency deviation measured values are very small and similar trend for each port, so we are attached only the worst case data.

Test Results(Uplink):

Public Safety Narrowband

Reference: 200 VAC at 20°C Freq. = 802,000,000 Hz

Voltage (%)	Temp. (°C)	Frequency (Hz)	Frequency Error (Hz)	Deviation (Hz)	ppm
100 %	+20(Ref)	802 000 004	4.384	0.000	0.00000
	-30	802 000 006	1.262	-3.122	-0.00389
	-20	802 000 012	7.527	3.143	0.00392
	-10	802 000 010	5.768	1.384	0.00173
	0	802 000 013	8.396	4.012	0.00500
	+10	802 000 008	3.229	-1.155	-0.00144
	+30	802 000 005	0.541	-3.843	-0.00479
	+40	802 000 014	9.759	5.375	0.00670
	+50	802 000 008	3.246	-1.138	-0.00142
115 %	+20	802 000 010	5.917	1.533	0.00191
85 %	+20	802 000 006	1.320	-3.064	-0.00382

NPSPAC

Reference: 200 VAC at 20°C Freq. = 807,500,000 Hz

Voltage (%)	Temp. (°C)	Frequency (Hz)	Frequency Error (Hz)	Deviation (Hz)	ppm
100 %	+20(Ref)	807 500 010	9.579	0.000	0.00000
	-30	807 500 011	1.862	-7.717	-0.00956
	-20	807 500 016	6.887	-2.692	-0.00333
	-10	807 500 020	9.928	0.349	0.00043
	0	807 500 014	4.706	-4.873	-0.00603
	+10	807 500 016	6.718	-2.862	-0.00354
	+30	807 500 014	4.501	-5.078	-0.00629
	+40	807 500 011	1.417	-8.162	-0.01011
	+50	807 500 019	9.793	0.214	0.00027
115 %	+20	807 500 015	5.325	-4.254	-0.00527
85 %	+20	807 500 019	9.913	0.334	0.00041

B/ILT; SMR		Reference: 200 VAC at 20°C Freq. = 812,500,000 Hz			
Voltage (%)	Temp. (°C)	Frequency (Hz)	Frequency Error (Hz)	Deviation (Hz)	ppm
100 %	+20(Ref)	812 500 000	0.490	0.000	0.00000
	-30	812 500 001	0.346	-0.144	-0.00018
	-20	812 500 008	7.118	6.628	0.00816
	-10	812 500 005	4.160	3.670	0.00452
	0	812 500 010	9.648	9.158	0.01127
	+10	812 500 009	8.494	8.004	0.00985
	+30	812 500 003	2.080	1.590	0.00196
	+40	812 500 003	2.629	2.139	0.00263
	+50	812 500 002	1.015	0.525	0.00065
115 %	+20	812 500 004	3.507	3.017	0.00371
85 %	+20	812 500 010	9.339	8.849	0.01089

ESMR		Reference: 200 VAC at 20°C Freq. = 820,500,000 Hz			
Voltage (%)	Temp. (°C)	Frequency (Hz)	Frequency Error (Hz)	Deviation (Hz)	ppm
100 %	+20(Ref)	820 500 010	9.969	0.000	0.00000
	-30	820 500 016	5.551	-4.418	-0.00538
	-20	820 500 017	7.018	-2.951	-0.00360
	-10	820 500 018	8.092	-1.877	-0.00229
	0	820 500 013	2.741	-7.228	-0.00881
	+10	820 500 015	4.729	-5.240	-0.00639
	+30	820 500 016	6.293	-3.676	-0.00448
	+40	820 500 017	7.502	-2.467	-0.00301
	+50	820 500 013	3.382	-6.587	-0.00803
115 %	+20	820 500 018	8.213	-1.756	-0.00214
85 %	+20	820 500 016	6.308	-3.661	-0.00446

Test Results(Downlink):

Public Safety Narrowband

Reference: 200 VAC at 20°C Freq. = 772,000,000 Hz

Voltage (%)	Temp. (°C)	Frequency (Hz)	Frequency Error (Hz)	Deviation (Hz)	ppm
100 %	+20(Ref)	772 000 001	0.606	0.000	0.00000
	-30	772 000 002	1.891	1.286	0.00167
	-20	772 000 002	1.764	1.158	0.00150
	-10	772 000 010	9.477	8.871	0.01149
	0	772 000 009	8.861	8.255	0.01069
	+10	772 000 007	6.579	5.973	0.00774
	+30	772 000 007	6.800	6.194	0.00802
	+40	772 000 008	6.985	6.380	0.00826
	+50	772 000 008	7.104	6.498	0.00842
115 %	+20	772 000 003	2.292	1.686	0.00218
85 %	+20	772 000 008	7.214	6.608	0.00856

NPSPAC

Reference: 200 VAC at 20°C Freq. = 852,500,000 Hz

Voltage (%)	Temp. (°C)	Frequency (Hz)	Frequency Error (Hz)	Deviation (Hz)	ppm
100 %	+20(Ref)	852 500 004	3.737	0.000	0.00000
	-30	852 500 014	9.805	6.067	0.00712
	-20	852 500 008	4.754	1.017	0.00119
	-10	852 500 010	6.185	2.448	0.00287
	0	852 500 007	3.499	-0.239	-0.00028
	+10	852 500 011	7.275	3.538	0.00415
	+30	852 500 011	7.279	3.541	0.00415
	+40	852 500 004	0.049	-3.688	-0.00433
	+50	852 500 006	1.763	-1.974	-0.00232
115 %	+20	852 500 006	2.227	-1.510	-0.00177
85 %	+20	852 500 005	1.051	-2.687	-0.00315

B/ILT; SMR		Reference: 200 VAC at 20°C Freq. = 857,500,000 Hz			
Voltage (%)	Temp. (°C)	Frequency (Hz)	Frequency Error (Hz)	Deviation (Hz)	ppm
100 %	+20(Ref)	857 500 007	7.471	0.000	0.00000
	-30	857 500 011	3.927	-3.543	-0.00413
	-20	857 500 008	0.159	-7.312	-0.00853
	-10	857 500 009	1.461	-6.009	-0.00701
	0	857 500 016	8.325	0.855	0.00100
	+10	857 500 016	8.154	0.683	0.00080
	+30	857 500 011	3.360	-4.110	-0.00479
	+40	857 500 015	7.995	0.525	0.00061
	+50	857 500 011	3.786	-3.685	-0.00430
115 %	+20	857 500 012	4.891	-2.580	-0.00301
85 %	+20	857 500 015	7.974	0.503	0.00059

ESMR		Reference: 200 VAC at 20°C Freq. = 865,500,000 Hz			
Voltage (%)	Temp. (°C)	Frequency (Hz)	Frequency Error (Hz)	Deviation (Hz)	ppm
100 %	+20(Ref)	865 500 008	8.043	0.000	0.00000
	-30	865 500 016	7.662	-0.380	-0.00044
	-20	865 500 014	6.173	-1.870	-0.00216
	-10	865 500 009	1.058	-6.985	-0.00807
	0	865 500 009	0.516	-7.527	-0.00870
	+10	865 500 013	5.108	-2.935	-0.00339
	+30	865 500 009	1.133	-6.910	-0.00798
	+40	865 500 015	6.470	-1.573	-0.00182
	+50	865 500 015	6.896	-1.147	-0.00133
115 %	+20	865 500 013	5.056	-2.987	-0.00345
85 %	+20	865 500 017	8.778	0.735	0.00085

6. Annex A_EUT AND TEST SETUP PHOTO

Please refer to test setup photo file no. as follows;

No.	Description
1	HCT-RF-2408-FC018-P