

# 承 認 書

## SPECIFICATION FOR APPROVAL

客戶名稱  
CUSTOMER : \_\_\_\_\_

客戶料號  
CUSTOMER'S P/N : \_\_\_\_\_

料號  
PART NUMBER : WAN5020D245W36

規格  
DESCRIPTION : Chip Antenna 5020 M-Ant 2.45G Type 36

版本  
VERSION : V1.9

日期  
ISSUE DATE : 2023/06/14

客戶承認 CUSTOMER APPROVED		

工 程 部 R&D CENTER		
承 認 APPROVAL	確 認 CHECKED	製 作 DRAWN
Ray	Tennyson	Snow



萬誠科技股份有限公司

112 台北市北投區立功街 151 號 1 樓

電話: (02) 2898-2220  
傳真: (02) 2898-5055

OneWave Electronic Co., Ltd.

1F, No. 151, Li Gong Street, Beitou District,  
Taipei City 112, Taiwan

TEL: +886 2 2898-2220  
FAX: +886 2 2898-5055

# 5020 Chip antenna

For Bluetooth / WLAN Applications

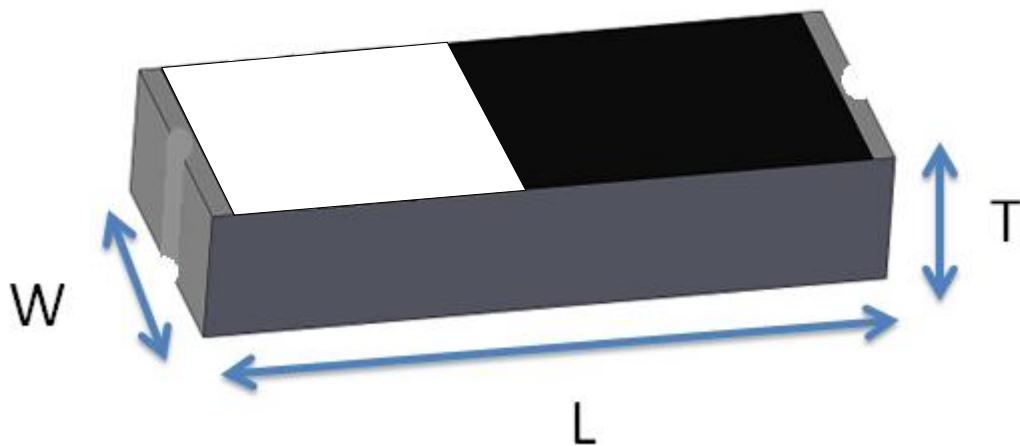

P/N: WAN5020D245W36

OneWave

	Dimension (mm)
L	5.02 ± 0.20
W	2.12 ± 0.20
T	1.03 ± 0.20

## Part Number Information

WAN   5020   D   245   W   36  
 A            B            C            D            E            F

A	Product Series	Antenna
B	Dimension L x W	5.0X2.0mm (+-0.2mm)
C	Material	High K material
D	Working Frequency	2.4 ~ 2.5GHz
E	Feeding mode	Monopole & Single Feeding
F	Antenna type	Type = 36

## 1. Electrical Specification

Specification		
Part Number	WAN5020D245W36	
Central Frequency	2450	MHz
Bandwidth	100 (Min.)	MHz
Return Loss	-10 (Max)	dB
Peak Gain	3.49	dBi
Impedance	50	Ohm
Operating Temperature	-40~+110	°C
Maximum Power	4	W
Resistance to Soldering Heats	10 ( @ 260°C )	sec.
Polarization	Linear	
Azimuth Beamwidth	Omni-directional	
Termination	Cu / Sn (Leadless)	

Remark : Bandwidth & Peak Gain was measured under evaluation board of next page

## 2.Recommended PCB Pattern

### Evaluation Board Dimension

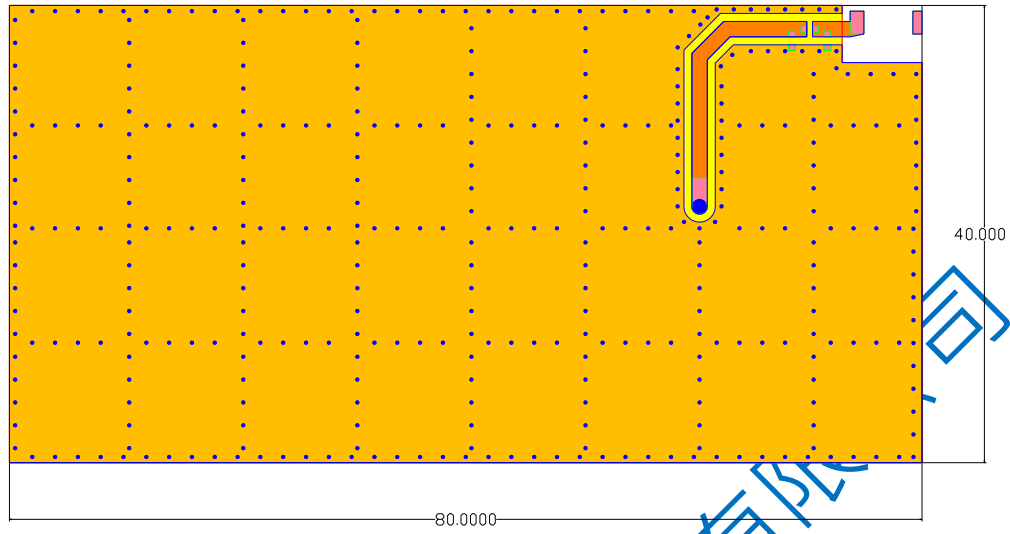

Unit : mm

Feed Line
  TOP Copper
  VIA

### Suggested Matching Circuit

重要資訊：

匹配元件建議使用精準度高的電感 $\pm 0.1 \sim 0.3 \text{ nH}$ 、電容 $\pm 0.1 \text{ pF}$

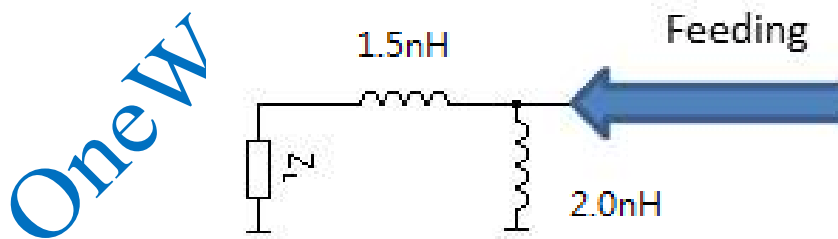

**Layout Dimensions in Clearance area (Size=7.0\*5.0mm)**

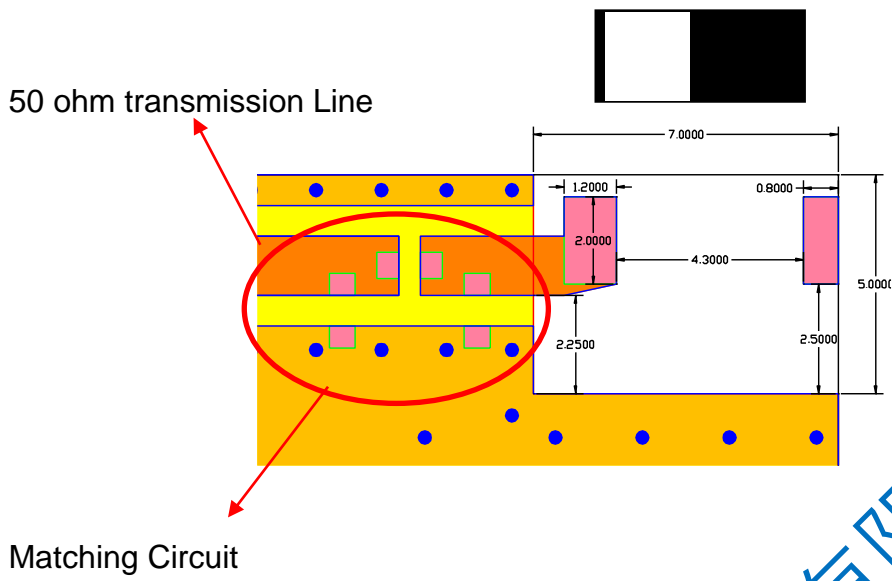

**FootPrint (Unit : mm)**

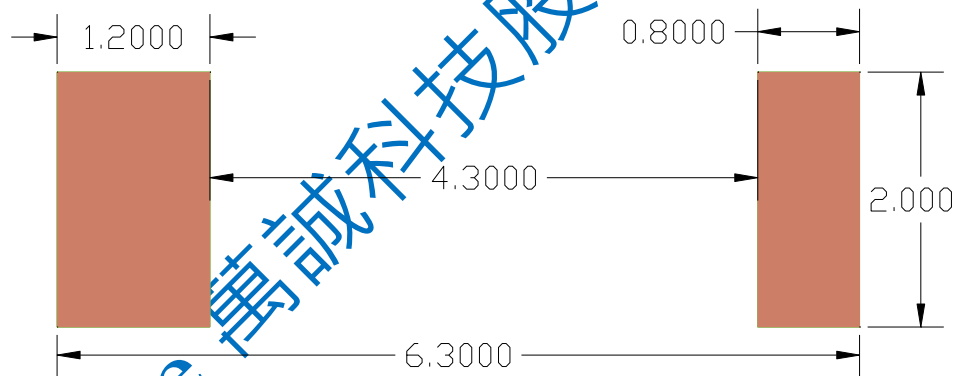

OneWave 傳誠科技股份有限公司

### 3.Measurement Results

Return Loss

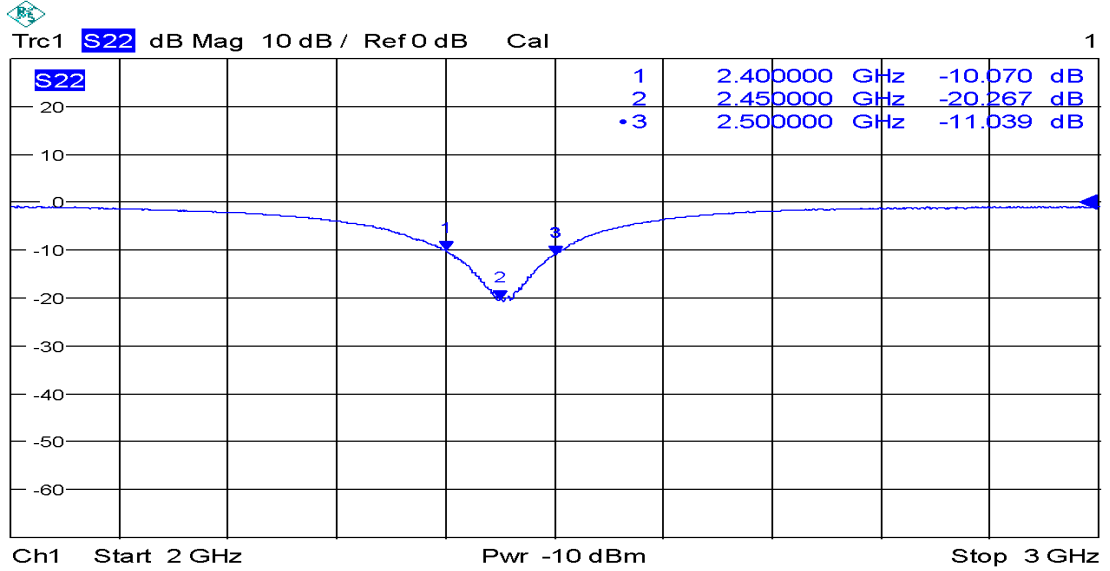

OneWave 萬誠科技

Radiation Pattern

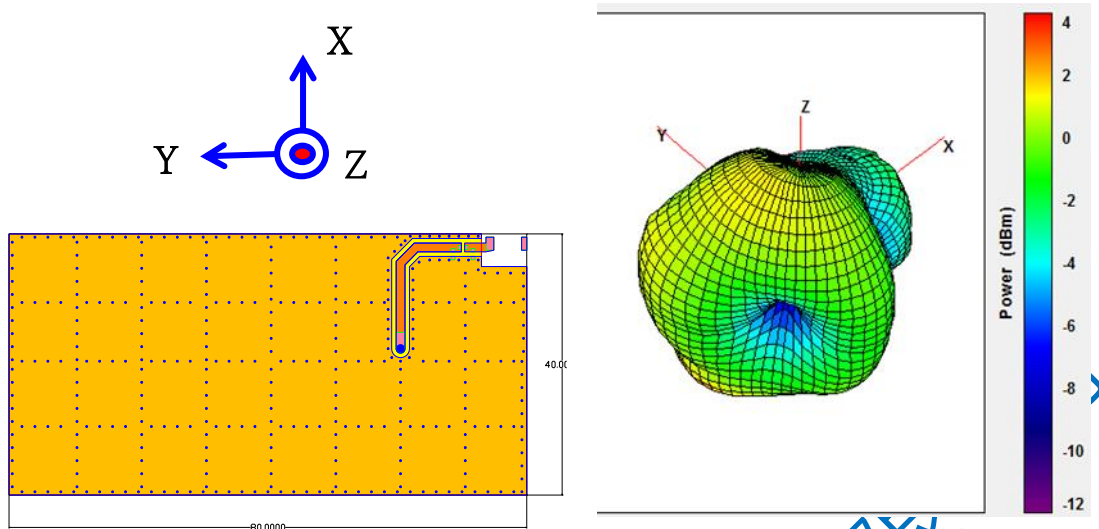

	Efficiency	Peak Gain	Directivity
2400MHz	70.77 %	2.92 dBi	4.42 dBi
2450MHz	81.12 %	3.49 dBi	4.39 dBi
2500MHz	72.18 %	2.94 dBi	4.35 dBi

Chamber Coordinate System

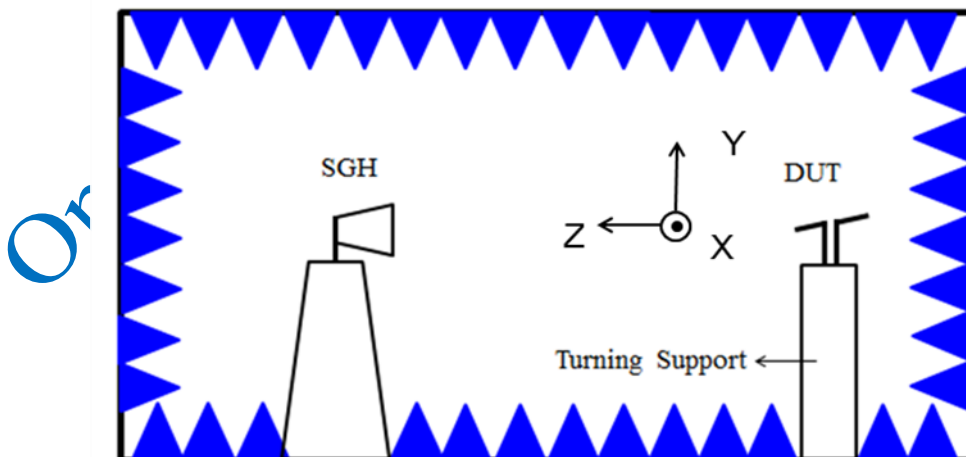

## 4. Reliability and Test Conditions

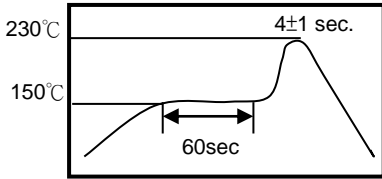
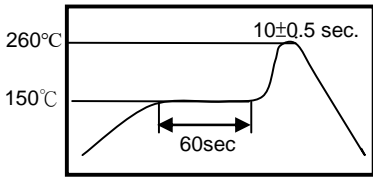
ITEM	REQUIREMENTS	TEST CONDITION															
Solderability	1. Wetting shall exceed 90% coverage 2. No visible mechanical damage TEMP (°C) 	Pre-heating temperature: 150°C/60sec. Solder temperature: 230±5°C Duration: 4±1sec. Solder: Sn-Ag3.0-Cu0.5 Flux for lead free: rosin															
Solder heat Resistance	1. No visible mechanical damage 2. Central Freq. change :within ±6% TEMP (°C) 	Pre-heating temperature: 150°C/60sec. Solder temperature: 260±5°C Duration: 10±0.5sec. Solder: Sn-Ag3.0-Cu0.5 Flux for lead free: rosin															
Component Adhesion (Push test)	1. No visible mechanical damage	The device should be reflow soldered (230±5°C for 10sec.) to a tinned copper substrate. A dynamometer force gauge should be applied the side of the component. The device must with-ST-F 0.5 Kg without failure of the termination attached to component.															
Component Adhesion (Pull test)	1. No visible mechanical damage	Insert 10cm wire into the remaining open eye bend, the ends of even wire lengths upward and wind together. Terminal shall not be remarkably damaged.															
Thermal shock	1. No visible mechanical damage 2. Central Freq. change :within ±6% <table border="1" data-bbox="386 1258 826 1505"> <thead> <tr> <th>Phase</th> <th>Temperature(°C)</th> <th>Time(min)</th> </tr> </thead> <tbody> <tr> <td>1</td> <td>+110±5°C</td> <td>30±3</td> </tr> <tr> <td>2</td> <td>Room Temperature</td> <td>Within 3sec</td> </tr> <tr> <td>3</td> <td>-40±2°C</td> <td>30±3</td> </tr> <tr> <td>4</td> <td>Room Temperature</td> <td>Within 3sec</td> </tr> </tbody> </table>	Phase	Temperature(°C)	Time(min)	1	+110±5°C	30±3	2	Room Temperature	Within 3sec	3	-40±2°C	30±3	4	Room Temperature	Within 3sec	+110°C => 30±3min -40°C => 30±3min Test cycle: 10 cycles The chip shall be stabilized at normal condition for 2~3 hours before measuring.
Phase	Temperature(°C)	Time(min)															
1	+110±5°C	30±3															
2	Room Temperature	Within 3sec															
3	-40±2°C	30±3															
4	Room Temperature	Within 3sec															
Resistance to High Temperature	1. No visible mechanical damage 2. Central Freq. change :within ±6% 3. No disconnection or short circuit.	Temperature: +110±5°C Duration: 1000±12hrs The chip shall be stabilized at normal condition for 2~3 hours before measuring.															
Resistance to Low Temperature	1. No visible mechanical damage 2. Central Freq. change :within ±6% 3. No disconnection or short circuit.	Temperature: -40±5°C Duration: 1000±12hrs The chip shall be stabilized at normal condition for 2~3 hours before measuring.															
Humidity	1. No visible mechanical damage 2. Central Freq. change :within ±6% 3. No disconnection or short circuit.	Temperature: 40±2°C Humidity: 90% to 95% RH Duration: 1000±12hrs The chip shall be stabilized at normal condition for 2~3 hours before measuring.															



## 5.Soldering and Mounting

Mildly activated rosin fluxes are preferred. The minimum amount of solder can lead to damage from the stresses caused by the difference in coefficients of expansion between solder, chip and substrate. The terminations are suitable for all wave and re-flow soldering systems. If hand soldering cannot be avoided, the preferred technique is the utilization of hot air soldering tools.

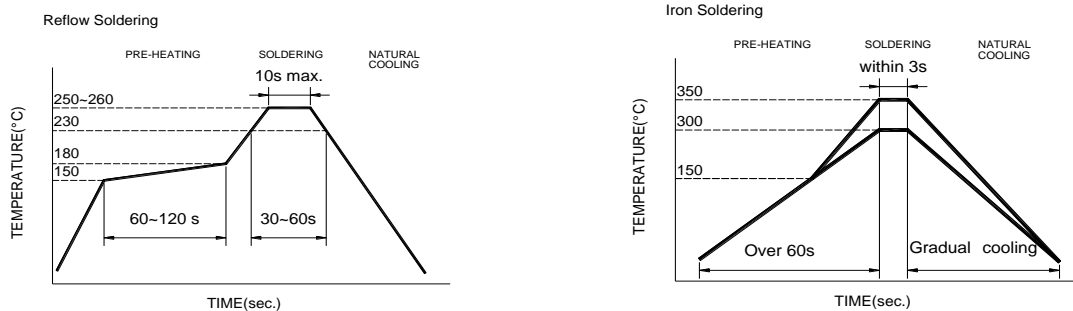

Recommended temperature profiles for re-flow soldering in Figure 1.

Products attachment with a soldering iron is discouraged due to the inherent process control limitations. In the event that a soldering iron must be employed the following precautions are recommended.

- Preheat circuit and products to 150°C
- Never contact the ceramic with the iron tip
- Use a 20 watt soldering iron with tip diameter of 1.0mm
- 280°C tip temperature (max)
- 1.0mm tip diameter (max)
- Limit soldering time to 3 sec.

## 6.Packaging Information

### ◆ Tape Specification:

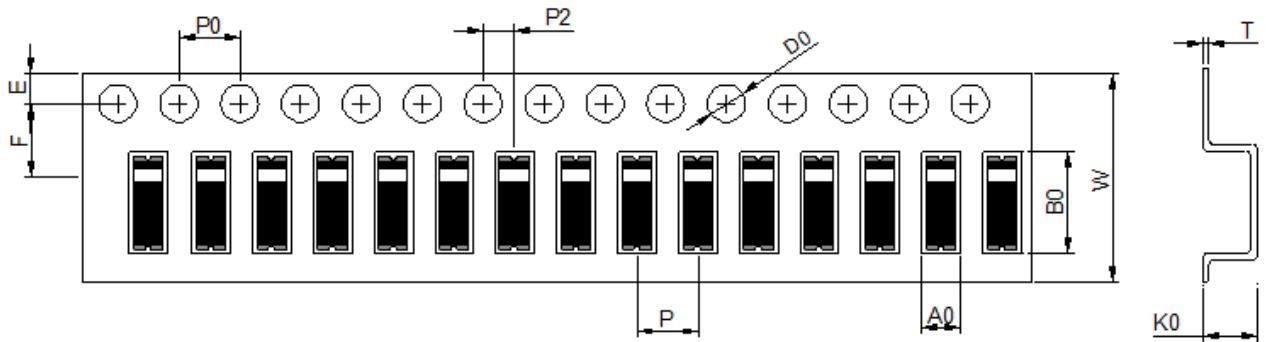

W	Ao	Bo	Ko	P	F	E	D	D1	Po	P2	t
12.0	2.28	5.70	1.58	4.00	5.50	1.75	1.50	0.50	4.00	2.00	0.25
±0.30	±0.10	±0.10	±0.10	±0.10	±0.10	±0.10	±0.10	±0.10	±0.10	±0.10	±0.05

### ◆ Reel Specification: (7", Φ180 mm)

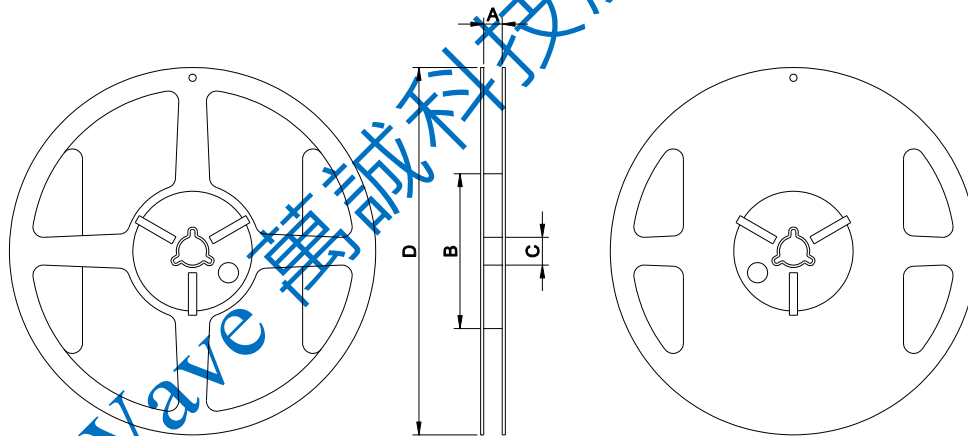

7" x 12 mm

Tape Width(mm)	A(mm)	B(mm)	C(mm)	D(mm)	Chip/Reel(pcs)
12	12±1.0	60±2	13.5±0.5	178±2	3000

## 7.Storage and Transportation Information

### Storage Conditions

To maintain the solderability of terminal electrodes:

1. Temperature and humidity conditions: -10~ 40°C and 30~70% RH.
2. Recommended products should be used within 6 months from the time of delivery.
3. The packaging material should be kept where no chlorine or sulfur exists in the air.

### Transportation Conditions

1. Products should be handled with care to avoid damage or contamination from perspiration and skin oils.
2. The use of tweezers or vacuum pick up is strongly recommended for individual components.
3. Bulk handling should ensure that abrasion and mechanical shock are minimized.

OneWave 萬誠科技股份有限公司