



Shenzhen CTA Testing Technology Co., Ltd.

Room 106, Building 1, Yibaolai Industrial Park, Qiaotou Community, Fuhai Street, Bao'an District, Shenzhen, China

TEST REPORT

Report Reference No. : CTA24091002701

FCC ID : 2BK53-OMIM9

Compiled by

(position+printed name+signature)..: File administrators Jinghua Xiao

Supervised by

(position+printed name+signature)..: Project Engineer Xudong Zhang



Approved by

(position+printed name+signature)..: RF Manager Eric Wang

Date of issue : Sep. 20, 2024

Testing Laboratory Name : Shenzhen CTA Testing Technology Co., Ltd.

Address : Room 106, Building 1, Yibaolai Industrial Park, Qiaotou Community, Fuhai Street, Bao'an District, Shenzhen, China

Applicant's name : Fujian Oumi Network Technology Co., Ltd

Address : Room A801, 8th Floor, Building A, Modern Meiju Plaza, East Section of Quanxiu Road, Fengze District, Quanzhou City, China

Test specification :

Standard : FCC 47CFR §2.1093; ANSI/IEEE C95.1-1992; IEEE 1528-2013; KDB 941225 D05; KDB 941225 D06; KDB 648474 D04; KDB 447498 D01; KDB 865664 D01; KDB 865664 D02; KDB 690783 D01; KDB 643646 D01

Shenzhen CTA Testing Technology Co., Ltd. All rights reserved.

This publication may be reproduced in whole or in part for non-commercial purposes as long as the Shenzhen CTA Testing Technology Co., Ltd. is acknowledged as copyright owner and source of the material. Shenzhen CTA Testing Technology Co., Ltd. takes no responsibility for and will not assume liability for damages resulting from the reader's interpretation of the reproduced material due to its placement and context.

Test item description : OMI public network intercom

Trade Mark : OMI

Manufacturer : Fujian Oumi Network Technology Co., Ltd

Model/Type reference : OMI-M9

Listed Models : N/A

Rating : DC 3.7V From Battery and DC 5.0V From external circuit

Result : PASS

TEST REPORT

Equipment under Test : OMI public network intercom

Model /Type : OMI-M9

Listed Models : N/A

Applicant : **Fujian Oumi Network Technology Co., Ltd**

Address : Room A801, 8th Floor, Building A, Modern Meiju Plaza, East Section of Quianxiu Road, Fengze District, Quanzhou City, China

Manufacturer : **Fujian Oumi Network Technology Co., Ltd**

Address : Room A801, 8th Floor, Building A, Modern Meiju Plaza, East Section of Quianxiu Road, Fengze District, Quanzhou City, China

Factory : **Fujian Oumi Network Technology Co., Ltd**

Address : Room A801, 8th Floor, Building A, Modern Meiju Plaza, East Section of Quianxiu Road, Fengze District, Quanzhou City, China

Test Result:	PASS
---------------------	-------------

The test report merely corresponds to the test sample.

It is not permitted to copy extracts of these test result without the written permission of the test laboratory.

※ ※ Revision History ※ ※

REV.	ISSUED DATE	DESCRIPTION
Rev.1.0	Sep. 20, 2024	Initial Test Report Release

Contents

1	Statement of Compliance	5
2	General Information.....	6
2.1	General Remarks	6
2.2	Description of Equipment Under Test (EUT).....	6
2.3	Device Category and SAR Limits	7
2.4	Applied Standard	7
2.5	Test Facility.....	7
2.6	Environment of Test Site.....	8
2.7	Test Configuration.....	8
3	Specific Absorption Rate (SAR)	9
3.1	Introduction.....	9
3.2	SAR Definition	9
4	SAR Measurement System	10
4.1	E-Field Probe.....	10
4.2	Data Acquisition Electronics (DAE).....	11
4.3	Robot.....	12
4.4	Measurement Server	12
4.5	Phantom	13
4.6	Device Holder.....	13
4.7	Data Storage and Evaluation.....	14
5	Test Equipment List.....	16
6	Tissue Simulating Liquids.....	17
7	System Verification Procedures	19
8	EUT Testing Position.....	21
8.1	The measurement procedures are as follows:.....	21
9	Measurement Procedures	22
9.1	Spatial Peak SAR Evaluation	22
9.2	Power Reference Measurement	22
9.3	Area Scan Procedures	23
9.4	Zoom Scan Procedures.....	23
9.5	Volume Scan Procedures	24
9.6	Power Drift Monitoring.....	24
10	TEST CONDITIONS AND RESULTS.....	25
10.1	Conducted Power Results	25
10.2	Transmit Antennas(Front View)	58
10.3	SAR Test Results.....	59
Appendix A.	EUT Photos and Test Setup Photos.....	62
Appendix B.	Plots of SAR System Check	63
Appendix C.	Plots of SAR Test Data.....	67
Appendix D.	DASY System Calibration Certificate.....	79

1 Statement of Compliance

<Highest SAR Summary>

This device is in compliance with Specific Absorption Rate (SAR) for general population/uncontrolled exposure limits (1.6 W/kg) specified in FCC 47 CFR part 2 (2.1093) and ANSI/IEEE C95.1-2005, and had been tested in accordance with the measurement methods and procedures specified in IEEE 1528-2013. The maximum results of Specific Absorption Rate (SAR) found during testing are as follows.

<Highest SAR Summary>

Frequency Band	Highest Reported 1g-SAR(W/Kg)	Highest Reported 1g-SAR(W/Kg)
	Front of face (25mm)	Body-worn (0mm)
LTE Band 2	0.131	0.564
LTE Band 4	0.140	0.565
LTE Band 5	0.062	0.342
LTE Band 7	0.399	0.798
LTE Band 38	0.330	0.755
LTE Band 41	0.442	0.799
Simultaneous Reported SAR (W/Kg)	N/A	N/A
SAR Test Limit (W/Kg)	1.60	
Test Result	PASS	

2 General Information

2.1 General Remarks

Date of receipt of test sample	:	Aug. 20, 2024
Testing commenced on	:	Aug. 20, 2024
Testing concluded on	:	Aug. 27, 2024

2.2 Description of Equipment Under Test (EUT)

Product Name:	OMI public network intercom
Model/Type reference:	OMI-M9
Power supply:	DC 3.7V From Battery and DC 5.0V From external circuit
Testing sample ID:	CTA240910027-1# (Engineer sample) CTA240910027-2# (Normal sample)
Hardware version:	V0.1A
Software version:	V008_1.011.069
LTE	
Operation Band:	<input checked="" type="checkbox"/> E-UTRA Band 2(U.S.-Band) <input checked="" type="checkbox"/> E-UTRA Band 4(U.S.-Band) <input checked="" type="checkbox"/> E-UTRA Band 5(U.S.-Band) <input checked="" type="checkbox"/> E-UTRA Band 7(U.S.-Band) <input checked="" type="checkbox"/> E-UTRA Band 38(U.S.-Band) <input checked="" type="checkbox"/> E-UTRA Band 41(U.S.-Band)
Release Version:	Release 9
Category:	Cat 4
Modulation Type:	QPSK, 16QAM
Antenna Description:	PIFA antenna 1.75dBi(max.) For E-UTRA Band 2 1.72dBi(max.) For E-UTRA Band 4 1.2dBi(max.) For E-UTRA Band 5 1.94dBi(max.) For E-UTRA Band 7 1.7dBi(max.) For E-UTRA Band 38 1.96dBi(max.) For E-UTRA Band 41
Category of device:	Portable device
Remark: The above DUT's information was declared by manufacturer. Please refer to the specifications or user's manual for more detailed description.	

2.3 Device Category and SAR Limits

This device belongs to portable device category because its radiating structure is allowed to be used within 20 centimeters of the body of the user. Limit for General Population/Uncontrolled exposure should be applied for this device, it is 1.6 W/kg as averaged over any 1 gram of tissue.

2.4 Applied Standard

The Specific Absorption Rate (SAR) testing specification, method, and procedure for this device is in accordance with the following standards:

FCC 47CFR §2.1093	Radiofrequency Radiation Exposure Evaluation: Portable Devices
ANSI/IEEE C95.1-1992	IEEE Standard for Safety Levels with Respect to Human Exposure to Radio Frequency Electromagnetic Fields, 3 kHz – 300 GHz.
IEEE 1528-2013	Recommended Practice for Determining the Peak Spatial-Average Specific Absorption Rate (SAR) in the Human Head from Wireless Communications Devices: Measurement Techniques
KDB 941225 D05	SAR for LTE Devices v02r05
KDB 941225 D06	Hotspot Mode SAR v02r01
KDB 648474 D04	Handset SAR v01r03
KDB 447498 D01	General RF Exposure Guidance v06
KDB 865664 D01	SAR Measurement 100 MHz to 6 GHz v01r04
KDB 865664 D02	RF Exposure Reporting v01r02
KDB 690783 D01	SAR Listings on Grants v01r03
KDB 643646 D01	SAR Test for PTT Radios v01r03

2.5 Test Facility

FCC-Registration No.: 517856 Designation Number: CN1318

Shenzhen CTA Testing Technology Co., Ltd. has been listed on the US Federal Communications Commission list of test facilities recognized to perform electromagnetic emissions measurements.

A2LA-Lab Cert. No.: 6534.01

Shenzhen CTA Testing Technology Co., Ltd. has been listed by American Association for Laboratory Accreditation to perform electromagnetic emission measurement.

ISED#: 27890 CAB identifier: CN0127

Shenzhen CTA Testing Technology Co., Ltd. has been listed by Innovation, Science and Economic Development Canada to perform electromagnetic emission measurement.

The 3m-Semi anechoic test site fulfils CISPR 16-1-4 according to ANSI C63.10 and CISPR 16-1-4:2010.

2.6 Environment of Test Site

Items	Required	Actual
Temperature (°C)	18-25	22~23
Humidity (%RH)	30-70	55~65

2.7 Test Configuration

The device was controlled by using a base station emulator. Communication between the device and the emulator was established by air link. The distance between the EUT and the antenna of the emulator is larger than 50 cm and the output power radiated from the emulator antenna is at least 30 dB smaller than the output power of EUT. The EUT was set from the emulator to radiate maximum output power during all tests. For WLAN SAR testing, WLAN engineering testing software installed on the EUT can provide continuous transmitting RF signal.

3 Specific Absorption Rate (SAR)

3.1 Introduction

SAR is related to the rate at which energy is absorbed per unit mass in an object exposed to a radio field. The SAR distribution in a biological body is complicated and is usually carried out by experimental techniques or numerical modeling. The standard recommends limits for two tiers of groups, occupational/controlled and general population/uncontrolled, based on a person's awareness and ability to exercise control over his or her exposure. In general, occupational/controlled exposure limits are higher than the limits for general population/uncontrolled.

3.2 SAR Definition

The SAR definition is the time derivative (rate) of the incremental energy (dW) absorbed by (dissipated in) an incremental mass (dm) contained in a volume element (dv) of a given density (ρ). The equation description is as below:

$$\text{SAR} = \frac{d}{dt} \left(\frac{dW}{dm} \right) = \frac{d}{dt} \left(\frac{dW}{\rho dv} \right)$$

SAR is expressed in units of Watts per kilogram (W/kg)

SAR measurement can be either related to the temperature elevation in tissue by

$$\text{SAR} = c \left(\frac{\delta T}{\delta t} \right)$$

Where: C is the specific heat capacity, δT is the temperature rise and δt is the exposure duration, or related to the electrical field in the tissue by

$$\text{SAR} = \frac{\sigma |E|^2}{\rho}$$

Where: σ is the conductivity of the tissue, ρ is the mass density of the tissue and E is the RMS electrical field strength.

However for evaluating SAR of low power transmitter, electrical field measurement is typically applied.

4 SAR Measurement System

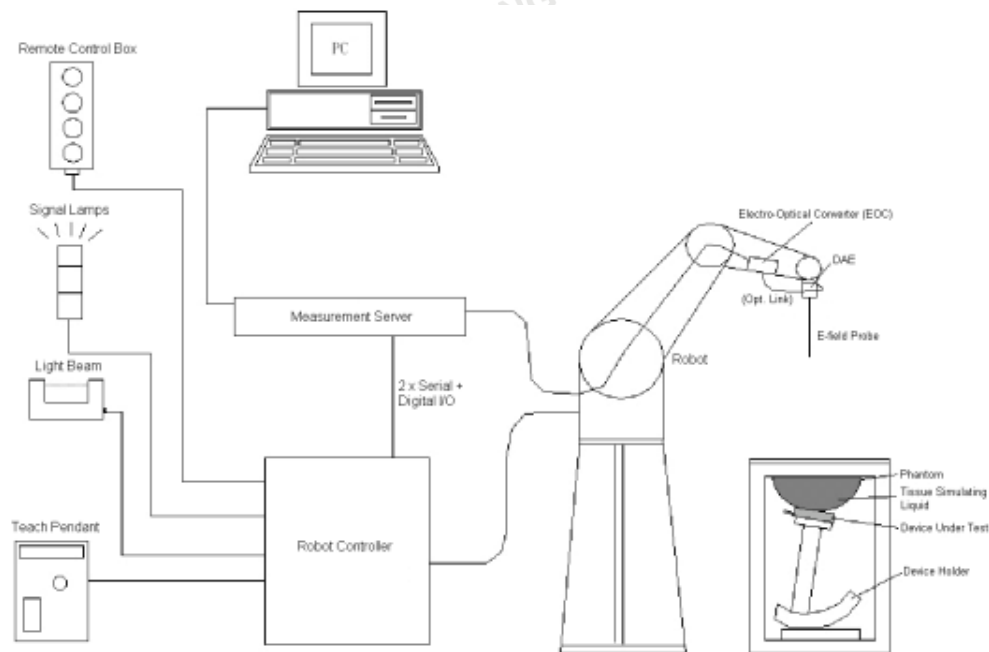

DASY System Configurations

The DASY system for performance compliance tests is illustrated above graphically. This system consists of the following items:

- A standard high precision 6-axis robot with controller, a teach pendant and software
- A data acquisition electronic (DAE) attached to the robot arm extension
- A dosimetric probe equipped with an optical surface detector system
- The electro-optical converter (EOC) performs the conversion between optical and electrical signals
- A measurement server performs the time critical tasks such as signal filtering, control of the robot operation and fast movement interrupts.
- A probe alignment unit which improves the accuracy of the probe positioning
- A computer operating Windows XP
- DASY software
- Remote control with teach pendant and additional circuitry for robot safety such as warning lamps, etc.
- The SAM twin phantom
- A device holder
- Tissue simulating liquid
- Dipole for evaluating the proper functioning of the system

components are described in details in the following sub-sections.

4.1 E-Field Probe

The SAR measurement is conducted with the dosimetric probe (manufactured by SPEAG). The probe is specially designed and calibrated for use in liquid with high permittivity. The dosimetric probe has special calibration in liquid at different frequency. This probe has a built in optical surface detection system to prevent from collision with phantom.

➤ E-Field Probe Specification

<EX3DV4 Probe>

Construction	Symmetrical design with triangular core Built-in shielding against static charges PEEK enclosure material (resistant to organic solvents, e.g., DGBE)	 <p style="text-align: center;">Photo of EX3DV4</p>
Frequency	10 MHz to 6 GHz; Linearity: ± 0.2 dB	
Directivity	± 0.3 dB in HSL (rotation around probe axis) ± 0.5 dB in tissue material (rotation normal to probe axis)	
Dynamic Range	10 μ W/g to 100 W/kg; Linearity: ± 0.2 dB (noise: typically < 1 μ W/g)	
Dimensions	Overall length: 330 mm (Tip: 20 mm) Tip diameter: 2.5 mm (Body: 12 mm) Typical distance from probe tip to dipole centers: 1 mm	

➤ E-Field Probe Calibration

Each probe needs to be calibrated according to a dosimetric assessment procedure with accuracy better than $\pm 10\%$. The spherical isotropy shall be evaluated and within ± 0.25 dB. The sensitivity parameters (NormX, NormY, and NormZ), the diode compression parameter (DCP) and the conversion factor (ConvF) of the probe are tested. The calibration data can be referred to appendix C of this report.

4.2 Data Acquisition Electronics (DAE)

The data acquisition electronics (DAE) consists of a highly sensitive electrometer-grade preamplifier with auto-zeroing, a channel and gain-switching multiplexer, a fast 16 bit AD-converter and a command decoder and control logic unit. Transmission to the measurement server is accomplished through an optical downlink for data and status information as well as an optical uplink for commands and the clock. The input impedance of the DAE is 200M Ω ; the inputs are symmetrical and floating. Common mode rejection is above 80dB.



Photo of DAE

4.3 Robot

The SPEAG DASY system uses the high precision robots (DASY5: TX60XL) type from Stäubli SA (France). For the 6-axis controllersystem, the robot controller version (DASY5: CS8c) from Stäubli is used. The Stäublirobot series have many features that are important for our application:

- High precision (repeatability ± 0.035 mm)
- High reliability (industrial design)
- Jerk-free straight movements
- Low ELF interference (the closed metallic construction shields against motor control fields)



Photo of DASY5

4.4 Measurement Server

The measurement server is based on a PC/104 CPU board with CPU (DASY5: 400 MHz, Intel Celeron), chipdisk (DASY5: 128 MB), RAM (DASY5: 128 MB). The necessary circuits for communication with the DAE electronic box, as well as the 16 bit AD converter system for optical detection and digital I/O interface are contained on the DASY I/O board, which is directly connected to the PC/104 bus of the CPU board.

The measurement server performs all the real-time data evaluation for field measurements and surface detection, controls robot movements and handles safety operations.



Photo of Server for DASY5

4.5 Phantom

<SAM Twin Phantom>

Shell Thickness	2 ± 0.2 mm; Center ear point: 6 ± 0.2 mm	
Filling Volume	Approx. 25 liters	
Dimensions	Length: 1000 mm; Width: 500 mm; Height: adjustable feet	
Measurement Areas	Left Hand, Right Hand, Flat Phantom	

Photo of SAM Phantom

The bottom plate contains three pair of bolts for locking the device holder. The device holder positions are adjusted to the standard measurement positions in the three sections. A white cover is provided to tap the phantom during off-periods to prevent water evaporation and changes in the liquid parameters. On the phantom top, three reference markers are provided to identify the phantom position with respect to the robot.

<ELI4 Phantom>

Shell Thickness	2 ± 0.2 mm (sagging: <1%)	
Filling Volume	Approx. 30 liters	
Dimensions	Major ellipse axis: 600 mm Minor axis: 400 mm	

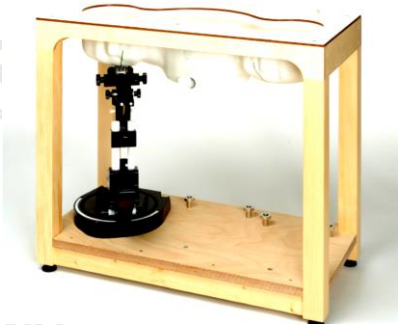
Photo of ELI4 Phantom

The ELI4 phantom is intended for compliance testing of handheld and body-mounted wireless devices in the frequency range of 30 MHz to 6 GHz. ELI4 is fully compatible with standard and all known tissue simulating liquids.

4.6 Device Holder

The SAR in the phantom is approximately inversely proportional to the square of the distance between the source and the liquid surface. For a source at 5 mm distance, a positioning uncertainty of ±0.5mm would produce a SAR uncertainty of ± 20%. Accurate device positioning is therefore crucial for accurate and repeatable measurements. The positions in which the devices must be measured are defined by the standards.

The DASY device holder is designed to cope with different positions given in the standard. It has two scales for the device rotation (with respect to the body axis) and the device inclination (with respect to the line between the ear reference points). The rotation center for both scales is the ear reference point (ERP). Thus the device needs no repositioning when changing the angles.

The DASY device holder is constructed of low-loss POM material having the following dielectric parameters: relative permittivity $\epsilon = 3$ and loss tangent $\delta = 0.02$. The amount of dielectric material has been reduced in the closest vicinity of the device, since measurements have suggested that the influence of the clamp on the test results could thus be lowered.



Device Holder

4.7 Data Storage and Evaluation

➤ Data Storage

The DASY software stores the assessed data from the data acquisition electronics as raw data (in microvolt readings from the probe sensors), together with all the necessary software parameters for the data evaluation (probe calibration data, liquid parameters and device frequency and modulation data) in measurement files. The post-processing software evaluates the desired unit and format for output each time the data is visualized or exported. This allows verification of the complete software setup even after the measurement and allows correction of erroneous parameter settings. For example, if a measurement has been performed with an incorrect crest factor parameter in the device setup, the parameter can be corrected afterwards and the data can be reevaluated.

The measured data can be visualized or exported in different units or formats, depending on the selected probe type (e.g., [V/m], [A/m], [W/kg]). Some of these units are not available in certain situations or give meaningless results, e.g., a SAR-output in a non-lose media, will always be zero. Raw data can also be exported to perform the evaluation with other software packages.

➤ Data Evaluation

The DASY post-processing software (SEMCAD) automatically executes the following procedures to calculate the field units from the microvolt readings at the probe connector. The parameters used in the evaluation are stored in the configuration modules of the software:

Probe parameters:	- Sensitivity	Norm _i , a _{i0} , a _{i1} , a _{i2}
	- Conversion factor	ConvF _i
	- Diode compression point	dcp _i
Device parameters:	- Frequency	f
	- Crest factor	cf
Media parameters:	- Conductivity	σ
	- Density	ρ

These parameters must be set correctly in the software. They can be found in the component documents or they can be imported into the software from the configuration files issued for the DASY components. In the direct measuring mode of the multi-meter option, the parameters of the actual system setup are used. In the scan visualization and export modes, the parameters stored in the corresponding document files are used.

The first step of the evaluation is a linearization of the filtered input signal to account for the compression characteristics of the detector diode. The compensation depends on the input signal, the diode type and the DC-transmission factor from the diode to the evaluation electronics. If the exciting field is pulsed, the crest factor of the signal must be known to correctly compensate for peak power.

The formula for each channel can be given as:

$$V_i = U_i + U_i^2 \cdot \frac{cf}{dcp_i}$$

with V_i = compensated signal of channel i , ($i = x, y, z$)

U_i = input signal of channel i , ($i = x, y, z$)

cf = crest factor of exciting field (DASY parameter)

dcp_i = diode compression point (DASY parameter)

From the compensated input signals, the primary field data for each channel can be evaluated:

$$\text{E-field Probes: } E_i = \sqrt{\frac{V_i}{\text{Norm}_i \cdot \text{ConvF}}}$$

$$\text{H-field Probes: } H_i = \sqrt{V_i} \cdot \frac{a_{i0} + a_{i1}f + a_{i2}f^2}{f}$$

with V_i = compensated signal of channel i , ($i = x, y, z$)

Norm_i = sensor sensitivity of channel i , ($i = x, y, z$), $\mu\text{V}/(\text{V/m})^2$ for E-field Probes

ConvF = sensitivity enhancement in solution

a_{ij} = sensor sensitivity factors for H-field probes

f = carrier frequency [GHz]

E_i = electric field strength of channel i in V/m

H_i = magnetic field strength of channel i in A/m

The RSS value of the field components gives the total field strength (Hermitian magnitude):

$$E_{\text{tot}} = \sqrt{E_x^2 + E_y^2 + E_z^2}$$

The primary field data are used to calculate the derived field units.

$$\text{SAR} = E_{\text{tot}}^2 \cdot \frac{\sigma}{\rho \cdot 1000}$$

with SAR = local specific absorption rate in W/kg

E_{tot} = total field strength in V/m

σ = conductivity in [mho/m] or [Siemens/m]

ρ = equivalent tissue density in g/cm^3

Note that the density is set to 1, to account for actual head tissue density rather than the density of the tissue simulating liquid.

5 Test Equipment List

Manufacturer	Name of Equipment	Type/Model	Serial Number	Calibration	
				Last Cal.	Due Date
SPEAG	835MHz System Validation Kit	D835V2	484	Aug. 25,2023	Aug. 24,2026
SPEAG	1800MHz System Validation Kit	D1800V2	2d158	Dec. 17,2021	Dec. 16,2024
SPEAG	1900MHz System Validation Kit	D1900V2	5d002	Aug. 25,2023	Aug. 24,2026
SPEAG	2600MHz System Validation Kit	D2600V2	1073	Feb. 17,2023	Feb. 16,2026
Rohde & Schwarz	UNIVERSAL RADIO COMMUNICATION TESTER	CMW500	1201.0002K50-104209-JC	Nov.05, 2023	Nov.04, 2024
SPEAG	Data Acquisition Electronics	DAE3	428	Aug.30,2023	Aug.29,2024
SPEAG	Dosimetric E-Field Probe	EX3DV4	7624	Sep. 06,2023	Sep. 05,2024
Agilent	ENA Series Network Analyzer	E5071C	MY46317418	Oct.25, 2023	Oct.24, 2024
SPEAG	DAK	DAK-3.5	1226	Oct.25, 2023	Oct.24, 2024
SPEAG	SAM Twin Phantom	QD000P40CD	1802	NA1	NA1
SPEAG	ELI Phantom	QDOVA004AA	2058	NA1	NA1
AR	Amplifier	ZHL-42W	QA1118004	Oct.25, 2023	Oct.24, 2024
Agilent	Power Meter	N1914A	MY50001102	Oct.25, 2023	Oct.24, 2024
Agilent	Power Sensor	N8481H	MY51240001	Oct.25, 2023	Oct.24, 2024
R&S	Spectrum Analyzer	N9020A	MY51170037	Oct.25, 2023	Oct.24, 2024
Agilent	Signal Generation	N5182A	MY48180656	Oct.25, 2023	Oct.24, 2024
Worken	Directional Coupler	0110A056010-10	COM5BNW1A2	Oct.25, 2023	Oct.24, 2024

Note:

- The calibration certificate of DASY can be referred to appendix C of this report.
- The dipole calibration interval can be extended to 3 years with justification. The dipoles are also not physically damaged, or repaired during the interval.
- The Insertion Loss calibration of Dual Directional Coupler and Attenuator were characterized via the network analyzer and compensated during system check.
- The dielectric probe kit was calibrated via the network analyzer, with the specified procedure (calibrated in pure water) and calibration kit (standard) short circuit, before the dielectric measurement. The specific procedure and calibration kit are provided by Agilent.
- In system check we need to monitor the level on the power meter, and adjust the power amplifier level to have precise power level to the dipole; the measured SAR will be normalized to 1W input power according to the ratio of 1W to the input power to the dipole. For system check, the calibration of the power amplifier is deemed not critically required for correct measurement; the power meter is critical and we do have calibration for it
- "1" : NA as this is not measurement equipment.

6 Tissue Simulating Liquids

For the measurement of the field distribution inside the SAM phantom with DASY, the phantom must be filled with around 25 liters of homogeneous body tissue simulating liquid. For head SAR testing, the liquid height from the ear reference point (ERP) of the phantom to the liquid top surface is larger than 15 cm, which is shown in Fig. 6.1. For body SAR testing, the liquid height from the center of the flat phantom to the liquid top surface is larger than 15 cm, which is shown as followed:



Photo of Liquid Height

The following table gives the recipes for tissue simulating liquid.

Ingredients (% by weight)	Frequency (MHz)				
	450	700-900	1750-2000	2300-2500	2500-2700
Water	38.56	40.30	55.24	55.00	54.92
Salt (NaCl)	3.95	1.38	0.31	0.2	0.23
Sucrose	56.32	57.90	0	0	0
HEC	0.98	0.24	0	0	0
Bactericide	0.19	0.18	0	0	0
Tween	0	0	44.45	44.80	44.85
Salt: 99+% Pure Sodium Chloride			Sucrose: 98+% Pure Sucrose		
Water: De-ionized, 16 MΩ+ resistivity			HEC: Hydroxyethyl Cellulose		
Tween: Polyoxyethylene (20) sorbitan monolaurate					
HSL5GHZ is composed of the following ingredients:					
Water: 50-65%					
Mineral oil: 10-30%					
Emulsifiers: 8-25%					
Sodium salt: 0-1.5%					

Table 1: Recipe of Tissue Simulate Liquid

The following table shows the measuring results for simulating liquid.

Measured Frequency (MHz)	Target Tissue		Measured Tissue				Liquid Temp.	Test Data
	ϵ_r	σ	ϵ_r	Dev. (%)	σ	Dev. (%)		
835	41.5	0.90	39.878	-3.91%	0.875	-2.78%	22.8	Aug. 20, 2024
1800	40.1	1.37	39.125	-2.19%	1.332	-4.86%	23.2	Aug. 23, 2024
1900	40.0	1.40	41.325	3.31%	1.382	-1.29%	22.4	Aug. 26, 2024
2600	39.0	1.96	40.125	2.88%	1.885	-3.83%	21.9	Aug. 27, 2024

7 System Verification Procedures

Each DASY system is equipped with one or more system validation kits. These units, together with the predefined measurement procedures within the DASY software, enable the user to conduct the system performance check and system validation. System validation kit includes a dipole, tripod holder to fix it underneath the flat phantom and a corresponding distance holder.

➤ Purpose of System Performance check

The system performance check verifies that the system operates within its specifications. System and operator errors can be detected and corrected. It is recommended that the system performance check be performed prior to any usage of the system in order to guarantee reproducible results. The system performance check uses normal SAR measurements in a simplified setup with a well characterized source. This setup was selected to give a high sensitivity to all parameters that might fail or vary over time. The system check does not intend to replace the calibration of the components, but indicates situations where the system uncertainty is exceeded due to drift or failure.

➤ System Setup

In the simplified setup for system evaluation, the EUT is replaced by a calibrated dipole and the power source is replaced by a continuous wave that comes from a signal generator. The calibrated dipole must be placed beneath the flat phantom section of the SAM twin phantom with the correct distance holder. The distance holder should touch the phantom surface with a light pressure at the reference marking and be oriented parallel to the long side of the phantom. The equipment setup is shown below:

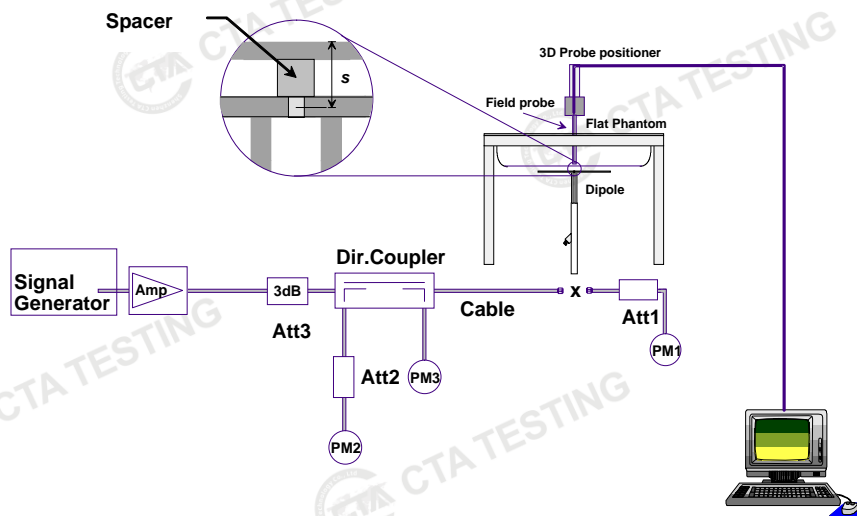

System Setup for System Evaluation

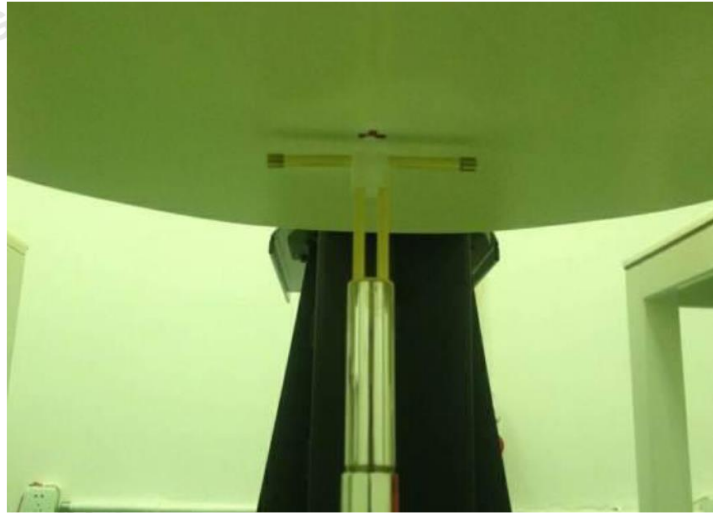

Photo of Dipole Setup

➤ Validation Results

Comparing to the original SAR value provided by SPEAG, the verification data should be within its specification of 10%. The table below shows the target SAR and measured SAR after normalized to 1W input power. It indicates that the system performance check can meet the variation criterion and the plots can be referred to Appendix A of this report.

Date	Frequency (MHz)	Power fed onto reference dipole (mW)	Targeted SAR 1g (W/kg)	Measured SAR1g (W/kg)	Normalized SAR (W/kg)	Deviation (%)
08/20/2024	835	250	9.68	2.22	8.88	-8.26%
08/23/2024	1800	250	39.2	9.52	38.08	-2.86%
08/26/2024	1900	250	40.1	9.74	38.96	-2.84%
08/27/2024	2600	250	56.8	13.98	55.92	-1.55%

8 EUT Testing Position

8.1 The measurement procedures are as follows:

Front -of-face device

A typical example of a front-of-face device is a two-way radio that is held at a distance from the face of the user when transmitting. In these cases the device under test shall be positioned at the distance to the phantom surface that corresponds to the intended use as specified by the manufacturer in the user instructions (Figure 8a). If the intended use is not specified, a separation distance of 25 mm between the phantom surface and the device shall be used.

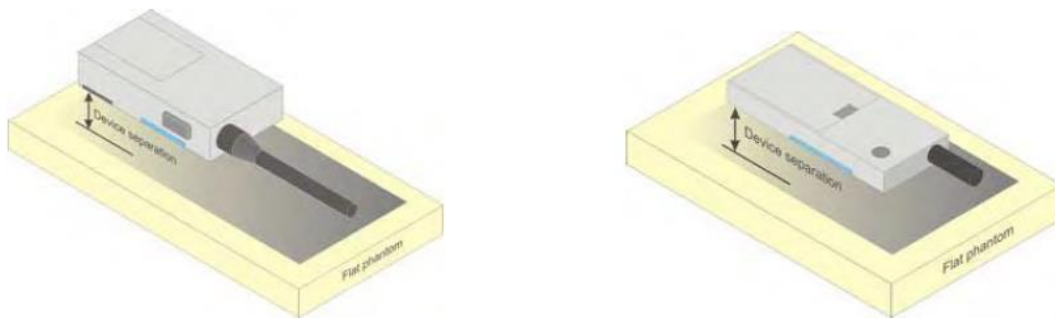

a) Two-way radios

Body-worn device

A typical example of a body-worn device is a Walkie Talkie, wireless enabled PDA or other battery operated wireless device with the ability to transmit while mounted on a person's body using a carry accessory approved by the wireless device manufacturer.

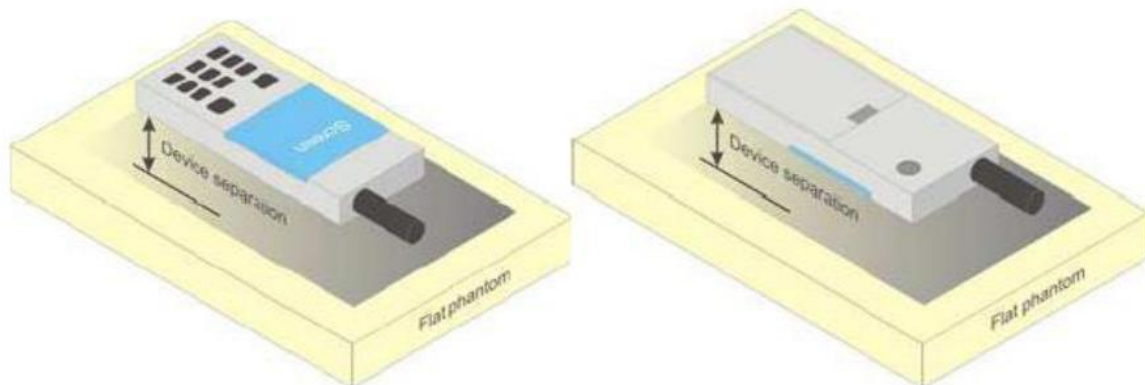

Picture 4 Test positions for body-worn devices

9 Measurement Procedures

The measurement procedures are as follows:

- (a) Use base station simulator (if applicable) or engineering software to transmit RF power continuously (continuous Tx) in the middle channel.
- (b) Keep EUT to radiate maximum output power or 100% duty factor (if applicable)
- (c) Measure output power through RF cable and power meter.
- (d) Place the EUT in the positions as setup photos demonstrates.
- (e) Set scan area, grid size and other setting on the DASY software.
- (f) Measure SAR transmitting at the middle channel for all applicable exposure positions.
- (g) Identify the exposure position and device configuration resulting the highest SAR
- (h) Measure SAR at the lowest and highest channels at the worst exposure position and device configuration if applicable.

According to the test standard, the recommended procedure for assessing the peak spatial-average SAR value consists of the following steps:

- (a) Power reference measurement
- (b) Area scan
- (c) Zoom scan
- (d) Power drift measurement

9.1 Spatial Peak SAR Evaluation

The procedure for spatial peak SAR evaluation has been implemented according to the test standard. It can be conducted for 1g and 10g, as well as for user-specific masses. The DASY software includes all numerical procedures necessary to evaluate the spatial peak SAR value.

The base for the evaluation is a "cube" measurement. The measured volume must include the 1g and 10g cubes with the highest averaged SAR values. For that purpose, the center of the measured volume is aligned to the interpolated peak SAR value of a previously performed area scan.

The entire evaluation of the spatial peak values is performed within the post-processing engine (SEMCAD). The system always gives the maximum values for the 1g and 10g cubes. The algorithm to find the cube with highest averaged SAR is divided into the following stages:

- (a) Extraction of the measured data (grid and values) from the Zoom Scan
- (b) Calculation of the SAR value at every measurement point based on all stored data (A/D values and measurement parameters)
- (c) Generation of a high-resolution mesh within the measured volume
- (d) Interpolation of all measured values from the measurement grid to the high-resolution grid
- (e) Extrapolation of the entire 3-D field distribution to the phantom surface over the distance from sensor to surface
- (f) Calculation of the averaged SAR within masses of 1g and 10g

9.2 Power Reference Measurement

The Power Reference Measurement and Power Drift Measurements are for monitoring the power drift of the device under test in the batch process. The minimum distance of probe sensors to surface determines the closest measurement point to phantom surface. This distance cannot be smaller than the distance of sensor calibration points to probe tip as defined in the probe properties.

9.3 Area Scan Procedures

The area scan is used as a fast scan in two dimensions to find the area of high field values, before doing a fine measurement around the hot spot. The sophisticated interpolation routines implemented in DASY software can find the maximum found in the scanned area, within a range of the global maximum. The range (in dB) is specified in the standards for compliance testing. For example, a 2 dB range is required in IEEE standard 1528 and IEC 62209 standards, whereby 3 dB is a requirement when compliance is assessed in accordance with the ARIB standard (Japan), if only one zoom scan follows the area scan, then only the absolute maximum will be taken as reference. For cases where multiple maximums are detected, the number of zoom scans has to be increased accordingly.

Area scan parameters extracted from FCC KDB 865664 D01 SAR measurement 100 MHz to 6 GHz.

	≤ 3 GHz	> 3 GHz
Maximum distance from closest measurement point (geometric center of probe sensors) to phantom surface	5 mm \pm 1 mm	$\frac{1}{2} \cdot \delta \cdot \ln(2)$ mm \pm 0.5 mm
Maximum probe angle from probe axis to phantom surface normal at the measurement location	$30^\circ \pm 1^\circ$	$20^\circ \pm 1^\circ$
Maximum area scan spatial resolution: Δx_{Area} , Δy_{Area}	≤ 2 GHz: ≤ 15 mm 2 – 3 GHz: ≤ 12 mm	3 – 4 GHz: ≤ 12 mm 4 – 6 GHz: ≤ 10 mm
	When the x or y dimension of the test device, in the measurement plane orientation, is smaller than the above, the measurement resolution must be \leq the corresponding x or y dimension of the test device with at least one measurement point on the test device.	

9.4 Zoom Scan Procedures

Zoom scans are used to assess the peak spatial SAR values within a cubic averaging volume containing 1 gram and 10gram of simulated tissue. The zoom scan measures points (refer to table below) within a cube whose base faces are centered on the maxima found in a preceding area scan job within the same procedure. When the measurement is done, the zoom scan evaluates the averaged SAR for 1 gram and 10 gram and displays these values next to the job's label.

Zoom scan parameters extracted from FCC KDB 865664 D01 SAR measurement 100 MHz to 6 GHz.

			≤ 3 GHz	> 3 GHz
Maximum zoom scan spatial resolution: Δx_{Zoom} , Δy_{Zoom}			≤ 2 GHz: ≤ 8 mm 2 – 3 GHz: ≤ 5 mm*	3 – 4 GHz: ≤ 5 mm* 4 – 6 GHz: ≤ 4 mm*
Maximum zoom scan spatial resolution, normal to phantom surface	uniform grid: $\Delta z_{Zoom}(n)$		≤ 5 mm	3 – 4 GHz: ≤ 4 mm 4 – 5 GHz: ≤ 3 mm 5 – 6 GHz: ≤ 2 mm
	graded grid	$\Delta z_{Zoom}(1)$: between 1 st two points closest to phantom surface	≤ 4 mm	3 – 4 GHz: ≤ 3 mm 4 – 5 GHz: ≤ 2.5 mm 5 – 6 GHz: ≤ 2 mm
		$\Delta z_{Zoom}(n>1)$: between subsequent points	$\leq 1.5 \cdot \Delta z_{Zoom}(n-1)$ mm	
Minimum zoom scan volume	x, y, z	≥ 30 mm	3 – 4 GHz: ≥ 28 mm 4 – 5 GHz: ≥ 25 mm 5 – 6 GHz: ≥ 22 mm	
Note: δ is the penetration depth of a plane-wave at normal incidence to the tissue medium; see IEEE Std 1528-2013 for details.				
* When zoom scan is required and the <i>reported</i> SAR from the <i>area scan based 1-g SAR estimation</i> procedures of KDB Publication 447498 is ≤ 1.4 W/kg, ≤ 8 mm, ≤ 7 mm and ≤ 5 mm zoom scan resolution may be applied, respectively, for 2 GHz to 3 GHz, 3 GHz to 4 GHz and 4 GHz to 6 GHz.				

9.5 Volume Scan Procedures

The volume scan is used for assess overlapping SAR distributions for antennas transmitting in different frequency bands. It is equivalent to an oversized zoom scan used in standalone measurements. The measurement volume will be used to enclose all the simultaneous transmitting antennas. For antennas transmitting simultaneously in different frequency bands, the volume scan is measured separately in each frequency band. In order to sum correctly to compute the 1g aggregate SAR, the EUT remain in the same test position for all measurements and all volume scan use the same spatial resolution and grid spacing. When all volume scan were completed, the software, SEMCAD postprocessor can combine and subsequently superpose these measurement data to calculating the multiband SAR.

9.6 Power Drift Monitoring

All SAR testing is under the EUT install full charged battery and transmit maximum output power. In DASY measurement software, the power reference measurement and power drift measurement procedures are used for monitoring the power drift of EUT during SAR test. Both these procedures measure the field at a specified reference position before and after the SAR testing. The software will calculate the field difference in dB. If the power drift more than 5%, the SAR will be retested.

10 TEST CONDITIONS AND RESULTS

10.1 Conducted Power Results

<LTE Conducted Power>

Band	Bandwidth(MHz)	UL Frequency(MHz)	Modulation	RB Size	RB Offset	Average Power	Tune-up limit (dBm)
Band2	1.4	1850.7	QPSK	6	LOW	23.51	24.00
Band2	1.4	1850.7	QPSK	3	LOW	24.98	25.00
Band2	1.4	1850.7	QPSK	3	MID	25.02	25.50
Band2	1.4	1850.7	QPSK	3	HIGH	24.99	25.00
Band2	1.4	1850.7	QPSK	1	LOW	25.05	25.50
Band2	1.4	1850.7	QPSK	1	MID	25	25.00
Band2	1.4	1850.7	QPSK	1	HIGH	25.02	25.50
Band2	1.4	1850.7	16QAM	6	LOW	22.62	23.00
Band2	1.4	1850.7	16QAM	3	LOW	23.69	24.00
Band2	1.4	1850.7	16QAM	3	MID	23.77	24.00
Band2	1.4	1850.7	16QAM	3	HIGH	23.75	24.00
Band2	1.4	1850.7	16QAM	1	LOW	23.93	24.00
Band2	1.4	1850.7	16QAM	1	MID	23.94	24.00
Band2	1.4	1850.7	16QAM	1	HIGH	23.92	24.00
Band2	1.4	1880	QPSK	6	LOW	23.13	24.00
Band2	1.4	1880	QPSK	3	LOW	24.03	25.00
Band2	1.4	1880	QPSK	3	MID	24.1	25.00
Band2	1.4	1880	QPSK	3	HIGH	24.09	25.00
Band2	1.4	1880	QPSK	1	LOW	24.06	25.00
Band2	1.4	1880	QPSK	1	MID	24.11	25.00
Band2	1.4	1880	QPSK	1	HIGH	24.05	25.00
Band2	1.4	1880	16QAM	6	LOW	22.19	23.00
Band2	1.4	1880	16QAM	3	LOW	23.14	24.00
Band2	1.4	1880	16QAM	3	MID	23.21	24.00
Band2	1.4	1880	16QAM	3	HIGH	23.14	24.00
Band2	1.4	1880	16QAM	1	LOW	23.39	24.00
Band2	1.4	1880	16QAM	1	MID	23.38	24.00
Band2	1.4	1880	16QAM	1	HIGH	23.41	24.00
Band2	1.4	1909.3	QPSK	6	LOW	22.53	23.00
Band2	1.4	1909.3	QPSK	3	LOW	23.31	24.00
Band2	1.4	1909.3	QPSK	3	MID	23.35	24.00
Band2	1.4	1909.3	QPSK	3	HIGH	23.16	24.00
Band2	1.4	1909.3	QPSK	1	LOW	23.41	24.00
Band2	1.4	1909.3	QPSK	1	MID	23.24	24.00
Band2	1.4	1909.3	QPSK	1	HIGH	23.13	24.00

Band2	1.4	1909.3	16QAM	6	LOW	21.66	22.00
Band2	1.4	1909.3	16QAM	3	LOW	22.79	23.00
Band2	1.4	1909.3	16QAM	3	MID	22.78	23.00
Band2	1.4	1909.3	16QAM	3	HIGH	23.1	24.00
Band2	1.4	1909.3	16QAM	1	LOW	23.36	24.00
Band2	1.4	1909.3	16QAM	1	MID	22.64	23.00
Band2	1.4	1909.3	16QAM	1	HIGH	22.51	23.00
Band2	3	1851.5	QPSK	15	LOW	23.64	24.00
Band2	3	1851.5	QPSK	8	LOW	23.59	24.00
Band2	3	1851.5	QPSK	8	MID	23.59	24.00
Band2	3	1851.5	QPSK	8	HIGH	23.61	24.00
Band2	3	1851.5	QPSK	1	LOW	24.08	25.00
Band2	3	1851.5	QPSK	1	MID	25.16	25.50
Band2	3	1851.5	QPSK	1	HIGH	24.11	25.00
Band2	3	1851.5	16QAM	15	LOW	22.66	23.00
Band2	3	1851.5	16QAM	12	LOW	22.66	23.00
Band2	3	1851.5	16QAM	12	MID	22.33	23.00
Band2	3	1851.5	16QAM	12	HIGH	22.31	23.00
Band2	3	1851.5	16QAM	1	LOW	23.95	24.00
Band2	3	1851.5	16QAM	1	MID	23.54	24.00
Band2	3	1851.5	16QAM	1	HIGH	23.74	24.00
Band2	3	1880	QPSK	15	LOW	22.95	23.00
Band2	3	1880	QPSK	8	LOW	23.19	24.00
Band2	3	1880	QPSK	8	MID	24.19	25.00
Band2	3	1880	QPSK	8	HIGH	23.25	24.00
Band2	3	1880	QPSK	1	LOW	24.17	25.00
Band2	3	1880	QPSK	1	MID	24.11	25.00
Band2	3	1880	QPSK	1	HIGH	24.11	25.00
Band2	3	1880	16QAM	15	LOW	22.3	23.00
Band2	3	1880	16QAM	12	LOW	22.31	23.00
Band2	3	1880	16QAM	12	MID	22.29	23.00
Band2	3	1880	16QAM	12	HIGH	22.27	23.00
Band2	3	1880	16QAM	1	LOW	23.47	24.00
Band2	3	1880	16QAM	1	MID	23.44	24.00
Band2	3	1880	16QAM	1	HIGH	23.45	24.00
Band2	3	1908.5	QPSK	15	LOW	23.29	24.00
Band2	3	1908.5	QPSK	8	LOW	22.93	23.00
Band2	3	1908.5	QPSK	8	MID	22.88	23.00
Band2	3	1908.5	QPSK	8	HIGH	22.84	23.00
Band2	3	1908.5	QPSK	1	LOW	23.78	24.00
Band2	3	1908.5	QPSK	1	MID	23.6	24.00
Band2	3	1908.5	QPSK	1	HIGH	23.03	24.00

Band2	3	1908.5	16QAM	15	LOW	21.92	22.00
Band2	3	1908.5	16QAM	12	LOW	21.92	22.00
Band2	3	1908.5	16QAM	12	MID	21.92	22.00
Band2	3	1908.5	16QAM	12	HIGH	21.87	22.00
Band2	3	1908.5	16QAM	1	LOW	22.91	23.00
Band2	3	1908.5	16QAM	1	MID	22.9	23.00
Band2	3	1908.5	16QAM	1	HIGH	22.57	23.00
Band2	5	1852.5	QPSK	25	LOW	23.13	24.00
Band2	5	1852.5	QPSK	12	LOW	23.17	24.00
Band2	5	1852.5	QPSK	12	MID	23.16	24.00
Band2	5	1852.5	QPSK	12	HIGH	22.98	23.00
Band2	5	1852.5	QPSK	1	LOW	24.04	25.00
Band2	5	1852.5	QPSK	1	MID	24.63	25.00
Band2	5	1852.5	QPSK	1	HIGH	23	24.00
Band2	5	1852.5	16QAM	25	LOW	22.04	23.00
Band2	5	1852.5	16QAM	12	LOW	22.18	23.00
Band2	5	1852.5	16QAM	12	MID	22.06	23.00
Band2	5	1852.5	16QAM	12	HIGH	22.18	23.00
Band2	5	1852.5	16QAM	1	LOW	23.51	24.00
Band2	5	1852.5	16QAM	1	MID	23.34	24.00
Band2	5	1852.5	16QAM	1	HIGH	23.43	24.00
Band2	5	1880	QPSK	25	LOW	22.99	23.00
Band2	5	1880	QPSK	12	LOW	23.04	24.00
Band2	5	1880	QPSK	12	MID	23.02	24.00
Band2	5	1880	QPSK	12	HIGH	22.98	23.00
Band2	5	1880	QPSK	1	LOW	24	25.00
Band2	5	1880	QPSK	1	MID	23.99	24.00
Band2	5	1880	QPSK	1	HIGH	24.05	25.00
Band2	5	1880	16QAM	25	LOW	22	23.00
Band2	5	1880	16QAM	12	LOW	22.06	23.00
Band2	5	1880	16QAM	12	MID	22.04	23.00
Band2	5	1880	16QAM	12	HIGH	22	23.00
Band2	5	1880	16QAM	1	LOW	23.23	24.00
Band2	5	1880	16QAM	1	MID	23.09	24.00
Band2	5	1880	16QAM	1	HIGH	23.29	24.00
Band2	5	1907.5	QPSK	25	LOW	22.79	23.00
Band2	5	1907.5	QPSK	12	LOW	23.12	24.00
Band2	5	1907.5	QPSK	12	MID	22.97	23.00
Band2	5	1907.5	QPSK	12	HIGH	22.68	23.00
Band2	5	1907.5	QPSK	1	LOW	23.87	24.00
Band2	5	1907.5	QPSK	1	MID	23.67	24.00
Band2	5	1907.5	QPSK	1	HIGH	23.4	24.00

Band2	5	1907.5	16QAM	25	LOW	21.96	22.00
Band2	5	1907.5	16QAM	12	LOW	22.09	23.00
Band2	5	1907.5	16QAM	12	MID	22.06	23.00
Band2	5	1907.5	16QAM	12	HIGH	21.88	22.00
Band2	5	1907.5	16QAM	1	LOW	23.14	24.00
Band2	5	1907.5	16QAM	1	MID	22.91	23.00
Band2	5	1907.5	16QAM	1	HIGH	22.67	23.00
Band2	10	1855	QPSK	50	LOW	22.84	23.00
Band2	10	1855	QPSK	25	LOW	22.95	23.00
Band2	10	1855	QPSK	25	MID	22.86	23.00
Band2	10	1855	QPSK	25	HIGH	23.04	24.00
Band2	10	1855	QPSK	1	LOW	24.06	25.00
Band2	10	1855	QPSK	1	MID	24.47	25.00
Band2	10	1855	QPSK	1	HIGH	24.64	25.00
Band2	10	1855	16QAM	27	LOW	21.77	22.00
Band2	10	1855	16QAM	15	LOW	21.87	22.00
Band2	10	1855	16QAM	15	MID	21.72	22.00
Band2	10	1855	16QAM	15	HIGH	21.98	22.00
Band2	10	1855	16QAM	1	LOW	23.56	24.00
Band2	10	1855	16QAM	1	MID	23.27	24.00
Band2	10	1855	16QAM	1	HIGH	23.39	24.00
Band2	10	1880	QPSK	50	LOW	22.77	23.00
Band2	10	1880	QPSK	25	LOW	22.83	23.00
Band2	10	1880	QPSK	25	MID	22.83	23.00
Band2	10	1880	QPSK	25	HIGH	22.85	23.00
Band2	10	1880	QPSK	1	LOW	23.98	24.00
Band2	10	1880	QPSK	1	MID	23.81	24.00
Band2	10	1880	QPSK	1	HIGH	24.17	25.00
Band2	10	1880	16QAM	27	LOW	21.91	22.00
Band2	10	1880	16QAM	15	LOW	21.9	22.00
Band2	10	1880	16QAM	15	MID	21.83	22.00
Band2	10	1880	16QAM	15	HIGH	21.99	22.00
Band2	10	1880	16QAM	1	LOW	23.62	24.00
Band2	10	1880	16QAM	1	MID	23.48	24.00
Band2	10	1880	16QAM	1	HIGH	23.84	24.00
Band2	10	1905	QPSK	50	LOW	22.8	23.00
Band2	10	1905	QPSK	25	LOW	23.07	24.00
Band2	10	1905	QPSK	25	MID	23.12	24.00
Band2	10	1905	QPSK	25	HIGH	22.68	23.00
Band2	10	1905	QPSK	1	LOW	24.49	25.00
Band2	10	1905	QPSK	1	MID	23.99	24.00
Band2	10	1905	QPSK	1	HIGH	23.62	24.00

Band2	10	1905	16QAM	27	LOW	21.93	22.00
Band2	10	1905	16QAM	15	LOW	21.95	22.00
Band2	10	1905	16QAM	15	MID	22.27	23.00
Band2	10	1905	16QAM	15	HIGH	21.79	22.00
Band2	10	1905	16QAM	1	LOW	23.66	24.00
Band2	10	1905	16QAM	1	MID	23.18	24.00
Band2	10	1905	16QAM	1	HIGH	24.03	25.00
Band2	15	1857.5	QPSK	75	LOW	23.22	24.00
Band2	15	1857.5	QPSK	38	LOW	23.25	24.00
Band2	15	1857.5	QPSK	38	MID	23.25	24.00
Band2	15	1857.5	QPSK	38	HIGH	23.33	24.00
Band2	15	1857.5	QPSK	1	LOW	24.73	25.00
Band2	15	1857.5	QPSK	1	MID	24.47	25.00
Band2	15	1857.5	QPSK	1	HIGH	24.23	25.00
Band2	15	1857.5	16QAM	27	LOW	22.05	23.00
Band2	15	1857.5	16QAM	15	LOW	23.19	24.00
Band2	15	1857.5	16QAM	15	MID	23.18	24.00
Band2	15	1857.5	16QAM	15	HIGH	23.08	24.00
Band2	15	1857.5	16QAM	1	LOW	24	25.00
Band2	15	1857.5	16QAM	1	MID	23.84	24.00
Band2	15	1857.5	16QAM	1	HIGH	23.68	24.00
Band2	15	1880	QPSK	75	LOW	22.88	23.00
Band2	15	1880	QPSK	38	HIGH	22.92	23.00
Band2	15	1880	QPSK	38	MID	22.88	23.00
Band2	15	1880	QPSK	1	LOW	23.91	24.00
Band2	15	1880	QPSK	1	MID	23.87	24.00
Band2	15	1880	QPSK	1	HIGH	24.26	25.00
Band2	15	1880	16QAM	27	LOW	21.96	22.00
Band2	15	1880	16QAM	15	LOW	22.98	23.00
Band2	15	1880	16QAM	15	MID	22.98	23.00
Band2	15	1880	16QAM	15	HIGH	23.26	24.00
Band2	15	1880	16QAM	1	LOW	23.55	24.00
Band2	15	1880	16QAM	1	MID	23.58	24.00
Band2	15	1880	16QAM	1	HIGH	24	25.00
Band2	15	1902.5	QPSK	75	LOW	23.14	24.00
Band2	15	1902.5	QPSK	38	LOW	23.11	24.00
Band2	15	1902.5	QPSK	38	MID	23.11	24.00
Band2	15	1902.5	QPSK	38	HIGH	23.1	24.00
Band2	15	1902.5	QPSK	1	LOW	24.46	25.00
Band2	15	1902.5	QPSK	1	MID	24.06	25.00
Band2	15	1902.5	QPSK	1	HIGH	23.62	24.00
Band2	15	1902.5	16QAM	27	LOW	22.56	23.00

Band2	15	1902.5	16QAM	15	LOW	23.42	24.00
Band2	15	1902.5	16QAM	15	MID	23.39	24.00
Band2	15	1902.5	16QAM	15	HIGH	22.76	23.00
Band2	15	1902.5	16QAM	1	LOW	23.98	24.00
Band2	15	1902.5	16QAM	1	MID	23.57	24.00
Band2	15	1902.5	16QAM	1	HIGH	23.3	24.00
Band2	20	1860	QPSK	100	LOW	23.23	24.00
Band2	20	1860	QPSK	50	LOW	23.37	24.00
Band2	20	1860	QPSK	50	MID	23.41	24.00
Band2	20	1860	QPSK	50	HIGH	23.16	24.00
Band2	20	1860	QPSK	1	LOW	25.08	25.50
Band2	20	1860	QPSK	1	MID	24.43	25.00
Band2	20	1860	QPSK	1	HIGH	23.92	24.00
Band2	20	1860	16QAM	27	LOW	22.17	23.00
Band2	20	1860	16QAM	15	LOW	23.41	24.00
Band2	20	1860	16QAM	15	MID	23.38	24.00
Band2	20	1860	16QAM	15	HIGH	23	24.00
Band2	20	1860	16QAM	1	LOW	24.04	25.00
Band2	20	1860	16QAM	1	MID	23.73	24.00
Band2	20	1860	16QAM	1	HIGH	23.49	24.00
Band2	20	1880	QPSK	100	LOW	22.94	23.00
Band2	20	1880	QPSK	50	LOW	23.09	24.00
Band2	20	1880	QPSK	50	MID	23.09	24.00
Band2	20	1880	QPSK	50	HIGH	23.21	24.00
Band2	20	1880	QPSK	1	LOW	24	25.00
Band2	20	1880	QPSK	1	MID	24.14	25.00
Band2	20	1880	QPSK	1	HIGH	24.66	25.00
Band2	20	1880	16QAM	27	LOW	22.04	23.00
Band2	20	1880	16QAM	15	LOW	22.97	23.00
Band2	20	1880	16QAM	15	MID	22.96	23.00
Band2	20	1880	16QAM	15	HIGH	23.34	24.00
Band2	20	1880	16QAM	1	LOW	23.36	24.00
Band2	20	1880	16QAM	1	MID	23.54	24.00
Band2	20	1880	16QAM	1	HIGH	23.85	24.00
Band2	20	1900	QPSK	100	LOW	23.5	24.00
Band2	20	1900	QPSK	50	LOW	23.53	24.00
Band2	20	1900	QPSK	50	MID	23.53	24.00
Band2	20	1900	QPSK	50	HIGH	23.08	24.00
Band2	20	1900	QPSK	1	LOW	24.89	25.00
Band2	20	1900	QPSK	1	MID	24.64	25.00
Band2	20	1900	QPSK	1	HIGH	23.68	24.00
Band2	20	1900	16QAM	27	LOW	22.45	23.00

Band2	20	1900	16QAM	15	LOW	23.58	24.00
Band2	20	1900	16QAM	15	MID	23.52	24.00
Band2	20	1900	16QAM	15	HIGH	22.8	23.00
Band2	20	1900	16QAM	1	LOW	24.03	25.00
Band2	20	1900	16QAM	1	MID	23.94	24.00
Band2	20	1900	16QAM	1	HIGH	23.11	24.00

Band	Bandwidth(MHz)	UL Frequency(MHz)	Modulation	RB Size	RB Offset	Average Power	Tune-up limit (dBm)
Band4	1.4	1710.7	QPSK	6	LOW	21.59	22.00
Band4	1.4	1710.7	QPSK	3	LOW	22.15	23.00
Band4	1.4	1710.7	QPSK	3	MID	22.12	23.00
Band4	1.4	1710.7	QPSK	3	HIGH	22.09	23.00
Band4	1.4	1710.7	QPSK	1	LOW	22.05	23.00
Band4	1.4	1710.7	QPSK	1	MID	22.31	23.00
Band4	1.4	1710.7	QPSK	1	HIGH	22.08	23.00
Band4	1.4	1710.7	16QAM	6	LOW	20.16	21.00
Band4	1.4	1710.7	16QAM	3	LOW	21.33	22.00
Band4	1.4	1710.7	16QAM	3	MID	21.35	22.00
Band4	1.4	1710.7	16QAM	3	HIGH	21.35	22.00
Band4	1.4	1710.7	16QAM	1	LOW	21.15	22.00
Band4	1.4	1710.7	16QAM	1	MID	21.36	22.00
Band4	1.4	1710.7	16QAM	1	HIGH	21.14	22.00
Band4	1.4	1732.5	QPSK	6	LOW	21.28	22.00
Band4	1.4	1732.5	QPSK	3	LOW	22.51	23.00
Band4	1.4	1732.5	QPSK	3	MID	22.47	23.00
Band4	1.4	1732.5	QPSK	3	HIGH	22.44	23.00
Band4	1.4	1732.5	QPSK	1	LOW	22.27	23.00
Band4	1.4	1732.5	QPSK	1	MID	22.65	23.00
Band4	1.4	1732.5	QPSK	1	HIGH	22.29	23.00
Band4	1.4	1732.5	16QAM	6	LOW	20.46	21.00
Band4	1.4	1732.5	16QAM	3	LOW	21.55	22.00
Band4	1.4	1732.5	16QAM	3	MID	21.57	22.00
Band4	1.4	1732.5	16QAM	3	HIGH	21.63	22.00
Band4	1.4	1732.5	16QAM	1	LOW	21.45	22.00
Band4	1.4	1732.5	16QAM	1	MID	21.85	22.00
Band4	1.4	1732.5	16QAM	1	HIGH	21.43	22.00
Band4	1.4	1754.3	QPSK	6	LOW	21	22.00
Band4	1.4	1754.3	QPSK	3	LOW	22.01	23.00
Band4	1.4	1754.3	QPSK	3	MID	21.96	22.00
Band4	1.4	1754.3	QPSK	3	HIGH	21.98	22.00
Band4	1.4	1754.3	QPSK	1	LOW	21.89	22.00
Band4	1.4	1754.3	QPSK	1	MID	22.14	23.00
Band4	1.4	1754.3	QPSK	1	HIGH	21.87	22.00
Band4	1.4	1754.3	16QAM	6	LOW	19.94	20.00
Band4	1.4	1754.3	16QAM	3	LOW	21.03	22.00
Band4	1.4	1754.3	16QAM	3	MID	21.06	22.00
Band4	1.4	1754.3	16QAM	3	HIGH	21.05	22.00
Band4	1.4	1754.3	16QAM	1	LOW	21.05	22.00

Band4	1.4	1754.3	16QAM	1	MID	21.24	22.00
Band4	1.4	1754.3	16QAM	1	HIGH	21.04	22.00
Band4	3	1711.5	QPSK	15	LOW	21.03	22.00
Band4	3	1711.5	QPSK	8	LOW	21.07	22.00
Band4	3	1711.5	QPSK	8	MID	21.1	22.00
Band4	3	1711.5	QPSK	8	HIGH	21.08	22.00
Band4	3	1711.5	QPSK	1	LOW	22.08	23.00
Band4	3	1711.5	QPSK	1	MID	22.16	23.00
Band4	3	1711.5	QPSK	1	HIGH	22.15	23.00
Band4	3	1711.5	16QAM	15	LOW	20.13	21.00
Band4	3	1711.5	16QAM	15	MID	20.15	21.00
Band4	3	1711.5	16QAM	15	HIGH	20.12	21.00
Band4	3	1711.5	16QAM	1	LOW	21.2	22.00
Band4	3	1711.5	16QAM	1	MID	21.25	22.00
Band4	3	1711.5	16QAM	1	HIGH	21.22	22.00
Band4	3	1732.5	QPSK	15	LOW	21.28	22.00
Band4	3	1732.5	QPSK	8	LOW	21.33	22.00
Band4	3	1732.5	QPSK	8	MID	21.31	22.00
Band4	3	1732.5	QPSK	8	HIGH	21.31	22.00
Band4	3	1732.5	QPSK	1	LOW	22.28	23.00
Band4	3	1732.5	QPSK	1	MID	22.25	23.00
Band4	3	1732.5	QPSK	1	HIGH	22.24	23.00
Band4	3	1732.5	16QAM	15	LOW	20.4	21.00
Band4	3	1732.5	16QAM	15	MID	20.44	21.00
Band4	3	1732.5	16QAM	15	HIGH	20.41	21.00
Band4	3	1732.5	16QAM	1	LOW	21.86	22.00
Band4	3	1732.5	16QAM	1	MID	21.92	22.00
Band4	3	1732.5	16QAM	1	HIGH	21.93	22.00
Band4	3	1753.5	QPSK	15	LOW	20.9	21.00
Band4	3	1753.5	QPSK	8	LOW	21.38	22.00
Band4	3	1753.5	QPSK	8	MID	20.93	21.00
Band4	3	1753.5	QPSK	8	HIGH	20.87	21.00
Band4	3	1753.5	QPSK	1	LOW	21.96	22.00
Band4	3	1753.5	QPSK	1	MID	21.9	22.00
Band4	3	1753.5	QPSK	1	HIGH	21.85	22.00
Band4	3	1753.5	16QAM	15	LOW	19.96	20.00
Band4	3	1753.5	16QAM	15	MID	19.95	20.00
Band4	3	1753.5	16QAM	15	HIGH	19.96	20.00
Band4	3	1753.5	16QAM	1	LOW	21.16	22.00
Band4	3	1753.5	16QAM	1	MID	21.08	22.00
Band4	3	1753.5	16QAM	1	HIGH	21.04	22.00
Band4	5	1712.5	QPSK	25	LOW	21.01	22.00

Band4	5	1712.5	QPSK	12	LOW	21	22.00
Band4	5	1712.5	QPSK	12	MID	21	22.00
Band4	5	1712.5	QPSK	12	HIGH	20.93	21.00
Band4	5	1712.5	QPSK	1	LOW	21.85	22.00
Band4	5	1712.5	QPSK	1	MID	22.06	23.00
Band4	5	1712.5	QPSK	1	HIGH	21.95	22.00
Band4	5	1712.5	16QAM	25	LOW	20.03	21.00
Band4	5	1712.5	16QAM	12	LOW	19.98	20.00
Band4	5	1712.5	16QAM	12	MID	20.01	21.00
Band4	5	1712.5	16QAM	12	HIGH	19.97	20.00
Band4	5	1712.5	16QAM	1	LOW	20.97	21.00
Band4	5	1712.5	16QAM	1	MID	21.12	22.00
Band4	5	1712.5	16QAM	1	HIGH	21.01	22.00
Band4	5	1732.5	QPSK	25	LOW	21.3	22.00
Band4	5	1732.5	QPSK	12	LOW	21.31	22.00
Band4	5	1732.5	QPSK	12	MID	21.26	22.00
Band4	5	1732.5	QPSK	12	HIGH	21.29	22.00
Band4	5	1732.5	QPSK	1	LOW	22.22	23.00
Band4	5	1732.5	QPSK	1	MID	22.4	23.00
Band4	5	1732.5	QPSK	1	HIGH	22.17	23.00
Band4	5	1732.5	16QAM	25	LOW	20.45	21.00
Band4	5	1732.5	16QAM	12	LOW	20.41	21.00
Band4	5	1732.5	16QAM	12	MID	20.39	21.00
Band4	5	1732.5	16QAM	12	HIGH	20.32	21.00
Band4	5	1732.5	16QAM	1	LOW	21.35	22.00
Band4	5	1732.5	16QAM	1	MID	21.48	22.00
Band4	5	1732.5	16QAM	1	HIGH	21.34	22.00
Band4	5	1752.5	QPSK	25	LOW	21.03	22.00
Band4	5	1752.5	QPSK	12	LOW	20.97	21.00
Band4	5	1752.5	QPSK	12	MID	20.98	21.00
Band4	5	1752.5	QPSK	12	HIGH	20.89	21.00
Band4	5	1752.5	QPSK	1	LOW	21.96	22.00
Band4	5	1752.5	QPSK	1	MID	22.08	23.00
Band4	5	1752.5	QPSK	1	HIGH	21.8	22.00
Band4	5	1752.5	16QAM	25	LOW	19.91	20.00
Band4	5	1752.5	16QAM	12	LOW	20.09	21.00
Band4	5	1752.5	16QAM	12	MID	20	21.00
Band4	5	1752.5	16QAM	12	HIGH	19.98	20.00
Band4	5	1752.5	16QAM	1	LOW	20.98	21.00
Band4	5	1752.5	16QAM	1	MID	21.04	22.00
Band4	5	1752.5	16QAM	1	HIGH	20.79	21.00
Band4	10	1715	QPSK	50	LOW	21.33	22.00

Band4	10	1715	QPSK	25	LOW	21.31	22.00
Band4	10	1715	QPSK	25	MID	21.33	22.00
Band4	10	1715	QPSK	25	HIGH	21.26	22.00
Band4	10	1715	QPSK	1	LOW	21.28	22.00
Band4	10	1715	QPSK	1	MID	22.36	23.00
Band4	10	1715	QPSK	1	HIGH	22.02	23.00
Band4	10	1715	16QAM	12	LOW	21.16	22.00
Band4	10	1715	16QAM	6	LOW	21.21	22.00
Band4	10	1715	16QAM	6	MID	21.26	22.00
Band4	10	1715	16QAM	6	HIGH	21.24	22.00
Band4	10	1715	16QAM	1	LOW	21.28	22.00
Band4	10	1715	16QAM	1	MID	21.48	22.00
Band4	10	1715	16QAM	1	HIGH	21.4	22.00
Band4	10	1732.5	QPSK	50	LOW	21.42	22.00
Band4	10	1732.5	QPSK	25	LOW	21.41	22.00
Band4	10	1732.5	QPSK	25	MID	21.39	22.00
Band4	10	1732.5	QPSK	25	HIGH	21.4	22.00
Band4	10	1732.5	QPSK	1	LOW	22.24	23.00
Band4	10	1732.5	QPSK	1	MID	22.5	23.00
Band4	10	1732.5	QPSK	1	HIGH	22.21	23.00
Band4	10	1732.5	16QAM	12	LOW	21.51	22.00
Band4	10	1732.5	16QAM	6	LOW	21.31	22.00
Band4	10	1732.5	16QAM	6	MID	21.36	22.00
Band4	10	1732.5	16QAM	6	HIGH	21.5	22.00
Band4	10	1732.5	16QAM	1	LOW	21.5	22.00
Band4	10	1732.5	16QAM	1	MID	21.55	22.00
Band4	10	1732.5	16QAM	1	HIGH	21.54	22.00
Band4	10	1750	QPSK	50	LOW	20.98	21.00
Band4	10	1750	QPSK	25	LOW	21.22	22.00
Band4	10	1750	QPSK	25	MID	21.05	22.00
Band4	10	1750	QPSK	25	HIGH	20.95	21.00
Band4	10	1750	QPSK	1	LOW	21.04	22.00
Band4	10	1750	QPSK	1	MID	22.17	23.00
Band4	10	1750	QPSK	1	HIGH	22.24	23.00
Band4	10	1750	16QAM	12	LOW	21.2	22.00
Band4	10	1750	16QAM	6	LOW	22.09	23.00
Band4	10	1750	16QAM	6	MID	22.11	23.00
Band4	10	1750	16QAM	6	HIGH	20.89	21.00
Band4	10	1750	16QAM	1	LOW	21.56	22.00
Band4	10	1750	16QAM	1	MID	21.49	22.00
Band4	10	1750	16QAM	1	HIGH	21.54	22.00
Band4	15	1717.5	QPSK	75	LOW	21.2	22.00

Band4	15	1717.5	QPSK	38	LOW	21.26	22.00
Band4	15	1717.5	QPSK	38	MID	21.21	22.00
Band4	15	1717.5	QPSK	38	HIGH	21.15	22.00
Band4	15	1717.5	QPSK	1	LOW	21.98	22.00
Band4	15	1717.5	QPSK	1	MID	22.08	23.00
Band4	15	1717.5	QPSK	1	HIGH	22.06	23.00
Band4	15	1717.5	16QAM	27	LOW	20.1	21.00
Band4	15	1717.5	16QAM	15	LOW	21.13	22.00
Band4	15	1717.5	16QAM	15	MID	21.07	22.00
Band4	15	1717.5	16QAM	15	HIGH	21.08	22.00
Band4	15	1717.5	16QAM	1	LOW	21.41	22.00
Band4	15	1717.5	16QAM	1	MID	21.83	22.00
Band4	15	1717.5	16QAM	1	HIGH	21.71	22.00
Band4	15	1732.5	QPSK	75	LOW	21.31	22.00
Band4	15	1732.5	QPSK	38	LOW	21.33	22.00
Band4	15	1732.5	QPSK	38	MID	21.29	22.00
Band4	15	1732.5	QPSK	38	HIGH	21.34	22.00
Band4	15	1732.5	QPSK	1	LOW	21.34	22.00
Band4	15	1732.5	QPSK	1	MID	22.13	23.00
Band4	15	1732.5	QPSK	1	HIGH	22.13	23.00
Band4	15	1732.5	16QAM	27	LOW	20.35	21.00
Band4	15	1732.5	16QAM	15	LOW	21.25	22.00
Band4	15	1732.5	16QAM	15	MID	21.3	22.00
Band4	15	1732.5	16QAM	15	HIGH	21.32	22.00
Band4	15	1732.5	16QAM	1	LOW	21.94	22.00
Band4	15	1732.5	16QAM	1	MID	22.07	23.00
Band4	15	1732.5	16QAM	1	HIGH	21.9	22.00
Band4	15	1747.5	QPSK	75	LOW	21.19	22.00
Band4	15	1747.5	QPSK	38	LOW	21.18	22.00
Band4	15	1747.5	QPSK	38	MID	21.15	22.00
Band4	15	1747.5	QPSK	38	HIGH	21.19	22.00
Band4	15	1747.5	QPSK	1	LOW	22.14	23.00
Band4	15	1747.5	QPSK	1	MID	22.11	23.00
Band4	15	1747.5	QPSK	1	HIGH	21.86	22.00
Band4	15	1747.5	16QAM	27	LOW	20.16	21.00
Band4	15	1747.5	16QAM	15	LOW	21.3	22.00
Band4	15	1747.5	16QAM	15	MID	21.26	22.00
Band4	15	1747.5	16QAM	15	HIGH	20.99	21.00
Band4	15	1747.5	16QAM	1	LOW	21.86	22.00
Band4	15	1747.5	16QAM	1	MID	21.75	22.00
Band4	15	1747.5	16QAM	1	HIGH	21.4	22.00
Band4	20	1720	QPSK	100	LOW	21.19	22.00

Band4	20	1720	QPSK	50	LOW	21.25	22.00
Band4	20	1720	QPSK	50	MID	21.27	22.00
Band4	20	1720	QPSK	50	HIGH	21.21	22.00
Band4	20	1720	QPSK	1	LOW	21.98	22.00
Band4	20	1720	QPSK	1	MID	22.68	23.00
Band4	20	1720	QPSK	1	HIGH	21.62	22.00
Band4	20	1720	16QAM	27	LOW	21.62	22.00
Band4	20	1720	16QAM	15	LOW	22.68	23.00
Band4	20	1720	16QAM	15	MID	22.75	23.00
Band4	20	1720	16QAM	15	HIGH	23.39	24.00
Band4	20	1720	16QAM	1	LOW	23.14	24.00
Band4	20	1720	16QAM	1	MID	23.74	24.00
Band4	20	1720	16QAM	1	HIGH	23.84	24.00
Band4	20	1732.5	QPSK	100	LOW	23.42	24.00

Band	Bandwidth(MHz)	UL Frequency(MHz)	Modulation	RB Size	RB Offset	Average Power	Tune-up limit (dBm)
Band5	1.4	824.7	QPSK	6	LOW	19.16	20.00
Band5	1.4	824.7	QPSK	3	LOW	20.15	21.00
Band5	1.4	824.7	QPSK	3	MID	20.16	21.00
Band5	1.4	824.7	QPSK	3	HIGH	20.22	21.00
Band5	1.4	824.7	QPSK	1	LOW	20	21.00
Band5	1.4	824.7	QPSK	1	MID	20.32	21.00
Band5	1.4	824.7	QPSK	1	HIGH	20.02	21.00
Band5	1.4	824.7	16QAM	6	LOW	18.23	19.00
Band5	1.4	824.7	16QAM	3	LOW	19.3	20.00
Band5	1.4	824.7	16QAM	3	MID	19.3	20.00
Band5	1.4	824.7	16QAM	3	HIGH	19.29	20.00
Band5	1.4	824.7	16QAM	1	LOW	19.31	20.00
Band5	1.4	824.7	16QAM	1	MID	19.6	20.00
Band5	1.4	824.7	16QAM	1	HIGH	19.35	20.00
Band5	1.4	836.5	QPSK	6	LOW	19.47	20.00
Band5	1.4	836.5	QPSK	3	LOW	20.5	21.00
Band5	1.4	836.5	QPSK	3	MID	20.52	21.00
Band5	1.4	836.5	QPSK	3	HIGH	20.45	21.00
Band5	1.4	836.5	QPSK	1	LOW	20.45	21.00
Band5	1.4	836.5	QPSK	1	MID	20.59	21.00
Band5	1.4	836.5	QPSK	1	HIGH	20.37	21.00
Band5	1.4	836.5	16QAM	6	LOW	18.5	19.00
Band5	1.4	836.5	16QAM	3	LOW	19.73	20.00
Band5	1.4	836.5	16QAM	3	MID	19.68	20.00
Band5	1.4	836.5	16QAM	3	HIGH	19.68	20.00
Band5	1.4	836.5	16QAM	1	LOW	19.55	20.00
Band5	1.4	836.5	16QAM	1	MID	19.75	20.00
Band5	1.4	836.5	16QAM	1	HIGH	19.55	20.00
Band5	1.4	848.3	QPSK	6	LOW	19.64	20.00
Band5	1.4	848.3	QPSK	3	LOW	20.7	21.00
Band5	1.4	848.3	QPSK	3	MID	20.59	21.00
Band5	1.4	848.3	QPSK	3	HIGH	20.67	21.00
Band5	1.4	848.3	QPSK	1	LOW	20.64	21.00
Band5	1.4	848.3	QPSK	1	MID	20.88	21.00
Band5	1.4	848.3	QPSK	1	HIGH	20.67	21.00
Band5	1.4	848.3	16QAM	6	LOW	18.81	19.00
Band5	1.4	848.3	16QAM	3	LOW	19.62	20.00
Band5	1.4	848.3	16QAM	3	MID	19.64	20.00
Band5	1.4	848.3	16QAM	3	HIGH	19.72	20.00
Band5	1.4	848.3	16QAM	1	LOW	19.7	20.00

Band5	1.4	848.3	16QAM	1	MID	19.88	20.00
Band5	1.4	848.3	16QAM	1	HIGH	19.65	20.00
Band5	3	825.5	QPSK	15	LOW	19.05	20.00
Band5	3	825.5	QPSK	8	LOW	19.08	20.00
Band5	3	825.5	QPSK	8	MID	19.07	20.00
Band5	3	825.5	QPSK	8	HIGH	19.12	20.00
Band5	3	825.5	QPSK	1	LOW	20.09	21.00
Band5	3	825.5	QPSK	1	MID	20.09	21.00
Band5	3	825.5	QPSK	1	HIGH	20.17	21.00
Band5	3	825.5	16QAM	15	LOW	18.18	19.00
Band5	3	825.5	16QAM	8	LOW	18.37	19.00
Band5	3	825.5	16QAM	8	MID	18.33	19.00
Band5	3	825.5	16QAM	8	HIGH	18.35	19.00
Band5	3	825.5	16QAM	1	LOW	19.71	20.00
Band5	3	825.5	16QAM	1	MID	19.75	20.00
Band5	3	825.5	16QAM	1	HIGH	19.86	20.00
Band5	3	836.5	QPSK	15	LOW	19.38	20.00
Band5	3	836.5	QPSK	8	LOW	19.37	20.00
Band5	3	836.5	QPSK	8	MID	19.4	20.00
Band5	3	836.5	QPSK	8	HIGH	19.43	20.00
Band5	3	836.5	QPSK	1	LOW	20.47	21.00
Band5	3	836.5	QPSK	1	MID	20.54	21.00
Band5	3	836.5	QPSK	1	HIGH	20.56	21.00
Band5	3	836.5	16QAM	15	LOW	18.44	19.00
Band5	3	836.5	16QAM	8	LOW	18.42	19.00
Band5	3	836.5	16QAM	8	MID	18.43	19.00
Band5	3	836.5	16QAM	8	HIGH	18.51	19.00
Band5	3	836.5	16QAM	1	LOW	19.59	20.00
Band5	3	836.5	16QAM	1	MID	19.59	20.00
Band5	3	836.5	16QAM	1	HIGH	19.61	20.00
Band5	3	847.5	QPSK	15	LOW	19.61	20.00
Band5	3	847.5	QPSK	8	LOW	19.62	20.00
Band5	3	847.5	QPSK	8	MID	19.61	20.00
Band5	3	847.5	QPSK	8	HIGH	19.61	20.00
Band5	3	847.5	QPSK	1	LOW	20.57	21.00
Band5	3	847.5	QPSK	1	MID	20.66	21.00
Band5	3	847.5	QPSK	1	HIGH	20.71	21.00
Band5	3	847.5	16QAM	15	LOW	18.7	19.00
Band5	3	847.5	16QAM	8	LOW	18.75	19.00
Band5	3	847.5	16QAM	8	MID	18.78	19.00
Band5	3	847.5	16QAM	8	HIGH	18.7	19.00
Band5	3	847.5	16QAM	1	LOW	19.82	20.00

Band5	3	847.5	16QAM	1	MID	19.81	20.00
Band5	3	847.5	16QAM	1	HIGH	19.8	20.00
Band5	5	826.5	QPSK	25	LOW	19.15	20.00
Band5	5	826.5	QPSK	12	LOW	19.06	20.00
Band5	5	826.5	QPSK	12	MID	19.09	20.00
Band5	5	826.5	QPSK	12	HIGH	19.16	20.00
Band5	5	826.5	QPSK	1	LOW	20.03	21.00
Band5	5	826.5	QPSK	1	MID	20.24	21.00
Band5	5	826.5	QPSK	1	HIGH	20.15	21.00
Band5	5	826.5	16QAM	25	LOW	18.21	19.00
Band5	5	826.5	16QAM	12	LOW	18.17	19.00
Band5	5	826.5	16QAM	12	MID	18.18	19.00
Band5	5	826.5	16QAM	12	HIGH	18.22	19.00
Band5	5	826.5	16QAM	1	LOW	19.05	20.00
Band5	5	826.5	16QAM	1	MID	19.28	20.00
Band5	5	826.5	16QAM	1	HIGH	19.15	20.00
Band5	5	836.5	QPSK	25	LOW	19.39	20.00
Band5	5	836.5	QPSK	12	LOW	19.34	20.00
Band5	5	836.5	QPSK	12	MID	19.36	20.00
Band5	5	836.5	QPSK	12	HIGH	19.38	20.00
Band5	5	836.5	QPSK	1	LOW	20.36	21.00
Band5	5	836.5	QPSK	1	MID	20.48	21.00
Band5	5	836.5	QPSK	1	HIGH	20.4	21.00
Band5	5	836.5	16QAM	25	LOW	18.49	19.00
Band5	5	836.5	16QAM	12	LOW	18.5	19.00
Band5	5	836.5	16QAM	12	MID	18.5	19.00
Band5	5	836.5	16QAM	12	HIGH	18.55	19.00
Band5	5	836.5	16QAM	1	LOW	19.63	20.00
Band5	5	836.5	16QAM	1	MID	19.75	20.00
Band5	5	836.5	16QAM	1	HIGH	19.69	20.00
Band5	5	846.5	QPSK	25	LOW	19.53	20.00
Band5	5	846.5	QPSK	12	LOW	19.58	20.00
Band5	5	846.5	QPSK	12	MID	19.57	20.00
Band5	5	846.5	QPSK	12	HIGH	19.49	20.00
Band5	5	846.5	QPSK	1	LOW	20.5	21.00
Band5	5	846.5	QPSK	1	MID	20.56	21.00
Band5	5	846.5	QPSK	1	HIGH	20.54	21.00
Band5	5	846.5	16QAM	25	LOW	18.58	19.00
Band5	5	846.5	16QAM	12	LOW	18.64	19.00
Band5	5	846.5	16QAM	12	MID	18.65	19.00
Band5	5	846.5	16QAM	12	HIGH	18.61	19.00
Band5	5	846.5	16QAM	1	LOW	19.59	20.00

Band5	5	846.5	16QAM	1	MID	19.63	20.00
Band5	5	846.5	16QAM	1	HIGH	19.52	20.00
Band5	10	829	QPSK	50	LOW	19.19	20.00
Band5	10	829	QPSK	12	LOW	20.13	21.00
Band5	10	829	QPSK	12	MID	20.13	21.00
Band5	10	829	QPSK	12	HIGH	20.29	21.00
Band5	10	829	QPSK	1	LOW	20.07	21.00
Band5	10	829	QPSK	1	MID	20.45	21.00
Band5	10	829	QPSK	1	HIGH	20.32	21.00
Band5	10	829	16QAM	27	LOW	18.37	19.00
Band5	10	829	16QAM	12	LOW	19.26	20.00
Band5	10	829	16QAM	12	MID	19.23	20.00
Band5	10	829	16QAM	12	HIGH	19.36	20.00
Band5	10	829	16QAM	1	LOW	19.35	20.00
Band5	10	829	16QAM	1	MID	19.77	20.00
Band5	10	829	16QAM	1	HIGH	19.52	20.00
Band5	10	836.5	QPSK	50	LOW	19.45	20.00
Band5	10	836.5	QPSK	25	LOW	19.48	20.00
Band5	10	836.5	QPSK	25	MID	19.44	20.00
Band5	10	836.5	QPSK	25	HIGH	19.46	20.00
Band5	10	836.5	QPSK	1	LOW	20.23	21.00
Band5	10	836.5	QPSK	1	MID	20.59	21.00
Band5	10	836.5	QPSK	1	HIGH	20.52	21.00
Band5	10	836.5	16QAM	27	LOW	18.51	19.00
Band5	10	836.5	16QAM	15	LOW	18.48	19.00
Band5	10	836.5	16QAM	15	MID	18.54	19.00
Band5	10	836.5	16QAM	15	HIGH	18.49	19.00
Band5	10	836.5	16QAM	1	LOW	19.94	20.00
Band5	10	836.5	16QAM	1	MID	20.18	21.00
Band5	10	836.5	16QAM	1	HIGH	20.03	21.00
Band5	10	844	QPSK	50	LOW	19.59	20.00
Band5	10	844	QPSK	25	LOW	19.67	20.00
Band5	10	844	QPSK	25	MID	19.68	20.00
Band5	10	844	QPSK	25	HIGH	19.56	20.00
Band5	10	844	QPSK	1	LOW	20.57	21.00
Band5	10	844	QPSK	1	MID	20.87	21.00
Band5	10	844	QPSK	1	HIGH	20.67	21.00
Band5	10	844	16QAM	27	LOW	18.77	19.00
Band5	10	844	16QAM	15	LOW	18.59	19.00
Band5	10	844	16QAM	15	MID	18.64	19.00
Band5	10	844	16QAM	15	HIGH	18.61	19.00
Band5	10	844	16QAM	1	LOW	19.66	20.00

Band5	10	844	16QAM	1	MID	20.01	21.00
Band5	10	844	16QAM	1	HIGH	19.7	20.00

Band	Bandwidth(MHz)	UL Frequency(MHz)	Modulation	RB Size	RB Offset	Average Power	Tune-up limit (dBm)
Band7	5	2502.5	QPSK	25	LOW	20.88	21.00
Band7	5	2502.5	QPSK	12	LOW	20.7	21.00
Band7	5	2502.5	QPSK	12	MID	20.74	21.00
Band7	5	2502.5	QPSK	12	HIGH	21.75	22.00
Band7	5	2502.5	QPSK	1	LOW	21.75	22.00
Band7	5	2502.5	QPSK	1	MID	21.88	22.00
Band7	5	2502.5	QPSK	1	HIGH	21.65	22.00
Band7	5	2502.5	16QAM	25	LOW	19.8	20.00
Band7	5	2502.5	16QAM	12	LOW	21.88	22.00
Band7	5	2502.5	16QAM	12	MID	21.65	22.00
Band7	5	2502.5	16QAM	12	HIGH	19.8	20.00
Band7	5	2502.5	16QAM	1	LOW	21	22.00
Band7	5	2502.5	16QAM	1	MID	20.89	21.00
Band7	5	2502.5	16QAM	1	HIGH	20.96	21.00
Band7	5	2535	QPSK	25	LOW	20.51	21.00
Band7	5	2535	QPSK	12	LOW	20.56	21.00
Band7	5	2535	QPSK	12	MID	20.58	21.00
Band7	5	2535	QPSK	12	HIGH	20.57	21.00
Band7	5	2535	QPSK	1	LOW	21.54	22.00
Band7	5	2535	QPSK	1	MID	21.64	22.00
Band7	5	2535	QPSK	1	HIGH	19.79	20.00
Band7	5	2535	16QAM	25	LOW	19.79	20.00
Band7	5	2535	16QAM	12	LOW	19.72	20.00
Band7	5	2535	16QAM	12	MID	19.73	20.00
Band7	5	2535	16QAM	12	HIGH	19.73	20.00
Band7	5	2535	16QAM	1	LOW	20.7	21.00
Band7	5	2535	16QAM	1	MID	20.75	21.00
Band7	5	2535	16QAM	1	HIGH	20.91	21.00
Band7	5	2567.5	QPSK	25	LOW	20.91	21.00
Band7	5	2567.5	QPSK	12	LOW	20.92	21.00
Band7	5	2567.5	QPSK	12	MID	20.91	21.00
Band7	5	2567.5	QPSK	12	HIGH	20.8	21.00
Band7	5	2567.5	QPSK	1	LOW	21.74	22.00
Band7	5	2567.5	QPSK	1	MID	21.89	22.00
Band7	5	2567.5	QPSK	1	HIGH	21.78	22.00
Band7	5	2567.5	16QAM	25	LOW	19.92	20.00
Band7	5	2567.5	16QAM	12	LOW	19.96	20.00
Band7	5	2567.5	16QAM	12	MID	19.94	20.00
Band7	5	2567.5	16QAM	12	HIGH	19.87	20.00
Band7	5	2567.5	16QAM	1	LOW	20.73	21.00

Band7	5	2567.5	16QAM	1	MID	20.84	21.00
Band7	5	2567.5	16QAM	1	HIGH	20.72	21.00
Band7	10	2505	QPSK	50	LOW	20.34	21.00
Band7	10	2505	QPSK	25	LOW	20.32	21.00
Band7	10	2505	QPSK	25	MID	20.3	21.00
Band7	10	2505	QPSK	25	HIGH	20.37	21.00
Band7	10	2505	QPSK	1	LOW	21.33	22.00
Band7	10	2505	QPSK	1	MID	21.57	22.00
Band7	10	2505	QPSK	1	HIGH	21.32	22.00
Band7	10	2505	16QAM	27	LOW	19.37	20.00
Band7	10	2505	16QAM	15	LOW	19.34	20.00
Band7	10	2505	16QAM	15	MID	19.33	20.00
Band7	10	2505	16QAM	15	HIGH	19.42	20.00
Band7	10	2505	16QAM	1	LOW	20.39	21.00
Band7	10	2505	16QAM	1	MID	20.75	21.00
Band7	10	2505	16QAM	1	HIGH	20.47	21.00
Band7	10	2535	QPSK	50	LOW	20.56	21.00
Band7	10	2535	QPSK	25	LOW	20.58	21.00
Band7	10	2535	QPSK	25	MID	20.59	21.00
Band7	10	2535	QPSK	25	HIGH	20.54	21.00
Band7	10	2535	QPSK	1	LOW	21.55	22.00
Band7	10	2535	QPSK	1	MID	21.72	22.00
Band7	10	2535	QPSK	1	HIGH	21.63	22.00
Band7	10	2535	16QAM	27	LOW	19.68	20.00
Band7	10	2535	16QAM	15	LOW	19.7	20.00
Band7	10	2535	16QAM	15	MID	19.74	20.00
Band7	10	2535	16QAM	15	HIGH	19.67	20.00
Band7	10	2535	16QAM	1	LOW	20.74	21.00
Band7	10	2535	16QAM	1	MID	20.98	21.00
Band7	10	2535	16QAM	1	HIGH	20.77	21.00
Band7	10	2565	QPSK	50	LOW	20.74	21.00
Band7	10	2565	QPSK	25	LOW	20.78	21.00
Band7	10	2565	QPSK	25	MID	20.83	21.00
Band7	10	2565	QPSK	25	HIGH	20.76	21.00
Band7	10	2565	QPSK	1	LOW	21.79	22.00
Band7	10	2565	QPSK	1	MID	22.12	23.00
Band7	10	2565	QPSK	1	HIGH	21.95	22.00
Band7	10	2565	16QAM	27	LOW	19.86	20.00
Band7	10	2565	16QAM	15	LOW	19.95	20.00
Band7	10	2565	16QAM	15	MID	19.95	20.00
Band7	10	2565	16QAM	15	HIGH	19.94	20.00
Band7	10	2565	16QAM	1	LOW	21.01	22.00

Band7	10	2565	16QAM	1	MID	21.16	22.00
Band7	10	2565	16QAM	1	HIGH	20.97	21.00
Band7	15	2507.5	QPSK	75	LOW	20.45	21.00
Band7	15	2507.5	QPSK	38	LOW	20.43	21.00
Band7	15	2507.5	QPSK	38	MID	20.55	21.00
Band7	15	2507.5	QPSK	38	HIGH	20.46	21.00
Band7	15	2507.5	QPSK	1	LOW	21.24	22.00
Band7	15	2507.5	QPSK	1	MID	21.38	22.00
Band7	15	2507.5	QPSK	1	HIGH	21.29	22.00
Band7	15	2507.5	16QAM	27	LOW	19.36	20.00
Band7	15	2507.5	16QAM	15	LOW	20.32	21.00
Band7	15	2507.5	16QAM	15	MID	20.31	21.00
Band7	15	2507.5	16QAM	15	HIGH	20.37	21.00
Band7	15	2507.5	16QAM	1	LOW	20.76	21.00
Band7	15	2507.5	16QAM	1	MID	20.9	21.00
Band7	15	2507.5	16QAM	1	HIGH	20.86	21.00
Band7	15	2535	QPSK	75	LOW	20.72	21.00
Band7	15	2535	QPSK	38	LOW	20.72	21.00
Band7	15	2535	QPSK	38	MID	20.66	21.00
Band7	15	2535	QPSK	38	HIGH	20.65	21.00
Band7	15	2535	QPSK	1	LOW	21.54	22.00
Band7	15	2535	QPSK	1	MID	21.71	22.00
Band7	15	2535	QPSK	1	HIGH	21.59	22.00
Band7	15	2535	16QAM	27	LOW	19.66	20.00
Band7	15	2535	16QAM	15	LOW	20.44	21.00
Band7	15	2535	16QAM	15	MID	20.49	21.00
Band7	15	2535	16QAM	15	HIGH	20.46	21.00
Band7	15	2535	16QAM	1	LOW	20.55	21.00
Band7	15	2535	16QAM	1	MID	20.68	21.00
Band7	15	2535	16QAM	1	HIGH	20.62	21.00
Band7	15	2562.5	QPSK	75	LOW	20.88	21.00
Band7	15	2562.5	QPSK	38	LOW	20.92	21.00
Band7	15	2562.5	QPSK	38	MID	20.91	21.00
Band7	15	2562.5	QPSK	38	HIGH	20.93	21.00
Band7	15	2562.5	QPSK	1	LOW	21.69	22.00
Band7	15	2562.5	QPSK	1	MID	21.94	22.00
Band7	15	2562.5	QPSK	1	HIGH	21.8	22.00
Band7	15	2562.5	16QAM	27	LOW	19.85	20.00
Band7	15	2562.5	16QAM	15	LOW	20.49	21.00
Band7	15	2562.5	16QAM	15	MID	20.74	21.00
Band7	15	2562.5	16QAM	15	HIGH	20.71	21.00
Band7	15	2562.5	16QAM	1	LOW	21.13	22.00

Band7	15	2562.5	16QAM	1	MID	21.24	22.00
Band7	15	2562.5	16QAM	1	HIGH	21.1	22.00
Band7	20	2510	QPSK	100	LOW	20.37	21.00
Band7	20	2510	QPSK	50	LOW	20.19	21.00
Band7	20	2510	QPSK	50	MID	20.3	21.00
Band7	20	2510	QPSK	50	HIGH	20.34	21.00
Band7	20	2510	QPSK	1	LOW	21.19	22.00
Band7	20	2510	QPSK	1	MID	21.84	22.00
Band7	20	2510	QPSK	1	HIGH	21.3	22.00
Band7	20	2510	16QAM	27	LOW	19.3	20.00
Band7	20	2510	16QAM	15	LOW	20.07	21.00
Band7	20	2510	16QAM	15	MID	20.09	21.00
Band7	20	2510	16QAM	15	HIGH	20.35	21.00
Band7	20	2510	16QAM	1	LOW	20.33	21.00
Band7	20	2510	16QAM	1	MID	20.77	21.00
Band7	20	2510	16QAM	1	HIGH	20.49	21.00
Band7	20	2535	QPSK	100	LOW	20.51	21.00
Band7	20	2535	QPSK	50	LOW	20.55	21.00
Band7	20	2535	QPSK	50	MID	20.55	21.00
Band7	20	2535	QPSK	50	HIGH	20.52	21.00
Band7	20	2535	QPSK	1	LOW	21.19	22.00
Band7	20	2535	QPSK	1	MID	21.73	22.00
Band7	20	2535	QPSK	1	HIGH	21.33	22.00
Band7	20	2535	16QAM	27	LOW	19.54	20.00
Band7	20	2535	16QAM	15	LOW	20.38	21.00
Band7	20	2535	16QAM	15	MID	20.42	21.00
Band7	20	2535	16QAM	15	HIGH	20.52	21.00
Band7	20	2535	16QAM	1	LOW	20.74	21.00
Band7	20	2535	16QAM	1	MID	21.31	22.00
Band7	20	2535	16QAM	1	HIGH	20.81	21.00
Band7	20	2560	QPSK	100	LOW	20.73	21.00
Band7	20	2560	QPSK	50	LOW	20.68	21.00
Band7	20	2560	QPSK	50	MID	20.67	21.00
Band7	20	2560	QPSK	50	HIGH	20.65	21.00
Band7	20	2560	QPSK	1	LOW	21.5	22.00
Band7	20	2560	QPSK	1	MID	21.95	22.00
Band7	20	2560	QPSK	1	HIGH	21.63	22.00
Band7	20	2560	16QAM	27	LOW	19.63	20.00
Band7	20	2560	16QAM	15	LOW	20.43	21.00
Band7	20	2560	16QAM	15	MID	20.55	21.00
Band7	20	2560	16QAM	15	HIGH	20.58	21.00
Band7	20	2560	16QAM	1	LOW	20.83	21.00

Band7	20	2560	16QAM	1	MID	21.21	22.00
Band7	20	2560	16QAM	1	HIGH	20.82	21.00

Band	Bandwidth(MHz)	UL Frequency(MHz)	Modulation	RB Size	RB Offset	Average Power	Tune-up limit (dBm)
Band38	5	2572.5	QPSK	25	LOW	21.52	22.00
Band38	5	2572.5	QPSK	12	LOW	21.31	22.00
Band38	5	2572.5	QPSK	12	MID	21.31	22.00
Band38	5	2572.5	QPSK	12	HIGH	21.66	22.00
Band38	5	2572.5	QPSK	1	LOW	22.52	23.00
Band38	5	2572.5	QPSK	1	MID	22.87	23.00
Band38	5	2572.5	QPSK	1	HIGH	22.95	23.00
Band38	5	2572.5	16QAM	25	LOW	20.74	21.00
Band38	5	2572.5	16QAM	12	LOW	20.59	21.00
Band38	5	2572.5	16QAM	12	MID	20.59	21.00
Band38	5	2572.5	16QAM	12	HIGH	20.81	21.00
Band38	5	2572.5	16QAM	1	LOW	21.35	22.00
Band38	5	2572.5	16QAM	1	MID	21.61	22.00
Band38	5	2572.5	16QAM	1	HIGH	21.8	22.00
Band38	5	2595	QPSK	25	LOW	21.93	22.00
Band38	5	2595	QPSK	12	LOW	21.93	22.00
Band38	5	2595	QPSK	12	MID	21.93	22.00
Band38	5	2595	QPSK	12	HIGH	21.96	22.00
Band38	5	2595	QPSK	1	LOW	23.14	24.00
Band38	5	2595	QPSK	1	MID	23.22	24.00
Band38	5	2595	QPSK	1	HIGH	23.18	24.00
Band38	5	2595	16QAM	25	LOW	21.09	22.00
Band38	5	2595	16QAM	12	LOW	21.09	22.00
Band38	5	2595	16QAM	12	MID	21.1	22.00
Band38	5	2595	16QAM	12	HIGH	21.12	22.00
Band38	5	2595	16QAM	1	LOW	22.37	23.00
Band38	5	2595	16QAM	1	MID	22.33	23.00
Band38	5	2595	16QAM	1	HIGH	22.34	23.00
Band38	5	2617.5	QPSK	25	LOW	22.02	23.00
Band38	5	2617.5	QPSK	12	LOW	22.05	23.00
Band38	5	2617.5	QPSK	12	MID	22.05	23.00
Band38	5	2617.5	QPSK	12	HIGH	22.07	23.00
Band38	5	2617.5	QPSK	1	LOW	23.32	24.00
Band38	5	2617.5	QPSK	1	MID	23.35	24.00
Band38	5	2617.5	QPSK	1	HIGH	23.32	24.00
Band38	5	2617.5	16QAM	25	LOW	21.19	22.00
Band38	5	2617.5	16QAM	12	LOW	21.2	22.00
Band38	5	2617.5	16QAM	12	MID	21.16	22.00
Band38	5	2617.5	16QAM	12	HIGH	21.18	22.00
Band38	5	2617.5	16QAM	1	LOW	22.41	23.00

Band38	5	2617.5	16QAM	1	MID	22.39	23.00
Band38	5	2617.5	16QAM	1	HIGH	22.46	23.00
Band38	10	2575	QPSK	50	LOW	21.8	22.00
Band38	10	2575	QPSK	25	LOW	21.54	22.00
Band38	10	2575	QPSK	25	MID	21.54	22.00
Band38	10	2575	QPSK	25	HIGH	21.77	22.00
Band38	10	2575	QPSK	1	LOW	22.66	23.00
Band38	10	2575	QPSK	1	MID	23.17	24.00
Band38	10	2575	QPSK	1	HIGH	23.04	24.00
Band38	10	2575	16QAM	27	LOW	20.65	21.00
Band38	10	2575	16QAM	15	LOW	20.59	21.00
Band38	10	2575	16QAM	15	MID	20.59	21.00
Band38	10	2575	16QAM	15	HIGH	20.88	21.00
Band38	10	2575	16QAM	1	LOW	21.94	22.00
Band38	10	2575	16QAM	1	MID	22.33	23.00
Band38	10	2575	16QAM	1	HIGH	22.49	23.00
Band38	10	2595	QPSK	50	LOW	22.01	23.00
Band38	10	2595	QPSK	25	LOW	21.98	22.00
Band38	10	2595	QPSK	25	MID	21.98	22.00
Band38	10	2595	QPSK	25	HIGH	22.02	23.00
Band38	10	2595	QPSK	1	LOW	23.25	24.00
Band38	10	2595	QPSK	1	MID	23.38	24.00
Band38	10	2595	QPSK	1	HIGH	23.27	24.00
Band38	10	2595	16QAM	27	LOW	21.1	22.00
Band38	10	2595	16QAM	15	LOW	20.89	21.00
Band38	10	2595	16QAM	15	MID	20.9	21.00
Band38	10	2595	16QAM	15	HIGH	20.95	21.00
Band38	10	2595	16QAM	1	LOW	22.31	23.00
Band38	10	2595	16QAM	1	MID	22.19	23.00
Band38	10	2595	16QAM	1	HIGH	22.31	23.00
Band38	10	2615	QPSK	50	LOW	22.04	23.00
Band38	10	2615	QPSK	25	LOW	22.04	23.00
Band38	10	2615	QPSK	25	MID	22.04	23.00
Band38	10	2615	QPSK	25	HIGH	22.05	23.00
Band38	10	2615	QPSK	1	LOW	23.27	24.00
Band38	10	2615	QPSK	1	MID	23.35	24.00
Band38	10	2615	QPSK	1	HIGH	23.25	24.00
Band38	10	2615	16QAM	27	LOW	21.21	22.00
Band38	10	2615	16QAM	15	LOW	20.98	21.00
Band38	10	2615	16QAM	15	MID	20.98	21.00
Band38	10	2615	16QAM	15	HIGH	21	22.00
Band38	10	2615	16QAM	1	LOW	22.56	23.00

Band38	10	2615	16QAM	1	MID	22.42	23.00
Band38	10	2615	16QAM	1	HIGH	22.56	23.00
Band38	15	2577.5	QPSK	75	LOW	22.03	23.00
Band38	15	2577.5	QPSK	38	LOW	22	23.00
Band38	15	2577.5	QPSK	38	MID	22	23.00
Band38	15	2577.5	QPSK	38	HIGH	22.09	23.00
Band38	15	2577.5	QPSK	1	LOW	22.89	23.00
Band38	15	2577.5	QPSK	1	MID	23.44	24.00
Band38	15	2577.5	QPSK	1	HIGH	23.41	24.00
Band38	15	2577.5	16QAM	25	LOW	20.82	21.00
Band38	15	2577.5	16QAM	15	LOW	21.58	22.00
Band38	15	2577.5	16QAM	15	MID	21.58	22.00
Band38	15	2577.5	16QAM	15	HIGH	22	23.00
Band38	15	2577.5	16QAM	1	LOW	21.83	22.00
Band38	15	2577.5	16QAM	1	MID	22.27	23.00
Band38	15	2577.5	16QAM	1	HIGH	22.33	23.00
Band38	15	2595	QPSK	75	LOW	22.18	23.00
Band38	15	2595	QPSK	38	LOW	22.22	23.00
Band38	15	2595	QPSK	38	MID	22.2	23.00
Band38	15	2595	QPSK	38	HIGH	22.16	23.00
Band38	15	2595	QPSK	1	LOW	23.38	24.00
Band38	15	2595	QPSK	1	MID	23.39	24.00
Band38	15	2595	QPSK	1	HIGH	23.41	24.00
Band38	15	2595	16QAM	25	LOW	21.18	22.00
Band38	15	2595	16QAM	15	LOW	22	23.00
Band38	15	2595	16QAM	15	MID	22	23.00
Band38	15	2595	16QAM	15	HIGH	22	23.00
Band38	15	2595	16QAM	1	LOW	22.42	23.00
Band38	15	2595	16QAM	1	MID	22.46	23.00
Band38	15	2595	16QAM	1	HIGH	22.5	23.00
Band38	15	2612.5	QPSK	75	LOW	22.21	23.00
Band38	15	2612.5	QPSK	38	LOW	22.26	23.00
Band38	15	2612.5	QPSK	38	MID	22.17	23.00
Band38	15	2612.5	QPSK	38	HIGH	23.37	24.00
Band38	15	2612.5	QPSK	1	LOW	23.37	24.00
Band38	15	2612.5	QPSK	1	MID	23.42	24.00
Band38	15	2612.5	QPSK	1	HIGH	23.37	24.00
Band38	15	2612.5	16QAM	25	LOW	21.24	22.00
Band38	15	2612.5	16QAM	15	LOW	22.09	23.00
Band38	15	2612.5	16QAM	15	MID	22.1	23.00
Band38	15	2612.5	16QAM	15	HIGH	22.11	23.00
Band38	15	2612.5	16QAM	1	LOW	22.43	23.00

Band38	15	2612.5	16QAM	1	MID	22.46	23.00
Band38	15	2612.5	16QAM	1	HIGH	22.46	23.00
Band38	20	2580	QPSK	100	LOW	22.08	23.00
Band38	20	2580	QPSK	50	LOW	21.92	22.00
Band38	20	2580	QPSK	50	MID	21.89	22.00
Band38	20	2580	QPSK	50	HIGH	22.02	23.00
Band38	20	2580	QPSK	1	LOW	23.24	24.00
Band38	20	2580	QPSK	1	MID	23.27	24.00
Band38	20	2580	QPSK	1	HIGH	23.2	24.00
Band38	20	2580	16QAM	27	LOW	20.82	21.00
Band38	20	2580	16QAM	15	LOW	21.59	22.00
Band38	20	2580	16QAM	15	MID	21.68	22.00
Band38	20	2580	16QAM	15	HIGH	21.71	22.00
Band38	20	2580	16QAM	1	LOW	21.83	22.00
Band38	20	2580	16QAM	1	MID	22.5	23.00
Band38	20	2580	16QAM	1	HIGH	22.49	23.00
Band38	20	2595	QPSK	100	LOW	22.05	23.00
Band38	20	2595	QPSK	50	LOW	22.09	23.00
Band38	20	2595	QPSK	50	MID	22.06	23.00
Band38	20	2595	QPSK	50	HIGH	22.12	23.00
Band38	20	2595	QPSK	1	LOW	23.24	24.00
Band38	20	2595	QPSK	1	MID	23.41	24.00
Band38	20	2595	QPSK	1	HIGH	23.33	24.00
Band38	20	2595	16QAM	27	LOW	21.06	22.00
Band38	20	2595	16QAM	15	LOW	22.07	23.00
Band38	20	2595	16QAM	15	MID	22.06	23.00
Band38	20	2595	16QAM	15	HIGH	22.08	23.00
Band38	20	2595	16QAM	1	LOW	22.43	23.00
Band38	20	2595	16QAM	1	MID	22.54	23.00
Band38	20	2595	16QAM	1	HIGH	22.42	23.00
Band38	20	2610	QPSK	100	LOW	22.12	23.00
Band38	20	2610	QPSK	50	LOW	22.12	23.00
Band38	20	2610	QPSK	50	MID	22.12	23.00
Band38	20	2610	QPSK	50	HIGH	22.13	23.00
Band38	20	2610	QPSK	1	LOW	23.22	24.00
Band38	20	2610	QPSK	1	MID	23.38	24.00
Band38	20	2610	QPSK	1	HIGH	23.33	24.00
Band38	20	2610	16QAM	27	LOW	21.12	22.00
Band38	20	2610	16QAM	15	LOW	22.05	23.00
Band38	20	2610	16QAM	15	MID	22.09	23.00
Band38	20	2610	16QAM	15	HIGH	22.01	23.00
Band38	20	2610	16QAM	1	LOW	22.36	23.00

Band38	20	2610	16QAM	1	MID	22.52	23.00
Band38	20	2610	16QAM	1	HIGH	22.52	23.00

Band	Bandwidth(MHz)	UL Frequency(MHz)	Modulation	RB Size	RB Offset	Average Power	Tune-up limit (dBm)
Band41	5	2498.5	QPSK	25	LOW	23.19	24.00
Band41	5	2498.5	QPSK	12	LOW	24.35	25.00
Band41	5	2498.5	QPSK	12	MID	24.25	25.00
Band41	5	2498.5	QPSK	12	HIGH	24.34	25.00
Band41	5	2498.5	QPSK	1	LOW	24.15	25.00
Band41	5	2498.5	QPSK	1	MID	23.36	24.00
Band41	5	2498.5	QPSK	1	HIGH	23.29	24.00
Band41	5	2498.5	16QAM	25	LOW	23.33	24.00
Band41	5	2498.5	16QAM	12	LOW	24.16	25.00
Band41	5	2498.5	16QAM	12	MID	24.33	25.00
Band41	5	2498.5	16QAM	12	HIGH	24.39	25.00
Band41	5	2498.5	16QAM	1	LOW	24.47	25.00
Band41	5	2498.5	16QAM	1	MID	24.56	25.00
Band41	5	2498.5	16QAM	1	HIGH	24.32	25.00
Band41	5	2593	QPSK	25	LOW	24.47	25.00
Band41	5	2593	QPSK	12	LOW	23.94	24.00
Band41	5	2593	QPSK	12	MID	23.95	24.00
Band41	5	2593	QPSK	12	HIGH	23.89	24.00
Band41	5	2593	QPSK	1	LOW	23.82	24.00
Band41	5	2593	QPSK	1	MID	23.95	24.00
Band41	5	2593	QPSK	1	HIGH	23.85	24.00
Band41	5	2593	16QAM	25	LOW	23.92	24.00
Band41	5	2593	16QAM	12	LOW	24.06	25.00
Band41	5	2593	16QAM	12	MID	24.06	25.00
Band41	5	2593	16QAM	12	HIGH	24.12	25.00
Band41	5	2593	16QAM	1	LOW	24.23	25.00
Band41	5	2593	16QAM	1	MID	24.39	25.00
Band41	5	2593	16QAM	1	HIGH	24.33	25.00
Band41	5	2687.5	QPSK	25	LOW	24.87	25.00
Band41	5	2687.5	QPSK	12	LOW	24.95	25.00
Band41	5	2687.5	QPSK	12	MID	24.85	25.00
Band41	5	2687.5	QPSK	12	HIGH	24.96	25.00
Band41	5	2687.5	QPSK	1	LOW	24.87	25.00
Band41	5	2687.5	QPSK	1	MID	24.92	25.00
Band41	5	2687.5	QPSK	1	HIGH	24.77	25.00
Band41	5	2687.5	16QAM	25	LOW	24.89	25.00
Band41	5	2687.5	16QAM	12	LOW	24.89	25.00
Band41	5	2687.5	16QAM	12	MID	24.99	25.00
Band41	5	2687.5	16QAM	12	HIGH	24.95	25.00
Band41	5	2687.5	16QAM	1	LOW	24.96	25.00

Band41	5	2687.5	16QAM	1	MID	25.02	25.50
Band41	5	2687.5	16QAM	1	HIGH	24.95	25.00
Band41	10	2501	QPSK	50	LOW	24.08	25.00
Band41	10	2501	QPSK	25	LOW	24.2	25.00
Band41	10	2501	QPSK	25	MID	24.22	25.00
Band41	10	2501	QPSK	25	HIGH	24.33	25.00
Band41	10	2501	QPSK	1	LOW	24.24	25.00
Band41	10	2501	QPSK	1	MID	24.53	25.00
Band41	10	2501	QPSK	1	HIGH	24.3	25.00
Band41	10	2501	16QAM	27	LOW	24.36	25.00
Band41	10	2501	16QAM	15	LOW	24.19	25.00
Band41	10	2501	16QAM	15	MID	24.18	25.00
Band41	10	2501	16QAM	15	HIGH	24.16	25.00
Band41	10	2501	16QAM	1	LOW	24.51	25.00
Band41	10	2501	16QAM	1	MID	24.9	25.00
Band41	10	2501	16QAM	1	HIGH	24.63	25.00
Band41	10	2593	QPSK	50	LOW	24.41	25.00
Band41	10	2593	QPSK	25	LOW	24.37	25.00
Band41	10	2593	QPSK	25	MID	24.4	25.00
Band41	10	2593	QPSK	25	HIGH	24.45	25.00
Band41	10	2593	QPSK	1	LOW	24.31	25.00
Band41	10	2593	QPSK	1	MID	24.57	25.00
Band41	10	2593	QPSK	1	HIGH	24.37	25.00
Band41	10	2593	16QAM	27	LOW	24.54	25.00
Band41	10	2593	16QAM	15	LOW	24.26	25.00
Band41	10	2593	16QAM	15	MID	24.25	25.00
Band41	10	2593	16QAM	15	HIGH	24.37	25.00
Band41	10	2593	16QAM	1	LOW	24.57	25.00
Band41	10	2593	16QAM	1	MID	24.89	25.00
Band41	10	2593	16QAM	1	HIGH	24.65	25.00
Band41	10	2685	QPSK	50	LOW	25.26	25.50
Band41	10	2685	QPSK	25	LOW	25.25	25.50
Band41	10	2685	QPSK	25	MID	25.28	25.50
Band41	10	2685	QPSK	25	HIGH	25.25	25.50
Band41	10	2685	QPSK	1	LOW	25.43	25.50
Band41	10	2685	QPSK	1	MID	25.59	25.70
Band41	10	2685	QPSK	1	HIGH	25.33	25.50
Band41	10	2685	16QAM	27	LOW	25.23	25.50
Band41	10	2685	16QAM	15	LOW	25.16	25.50
Band41	10	2685	16QAM	15	MID	25.22	25.50
Band41	10	2685	16QAM	15	HIGH	25.16	25.50
Band41	10	2685	16QAM	1	LOW	25.35	25.50

Band41	10	2685	16QAM	1	MID	25.5	25.70
Band41	10	2685	16QAM	1	HIGH	25.25	25.50
Band41	15	2503.5	QPSK	75	LOW	24.53	25.00
Band41	15	2503.5	QPSK	38	LOW	24.51	25.00
Band41	15	2503.5	QPSK	38	MID	24.53	25.00
Band41	15	2503.5	QPSK	38	HIGH	24.5	25.00
Band41	15	2503.5	QPSK	1	LOW	24.24	25.00
Band41	15	2503.5	QPSK	1	MID	24.48	25.00
Band41	15	2503.5	QPSK	1	HIGH	24.4	25.00
Band41	15	2503.5	16QAM	27	LOW	24.44	25.00
Band41	15	2503.5	16QAM	15	LOW	24.25	25.00
Band41	15	2503.5	16QAM	15	MID	24.26	25.00
Band41	15	2503.5	16QAM	15	HIGH	24.39	25.00
Band41	15	2503.5	16QAM	1	LOW	24.52	25.00
Band41	15	2503.5	16QAM	1	MID	24.7	25.00
Band41	15	2503.5	16QAM	1	HIGH	24.68	25.00
Band41	15	2593	QPSK	75	LOW	24.53	25.00
Band41	15	2593	QPSK	38	LOW	24.45	25.00
Band41	15	2593	QPSK	38	MID	24.43	25.00
Band41	15	2593	QPSK	38	HIGH	24.44	25.00
Band41	15	2593	QPSK	1	LOW	24.31	25.00
Band41	15	2593	QPSK	1	MID	24.57	25.00
Band41	15	2593	QPSK	1	HIGH	24.5	25.00
Band41	15	2593	16QAM	27	LOW	24.37	25.00
Band41	15	2593	16QAM	15	LOW	24.19	25.00
Band41	15	2593	16QAM	15	MID	24.21	25.00
Band41	15	2593	16QAM	15	HIGH	24.31	25.00
Band41	15	2593	16QAM	1	LOW	24.31	25.00
Band41	15	2593	16QAM	1	MID	24.43	25.00
Band41	15	2593	16QAM	1	HIGH	24.4	25.00
Band41	15	2682.5	QPSK	75	LOW	25.4	25.50
Band41	15	2682.5	QPSK	38	LOW	25.45	25.50
Band41	15	2682.5	QPSK	38	MID	25.42	25.50
Band41	15	2682.5	QPSK	38	HIGH	25.42	25.50
Band41	15	2682.5	QPSK	1	LOW	25.22	25.50
Band41	15	2682.5	QPSK	1	MID	25.39	25.50
Band41	15	2682.5	QPSK	1	HIGH	25.17	25.50
Band41	15	2682.5	16QAM	27	LOW	25.19	25.50
Band41	15	2682.5	16QAM	15	LOW	25.24	25.50
Band41	15	2682.5	16QAM	15	MID	25.22	25.50
Band41	15	2682.5	16QAM	15	HIGH	25.14	25.50
Band41	15	2682.5	16QAM	1	LOW	25.34	25.50

Band41	15	2682.5	16QAM	1	MID	25.48	25.50
Band41	15	2682.5	16QAM	1	HIGH	25.3	25.50
Band41	20	2506	QPSK	100	LOW	24.41	25.00
Band41	20	2506	QPSK	50	LOW	24.34	25.00
Band41	20	2506	QPSK	50	MID	24.36	25.00
Band41	20	2506	QPSK	50	HIGH	24.45	25.00
Band41	20	2506	QPSK	1	LOW	24.09	25.00
Band41	20	2506	QPSK	1	MID	24.72	25.00
Band41	20	2506	QPSK	1	HIGH	24.23	25.00
Band41	20	2506	16QAM	27	LOW	24.32	25.00
Band41	20	2506	16QAM	15	LOW	24.21	25.00
Band41	20	2506	16QAM	15	MID	24.22	25.00
Band41	20	2506	16QAM	15	HIGH	24.2	25.00
Band41	20	2506	16QAM	1	LOW	24.2	25.00
Band41	20	2506	16QAM	1	MID	24.8	25.00
Band41	20	2506	16QAM	1	HIGH	24.33	25.00
Band41	20	2593	QPSK	100	LOW	24.44	25.00
Band41	20	2593	QPSK	50	LOW	24.33	25.00
Band41	20	2593	QPSK	50	MID	24.43	25.00
Band41	20	2593	QPSK	50	HIGH	24.44	25.00
Band41	20	2593	QPSK	1	LOW	24.02	25.00
Band41	20	2593	QPSK	1	MID	24.67	25.00
Band41	20	2593	QPSK	1	HIGH	24.27	25.00
Band41	20	2593	16QAM	27	LOW	24.36	25.00
Band41	20	2593	16QAM	15	LOW	24.17	25.00
Band41	20	2593	16QAM	15	MID	24.08	25.00
Band41	20	2593	16QAM	15	HIGH	24.31	25.00
Band41	20	2593	16QAM	1	LOW	24.31	25.00
Band41	20	2593	16QAM	1	MID	24.87	25.00
Band41	20	2593	16QAM	1	HIGH	24.48	25.00
Band41	20	2680	QPSK	100	LOW	25.27	25.50
Band41	20	2680	QPSK	50	LOW	25.25	25.50
Band41	20	2680	QPSK	50	MID	25.26	25.50
Band41	20	2680	QPSK	50	HIGH	25.25	25.50
Band41	20	2680	QPSK	1	LOW	25.14	25.50
Band41	20	2680	QPSK	1	MID	25.6	25.70
Band41	20	2680	QPSK	1	HIGH	25.03	25.50
Band41	20	2680	16QAM	27	LOW	25.29	25.50
Band41	20	2680	16QAM	15	LOW	24.15	25.00
Band41	20	2680	16QAM	15	MID	25.13	25.50
Band41	20	2680	16QAM	15	HIGH	25.05	25.50
Band41	20	2680	16QAM	1	LOW	24.25	25.00

Band41	20	2680	16QAM	1	MID	25.57	25.70
Band41	20	2680	16QAM	1	HIGH	25.05	25.50

10.2 Transmit Antennas(Front View)

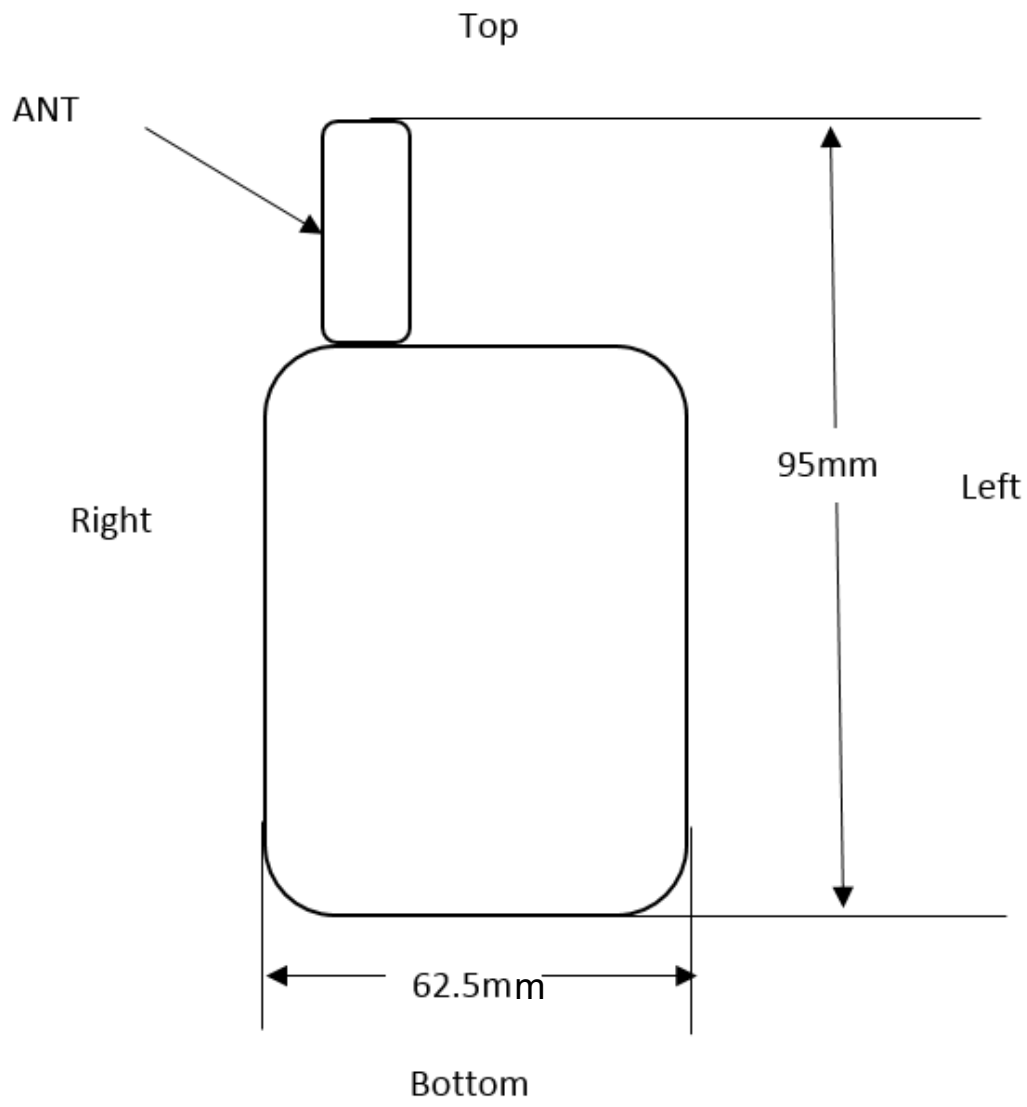

10.3 SAR Test Results

General Note:

- 1 Per KDB 447498 D01v06, the reported SAR is the measured SAR value adjusted for maximum tune-up tolerance.
 - a) Tune-up scaling Factor = tune-up limit power (mW) / EUT RF power (mW), where tune-up limit is the maximum rated power among all production units.
 - b) For SAR testing of WLAN signal with non-100% duty cycle, the measured SAR is scaled-up by the duty cycle scaling factor which is equal to "1/(duty cycle)"
 - c) For WLAN/Bluetooth: Reported SAR(W/kg)= Measured SAR(W/kg)* Duty Cycle scaling factor * Tune-up scaling factor
- 2 Per KDB 447498 D01v06, for each exposure position, testing of other required channels within the operating mode of a frequency band is not required when the reported 1-g or 10-g SAR for the mid-band or highest output power channel is:
 - ≤ 0.8 W/kg or 2.0 W/kg, for 1-g or 10-g respectively, when the transmission band is ≤ 100 MHz
 - ≤ 0.6 W/kg or 1.5 W/kg, for 1-g or 10-g respectively, when the transmission band is between 100 MHz and 200 MHz
 - ≤ 0.4 W/kg or 1.0 W/kg, for 1-g or 10-g respectively, when the transmission band is ≥ 200 MHz
- 3 Per KDB 865664 D01v01r04, for each frequency band, repeated SAR measurement is required only when the measured SAR is ≥ 0.8 W/kg.

<Body SAR>

SAR Values [LTE Band 2]

Plot No.	Mode	Test Position	Ch.	Freq. (MHz)	Average Power (dBm)	Tune-Up Limit (dBm)	Scaling Factor	Power Drift (dB)	Measured SAR1g (W/kg)	Reported SAR1g (W/kg)
Measured / Reported SAR numbers										
#1	20MHz/1RB#LOW	Front of face(25mm)	18700	1860	25.08	25.50	1.102	0.18	0.119	0.131
#2	20MHz/1RB#LOW	Body worn(0mm)	18700	1860	25.08	25.50	1.102	-0.11	0.512	0.564

SAR Values [LTE Band 4]

Plot No.	Mode	Test Position	Ch.	Freq. (MHz)	Average Power (dBm)	Tune-Up Limit (dBm)	Scaling Factor	Power Drift (dB)	Measured SAR1g (W/kg)	Reported SAR1g (W/kg)
Measured / Reported SAR numbers										
#3	20MHz/1RB# HIGH	Front of face(25mm)	20050	1720	23.84	24.00	1.038	-0.17	0.135	0.140
#4	20MHz/1RB# HIGH	Body worn(0mm)	20050	1720	23.84	24.00	1.038	-0.16	0.545	0.565

SAR Values [LTE Band 5]

Plot No.	Mode	Test Position	Ch.	Freq. (MHz)	Average Power (dBm)	Tune-Up Limit (dBm)	Scaling Factor	Power Drift (dB)	Measured SAR1g (W/kg)	Reported SAR1g (W/kg)
Measured / Reported SAR numbers										
#5	10MHz/1RB#MID	Front of face(25mm)	20600	844	20.87	21.00	1.030	-0.17	0.060	0.062
#6	10MHz/1RB#MID	Body worn(0mm)	20600	844	20.87	21.00	1.030	-0.11	0.332	0.342

SAR Values [LTE Band 7]

Plot No.	Mode	Test Position	Ch.	Freq. (MHz)	Average Power (dBm)	Tune-Up Limit (dBm)	Scaling Factor	Power Drift (dB)	Measured SAR1g (W/kg)	Reported SAR1g (W/kg)
Measured / Reported SAR numbers										
#7	10MHz/1RB#MID	Front of face(25mm)	21400	2565	22.12	23.00	1.225	-0.02	0.326	0.399
#8	10MHz/1RB#MID	Body worn(0mm)	21400	2565	22.12	23.00	1.225	0.15	0.652	0.798

SAR Values [LTE Band 38]

Plot No.	Mode	Test Position	Ch.	Freq. (MHz)	Average Power (dBm)	Tune-Up Limit (dBm)	Scaling Factor	Power Drift (dB)	Measured SAR1g (W/kg)	Reported SAR1g (W/kg)
Measured / Reported SAR numbers										
#9	20MHz/1RB#MID	Front of face(25mm)	38000	2595	23.41	24.00	1.146	0.13	0.288	0.330
#10	20MHz/1RB#MID	Body worn(0mm)	38000	2595	23.41	24.00	1.146	0.08	0.659	0.755

SAR Values [LTE Band 41]

Plot No.	Mode	Test Position	Ch.	Freq. (MHz)	Average Power (dBm)	Tune-Up Limit (dBm)	Scaling Factor	Power Drift (dB)	Measured SAR1g (W/kg)	Reported SAR1g (W/kg)
Measured / Reported SAR numbers										
#11	20MHz/1RB#MID	Front of face(25mm)	41490	2680	25.60	25.70	1.023	-0.16	0.432	0.442
#12	20MHz/1RB#MID	Body worn(0mm)	41490	2680	25.60	25.70	1.023	-0.07	0.781	0.799

Appendix A. EUT Photos and Test Setup Photos

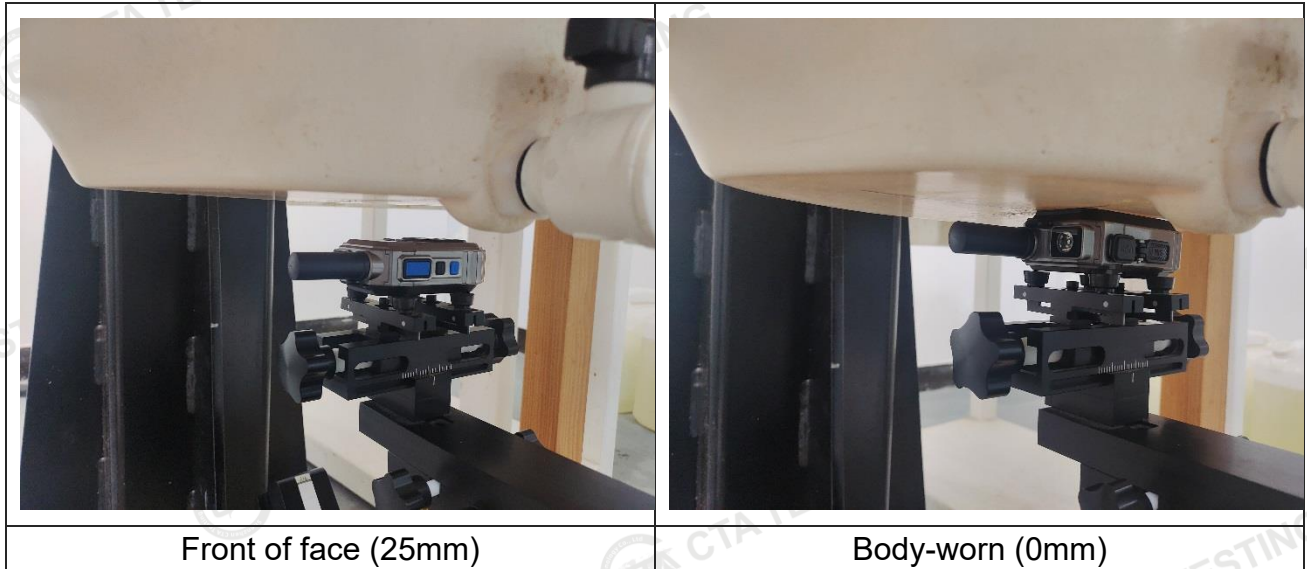

Appendix B. Plots of SAR System Check

835MHz System Check

Date: 08/20/2024

DUT: Dipole 835 MHz; Type: D835V2; Serial: 484

Communication System: CW; Frequency: 835 MHz; Duty Cycle: 1:1

Medium parameters used: $f = 835 \text{ MHz}$; $\sigma = 0.875 \text{ S/m}$; $\epsilon_r = 39.878$; $\rho = 1000 \text{ kg/m}^3$

Phantom section: Flat Section

DASY5 Configuration:

- Probe: EX3DV4 – SN7624; ConvF(10.19, 10.19, 10.19); Calibrated: Sep. 06, 2023;
- Sensor-Surface: 2mm (Mechanical Surface Detection)
- Electronics: DAE3 Sn428; Calibrated: 08/30/2023
- Phantom: Twin-SAM V8.0 ; Type: QD 000 P41 AA; Serial: 1974
- DASY52 52.10.2(1495); SEMCAD X 14.6.12(7450)

Area Scan (5x18x1): Measured grid: $dx=15 \text{ mm}$, $dy=15 \text{ mm}$

Maximum value of SAR (measured) = 4.23 W/kg

Zoom Scan (5x5x7)/Cube 0: Measurement grid: $dx=8\text{mm}$, $dy=8\text{mm}$, $dz=5\text{mm}$

Reference Value = 63.52 V/m; Power Drift = -0.18 dB

Peak SAR (extrapolated) = 2.15 W/kg

SAR(1 g) = 2.22 W/kg; SAR(10 g) = 1.52 W/kg

Maximum value of SAR (measured) = 4.11 W/kg

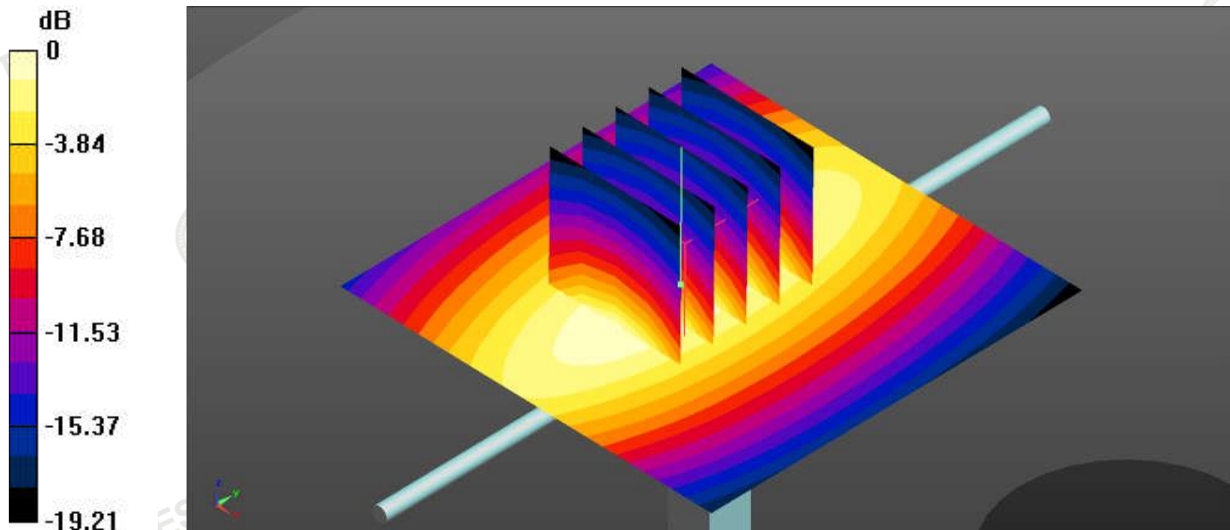

0 dB = 4.11 W/kg

System Performance Check 835MHz 250mW

1800 MHz System Check

Date: 08/23/2024

DUT: Dipole 1800 MHz; Type: D1800V2; Serial: 2d158

Communication System: CW; Frequency: 1800 MHz; Duty Cycle: 1:1

Medium parameters used: $f = 1800$ MHz; $\sigma = 1.332$ S/m; $\epsilon_r = 39.125$; $\rho = 1000$ kg/m³

Phantom section: Flat Section

DASY5 Configuration:

- Probe: EX3DV4 - SN7624; ConvF(8.66, 8.66, 8.66); Calibrated: Sep. 06, 2023
- Sensor-Surface: 2mm (Mechanical Surface Detection)
- Electronics: DAE3 Sn428; Calibrated: 08/30/2023
- Phantom: Twin-SAM V8.0 ; Type: QD 000 P41 AA; Serial: 1974
- DASY52 52.10.2(1495); SEMCAD X 14.6.12(7450)

Area Scan (6x10x1): Measured grid: dx=15 mm, dy=15 mm

Maximum value of SAR (measured) = 11.5 W/kg

Zoom Scan (5x5x7)/Cube 0: Measurement grid: dx=8mm, dy=8mm, dz=5mm

Reference Value = 96.23 V/m; Power Drift = -0.01 dB

Peak SAR (extrapolated) = 21.3 W/kg

SAR(1 g) = 9.52 W/kg; SAR(10 g) = 5.22 W/kg

Maximum value of SAR (measured) = 10.8 W/kg

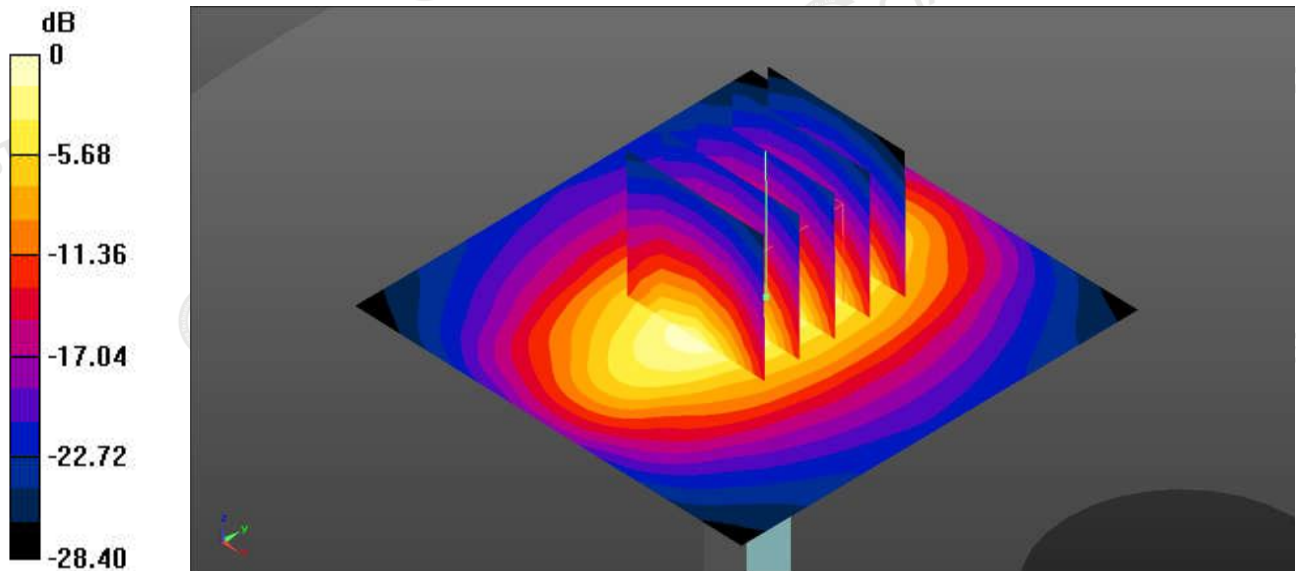

0 dB = 10.8 W/kg

System Performance Check 1800MHz 250mW

DUT: Dipole 1900 MHz; Type: D1900V2; Serial: 5d002

Communication System: CW; Frequency: 1900 MHz; Duty Cycle: 1:1

Medium parameters used: $f = 1900$ MHz; $\sigma = 1.382$ S/m; $\epsilon_r = 41.325$; $\rho = 1000$ kg/m³

Phantom section: Flat Section

DASY5 Configuration:

- Probe: EX3DV4 - SN7624; ConvF(8.35, 8.35, 8.35); Calibrated: Sep. 06, 2023
- Sensor-Surface: 2mm (Mechanical Surface Detection)
- Electronics: DAE3 Sn428; Calibrated: 08/30/2023
- Phantom: Twin-SAM V8.0 ; Type: QD 000 P41 AA; Serial: 1974
- DASY52 52.10.2(1495); SEMCAD X 14.6.12(7450)

Area Scan (6x10x1): Measurement grid: dx=15 mm, dy=15 mm

Maximum value of SAR (measured) = 11.9 W/kg

Zoom Scan (5x5x7)/Cube 0: Measurement grid: dx=8mm, dy=8mm, dz=5mm

Reference Value = 54.21 V/m; Power Drift = -0.17 dB

Peak SAR (extrapolated) = 16.8 W/kg

SAR(1 g) = 9.74 W/kg; SAR(10 g) = 5.44 W/kg

Maximum value of SAR (measured) = 11.2 W/kg

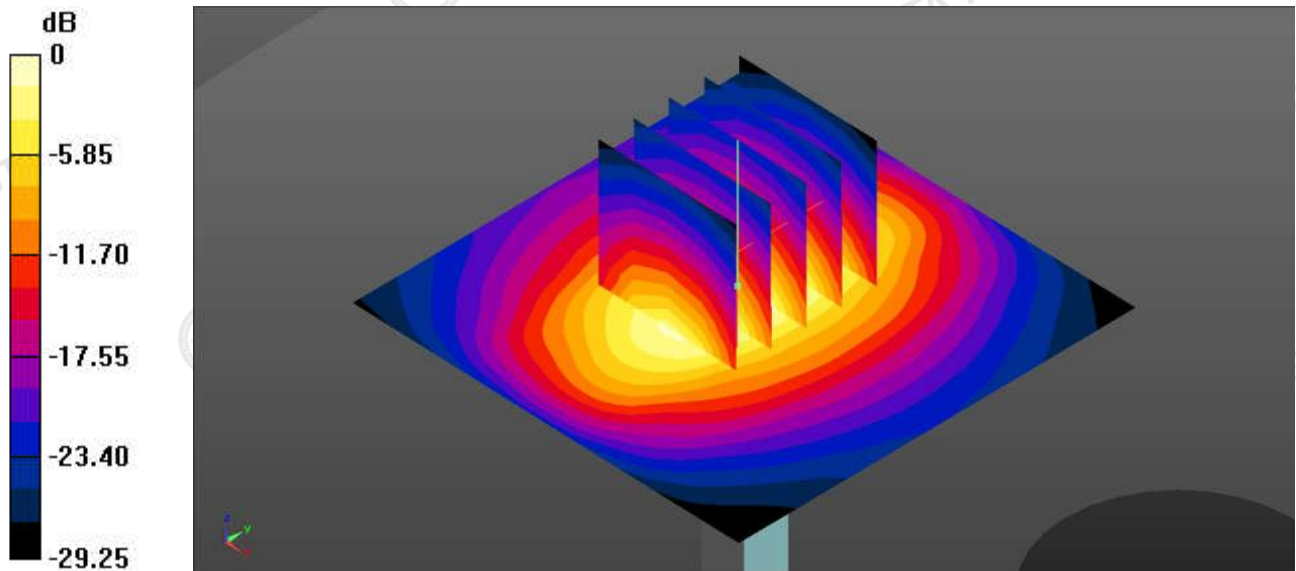

0 dB = 11.2 W/kg

System Performance Check 1900MHz 250mW

DUT: Dipole 2600 MHz; Type: D2600V2; Serial: 1073

Communication System: CW; Frequency: 2600 MHz; Duty Cycle: 1:1

Medium parameters used: $f = 2600$ MHz; $\sigma = 1.885$ S/m; $\epsilon_r = 40.125$; $\rho = 1000$ kg/m³

Phantom section: Flat Section

DASY5 Configuration:

- Probe: EX3DV4 - SN7624; ConvF(7.66, 7.66, 7.66); Calibrated: Sep. 06, 2023
- Sensor-Surface: 2mm (Mechanical Surface Detection)
- Electronics: DAE3 Sn428; Calibrated: 08/30/2023
- Phantom: Twin-SAM V8.0 ; Type: QD 000 P41 AA; Serial: 1974
- DASY52 52.10.2(1495); SEMCAD X 14.6.12(7450)

Area Scan (4x8x1): Measurement grid: dx=12 mm, dy=12 mm

Maximum value of SAR (measured) = 23.9 W/kg

Zoom Scan (7x7x7)/Cube 0: Measurement grid: dx=5mm, dy=5mm, dz=5mm

Reference Value = 77.85 V/m; Power Drift = -0.09 dB

Peak SAR (extrapolated) = 11.3 W/kg

SAR(1 g) = 13.98 W/kg; SAR(10 g) = 5.98 W/kg

Maximum value of SAR (measured) = 22.7 W/kg

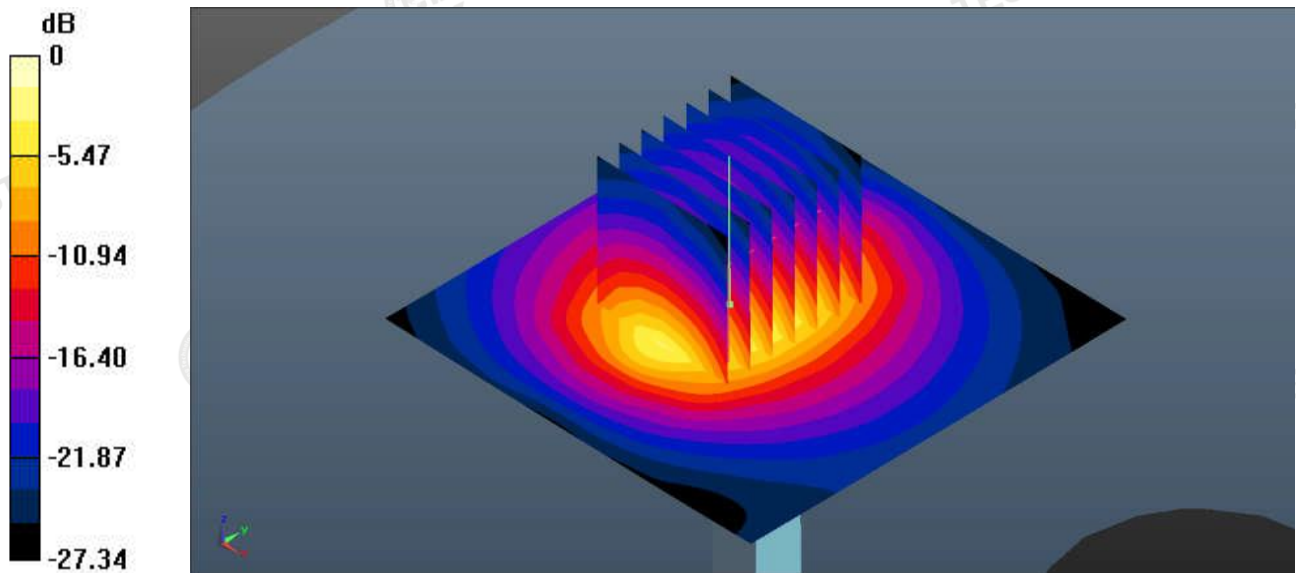

0 dB = 22.7 W/kg

System Performance Check 2600MHz 250mW

Appendix C. Plots of SAR Test Data

#1

Date: 08/26/2024

LTE Band 2_20MHz/1RB#LOW _ Front of face _25mm _Ch18700

Communication System: UID 0, Generic LTE (0); Frequency: 1860 MHz; Duty Cycle: 1:1

Medium parameters used: $f = 1860$ MHz; $\sigma = 1.465$ S/m; $\epsilon_r = 40.658$; $\rho = 1000$ kg/m³

Phantom section: Flat Section

DASY5 Configuration:

- Probe: EX3DV4 - SN7624; ConvF(8.35, 8.35, 8.35); Calibrated: Sep. 06, 2023
- Sensor-Surface: 2mm (Mechanical Surface Detection)
- Electronics: DAE3 Sn428; Calibrated: 08/30/2023
- Phantom: Twin-SAM V8.0 ; Type: QD 000 P41 AA; Serial: 1974
- DASY52 52.10.2(1495); SEMCAD X 14.6.12(7450)

Front /Area Scan (8x13x1): Measurement grid: dx=15 mm, dy=15 mm

Maximum value of SAR (measured) = 0.298 W/kg

Front /Zoom Scan (5x5x7)/Cube 0: Measurement grid: dx=8mm, dy=8mm, dz=5mm

Reference Value = 7.125V/m; Power Drift = 0.18 dB

Peak SAR (extrapolated) = 1.56 W/kg

SAR(1 g) = 0.119 W/kg; SAR(10 g) = 0.065 W/kg

Maximum value of SAR (measured) = 0.278 W/kg

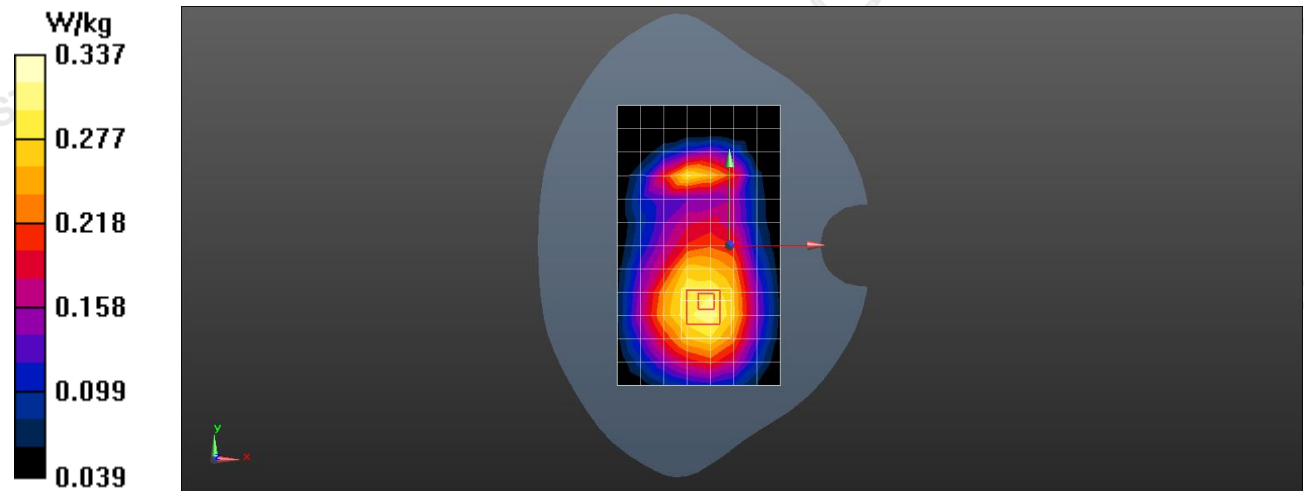

0 dB = 0.278 W/kg

#2

Date: 08/26/2024

LTE Band 2_20MHz/1RB#LOW _ Body worn _0mm _Ch18700

Communication System: UID 0, Generic LTE (0); Frequency: 1860 MHz; Duty Cycle: 1:1

Medium parameters used: $f = 1860$ MHz; $\sigma = 1.465$ S/m; $\epsilon_r = 40.658$; $\rho = 1000$ kg/m³

Phantom section: Flat Section

DASY5 Configuration:

- Probe: EX3DV4 - SN7624; ConvF(8.35, 8.35, 8.35); Calibrated: Sep. 06, 2023
- Sensor-Surface: 2mm (Mechanical Surface Detection)
- Electronics: DAE3 Sn428; Calibrated: 08/30/2023
- Phantom: Twin-SAM V8.0 ; Type: QD 000 P41 AA; Serial: 1974
- DASY52 52.10.2(1495); SEMCAD X 14.6.12(7450)

Front /Area Scan (8x13x1): Measurement grid: dx=15 mm, dy=15 mm

Maximum value of SAR (measured) = 0.498 W/kg

Front /Zoom Scan (5x5x7)/Cube 0: Measurement grid: dx=8mm, dy=8mm, dz=5mm

Reference Value = 3.226V/m; Power Drift = -0.11 dB

Peak SAR (extrapolated) = 2.65 W/kg

SAR(1 g) = 0.512 W/kg; SAR(10 g) = 0.377 W/kg

Maximum value of SAR (measured) = 0.482 W/kg

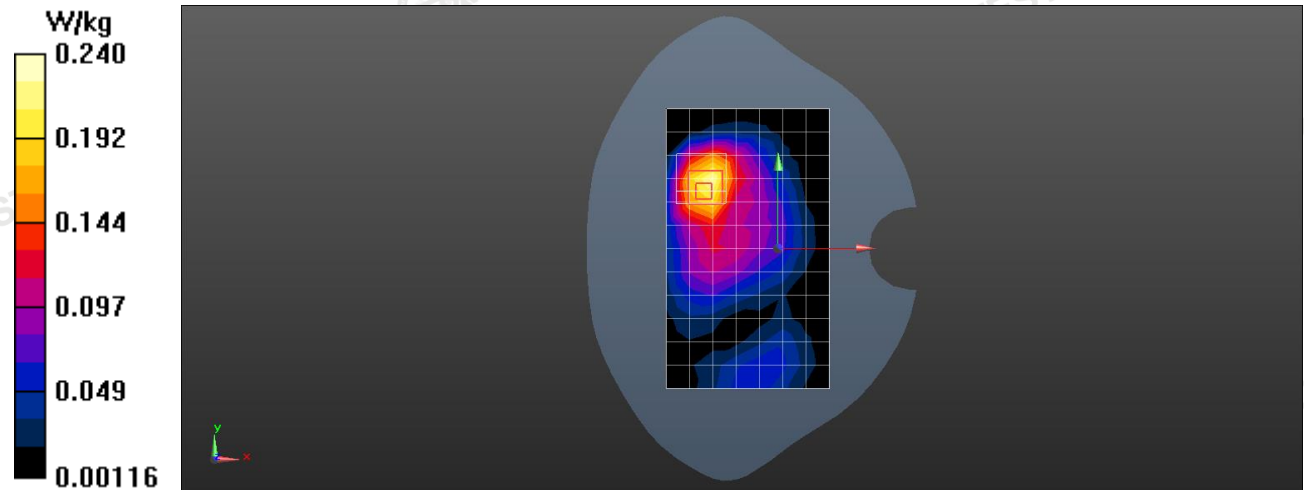

0 dB = 0.482 W/kg

#3

Date: 08/23/2024

LTE Band 4_20MHz/1RB#HIGH _ Front of face _25mm_Ch20050

Communication System: UID 0, Generic LTE (0); Frequency: 1720 MHz; Duty Cycle: 1:1

Medium parameters used: $f = 1720$ MHz; $\sigma = 1.426$ S/m; $\epsilon_r = 39.214$; $\rho = 1000$ kg/m³

Phantom section: Flat Section

DASY5 Configuration:

- Probe: EX3DV4 - SN7624; ConvF(8.66, 8.66, 8.66); Calibrated: Sep. 06, 2023
- Sensor-Surface: 2mm (Mechanical Surface Detection)
- Electronics: DAE3 Sn428; Calibrated: 08/30/2023
- Phantom: Twin-SAM V8.0; Type: QD 000 P41 AA; Serial: 1974
- DASY52 52.10.2(1495); SEMCAD X 14.6.12(7450)

Front /Area Scan (8x13x1): Measurement grid: dx=15 mm, dy=15 mm

Maximum value of SAR (measured) = 0.123 W/kg

Front /Zoom Scan (5x5x7)/Cube 0: Measurement grid: dx=8mm, dy=8mm, dz=5mm

Reference Value =0.652 V/m; Power Drift = -0.17 dB

Peak SAR (extrapolated) = 1.11 W/kg

SAR(1 g) = 0.135 W/kg; SAR(10 g) = 0.086 W/kg

Maximum value of SAR (measured) = 0.114 W/kg

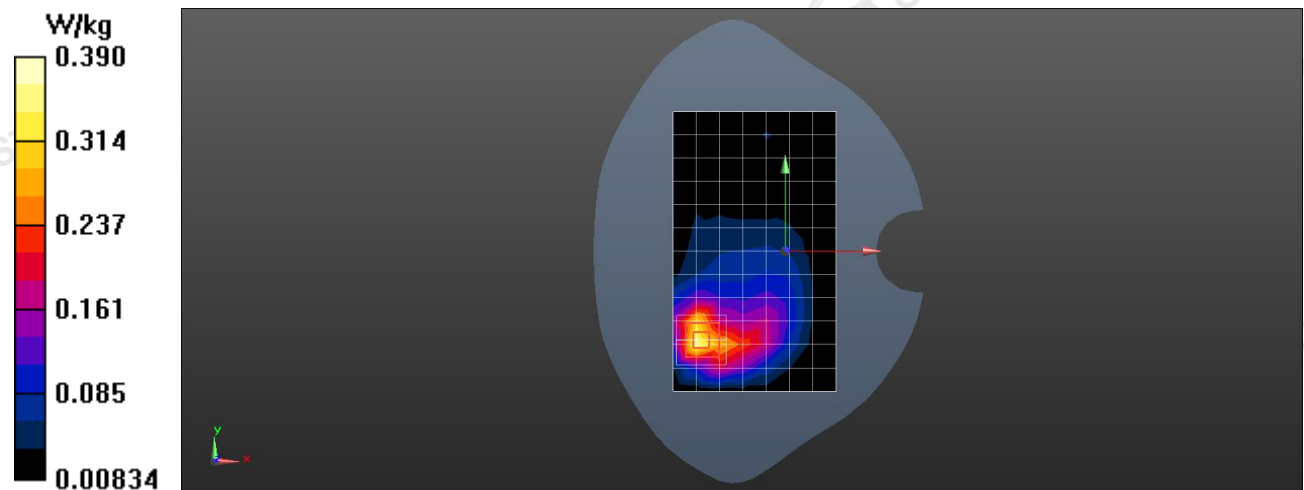

0 dB = 0.114 W/kg

#4

Date: 08/23/2024

LTE Band 4_20MHz/1RB#HIGH_ Body worn _0mm_Ch20050

Communication System: UID 0, Generic LTE (0); Frequency: 1720 MHz; Duty Cycle: 1:1

Medium parameters used: $f = 1720$ MHz; $\sigma = 1.426$ S/m; $\epsilon_r = 39.214$; $\rho = 1000$ kg/m³

Phantom section: Flat Section

DASY5 Configuration:

- Probe: EX3DV4 - SN7624; ConvF(8.66, 8.66, 8.66); Calibrated: Sep. 06, 2023
- Sensor-Surface: 2mm (Mechanical Surface Detection)
- Electronics: DAE3 Sn428; Calibrated: 08/30/2023
- Phantom: Twin-SAM V8.0; Type: QD 000 P41 AA; Serial: 1974
- DASY52 52.10.2(1495); SEMCAD X 14.6.12(7450)

Front /Area Scan (8x13x1): Measurement grid: dx=15 mm, dy=15 mm

Maximum value of SAR (measured) = 0.754 W/kg

Front /Zoom Scan (5x5x7)/Cube 0: Measurement grid: dx=8mm, dy=8mm, dz=5mm

Reference Value = 9.621 V/m; Power Drift = -0.16 dB

Peak SAR (extrapolated) = 3.25 W/kg

SAR(1 g) = 0.545 W/kg; SAR(10 g) = 0.377 W/kg

Maximum value of SAR (measured) = 0.766 W/kg

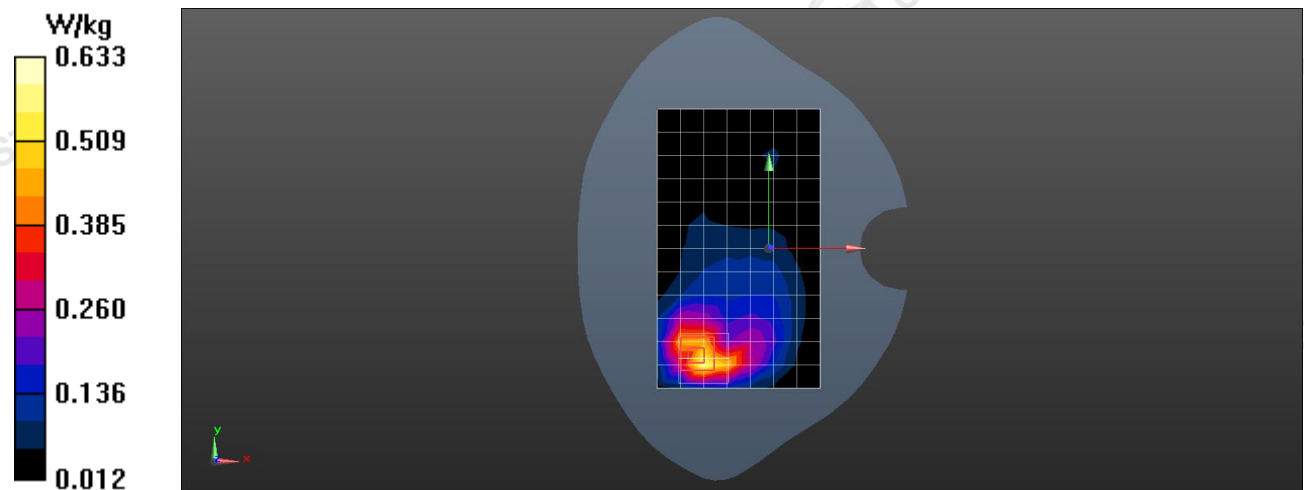

0 dB = 0.766 W/kg

#5

Date: 08/20/2024

LTE Band 5_10MHz/1RB#MID_ Front of face _25mm_Ch20600

Communication System: UID 0, Generic LTE (0); Frequency: 844 MHz; Duty Cycle: 1:1

Medium parameters used: $f = 844 \text{ MHz}$; $\sigma = 0.887 \text{ S/m}$; $\epsilon_r = 41.365$; $\rho = 1000 \text{ kg/m}^3$

Phantom section: Flat Section

DASY5 Configuration:

- Probe: EX3DV4 - SN7624; ConvF(10.19, 10.19, 10.19); Calibrated: Sep. 06, 2023
- Sensor-Surface: 2mm (Mechanical Surface Detection)
- Electronics: DAE3 Sn428; Calibrated: 08/30/2023
- Phantom: Twin-SAM V8.0; Type: QD 000 P41 AA; Serial: 1974
- DASY52 52.10.2(1495); SEMCAD X 14.6.12(7450)

Front /Area Scan (8x13x1): Measurement grid: $dx=15 \text{ mm}$, $dy=15 \text{ mm}$

Maximum value of SAR (measured) = 0.396 W/kg

Front /Zoom Scan (5x5x7)/Cube 0: Measurement grid: $dx=8\text{mm}$, $dy=8\text{mm}$, $dz=5\text{mm}$

Reference Value = 5.003 V/m; Power Drift = -0.17 dB

Peak SAR (extrapolated) = 2.06 W/kg

SAR(1 g) = 0.060 W/kg; SAR(10 g) = 0.041 W/kg

Maximum value of SAR (measured) = 0.388 W/kg

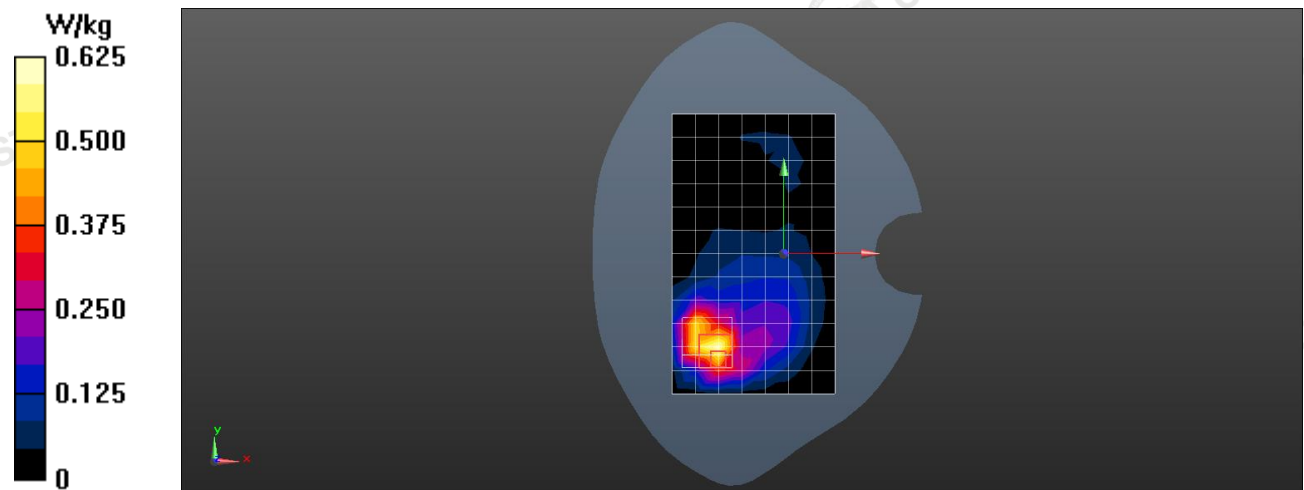

0 dB = 0.388 W/kg

#6

Date: 08/20/2024

LTE Band 5_10MHz/1RB#MID_ Body worn _0mm_Ch20600

Communication System: UID 0, Generic LTE (0); Frequency: 844 MHz; Duty Cycle: 1:1

Medium parameters used: $f = 844 \text{ MHz}$; $\sigma = 0.887 \text{ S/m}$; $\epsilon_r = 41.365$; $\rho = 1000 \text{ kg/m}^3$

Phantom section: Flat Section

DASY5 Configuration:

- Probe: EX3DV4 - SN7624; ConvF(10.19, 10.19, 10.19); Calibrated: Sep. 06, 2023
- Sensor-Surface: 2mm (Mechanical Surface Detection)
- Electronics: DAE3 Sn428; Calibrated: 08/30/2023
- Phantom: Twin-SAM V8.0; Type: QD 000 P41 AA; Serial: 1974
- DASY52 52.10.2(1495); SEMCAD X 14.6.12(7450)

Front /Area Scan (10x15x1): Measurement grid: $dx=15 \text{ mm}$, $dy=15 \text{ mm}$

Maximum value of SAR (measured) = 0.325 W/kg

Front /Zoom Scan (5x5x7)/Cube 0: Measurement grid: $dx=8\text{mm}$, $dy=8\text{mm}$, $dz=5\text{mm}$

Reference Value = 4.527 V/m; Power Drift = -0.11 dB

Peak SAR (extrapolated) = 1.39 W/kg

SAR(1 g) = 0.332 W/kg; SAR(10 g) = 0.199 W/kg

Maximum value of SAR (measured) = 0.326 W/kg

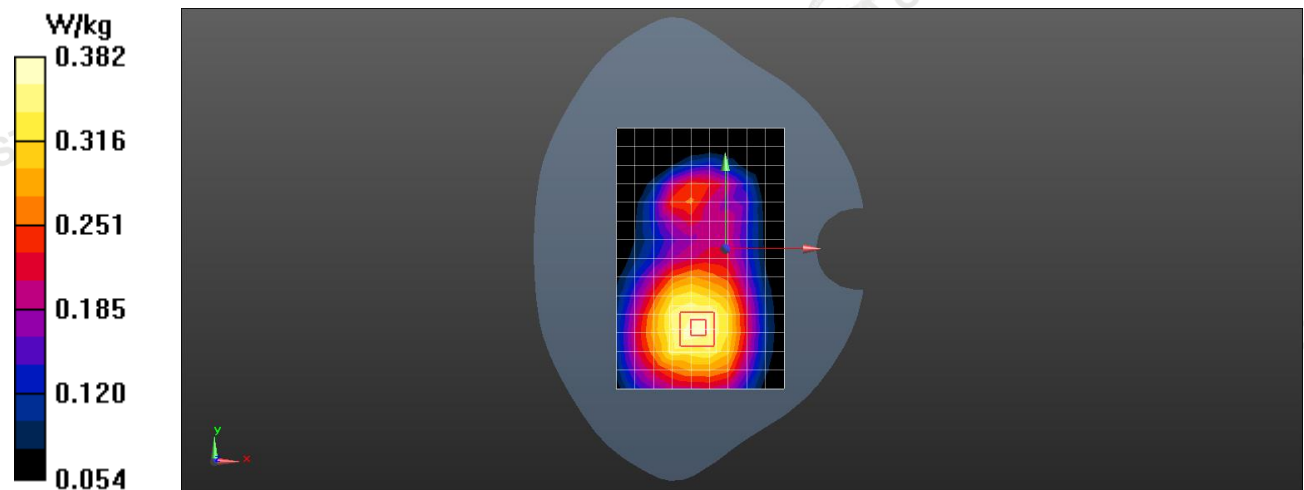

0 dB = 0.326 W/kg

#7

Date: 08/27/2024

LTE Band 7_10MHz/1RB#MID_ Front of face _25mm_Ch21400

Communication System: UID 0, Generic LTE (0); Frequency 2565 MHz; Duty Cycle: 1:1

Medium parameters used: $f = 2565$ MHz; $\sigma = 1.860$ S/m; $\epsilon_r = 37.974$; $\rho = 1000$ kg/m³

Phantom section: Flat Section

DASY5 Configuration:

- Probe: EX3DV4 - SN7624; ConvF(7.66, 7.66, 7.66); Calibrated: Sep. 06, 2023
- Sensor-Surface: 2mm (Mechanical Surface Detection)
- Electronics: DAE3 Sn428; Calibrated: 08/30/2023
- Phantom: Twin-SAM V8.0 ; Type: QD 000 P41 AA; Serial: 1974
- DASY52 52.10.2(1495); SEMCAD X 14.6.12(7450)

Front /Area Scan (10x15x1): Measurement grid: dx=12 mm, dy=12 mm

Maximum value of SAR (measured) = 0.144 W/kg

Front /Zoom Scan (7x7x7)/Cube 0: Measurement grid: dx=5mm, dy=5mm, dz=5mm

Reference Value = 2.024 V/m; Power Drift = -0.02 dB

Peak SAR (extrapolated) = 1.12 W/kg

SAR(1 g) = 0.326 W/kg; SAR(10 g) = 0.239 W/kg

Maximum value of SAR (measured) = 0.135 W/kg

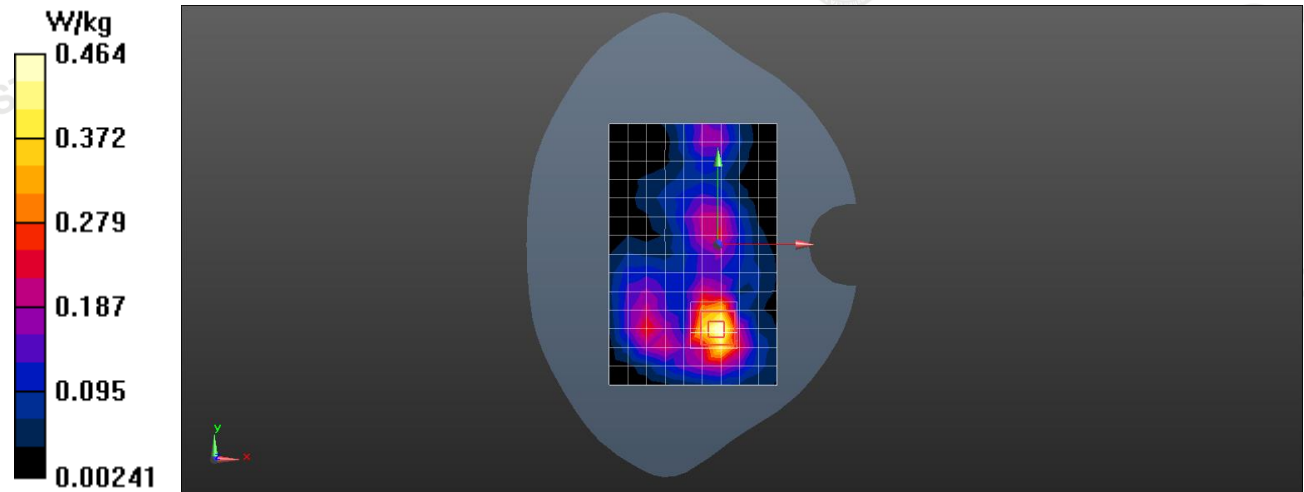

0 dB = 0.135 W/kg

#8

Date: 08/27/2024

LTE Band 7_10MHz/1RB#MID_ Body worn _0mm_Ch21400

Communication System: UID 0, Generic LTE (0); Frequency 2565 MHz; Duty Cycle: 1:1

Medium parameters used: $f = 2565$ MHz; $\sigma = 1.860$ S/m; $\epsilon_r = 37.974$; $\rho = 1000$ kg/m³

Phantom section: Flat Section

DASY5 Configuration:

- Probe: EX3DV4 - SN7624; ConvF(7.66, 7.66, 7.66); Calibrated: Sep. 06, 2023
- Sensor-Surface: 2mm (Mechanical Surface Detection)
- Electronics: DAE3 Sn428; Calibrated: 08/30/2023
- Phantom: Twin-SAM V8.0 ; Type: QD 000 P41 AA; Serial: 1974
- DASY52 52.10.2(1495); SEMCAD X 14.6.12(7450)

Front /Area Scan (10x15x1): Measurement grid: dx=12 mm, dy=12 mm

Maximum value of SAR (measured) = 0.523 W/kg

Front /Zoom Scan (7x7x7)/Cube 0: Measurement grid: dx=5mm, dy=5mm, dz=5mm

Reference Value = 8.456 V/m; Power Drift = 0.15 dB

Peak SAR (extrapolated) = 2.22 W/kg

SAR(1 g) = 0.652 W/kg; SAR(10 g) = 0.467 W/kg

Maximum value of SAR (measured) = 0.514 W/kg

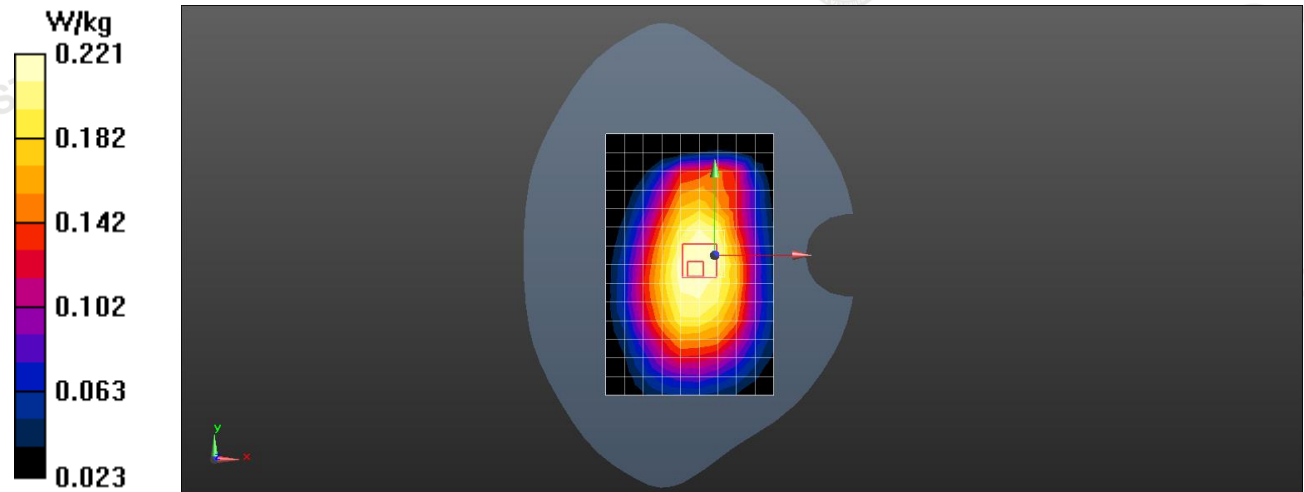

0 dB = 0.514 W/kg

#9

Date: 08/27/2024

LTE Band 38_20MHz/1RB#MID_ Front of face _25mm_Ch38000

Communication System: UID 0, Generic LTE (0); Frequency: 2595 MHz; Duty Cycle: 1:1

Medium parameters used: $f = 2595$ MHz; $\sigma = 1.897$ S/m; $\epsilon_r = 38.966$; $\rho = 1000$ kg/m³

Phantom section: Flat Section

DASY5 Configuration:

- Probe: EX3DV4 - SN7624; ConvF(7.66, 7.66, 7.66); Calibrated: Sep. 06, 2023
- Sensor-Surface: 2mm (Mechanical Surface Detection)
- Electronics: DAE3 Sn428; Calibrated: 08/30/2023
- Phantom: Twin-SAM V8.0 ; Type: QD 000 P41 AA; Serial: 1974
- DASY52 52.10.2(1495); SEMCAD X 14.6.12(7450)

Front /Area Scan (10x15x1): Measurement grid: dx=12 mm, dy=12 mm

Maximum value of SAR (measured) = 0.254 W/kg

Front /Zoom Scan (7x7x7)/Cube 0: Measurement grid: dx=5mm, dy=5mm, dz=5mm

Reference Value =4.116 V/m; Power Drift = 0.13 dB

Peak SAR (extrapolated) = 1.65 W/kg

SAR(1 g) = 0.288 W/kg; SAR(10 g) = 0.154 W/kg

Maximum value of SAR (measured) = 0.244 W/kg

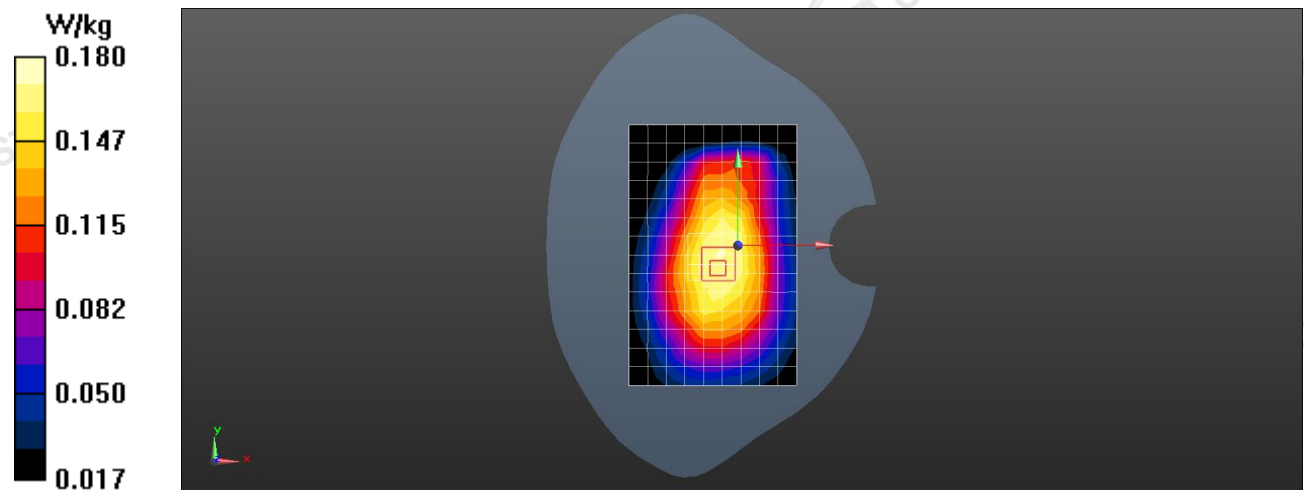

0 dB = 0.244 W/kg

#10

Date: 08/27/2024

LTE Band 38_20MHz/1RB#MID_ Body worn _0mm_Ch38000

Communication System: UID 0, Generic LTE (0); Frequency: 2595 MHz; Duty Cycle: 1:1

Medium parameters used: $f = 2595$ MHz; $\sigma = 1.897$ S/m; $\epsilon_r = 38.966$; $\rho = 1000$ kg/m³

Phantom section: Flat Section

DASY5 Configuration:

- Probe: EX3DV4 - SN7624; ConvF(7.66, 7.66, 7.66); Calibrated: Sep. 06, 2023
- Sensor-Surface: 2mm (Mechanical Surface Detection)
- Electronics: DAE3 Sn428; Calibrated: 08/30/2023
- Phantom: Twin-SAM V8.0 ; Type: QD 000 P41 AA; Serial: 1974
- DASY52 52.10.2(1495); SEMCAD X 14.6.12(7450)

Front /Area Scan (10x15x1): Measurement grid: dx=12 mm, dy=12 mm

Maximum value of SAR (measured) = 0.878 W/kg

Front /Zoom Scan (7x7x7)/Cube 0: Measurement grid: dx=5mm, dy=5mm, dz=5mm

Reference Value = 2.411 V/m; Power Drift = 0.08 dB

Peak SAR (extrapolated) = 2.03 W/kg

SAR(1 g) = 0.659 W/kg; SAR(10 g) = 0.447 W/kg

Maximum value of SAR (measured) = 0.865 W/kg

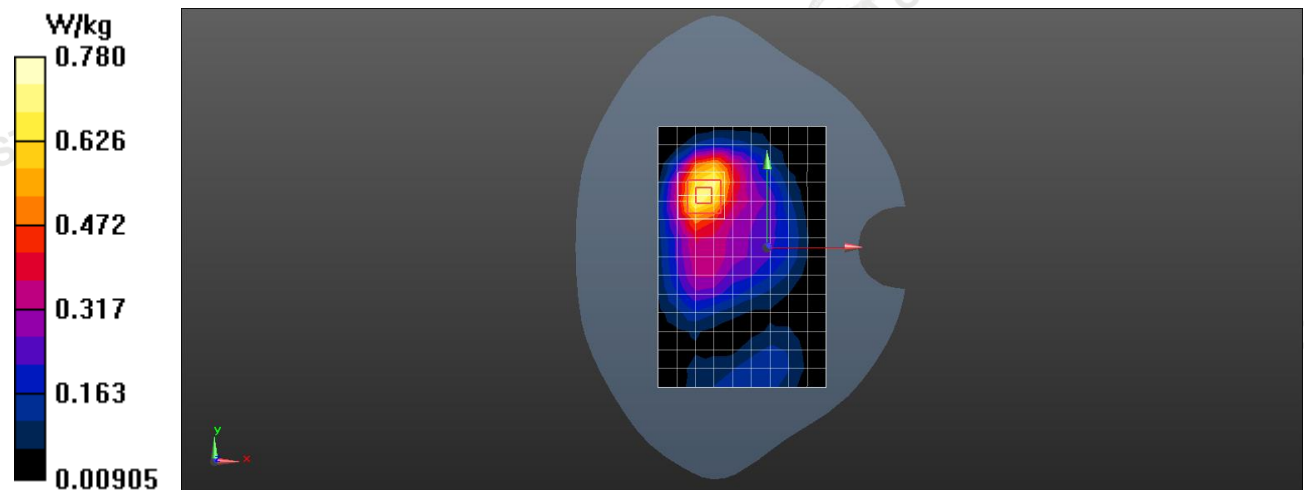

0 dB = 0.865 W/kg

#11

Date: 08/27/2024

LTE Band 41_20MHz/1RB#MID_ Front of face _25mm_Ch41490

Communication System: UID 0, Generic LTE (0); Frequency: 2680 MHz; Duty Cycle: 1:1

Medium parameters used: $f = 2680$ MHz; $\sigma = 1.965$ S/m; $\epsilon_r = 40.885$; $\rho = 1000$ kg/m³

Phantom section: Flat Section

DASY5 Configuration:

- Probe: EX3DV4 - SN7624; ConvF(7.66, 7.66, 7.66); Calibrated: Sep. 06, 2023
- Sensor-Surface: 2mm (Mechanical Surface Detection)
- Electronics: DAE3 Sn428; Calibrated: 08/30/2023
- Phantom: Twin-SAM V8.0 ; Type: QD 000 P41 AA; Serial: 1974
- DASY52 52.10.2(1495); SEMCAD X 14.6.12(7450)

Front /Area Scan (10x15x1): Measurement grid: dx=12 mm, dy=12 mm

Maximum value of SAR (measured) = 0.124 W/kg

Front /Zoom Scan (7x7x7)/Cube 0: Measurement grid: dx=5mm, dy=5mm, dz=5mm

Reference Value = 12.05 V/m; Power Drift = -0.16 dB

Peak SAR (extrapolated) = 1.55 W/kg

SAR(1 g) = 0.432 W/kg; SAR(10 g) = 0.298 W/kg

Maximum value of SAR (measured) = 0.115 W/kg

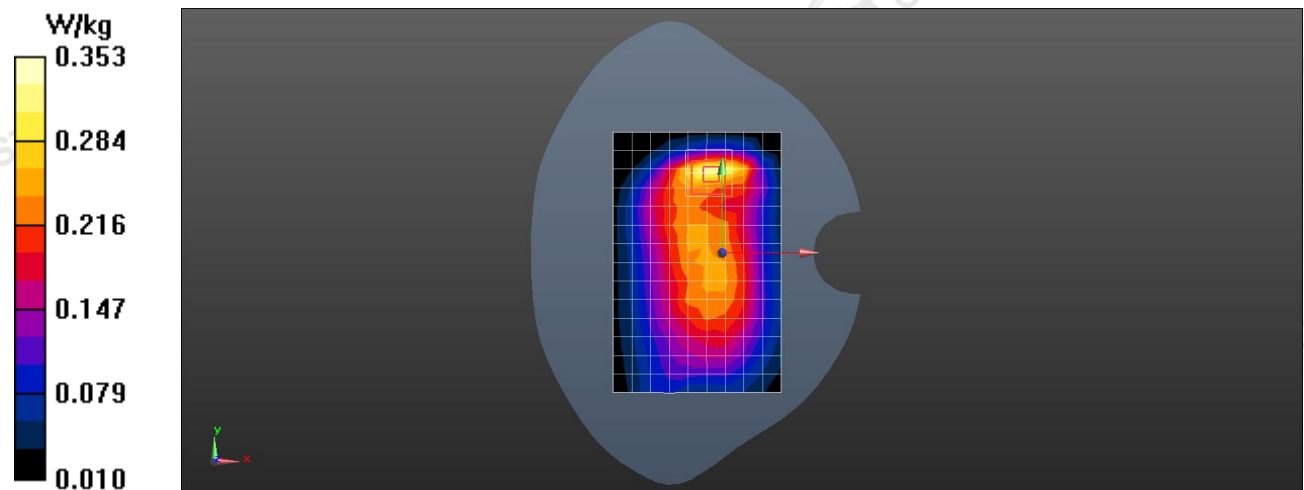

0 dB = 0.115 W/kg

#12

Date: 08/27/2024

LTE Band 41_20MHz/1RB#MID_ Body worn _0mm_Ch41490

Communication System: UID 0, Generic LTE (0); Frequency: 2680 MHz; Duty Cycle: 1:1

Medium parameters used: $f = 2680$ MHz; $\sigma = 1.965$ S/m; $\epsilon_r = 40.885$; $\rho = 1000$ kg/m³

Phantom section: Flat Section

DASY5 Configuration:

- Probe: EX3DV4 - SN7624; ConvF(7.66, 7.66, 7.66); Calibrated: Sep. 06, 2023
- Sensor-Surface: 2mm (Mechanical Surface Detection)
- Electronics: DAE3 Sn428; Calibrated: 08/30/2023
- Phantom: Twin-SAM V8.0 ; Type: QD 000 P41 AA; Serial: 1974
- DASY52 52.10.2(1495); SEMCAD X 14.6.12(7450)

Front /Area Scan (8x13x1): Measurement grid: dx=12 mm, dy=12 mm

Maximum value of SAR (measured) = 1.85 W/kg

Front /Zoom Scan (7x7x7)/Cube 0: Measurement grid: dx=5mm, dy=5mm, dz=5mm

Reference Value = 15.25 V/m; Power Drift = -0.07 dB

Peak SAR (extrapolated) = 1.36 W/kg

SAR(1 g) = 0.781 W/kg; SAR(10 g) = 0.596 W/kg

Maximum value of SAR (measured) = 1.77 W/kg

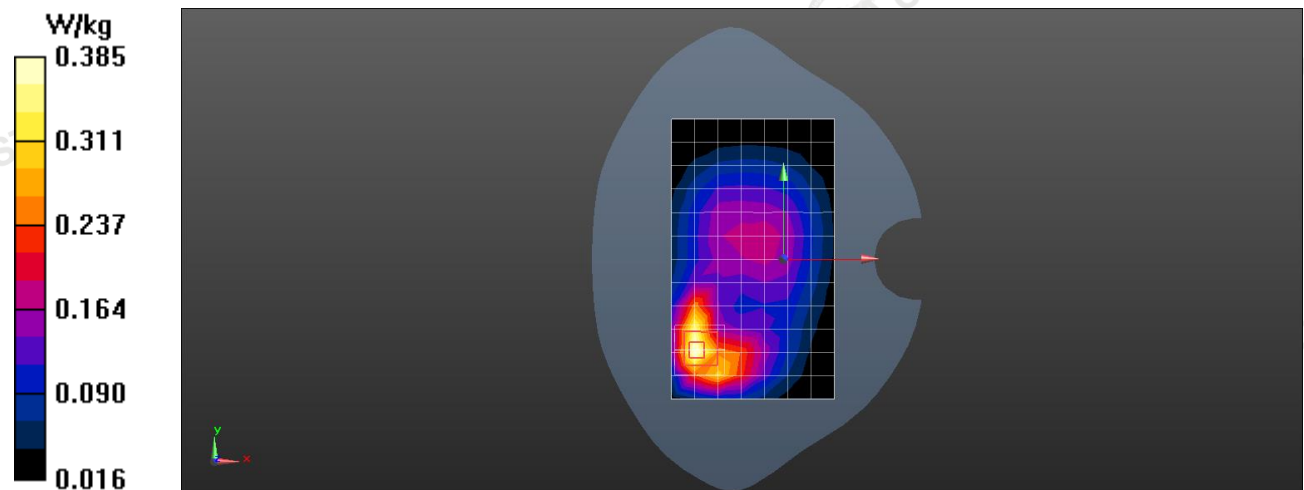

0 dB = 1.77 W/kg

Appendix D. DASY System Calibration Certificate

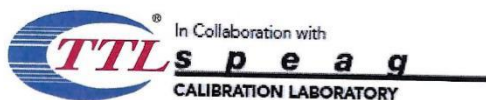

In Collaboration with
TTL Speag
 CALIBRATION LABORATORY
 Add: No.52 HuaYuanBei Road, Haidian District, Beijing, 100191, China
 Tel: +86-10-62304633-2117
 E-mail: emf@caict.ac.cn http://www.caict.ac.cn



中国认可
 国际互认
 校准
CAICT
 CALIBRATION
 CNAS L0570

Client **INNOWAVE**

Certificate No: **J23Z60222**

CALIBRATION CERTIFICATE

Object: **EX3DV4 - SN : 7624**

Calibration Procedure(s): **FF-Z11-004-02**
 Calibration Procedures for Dosimetric E-field Probes

Calibration date: **September 06, 2023**

This calibration Certificate documents the traceability to national standards, which realize the physical units of measurements(SI). The measurements and the uncertainties with confidence probability are given on the following pages and are part of the certificate.

All calibrations have been conducted in the closed laboratory facility: environment temperature(22±3)°C and humidity<70%.

Calibration Equipment used (M&TE critical for calibration)

Primary Standards	ID #	Cal Date(Calibrated by, Certificate No.)	Scheduled Calibration
Power Meter NRP2	101919	12-Jun-23(CTTL, No.J23X05435)	Jun-24
Power sensor NRP-Z91	101547	12-Jun-23(CTTL, No.J23X05435)	Jun-24
Power sensor NRP-Z91	101548	12-Jun-23(CTTL, No.J23X05435)	Jun-24
Reference 10dBAttenuator	18N50W-10dB	19-Jan-23(CTTL, No.J23X00212)	Jan-25
Reference 20dBAttenuator	18N50W-20dB	19-Jan-23(CTTL, No.J23X00211)	Jan-25
Reference Probe EX3DV4	SN 3846	31-May-23(SPEAG, No.EX-3846_May23)	May-24
DAE4	SN 549	24-Jan-23(SPEAG, No.DAE4-549_Jan23)	Jan-24
DAE4	SN 1744	30-Aug-22(SPEAG, No.DAE4-1744_Aug22)	Aug-23
Secondary Standards	ID #	Cal Date(Calibrated by, Certificate No.)	Scheduled Calibration
SignalGenerator MG3700A	6201052605	12-Jun-23(CTTL, No.J23X05434)	Jun-24
Network Analyzer E5071C	MY46110673	10-Jan-23(CTTL, No.J23X00104)	Jan-24
Reference 10dBAttenuator	BT0520	11-May-23(CTTL, No.J23X04061)	May-25
Reference 20dBAttenuator	BT0267	11-May-23(CTTL, No.J23X04062)	May-25
OCP DAK-3.5	SN 1040	18-Jan-23(SPEAG, No.OCP-DAK3.5-1040_Jan23)	Jan-24

	Name	Function	Signature
Calibrated by:	Yu Zongying	SAR Test Engineer	
Reviewed by:	Lin Hao	SAR Test Engineer	
Approved by:	Qi Dianyuan	SAR Project Leader	

Issued: September 12, 2023

This calibration certificate shall not be reproduced except in full without written approval of the laboratory.

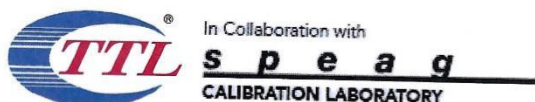

Add: No.52 HuaYuanBei Road, Haidian District, Beijing, 100191, China
Tel: +86-10-62304633-2117
E-mail: emf@caict.ac.cn <http://www.caict.ac.cn>

Glossary:

TSL	tissue simulating liquid
NORM _{x,y,z}	sensitivity in free space
ConvF	sensitivity in TSL / NORM _{x,y,z}
DCP	diode compression point
CF	crest factor (1/duty_cycle) of the RF signal
A,B,C,D	modulation dependent linearization parameters
Polarization Φ	Φ rotation around probe axis
Polarization θ	θ rotation around an axis that is in the plane normal to probe axis (at measurement center), i $\theta=0$ is normal to probe axis
Connector Angle	information used in DASY system to align probe sensor X to the robot coordinate system

Calibration is Performed According to the Following Standards:

- IEEE Std 1528-2013, "IEEE Recommended Practice for Determining the Peak Spatial-Averaged Specific Absorption Rate (SAR) in the Human Head from Wireless Communications Devices: Measurement Techniques", June 2013
- IEC 62209-1, "Measurement procedure for the assessment of Specific Absorption Rate (SAR) from hand-held and body-mounted devices used next to the ear (frequency range of 300 MHz to 6 GHz)", July 2016
- IEC 62209-2, "Procedure to determine the Specific Absorption Rate (SAR) for wireless communication devices used in close proximity to the human body (frequency range of 30 MHz to 6 GHz)", March 2010
- KDB 865664, "SAR Measurement Requirements for 100 MHz to 6 GHz"

Methods Applied and Interpretation of Parameters:

- NORM_{x,y,z}**: Assessed for E-field polarization $\theta=0$ ($f \leq 900$ MHz in TEM-cell; $f > 1800$ MHz: waveguide). NORM_{x,y,z} are only intermediate values, i.e., the uncertainties of NORM_{x,y,z} does not effect the E^2 -field uncertainty inside TSL (see below ConvF).
- NORM(f)_{x,y,z} = NORM_{x,y,z} * frequency_response** (see Frequency Response Chart). This linearization is implemented in DASY4 software versions later than 4.2. The uncertainty of the frequency response is included in the stated uncertainty of ConvF.
- DCP_{x,y,z}**: DCP are numerical linearization parameters assessed based on the data of power sweep (no uncertainty required). DCP does not depend on frequency nor media.
- PAR**: PAR is the Peak to Average Ratio that is not calibrated but determined based on the signal characteristics.
- A_{x,y,z}; B_{x,y,z}; C_{x,y,z}; VR_{x,y,z}; A,B,C** are numerical linearization parameters assessed based on the data of power sweep for specific modulation signal. The parameters do not depend on frequency nor media. VR is the maximum calibration range expressed in RMS voltage across the diode.
- ConvF and Boundary Effect Parameters**: Assessed in flat phantom using E-field (or Temperature Transfer Standard for $f \leq 800$ MHz) and inside waveguide using analytical field distributions based on power measurements for $f > 800$ MHz. The same setups are used for assessment of the parameters applied for boundary compensation (alpha, depth) of which typical uncertainty valued are given. These parameters are used in DASY4 software to improve probe accuracy close to the boundary. The sensitivity in TSL corresponds to NORM_{x,y,z} * ConvF whereby the uncertainty corresponds to that given for ConvF. A frequency dependent ConvF is used in DASY version 4.4 and higher which allows extending the validity from ± 50 MHz to ± 100 MHz.
- Spherical isotropy (3D deviation from isotropy)**: in a field of low gradients realized using a flat phantom exposed by a patch antenna.
- Sensor Offset**: The sensor offset corresponds to the offset of virtual measurement center from the probe tip (on probe axis). No tolerance required.
- Connector Angle**: The angle is assessed using the information gained by determining the NORM_x (no uncertainty required).

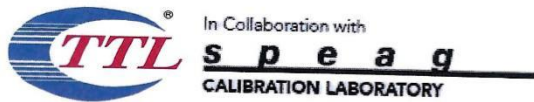

Add: No.52 HuaYuanBei Road, Haidian District, Beijing, 100191, China
 Tel: +86-10-62304633-2117
 E-mail: emf@caict.ac.cn http://www.caict.ac.cn

DASY/EASY – Parameters of Probe: EX3DV4 – SN:7624

Basic Calibration Parameters

	Sensor X	Sensor Y	Sensor Z	Unc (k=2)
Norm($\mu\text{V}/(\text{V}/\text{m})^2$) ^A	0.57	0.59	0.58	$\pm 10.0\%$
DCP(mV) ^B	112.6	113.4	119.4	

Modulation Calibration Parameters

UID	Communication System Name		A dB	B dB $\cdot\mu\text{V}$	C	D dB	VR mV	Unc ^E (k=2)
0	CW	X	0.0	0.0	1.0	0.00	200.3	$\pm 4.7\%$
		Y	0.0	0.0	1.0		212.4	
		Z	0.0	0.0	1.0		202.8	

The reported uncertainty of measurement is stated as the standard uncertainty of Measurement multiplied by the coverage factor $k=2$, which for a normal distribution Corresponds to a coverage probability of approximately 95%.

^A The uncertainties of Norm X, Y, Z do not affect the E²-field uncertainty inside TSL (see Page 4).

^B Numerical linearization parameter: uncertainty not required.

^E Uncertainty is determined using the max. deviation from linear response applying rectangular distribution and is expressed for the square of the field value.

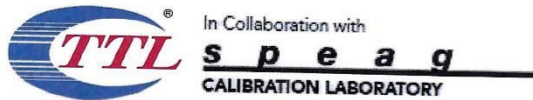

Add: No.52 HuaYuanBei Road, Haidian District, Beijing, 100191, China
Tel: +86-10-62304633-2117
E-mail: emf@caict.ac.cn <http://www.caict.ac.cn>

DASY/EASY – Parameters of Probe: EX3DV4 – SN:7624

Calibration Parameter Determined in Head Tissue Simulating Media

f [MHz] ^C	Relative Permittivity ^F	Conductivity (S/m) ^F	ConvF X	ConvF Y	ConvF Z	Alpha ^G	Depth ^G (mm)	Unct. (k=2)
750	41.9	0.89	10.58	10.58	10.58	0.20	1.06	±12.7%
835	41.5	0.90	10.19	10.19	10.19	0.19	1.20	±12.7%
1750	40.1	1.37	8.66	8.66	8.66	0.21	1.13	±12.7%
1900	40.0	1.40	8.35	8.35	8.35	0.33	0.91	±12.7%
2100	39.8	1.49	8.27	8.27	8.27	0.23	1.08	±12.7%
2300	39.5	1.67	8.13	8.13	8.13	0.58	0.67	±12.7%
2450	39.2	1.80	7.85	7.85	7.85	0.63	0.66	±12.7%
2600	39.0	1.96	7.66	7.66	7.66	0.65	0.66	±12.7%
3500	37.9	2.91	7.20	7.20	7.20	0.34	1.00	±13.9%
3700	37.7	3.12	7.00	7.00	7.00	0.36	1.07	±13.9%
3900	37.5	3.32	6.85	6.85	6.85	0.30	1.50	±13.9%
4100	37.2	3.53	6.78	6.78	6.78	0.30	1.35	±13.9%
4200	37.1	3.63	6.68	6.68	6.68	0.30	1.45	±13.9%
4400	36.9	3.84	6.61	6.61	6.61	0.30	1.45	±13.9%
4600	36.7	4.04	6.47	6.47	6.47	0.40	1.30	±13.9%
4800	36.4	4.25	6.37	6.37	6.37	0.40	1.40	±13.9%
4950	36.3	4.40	6.08	6.08	6.08	0.40	1.40	±13.9%
5250	35.9	4.71	5.55	5.55	5.55	0.40	1.50	±13.9%
5600	35.5	5.07	4.96	4.96	4.96	0.35	1.70	±13.9%
5750	35.4	5.22	4.98	4.98	4.98	0.35	1.80	±13.9%

^C Frequency validity above 300 MHz of ±100MHz only applies for DASY v4.4 and higher (Page 2), else it is restricted to ±50MHz. The uncertainty is the RSS of ConvF uncertainty at calibration frequency and the uncertainty for the indicated frequency band. Frequency validity below 300 MHz is ± 10, 25, 40, 50 and 70 MHz for ConvF assessments at 30, 64, 128, 150 and 220 MHz respectively. Above 5 GHz frequency validity can be extended to ± 110 MHz.

^F At frequency up to 6 GHz, the validity of tissue parameters (ϵ and σ) can be relaxed to ±10% if liquid compensation formula is applied to measured SAR values. The uncertainty is the RSS of the ConvF uncertainty for indicated target tissue parameters.

^G Alpha/Depth are determined during calibration. SPEAG warrants that the remaining deviation due to the boundary effect after compensation is always less than ± 1% for frequencies below 3 GHz and below ± 2% for the frequencies between 3-6 GHz at any distance larger than half the probe tip diameter from the boundary.

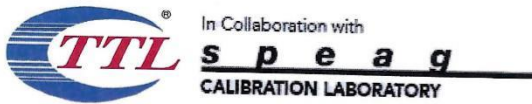

Add: No.52 HuaYuanBei Road, Haidian District, Beijing, 100191, China
Tel: +86-10-62304633-2117
E-mail: emf@caict.ac.cn <http://www.caict.ac.cn>

Frequency Response of E-Field (TEM-Cell: ifi110 EXX, Waveguide: R22)

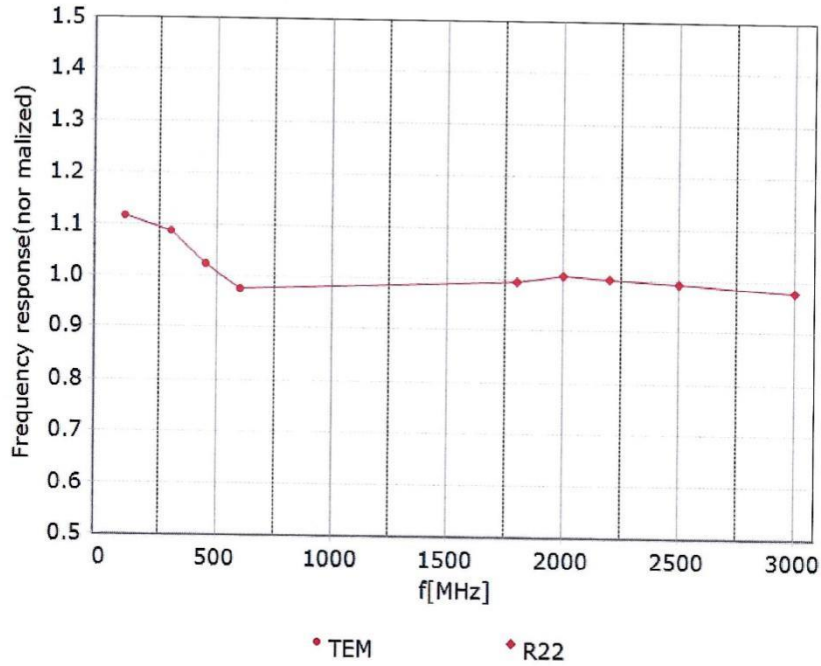

Uncertainty of Frequency Response of E-field: $\pm 7.4\%$ ($k=2$)



Add: No.52 HuaYuanBei Road, Haidian District, Beijing, 100191, China
Tel: +86-10-62304633-2117
E-mail: emf@caict.ac.cn <http://www.caict.ac.cn>

Receiving Pattern (Φ), $\theta=0^\circ$

f=600 MHz, TEM

f=1800 MHz, R22

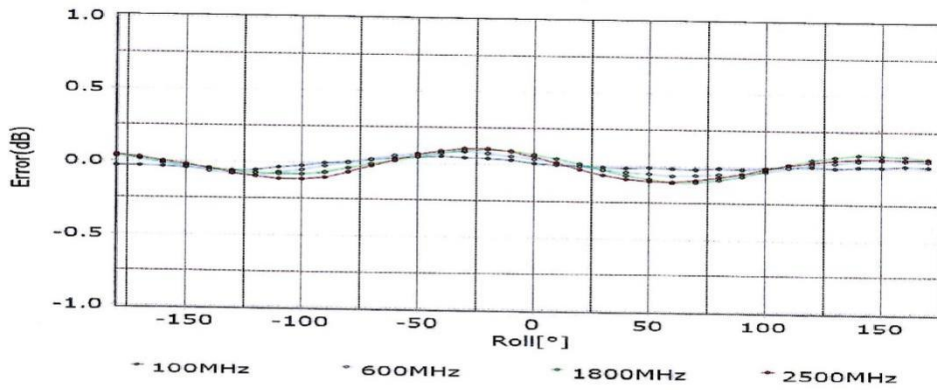
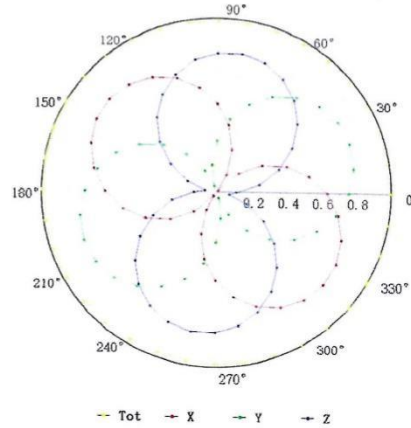
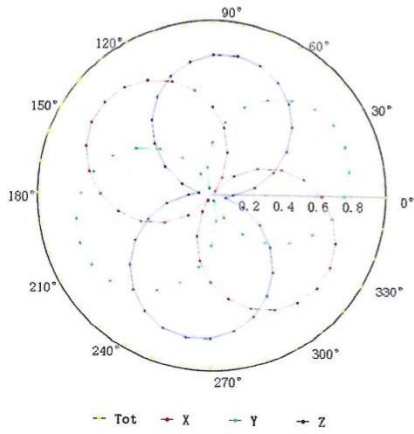

Uncertainty of Axial Isotropy Assessment: $\pm 1.2\%$ ($k=2$)



Add: No.52 HuaYuanBei Road, Haidian District, Beijing, 100191, China
 Tel: +86-10-62304633-2117
 E-mail: cmf@caict.ac.cn http://www.caict.ac.cn

Dynamic Range $f(\text{SAR}_{\text{head}})$ (TEM cell, $f = 900 \text{ MHz}$)

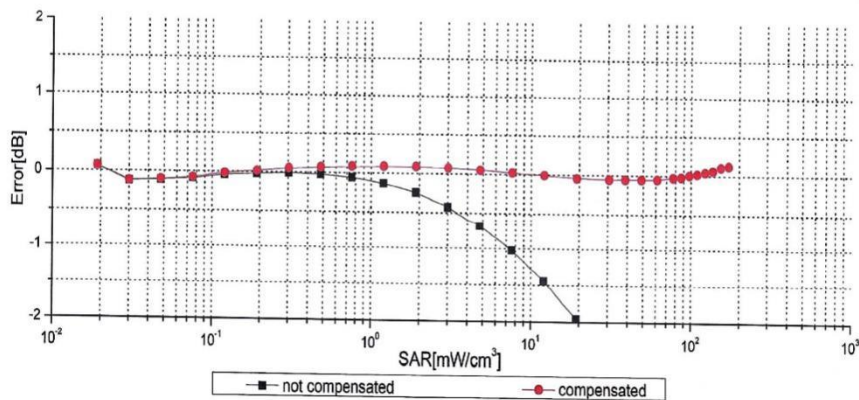
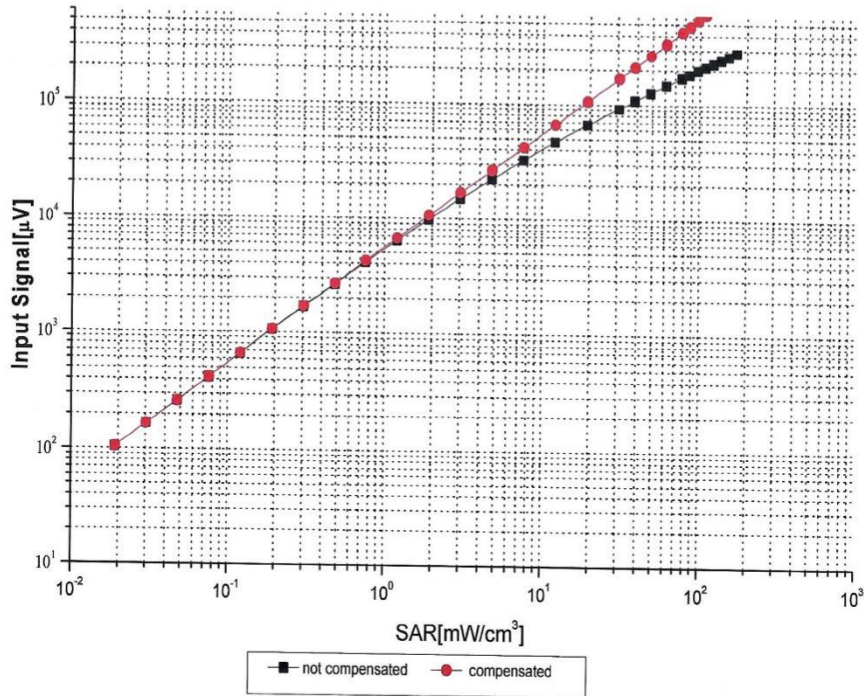

Uncertainty of Linearity Assessment: $\pm 0.9\%$ ($k=2$)

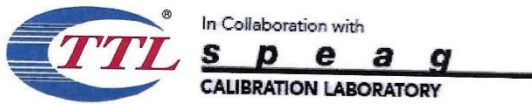

Add: No.52 HuaYuanBei Road, Haidian District, Beijing, 100191, China
Tel: +86-10-62304633-2117
E-mail: emf@caict.ac.cn http://www.caict.ac.cn

Conversion Factor Assessment

f=750 MHz,WGLS R9(H_convF)

f=1750 MHz,WGLS R22(H_convF)

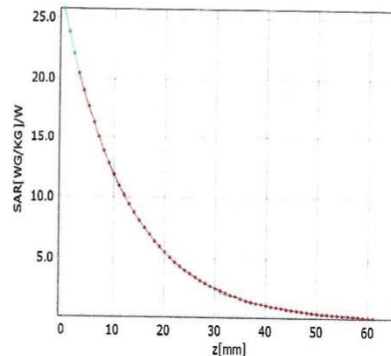
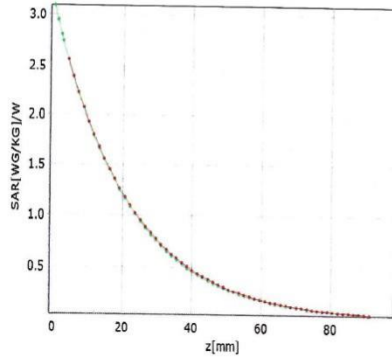

Deviation from Isotropy in Liquid

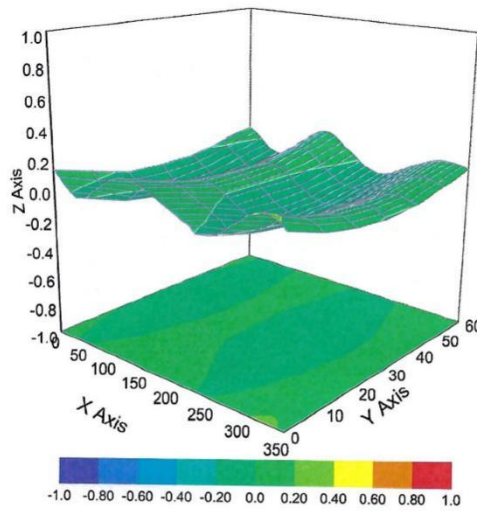

Uncertainty of Spherical Isotropy Assessment: $\pm 3.2\%$ ($k=2$)

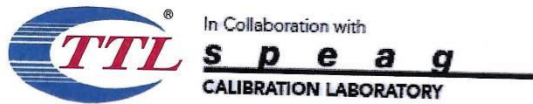

Add: No.52 HuaYuanBei Road, Haidian District, Beijing, 100191, China
Tel: +86-10-62304633-2117
E-mail: emf@caict.ac.cn <http://www.caict.ac.cn>

DASY/EASY – Parameters of Probe: EX3DV4 – SN:7624

Other Probe Parameters

Sensor Arrangement	Triangular
Connector Angle (°)	151.7
Mechanical Surface Detection Mode	enabled
Optical Surface Detection Mode	disable
Probe Overall Length	337mm
Probe Body Diameter	10mm
Tip Length	9mm
Tip Diameter	2.5mm
Probe Tip to Sensor X Calibration Point	1mm
Probe Tip to Sensor Y Calibration Point	1mm
Probe Tip to Sensor Z Calibration Point	1mm
Recommended Measurement Distance from Surface	1.4mm



In Collaboration with
TTL s p e a g
 CALIBRATION LABORATORY
 Add: No.52 HuaYuanBei Road, Haidian District, Beijing, 100191, China
 Tel: +86-10-62304633-2117
 E-mail: emf@caict.ac.cn <http://www.caict.ac.cn>



中国认可
 国际互认
 校准
CAICT
 CALIBRATION
 CNAS L0570

Client : CTA

Certificate No: J23Z60391

CALIBRATION CERTIFICATE

Object: DAE3 - SN: 428
 Calibration Procedure(s): FF-Z11-002-01
 Calibration Procedure for the Data Acquisition Electronics (DAEx)
 Calibration date: August 30, 2023

This calibration Certificate documents the traceability to national standards, which realize the physical units of measurements(SI). The measurements and the uncertainties with confidence probability are given on the following pages and are part of the certificate.

All calibrations have been conducted in the closed laboratory facility: environment temperature(22±3)°C and humidity<70%.

Calibration Equipment used (M&TE critical for calibration)

Primary Standards	ID #	Cal Date(Calibrated by, Certificate No.)	Scheduled Calibration
Process Calibrator 753	1971018	12-Jun-23 (CTTL, No.J23X05436)	Jun-24

	Name	Function	Signature
Calibrated by:	Yu Zongying	SAR Test Engineer	
Reviewed by:	Lin Hao	SAR Test Engineer	
Approved by:	Qi Dianyuan	SAR Project Leader	

Issued: September 06, 2023

This calibration certificate shall not be reproduced except in full without written approval of the laboratory.



In Collaboration with
s p e a g
CALIBRATION LABORATORY



Add: No.52 HuaYuanBei Road, Haidian District, Beijing, 100191, China
Tel: +86-10-62304633-2117
E-mail: cmf@caict.ac.cn <http://www.caict.ac.cn>

Glossary:

DAE data acquisition electronics
Connector angle information used in DASY system to align probe sensor X to the robot coordinate system.

Methods Applied and Interpretation of Parameters:

- *DC Voltage Measurement:* Calibration Factor assessed for use in DASY system by comparison with a calibrated instrument traceable to national standards. The figure given corresponds to the full scale range of the voltmeter in the respective range.
- *Connector angle:* The angle of the connector is assessed measuring the angle mechanically by a tool inserted. Uncertainty is not required.
- The report provide only calibration results for DAE, it does not contain other performance test results.



Add: No.52 HuaYuanBei Road, Haidian District, Beijing, 100191, China
 Tel: +86-10-62304633-2117
 E-mail: emf@caict.ac.cn <http://www.caict.ac.cn>

DC Voltage Measurement

A/D - Converter Resolution nominal
 High Range: 1LSB = 6.1 μ V, full range = -100...+300 mV
 Low Range: 1LSB = 61nV, full range = -1.....+3mV
 DASY measurement parameters: Auto Zero Time: 3 sec; Measuring time: 3 sec

Calibration Factors	X	Y	Z
High Range	404.468 \pm 0.15% (k=2)	404.804 \pm 0.15% (k=2)	404.579 \pm 0.15% (k=2)
Low Range	3.95934 \pm 0.7% (k=2)	3.95437 \pm 0.7% (k=2)	3.91875 \pm 0.7% (k=2)

Connector Angle

Connector Angle to be used in DASY system	258.5 $^{\circ}$ \pm 1 $^{\circ}$
---	-------------------------------------



In Collaboration with
TTL Speag
 CALIBRATION LABORATORY
 Add: No.52 HuaYuanBei Road, Haidian District, Beijing, 100191
 Tel: +86-10-62304633-2117
 E-mail: emf@caict.ac.cn http://www.caict.ac.cn



中国认可
 国际互认
 校准
CAICT
 CALIBRATION
 CNAS L0570

Client **CTA**

Certificate No: **J23Z60387**

CALIBRATION CERTIFICATE

Object **D835V2 - SN: 484**

Calibration Procedure(s) **FF-Z11-003-01**
 Calibration Procedures for dipole validation kits

Calibration date: **August 25, 2023**

This calibration Certificate documents the traceability to national standards, which realize the physical units of measurements (SI). The measurements and the uncertainties with confidence probability are given on the following pages and are part of the certificate.

All calibrations have been conducted in the closed laboratory facility: environment temperature (22±3)°C and humidity<70%.

Calibration Equipment used (M&TE critical for calibration)

Primary Standards	ID #	Cal Date (Calibrated by, Certificate No.)	Scheduled Calibration
Power Meter NRP2	106277	22-Sep-22 (CTTL, No.J22X09561)	Sep-23
Power sensor NRP8S	104291	22-Sep-22 (CTTL, No.J22X09561)	Sep-23
Reference Probe EX3DV4	SN 3617	31-Mar-23(CTTL-SPEAG,No.Z23-60161)	Mar-24
DAE4	SN 1556	11-Jan-23(CTTL-SPEAG,No.Z23-60034)	Jan-24
Secondary Standards	ID #	Cal Date (Calibrated by, Certificate No.)	Scheduled Calibration
Signal Generator E4438C	MY49071430	05-Jan-23 (CTTL, No. J23X00107)	Jan-24
NetworkAnalyzer E5071C	MY46110673	10-Jan-23 (CTTL, No. J23X00104)	Jan-24

	Name	Function	Signature
Calibrated by:	Zhao Jing	SAR Test Engineer	
Reviewed by:	Lin Hao	SAR Test Engineer	
Approved by:	Qi Dianyuan	SAR Project Leader	

Issued: September 1, 2023

This calibration certificate shall not be reproduced except in full without written approval of the laboratory.



In Collaboration with
s p e a g
CALIBRATION LABORATORY



Add: No.52 HuaYuanBei Road, Haidian District, Beijing, 100191, China
Tel: +86-10-62304633-2117
E-mail: cmf@caict.ac.cn http://www.caict.ac.cn

Glossary:

TSL	tissue simulating liquid
ConvF	sensitivity in TSL / NORM _{x,y,z}
N/A	not applicable or not measured

Calibration is Performed According to the Following Standards:

- IEC/IEEE 62209-1528, "Measurement Procedure for The Assessment of Specific Absorption Rate of Human Exposure to Radio Frequency Fields from Hand-held and Body-mounted Wireless Communication Devices- Part 1528: Human Models, Instrumentation and Procedures (Frequency range of 4 MHz to 10 GHz)", October 2020
- KDB 865664, "SAR Measurement Requirements for 100 MHz to 6 GHz"

Additional Documentation:

- DASY4/5 System Handbook

Methods Applied and Interpretation of Parameters:

- Measurement Conditions:** Further details are available from the Validation Report at the end of the certificate. All figures stated in the certificate are valid at the frequency indicated.
- Antenna Parameters with TSL:** The dipole is mounted with the spacer to position its feed point exactly below the center marking of the flat phantom section, with the arms oriented parallel to the body axis.
- Feed Point Impedance and Return Loss:** These parameters are measured with the dipole positioned under the liquid filled phantom. The impedance stated is transformed from the measurement at the SMA connector to the feed point. The Return Loss ensures low reflected power. No uncertainty required.
- Electrical Delay:** One-way delay between the SMA connector and the antenna feed point. No uncertainty required.
- SAR measured:** SAR measured at the stated antenna input power.
- SAR normalized:** SAR as measured, normalized to an input power of 1 W at the antenna connector.
- SAR for nominal TSL parameters:** The measured TSL parameters are used to calculate the nominal SAR result.

The reported uncertainty of measurement is stated as the standard uncertainty of Measurement multiplied by the coverage factor $k=2$, which for a normal distribution Corresponds to a coverage probability of approximately 95%.

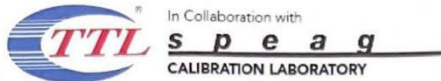

Add: No.52 HuaYuanBei Road, Haidian District, Beijing, 100191, China
 Tel: +86-10-62304633-2117
 E-mail: emf@caict.ac.cn http://www.caict.ac.cn

Measurement Conditions

DASY system configuration, as far as not given on page 1.

DASY Version	DASY52	V52.10.4
Extrapolation	Advanced Extrapolation	
Phantom	Triple Flat Phantom 5.1C	
Distance Dipole Center - TSL	15 mm	with Spacer
Zoom Scan Resolution	dx, dy, dz = 5 mm	
Frequency	835 MHz ± 1 MHz	

Head TSL parameters

The following parameters and calculations were applied.

	Temperature	Permittivity	Conductivity
Nominal Head TSL parameters	22.0 °C	41.5	0.90 mho/m
Measured Head TSL parameters	(22.0 ± 0.2) °C	42.1 ± 6 %	0.90 mho/m ± 6 %
Head TSL temperature change during test	<1.0 °C	---	---

SAR result with Head TSL

SAR averaged over 1 cm ³ (1 g) of Head TSL	Condition	
SAR measured	250 mW input power	2.42 W/kg
SAR for nominal Head TSL parameters	normalized to 1W	9.68 W/kg ± 18.8 % (k=2)
SAR averaged over 10 cm ³ (10 g) of Head TSL	Condition	
SAR measured	250 mW input power	1.56 W/kg
SAR for nominal Head TSL parameters	normalized to 1W	6.24 W/kg ± 18.7 % (k=2)



Add: No.52 HuaYuanBei Road, Haidian District, Beijing, 100191, China
 Tel: +86-10-62304633-2117
 E-mail: emf@caict.ac.cn http://www.caict.ac.cn

Appendix (Additional assessments outside the scope of CNAS L0570)

Antenna Parameters with Head TSL

Impedance, transformed to feed point	49.8Ω- 2.74jΩ
Return Loss	- 31.2dB

General Antenna Parameters and Design

Electrical Delay (one direction)	1.299 ns
----------------------------------	----------

After long term use with 100W radiated power, only a slight warming of the dipole near the feed-point can be measured.

The dipole is made of standard semirigid coaxial cable. The center conductor of the feeding line is directly connected to the second arm of the dipole. The antenna is therefore short-circuited for DC-signals. On some of the dipoles, small end caps are added to the dipole arms in order to improve matching when loaded according to the position as explained in the "Measurement Conditions" paragraph. The SAR data are not affected by this change. The overall dipole length is still according to the Standard.

No excessive force must be applied to the dipole arms, because they might bend or the soldered connections near the feed-point may be damaged.

Additional EUT Data

Manufactured by	SPEAG
-----------------	-------