



Shenzhen CTA Testing Technology Co., Ltd.

Room 106, Building 1, Yibaolai Industrial Park, Qiaotou Community, Fuhai Street, Bao'an District, Shenzhen, China

TEST REPORT

Report Reference No.: **CTA24062700509**

FCC ID: **2BHYZ-X30PRO**

Compiled by

(position+printed name+signature)...: File administrators Jinghua Xiao

Supervised by

(position+printed name+signature)...: Project Engineer Xudong Zhang



Approved by

(position+printed name+signature)...: RF Manager Eric Wang

Date of issue: July 30, 2024

Testing Laboratory Name: **Shenzhen CTA Testing Technology Co., Ltd.**

Address.....: Room 106, Building 1, Yibaolai Industrial Park, Qiaotou Community, Fuhai Street, Bao'an District, Shenzhen, China

Applicant's name: **Shenzhen Xin times chain technology Co., LTD**

Address.....: 6 / F, Block F, Huachuangda Science Park, 176 Hangcheng Avenue, Hangcheng Street, Sanwei Community, Baoan District, Shenzhen, Guangdong, China

Test specification..... :

Standard: **IEC 62209-2:2010; IEEE 1528:2013; FCC 47 CFR Part 2.1093; ANSI/IEEE C95.1:2005; Reference FCC KDB 447498; KDB 865664; KDB 248227; KDB 941225; KDB 616217**

Shenzhen CTA Testing Technology Co., Ltd. All rights reserved.

This publication may be reproduced in whole or in part for non-commercial purposes as long as the Shenzhen CTA Testing Technology Co., Ltd. is acknowledged as copyright owner and source of the material. Shenzhen CTA Testing Technology Co., Ltd. takes no responsibility for and will not assume liability for damages resulting from the reader's interpretation of the reproduced material due to its placement and context.

Test item description : **Tablet computer**

Trade Mark.....: N/A

Manufacturer.....: Shenzhen Xin times chain technology Co., LTD

Model/Type reference: X30Pro

Listed Models: T106, X30, X35, X70, X75, X70Pro, X50, X55, X50Pro, X90, X95, X90Pro, X101, X101Pro, X103, X103Pro, X105, X105Pro, X107, X107Pro

Rating: DC 3.7V From Battery and DC 5.0V From external circuit

Result.....: **PASS**

TEST REPORT

Equipment under Test : Tablet computer

Model /Type : X30Pro

Listed Models : T106, X30, X35, X70, X75, X70Pro, X50, X55, X50Pro, X90, X95, X90Pro, X101, X101Pro, X103, X103Pro, X105, X105Pro, X107, X107Pro

Applicant : **Shenzhen Xin times chain technology Co., LTD**

Address : 6 / F, block F, huachuangda Science Park, No. 176, Hangcheng Avenue, Sanwei community, Hangcheng street, Bao'an District, Shenzhen, China

Manufacturer : **Shenzhen Xin times chain technology Co., LTD**

Address : 6 / F, block F, huachuangda Science Park, No. 176, Hangcheng Avenue, Sanwei community, Hangcheng street, Bao'an District, Shenzhen, China

| | |
|---------------------|-------------|
| Test Result: | PASS |
|---------------------|-------------|

The test report merely corresponds to the test sample.

It is not permitted to copy extracts of these test result without the written permission of the test laboratory.

※ ※ Revision History ※ ※

| REV. | ISSUED DATE | DESCRIPTION |
|---------|---------------|-----------------------------|
| Rev.1.0 | July 30, 2024 | Initial Test Report Release |
| | | |
| | | |
| | | |

Contents

| | | |
|-------------|--|----|
| 1 | Statement of Compliance | 6 |
| 2 | General Information..... | 7 |
| 2.1 | General Remarks | 7 |
| 2.2 | Description of Equipment Under Test (EUT)..... | 7 |
| 2.3 | Device Category and SAR Limits | 7 |
| 2.4 | Applied Standard | 8 |
| 2.5 | Test Facility..... | 8 |
| 2.6 | Environment of Test Site..... | 9 |
| 2.7 | Test Configuration..... | 9 |
| 3 | Specific Absorption Rate (SAR) | 10 |
| 3.1 | Introduction..... | 10 |
| 3.2 | SAR Definition | 10 |
| 4 | SAR Measurement System | 11 |
| 4.1 | E-Field Probe..... | 11 |
| 4.2 | Data Acquisition Electronics (DAE)..... | 12 |
| 4.3 | Robot..... | 13 |
| 4.4 | Measurement Server | 13 |
| 4.5 | Phantom | 14 |
| 4.6 | Device Holder..... | 14 |
| 4.7 | Data Storage and Evaluation..... | 15 |
| 5 | Test Equipment List..... | 17 |
| 6 | Tissue Simulating Liquids..... | 18 |
| 7 | System Verification Procedures | 20 |
| 8 | EUT Testing Position..... | 22 |
| 8.1 | Body-Supported Device Configurations..... | 22 |
| 9 | Measurement Procedures | 23 |
| 9.1 | Spatial Peak SAR Evaluation | 23 |
| 9.2 | Power Reference Measurement | 23 |
| 9.3 | Area Scan Procedures | 24 |
| 9.4 | Zoom Scan Procedures..... | 24 |
| 9.5 | Volume Scan Procedures | 25 |
| 9.6 | Power Drift Monitoring..... | 25 |
| 10 | TEST CONDITIONS AND RESULTS..... | 26 |
| 10.1 | Conducted Power Results | 26 |
| 10.2 | Transmit Antennas..... | 37 |
| 10.3 | SAR Test Exclusion and Estimated SAR | 38 |
| 10.4 | SAR Test Results..... | 40 |
| 10.5 | SAR Measurement Variability | 43 |
| 10.6 | Simultaneous Transmission Analysis..... | 44 |
| 11 | Measurement Uncertainty | 45 |
| Appendix A. | EUT Photos and Test Setup Photos..... | 47 |
| Appendix B. | Plots of SAR System Check | 48 |

Appendix C. Plots of SAR Test Data..... 54

Appendix D. DASY System Calibration Certificate..... 60

1 Statement of Compliance

<Highest SAR Summary>

This device is in compliance with Specific Absorption Rate (SAR) for general population/uncontrolled exposure limits (1.6 W/kg) specified in FCC 47 CFR part 2 (2.1093) and ANSI/IEEE C95.1-2005, and had been tested in accordance with the measurement methods and procedures specified in IEEE 1528-2013. The maximum results of Specific Absorption Rate (SAR) found during testing are as follows.

<Highest SAR Summary>

| Frequency Band | Highest Reported 1g-SAR(W/Kg) | Simultaneous Reported SAR (W/Kg) |
|------------------------------|-------------------------------|----------------------------------|
| | Body (0mm) | |
| LTE Band 2 | 0.620 | 0.954 |
| LTE Band 4 | 0.648 | |
| LTE Band 12/17 | 0.504 | |
| WLAN2.4G | 0.281 | |
| WLAN5.2G | 0.306 | |
| WLAN5.8G | 0.227 | |
| SAR Test Limit (W/Kg) | 1.60 | |
| Test Result | PASS | |

Note: LTE band 17 SAR was covered by LTE Band 12 according to April 2015 TCB workshop, SAR test for overlapping LTE bands can be reduced if a. the maximum output power, including tolerance, for the smaller band is \leq the larger band to qualify for the SAR test exclusion. b. the channel bandwidth and other operating parameters for the smaller band are fully supported by the larger band.

2 General Information

2.1 General Remarks

| | | |
|--------------------------------|---|---------------|
| Date of receipt of test sample | : | July 16, 2024 |
| Testing commenced on | : | July 22, 2024 |
| Testing concluded on | : | July 29, 2024 |

2.2 Description of Equipment Under Test (EUT)

| | |
|-----------------------|---|
| Product Name: | Tablet computer |
| Model/Type reference: | X30Pro |
| Power supply: | DC 3.7V From Battery and DC 5.0V From external circuit |
| Adapter information: | Model: YJZN-012 Input: AC 100-240V 50/60Hz 0.3A Output: DC 5.0V 2.0A |
| Testing sample ID: | CTA240627005-1# (Engineer sample) CTA240627005-2# (Normal sample) |
| Hardware version: | V1.0 |
| Software version: | V1.0 |
| Tx Frequency: | SRD: BT:2402~2480MHz 2.4G WIFI: 2412~2462MHz 5G WIFI: 5180~5240MHz, 5745~5825MHz LTE: FDD Band 2: TX: 1850~1909MHz FDD Band 4: TX: 1710~1755MHz FDD Band 12: TX: 699~716MHz FDD Band 17: TX: 704~716MHz |
| Type of Modulation: | BT: GFSK, $\pi/4$ DQPSK, 8DPSK 2.4G WIFI: BPSK, QPSK, 16QAM, 64QAM 5G WIFI: BPSK, QPSK, 16QAM, 64QAM, 256QAM LTE: QPSK, 16QAM |
| Category of device: | Portable device |
| Remark: | The above DUT's information was declared by manufacturer. Please refer to the specifications or user's manual for more detailed description. |

2.3 Device Category and SAR Limits

This device belongs to portable device category because its radiating structure is allowed to be used within 20 centimeters of the body of the user. Limit for General Population/Uncontrolled exposure should be applied for this device, it is 1.6 W/kg as averaged over any 1 gram of tissue.

2.4 Applied Standard

The Specific Absorption Rate (SAR) testing specification, method, and procedure for this device is in accordance with the following standards:

- FCC 47 CFR Part 2 (2.1093:2013)
- ANSI/IEEE C95.1:2005
- IEEE Std 1528:2013
- KDB 865664 D01 SAR Measurement 100 MHz to 6 GHz v01r04
- KDB 865664 D02 RF Exposure Reporting v01r02
- KDB 447498 D01 General RF Exposure Guidance v06
- KDB 248227 D01 802.11 Wi-Fi SAR v02r02
- KDB 941225 D05 SAR for LTE Devices v02r05
- KDB 616217 D04 SAR for laptop and tablets v01r02

2.5 Test Facility

FCC-Registration No.: 517856 Designation Number: CN1318

Shenzhen CTA Testing Technology Co., Ltd. has been listed on the US Federal Communications Commission list of test facilities recognized to perform electromagnetic emissions measurements.

A2LA-Lab Cert. No.: 6534.01

Shenzhen CTA Testing Technology Co., Ltd. has been listed by American Association for Laboratory Accreditation to perform electromagnetic emission measurement.

ISED#: 27890 CAB identifier: CN0127

Shenzhen CTA Testing Technology Co., Ltd. has been listed by Innovation, Science and Economic Development Canada to perform electromagnetic emission measurement.

The 3m-Semi anechoic test site fulfills CISPR 16-1-4 according to ANSI C63.10 and CISPR 16-1-4:2010.

2.6 Environment of Test Site

| Items | Required | Actual |
|------------------|----------|--------|
| Temperature (°C) | 18-25 | 22~23 |
| Humidity (%RH) | 30-70 | 55~65 |

2.7 Test Configuration

The device was controlled by using a base station emulator. Communication between the device and the emulator was established by air link. The distance between the EUT and the antenna of the emulator is larger than 50 cm and the output power radiated from the emulator antenna is at least 30 dB smaller than the output power of EUT. The EUT was set from the emulator to radiate maximum output power during all tests. For WLAN SAR testing, WLAN engineering testing software installed on the EUT can provide continuous transmitting RF signal.

3 Specific Absorption Rate (SAR)

3.1 Introduction

SAR is related to the rate at which energy is absorbed per unit mass in an object exposed to a radio field. The SAR distribution in a biological body is complicated and is usually carried out by experimental techniques or numerical modeling. The standard recommends limits for two tiers of groups, occupational/controlled and general population/uncontrolled, based on a person's awareness and ability to exercise control over his or her exposure. In general, occupational/controlled exposure limits are higher than the limits for general population/uncontrolled.

3.2 SAR Definition

The SAR definition is the time derivative (rate) of the incremental energy (dW) absorbed by (dissipated in) an incremental mass (dm) contained in a volume element (dv) of a given density (ρ). The equation description is as below:

$$\text{SAR} = \frac{d}{dt} \left(\frac{dW}{dm} \right) = \frac{d}{dt} \left(\frac{dW}{\rho dv} \right)$$

SAR is expressed in units of Watts per kilogram (W/kg)

SAR measurement can be either related to the temperature elevation in tissue by

$$\text{SAR} = c \left(\frac{\delta T}{\delta t} \right)$$

Where: C is the specific heat capacity, δT is the temperature rise and δt is the exposure duration, or related to the electrical field in the tissue by

$$\text{SAR} = \frac{\sigma |E|^2}{\rho}$$

Where: σ is the conductivity of the tissue, ρ is the mass density of the tissue and E is the RMS electrical field strength.

However for evaluating SAR of low power transmitter, electrical field measurement is typically applied.

4 SAR Measurement System

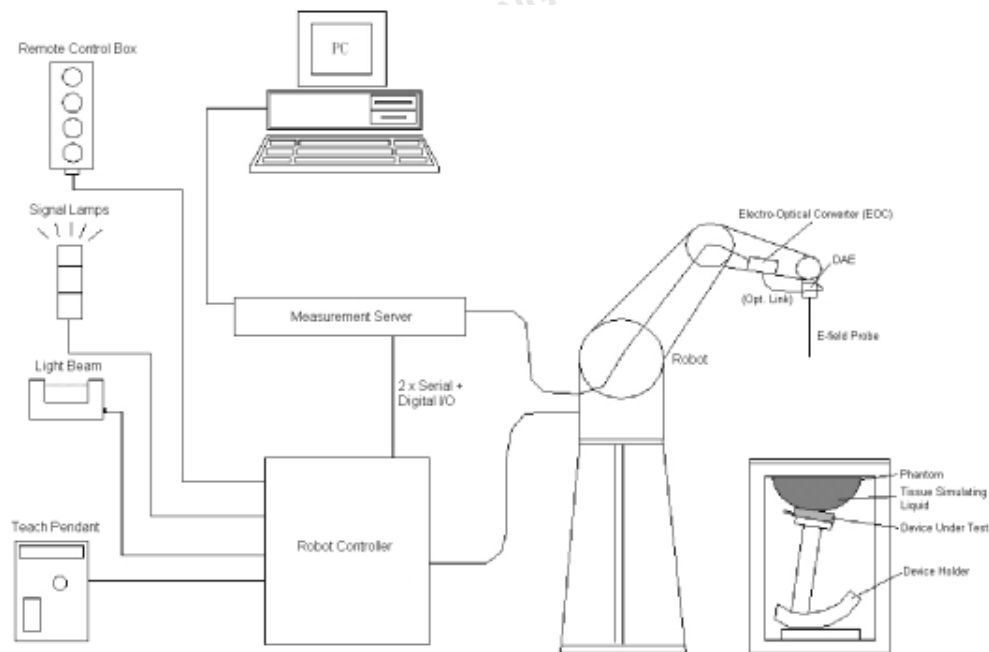

DASY System Configurations

The DASY system for performance compliance tests is illustrated above graphically. This system consists of the following items:

- A standard high precision 6-axis robot with controller, a teach pendant and software
- A data acquisition electronic (DAE) attached to the robot arm extension
- A dosimetric probe equipped with an optical surface detector system
- The electro-optical converter (EOC) performs the conversion between optical and electrical signals
- A measurement server performs the time critical tasks such as signal filtering, control of the robot operation and fast movement interrupts.
- A probe alignment unit which improves the accuracy of the probe positioning
- A computer operating Windows XP
- DASY software
- Remote control with teach pendant and additional circuitry for robot safety such as warning lamps, etc.
- The SAM twin phantom
- A device holder
- Tissue simulating liquid
- Dipole for evaluating the proper functioning of the system

components are described in details in the following sub-sections.

4.1 E-Field Probe

The SAR measurement is conducted with the dosimetric probe (manufactured by SPEAG). The probe is specially designed and calibrated for use in liquid with high permittivity. The dosimetric probe has special calibration in liquid at different frequency. This probe has a built in optical surface detection system to prevent from collision with phantom.

➤ E-Field Probe Specification

<EX3DV4 Probe>

| | | |
|----------------------|---|---|
| Construction | Symmetrical design with triangular core Built-in shielding against static charges PEEK enclosure material (resistant to organic solvents, e.g., DGBE) |  <p style="text-align: center;">Photo of EX3DV4</p> |
| Frequency | 10 MHz to 6 GHz; Linearity: ± 0.2 dB | |
| Directivity | ± 0.3 dB in HSL (rotation around probe axis) ± 0.5 dB in tissue material (rotation normal to probe axis) | |
| Dynamic Range | 10 μ W/g to 100 W/kg; Linearity: ± 0.2 dB (noise: typically < 1 μ W/g) | |
| Dimensions | Overall length: 330 mm (Tip: 20 mm) Tip diameter: 2.5 mm (Body: 12 mm) Typical distance from probe tip to dipole centers: 1 mm | |

➤ E-Field Probe Calibration

Each probe needs to be calibrated according to a dosimetric assessment procedure with accuracy better than $\pm 10\%$. The spherical isotropy shall be evaluated and within ± 0.25 dB. The sensitivity parameters (NormX, NormY, and NormZ), the diode compression parameter (DCP) and the conversion factor (ConvF) of the probe are tested. The calibration data can be referred to appendix C of this report.

4.2 Data Acquisition Electronics (DAE)

The data acquisition electronics (DAE) consists of a highly sensitive electrometer-grade preamplifier with auto-zeroing, a channel and gain-switching multiplexer, a fast 16 bit AD-converter and a command decoder and control logic unit. Transmission to the measurement server is accomplished through an optical downlink for data and status information as well as an optical uplink for commands and the clock. The input impedance of the DAE is 200M Ω ; the inputs are symmetrical and floating. Common mode rejection is above 80dB.



Photo of DAE

4.3 Robot

The SPEAG DASY system uses the high precision robots (DASY5: TX60XL) type from Stäubli SA (France). For the 6-axis controllersystem, the robot controller version (DASY5: CS8c) from Stäubli is used. The Stäublirobot series have many features that are important for our application:

- High precision (repeatability ± 0.035 mm)
- High reliability (industrial design)
- Jerk-free straight movements
- Low ELF interference (the closed metallic construction shields against motor control fields)



Photo of DASY5

4.4 Measurement Server

The measurement server is based on a PC/104 CPU board with CPU (DASY5: 400 MHz, Intel Celeron), chipdisk (DASY5: 128 MB), RAM (DASY5: 128 MB). The necessary circuits for communication with the DAE electronic box, as well as the 16 bit AD converter system for optical detection and digital I/O interface are contained on the DASY I/O board, which is directly connected to the PC/104 bus of the CPU board.

The measurement server performs all the real-time data evaluation for field measurements and surface detection, controls robot movements and handles safety operations.



Photo of Server for DASY5

4.5 Phantom

<SAM Twin Phantom>

| | | |
|--------------------------|--|--|
| Shell Thickness | 2 ± 0.2 mm; Center ear point: 6 ± 0.2 mm |  |
| Filling Volume | Approx. 25 liters | |
| Dimensions | Length: 1000 mm; Width: 500 mm; Height: adjustable feet | |
| Measurement Areas | Left Hand, Right Hand, Flat Phantom | |

Photo of SAM Phantom

The bottom plate contains three pair of bolts for locking the device holder. The device holder positions are adjusted to the standard measurement positions in the three sections. A white cover is provided to tap the phantom during off-periods to prevent water evaporation and changes in the liquid parameters. On the phantom top, three reference markers are provided to identify the phantom position with respect to the robot.

<ELI4 Phantom>

| | | |
|------------------------|--|--|
| Shell Thickness | 2 ± 0.2 mm (sagging: <1%) |  |
| Filling Volume | Approx. 30 liters | |
| Dimensions | Major ellipse axis: 600 mm Minor axis: 400 mm | |

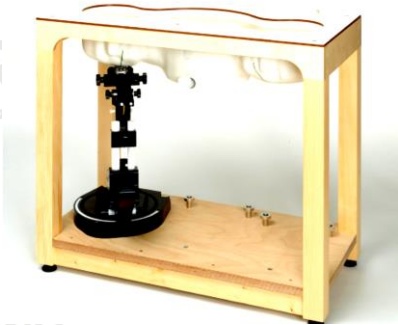
Photo of ELI4 Phantom

The ELI4 phantom is intended for compliance testing of handheld and body-mounted wireless devices in the frequency range of 30 MHz to 6 GHz. ELI4 is fully compatible with standard and all known tissue simulating liquids.

4.6 Device Holder

The SAR in the phantom is approximately inversely proportional to the square of the distance between the source and the liquid surface. For a source at 5 mm distance, a positioning uncertainty of ±0.5mm would produce a SAR uncertainty of ± 20%. Accurate device positioning is therefore crucial for accurate and repeatable measurements. The positions in which the devices must be measured are defined by the standards.

The DASY device holder is designed to cope with different positions given in the standard. It has two scales for the device rotation (with respect to the body axis) and the device inclination (with respect to the line between the ear reference points). The rotation center for both scales is the ear reference point (ERP). Thus the device needs no repositioning when changing the angles.

The DASY device holder is constructed of low-loss POM material having the following dielectric parameters: relative permittivity $\epsilon = 3$ and loss tangent $\delta = 0.02$. The amount of dielectric material has been reduced in the closest vicinity of the device, since measurements have suggested that the influence of the clamp on the test results could thus be lowered.



Device Holder

4.7 Data Storage and Evaluation

➤ Data Storage

The DASY software stores the assessed data from the data acquisition electronics as raw data (in microvolt readings from the probe sensors), together with all the necessary software parameters for the data evaluation (probe calibration data, liquid parameters and device frequency and modulation data) in measurement files. The post-processing software evaluates the desired unit and format for output each time the data is visualized or exported. This allows verification of the complete software setup even after the measurement and allows correction of erroneous parameter settings. For example, if a measurement has been performed with an incorrect crest factor parameter in the device setup, the parameter can be corrected afterwards and the data can be reevaluated.

The measured data can be visualized or exported in different units or formats, depending on the selected probe type (e.g., [V/m], [A/m], [W/kg]). Some of these units are not available in certain situations or give meaningless results, e.g., a SAR-output in a non-lose media, will always be zero. Raw data can also be exported to perform the evaluation with other software packages.

➤ Data Evaluation

The DASY post-processing software (SEMCAD) automatically executes the following procedures to calculate the field units from the microvolt readings at the probe connector. The parameters used in the evaluation are stored in the configuration modules of the software:

| | | |
|---------------------------|---------------------------|---|
| Probe parameters: | - Sensitivity | Norm _i , a _{i0} , a _{i1} , a _{i2} |
| | - Conversion factor | ConvF _i |
| | - Diode compression point | dcp _i |
| Device parameters: | - Frequency | f |
| | - Crest factor | cf |
| Media parameters: | - Conductivity | σ |
| | - Density | ρ |

These parameters must be set correctly in the software. They can be found in the component documents or they can be imported into the software from the configuration files issued for the DASY components. In the direct measuring mode of the multi-meter option, the parameters of the actual system setup are used. In the scan visualization and export modes, the parameters stored in the corresponding document files are used.

The first step of the evaluation is a linearization of the filtered input signal to account for the compression characteristics of the detector diode. The compensation depends on the input signal, the diode type and the DC-transmission factor from the diode to the evaluation electronics. If the exciting field is pulsed, the crest factor of the signal must be known to correctly compensate for peak power.

The formula for each channel can be given as:

$$V_i = U_i + U_i^2 \cdot \frac{cf}{dcp_i}$$

with V_i = compensated signal of channel i , ($i = x, y, z$)

U_i = input signal of channel i , ($i = x, y, z$)

cf = crest factor of exciting field (DASY parameter)

dcp_i = diode compression point (DASY parameter)

From the compensated input signals, the primary field data for each channel can be evaluated:

$$\text{E-field Probes: } E_i = \sqrt{\frac{V_i}{\text{Norm}_i \cdot \text{ConvF}}}$$

$$\text{H-field Probes: } H_i = \sqrt{V_i} \cdot \frac{a_{i0} + a_{i1}f + a_{i2}f^2}{f}$$

with V_i = compensated signal of channel i , ($i = x, y, z$)

Norm_i = sensor sensitivity of channel i , ($i = x, y, z$), $\mu\text{V}/(\text{V/m})^2$ for E-field Probes

ConvF = sensitivity enhancement in solution

a_{ij} = sensor sensitivity factors for H-field probes

f = carrier frequency [GHz]

E_i = electric field strength of channel i in V/m

H_i = magnetic field strength of channel i in A/m

The RSS value of the field components gives the total field strength (Hermitian magnitude):

$$E_{\text{tot}} = \sqrt{E_x^2 + E_y^2 + E_z^2}$$

The primary field data are used to calculate the derived field units.

$$\text{SAR} = E_{\text{tot}}^2 \cdot \frac{\sigma}{\rho \cdot 1000}$$

with SAR = local specific absorption rate in W/kg

E_{tot} = total field strength in V/m

σ = conductivity in [mho/m] or [Siemens/m]

ρ = equivalent tissue density in g/cm^3

Note that the density is set to 1, to account for actual head tissue density rather than the density of the tissue simulating liquid.

5 Test Equipment List

| Manufacturer | Name of Equipment | Type/Model | Serial Number | Calibration | |
|-----------------|--------------------------------------|----------------|------------------------|--------------|--------------|
| | | | | Last Cal. | Due Date |
| SPEAG | 750MHz System Validation Kit | D750V3 | 1194 | Feb. 17,2023 | Feb. 16,2026 |
| SPEAG | 1800MHz System Validation Kit | D1800V2 | 2d158 | Dec. 17,2021 | Dec. 16,2024 |
| SPEAG | 1900MHz System Validation Kit | D1900V2 | 5d002 | Aug. 25,2023 | Aug. 24,2026 |
| SPEAG | 2450MHz System Validation Kit | D2450V2 | 745 | Aug. 28,2023 | Aug. 27,2026 |
| SPEAG | 5GHz System Validation Kit | D5GHzV2 | 1301 | Feb.16, 2023 | Feb.15, 2026 |
| Rohde & Schwarz | UNIVERSAL RADIO COMMUNICATION TESTER | CMW500 | 1201.0002K50-104209-JC | Nov.05, 2023 | Nov.04, 2024 |
| SPEAG | Data Acquisition Electronics | DAE3 | 428 | Aug.30,2023 | Aug.29,2024 |
| SPEAG | Dosimetric E-Field Probe | EX3DV4 | 7624 | Sep. 06,2023 | Sep. 05,2024 |
| Agilent | ENA Series Network Analyzer | E5071C | MY46317418 | Oct.25, 2023 | Oct.24, 2024 |
| SPEAG | DAK | DAK-3.5 | 1226 | NCR | NCR |
| SPEAG | SAM Twin Phantom | QD000P40CD | 1802 | NCR | NCR |
| SPEAG | ELI Phantom | QDOVA004AA | 2058 | NCR | NCR |
| AR | Amplifier | ZHL-42W | QA1118004 | NCR | NCR |
| Agilent | Power Meter | N1914A | MY50001102 | Oct.25, 2023 | Oct.24, 2024 |
| Agilent | Power Sensor | N8481H | MY51240001 | Oct.25, 2023 | Oct.24, 2024 |
| R&S | Spectrum Analyzer | N9020A | MY51170037 | Oct.25, 2023 | Oct.24, 2024 |
| Agilent | Signal Generation | N5182A | MY48180656 | Oct.25, 2023 | Oct.24, 2024 |
| Worken | Directional Coupler | 0110A05601O-10 | COM5BNW1A2 | Oct.25, 2023 | Oct.24, 2024 |

Note:

1. The calibration certificate of DASYS can be referred to appendix C of this report.
2. The dipole calibration interval can be extended to 3 years with justification. The dipoles are also not physically damaged, or repaired during the interval.
3. The Insertion Loss calibration of Dual Directional Coupler and Attenuator were characterized via the network analyzer and compensated during system check.
4. The dielectric probe kit was calibrated via the network analyzer, with the specified procedure (calibrated in pure water) and calibration kit (standard) short circuit, before the dielectric measurement. The specific procedure and calibration kit are provided by Agilent.
5. In system check we need to monitor the level on the power meter, and adjust the power amplifier level to have precise power level to the dipole; the measured SAR will be normalized to 1W input power according to the ratio of 1W to the input power to the dipole. For system check, the calibration of the power amplifier is deemed not critically required for correct measurement; the power meter is critical and we do have calibration for it

6 Tissue Simulating Liquids

For the measurement of the field distribution inside the SAM phantom with DASY, the phantom must be filled with around 25 liters of homogeneous body tissue simulating liquid. For head SAR testing, the liquid height from the ear reference point (ERP) of the phantom to the liquid top surface is larger than 15 cm, which is shown in Fig. 6.1. For body SAR testing, the liquid height from the center of the flat phantom to the liquid top surface is larger than 15 cm, which is shown as followed:



Photo of Liquid Height

The following table gives the recipes for tissue simulating liquid.

| Frequency (MHz) | Water (%) | Sugar (%) | Cellulose (%) | Salt (%) | Preventol (%) | DGBE (%) | Conductivity (σ) | Permittivity (ϵ_r) |
|-----------------|-----------|-----------|---------------|----------|---------------|----------|---------------------------|-------------------------------|
| For Head | | | | | | | | |
| 835 | 40.3 | 57.9 | 0.2 | 1.4 | 0.2 | 0 | 0.90 | 41.5 |
| 1800,1900,2000 | 55.2 | 0 | 0 | 0.3 | 0 | 44.5 | 1.40 | 40.0 |
| 2450 | 55.0 | 0 | 0 | 0 | 0 | 45.0 | 1.80 | 39.2 |
| 2600 | 54.8 | 0 | 0 | 0.1 | 0 | 45.1 | 1.96 | 39.0 |
| For Body | | | | | | | | |
| 835 | 50.8 | 48.2 | 0 | 0.9 | 0.1 | 0 | 0.97 | 55.2 |
| 1800,1900,2000 | 70.2 | 0 | 0 | 0.4 | 0 | 29.4 | 1.52 | 53.3 |
| 2450 | 68.6 | 0 | 0 | 0 | 0 | 31.4 | 1.95 | 52.7 |
| 2600 | 65.5 | 0 | 0 | 0 | 0 | 31.5 | 2.16 | 52.5 |

The following table shows the measuring results for simulating liquid.

| Measured Frequency (MHz) | Target Tissue | | Measured Tissue | | | | Liquid Temp. | Test Data |
|--------------------------|---------------|----------|-----------------|----------|----------|----------|--------------|------------|
| | ϵ_r | σ | ϵ_r | Dev. (%) | σ | Dev. (%) | | |
| 750 | 41.9 | 0.89 | 40.978 | -2.20% | 0.870 | -2.21% | 22.6 | 07/22/2024 |
| 1750 | 40.1 | 1.37 | 39.098 | -2.50% | 1.336 | -2.46% | 22.5 | 07/23/2024 |
| 1900 | 40.0 | 1.40 | 41.304 | 3.26% | 1.331 | -4.92% | 22.6 | 07/24/2024 |
| 2450 | 39.2 | 1.80 | 39.039 | -0.41% | 1.738 | -3.47% | 22.7 | 07/25/2024 |
| 5250 | 35.9 | 4.71 | 35.670 | -0.64% | 4.702 | -0.18% | 22.2 | 07/26/2024 |
| 5750 | 35.4 | 5.22 | 34.480 | -2.60% | 5.365 | 2.77% | 22.3 | 07/29/2024 |

7 System Verification Procedures

Each DASY system is equipped with one or more system validation kits. These units, together with the predefined measurement procedures within the DASY software, enable the user to conduct the system performance check and system validation. System validation kit includes a dipole, tripod holder to fix it underneath the flat phantom and a corresponding distance holder.

➤ Purpose of System Performance check

The system performance check verifies that the system operates within its specifications. System and operator errors can be detected and corrected. It is recommended that the system performance check be performed prior to any usage of the system in order to guarantee reproducible results. The system performance check uses normal SAR measurements in a simplified setup with a well characterized source. This setup was selected to give a high sensitivity to all parameters that might fail or vary over time. The system check does not intend to replace the calibration of the components, but indicates situations where the system uncertainty is exceeded due to drift or failure.

➤ System Setup

In the simplified setup for system evaluation, the EUT is replaced by a calibrated dipole and the power source is replaced by a continuous wave that comes from a signal generator. The calibrated dipole must be placed beneath the flat phantom section of the SAM twin phantom with the correct distance holder. The distance holder should touch the phantom surface with a light pressure at the reference marking and be oriented parallel to the long side of the phantom. The equipment setup is shown below:

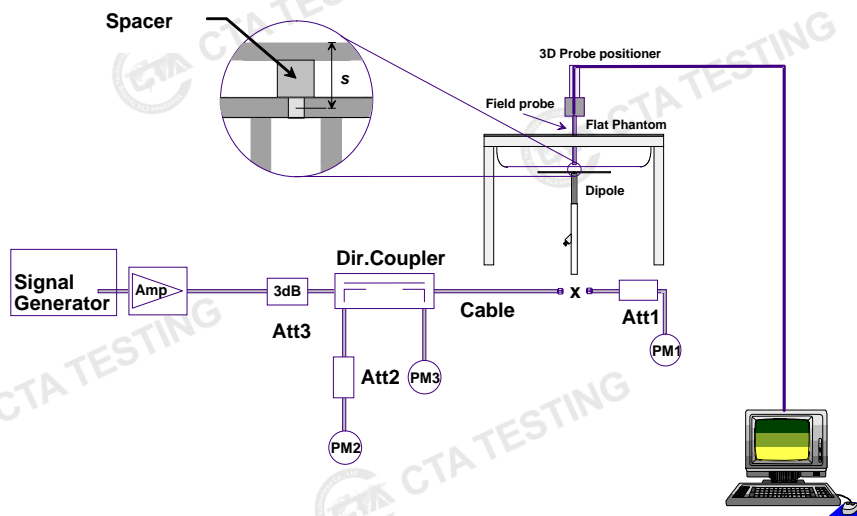

System Setup for System Evaluation

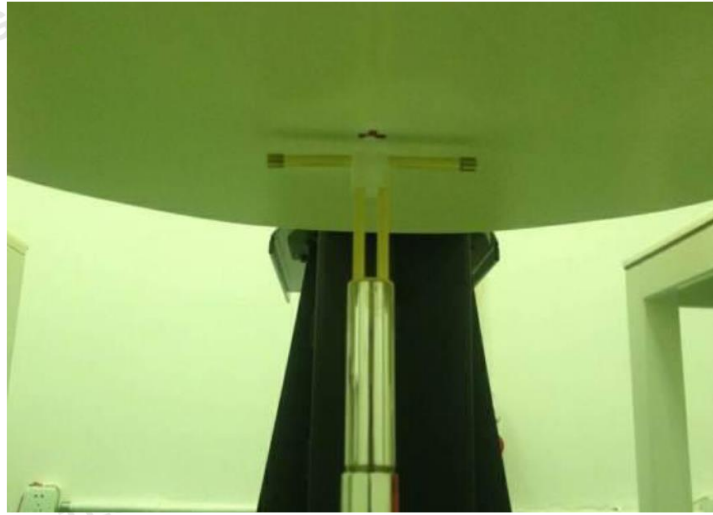

Photo of Dipole Setup

➤ Validation Results

Comparing to the original SAR value provided by SPEAG, the verification data should be within its specification of 10%. The table below shows the target SAR and measured SAR after normalized to 1W input power. It indicates that the system performance check can meet the variation criterion and the plots can be referred to Appendix A of this report.

| Date | Frequency (MHz) | Power fed onto reference dipole (mW) | Targeted SAR 1g (W/kg) | Measured SAR1g (W/kg) | Normalized SAR (W/kg) | Deviation (%) |
|------------|-----------------|--------------------------------------|------------------------|-----------------------|-----------------------|---------------|
| 07/22/2024 | 750 | 250 | 8.57 | 2.16 | 8.64 | 1.02% |
| 07/23/2024 | 1750 | 250 | 39.2 | 10.18 | 40.72 | 3.88% |
| 07/24/2024 | 1900 | 250 | 40.1 | 9.66 | 38.64 | -3.69% |
| 07/25/2024 | 2450 | 250 | 52.7 | 12.99 | 51.96 | -1.44% |
| 07/26/2024 | 5250 | 100 | 77.7 | 7.78 | 77.80 | 0.12% |
| 07/29/2024 | 5750 | 100 | 78.0 | 7.95 | 79.50 | 1.98% |

8 EUT Testing Position

8.1 Body-Supported Device Configurations

According to KDB 616217 section 4.3, SAR should be separately assessed with each surface and separation distance positioned against the flat phantom that correspond to the intended use as specified by the manufacturer. The antennas in tablets are typically located near the back (bottom) surface and/or along the edges of the devices; therefore, SAR evaluation is required for these configurations. Exposures from antennas through the front (top) surface of the display section of a full-size tablet, away from the edges, are generally limited to the user's hands. Exposures to hands for typical consumer transmitters used in tablets are not expected to exceed the extremity SAR limit; therefore, SAR evaluation for the front surface of tablet display screens are generally not necessary, except for tablets that are designed to require continuous operations with the hand(s) next to the antenna(s).

- To position the device parallel to the phantom surface with either keypad up or down.
- To adjust the device parallel to the flat phantom.
- To adjust the distance between the device surface and the flat phantom to 0 mm.
- When each surface is measurement, the SAR Test Exclusion Threshold in KDB 447498 should be applied.

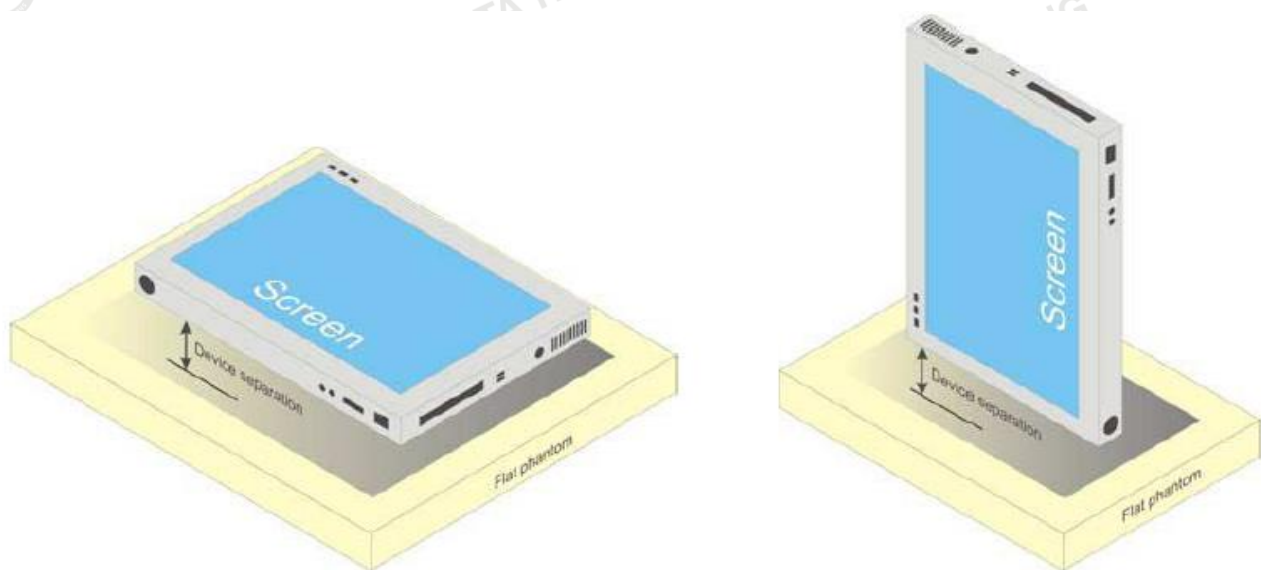

Fig.81 Illustration for Body Position

9 Measurement Procedures

The measurement procedures are as follows:

- (a) Use base station simulator (if applicable) or engineering software to transmit RF power continuously (continuous Tx) in the middle channel.
- (b) Keep EUT to radiate maximum output power or 100% duty factor (if applicable)
- (c) Measure output power through RF cable and power meter.
- (d) Place the EUT in the positions as setup photos demonstrates.
- (e) Set scan area, grid size and other setting on the DASY software.
- (f) Measure SAR transmitting at the middle channel for all applicable exposure positions.
- (g) Identify the exposure position and device configuration resulting the highest SAR
- (h) Measure SAR at the lowest and highest channels at the worst exposure position and device configuration if applicable.

According to the test standard, the recommended procedure for assessing the peak spatial-average SAR value consists of the following steps:

- (a) Power reference measurement
- (b) Area scan
- (c) Zoom scan
- (d) Power drift measurement

9.1 Spatial Peak SAR Evaluation

The procedure for spatial peak SAR evaluation has been implemented according to the test standard. It can be conducted for 1g and 10g, as well as for user-specific masses. The DASY software includes all numerical procedures necessary to evaluate the spatial peak SAR value.

The base for the evaluation is a "cube" measurement. The measured volume must include the 1g and 10g cubes with the highest averaged SAR values. For that purpose, the center of the measured volume is aligned to the interpolated peak SAR value of a previously performed area scan.

The entire evaluation of the spatial peak values is performed within the post-processing engine (SEMCAD). The system always gives the maximum values for the 1g and 10g cubes. The algorithm to find the cube with highest averaged SAR is divided into the following stages:

- (a) Extraction of the measured data (grid and values) from the Zoom Scan
- (b) Calculation of the SAR value at every measurement point based on all stored data (A/D values and measurement parameters)
- (c) Generation of a high-resolution mesh within the measured volume
- (d) Interpolation of all measured values from the measurement grid to the high-resolution grid
- (e) Extrapolation of the entire 3-D field distribution to the phantom surface over the distance from sensor to surface
- (f) Calculation of the averaged SAR within masses of 1g and 10g

9.2 Power Reference Measurement

The Power Reference Measurement and Power Drift Measurements are for monitoring the power drift of the device under test in the batch process. The minimum distance of probe sensors to surface determines the closest measurement point to phantom surface. This distance cannot be smaller than the distance of sensor calibration points to probe tip as defined in the probe properties.

9.3 Area Scan Procedures

The area scan is used as a fast scan in two dimensions to find the area of high field values, before doing a fine measurement around the hot spot. The sophisticated interpolation routines implemented in DASY software can find the maximum found in the scanned area, within a range of the global maximum. The range (in dB) is specified in the standards for compliance testing. For example, a 2 dB range is required in IEEE standard 1528 and IEC 62209 standards, whereby 3 dB is a requirement when compliance is assessed in accordance with the ARIB standard (Japan), if only one zoom scan follows the area scan, then only the absolute maximum will be taken as reference. For cases where multiple maximums are detected, the number of zoom scans has to be increased accordingly.

Area scan parameters extracted from FCC KDB 865664 D01 SAR measurement 100 MHz to 6 GHz.

| | ≤ 3 GHz | > 3 GHz |
|--|---|---|
| Maximum distance from closest measurement point (geometric center of probe sensors) to phantom surface | 5 mm ± 1 mm | $\frac{1}{2} \cdot \delta \cdot \ln(2)$ mm ± 0.5 mm |
| Maximum probe angle from probe axis to phantom surface normal at the measurement location | 30° ± 1° | 20° ± 1° |
| Maximum area scan spatial resolution: Δx_{Area} , Δy_{Area} | ≤ 2 GHz: ≤ 15 mm 2 – 3 GHz: ≤ 12 mm | 3 – 4 GHz: ≤ 12 mm 4 – 6 GHz: ≤ 10 mm |
| | When the x or y dimension of the test device, in the measurement plane orientation, is smaller than the above, the measurement resolution must be ≤ the corresponding x or y dimension of the test device with at least one measurement point on the test device. | |

9.4 Zoom Scan Procedures

Zoom scans are used to assess the peak spatial SAR values within a cubic averaging volume containing 1 gram and 10gram of simulated tissue. The zoom scan measures points (refer to table below) within a cube whose base faces are centered on the maxima found in a preceding area scan job within the same procedure. When the measurement is done, the zoom scan evaluates the averaged SAR for 1 gram and 10 gram and displays these values next to the job's label.

Zoom scan parameters extracted from FCC KDB 865664 D01 SAR measurement 100 MHz to 6 GHz.

| | | | ≤ 3 GHz | > 3 GHz |
|--|------------------------------------|--|--|---|
| Maximum zoom scan spatial resolution: Δx_{Zoom} , Δy_{Zoom} | | | ≤ 2 GHz: ≤ 8 mm 2 – 3 GHz: ≤ 5 mm* | 3 – 4 GHz: ≤ 5 mm* 4 – 6 GHz: ≤ 4 mm* |
| Maximum zoom scan spatial resolution, normal to phantom surface | uniform grid: $\Delta z_{Zoom}(n)$ | | ≤ 5 mm | 3 – 4 GHz: ≤ 4 mm 4 – 5 GHz: ≤ 3 mm 5 – 6 GHz: ≤ 2 mm |
| | graded grid | $\Delta z_{Zoom}(1)$: between 1 st two points closest to phantom surface | ≤ 4 mm | 3 – 4 GHz: ≤ 3 mm 4 – 5 GHz: ≤ 2.5 mm 5 – 6 GHz: ≤ 2 mm |
| | | $\Delta z_{Zoom}(n>1)$: between subsequent points | ≤ 1.5 · $\Delta z_{Zoom}(n-1)$ mm | |
| Minimum zoom scan volume | x, y, z | ≥ 30 mm | 3 – 4 GHz: ≥ 28 mm 4 – 5 GHz: ≥ 25 mm 5 – 6 GHz: ≥ 22 mm | |
| Note: δ is the penetration depth of a plane-wave at normal incidence to the tissue medium; see IEEE Std 1528-2013 for details. * When zoom scan is required and the <i>reported</i> SAR from the <i>area scan based 1-g SAR estimation</i> procedures of KDB Publication 447498 is ≤ 1.4 W/kg, ≤ 8 mm, ≤ 7 mm and ≤ 5 mm zoom scan resolution may be applied, respectively, for 2 GHz to 3 GHz, 3 GHz to 4 GHz and 4 GHz to 6 GHz. | | | | |

9.5 Volume Scan Procedures

The volume scan is used for assess overlapping SAR distributions for antennas transmitting in different frequency bands. It is equivalent to an oversized zoom scan used in standalone measurements. The measurement volume will be used to enclose all the simultaneous transmitting antennas. For antennas transmitting simultaneously in different frequency bands, the volume scan is measured separately in each frequency band. In order to sum correctly to compute the 1g aggregate SAR, the EUT remain in the same test position for all measurements and all volume scan use the same spatial resolution and grid spacing. When all volume scan were completed, the software, SEMCAD postprocessor can combine and subsequently superpose these measurement data to calculating the multiband SAR.

9.6 Power Drift Monitoring

All SAR testing is under the EUT install full charged battery and transmit maximum output power. In DASY measurement software, the power reference measurement and power drift measurement procedures are used for monitoring the power drift of EUT during SAR test. Both these procedures measure the field at a specified reference position before and after the SAR testing. The software will calculate the field difference in dB. If the power drift more than 5%, the SAR will be retested.

10 TEST CONDITIONS AND RESULTS

10.1 Conducted Power Results

<LTE Conducted Power>

| LTE Band 2 | | | | | | | |
|------------|------------|---------|-----------|------------------------|--------------|--------------|---------------------|
| BW (MHz) | Modulation | RB Size | RB Offset | Channel/Frequency(MHz) | | | Tune-up limit (dBm) |
| | | | | 18700 | 18900 | 19100 | |
| | | | | 1860 | 1880 | 1900 | |
| 20 | QPSK | 1 | 0 | 23.27 | 23.18 | 23.02 | 23.0 |
| 20 | QPSK | 1 | 49 | 23.72 | 23.55 | 23.29 | |
| 20 | QPSK | 1 | 99 | 23.65 | 23.76 | 23.38 | |
| 20 | QPSK | 50 | 0 | 22.10 | 22.29 | 22.17 | 22.0 |
| 20 | QPSK | 50 | 24 | 22.41 | 22.31 | 22.11 | |
| 20 | QPSK | 50 | 50 | 22.37 | 22.11 | 22.28 | |
| 20 | QPSK | 100 | 0 | 22.39 | 22.22 | 22.34 | 22.0 |
| 20 | 16QAM | 1 | 0 | 22.08 | 22.22 | 22.40 | |
| 20 | 16QAM | 1 | 49 | 22.26 | 22.31 | 22.39 | |
| 20 | 16QAM | 1 | 99 | 22.11 | 22.12 | 22.01 | 22.0 |
| 20 | 16QAM | 50 | 0 | 21.21 | 21.17 | 21.20 | |
| 20 | 16QAM | 50 | 24 | 21.33 | 21.29 | 21.37 | |
| 20 | 16QAM | 50 | 50 | 21.46 | 21.29 | 21.42 | 22.0 |
| 20 | 16QAM | 100 | 0 | 21.24 | 21.37 | 21.24 | |
| 20 | 16QAM | 100 | 0 | 21.24 | 21.37 | 21.24 | |
| BW (MHz) | Modulation | RB Size | RB Offset | Channel/Frequency(MHz) | | | Tune-up limit (dBm) |
| | | | | 18675 | 18900 | 19125 | |
| | | | | 1857.5 | 1880 | 1902.5 | |
| 15 | QPSK | 1 | 0 | 23.63 | 23.53 | 23.45 | 23.0 |
| 15 | QPSK | 1 | 37 | 23.13 | 23.72 | 23.94 | |
| 15 | QPSK | 1 | 74 | 23.18 | 23.13 | 23.64 | |
| 15 | QPSK | 36 | 0 | 22.37 | 22.22 | 22.43 | 22.0 |
| 15 | QPSK | 36 | 20 | 22.02 | 22.32 | 22.08 | |
| 15 | QPSK | 36 | 39 | 22.34 | 22.36 | 22.32 | |
| 15 | QPSK | 75 | 0 | 22.07 | 22.10 | 22.27 | 22.0 |
| 15 | 16QAM | 1 | 0 | 22.29 | 22.45 | 22.05 | |
| 15 | 16QAM | 1 | 37 | 22.33 | 22.05 | 22.14 | |
| 15 | 16QAM | 1 | 74 | 22.07 | 22.02 | 22.44 | 22.0 |
| 15 | 16QAM | 36 | 0 | 21.31 | 21.34 | 21.38 | |
| 15 | 16QAM | 36 | 20 | 21.53 | 21.20 | 21.15 | |
| 15 | 16QAM | 36 | 39 | 21.49 | 21.50 | 21.37 | 22.0 |
| 15 | 16QAM | 75 | 0 | 21.53 | 21.48 | 21.45 | |

| BW (MHz) | Modulation | RB Size | RB Offset | Channel/Frequency(MHz) | | | Tune-up limit (dBm) |
|----------|------------|---------|-----------|------------------------|--------------|--------------|---------------------|
| | | | | 18650 | 18900 | 19150 | |
| | | | | 1855 | 1880 | 1905 | |
| 10 | QPSK | 1 | 0 | 23.90 | 23.03 | 23.70 | 24.0 |
| 10 | QPSK | 1 | 25 | 23.39 | 23.94 | 23.11 | |
| 10 | QPSK | 1 | 49 | 23.38 | 23.98 | 23.04 | |
| 10 | QPSK | 25 | 0 | 22.39 | 22.27 | 22.08 | 23.0 |
| 10 | QPSK | 25 | 12 | 22.25 | 22.10 | 22.16 | |
| 10 | QPSK | 25 | 25 | 22.44 | 22.11 | 22.35 | |
| 10 | QPSK | 50 | 0 | 22.45 | 22.29 | 22.34 | |
| 10 | 16QAM | 1 | 0 | 22.38 | 22.10 | 22.16 | 23.0 |
| 10 | 16QAM | 1 | 25 | 22.05 | 22.04 | 22.20 | |
| 10 | 16QAM | 1 | 49 | 22.15 | 22.29 | 22.02 | |
| 10 | 16QAM | 25 | 0 | 21.32 | 21.38 | 21.15 | 22.0 |
| 10 | 16QAM | 25 | 12 | 21.48 | 21.55 | 21.44 | |
| 10 | 16QAM | 25 | 25 | 21.31 | 21.43 | 21.51 | |
| 10 | 16QAM | 50 | 0 | 21.20 | 21.39 | 21.50 | |
| 10 | 16QAM | 50 | 0 | 21.20 | 21.39 | 21.50 | |
| BW (MHz) | Modulation | RB Size | RB Offset | Channel/Frequency(MHz) | | | Tune-up limit (dBm) |
| | | | | 18625 | 18900 | 19175 | |
| | | | | 1852.5 | 1880 | 1907.5 | |
| 5 | QPSK | 1 | 0 | 23.87 | 23.35 | 23.93 | 24.0 |
| 5 | QPSK | 1 | 12 | 23.26 | 23.49 | 23.23 | |
| 5 | QPSK | 1 | 24 | 23.06 | 23.63 | 23.52 | |
| 5 | QPSK | 12 | 0 | 22.19 | 22.32 | 22.31 | 23.0 |
| 5 | QPSK | 12 | 7 | 22.44 | 22.35 | 22.20 | |
| 5 | QPSK | 12 | 13 | 22.09 | 22.25 | 22.03 | |
| 5 | QPSK | 25 | 0 | 22.04 | 22.40 | 22.25 | |
| 5 | 16QAM | 1 | 0 | 22.42 | 22.04 | 22.33 | 23.0 |
| 5 | 16QAM | 1 | 12 | 22.28 | 22.17 | 22.03 | |
| 5 | 16QAM | 1 | 24 | 22.14 | 22.29 | 22.31 | |
| 5 | 16QAM | 12 | 0 | 21.39 | 21.27 | 21.31 | 22.0 |
| 5 | 16QAM | 12 | 7 | 21.33 | 21.15 | 21.50 | |
| 5 | 16QAM | 12 | 13 | 21.42 | 21.47 | 21.28 | |
| 5 | 16QAM | 25 | 0 | 21.52 | 21.55 | 21.41 | |
| 5 | 16QAM | 25 | 0 | 21.52 | 21.55 | 21.41 | |

| BW (MHz) | Modulation | RB Size | RB Offset | Channel/Frequency(MHz) | | | Tune-up limit (dBm) |
|----------|------------|---------|-----------|------------------------|--------------|--------------|---------------------|
| | | | | 18615 | 18900 | 19185 | |
| | | | | 1851.5 | 1880 | 1908.5 | |
| 3 | QPSK | 1 | 0 | 23.20 | 23.42 | 23.42 | 24.0 |
| 3 | QPSK | 1 | 8 | 23.91 | 23.70 | 23.74 | |
| 3 | QPSK | 1 | 14 | 23.29 | 23.93 | 23.78 | |
| 3 | QPSK | 8 | 0 | 22.39 | 22.34 | 22.27 | 23.0 |
| 3 | QPSK | 8 | 4 | 22.33 | 22.11 | 22.33 | |
| 3 | QPSK | 8 | 7 | 22.06 | 22.21 | 22.20 | |
| 3 | QPSK | 15 | 0 | 22.45 | 22.03 | 22.13 | 23.0 |
| 3 | 16QAM | 1 | 0 | 22.33 | 22.05 | 22.38 | |
| 3 | 16QAM | 1 | 8 | 22.12 | 22.12 | 22.30 | |
| 3 | 16QAM | 1 | 14 | 22.27 | 22.19 | 22.10 | 22.0 |
| 3 | 16QAM | 8 | 0 | 21.54 | 21.51 | 21.52 | |
| 3 | 16QAM | 8 | 4 | 21.21 | 21.43 | 21.17 | |
| 3 | 16QAM | 8 | 7 | 21.51 | 21.37 | 21.52 | 22.0 |
| 3 | 16QAM | 15 | 0 | 21.22 | 21.47 | 21.34 | |
| 3 | 16QAM | 15 | 0 | 21.22 | 21.47 | 21.34 | |
| BW (MHz) | Modulation | RB Size | RB Offset | Channel/Frequency(MHz) | | | Tune-up limit (dBm) |
| | | | | 18607 | 18900 | 19193 | |
| | | | | 1850.7 | 1880 | 1909.3 | |
| 1.4 | QPSK | 1 | 0 | 23.95 | 23.87 | 23.56 | 24.0 |
| 1.4 | QPSK | 1 | 3 | 23.59 | 23.37 | 23.35 | |
| 1.4 | QPSK | 1 | 5 | 23.61 | 23.58 | 23.46 | |
| 1.4 | QPSK | 3 | 0 | 22.34 | 22.04 | 22.45 | 23.0 |
| 1.4 | QPSK | 3 | 1 | 22.20 | 22.36 | 22.14 | |
| 1.4 | QPSK | 3 | 3 | 22.29 | 22.18 | 22.16 | |
| 1.4 | QPSK | 6 | 0 | 22.10 | 22.02 | 22.21 | 23.0 |
| 1.4 | 16QAM | 1 | 0 | 22.08 | 22.23 | 22.32 | |
| 1.4 | 16QAM | 1 | 3 | 22.25 | 22.23 | 22.17 | |
| 1.4 | 16QAM | 1 | 5 | 22.10 | 22.39 | 22.43 | 22.0 |
| 1.4 | 16QAM | 3 | 0 | 21.37 | 21.32 | 21.38 | |
| 1.4 | 16QAM | 3 | 1 | 21.17 | 21.17 | 21.44 | |
| 1.4 | 16QAM | 3 | 3 | 21.50 | 21.54 | 21.29 | 22.0 |
| 1.4 | 16QAM | 3 | 3 | 21.50 | 21.54 | 21.29 | |
| 1.4 | 16QAM | 6 | 0 | 21.32 | 21.34 | 21.43 | |

| LTE Band 4 | | | | | | | |
|------------|------------|---------|-----------|------------------------|--------------|--------------|---------------------|
| BW (MHz) | Modulation | RB Size | RB Offset | Channel/Frequency(MHz) | | | Tune-up limit (dBm) |
| | | | | 20050 | 20175 | 20300 | |
| | | | | 1720 | 1747.5 | 1775 | |
| 20 | QPSK | 1 | 0 | 23.42 | 23.70 | 23.58 | 24.0 |
| 20 | QPSK | 1 | 49 | 23.61 | 23.68 | 23.08 | |
| 20 | QPSK | 1 | 99 | 23.14 | 23.02 | 23.55 | |
| 20 | QPSK | 50 | 0 | 22.44 | 22.37 | 22.11 | 23.0 |
| 20 | QPSK | 50 | 24 | 22.23 | 22.15 | 22.14 | |
| 20 | QPSK | 50 | 50 | 22.36 | 22.13 | 22.28 | |
| 20 | QPSK | 100 | 0 | 22.30 | 22.13 | 22.08 | 23.0 |
| 20 | 16QAM | 1 | 0 | 22.10 | 22.04 | 22.04 | |
| 20 | 16QAM | 1 | 49 | 22.27 | 22.05 | 22.34 | |
| 20 | 16QAM | 1 | 99 | 22.03 | 22.05 | 22.38 | 22.0 |
| 20 | 16QAM | 50 | 0 | 21.21 | 21.42 | 21.44 | |
| 20 | 16QAM | 50 | 24 | 21.15 | 21.41 | 21.38 | |
| 20 | 16QAM | 50 | 50 | 21.35 | 21.41 | 21.17 | 22.0 |
| 20 | 16QAM | 100 | 0 | 21.44 | 21.20 | 21.49 | |
| 20 | 16QAM | 100 | 0 | 21.44 | 21.20 | 21.49 | |
| BW (MHz) | Modulation | RB Size | RB Offset | Channel/Frequency(MHz) | | | Tune-up limit (dBm) |
| | | | | 20025 | 20175 | 20325 | |
| | | | | 1717.5 | 1747.5 | 1777.5 | |
| 15 | QPSK | 1 | 0 | 23.39 | 23.75 | 23.83 | 24.0 |
| 15 | QPSK | 1 | 37 | 23.92 | 23.05 | 23.93 | |
| 15 | QPSK | 1 | 74 | 23.36 | 23.26 | 23.32 | |
| 15 | QPSK | 36 | 0 | 22.42 | 22.34 | 22.39 | 23.0 |
| 15 | QPSK | 36 | 20 | 22.39 | 22.29 | 22.26 | |
| 15 | QPSK | 36 | 39 | 22.13 | 22.32 | 22.01 | |
| 15 | QPSK | 75 | 0 | 22.14 | 22.14 | 22.29 | 23.0 |
| 15 | 16QAM | 1 | 0 | 22.24 | 22.14 | 22.15 | |
| 15 | 16QAM | 1 | 37 | 22.13 | 22.15 | 22.34 | |
| 15 | 16QAM | 1 | 74 | 22.21 | 22.24 | 22.25 | 22.0 |
| 15 | 16QAM | 36 | 0 | 21.19 | 21.39 | 21.55 | |
| 15 | 16QAM | 36 | 20 | 21.36 | 21.49 | 21.42 | |
| 15 | 16QAM | 36 | 39 | 21.52 | 21.40 | 21.15 | 22.0 |
| 15 | 16QAM | 75 | 0 | 21.25 | 21.40 | 21.26 | |
| 15 | 16QAM | 75 | 0 | 21.25 | 21.40 | 21.26 | |

| BW (MHz) | Modulation | RB Size | RB Offset | Channel/Frequency(MHz) | | | Tune-up limit (dBm) |
|----------|------------|---------|-----------|------------------------|--------------|--------------|---------------------|
| | | | | 20000 | 20175 | 20350 | |
| | | | | 1715 | 1747.5 | 1780 | |
| 10 | QPSK | 1 | 0 | 23.46 | 23.26 | 23.18 | 24.0 |
| 10 | QPSK | 1 | 25 | 23.83 | 23.01 | 23.97 | |
| 10 | QPSK | 1 | 49 | 23.49 | 23.20 | 23.55 | |
| 10 | QPSK | 25 | 0 | 22.36 | 22.28 | 22.05 | 23.0 |
| 10 | QPSK | 25 | 12 | 22.03 | 22.22 | 22.04 | |
| 10 | QPSK | 25 | 25 | 22.35 | 22.15 | 22.40 | |
| 10 | QPSK | 50 | 0 | 22.05 | 22.20 | 22.44 | 23.0 |
| 10 | 16QAM | 1 | 0 | 22.10 | 22.04 | 22.06 | |
| 10 | 16QAM | 1 | 25 | 22.29 | 22.41 | 22.29 | |
| 10 | 16QAM | 1 | 49 | 22.41 | 22.21 | 22.13 | 22.0 |
| 10 | 16QAM | 25 | 0 | 21.39 | 21.46 | 21.17 | |
| 10 | 16QAM | 25 | 12 | 21.24 | 21.22 | 21.43 | |
| 10 | 16QAM | 25 | 25 | 21.36 | 21.16 | 21.39 | 22.0 |
| 10 | 16QAM | 50 | 0 | 21.55 | 21.46 | 21.17 | |
| 10 | 16QAM | 50 | 0 | 21.55 | 21.46 | 21.17 | |
| BW (MHz) | Modulation | RB Size | RB Offset | Channel/Frequency(MHz) | | | Tune-up limit (dBm) |
| | | | | 19975 | 20175 | 20375 | |
| | | | | 1712.5 | 1747.5 | 1782.5 | |
| 5 | QPSK | 1 | 0 | 23.00 | 23.16 | 23.06 | 24.0 |
| 5 | QPSK | 1 | 12 | 23.97 | 23.01 | 23.58 | |
| 5 | QPSK | 1 | 24 | 23.44 | 23.96 | 23.82 | |
| 5 | QPSK | 12 | 0 | 22.22 | 22.05 | 22.44 | 23.0 |
| 5 | QPSK | 12 | 7 | 22.25 | 22.31 | 22.17 | |
| 5 | QPSK | 12 | 13 | 22.23 | 22.30 | 22.28 | |
| 5 | QPSK | 25 | 0 | 22.05 | 22.11 | 22.05 | 23.0 |
| 5 | 16QAM | 1 | 0 | 22.02 | 22.15 | 22.34 | |
| 5 | 16QAM | 1 | 12 | 22.37 | 22.39 | 22.44 | |
| 5 | 16QAM | 1 | 24 | 22.40 | 22.32 | 22.32 | 22.0 |
| 5 | 16QAM | 12 | 0 | 21.49 | 21.47 | 21.28 | |
| 5 | 16QAM | 12 | 7 | 21.20 | 21.36 | 21.37 | |
| 5 | 16QAM | 12 | 13 | 21.54 | 21.22 | 21.33 | 22.0 |
| 5 | 16QAM | 25 | 0 | 21.15 | 21.43 | 21.38 | |

| BW (MHz) | Modulation | RB Size | RB Offset | Channel/Frequency(MHz) | | | Tune-up limit (dBm) |
|----------|------------|---------|-----------|------------------------|--------------|--------------|---------------------|
| | | | | 19665 | 20175 | 20385 | |
| | | | | 1711.5 | 1747.5 | 1783.5 | |
| 3 | QPSK | 1 | 0 | 23.09 | 23.37 | 23.95 | 24.0 |
| 3 | QPSK | 1 | 8 | 23.35 | 23.60 | 23.52 | |
| 3 | QPSK | 1 | 14 | 23.30 | 23.71 | 23.97 | |
| 3 | QPSK | 8 | 0 | 22.15 | 22.38 | 22.25 | 23.0 |
| 3 | QPSK | 8 | 4 | 22.44 | 22.11 | 22.01 | |
| 3 | QPSK | 8 | 7 | 22.25 | 22.33 | 22.27 | |
| 3 | QPSK | 15 | 0 | 22.09 | 22.41 | 22.33 | 23.0 |
| 3 | 16QAM | 1 | 0 | 22.23 | 22.01 | 22.36 | |
| 3 | 16QAM | 1 | 8 | 22.29 | 22.34 | 22.08 | |
| 3 | 16QAM | 1 | 14 | 22.26 | 22.23 | 22.19 | 22.0 |
| 3 | 16QAM | 8 | 0 | 21.17 | 21.50 | 21.19 | |
| 3 | 16QAM | 8 | 4 | 21.31 | 21.47 | 21.31 | |
| 3 | 16QAM | 8 | 7 | 21.28 | 21.42 | 21.21 | 22.0 |
| 3 | 16QAM | 15 | 0 | 21.38 | 21.40 | 21.22 | |
| BW (MHz) | Modulation | RB Size | RB Offset | Channel/Frequency(MHz) | | | Tune-up limit (dBm) |
| | | | | 19957 | 20175 | 20393 | |
| | | | | 1710.7 | 1747.5 | 1784.3 | |
| 1.4 | QPSK | 1 | 0 | 23.84 | 23.59 | 23.90 | 24.0 |
| 1.4 | QPSK | 1 | 3 | 23.27 | 23.94 | 23.84 | |
| 1.4 | QPSK | 1 | 5 | 23.30 | 23.07 | 23.30 | |
| 1.4 | QPSK | 3 | 0 | 22.19 | 22.23 | 22.38 | 23.0 |
| 1.4 | QPSK | 3 | 1 | 22.08 | 22.06 | 22.41 | |
| 1.4 | QPSK | 3 | 3 | 22.20 | 22.15 | 22.22 | |
| 1.4 | QPSK | 6 | 0 | 22.41 | 22.05 | 22.01 | 23.0 |
| 1.4 | 16QAM | 1 | 0 | 22.30 | 22.06 | 22.10 | |
| 1.4 | 16QAM | 1 | 3 | 22.21 | 22.19 | 22.06 | |
| 1.4 | 16QAM | 1 | 5 | 22.06 | 22.18 | 22.07 | 22.0 |
| 1.4 | 16QAM | 3 | 0 | 21.45 | 21.33 | 21.47 | |
| 1.4 | 16QAM | 3 | 1 | 21.45 | 21.16 | 21.47 | |
| 1.4 | 16QAM | 3 | 3 | 21.20 | 21.19 | 21.21 | 22.0 |
| 1.4 | 16QAM | 6 | 0 | 21.45 | 21.47 | 21.34 | |

| LTE Band 12 | | | | | | | |
|-------------|------------|---------|-----------|------------------------|--------------|--------------|---------------------|
| BW (MHz) | Modulation | RB Size | RB Offset | Channel/Frequency(MHz) | | | Tune-up limit (dBm) |
| | | | | 23060 | 23095 | 23130 | |
| | | | | 704 | 707.5 | 711 | |
| 10 | QPSK | 1 | 0 | 23.67 | 23.21 | 23.52 | 25.0 |
| 10 | QPSK | 1 | 25 | 23.00 | 23.50 | 23.33 | |
| 10 | QPSK | 1 | 49 | 23.55 | 23.77 | 23.34 | |
| 10 | QPSK | 25 | 0 | 22.27 | 22.08 | 22.05 | 24.0 |
| 10 | QPSK | 25 | 12 | 22.18 | 22.17 | 22.06 | |
| 10 | QPSK | 25 | 25 | 22.34 | 22.11 | 22.34 | |
| 10 | QPSK | 50 | 0 | 22.11 | 22.36 | 22.13 | 24.0 |
| 10 | 16QAM | 1 | 0 | 22.08 | 22.37 | 22.22 | 24.0 |
| 10 | 16QAM | 1 | 25 | 22.32 | 22.01 | 22.35 | |
| 10 | 16QAM | 1 | 49 | 22.07 | 22.38 | 22.11 | |
| 10 | 16QAM | 25 | 0 | 21.19 | 21.33 | 21.55 | 23.0 |
| 10 | 16QAM | 25 | 12 | 21.46 | 21.37 | 21.19 | |
| 10 | 16QAM | 25 | 25 | 21.26 | 21.33 | 21.19 | |
| 10 | 16QAM | 50 | 0 | 21.33 | 21.53 | 21.53 | 23.0 |
| BW (MHz) | Modulation | RB Size | RB Offset | Channel/Frequency(MHz) | | | Tune-up limit (dBm) |
| | | | | 23035 | 23095 | 23155 | |
| | | | | 701.5 | 707.5 | 713.5 | |
| 5 | QPSK | 1 | 0 | 23.43 | 23.78 | 23.19 | 25.0 |
| 5 | QPSK | 1 | 12 | 23.06 | 23.13 | 23.06 | |
| 5 | QPSK | 1 | 24 | 23.45 | 23.28 | 23.47 | |
| 5 | QPSK | 12 | 0 | 22.28 | 22.32 | 22.34 | 24.0 |
| 5 | QPSK | 12 | 7 | 22.32 | 22.22 | 22.29 | |
| 5 | QPSK | 12 | 13 | 22.08 | 22.32 | 22.32 | |
| 5 | QPSK | 25 | 0 | 22.15 | 22.21 | 22.11 | 24.0 |
| 5 | 16QAM | 1 | 0 | 22.18 | 22.27 | 22.12 | 24.0 |
| 5 | 16QAM | 1 | 12 | 22.14 | 22.02 | 22.05 | |
| 5 | 16QAM | 1 | 24 | 22.18 | 22.23 | 22.35 | |
| 5 | 16QAM | 12 | 0 | 21.52 | 21.51 | 21.37 | 23.0 |
| 5 | 16QAM | 12 | 7 | 21.37 | 21.29 | 21.49 | |
| 5 | 16QAM | 12 | 13 | 21.21 | 21.37 | 21.31 | |
| 5 | 16QAM | 25 | 0 | 21.48 | 21.54 | 21.33 | 23.0 |

| BW (MHz) | Modulation | RB Size | RB Offset | Channel/Frequency(MHz) | | | Tune-up limit (dBm) |
|----------|------------|---------|-----------|------------------------|--------------|--------------|---------------------|
| | | | | 23025 | 23095 | 23165 | |
| | | | | 700.5 | 707.5 | 714.5 | |
| 3 | QPSK | 1 | 0 | 23.60 | 23.71 | 23.25 | 25.0 |
| 3 | QPSK | 1 | 8 | 23.51 | 23.51 | 23.86 | |
| 3 | QPSK | 1 | 14 | 23.78 | 23.08 | 23.84 | |
| 3 | QPSK | 8 | 0 | 22.40 | 22.07 | 22.19 | 24.0 |
| 3 | QPSK | 8 | 4 | 22.35 | 22.12 | 22.35 | |
| 3 | QPSK | 8 | 7 | 22.30 | 22.16 | 22.25 | |
| 3 | QPSK | 15 | 0 | 22.23 | 22.12 | 22.34 | 24.0 |
| 3 | 16QAM | 1 | 0 | 22.05 | 22.08 | 22.30 | 24.0 |
| 3 | 16QAM | 1 | 8 | 22.33 | 22.11 | 22.24 | |
| 3 | 16QAM | 1 | 14 | 22.16 | 22.18 | 22.17 | |
| 3 | 16QAM | 8 | 0 | 21.48 | 21.18 | 21.26 | 23.0 |
| 3 | 16QAM | 8 | 4 | 21.22 | 21.44 | 21.17 | |
| 3 | 16QAM | 8 | 7 | 21.34 | 21.43 | 21.39 | |
| 3 | 16QAM | 15 | 0 | 21.45 | 21.42 | 21.25 | 23.0 |
| BW (MHz) | Modulation | RB Size | RB Offset | Channel/Frequency(MHz) | | | Tune-up limit (dBm) |
| | | | | 23017 | 23095 | 23173 | |
| | | | | 699.7 | 707.5 | 715.3 | |
| 1.4 | QPSK | 1 | 0 | 23.41 | 23.31 | 23.26 | 25.0 |
| 1.4 | QPSK | 1 | 3 | 23.96 | 23.68 | 23.66 | |
| 1.4 | QPSK | 1 | 5 | 23.91 | 23.63 | 23.25 | |
| 1.4 | QPSK | 3 | 0 | 22.11 | 22.03 | 22.06 | 24.0 |
| 1.4 | QPSK | 3 | 1 | 22.20 | 22.11 | 22.16 | |
| 1.4 | QPSK | 3 | 3 | 22.12 | 22.31 | 22.21 | |
| 1.4 | QPSK | 6 | 0 | 22.17 | 22.13 | 22.34 | 24.0 |
| 1.4 | 16QAM | 1 | 0 | 22.36 | 22.41 | 22.35 | 24.0 |
| 1.4 | 16QAM | 1 | 3 | 22.33 | 22.11 | 22.04 | |
| 1.4 | 16QAM | 1 | 5 | 22.43 | 22.36 | 22.13 | |
| 1.4 | 16QAM | 3 | 0 | 21.43 | 21.35 | 21.53 | 24.0 |
| 1.4 | 16QAM | 3 | 1 | 21.24 | 21.50 | 21.20 | |
| 1.4 | 16QAM | 3 | 3 | 21.39 | 21.27 | 21.36 | |
| 1.4 | 16QAM | 6 | 0 | 21.50 | 21.43 | 21.47 | 23.0 |

| LTE Band 17 | | | | | | | |
|-------------|------------|---------|-----------|------------------------|--------------|--------------|---------------------|
| BW (MHz) | Modulation | RB Size | RB Offset | Channel/Frequency(MHz) | | | Tune-up limit (dBm) |
| | | | | 23780 | 23790 | 23800 | |
| | | | | 709 | 710 | 711 | |
| 10 | QPSK | 1 | 0 | 23.16 | 23.29 | 23.02 | 25.0 |
| 10 | QPSK | 1 | 25 | 23.42 | 23.65 | 23.49 | |
| 10 | QPSK | 1 | 49 | 23.03 | 23.14 | 23.58 | |
| 10 | QPSK | 25 | 0 | 22.25 | 22.45 | 22.24 | 24.0 |
| 10 | QPSK | 25 | 12 | 22.31 | 22.07 | 22.27 | |
| 10 | QPSK | 25 | 25 | 22.43 | 22.34 | 22.41 | |
| 10 | QPSK | 50 | 0 | 22.34 | 22.41 | 22.05 | 24.0 |
| 10 | 16QAM | 1 | 0 | 22.08 | 22.21 | 22.15 | 24.0 |
| 10 | 16QAM | 1 | 25 | 22.38 | 22.35 | 22.10 | |
| 10 | 16QAM | 1 | 49 | 22.10 | 22.07 | 22.16 | |
| 10 | 16QAM | 25 | 0 | 21.38 | 21.51 | 21.16 | 23.0 |
| 10 | 16QAM | 25 | 12 | 21.45 | 21.42 | 21.37 | |
| 10 | 16QAM | 25 | 25 | 21.29 | 21.32 | 21.47 | |
| 10 | 16QAM | 50 | 0 | 21.50 | 21.31 | 21.30 | 23.0 |
| BW (MHz) | Modulation | RB Size | RB Offset | Channel/Frequency(MHz) | | | Tune-up limit (dBm) |
| | | | | 23755 | 23790 | 23825 | |
| | | | | 706.5 | 710 | 713.5 | |
| 5 | QPSK | 1 | 0 | 23.43 | 23.32 | 23.46 | 25.0 |
| 5 | QPSK | 1 | 12 | 23.28 | 23.20 | 23.05 | |
| 5 | QPSK | 1 | 24 | 23.13 | 23.61 | 23.25 | |
| 5 | QPSK | 12 | 0 | 22.14 | 22.39 | 22.07 | 24.0 |
| 5 | QPSK | 12 | 7 | 22.30 | 22.06 | 22.43 | |
| 5 | QPSK | 12 | 13 | 22.44 | 22.02 | 22.07 | |
| 5 | QPSK | 25 | 0 | 22.04 | 22.08 | 22.35 | 24.0 |
| 5 | 16QAM | 1 | 0 | 22.08 | 22.39 | 22.24 | 24.0 |
| 5 | 16QAM | 1 | 12 | 22.29 | 22.35 | 22.04 | |
| 5 | 16QAM | 1 | 24 | 22.14 | 22.24 | 22.27 | |
| 5 | 16QAM | 12 | 0 | 21.37 | 21.35 | 21.27 | 23.0 |
| 5 | 16QAM | 12 | 7 | 21.26 | 21.28 | 21.23 | |
| 5 | 16QAM | 12 | 13 | 21.21 | 21.20 | 21.46 | |
| 5 | 16QAM | 25 | 0 | 21.27 | 21.27 | 21.17 | 23.0 |

<WLAN 2.4GHz Conducted Power>

| Mode | Channel | Frequency (MHz) | Conducted Peak Output Power(dBm) | Conducted Average Output Power(dBm) | Tune-up limit (dBm) |
|---------------|---------|-----------------|----------------------------------|-------------------------------------|---------------------|
| 802.11b | 1 | 2412 | 14.59 | 13.08 | 13.5 |
| | 6 | 2437 | 13.12 | 11.53 | 12.0 |
| | 11 | 2462 | 12.90 | 11.32 | 12.0 |
| 802.11g | 1 | 2412 | 14.24 | 10.81 | 11.0 |
| | 6 | 2437 | 12.00 | 8.44 | 9.0 |
| | 11 | 2462 | 13.89 | 10.43 | 11.0 |
| 802.11n(HT20) | 1 | 2412 | 14.24 | 10.38 | 11.0 |
| | 6 | 2437 | 12.31 | 8.66 | 9.0 |
| | 11 | 2462 | 13.98 | 10.34 | 11.0 |
| 802.11n(HT40) | 3 | 2422 | 13.48 | 9.90 | 10.0 |
| | 6 | 2437 | 13.56 | 9.54 | 10.0 |
| | 9 | 2452 | 11.63 | 7.77 | 8.0 |

<WLAN 5.2GHz Conducted Power>

| Type | Channel | Frequency (MHz) | Conducted Average Output Power(dBm) | Tune-up limit (dBm) |
|----------------|---------|-----------------|-------------------------------------|---------------------|
| 802.11a | 36 | 5180 | 13.70 | 14.0 |
| | 44 | 5220 | 13.24 | 14.0 |
| | 48 | 5240 | 12.85 | 14.0 |
| 802.11n(HT20) | 36 | 5180 | 13.80 | 14.0 |
| | 44 | 5220 | 13.25 | 14.0 |
| | 48 | 5240 | 13.00 | 14.0 |
| 802.11n(HT40) | 38 | 5190 | 12.41 | 13.0 |
| | 46 | 5230 | 12.78 | 13.0 |
| 802.11ac(HT20) | 36 | 5180 | 14.19 | 15.0 |
| | 44 | 5220 | 13.37 | 14.0 |
| | 48 | 5240 | 12.73 | 13.0 |
| 802.11ac(HT40) | 38 | 5190 | 12.53 | 13.0 |
| | 46 | 5230 | 12.28 | 13.0 |
| 802.11ac(HT80) | 42 | 5210 | 12.99 | 13.0 |

<WLAN 5.8GHz Conducted Power>

| Type | Channel | Frequency (MHz) | Conducted Average Output Power(dBm) | Tune-up limit (dBm) |
|----------------|---------|-----------------|-------------------------------------|---------------------|
| 802.11a | 149 | 5745 | 10.34 | 12.0 |
| | 157 | 5785 | 11.68 | 12.0 |
| | 165 | 5825 | 11.43 | 12.0 |
| 802.11n(HT20) | 149 | 5745 | 10.11 | 12.0 |
| | 157 | 5785 | 11.47 | 12.0 |
| | 165 | 5825 | 11.22 | 12.0 |
| 802.11n(HT40) | 151 | 5755 | 9.52 | 11.0 |
| | 159 | 5795 | 10.51 | 11.0 |
| 802.11ac(HT20) | 149 | 5745 | 10.21 | 11.0 |
| | 157 | 5785 | 11.81 | 12.0 |
| | 165 | 5825 | 11.58 | 12.0 |
| 802.11ac(HT40) | 151 | 5755 | 9.96 | 11.0 |
| | 159 | 5795 | 10.93 | 11.0 |
| 802.11ac(HT80) | 155 | 5775 | 10.53 | 11.0 |

<Bluetooth Conducted Power>

| Mode | Channel | Frequency (MHz) | Conducted Peak Output Power(dBm) | Tune-up limit (dBm) |
|---------------|---------|-----------------|----------------------------------|---------------------|
| GFSK | 0 | 2402 | -1.61 | -1.0 |
| | 39 | 2441 | 0.58 | 1.0 |
| | 78 | 2480 | 0.79 | 1.0 |
| $\pi/4$ DQPSK | 0 | 2402 | -0.14 | 1.0 |
| | 39 | 2441 | -0.67 | 1.0 |
| | 78 | 2480 | 2.45 | 3.0 |
| 8DPSK | 0 | 2402 | 0.40 | 1.0 |
| | 39 | 2441 | 2.29 | 3.0 |
| | 78 | 2480 | 2.58 | 3.0 |
| BLE 1M | 0 | 2402 | -1.07 | -1.0 |
| | 19 | 2440 | -1.99 | -1.0 |
| | 39 | 2480 | -2.33 | -2.0 |
| BLE 2M | 0 | 2402 | -1.23 | -1.0 |
| | 19 | 2440 | -2.17 | -1.0 |
| | 39 | 2480 | -1.54 | -1.0 |

10.2 Transmit Antennas

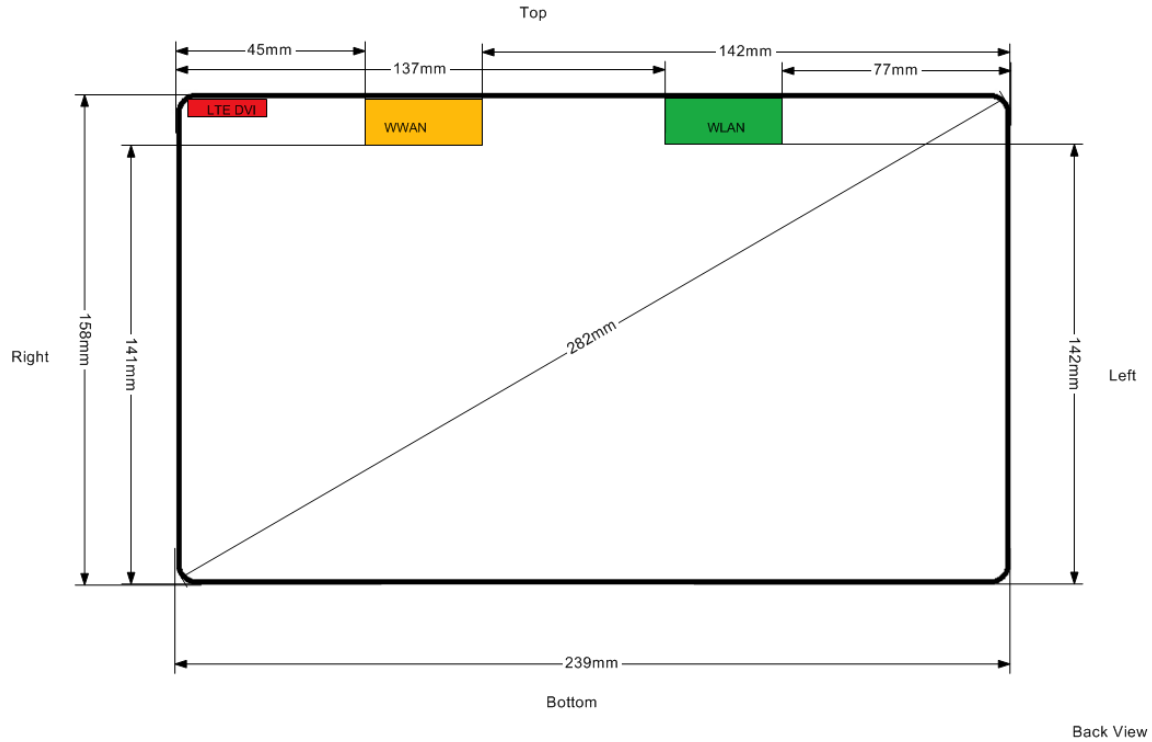

| Distance of The Antenna to the EUT surface and edge | | | | | |
|---|------|----------|-------------|-----------|------------|
| Antennas | Back | Top Side | Bottom Side | Left Side | Right Side |
| WWAN Main | <5mm | 0mm | 141mm | 142mm | 45mm |
| WLAN | <5mm | 0mm | 142mm | 77mm | 137mm |

10.3 SAR Test Exclusion and Estimated SAR

SAR Test Exclusion Considerations

Per KDB 447498 D01v06, the 1-g and 10-g SAR test exclusion thresholds for 100 MHz to 6 GHz at test separation distances ≤ 50 mm are determined by:

$$[(\text{max. power of channel, including tune-up tolerance, mW}) / (\text{min. test separation distance, mm})] \cdot [\sqrt{f(\text{GHz})}] \leq 3.0 \text{ for 1-g SAR and } \leq 7.5 \text{ for 10-g extremity SAR}$$

- f(GHz) is the RF channel transmit frequency in GHz.
- Power and distance are rounded to the nearest mW and mm before calculation.
- The result is rounded to one decimal place for comparison.

Per KDB 447498 D01v06, at 100 MHz to 6 GHz and for test separation distances > 50 mm, the SAR test exclusion threshold is determined according to the following:

- [Threshold at 50mm)+(test separation distance-50mm)*(f(MHz)/150)]mW, at 100MHz to 1500MHz
- [Threshold at 50mm)+(test separation distance-50mm)*10]mW at > 1500MHz and ≤ 6GHz

Estimated SAR

Per KDB447498 requires when the standalone SAR test exclusion of section 4.3.1 is applied to an antenna that transmits simultaneously with other antennas, the standalone SAR must be estimated according to the following to determine simultaneous transmission SAR test exclusion;

- (max. power of channel, including tune-up tolerance, mW)/(min. test separation distance, mm) • [√ f(GHz)/x] W/kg for test separation distances ≤ 50 mm; where x = 7.5 for 1-g SAR, and x = 18.75 for 10-g SAR.
- 0.4 W/kg for 1-g SAR and 1.0 W/kg for 10-g SAR, when the test separation distances is > 50 mm

The below table, exemption limits for routine evaluation based on frequency and separation distance was according to SAR-based Exemption – §1.1307(b)(3)(i)(B).

| Standalone SAR Test Exclusion and Estimated SAR | | | | | | | | | |
|---|-----------------|---------------|-------------------------|---------|---------------|--------------------|--------------------------|--------------------------|----------------------|
| Wireless Interface | Frequency (MHz) | Configuration | Max. Power With tune-up | | Distance (mm) | Calculation Result | SAR Exclusion Thresholds | Standalone SAR Exclusion | Estimated SAR (W/Kg) |
| | | | dBm | mW | | | | | |
| LTE Lower band | 707.5 | Back | 24 | 251.189 | 5 | 42.2 | 3 | No | N/A |
| | | Left edge | 24 | 251.189 | 142 | 251.189 | 612 | Yes | 0.400 |
| | | Right edge | 24 | 251.189 | 45 | 4.7 | 3 | No | N/A |
| | | Top edge | 24 | 251.189 | 5 | 42.2 | 3 | No | N/A |
| | | Bottom edge | 24 | 251.189 | 141 | 251.189 | 608 | Yes | 0.400 |
| LTE Higher band | 1880 | Back | 24 | 251.189 | 5 | 68.8 | 3 | No | N/A |
| | | Left edge | 24 | 251.189 | 142 | 251.189 | 1029 | Yes | 0.400 |
| | | Right edge | 24 | 251.189 | 45 | 7.600 | 3 | No | N/A |
| | | Top edge | 24 | 251.189 | 5 | 68.8 | 3 | No | N/A |
| | | Bottom edge | 24 | 251.189 | 141 | 251.189 | 1019 | Yes | 0.400 |
| 2.4GHz WLAN | 2450 | Back | 13.5 | 22.387 | 5 | 6.9 | 3 | No | N/A |
| | | Left edge | 13.5 | 22.387 | 77 | 22.387 | 366 | Yes | 0.400 |
| | | Right edge | 13.5 | 22.387 | 137 | 22.387 | 966 | Yes | 0.400 |
| | | Top edge | 13.5 | 22.387 | 5 | 6.9 | 3 | No | N/A |

| | | | | | | | | | |
|-----------------|------|-------------|------|-------------|------|--------|------|--------|-------|
| | | Bottom edge | 13.5 | 22.387 | 142 | 22.387 | 1016 | Yes | 0.400 |
| 5.2GHz WLAN | 5250 | Back | 15.0 | 31.623 | 5 | 14.7 | 3 | No | N/A |
| | | Left edge | 15.0 | 31.623 | 77 | 31.623 | 335 | Yes | 0.400 |
| | | Right edge | 15.0 | 31.623 | 137 | 31.623 | 935 | Yes | 0.400 |
| | | Top edge | 15.0 | 31.623 | 5 | 14.7 | 3 | No | N/A |
| | | Bottom edge | 15.0 | 31.623 | 142 | 31.623 | 985 | Yes | 0.400 |
| | | | | Bottom edge | 13.5 | 22.387 | 142 | 22.387 | 1016 |
| 5.8 GHz WLAN | 5785 | Back | 12.0 | 15.849 | 5 | 7.7 | 3 | No | N/A |
| | | Left edge | 12.0 | 15.849 | 77 | 15.849 | 332 | Yes | 0.400 |
| | | Right edge | 12.0 | 15.849 | 137 | 15.849 | 932 | Yes | 0.400 |
| | | Top edge | 12.0 | 15.849 | 5 | 7.7 | 3 | No | N/A |
| | | Bottom edge | 12.0 | 15.849 | 142 | 15.849 | 982 | Yes | 0.400 |
| | | | | Bottom edge | 13.5 | 22.387 | 142 | 22.387 | 1016 |
| Bluetooth | 2450 | Back | 3.0 | 1.995 | 5 | 0.6 | 3 | Yes | 0.083 |
| | | Left edge | 3.0 | 1.995 | 77 | 1.995 | 366 | Yes | 0.400 |
| | | Right edge | 3.0 | 1.995 | 137 | 1.995 | 966 | Yes | 0.400 |
| | | Top edge | 3.0 | 1.995 | 5 | 0.6 | 3 | Yes | 0.083 |
| | | Bottom edge | 3.0 | 1.995 | 142 | 1.995 | 1016 | Yes | 0.400 |
| | | | | Bottom edge | 13.5 | 22.387 | 142 | 22.387 | 1016 |

Remark:

1. Maximum average power including tune-up tolerance;
2. When the minimum test separation distance is < 5 mm, a distance of 5 mm is applied to determine SAR test exclusion
3. when the distance is < 50 mm exclusion threshold is "Ratio", when the distance is > 50 mm exclusion threshold is "mW".

10.4 SAR Test Results

General Note:

- 1 Per KDB 447498 D01v06, the reported SAR is the measured SAR value adjusted for maximum tune-up tolerance.
 - a) Tune-up scaling Factor = tune-up limit power (mW) / EUT RF power (mW), where tune-up limit is the maximum rated power among all production units.
 - b) For SAR testing of WLAN signal with non-100% duty cycle, the measured SAR is scaled-up by the duty cycle scaling factor which is equal to "1/(duty cycle)"
 - c) For WLAN/Bluetooth: Reported SAR(W/kg)= Measured SAR(W/kg)* Duty Cycle scaling factor * Tune-up scaling factor
- 2 Per KDB 447498 D01v06, for each exposure position, testing of other required channels within the operating mode of a frequency band is not required when the reported 1-g or 10-g SAR for the mid-band or highest output power channel is:
 - ≤ 0.8 W/kg or 2.0 W/kg, for 1-g or 10-g respectively, when the transmission band is ≤ 100 MHz
 - ≤ 0.6 W/kg or 1.5 W/kg, for 1-g or 10-g respectively, when the transmission band is between 100 MHz and 200 MHz
 - ≤ 0.4 W/kg or 1.0 W/kg, for 1-g or 10-g respectively, when the transmission band is ≥ 200 MHz
- 3 Per KDB 865664 D01v01r04, for each frequency band, repeated SAR measurement is required only when the measured SAR is ≥ 0.8 W/kg.

<Body SAR>

Note :We tested all Models and recorded the worst case as follows:

SAR Values [LTE Band 2]

| Plot No. | Mode | Test Position | Ch. | Freq. (MHz) | Average Power (dBm) | Tune-Up Limit (dBm) | Scaling Factor | Power Drift (dB) | Measured SAR _{1g} (W/kg) | Reported SAR _{1g} (W/kg) |
|--|---------------|---------------|-------|-------------|---------------------|---------------------|----------------|------------------|-----------------------------------|-----------------------------------|
| Measured / Reported SAR numbers-Body distance 0mm | | | | | | | | | | |
| #1 | 20MHz/1RB#99 | Back | 18900 | 1880 | 23.76 | 24.00 | 1.057 | 0.05 | 0.587 | 0.620 |
| | 20MHz/1RB#99 | Right Edge | 18900 | 1880 | 23.76 | 24.00 | 1.057 | 0.01 | 0.245 | 0.259 |
| | 20MHz/1RB#99 | Top Edge | 18900 | 1880 | 23.76 | 24.00 | 1.057 | -0.02 | 0.546 | 0.577 |
| | 20MHz/50RB#24 | Back | 18700 | 1860 | 22.41 | 23.00 | 1.146 | 0.08 | 0.425 | 0.487 |
| | 20MHz/50RB#24 | Right Edge | 18700 | 1860 | 22.41 | 23.00 | 1.146 | 0.04 | 0.083 | 0.095 |
| | 20MHz/50RB#24 | Top Edge | 18700 | 1860 | 22.41 | 23.00 | 1.146 | -0.02 | 0.382 | 0.438 |

SAR Values [LTE Band 4]

| Plot No. | Mode | Test Position | Ch. | Freq. (MHz) | Average Power (dBm) | Tune-Up Limit (dBm) | Scaling Factor | Power Drift (dB) | Measured SAR _{1g} (W/kg) | Reported SAR _{1g} (W/kg) |
|--|--------------|---------------|-------|-------------|---------------------|---------------------|----------------|------------------|-----------------------------------|-----------------------------------|
| Measured / Reported SAR numbers-Body distance 0mm | | | | | | | | | | |
| #2 | 20MHz/1RB#0 | Back | 20175 | 1747.5 | 23.70 | 24.00 | 1.072 | -0.05 | 0.605 | 0.648 |
| | 20MHz/1RB#0 | Right Edge | 20175 | 1747.5 | 23.70 | 24.00 | 1.072 | 0.11 | 0.262 | 0.281 |
| | 20MHz/1RB#0 | Top Edge | 20175 | 1747.5 | 23.70 | 24.00 | 1.072 | -0.01 | 0.561 | 0.601 |
| | 20MHz/50RB#0 | Back | 20050 | 1720 | 22.44 | 23.00 | 1.138 | -0.11 | 0.528 | 0.601 |
| | 20MHz/50RB#0 | Right Edge | 20050 | 1720 | 22.44 | 23.00 | 1.138 | 0.08 | 0.179 | 0.204 |
| | 20MHz/50RB#0 | Top Edge | 20050 | 1720 | 22.44 | 23.00 | 1.138 | 0.09 | 0.484 | 0.551 |

SAR Values [LTE Band 12]

| Plot No. | Mode | Test Position | Ch. | Freq. (MHz) | Average Power (dBm) | Tune-Up Limit (dBm) | Scaling Factor | Power Drift (dB) | Measured SAR _{1g} (W/kg) | Reported SAR _{1g} (W/kg) |
|--|---------------|---------------|-------|-------------|---------------------|---------------------|----------------|------------------|-----------------------------------|-----------------------------------|
| Measured / Reported SAR numbers-Body & hotspot open distance 10mm | | | | | | | | | | |
| #3 | 10MHz/1RB#49 | Back | 23095 | 707.5 | 23.77 | 24.0 | 1.054 | 0.03 | 0.478 | 0.504 |
| | 10MHz/1RB#49 | Right Edge | 23095 | 707.5 | 23.77 | 24.0 | 1.054 | 0.07 | 0.129 | 0.136 |
| | 10MHz/1RB#49 | Top Edge | 23095 | 707.5 | 23.77 | 24.0 | 1.054 | 0.13 | 0.435 | 0.459 |
| | 10MHz/25RB#25 | Back | 23060 | 704 | 22.34 | 23.0 | 1.164 | -0.04 | 0.422 | 0.491 |
| | 10MHz/25RB#25 | Right Edge | 23060 | 704 | 22.34 | 23.0 | 1.164 | -0.04 | 0.080 | 0.093 |
| | 10MHz/25RB#25 | Top Edge | 23060 | 704 | 22.34 | 23.0 | 1.164 | 0.12 | 0.377 | 0.439 |

SAR Values [WIFI 2.4G]

| Plot No. | Mode | Test Position | Ch. | Freq. (MHz) | Average Power (dBm) | Tune-Up Limit (dBm) | Scaling Factor | Power Drift (dB) | Measured SAR _{1g} (W/kg) | Reported SAR _{1g} (W/kg) |
|--|---------|---------------|-----|-------------|---------------------|---------------------|----------------|------------------|-----------------------------------|-----------------------------------|
| Measured / Reported SAR numbers-Body distance 0mm | | | | | | | | | | |
| #4 | 802.11b | Back | 01 | 2412 | 13.08 | 13.5 | 1.102 | -0.10 | 0.255 | 0.281 |
| | 802.11b | Top Edge | 01 | 2412 | 13.08 | 13.5 | 1.102 | -0.04 | 0.232 | 0.256 |

Remark: The highest reported SAR for DSSS is adjusted by the ratio of OFDM to DSSS specified maximum output power was <1.2W/kg, So ODFM SAR test is not required.

SAR Values [WIFI 5.2G]

| Plot No. | Mode | Test Position | Ch. | Freq. (MHz) | Average Power (dBm) | Tune-Up Limit (dBm) | Scaling Factor | Power Drift (dB) | Measured SAR _{1g} (W/kg) | Reported SAR _{1g} (W/kg) |
|--|----------------|---------------|-----|-------------|---------------------|---------------------|----------------|------------------|-----------------------------------|-----------------------------------|
| Measured / Reported SAR numbers-Body distance 0mm | | | | | | | | | | |
| #5 | 802.11ac(HT20) | Back | 36 | 5180 | 14.19 | 15.0 | 1.205 | 0.07 | 0.254 | 0.306 |
| | 802.11ac(HT20) | Top Edge | 36 | 5180 | 14.19 | 15.0 | 1.205 | -0.03 | 0.240 | 0.289 |

SAR Values [WIFI 5.8G]

| Plot No. | Mode | Test Position | Ch. | Freq. (MHz) | Average Power (dBm) | Tune-Up Limit (dBm) | Scaling Factor | Power Drift (dB) | Measured SAR _{1g} (W/kg) | Reported SAR _{1g} (W/kg) |
|--|----------------|---------------|-----|-------------|---------------------|---------------------|----------------|------------------|-----------------------------------|-----------------------------------|
| Measured / Reported SAR numbers-Body distance 0mm | | | | | | | | | | |
| #6 | 802.11ac(HT20) | Back | 157 | 5785 | 11.81 | 12.0 | 1.045 | -0.10 | 0.217 | 0.227 |
| | 802.11ac(HT20) | Top Edge | 157 | 5785 | 11.81 | 12.0 | 1.045 | -0.04 | 0.205 | 0.214 |

10.6 Simultaneous Transmission Analysis

Per FCC KD B447498 D01, simultaneous transmission SAR test exclusion may be applied when the sum of the 1-g SAR for all the transmitting antenna in a specific a physical test configuration is ≤ 1.6 W/Kg. When the sum is greater than the SAR limit, SAR test exclusion is determined by the SAR to peak location separation ratio.

$$\text{Ratio} = \frac{(\text{SAR}_1 + \text{SAR}_2)^{1.5}}{(\text{peak location separation, mm})} < 0.04$$

The following procedures adopted from “FCC SAR Considerations for Cell Phones with Multiple Transmitters” are applicable to handsets with built-in unlicensed transmitters such as 802.11 a/b/g/n and Bluetooth devices which may simultaneously transmit with the licensed transmitter.

Application Simultaneous Transmission information:

| No. | Simultaneous Transmission Configurations | Body-worn |
|-----|--|-----------|
| 1 | WWAN (2/3/4G) + WLAN 2.4GHz | Yes |
| 2 | WWAN (2/3/4G) + WLAN 5GHz | Yes |
| 3 | WWAN (2/3/4G) + Bluetooth | Yes |

Note: WLAN and BT share the same antenna and cannot transmitting at the same time.

Evaluation of Simultaneous SAR

Simultaneous transmission SAR for WIFI/BT and GSM/WCDMA/ LTE

| Exposure Position | 1 | 2 | 3 | 4 | 1+2 Summed 1g SAR (W/kg) | 1+3 Summed 1g SAR (W/kg) | 1+4 Summed 1g SAR (W/kg) | SPLSR |
|-------------------|---------------------------|----------------------------------|--------------------------------|------------------|-----------------------------------|-----------------------------------|-----------------------------------|-------|
| | MAX. WWAN Reported SAR | MAX. WLAN2.4G Reported SAR | MAX. WLAN5G Reported SAR | Bluetooth | | | | |
| | 1g SAR (W/kg) | 1g SAR (W/kg) | 1g SAR (W/kg) | 1g SAR (W/kg) | | | | |
| Back | 0.648 | 0.281 | 0.306 | 0.083 | 0.929 | 0.954 | 0.731 | N/A |
| Left Edge | 0.400 | 0.400 | 0.400 | 0.400 | 0.800 | 0.800 | 0.800 | N/A |
| Right Edge | 0.281 | 0.400 | 0.400 | 0.400 | 0.681 | 0.681 | 0.681 | N/A |
| Top Edge | 0.601 | 0.256 | 0.289 | 0.083 | 0.857 | 0.890 | 0.684 | N/A |
| Bottom Edge | 0.400 | 0.400 | 0.400 | 0.400 | 0.800 | 0.800 | 0.800 | N/A |

MAX. $\Sigma \text{SAR}_{1g} = 0.954$ W/kg < 1.6 W/kg, so the Simultaneous transmission SAR with volume scan are not required.

11 Measurement Uncertainty

| NO | Source | Uncert. ai (%) | Prob. Dist. | Div. k | ci (1g) | ci (10g) | Stand.U ncert. ui (1g) | Stand.U ncert. ui (10g) | Veff |
|-------------------|---|----------------|-------------|------------|---------|----------|------------------------|-------------------------|----------|
| 1 | Repeat | 0.4 | N | 1 | 1 | 1 | 0.4 | 0.4 | 9 |
| Instrument | | | | | | | | | |
| 2 | Probe calibration | 7 | N | 2 | 1 | 1 | 3.5 | 3.5 | ∞ |
| 3 | Axial isotropy | 4.7 | R | $\sqrt{3}$ | 0.7 | 0.7 | 1.9 | 1.9 | ∞ |
| 4 | Hemispherical isotropy | 9.4 | R | $\sqrt{3}$ | 0.7 | 0.7 | 3.9 | 3.9 | ∞ |
| 5 | Boundary effect | 1.0 | R | $\sqrt{3}$ | 1 | 1 | 0.6 | 0.6 | ∞ |
| 6 | Linearity | 4.7 | R | $\sqrt{3}$ | 1 | 1 | 2.7 | 2.7 | ∞ |
| 7 | Detection limits | 1.0 | R | $\sqrt{3}$ | 1 | 1 | 0.6 | 0.6 | ∞ |
| 8 | Readout electronics | 0.3 | N | 1 | 1 | 1 | 0.3 | 0.3 | ∞ |
| 9 | Response time | 0.8 | R | $\sqrt{3}$ | 1 | 1 | 0.5 | 0.5 | ∞ |
| 10 | Integration time | 2.6 | R | $\sqrt{3}$ | 1 | 1 | 1.5 | 1.5 | ∞ |
| 11 | Ambient noise | 3.0 | R | $\sqrt{3}$ | 1 | 1 | 1.7 | 1.7 | ∞ |
| 12 | Ambient reflections | 3.0 | R | $\sqrt{3}$ | 1 | 1 | 1.7 | 1.7 | ∞ |
| 13 | Probe positioner mech. restrictions | 0.4 | R | $\sqrt{3}$ | 1 | 1 | 0.2 | 0.2 | ∞ |
| 14 | Probe positioning with respect to phantom shell | 2.9 | R | $\sqrt{3}$ | 1 | 1 | 1.7 | 1.7 | ∞ |
| 15 | Max.SAR evaluation | 1.0 | R | $\sqrt{3}$ | 1 | 1 | 0.6 | 0.6 | ∞ |

| Test sample related | | | | | | | | | |
|------------------------------------|------------------------------|-------------|-----|---|------|------|--------------|--------------|----------|
| 16 | Device positioning | 3.8 | N | 1 | 1 | 1 | 3.8 | 3.8 | 99 |
| 17 | Device holder | 5.1 | N | 1 | 1 | 1 | 5.1 | 5.1 | 5 |
| 18 | Drift of output power | 5.0 | R | $\frac{1}{\sqrt{3}}$ | 1 | 1 | 2.9 | 2.9 | ∞ |
| Phantom and set-up | | | | | | | | | |
| 19 | Phantom uncertainty | 4.0 | R | $\frac{1}{\sqrt{3}}$ | 1 | 1 | 2.3 | 2.3 | ∞ |
| 20 | Liquid conductivity (target) | 5.0 | R | $\frac{1}{\sqrt{3}}$ | 0.64 | 0.43 | 1.8 | 1.2 | ∞ |
| 21 | Liquid conductivity (meas) | 2.5 | N | 1 | 0.64 | 0.43 | 1.6 | 1.2 | ∞ |
| 22 | Liquid Permittivity (target) | 5.0 | R | $\frac{1}{\sqrt{3}}$ | 0.6 | 0.49 | 1.7 | 1.5 | ∞ |
| 23 | Liquid Permittivity (meas) | 2.5 | N | 1 | 0.6 | 0.49 | 1.5 | 1.2 | ∞ |
| Combined standard | | | RSS | $U_c = \sqrt{\sum_{i=1}^n C_i^2 U_i^2}$ | | | 11.4% | 11.3% | 236 |
| Expanded uncertainty(P=95%) | | $U = k U_c$ | | | | | 22.8% | 22.6% | |

Appendix A. EUT Photos and Test Setup Photos

| | |
|--|--|
|  |  |
| <p>Back(0mm)</p> | <p>Top(0mm)</p> |
|  | |
| <p>Right (0mm)</p> | |
| | |

Appendix B. Plots of SAR System Check

750MHz System Check

Date: 07/22/2024

DUT: Dipole 750 MHz; Type: D750V3; Serial: 1194

Communication System: CW; Frequency: 750 MHz; Duty Cycle: 1:1

Medium parameters used (interpolated): $f = 750$ MHz; $\sigma = 0.870$ S/m; $\epsilon_r = 40.978$; $\rho = 1000$ kg/m³

Phantom section: Flat Section

DASY5 Configuration:

- Probe: EX3DV4 – SN7624; ConvF(10.58, 10.58, 10.58); Calibrated: Sep. 06, 2023
- Sensor-Surface: 2mm (Mechanical Surface Detection)
- Electronics: DAE3 Sn428; Calibrated: 08/30/2023
- Phantom: SAM 2; Type: QD000P40CC; Serial: TP:1474
- DASY52 52.10.2(1495); SEMCAD X 14.6.12(7450)

Area Scan (61x61x1): Interpolated grid: dx=1.500 mm, dy=1.500 mm

Maximum value of SAR (interpolated) = 3.63 W/kg

Zoom Scan (5x5x7)/Cube 0: Measurement grid: dx=8mm, dy=8mm, dz=5mm

Reference Value = 60.25 V/m; Power Drift = -0.11 dB

Peak SAR (extrapolated) = 4.15 W/kg

SAR(1 g) = 2.16 W/kg; SAR(10 g) = 1.48 W/kg

Maximum value of SAR (measured) = 3.47 W/kg

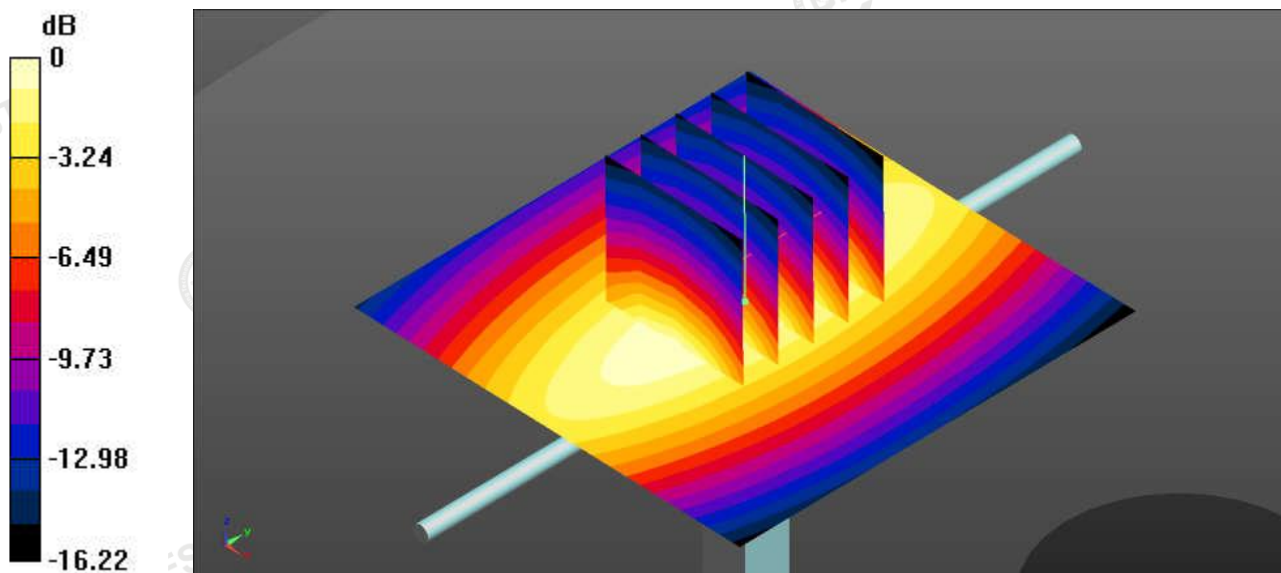

0 dB = 3.47 W/kg

System Performance Check 750MHz 250mW

1750 MHz System Check

Date: 07/23/2024

DUT: Dipole 1800 MHz; Type: D1800V2; Serial: 2d158

Communication System: CW; Frequency: 1750 MHz; Duty Cycle: 1:1

Medium parameters used (interpolated): $f = 1750$ MHz; $\sigma = 1.336$ S/m; $\epsilon_r = 39.098$; $\rho = 1000$ kg/m³

Phantom section: Flat Section

DASY5 Configuration:

- Probe: EX3DV4 - SN7624; ConvF(8.66, 8.66, 8.66); Calibrated: Sep. 06, 2023
- Sensor-Surface: 2mm (Mechanical Surface Detection)
- Electronics: DAE3 Sn428; Calibrated: 08/30/2023
- Phantom: SAM 2; Type: QD000P40CC; Serial: TP:1474
- DASY52 52.10.2(1495); SEMCAD X 14.6.12(7450)

Area Scan (61x61x1): Interpolated grid: dx=1.500 mm, dy=1.500 mm

Maximum value of SAR (interpolated) = 16.41 W/kg

Zoom Scan (5x5x7)/Cube 0: Measurement grid: dx=8mm, dy=8mm, dz=5mm

Reference Value = 85.59 V/m; Power Drift = 0.03 dB

Peak SAR (extrapolated) = 21.9 W/kg

SAR(1 g) = 10.18 W/kg; SAR(10 g) = 5.12 W/kg

Maximum value of SAR (measured) = 15.5 W/kg

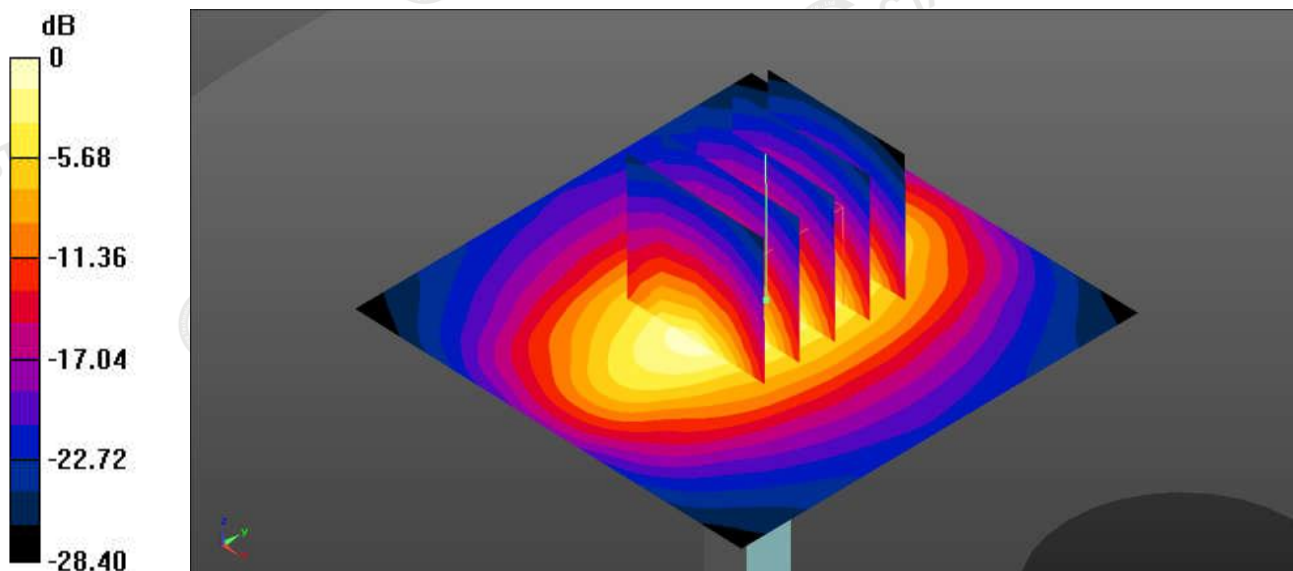

0 dB = 15.5 W/kg

System Performance Check 1750MHz 250mW

DUT: Dipole 1900 MHz; Type: D1900V2; Serial: 5d002

Communication System: CW; Frequency: 1900 MHz; Duty Cycle: 1:1

Medium parameters used (interpolated): $f = 1900$ MHz; $\sigma = 1.331$ S/m; $\epsilon_r = 41.304$; $\rho = 1000$ kg/m³

Phantom section: Flat Section

DASY5 Configuration:

- Probe: EX3DV4 - SN7624; ConvF(8.35, 8.35, 8.35); Calibrated: Sep. 06, 2023
- Sensor-Surface: 2mm (Mechanical Surface Detection)
- Electronics: DAE3 Sn428; Calibrated: 08/30/2023
- Phantom: SAM 2; Type: QD000P40CC; Serial: TP:1474
- DASY52 52.10.2(1495); SEMCAD X 14.6.12(7450)

Area Scan (61x61x1): Interpolated grid: dx=1.500 mm, dy=1.500 mm

Maximum value of SAR (interpolated) = 18.2 W/kg

Zoom Scan (5x5x7)/Cube 0: Measurement grid: dx=8mm, dy=8mm, dz=5mm

Reference Value = 88.69 V/m; Power Drift = -0.03 dB

Peak SAR (extrapolated) = 28.5 W/kg

SAR(1 g) = 9.66 W/kg; SAR(10 g) = 5.13 W/kg

Maximum value of SAR (measured) = 18.0 W/kg

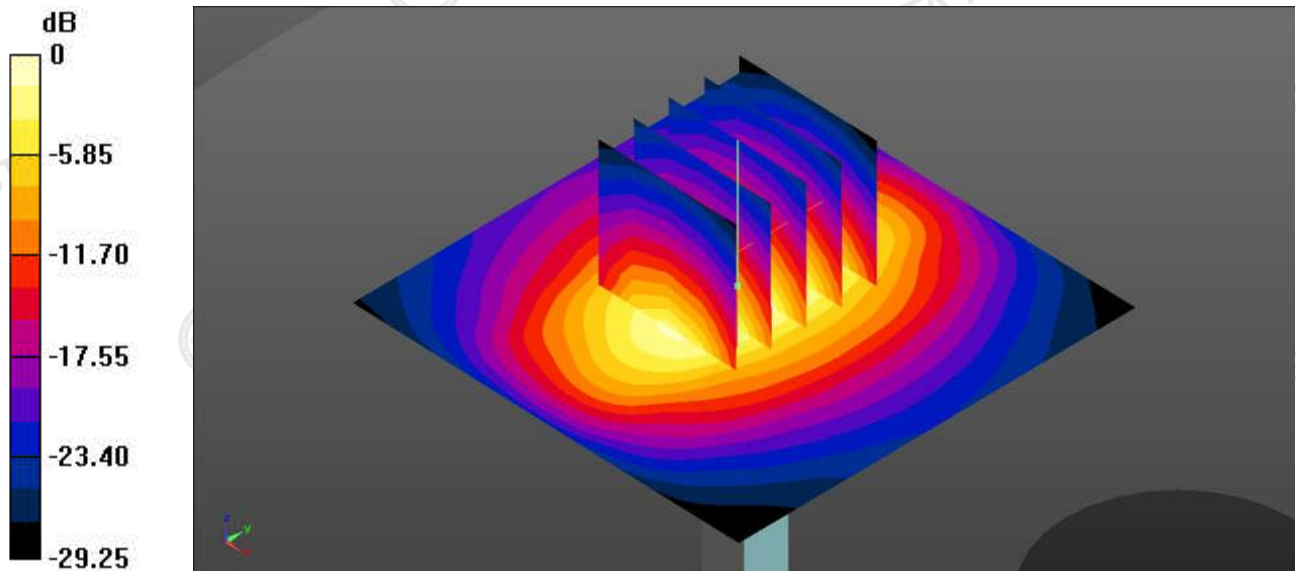

0 dB = 18.0 W/kg

System Performance Check 1900MHz 250mW

DUT: Dipole 2450 MHz; Type: D2450V2; Serial: 745

Communication System: CW; Frequency: 2450 MHz; Duty Cycle: 1:1

Medium parameters used (interpolated): $f = 2450$ MHz; $\sigma = 1.738$ S/m; $\epsilon_r = 39.039$; $\rho = 1000$ kg/m³

Phantom section: Flat Section

DASY5 Configuration:

- Probe: EX3DV4 - SN7624; ConvF(7.85, 7.85, 7.85); Calibrated: Sep. 06, 2023
- Sensor-Surface: 2mm (Mechanical Surface Detection)
- Electronics: DAE3 Sn428; Calibrated: 08/30/2023
- Phantom: SAM 2; Type: QD000P40CC; Serial: TP:1474
- DASY52 52.10.2(1495); SEMCAD X 14.6.12(7450)

Area Scan (71x71x1): Interpolated grid: dx=1.200 mm, dy=1.200 mm

Maximum value of SAR (interpolated) = 20.4 W/kg

Zoom Scan (7x7x7)/Cube 0: Measurement grid: dx=5mm, dy=5mm, dz=5mm

Reference Value = 93.87 V/m; Power Drift = -0.04 dB

Peak SAR (extrapolated) = 28.5 W/kg

SAR(1 g) = 12.99 W/kg; SAR(10 g) = 6.20 W/kg

Maximum value of SAR (measured) = 21.1 W/kg

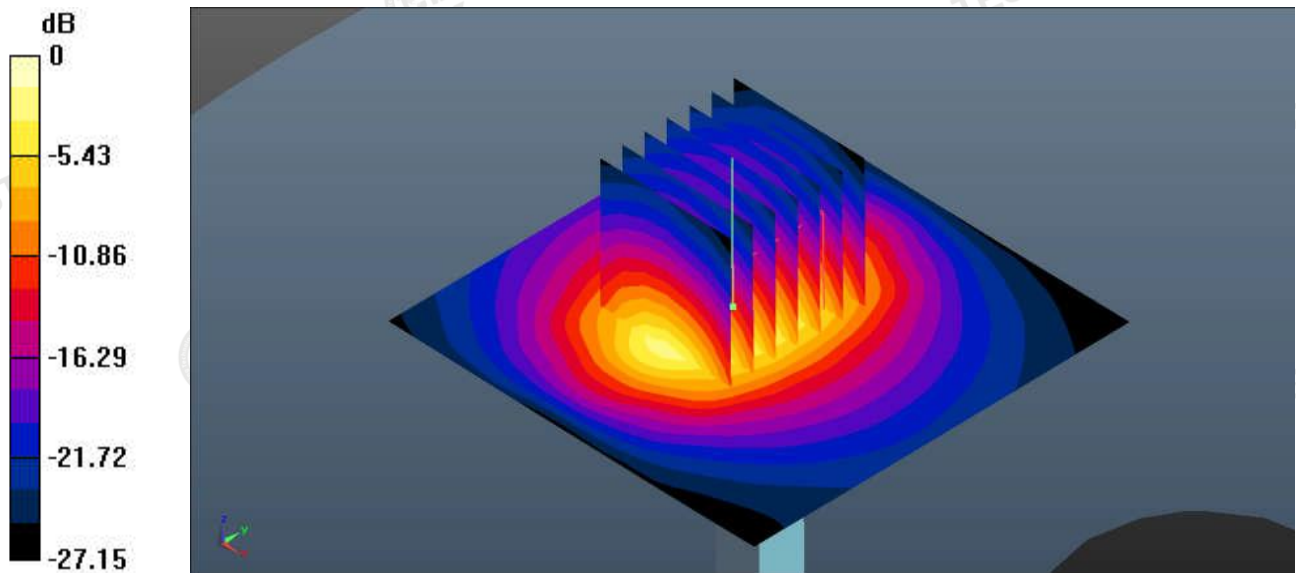

0 dB = 21.1 W/kg

System Performance Check 2450MHz 250mW

DUT: Dipole 5GHz; Type: D5GHzV2; Serial: 1301

Communication System: CW; Frequency: 5250 MHz; Duty Cycle: 1:1

Medium parameters used (interpolated): $f = 5250$ MHz; $\sigma = 4.702$ S/m; $\epsilon_r = 35.670$; $\rho = 1000$ kg/m³

Phantom section: Flat Section

DASY5 Configuration:

- Probe: EX3DV4 - SN7624; ConvF(5.55, 5.55, 5.55); Calibrated: Sep. 06, 2023
- Sensor-Surface: 2mm (Mechanical Surface Detection)
- Electronics: DAE3 Sn428; Calibrated: 08/30/2023
- Phantom: SAM 2; Type: QD000P40CC; Serial: TP:1474
- DASY52 52.10.2(1495); SEMCAD X 14.6.12(7450)

Area Scan (101x101x1): Interpolated grid: dx=1.000 mm, dy=1.000 mm

Maximum value of SAR (interpolated) = 9.65 W/kg

Zoom Scan (7x7x13): Measurement grid: dx=4mm, dy=4mm, dz=2mm

Reference Value = 33.78 V/m; Power Drift = -0.11 dB

Peak SAR (extrapolated) = 18.5 W/kg

SAR(1 g) = 7.78 W/kg; SAR(10 g) = 2.37 W/kg

Maximum value of SAR (measured) = 9.85 W/kg

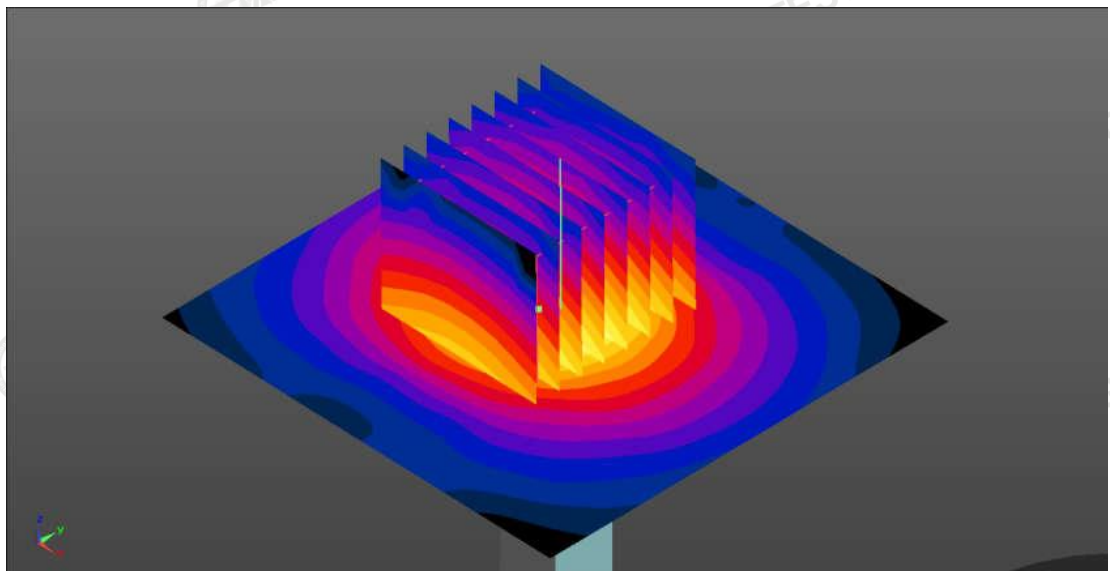
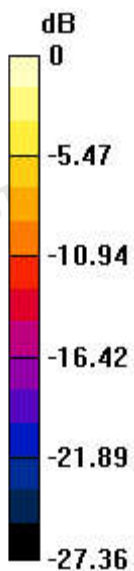

0 dB = 9.85 W/kg

System Performance Check 5250MHz 100mW

DUT: Dipole 5GHz; Type: D5GHzV2; Serial: 1301

Communication System: CW; Frequency: 5750 MHz; Duty Cycle: 1:1

Medium parameters used (interpolated): $f = 5750$ MHz; $\sigma = 5.365$ S/m; $\epsilon_r = 34.480$; $\rho = 1000$ kg/m³

Phantom section: Flat Section

DASY5 Configuration:

- Probe: EX3DV4 - SN7624; ConvF(4.98, 4.98, 4.98); Calibrated: Sep. 06, 2023
- Sensor-Surface: 2mm (Mechanical Surface Detection)
- Electronics: DAE3 Sn428; Calibrated: 08/30/2023
- Phantom: SAM 2; Type: QD000P40CC; Serial: TP:1474
- DASY52 52.10.2(1495); SEMCAD X 14.6.12(7450)

Area Scan (101x101x1): Interpolated grid: dx=1.000 mm, dy=1.000 mm

Maximum value of SAR (interpolated) = 18.4 W/kg

Zoom Scan (7x7x13): Measurement grid: dx=4mm, dy=4mm, dz=2mm

Reference Value = 42.24 V/m; Power Drift = -0.05 dB

Peak SAR (extrapolated) = 20.57 W/kg

SAR(1 g) = 7.95 W/kg; SAR(10 g) = 2.26 W/kg

Maximum value of SAR (measured) = 18.3 W/kg

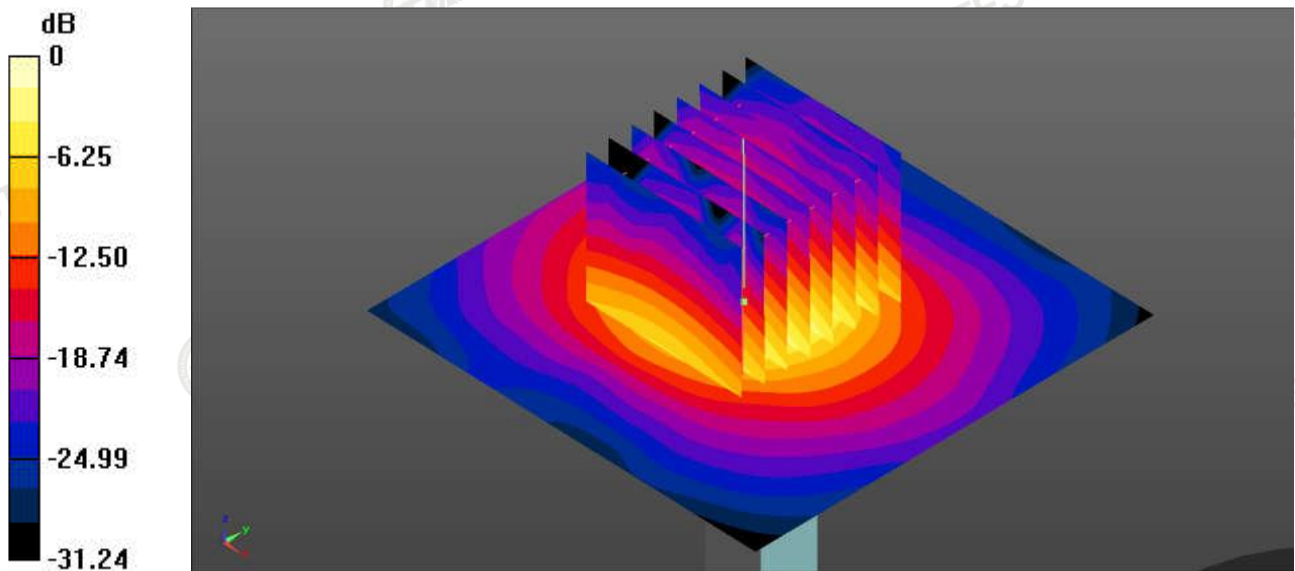

0 dB = 18.3 W/kg

System Performance Check 5750MHz 100mW

Appendix C. Plots of SAR Test Data

#1

Date: 07/24/2024

LTE Band 2_20MHz/1RB#99_Back_0mm_Ch18900

Communication System: UID 0, Generic LTE (0); Frequency: 1880.0 MHz; Duty Cycle: 1:1

Medium parameters used (interpolated): $f = 1880.0$ MHz; $\sigma = 1.415$ S/m; $\epsilon_r = 39.836$; $\rho = 1000$ kg/m³

Phantom section: Flat Section

DASY5 Configuration:

- Probe: EX3DV4 - SN7624; ConvF(8.35, 8.35, 8.35); Calibrated: Sep. 06, 2023
- Sensor-Surface: 2mm (Mechanical Surface Detection)
- Electronics: DAE3 Sn428; Calibrated: 08/30/2023
- Phantom: SAM 2; Type: QD000P40CC; Serial: TP:1474
- DASY52 52.10.2(1495); SEMCAD X 14.6.12(7450)

Area Scan (81x121x1): Interpolated grid: dx=1.500 mm, dy=1.500 mm

Maximum value of SAR (interpolated) = 0.98 W/kg

Zoom Scan (5x5x7)/Cube 0: Measurement grid: dx=8mm, dy=8mm, dz=5mm

Reference Value = 24.254 V/m; Power Drift = -0.07 dB

Peak SAR (extrapolated) = 1.39 W/kg

SAR(1 g) = 0.587 W/kg; SAR(10 g) = 0.279 W/kg

Maximum value of SAR (measured) = 1.11 W/kg

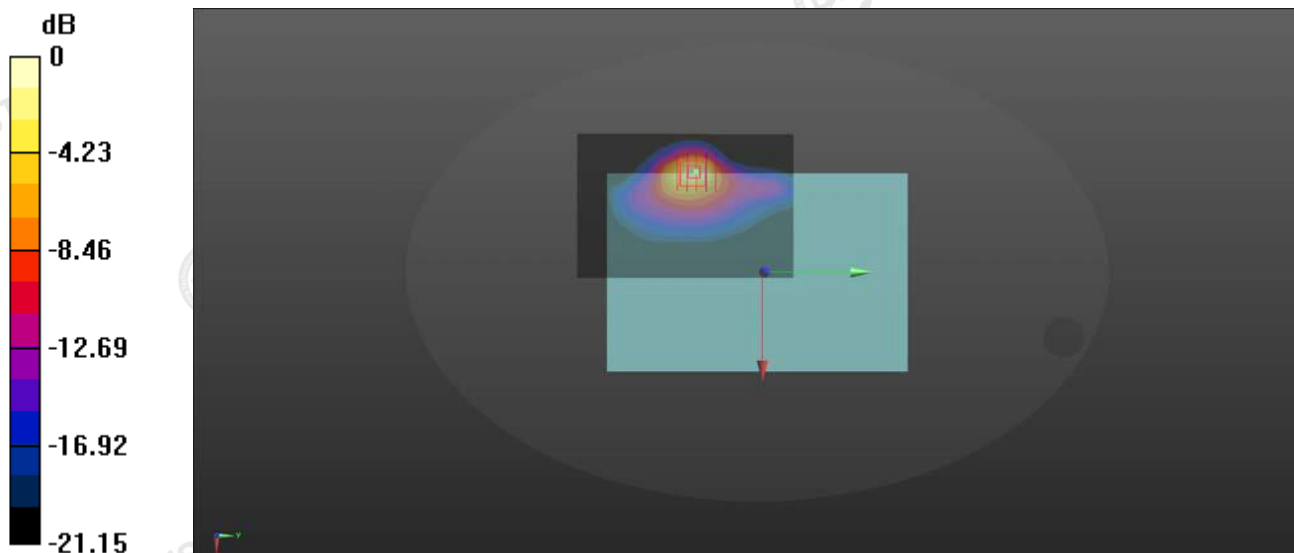

0 dB = 1.11 W/kg

#2

Date: 07/23/2024

LTE Band 4_20MHz/1RB#0_Back_0mm_Ch20175

Communication System: UID 0, Generic LTE (0); Frequency: 1747.5 MHz; Duty Cycle: 1:1

Medium parameters used (interpolated): $f = 1747.5$ MHz; $\sigma = 1.385$ S/m; $\epsilon_r = 41.147$; $\rho = 1000$ kg/m³

Phantom section: Flat Section

DASY5 Configuration:

- Probe: EX3DV4 - SN7624; ConvF(8.66, 8.66, 8.66); Calibrated: Sep. 06, 2023
- Sensor-Surface: 2mm (Mechanical Surface Detection)
- Electronics: DAE3 Sn428; Calibrated: 08/30/2023
- Phantom: SAM 2; Type: QD000P40CC; Serial: TP:1474
- DASY52 52.10.2(1495); SEMCAD X 14.6.12(7450)

Area Scan (81x121x1): Interpolated grid: dx=1.500 mm, dy=1.500 mm

Maximum value of SAR (interpolated) = 1.11 W/kg

Zoom Scan (5x5x7)/Cube 0: Measurement grid: dx=8mm, dy=8mm, dz=5mm

Reference Value = 25.47 V/m; Power Drift = -0.05 dB

Peak SAR (extrapolated) = 1.55 W/kg

SAR(1 g) = 0.605 W/kg; SAR(10 g) = 0.311 W/kg

Maximum value of SAR (measured) = 1.15 W/kg

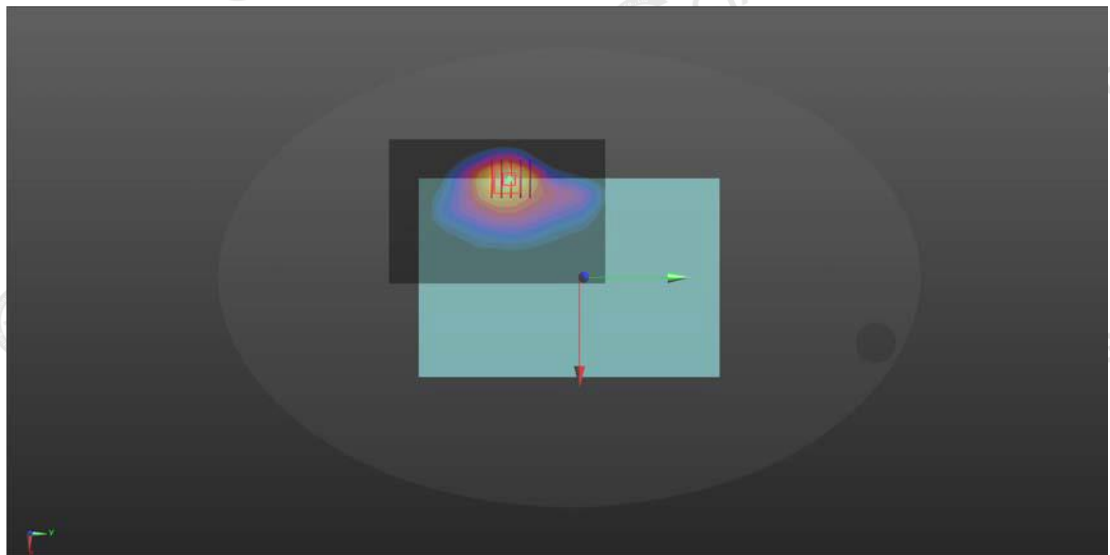
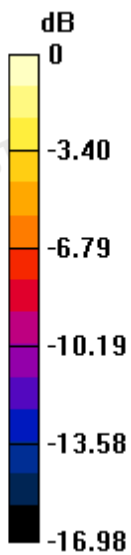

0 dB = 1.15 W/kg

#3

Date: 07/22/2024

LTE Band 12_10MHz/1RB#49_Back_0mm_Ch23095

Communication System: UID 0, Generic LTE (0); Frequency: 707.5 MHz; Duty Cycle: 1:1
 Medium parameters used (interpolated): $f = 707.5$ MHz; $\sigma = 1.375$ S/m; $\epsilon_r = 41.179$; $\rho = 1000$ kg/m³
 Phantom section: Flat Section

DASY5 Configuration:

- Probe: EX3DV4 - SN7624; ConvF(10.58, 10.58, 10.58); Calibrated: Sep. 06, 2023
- Sensor-Surface: 2mm (Mechanical Surface Detection)
- Electronics: DAE3 Sn428; Calibrated: 08/30/2023
- Phantom: SAM 2; Type: QD000P40CC; Serial: TP:1474
- DASY52 52.10.2(1495); SEMCAD X 14.6.12(7450)

Area Scan (81x121x1): Interpolated grid: dx=1.500 mm, dy=1.500 mm
 Maximum value of SAR (interpolated) = 0.663 W/kg

Zoom Scan (5x5x7)/Cube 0: Measurement grid: dx=8mm, dy=8mm, dz=5mm
 Reference Value = 20.25 V/m; Power Drift = 0.03 dB
 Peak SAR (extrapolated) = 1.05 W/kg

SAR(1 g) = 0.478 W/kg; SAR(10 g) = 0.262 W/kg
 Maximum value of SAR (measured) = 0.711 W/kg

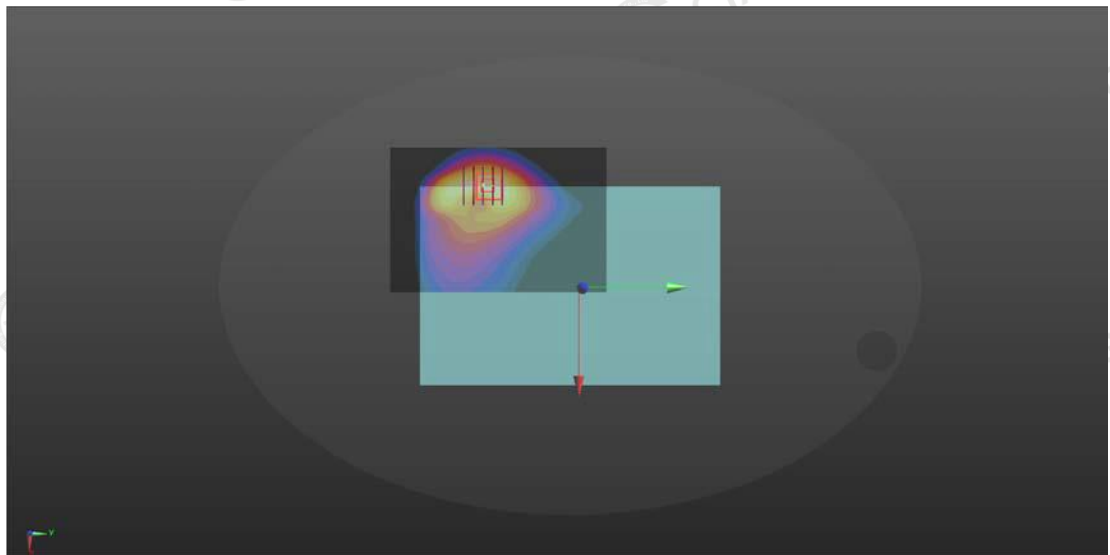
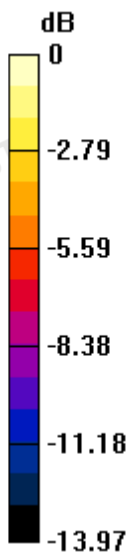

0 dB = 0.711 W/kg

#4

Date: 07/25/2024

WIFI2.4G_DSSS_Back_0mm_Ch01

Communication System: UID 0, Generic WIFI (0); Frequency: 2412 MHz; Duty Cycle: 1:1

Medium parameters used (interpolated): $f = 2412$ MHz; $\sigma = 1.755$ S/m; $\epsilon_r = 39.548$; $\rho = 1000$ kg/m³

Phantom section: Flat Section

DASY5 Configuration:

- Probe: EX3DV4 - SN7624; ConvF(7.85, 7.85, 7.85); Calibrated: Sep. 06, 2023
- Sensor-Surface: 2mm (Mechanical Surface Detection)
- Electronics: DAE3 Sn428; Calibrated: 08/30/2023
- Phantom: SAM 2; Type: QD000P40CC; Serial: TP:1474
- DASY52 52.10.2(1495); SEMCAD X 14.6.12(7450)

Area Scan (51x121x1): Interpolated grid: dx=1.200 mm, dy=1.200 mm

Maximum value of SAR (interpolated) = 0.475 W/kg

Zoom Scan (7x7x7)/Cube 0: Measurement grid: dx=5mm, dy=5mm, dz=5mm

Reference Value = 1.524 V/m; Power Drift = -0.10 dB

Peak SAR (extrapolated) = 0.662 W/kg

SAR(1 g) = 0.255 W/kg; SAR(10 g) = 0.112 W/kg

Maximum value of SAR (measured) = 0.429 W/kg

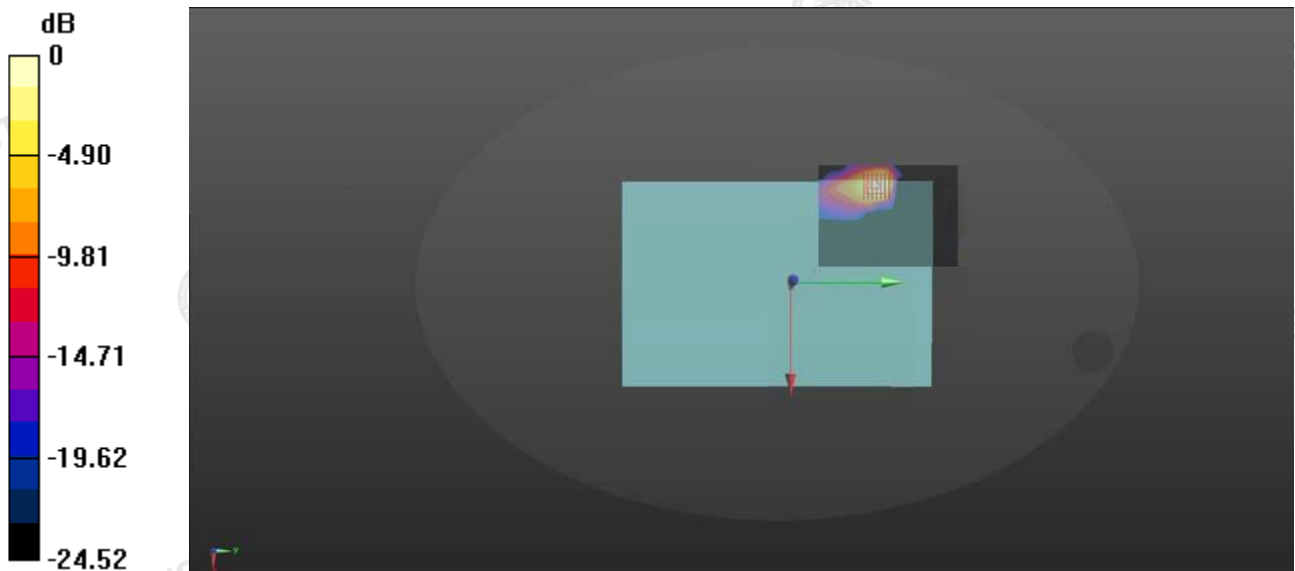

0 dB = 0.429 W/kg

#5

Date: 07/26/2024

WLAN 5.2GHz_802.11ac(HT20)_Back_0mm_CH36

Communication System: UID 0, Generic WLAN (0); Frequency: 5180 MHz; Duty Cycle: 1:1
Medium parameters used (interpolated): $f = 5180$ MHz; $\sigma = 4.665$ S/m; $\epsilon_r = 36.441$; $\rho = 1000$ kg/m³
Phantom section: Flat Section

DASY5 Configuration:

- Probe: EX3DV4 - SN7624; ConvF(5.55, 5.55, 5.55); Calibrated: Sep. 06, 2023
- Sensor-Surface: 2mm (Mechanical Surface Detection)
- Electronics: DAE3 Sn428; Calibrated: 08/30/2023
- Phantom: SAM 2; Type: QD000P40CC; Serial: TP:1474
- DASY52 52.10.2(1495); SEMCAD X 14.6.12(7450)

Area Scan (91x91x1): Measurement grid: dx=1.000mm, dy=1.000mm
Maximum value of SAR (interpolated) = 0.623 W/Kg

Zoom Scan (8x8x8)/Cube 0: Measurement grid: dx=4mm, dy=4mm, dz=4mm
Reference Value = 5.542 V/m; Power Drift = 0.07 dB
Peak SAR (extrapolated) = 1.47 W/kg

SAR(1 g) = 0.254 W/kg; SAR(10 g) = 0.085 W/kg
Maximum value of SAR (measured) = 0.530 W/Kg

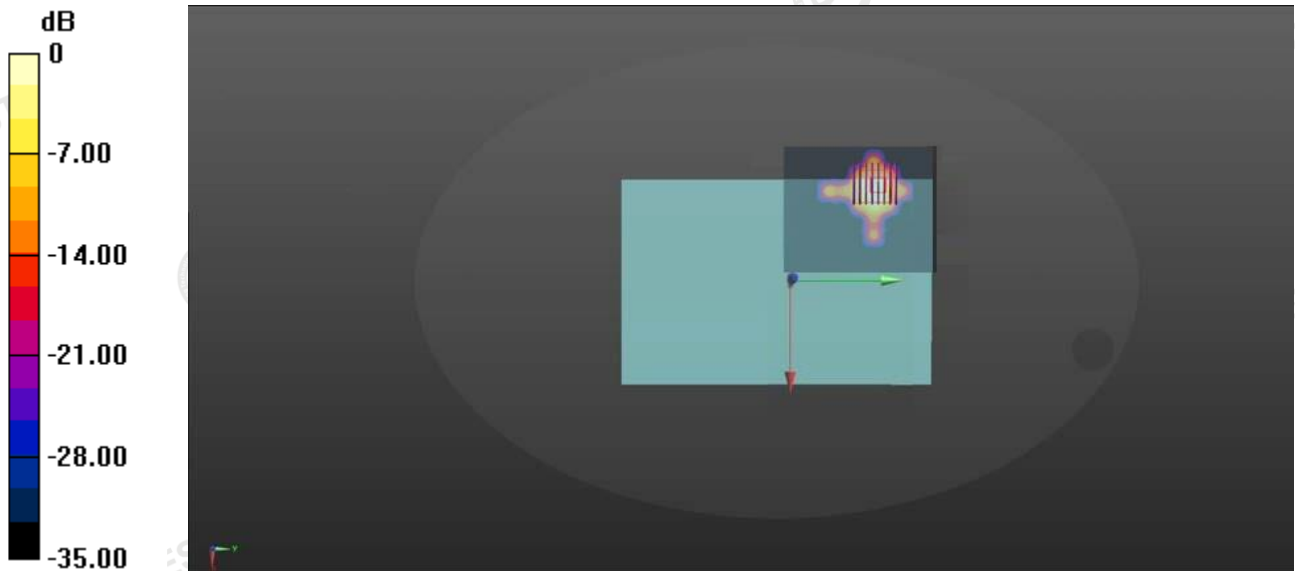

0 dB = 0.530 W/kg

#6

Date: 07/29/2024

WLAN 5.8GHz_802.11ac(HT20)_Back_0mm_CH157

Communication System: UID 0, Generic WLAN (0); Frequency: 5785 MHz; Duty Cycle: 1:1
 Medium parameters used (interpolated): $f = 5785$ MHz; $\sigma = 5.374$ S/m; $\epsilon_r = 34.646$; $\rho = 1000$ kg/m³
 Phantom section: Flat Section

DASY5 Configuration:

- Probe: EX3DV4 - SN7624; ConvF(4.98, 4.98, 4.98); Calibrated: Sep. 06, 2023
- Sensor-Surface: 2mm (Mechanical Surface Detection)
- Electronics: DAE3 Sn428; Calibrated: 08/30/2023
- Phantom: SAM 2; Type: QD000P40CC; Serial: TP:1474
- DASY52 52.10.2(1495); SEMCAD X 14.6.12(7450)

Area Scan (91x101x1): Measurement grid: dx=1.000mm, dy=1.000mm
 Maximum value of SAR (interpolated) = 0.452 W/Kg

Zoom Scan (8x8x8): Measurement grid: dx=4mm, dy=4mm, dz=4mm
 Reference Value = 3.674 V/m; Power Drift = -0.10 dB
 Peak SAR (extrapolated) = 0.854 W/kg

SAR(1 g) = 0.217 W/kg; SAR(10 g) = 0.049 W/kg
 Maximum value of SAR (measured) = 0.554 W/kg

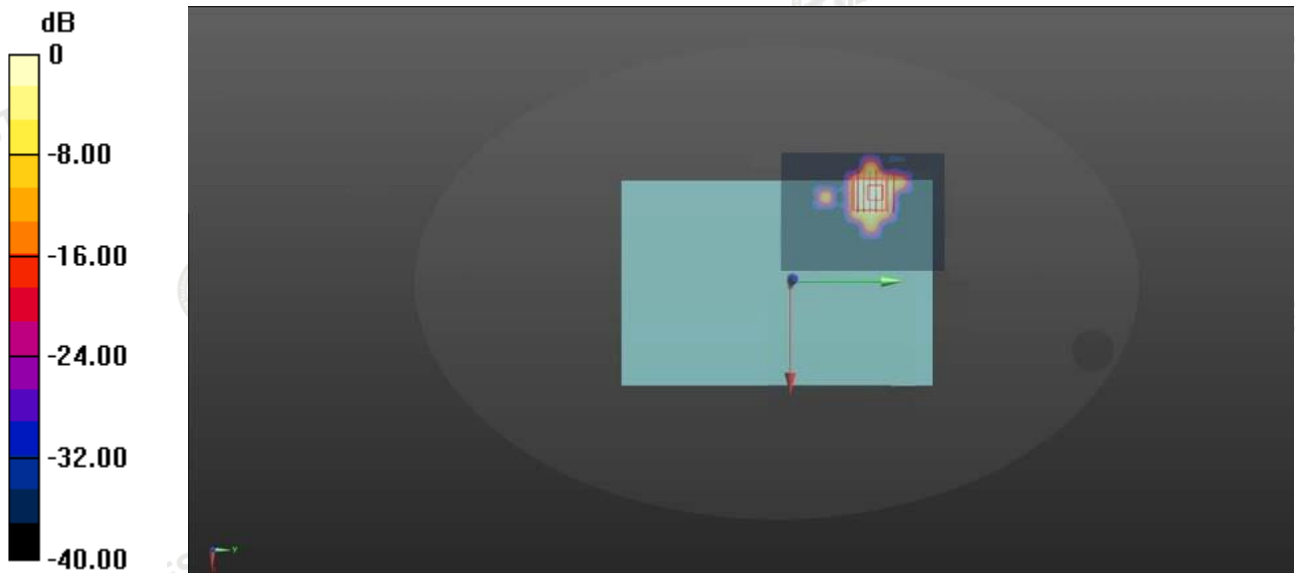

0 dB = 0.554 W/kg

Appendix D. DASY System Calibration Certificate

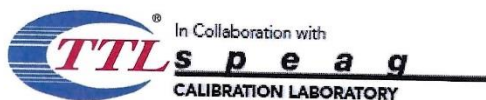

In Collaboration with
TTL Speag
 CALIBRATION LABORATORY
 Add: No.52 HuaYuanBei Road, Haidian District, Beijing, 100191, China
 Tel: +86-10-62304633-2117
 E-mail: emf@caict.ac.cn http://www.caict.ac.cn



中国认可
 国际互认
 校准
CAICT
 CALIBRATION
 CNAS L0570

Client **INNOWAVE**

Certificate No: **J23Z60222**

CALIBRATION CERTIFICATE

Object: **EX3DV4 - SN : 7624**

Calibration Procedure(s): **FF-Z11-004-02**
 Calibration Procedures for Dosimetric E-field Probes

Calibration date: **September 06, 2023**

This calibration Certificate documents the traceability to national standards, which realize the physical units of measurements(SI). The measurements and the uncertainties with confidence probability are given on the following pages and are part of the certificate.

All calibrations have been conducted in the closed laboratory facility: environment temperature(22±3)°C and humidity<70%.

Calibration Equipment used (M&TE critical for calibration)

| Primary Standards | ID # | Cal Date(Calibrated by, Certificate No.) | Scheduled Calibration |
|--------------------------|-------------|--|-----------------------|
| Power Meter NRP2 | 101919 | 12-Jun-23(CTTL, No.J23X05435) | Jun-24 |
| Power sensor NRP-Z91 | 101547 | 12-Jun-23(CTTL, No.J23X05435) | Jun-24 |
| Power sensor NRP-Z91 | 101548 | 12-Jun-23(CTTL, No.J23X05435) | Jun-24 |
| Reference 10dBAttenuator | 18N50W-10dB | 19-Jan-23(CTTL, No.J23X00212) | Jan-25 |
| Reference 20dBAttenuator | 18N50W-20dB | 19-Jan-23(CTTL, No.J23X00211) | Jan-25 |
| Reference Probe EX3DV4 | SN 3846 | 31-May-23(SPEAG, No.EX-3846_May23) | May-24 |
| DAE4 | SN 549 | 24-Jan-23(SPEAG, No.DAE4-549_Jan23) | Jan-24 |
| DAE4 | SN 1744 | 30-Aug-22(SPEAG, No.DAE4-1744_Aug22) | Aug-23 |
| Secondary Standards | ID # | Cal Date(Calibrated by, Certificate No.) | Scheduled Calibration |
| SignalGenerator MG3700A | 6201052605 | 12-Jun-23(CTTL, No.J23X05434) | Jun-24 |
| Network Analyzer E5071C | MY46110673 | 10-Jan-23(CTTL, No.J23X00104) | Jan-24 |
| Reference 10dBAttenuator | BT0520 | 11-May-23(CTTL, No.J23X04061) | May-25 |
| Reference 20dBAttenuator | BT0267 | 11-May-23(CTTL, No.J23X04062) | May-25 |
| OCP DAK-3.5 | SN 1040 | 18-Jan-23(SPEAG, No.OCP-DAK3.5-1040_Jan23) | Jan-24 |

| | Name | Function | Signature |
|----------------|-------------|--------------------|-----------|
| Calibrated by: | Yu Zongying | SAR Test Engineer | |
| Reviewed by: | Lin Hao | SAR Test Engineer | |
| Approved by: | Qi Dianyuan | SAR Project Leader | |

Issued: September 12, 2023

This calibration certificate shall not be reproduced except in full without written approval of the laboratory.



Add: No.52 HuaYuanBei Road, Haidian District, Beijing, 100191, China
 Tel: +86-10-62304633-2117
 E-mail: emf@caict.ac.cn <http://www.caict.ac.cn>

Glossary:

| | |
|-----------------------|---|
| TSL | tissue simulating liquid |
| NORM _{x,y,z} | sensitivity in free space |
| ConvF | sensitivity in TSL / NORM _{x,y,z} |
| DCP | diode compression point |
| CF | crest factor (1/duty_cycle) of the RF signal |
| A,B,C,D | modulation dependent linearization parameters |
| Polarization Φ | Φ rotation around probe axis |
| Polarization θ | θ rotation around an axis that is in the plane normal to probe axis (at measurement center), i $\theta=0$ is normal to probe axis |
| Connector Angle | information used in DASY system to align probe sensor X to the robot coordinate system |

Calibration is Performed According to the Following Standards:

- IEEE Std 1528-2013, "IEEE Recommended Practice for Determining the Peak Spatial-Averaged Specific Absorption Rate (SAR) in the Human Head from Wireless Communications Devices: Measurement Techniques", June 2013
- IEC 62209-1, "Measurement procedure for the assessment of Specific Absorption Rate (SAR) from hand-held and body-mounted devices used next to the ear (frequency range of 300 MHz to 6 GHz)", July 2016
- IEC 62209-2, "Procedure to determine the Specific Absorption Rate (SAR) for wireless communication devices used in close proximity to the human body (frequency range of 30 MHz to 6 GHz)", March 2010
- KDB 865664, "SAR Measurement Requirements for 100 MHz to 6 GHz"

Methods Applied and Interpretation of Parameters:

- NORM_{x,y,z}**: Assessed for E-field polarization $\theta=0$ ($f \leq 900$ MHz in TEM-cell; $f > 1800$ MHz: waveguide). NORM_{x,y,z} are only intermediate values, i.e., the uncertainties of NORM_{x,y,z} does not effect the E^2 -field uncertainty inside TSL (see below ConvF).
- NORM(f)_{x,y,z} = NORM_{x,y,z} * frequency_response** (see Frequency Response Chart). This linearization is implemented in DASY4 software versions later than 4.2. The uncertainty of the frequency response is included in the stated uncertainty of ConvF.
- DCP_{x,y,z}**: DCP are numerical linearization parameters assessed based on the data of power sweep (no uncertainty required). DCP does not depend on frequency nor media.
- PAR**: PAR is the Peak to Average Ratio that is not calibrated but determined based on the signal characteristics.
- A_{x,y,z}; B_{x,y,z}; C_{x,y,z}; VR_{x,y,z}; A,B,C** are numerical linearization parameters assessed based on the data of power sweep for specific modulation signal. The parameters do not depend on frequency nor media. VR is the maximum calibration range expressed in RMS voltage across the diode.
- ConvF and Boundary Effect Parameters**: Assessed in flat phantom using E-field (or Temperature Transfer Standard for $f \leq 800$ MHz) and inside waveguide using analytical field distributions based on power measurements for $f > 800$ MHz. The same setups are used for assessment of the parameters applied for boundary compensation (alpha, depth) of which typical uncertainty valued are given. These parameters are used in DASY4 software to improve probe accuracy close to the boundary. The sensitivity in TSL corresponds to NORM_{x,y,z} * ConvF whereby the uncertainty corresponds to that given for ConvF. A frequency dependent ConvF is used in DASY version 4.4 and higher which allows extending the validity from ± 50 MHz to ± 100 MHz.
- Spherical isotropy (3D deviation from isotropy)**: in a field of low gradients realized using a flat phantom exposed by a patch antenna.
- Sensor Offset**: The sensor offset corresponds to the offset of virtual measurement center from the probe tip (on probe axis). No tolerance required.
- Connector Angle**: The angle is assessed using the information gained by determining the NORM_x (no uncertainty required).

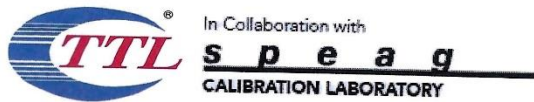

Add: No.52 HuaYuanBei Road, Haidian District, Beijing, 100191, China
 Tel: +86-10-62304633-2117
 E-mail: emf@caict.ac.cn http://www.caict.ac.cn

DASY/EASY – Parameters of Probe: EX3DV4 – SN:7624

Basic Calibration Parameters

| | Sensor X | Sensor Y | Sensor Z | Unc (k=2) |
|--|----------|----------|----------|--------------|
| Norm($\mu\text{V}/(\text{V}/\text{m})^2$) ^A | 0.57 | 0.59 | 0.58 | $\pm 10.0\%$ |
| DCP(mV) ^B | 112.6 | 113.4 | 119.4 | |

Modulation Calibration Parameters

| UID | Communication System Name | | A dB | B dB- μV | C | D dB | VR mV | Unc ^E (k=2) |
|-----|---------------------------|---|------|---------------------|-----|------|-------|------------------------|
| 0 | CW | X | 0.0 | 0.0 | 1.0 | 0.00 | 200.3 | $\pm 4.7\%$ |
| | | Y | 0.0 | 0.0 | 1.0 | | 212.4 | |
| | | Z | 0.0 | 0.0 | 1.0 | | 202.8 | |

The reported uncertainty of measurement is stated as the standard uncertainty of Measurement multiplied by the coverage factor $k=2$, which for a normal distribution Corresponds to a coverage probability of approximately 95%.

^A The uncertainties of Norm X, Y, Z do not affect the E²-field uncertainty inside TSL (see Page 4).

^B Numerical linearization parameter: uncertainty not required.

^E Uncertainty is determined using the max. deviation from linear response applying rectangular distribution and is expressed for the square of the field value.



Add: No.52 HuaYuanBei Road, Haidian District, Beijing, 100191, China
Tel: +86-10-62304633-2117
E-mail: emf@caict.ac.cn <http://www.caict.ac.cn>

DASY/EASY – Parameters of Probe: EX3DV4 – SN:7624

Calibration Parameter Determined in Head Tissue Simulating Media

| f [MHz] ^C | Relative Permittivity ^F | Conductivity (S/m) ^F | ConvF X | ConvF Y | ConvF Z | Alpha ^G | Depth ^G (mm) | Unct. (k=2) |
|----------------------|------------------------------------|---------------------------------|---------|---------|---------|--------------------|-------------------------|-------------|
| 750 | 41.9 | 0.89 | 10.58 | 10.58 | 10.58 | 0.20 | 1.06 | ±12.7% |
| 835 | 41.5 | 0.90 | 10.19 | 10.19 | 10.19 | 0.19 | 1.20 | ±12.7% |
| 1750 | 40.1 | 1.37 | 8.66 | 8.66 | 8.66 | 0.21 | 1.13 | ±12.7% |
| 1900 | 40.0 | 1.40 | 8.35 | 8.35 | 8.35 | 0.33 | 0.91 | ±12.7% |
| 2100 | 39.8 | 1.49 | 8.27 | 8.27 | 8.27 | 0.23 | 1.08 | ±12.7% |
| 2300 | 39.5 | 1.67 | 8.13 | 8.13 | 8.13 | 0.58 | 0.67 | ±12.7% |
| 2450 | 39.2 | 1.80 | 7.85 | 7.85 | 7.85 | 0.63 | 0.66 | ±12.7% |
| 2600 | 39.0 | 1.96 | 7.66 | 7.66 | 7.66 | 0.65 | 0.66 | ±12.7% |
| 3500 | 37.9 | 2.91 | 7.20 | 7.20 | 7.20 | 0.34 | 1.00 | ±13.9% |
| 3700 | 37.7 | 3.12 | 7.00 | 7.00 | 7.00 | 0.36 | 1.07 | ±13.9% |
| 3900 | 37.5 | 3.32 | 6.85 | 6.85 | 6.85 | 0.30 | 1.50 | ±13.9% |
| 4100 | 37.2 | 3.53 | 6.78 | 6.78 | 6.78 | 0.30 | 1.35 | ±13.9% |
| 4200 | 37.1 | 3.63 | 6.68 | 6.68 | 6.68 | 0.30 | 1.45 | ±13.9% |
| 4400 | 36.9 | 3.84 | 6.61 | 6.61 | 6.61 | 0.30 | 1.45 | ±13.9% |
| 4600 | 36.7 | 4.04 | 6.47 | 6.47 | 6.47 | 0.40 | 1.30 | ±13.9% |
| 4800 | 36.4 | 4.25 | 6.37 | 6.37 | 6.37 | 0.40 | 1.40 | ±13.9% |
| 4950 | 36.3 | 4.40 | 6.08 | 6.08 | 6.08 | 0.40 | 1.40 | ±13.9% |
| 5250 | 35.9 | 4.71 | 5.55 | 5.55 | 5.55 | 0.40 | 1.50 | ±13.9% |
| 5600 | 35.5 | 5.07 | 4.96 | 4.96 | 4.96 | 0.35 | 1.70 | ±13.9% |
| 5750 | 35.4 | 5.22 | 4.98 | 4.98 | 4.98 | 0.35 | 1.80 | ±13.9% |

^C Frequency validity above 300 MHz of ±100MHz only applies for DASY v4.4 and higher (Page 2), else it is restricted to ±50MHz. The uncertainty is the RSS of ConvF uncertainty at calibration frequency and the uncertainty for the indicated frequency band. Frequency validity below 300 MHz is ± 10, 25, 40, 50 and 70 MHz for ConvF assessments at 30, 64, 128, 150 and 220 MHz respectively. Above 5 GHz frequency validity can be extended to ± 110 MHz.

^F At frequency up to 6 GHz, the validity of tissue parameters (ϵ and σ) can be relaxed to ±10% if liquid compensation formula is applied to measured SAR values. The uncertainty is the RSS of the ConvF uncertainty for indicated target tissue parameters.

^G Alpha/Depth are determined during calibration. SPEAG warrants that the remaining deviation due to the boundary effect after compensation is always less than ± 1% for frequencies below 3 GHz and below ± 2% for the frequencies between 3-6 GHz at any distance larger than half the probe tip diameter from the boundary.



Add: No.52 HuaYuanBei Road, Haidian District, Beijing, 100191, China
Tel: +86-10-62304633-2117
E-mail: emf@caict.ac.cn <http://www.caict.ac.cn>

Frequency Response of E-Field (TEM-Cell: ifi110 EXX, Waveguide: R22)

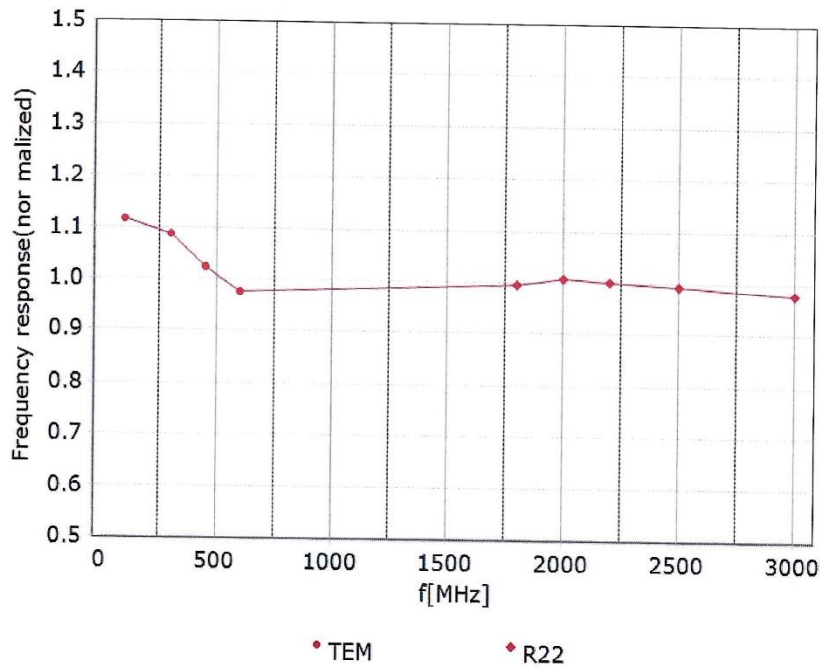

Uncertainty of Frequency Response of E-field: $\pm 7.4\%$ ($k=2$)



Add: No.52 HuaYuanBei Road, Haidian District, Beijing, 100191, China
Tel: +86-10-62304633-2117
E-mail: emf@caict.ac.cn http://www.caict.ac.cn

Receiving Pattern (Φ), $\theta=0^\circ$

f=600 MHz, TEM

f=1800 MHz, R22

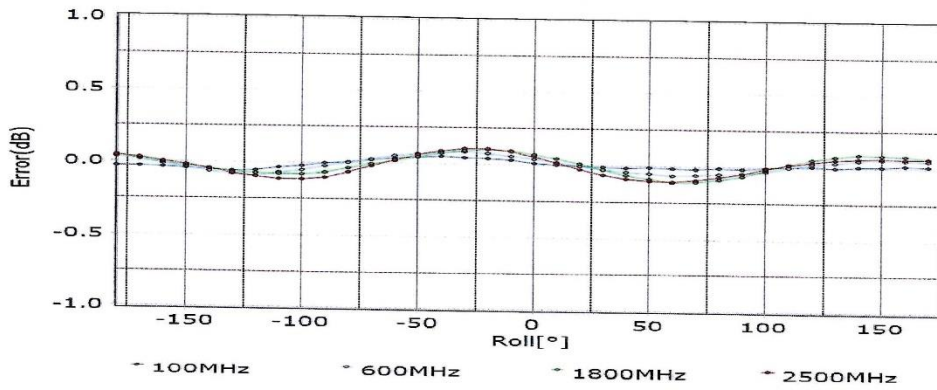
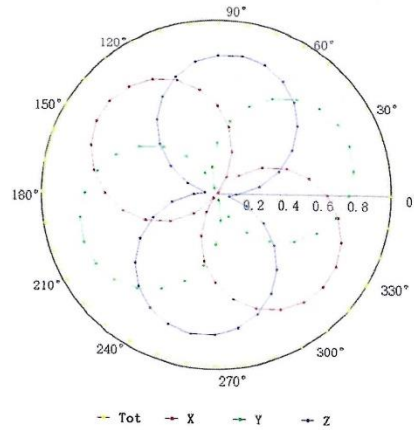
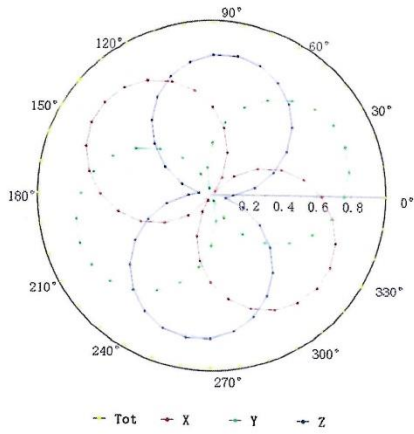

Uncertainty of Axial Isotropy Assessment: $\pm 1.2\%$ ($k=2$)



Add: No.52 HuaYuanBei Road, Haidian District, Beijing, 100191, China
Tel: +86-10-62304633-2117
E-mail: cmf@caict.ac.cn <http://www.caict.ac.cn>

Dynamic Range f(SAR_{head}) (TEM cell, f = 900 MHz)

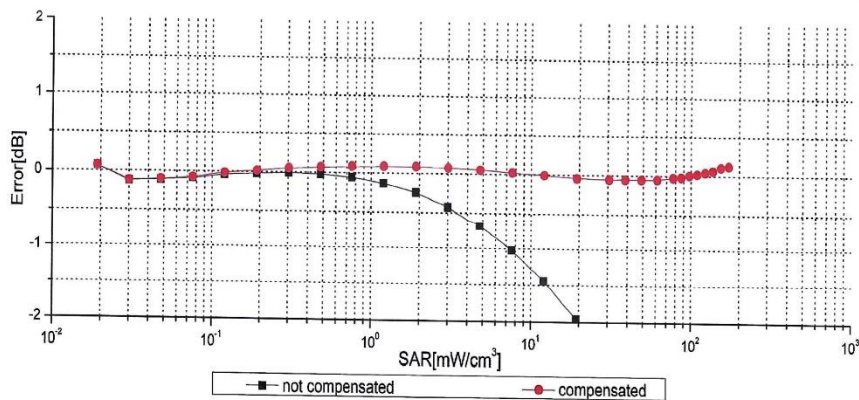
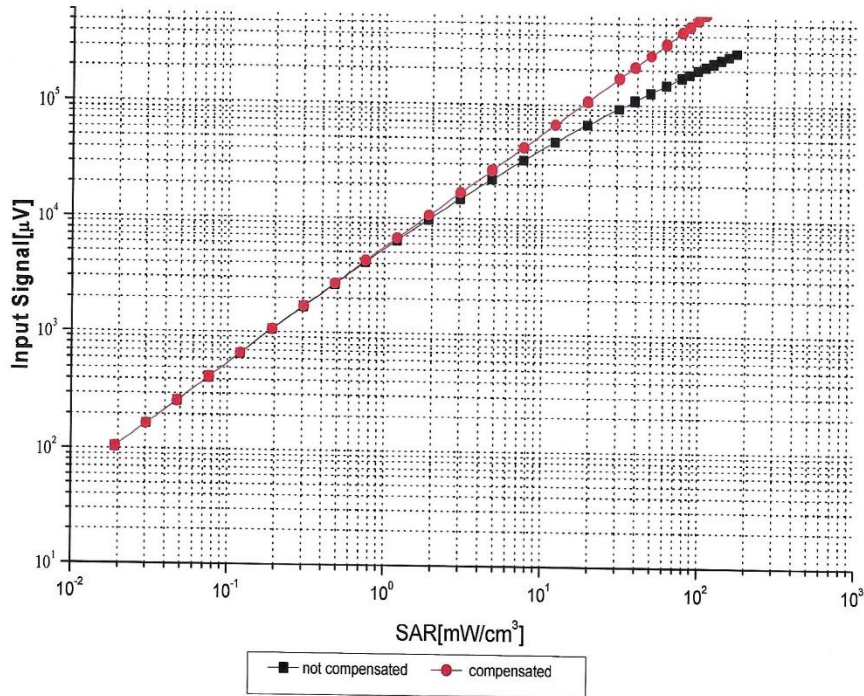

Uncertainty of Linearity Assessment: ±0.9% (k=2)



Add: No.52 HuaYuanBei Road, Haidian District, Beijing, 100191, China
Tel: +86-10-62304633-2117
E-mail: emf@caict.ac.cn http://www.caict.ac.cn

Conversion Factor Assessment

f=750 MHz,WGLS R9(H_convF)

f=1750 MHz,WGLS R22(H_convF)

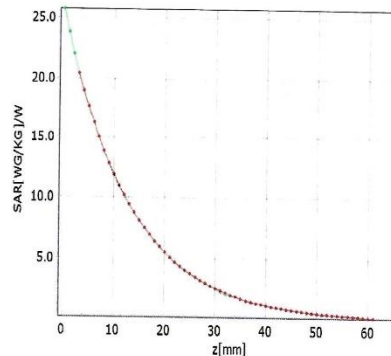
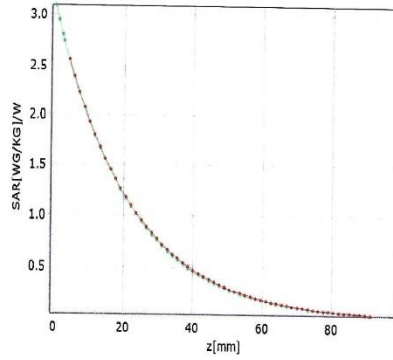

Deviation from Isotropy in Liquid

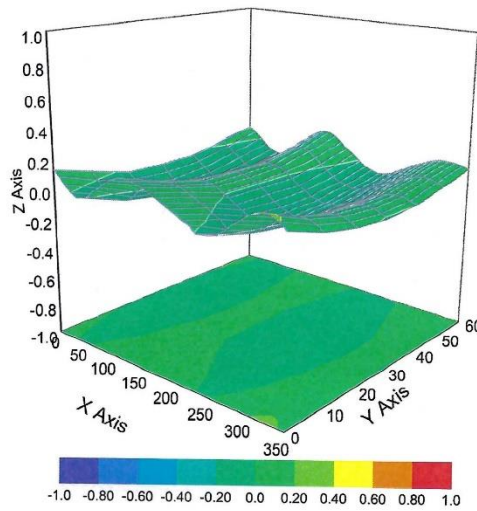

Uncertainty of Spherical Isotropy Assessment: $\pm 3.2\%$ ($k=2$)



Add: No.52 HuaYuanBei Road, Haidian District, Beijing, 100191, China
 Tel: +86-10-62304633-2117
 E-mail: emf@caict.ac.cn <http://www.caict.ac.cn>

DASY/EASY – Parameters of Probe: EX3DV4 – SN:7624

Other Probe Parameters

| | |
|---|------------|
| Sensor Arrangement | Triangular |
| Connector Angle (°) | 151.7 |
| Mechanical Surface Detection Mode | enabled |
| Optical Surface Detection Mode | disable |
| Probe Overall Length | 337mm |
| Probe Body Diameter | 10mm |
| Tip Length | 9mm |
| Tip Diameter | 2.5mm |
| Probe Tip to Sensor X Calibration Point | 1mm |
| Probe Tip to Sensor Y Calibration Point | 1mm |
| Probe Tip to Sensor Z Calibration Point | 1mm |
| Recommended Measurement Distance from Surface | 1.4mm |