



Shenzhen CTA Testing Technology Co., Ltd.

Room 106, Building 1, Yibaolai Industrial Park, Qiaotou Community, Fuhai Street, Bao'an District, Shenzhen, China

### FCC PART 15 SUBPART C TEST REPORT

#### FCC PART 15.247

Report Reference No.....: CTA24062700502

FCC ID.....: 2BHYZ-X30PRO

Compiled by

( position+printed name+signature) :: File administrators Jinghua Xiao

Supervised by

( position+printed name+signature) :: Project Engineer Xudong Zhang

Approved by

( position+printed name+signature) :: RF Manager Eric Wang

Date of issue .....: Jul. 23, 2024



Testing Laboratory Name .....: Shenzhen CTA Testing Technology Co., Ltd.

Address .....: Room 106, Building 1, Yibaolai Industrial Park, Qiaotou Community, Fuhai Street, Bao'an District, Shenzhen, China

Applicant's name.....: Shenzhen Xin times chain technology Co., LTD

Address .....: 6 / F, Block F, Huachuangda Science Park, 176 Hangcheng Avenue, Hangcheng Street, Sanwei Community, Baoan District, Shenzhen, Guangdong, China

Test specification .....

Standard.....: FCC Part 15.247

Shenzhen CTA Testing Technology Co., Ltd. All rights reserved.

This publication may be reproduced in whole or in part for non-commercial purposes as long as the Shenzhen CTA Testing Technology Co., Ltd. is acknowledged as copyright owner and source of the material. Shenzhen CTA Testing Technology Co., Ltd. takes no responsibility for and will not assume liability for damages resulting from the reader's interpretation of the reproduced material due to its placement and context.

Test item description .....: Tablet computer

Trade Mark.....: N/A

Manufacturer .....: Shenzhen Xin times chain technology Co., LTD

Model/Type reference .....: X30Pro

Listed Models .....: T106, X30, X35, X70, X75, X70Pro, X50, X55, X50Pro, X90, X95, X90Pro, X101, X101Pro, X103, X103Pro, X105, X105Pro, X107, X107Pro

Modulation .....: GFSK, Π/4DQPSK, 8DPSK

Frequency .....: From 2402MHz to 2480MHz

Rating.....: DC 3.7V From Battery and DC 5.0V From external circuit

Result.....: PASS

Shenzhen CTA Testing Technology Co., Ltd.

Room 106, Building 1, Yibaolai Industrial Park, Qiaotou Community, Fuhai Street, Bao'an District, Shenzhen, China  
Tel:+86-755 2322 5875 E-mail:cta@cta-test.cn Web:http://www.cta-test.cn

# TEST REPORT

Equipment under Test : Tablet computer

Model /Type : X30Pro

Listed Models : T106, X30, X35, X70, X75, X70Pro, X50, X55, X50Pro, X90, X95, X90Pro, X101, X101Pro, X103, X103Pro, X105, X105Pro, X107, X107Pro

**Applicant** : **Shenzhen Xin times chain technology Co., LTD**

**Address** : 6 / F, Block F, Huachuangda Science Park, 176 Hangcheng Avenue, Hangcheng Street, Sanwei Community, Baoan District, Shenzhen, Guangdong, China

**Manufacturer** : **Shenzhen Xin times chain technology Co., LTD**

**Address** : 6 / F, Block F, Huachuangda Science Park, 176 Hangcheng Avenue, Hangcheng Street, Sanwei Community, Baoan District, Shenzhen, Guangdong, China

<b>Test Result:</b>	<b>PASS</b>
---------------------	-------------

The test report merely corresponds to the test sample.  
It is not permitted to copy extracts of these test result without the written permission of the test laboratory.

## Contents

<b>1</b>	<b><u>TEST STANDARDS .....</u></b>	<b>4</b>
<b>2</b>	<b><u>SUMMARY .....</u></b>	<b>5</b>
2.1	General Remarks	5
2.2	Product Description	5
2.3	Equipment Under Test	5
2.4	Short description of the Equipment under Test (EUT)	5
2.5	EUT operation mode	6
2.6	Block Diagram of Test Setup	6
2.7	Related Submittal(s) / Grant (s)	6
2.8	Modifications	6
<b>3</b>	<b><u>TEST ENVIRONMENT .....</u></b>	<b>7</b>
3.1	Address of the test laboratory	7
3.2	Test Facility	7
3.3	Environmental conditions	7
3.4	Summary of measurement results	8
3.5	Statement of the measurement uncertainty	8
3.6	Equipments Used during the Test	9
<b>4</b>	<b><u>TEST CONDITIONS AND RESULTS .....</u></b>	<b>11</b>
4.1	AC Power Conducted Emission	11
4.2	Radiated Emission	14
4.3	Maximum Peak Output Power	20
4.4	20dB Bandwidth	21
4.5	Frequency Separation	25
4.6	Number of hopping frequency	27
4.7	Time of Occupancy (Dwell Time)	29
4.8	Out-of-band Emissions	33
4.9	Pseudorandom Frequency Hopping Sequence	42
4.10	Antenna Requirement	43
<b>5</b>	<b><u>TEST SETUP PHOTOS OF THE EUT .....</u></b>	<b>44</b>
<b>6</b>	<b><u>PHOTOS OF THE EUT .....</u></b>	<b>45</b>

# 1 TEST STANDARDS

The tests were performed according to following standards:

[FCC Rules Part 15.247](#): Frequency Hopping, Direct Spread Spectrum and Hybrid Systems that are in operation within the bands of 902-928 MHz, 2400-2483.5 MHz, and 5725-5850 MHz.

[ANSI C63.10-2013](#): American National Standard for Testing Unlicensed Wireless Devices

## 2 SUMMARY

### 2.1 General Remarks

Date of receipt of test sample	:	Jun 27, 2024
Testing commenced on	:	Jun 27, 2024
Testing concluded on	:	Jul. 23, 2024

### 2.2 Product Description

Product Name:	Tablet computer
Model/Type reference:	X30Pro
Power supply:	DC 3.7V From Battery and DC 5.0V From external circuit
Adapter information:	Model: YJZN-012 Input: AC 100-240V 50/60Hz 0.3A Output: DC 5.0V 2.0A
Hardware version:	V1.0
Software version:	V1.0
Testing sample ID:	CTA240627005-1# (Engineer sample) CTA240627005-2# (Normal sample)
<b>Bluetooth :</b>	
Supported Type:	Bluetooth BR/EDR
Modulation:	GFSK, $\pi/4$ DQPSK, 8DPSK
Operation frequency:	2402MHz~2480MHz
Channel number:	79
Channel separation:	1MHz
Antenna type:	PIFA antenna
Antenna gain:	0.60dBi

### 2.3 Equipment Under Test

#### Power supply system utilised

Power supply voltage	:	<input type="radio"/> 230V / 50 Hz	<input type="radio"/> 120V / 60Hz
		<input type="radio"/> 12V DC	<input type="radio"/> 24V DC
		<input checked="" type="radio"/> Other (specified in blank below)	

DC 3.7V From Battery and DC 5.0V From external circuit

### 2.4 Short description of the Equipment under Test (EUT)

This is a Tablet computer.

For more details, refer to the user's manual of the EUT.

### 2.5 EUT operation mode

The Applicant provides communication tools software(Engineer mode) to control the EUT for staying in continuous transmitting (Duty Cycle more than 98%) and receiving mode for testing .There are 79 channels provided to the EUT and Channel 00/39/78 were selected to test.

#### Operation Frequency:

Channel	Frequency (MHz)
00	2402
01	2403
:	:
38	2440
39	2441
40	2442
:	:
77	2479
78	2480

### 2.6 Block Diagram of Test Setup

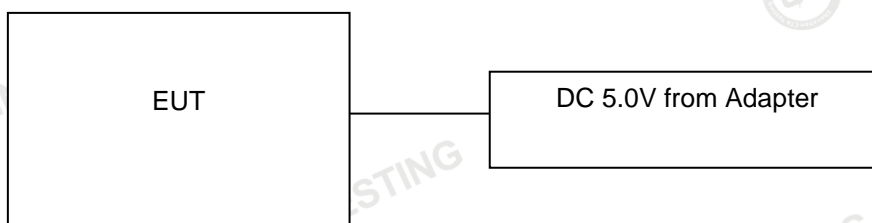

### 2.7 Related Submittal(s) / Grant (s)

This submittal(s) (test report) is intended for the device filing to comply with Section 15.247 of the FCC Part 15, Subpart C Rules.

### 2.8 Modifications

No modifications were implemented to meet testing criteria.

### 3 TEST ENVIRONMENT

#### 3.1 Address of the test laboratory

**Shenzhen CTA Testing Technology Co., Ltd.**

Room 106, Building 1, Yibaolai Industrial Park, Qiaotou Community, Fuhai Street, Bao'an District, Shenzhen, China

#### 3.2 Test Facility

The test facility is recognized, certified, or accredited by the following organizations:

**FCC-Registration No.: 517856 Designation Number: CN1318**

Shenzhen CTA Testing Technology Co., Ltd. has been listed on the US Federal Communications Commission list of test facilities recognized to perform electromagnetic emissions measurements.

**A2LA-Lab Cert. No.: 6534.01**

Shenzhen CTA Testing Technology Co., Ltd. has been listed by American Association for Laboratory Accreditation to perform electromagnetic emission measurement.

**ISED#: 27890 CAB identifier: CN0127**

Shenzhen CTA Testing Technology Co., Ltd. has been listed by Innovation, Science and Economic Development Canada to perform electromagnetic emission measurement.

The 3m-Semi anechoic test site fulfils CISPR 16-1-4 according to ANSI C63.10 and CISPR 16-1-4:2010.

#### 3.3 Environmental conditions

During the measurement the environmental conditions were within the listed ranges:

Radiated Emission:

Temperature:	24 ° C
Humidity:	45 %
Atmospheric pressure:	950-1050mbar

AC Power Conducted Emission:

Temperature:	25 ° C
Humidity:	46 %
Atmospheric pressure:	950-1050mbar

Conducted testing:

Temperature:	25 ° C
Humidity:	44 %
Atmospheric pressure:	950-1050mbar

**Shenzhen CTA Testing Technology Co., Ltd.**

Room 106, Building 1, Yibaolai Industrial Park, Qiaotou Community, Fuhai Street, Bao'an District, Shenzhen, China

Tel:+86-755 2322 5875 E-mail:cta@cta-test.cn Web:http://www.cta-test.cn

### 3.4 Summary of measurement results

Test Specification clause	Test case	Test Mode	Test Channel	Recorded In Report		Test result
§15.247(a)(1)	Carrier Frequency separation	GFSK Π/4DQPSK 8DPSK	<input checked="" type="checkbox"/> Lowest <input checked="" type="checkbox"/> Middle <input checked="" type="checkbox"/> Highest	GFSK Π/4DQPSK 8DPSK	<input checked="" type="checkbox"/> Middle	Compliant
§15.247(a)(1)	Number of Hopping channels	GFSK Π/4DQPSK 8DPSK	<input checked="" type="checkbox"/> Full	GFSK	<input checked="" type="checkbox"/> Full	Compliant
§15.247(a)(1)	Time of Occupancy (dwell time)	GFSK Π/4DQPSK 8DPSK	<input checked="" type="checkbox"/> Lowest <input checked="" type="checkbox"/> Middle <input checked="" type="checkbox"/> Highest	GFSK Π/4DQPSK 8DPSK	<input checked="" type="checkbox"/> Middle	Compliant
§15.247(a)(1)	Spectrum bandwidth of aFHSS system 20dB bandwidth	GFSK Π/4DQPSK 8DPSK	<input checked="" type="checkbox"/> Lowest <input checked="" type="checkbox"/> Middle <input checked="" type="checkbox"/> Highest	GFSK Π/4DQPSK 8DPSK	<input checked="" type="checkbox"/> Lowest <input checked="" type="checkbox"/> Middle <input checked="" type="checkbox"/> Highest	Compliant
§15.247(b)(1)	Maximum output peak power	GFSK Π/4DQPSK 8DPSK	<input checked="" type="checkbox"/> Lowest <input checked="" type="checkbox"/> Middle <input checked="" type="checkbox"/> Highest	GFSK Π/4DQPSK 8DPSK	<input checked="" type="checkbox"/> Lowest <input checked="" type="checkbox"/> Middle <input checked="" type="checkbox"/> Highest	Compliant
§15.247(d)	Band edge compliance conducted	GFSK Π/4DQPSK 8DPSK	<input checked="" type="checkbox"/> Lowest <input checked="" type="checkbox"/> Highest	GFSK Π/4DQPSK 8DPSK	<input checked="" type="checkbox"/> Lowest <input checked="" type="checkbox"/> Highest	Compliant
§15.205	Band edge compliance radiated	GFSK Π/4DQPSK 8DPSK	<input checked="" type="checkbox"/> Lowest <input checked="" type="checkbox"/> Highest	GFSK Π/4DQPSK 8DPSK	<input checked="" type="checkbox"/> Lowest <input checked="" type="checkbox"/> Highest	Compliant
§15.247(d)	TX spurious emissions conducted	GFSK Π/4DQPSK 8DPSK	<input checked="" type="checkbox"/> Lowest <input checked="" type="checkbox"/> Middle <input checked="" type="checkbox"/> Highest	GFSK Π/4DQPSK 8DPSK	<input checked="" type="checkbox"/> Lowest <input checked="" type="checkbox"/> Middle <input checked="" type="checkbox"/> Highest	Compliant
§15.247(d)	TX spurious emissions radiated	GFSK Π/4DQPSK 8DPSK	<input checked="" type="checkbox"/> Lowest <input checked="" type="checkbox"/> Middle <input checked="" type="checkbox"/> Highest	GFSK	<input checked="" type="checkbox"/> Lowest <input checked="" type="checkbox"/> Middle <input checked="" type="checkbox"/> Highest	Compliant
§15.209(a)	TX spurious Emissions radiated Below 1GHz	GFSK Π/4DQPSK 8DPSK	<input checked="" type="checkbox"/> Lowest <input checked="" type="checkbox"/> Middle <input checked="" type="checkbox"/> Highest	GFSK	<input checked="" type="checkbox"/> Middle	Compliant
§15.107(a) §15.207	Conducted Emissions 9KHz-30 MHz	GFSK Π/4DQPSK 8DPSK	<input checked="" type="checkbox"/> Lowest <input checked="" type="checkbox"/> Middle <input checked="" type="checkbox"/> Highest	GFSK	<input checked="" type="checkbox"/> Middle	Compliant

Remark:

1. The measurement uncertainty is not included in the test result.
2. We tested all test mode and recorded worst case in report

### 3.5 Statement of the measurement uncertainty

The data and results referenced in this document are true and accurate. The reader is cautioned that there may be errors within the calibration limits of the equipment and facilities. The measurement uncertainty was calculated for all measurements listed in this test report acc. to TR-100028-01 "Electromagnetic compatibility and Radio spectrum Matters (ERM); Uncertainties in the measurement of mobile radio equipment characteristics; Part 1" and TR-100028-02 "Electromagnetic compatibility and Radio spectrum Matters (ERM); Uncertainties in the measurement of mobile radio equipment characteristics; Part 2" and is documented in the Shenzhen CTA Testing Technology Co., Ltd. quality system acc. to DIN EN ISO/IEC 17025. Furthermore, component and process variability of devices similar to that tested may result in additional deviation. The manufacturer has the sole responsibility of continued compliance of the device.

Hereafter the best measurement capability for Shenzhen CTA Testing Technology Co., Ltd. :

Test	Range	Measurement Uncertainty	Notes
Radiated Emission	9KHz~30MHz	3.02 dB	(1)
Radiated Emission	30~1000MHz	4.06 dB	(1)
Radiated Emission	1~18GHz	5.14 dB	(1)
Radiated Emission	18-40GHz	5.38 dB	(1)
Conducted Disturbance	0.15~30MHz	2.14 dB	(1)
Output Peak power	30MHz~18GHz	0.55 dB	(1)
Power spectral density	/	0.57 dB	(1)

Shenzhen CTA Testing Technology Co., Ltd.

Room 106, Building 1, Yibaolai Industrial Park, Qiaotou Community, Fuhai Street, Bao'an District, Shenzhen, China  
Tel:+86-755 2322 5875 E-mail:cta@cta-test.cn Web:http://www.cta-test.cn



Spectrum bandwidth	/	1.1%	(1)
Radiated spurious emission (30MHz-1GHz)	30~1000MHz	4.10 dB	(1)
Radiated spurious emission (1GHz-18GHz)	1~18GHz	4.32 dB	(1)
Radiated spurious emission (18GHz-40GHz)	18-40GHz	5.54 dB	(1)

(1) This uncertainty represents an expanded uncertainty expressed at approximately the 95% confidence level using a coverage factor of k=2.

### 3.6 Equipments Used during the Test

Test Equipment	Manufacturer	Model No.	Equipment No.	Calibration Date	Calibration Due Date
LISN	R&S	ENV216	CTA-308	2023/08/02	2024/08/01
LISN	R&S	ENV216	CTA-314	2023/08/02	2024/08/01
EMI Test Receiver	R&S	ESPI	CTA-307	2023/08/02	2024/08/01
EMI Test Receiver	R&S	ESCI	CTA-306	2023/08/02	2024/08/01
Spectrum Analyzer	Agilent	N9020A	CTA-301	2023/08/02	2024/08/01
Spectrum Analyzer	R&S	FSP	CTA-337	2023/08/02	2024/08/01
Vector Signal generator	Agilent	N5182A	CTA-305	2023/08/02	2024/08/01
Analog Signal Generator	R&S	SML03	CTA-304	2023/08/02	2024/08/01
WIDEBAND RADIO COMMUNICATION TESTER	CMW500	R&S	CTA-302	2023/08/02	2024/08/01
Temperature and humidity meter	Chigo	ZG-7020	CTA-326	2023/08/02	2024/08/01
Ultra-Broadband Antenna	Schwarzbeck	VULB9163	CTA-310	2023/10/17	2024/10/16
Horn Antenna	Schwarzbeck	BBHA 9120D	CTA-309	2023/10/13	2024/10/12
Loop Antenna	Zhinan	ZN30900C	CTA-311	2023/10/17	2024/10/16
Horn Antenna	Beijing Hangwei Dayang	OBH100400	CTA-336	2021/08/07	2024/08/06
Amplifier	Schwarzbeck	BBV 9745	CTA-312	2023/08/02	2024/08/01
Amplifier	Taiwan chengyi	EMC051845B	CTA-313	2023/08/02	2024/08/01
Directional coupler	NARDA	4226-10	CTA-303	2023/08/02	2024/08/01
High-Pass Filter	XingBo	XBLBQ-GTA18	CTA-402	2023/08/02	2024/08/01
High-Pass Filter	XingBo	XBLBQ-GTA27	CTA-403	2023/08/02	2024/08/01
Automated filter bank	Tonscend	JS0806-F	CTA-404	2023/08/02	2024/08/01
Power Sensor	Agilent	U2021XA	CTA-405	2023/08/02	2024/08/01
Amplifier	Schwarzbeck	BBV9719	CTA-406	2023/08/02	2024/08/01

Shenzhen CTA Testing Technology Co., Ltd.

Room 106, Building 1, Yibaolai Industrial Park, Qiaotou Community, Fuhai Street, Bao'an District, Shenzhen, China  
Tel:+86-755 2322 5875 E-mail:cta@cta-test.cn Web:http://www.cta-test.cn

Test Equipment	Manufacturer	Model No.	Version number	Calibration Date	Calibration Due Date
EMI Test Software	Tonscend	TS@JS32-RE	5.0.0.2	N/A	N/A
EMI Test Software	Tonscend	TS@JS32-CE	5.0.0.1	N/A	N/A
RF Test Software	Tonscend	TS@JS1120-3	3.1.65	N/A	N/A
RF Test Software	Tonscend	TS@JS1120	3.1.46	N/A	N/A

## 4 TEST CONDITIONS AND RESULTS

### 4.1 AC Power Conducted Emission

#### TEST CONFIGURATION

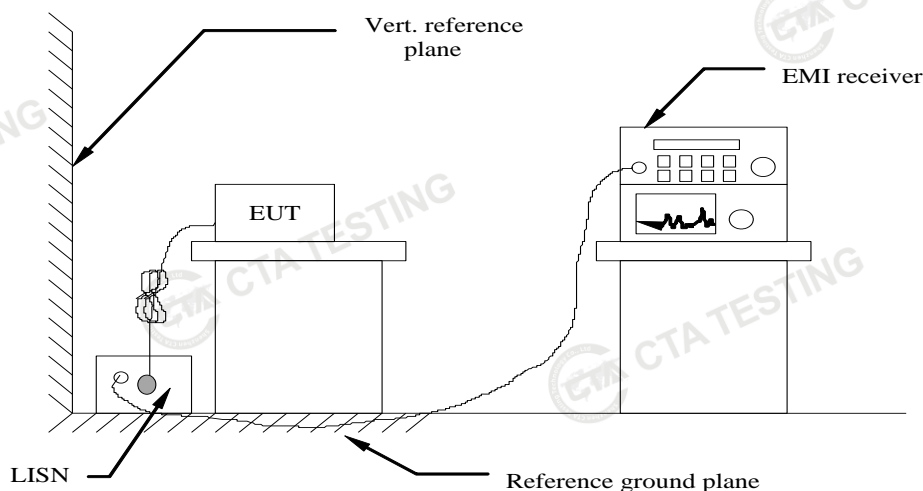

#### TEST PROCEDURE

- 1 The equipment was set up as per the test configuration to simulate typical actual usage per the user's manual. The EUT is a tabletop system, a wooden table with a height of 0.8 meters is used and is placed on the ground plane as per ANSI C63.10-2013.
- 2 Support equipment, if needed, was placed as per ANSI C63.10-2013
- 3 All I/O cables were positioned to simulate typical actual usage as per ANSI C63.10-2013
- 4 The EUT received power from adapter, the adapter received AC120V/60Hz and AC 240V/60Hz power through a Line Impedance Stabilization Network (LISN) which supplied power source and was grounded to the ground plane.
- 5 All support equipments received AC power from a second LISN, if any.
- 6 The EUT test program was started. Emissions were measured on each current carrying line of the EUT using a spectrum Analyzer / Receiver connected to the LISN powering the EUT. The LISN has two monitoring points: Line 1 (Hot Side) and Line 2 (Neutral Side). Two scans were taken: one with Line 1 connected to Analyzer / Receiver and Line 2 connected to a 50 ohm load; the second scan had Line 1 connected to a 50 ohm load and Line 2 connected to the Analyzer / Receiver.
- 7 Analyzer / Receiver scanned from 150 KHz to 30MHz for emissions in each of the test modes.
- 8 During the above scans, the emissions were maximized by cable manipulation.

#### AC Power Conducted Emission Limit

For intentional device, according to § 15.207(a) AC Power Conducted Emission Limits is as following :

Frequency range (MHz)	Limit (dBuV)	
	Quasi-peak	Average
0.15-0.5	66 to 56*	56 to 46*
0.5-5	56	46
5-30	60	50

\* Decreases with the logarithm of the frequency.

#### TEST RESULTS

Remark:

1. All modes of GFSK,  $\pi/4$  DQPSK and 8DPSK were test at Low, Middle, and High channel; only the worst result of GFSK Middle Channel was reported as below:

**Shenzhen CTA Testing Technology Co., Ltd.**

Room 106, Building 1, Yibaolai Industrial Park, Qiaotou Community, Fuhai Street, Bao'an District, Shenzhen, China  
 Tel:+86-755 2322 5875 E-mail:cta@cta-test.cn Web:http://www.cta-test.cn

2. Both 120 VAC, 50/60 Hz and 240 VAC, 50/60 Hz power supply have been tested, only the worst result of 120 VAC, 60 Hz was reported as below:

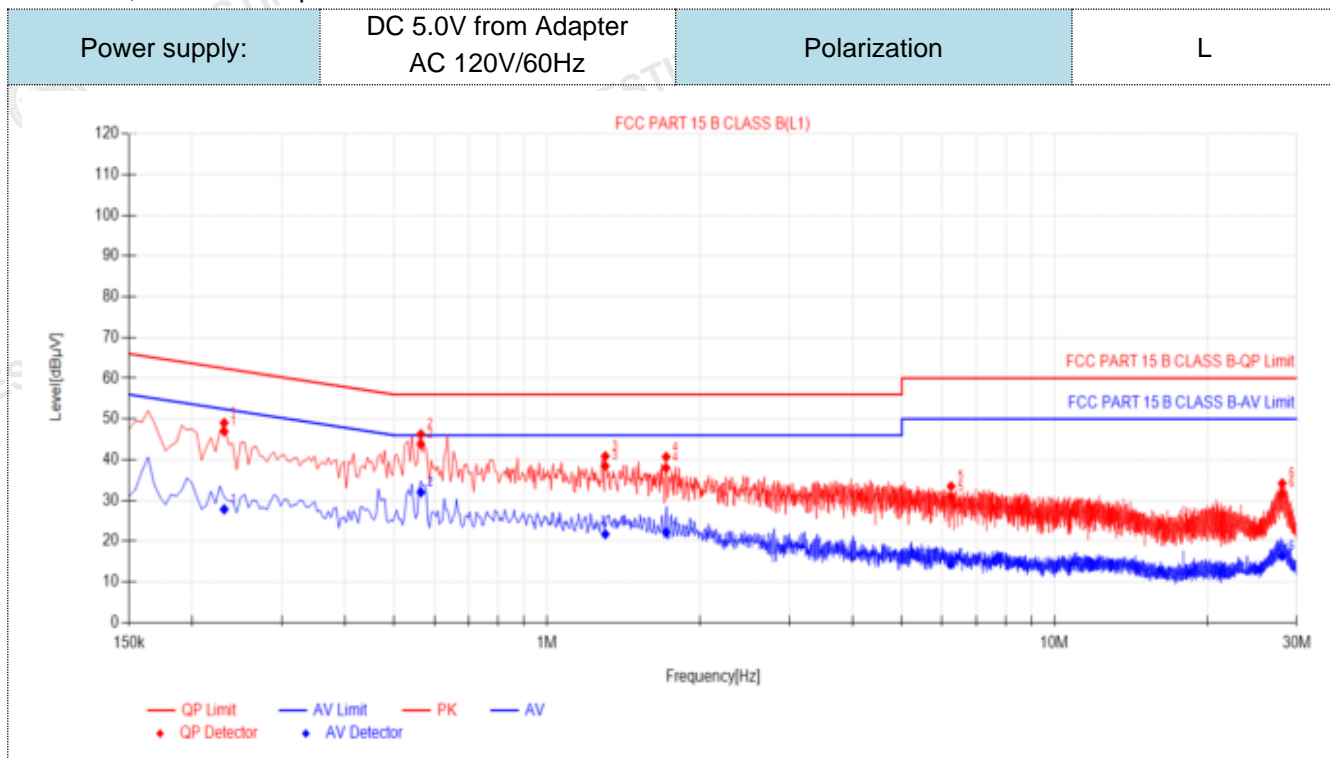

Final Data List											
NO.	Freq. [MHz]	Factor [dB]	QP Reading[dB µV]	QP Value [dBµV]	QP Limit [dBµV]	QP Margin [dB]	AV Reading [dBµV]	AV Value [dBµV]	AV Limit [dBµV]	AV Margin [dB]	Verdict
1	0.231	10.00	36.91	46.91	62.41	15.50	17.81	27.81	52.41	24.60	PASS
2	0.564	10.04	33.80	43.84	56.00	12.16	21.95	31.99	46.00	14.01	PASS
3	1.302	9.90	28.54	38.44	56.00	17.56	11.80	21.70	46.00	24.30	PASS
4	1.716	9.91	28.05	37.96	56.00	18.04	12.28	22.19	46.00	23.81	PASS
5	6.252	10.18	20.66	30.84	60.00	29.16	4.12	14.30	50.00	35.70	PASS
6	28.0905	10.58	21.06	31.64	60.00	28.36	5.74	16.32	50.00	33.68	PASS

- Note:1).QP Value (dBµV)= QP Reading (dBµV)+ Factor (dB)  
 2). Factor (dB)=insertion loss of LISN (dB) + Cable loss (dB)  
 3). QPMargin(dB) = QP Limit (dBµV) - QP Value (dBµV)  
 4). AVMargin(dB) = AV Limit (dBµV) - AV Value (dBµV)

Power supply:	DC 5.0V from Adapter AC 120V/60Hz	Polarization	N
---------------	--------------------------------------	--------------	---

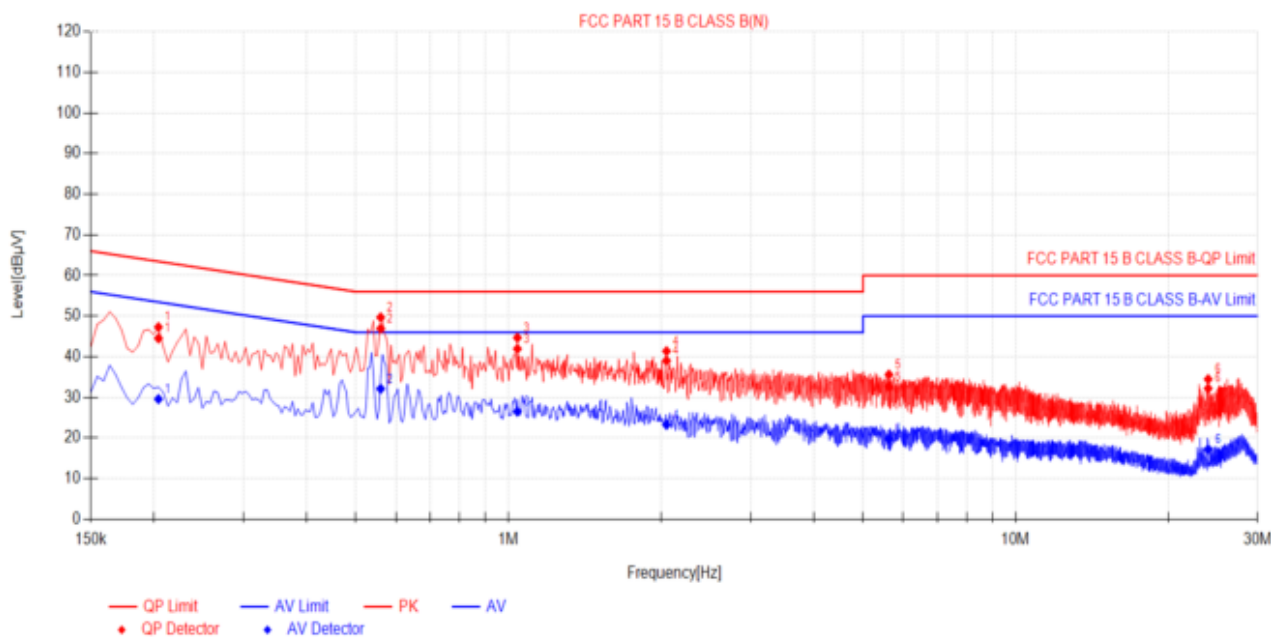

Final Data List											
NO.	Freq. [MHz]	Factor [dB]	QP Reading[dB µV]	QP Value [dBµV]	QP Limit [dBµV]	QP Margin [dB]	AV Reading [dBµV]	AV Value [dBµV]	AV Limit [dBµV]	AV Margin [dB]	Verdict
1	0.204	9.96	34.58	44.54	63.45	18.91	19.61	29.57	53.45	23.88	PASS
2	0.5595	10.10	36.84	46.94	56.00	9.06	22.00	32.10	46.00	13.90	PASS
3	1.041	10.13	31.80	41.93	56.00	14.07	16.37	26.50	46.00	19.50	PASS
4	2.049	10.18	28.85	39.03	56.00	16.97	13.05	23.23	46.00	22.77	PASS
5	5.6265	10.19	22.45	32.64	60.00	27.36	9.56	19.75	50.00	30.25	PASS
6	23.973	10.67	21.51	32.18	60.00	27.82	6.52	17.19	50.00	32.81	PASS

- Note:1). QP Value (dBµV) = QP Reading (dBµV) + Factor (dB)  
 2). Factor (dB) = insertion loss of LISN (dB) + Cable loss (dB)  
 3). QPMargin(dB) = QP Limit (dBµV) - QP Value (dBµV)  
 4). AVMargin(dB) = AV Limit (dBµV) - AV Value (dBµV)

## 4.2 Radiated Emission

### TEST CONFIGURATION

Frequency range 9 KHz – 30MHz

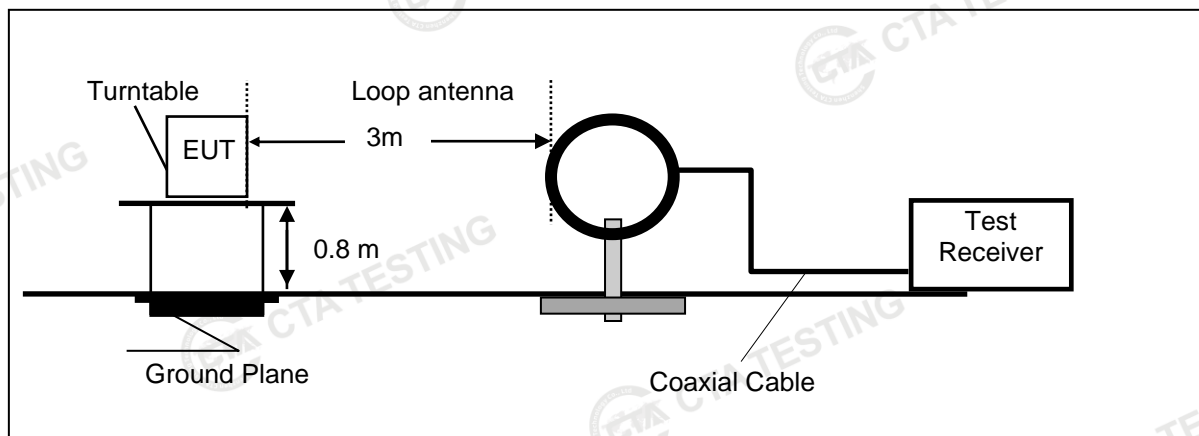

Frequency range 30MHz – 1000MHz

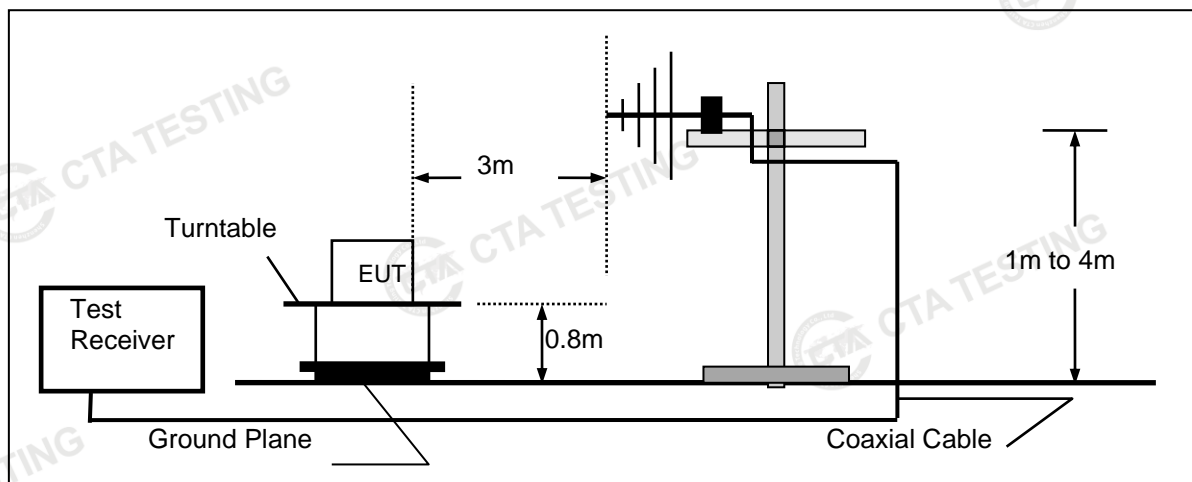

Frequency range above 1GHz-25GHz

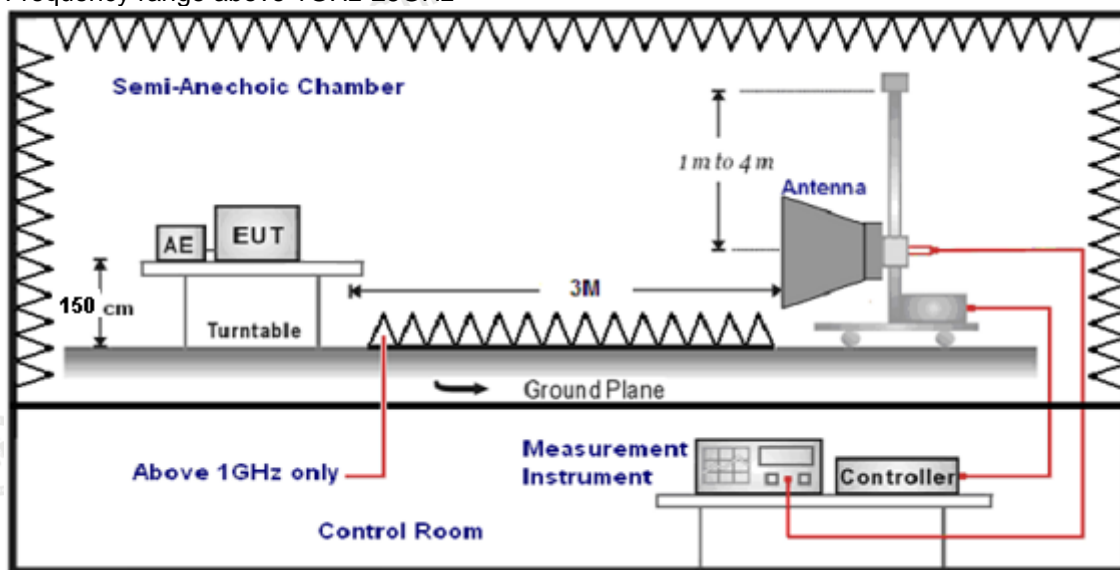

**TEST PROCEDURE**

1. The EUT was placed on a turn table which is 0.8m above ground plane when testing frequency range 9 KHz –1GHz;the EUT was placed on a turn table which is 1.5m above ground plane when testing frequency range 1GHz – 25GHz.
2. Maximum procedure was performed by raising the receiving antenna from 1m to 4m and rotating the turn table from 0° to 360° to acquire the highest emissions from EUT.
3. And also, each emission was to be maximized by changing the polarization of receiving antenna both horizontal and vertical.
4. Repeat above procedures until all frequency measurements have been completed.
5. Radiated emission test frequency band from 9KHz to 25GHz.
6. The distance between test antenna and EUT as following table states:

Test Frequency range	Test Antenna Type	Test Distance
9KHz-30MHz	Active Loop Antenna	3
30MHz-1GHz	Ultra-Broadband Antenna	3
1GHz-18GHz	Double Ridged Horn Antenna	3
18GHz-25GHz	Horn Antenna	1

7. Setting test receiver/spectrum as following table states:

Test Frequency range	Test Receiver/Spectrum Setting	Detector
9KHz-150KHz	RBW=200Hz/VBW=3KHz, Sweep time=Auto	QP
150KHz-30MHz	RBW=9KHz/VBW=100KHz, Sweep time=Auto	QP
30MHz-1GHz	RBW=120KHz/VBW=1000KHz, Sweep time=Auto	QP
1GHz-40GHz	Peak Value: RBW=1MHz/VBW=3MHz, Sweep time=Auto Average Value: RBW=1MHz/VBW=10Hz, Sweep time=Auto	Peak

**Field Strength Calculation**

The field strength is calculated by adding the Antenna Factor and Cable Factor and subtracting the Amplifier Gain and Duty Cycle Correction Factor(if any) from the measured reading. The basic equation with a sample calculation is as follows:

$$FS = RA + AF + CL - AG$$

Where FS = Field Strength	CL = Cable Attenuation Factor (Cable Loss)
RA = Reading Amplitude	AG = Amplifier Gain
AF = Antenna Factor	

$$Transd=AF +CL-AG$$

**RADIATION LIMIT**

For intentional device, according to § 15.209(a), the general requirement of field strength of radiated emission from intentional radiators at a distance of 3 meters shall not exceed the following table. According to § 15.247(d), in any 100kHz bandwidth outside the frequency band in which the EUT is operating, the radio frequency power that is produced by the intentional radiator shall be at least 20dB below that in the100kHz bandwidth within the band that contains the highest level of desired power.

The pre-test have done for the EUT in three axes and found the worst emission at position shown in test setup photos.

Frequency (MHz)	Distance (Meters)	Radiated (dBµV/m)	Radiated (µV/m)
0.009-0.49	3	20log(2400/F(KHz))+40log(300/3)	2400/F(KHz)
0.49-1.705	3	20log(24000/F(KHz))+ 40log(30/3)	24000/F(KHz)
1.705-30	3	20log(30)+ 40log(30/3)	30
30-88	3	40.0	100
88-216	3	43.5	150
216-960	3	46.0	200
Above 960	3	54.0	500

**TEST RESULTS**

Remark:

1. This test was performed with EUT in X, Y, Z position and the worse case was found when EUT in X position.
2. We measured Radiated Emission at GFSK, π/4 DQPSK and 8DPSK mode from 9 KHz to 25GHz and recorded worst case at GFSK DH5 mode.
3. For below 1GHz testing recorded worst at GFSK DH5 middle channel(powered by external circuit).
4. Radiated emission test from 9 KHz to 10th harmonic of fundamental was verified, and no emission found except system noise floor in 9 KHz to 30MHz and not recorded in this report.

**For 30MHz-1GHz**

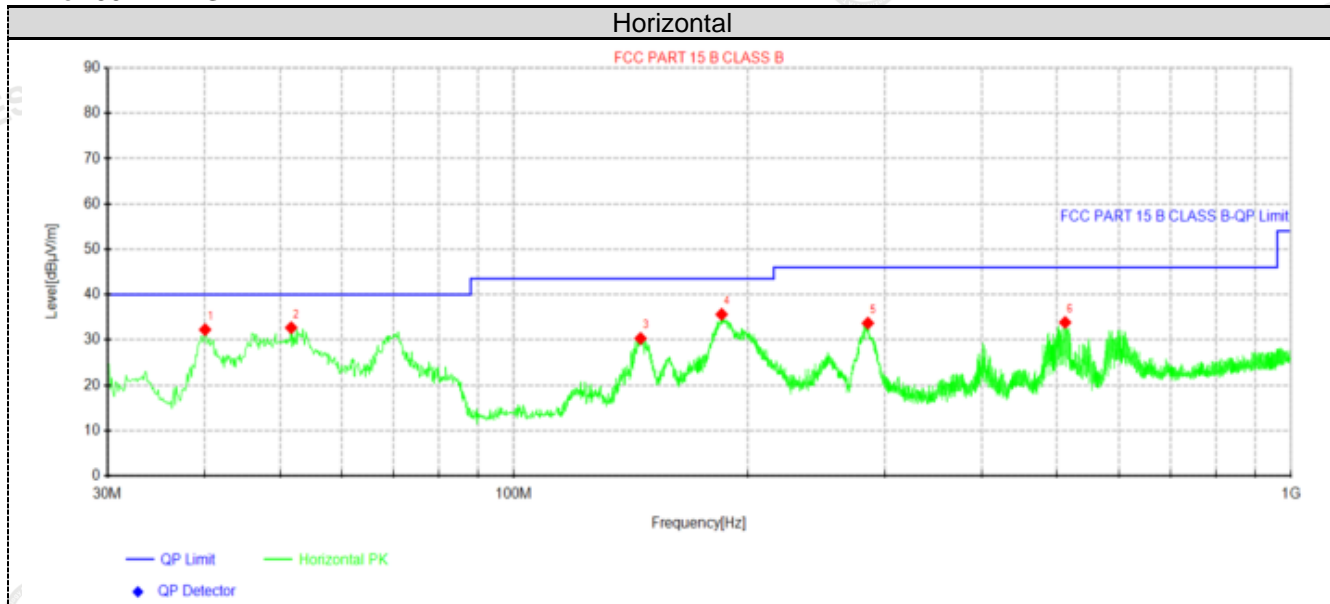

**Suspected Data List**

NO.	Freq. [MHz]	Reading [dBµV]	Level [dBµV/m]	Factor [dB/m]	Limit [dBµV/m]	Margin [dB]	Height [cm]	Angle [°]	Polarity
1	40.0638	44.49	32.26	-12.23	40.00	7.74	100	246	Horizontal
2	51.7038	44.30	32.69	-11.61	40.00	7.31	100	269	Horizontal
3	145.551	46.39	30.32	-16.07	43.50	13.18	100	258	Horizontal
4	185.078	50.37	35.64	-14.73	43.50	7.86	100	94	Horizontal
5	285.473	45.54	33.70	-11.84	46.00	12.30	100	305	Horizontal
6	512.09	43.03	33.86	-9.17	46.00	12.14	100	199	Horizontal

Note:1).Level (dBµV/m)= Reading (dBµV)+ Factor (dB/m)

2). Factor(dB/m)=Antenna Factor (dB/m) + Cable loss (dB) - Pre Amplifier gain (dB)

3). Margin(dB) = Limit (dBµV/m) - Level (dBµV/m)



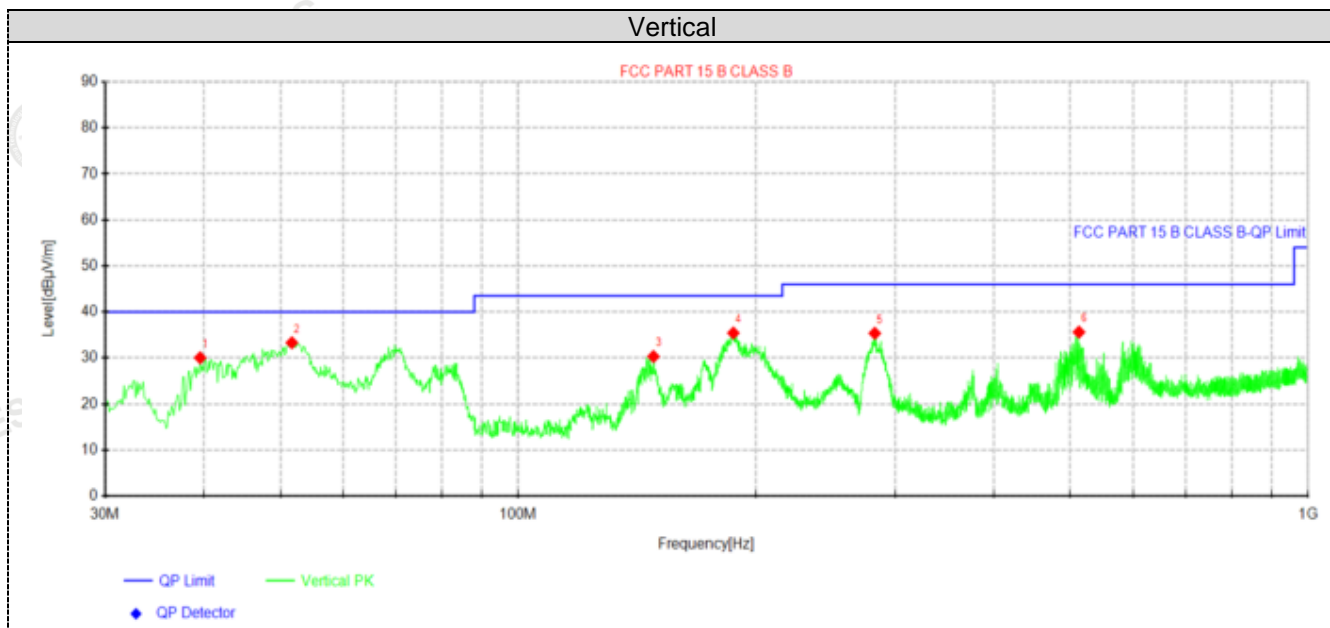

Suspected Data List									
NO.	Freq. [MHz]	Reading [dBµV]	Level [dBµV/m]	Factor [dB/m]	Limit [dBµV/m]	Margin [dB]	Height [cm]	Angle [°]	Polarity
1	39.5788	42.42	30.04	-12.38	40.00	9.96	100	265	Vertical
2	51.7038	44.93	33.32	-11.61	40.00	6.68	100	253	Vertical
3	148.34	46.31	30.32	-15.99	43.50	13.18	100	3	Vertical
4	187.261	49.84	35.43	-14.41	43.50	8.07	100	10	Vertical
5	282.806	47.26	35.37	-11.89	46.00	10.63	100	356	Vertical
6	512.817	44.77	35.62	-9.15	46.00	10.38	100	360	Vertical

Note:1). Level (dBµV/m) = Reading (dBµV) + Factor (dB/m)

2). Factor (dB/m) = Antenna Factor (dB/m) + Cable loss (dB) - Pre Amplifier gain (dB)

3). Margin (dB) = Limit (dBµV/m) - Level (dBµV/m)

## For 1GHz to 25GHz

Note: GFSK ,  $\pi/4$  DQPSK and 8DPSK all have been tested, only worse case GFSK is reported.

## GFSK (above 1GHz)

Frequency(MHz):			2402		Polarity:		HORIZONTAL		
Frequency (MHz)	Emission Level (dBuV/m)		Limit (dBuV/m)	Margin (dB)	Raw Value (dBuV)	Antenna Factor (dB/m)	Cable Factor (dB)	Pre-amplifier (dB)	Correction Factor (dB/m)
4804.00	61.76	PK	74	12.24	66.03	32.33	5.12	41.72	-4.27
4804.00	45.32	AV	54	8.68	49.59	32.33	5.12	41.72	-4.27
7206.00	52.83	PK	74	21.17	53.35	36.6	6.49	43.61	-0.52
7206.00	42.22	AV	54	11.78	42.74	36.6	6.49	43.61	-0.52

Frequency(MHz):			2402		Polarity:		VERTICAL		
Frequency (MHz)	Emission Level (dBuV/m)		Limit (dBuV/m)	Margin (dB)	Raw Value (dBuV)	Antenna Factor (dB/m)	Cable Factor (dB)	Pre-amplifier (dB)	Correction Factor (dB/m)
4804.00	59.72	PK	74	14.28	63.99	32.33	5.12	41.72	-4.27
4804.00	42.94	AV	54	11.06	47.21	32.33	5.12	41.72	-4.27
7206.00	50.24	PK	74	23.76	50.76	36.6	6.49	43.61	-0.52
7206.00	40.33	AV	54	13.67	40.85	36.6	6.49	43.61	-0.52

Frequency(MHz):			2441		Polarity:		HORIZONTAL		
Frequency (MHz)	Emission Level (dBuV/m)		Limit (dBuV/m)	Margin (dB)	Raw Value (dBuV)	Antenna Factor (dB/m)	Cable Factor (dB)	Pre-amplifier (dB)	Correction Factor (dB/m)
4882.00	60.75	PK	74	13.25	64.63	32.6	5.34	41.82	-3.88
4882.00	44.80	AV	54	9.20	48.68	32.6	5.34	41.82	-3.88
7323.00	53.56	PK	74	20.44	53.67	36.8	6.81	43.72	-0.11
7323.00	41.64	AV	54	12.36	41.75	36.8	6.81	43.72	-0.11

Frequency(MHz):			2441		Polarity:		VERTICAL		
Frequency (MHz)	Emission Level (dBuV/m)		Limit (dBuV/m)	Margin (dB)	Raw Value (dBuV)	Antenna Factor (dB/m)	Cable Factor (dB)	Pre-amplifier (dB)	Correction Factor (dB/m)
4882.00	58.96	PK	74	15.04	62.84	32.6	5.34	41.82	-3.88
4882.00	42.58	AV	54	11.42	46.46	32.6	5.34	41.82	-3.88
7323.00	51.25	PK	74	22.75	51.36	36.8	6.81	43.72	-0.11
7323.00	39.75	AV	54	14.25	39.86	36.8	6.81	43.72	-0.11

Frequency(MHz):			2480		Polarity:		HORIZONTAL		
Frequency (MHz)	Emission Level (dBuV/m)		Limit (dBuV/m)	Margin (dB)	Raw Value (dBuV)	Antenna Factor (dB/m)	Cable Factor (dB)	Pre-amplifier (dB)	Correction Factor (dB/m)
4960.00	60.01	PK	74	13.99	63.09	32.73	5.66	41.47	-3.08
4960.00	44.23	AV	54	9.77	47.31	32.73	5.66	41.47	-3.08
7440.00	53.74	PK	74	20.26	53.29	37.04	7.25	43.84	0.45
7440.00	41.83	PK	54	12.17	41.38	37.04	7.25	43.84	0.45

Frequency(MHz):			2480		Polarity:		VERTICAL		
Frequency (MHz)	Emission Level (dBuV/m)		Limit (dBuV/m)	Margin (dB)	Raw Value (dBuV)	Antenna Factor (dB/m)	Cable Factor (dB)	Pre-amplifier (dB)	Correction Factor (dB/m)
4960.00	58.10	PK	74	15.90	61.18	32.73	5.66	41.47	-3.08
4960.00	42.17	AV	54	11.83	45.25	32.73	5.66	41.47	-3.08
7440.00	51.58	PK	74	22.42	51.13	37.04	7.25	43.84	0.45
7440.00	40.11	PK	54	13.89	39.85	37.04	7.25	43.84	0.45

Shenzhen CTA Testing Technology Co., Ltd.

Room 106, Building 1, Yibaolai Industrial Park, Qiaotou Community, Fuhai Street, Bao'an District, Shenzhen, China

Tel:+86-755 2322 5875 E-mail:cta@cta-test.cn Web:http://www.cta-test.cn

## REMARKS:

1. Emission level (dBuV/m) =Raw Value (dBuV)+Correction Factor (dB/m)
2. Correction Factor (dB/m) = Antenna Factor (dB/m)+Cable Factor (dB)- Pre-amplifier
3. Margin value = Limit value- Emission level.
4. -- Mean the PK detector measured value is below average limit.
5. The other emission levels were very low against the limit.

**Results of Band Edges Test (Radiated)**

Note: GFSK,  $\pi/4$  DQPSK and 8DPSK all have been tested, only worse case GFSK is reported.

**GFSK**

Frequency(MHz):			2402		Polarity:		HORIZONTAL		
Frequency (MHz)	Emission Level (dBuV/m)		Limit (dBuV/m)	Margin (dB)	Raw Value (dBuV)	Antenna Factor (dB/m)	Cable Factor (dB)	Pre-amplifier (dB)	Correction Factor (dB/m)
2390.00	62.04	PK	74	11.96	72.46	27.42	4.31	42.15	-10.42
2390.00	43.20	AV	54	10.80	53.62	27.42	4.31	42.15	-10.42
Frequency(MHz):			2402		Polarity:		VERTICAL		
Frequency (MHz)	Emission Level (dBuV/m)		Limit (dBuV/m)	Margin (dB)	Raw Value (dBuV)	Antenna Factor (dB/m)	Cable Factor (dB)	Pre-amplifier (dB)	Correction Factor (dB/m)
2390.00	59.61	PK	74	14.39	70.03	27.42	4.31	42.15	-10.42
2390.00	40.19	AV	54	13.81	50.61	27.42	4.31	42.15	-10.42
Frequency(MHz):			2480		Polarity:		HORIZONTAL		
Frequency (MHz)	Emission Level (dBuV/m)		Limit (dBuV/m)	Margin (dB)	Raw Value (dBuV)	Antenna Factor (dB/m)	Cable Factor (dB)	Pre-amplifier (dB)	Correction Factor (dB/m)
2483.50	61.18	PK	74	12.82	71.29	27.7	4.47	42.28	-10.11
2483.50	42.20	AV	54	11.80	52.31	27.7	4.47	42.28	-10.11
Frequency(MHz):			2480		Polarity:		VERTICAL		
Frequency (MHz)	Emission Level (dBuV/m)		Limit (dBuV/m)	Margin (dB)	Raw Value (dBuV)	Antenna Factor (dB/m)	Cable Factor (dB)	Pre-amplifier (dB)	Correction Factor (dB/m)
2483.50	58.64	PK	74	15.36	68.75	27.7	4.47	42.28	-10.11
2483.50	40.50	AV	54	13.50	50.61	27.7	4.47	42.28	-10.11

## REMARKS:

1. Emission level (dBuV/m) =Raw Value (dBuV)+Correction Factor (dB/m)
2. Correction Factor (dB/m) = Antenna Factor (dB/m)+Cable Factor (dB)- Pre-amplifier
3. Margin value = Limit value- Emission level.
4. -- Mean the PK detector measured value is below average limit.
5. The other emission levels were very low against the limit.

### 4.3 Maximum Peak Output Power

**Limit**

The Maximum Peak Output Power Measurement is 125mW (20.97).

**Test Procedure**

Remove the antenna from the EUT and then connect a low loss RF cable from the antenna port to the powersensor.

**Test Configuration**



**Test Results**

Type	Channel	Output power (dBm)	Limit (dBm)	Result
GFSK	00	-1.61	20.97	Pass
	39	0.58		
	78	0.79		
π/4DQPSK	00	-0.14	20.97	Pass
	39	-0.67		
	78	2.45		
8DPSK	00	0.40	20.97	Pass
	39	2.29		
	78	2.58		

Note: 1.The test results including the cable lose.

### 4.4 20dB Bandwidth

**Limit**

For frequency hopping systems operating in the 2400MHz-2483.5MHz no limit for 20dB bandwidth.

**Test Procedure**

The transmitter output was connected to the spectrum analyzer through an attenuator. The bandwidth of the fundamental frequency was measured by spectrum analyzer with 30 KHz RBW and 100 KHz VBW.

The 20dB bandwidth is defined as the total spectrum the power of which is higher than peak power minus 20dB.

**Test Configuration**

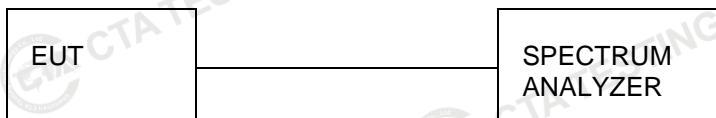

**Test Results**

Modulation	Channel	20dB bandwidth (MHz)	Result
GFSK	CH00	0.948	Pass
	CH39	0.954	
	CH78	0.927	
π/4DQPSK	CH00	1.311	
	CH39	1.281	
	CH78	1.290	
8DPSK	CH00	1.299	
	CH39	1.320	
	CH78	1.320	

Test plot as follows:

### GFSK Modulation

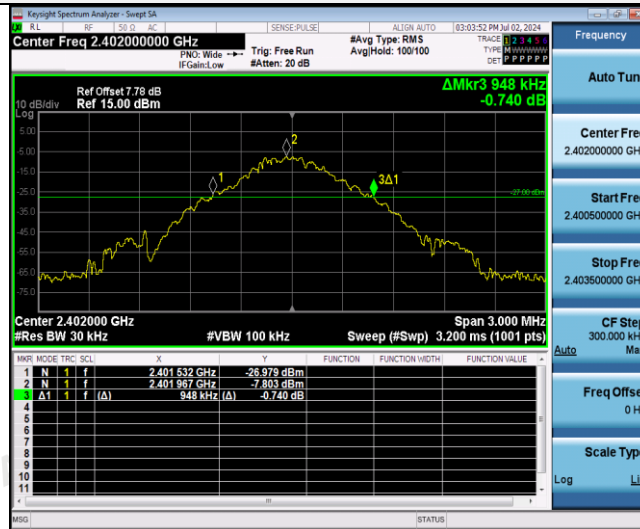

### CH00



### CH39



### CH78

$\pi/4$ DQPSK Modulation

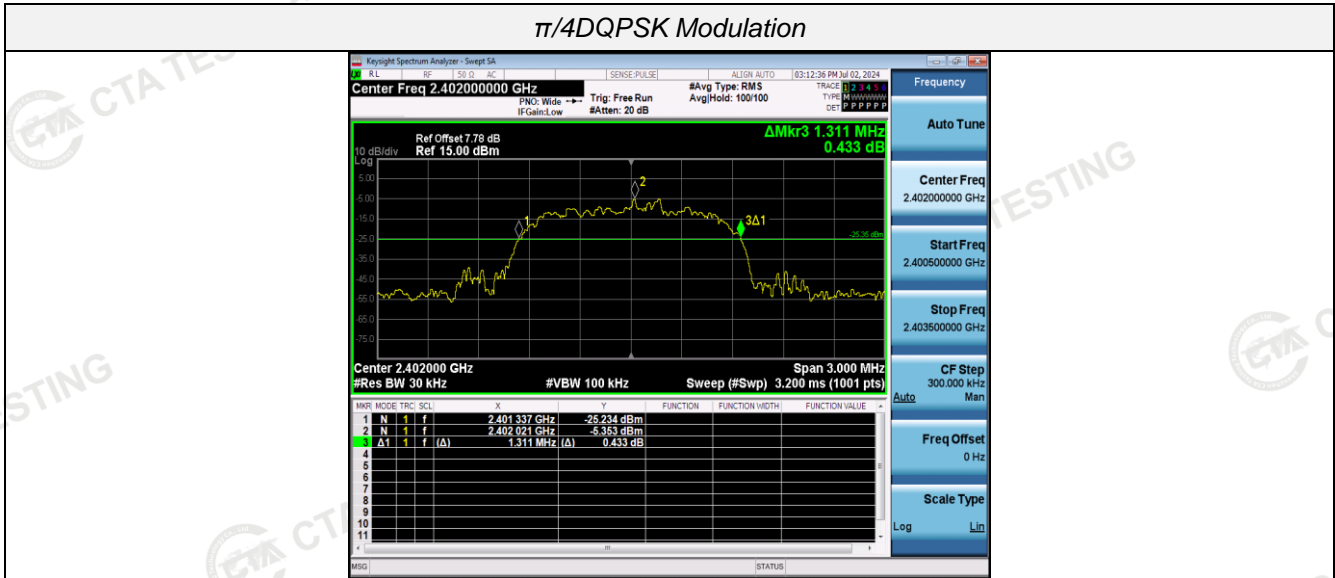

CH00



CH39

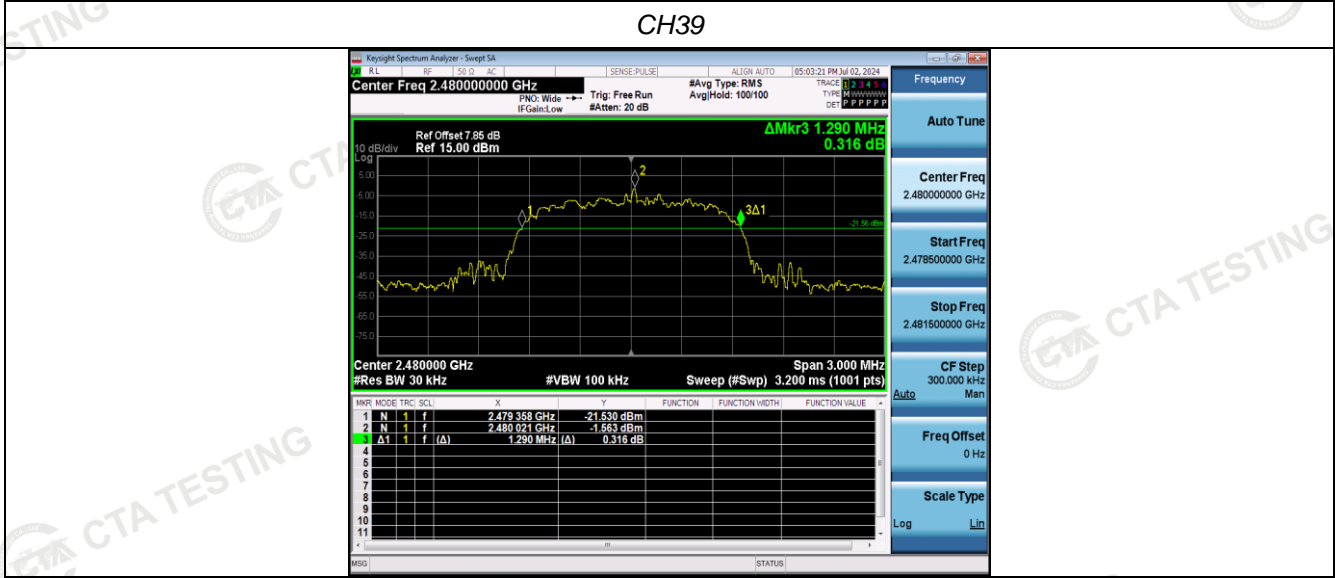

CH78

8DPSK Modulation



CH00



CH39



CH78



### 4.5 Frequency Separation

**LIMIT**

According to 15.247(a)(1), frequency hopping systems shall have hopping channel carrier frequencies separated by minimum of 25KHz or the  $2/3 \times 20\text{dB}$  bandwidth of the hopping channel, whichever is greater.

**TEST PROCEDURE**

The transmitter output was connected to the spectrum analyzer through an attenuator. The bandwidth of the fundamental frequency was measured by spectrum analyzer with 100 KHz RBW and 300 KHz VBW.

**TEST CONFIGURATION**



**TEST RESULTS**

Modulation	Channel	Channel Separation (MHz)	Limit(MHz)	Result
GFSK	CH38	1.008	25KHz or $2/3 \times 20\text{dB}$ bandwidth	Pass
	CH39			
$\pi/4$ DQPSK	CH38	1.040	25KHz or $2/3 \times 20\text{dB}$ bandwidth	Pass
	CH39			
8DPSK	CH38	0.956	25KHz or $2/3 \times 20\text{dB}$ bandwidth	Pass
	CH39			

Note:

We have tested all mode at high, middle and low channel, and recorded worst case at middle

**Test plot as follows:**

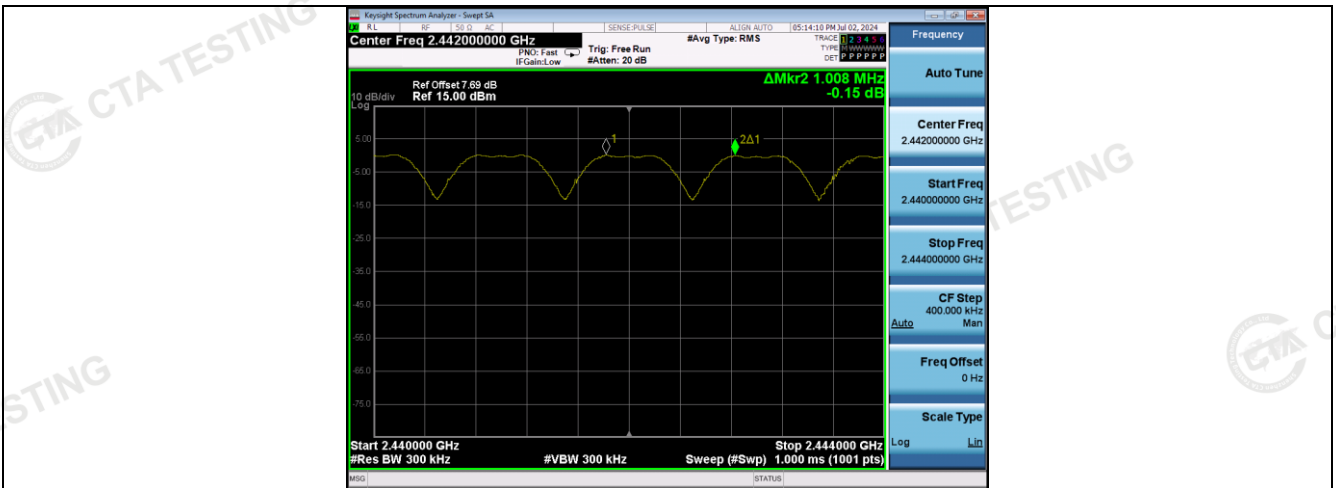

GFSK

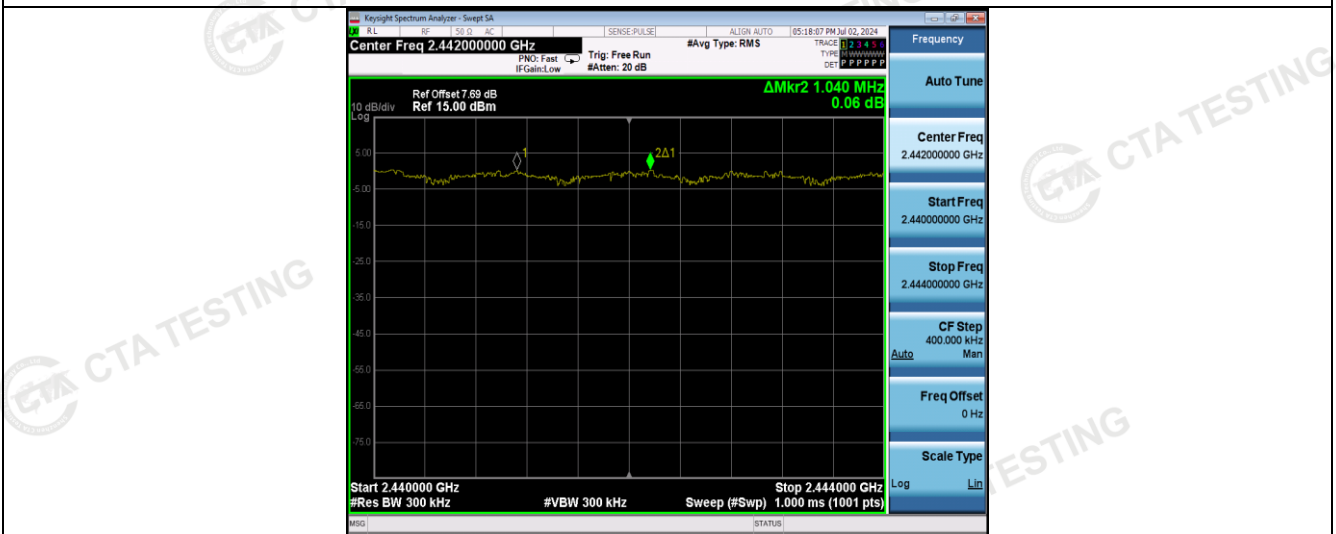

$\pi/4$ DQPSK

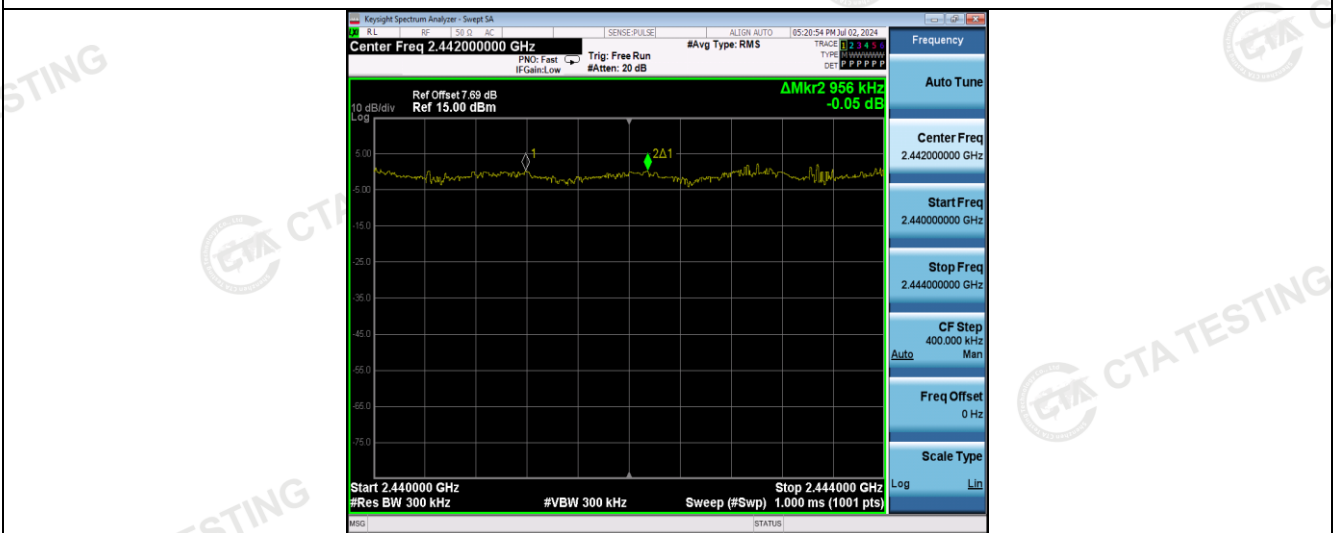

8DPSK

### 4.6 Number of hopping frequency

**Limit**

Frequency hopping systems in the 2400–2483.5 MHz band shall use at least 15 channels.

**Test Procedure**

The transmitter output was connected to the spectrum analyzer through an attenuator. Set spectrum analyzer start 2400MHz to 2483.5MHz with 100 KHz RBW and 300 KHz VBW.

**Test Configuration**



**Test Results**

Modulation	Number of Hopping Channel	Limit	Result
GFSK	79	≥15	Pass
$\pi/4$ DQPSK	79		
8DPSK	79		

**Test plot as follows:**

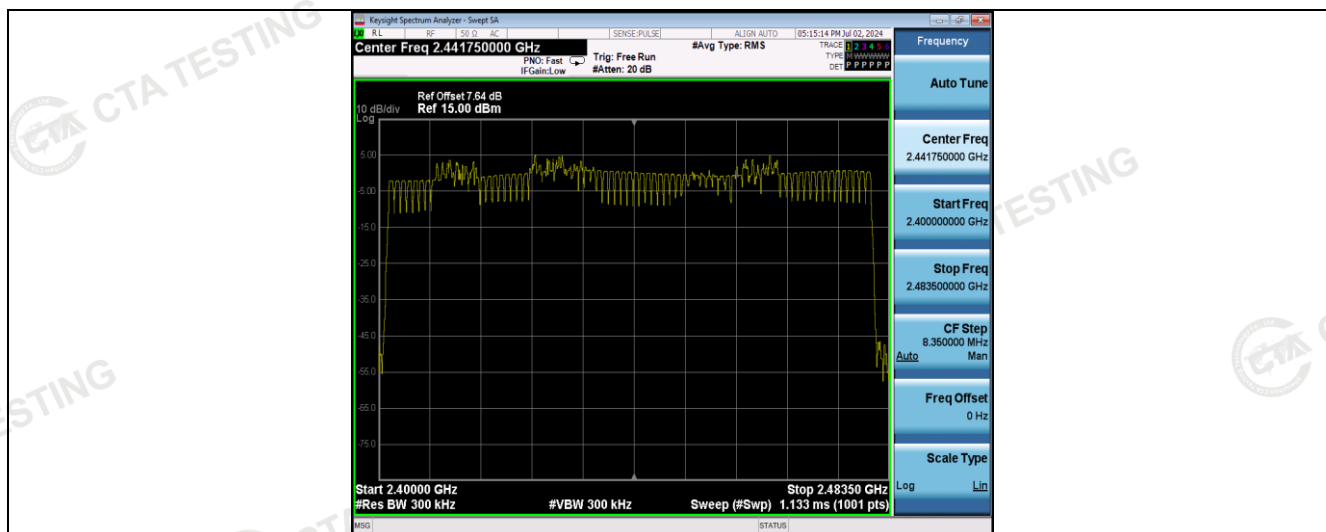

GFSK Modulation

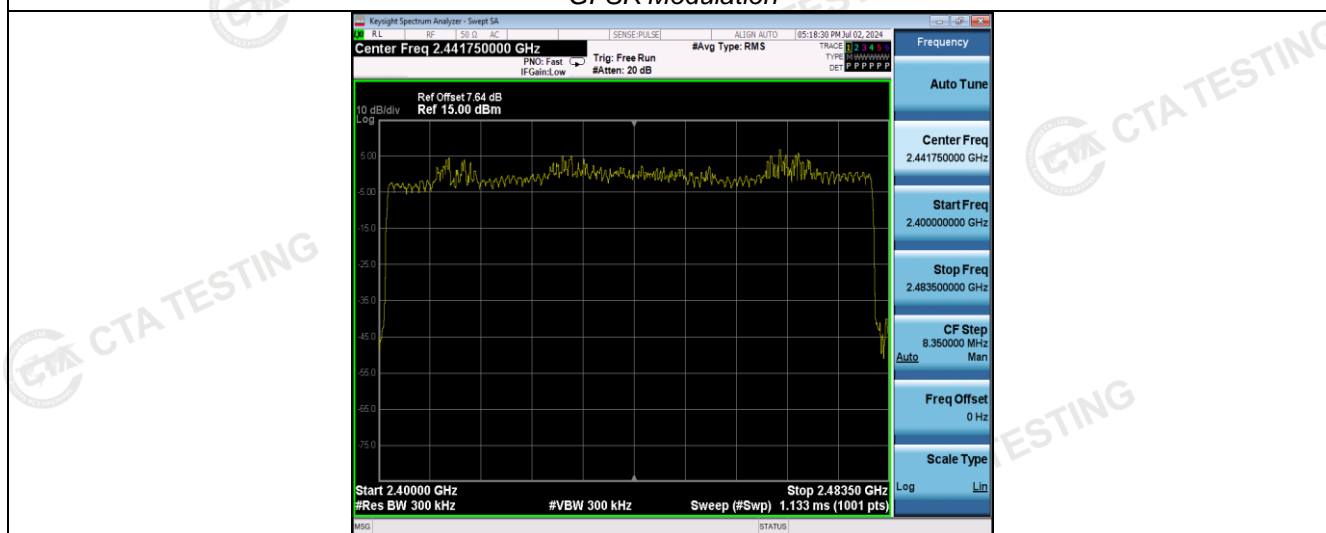

$\pi/4$ DQPSK Modulation

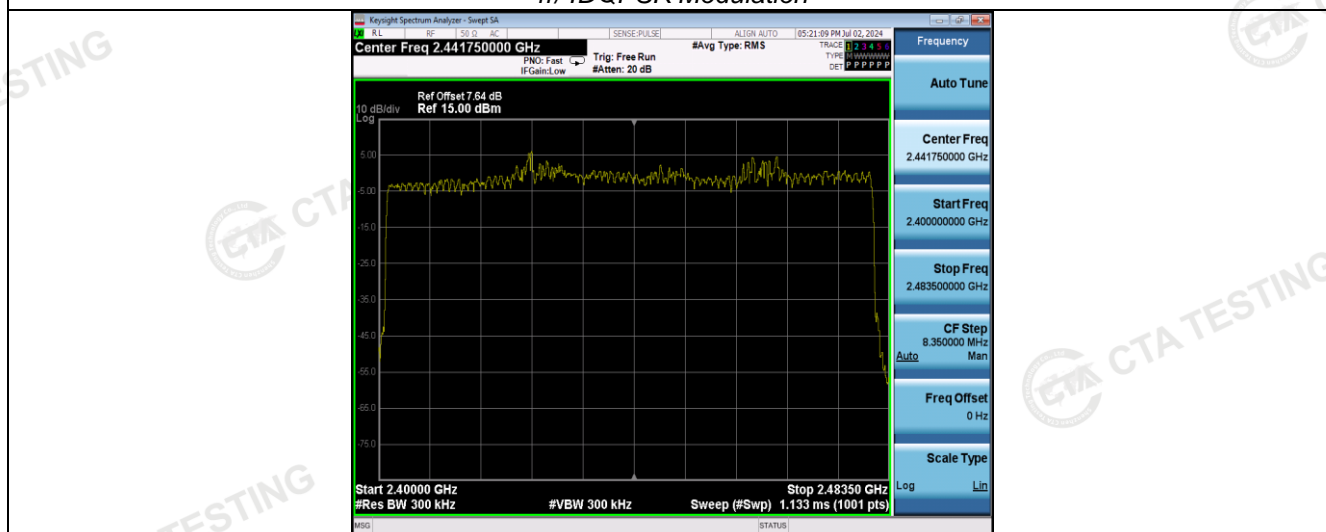

8DPSK Modulation

### 4.7 Time of Occupancy (Dwell Time)

**Limit**

The average time of occupancy on any channel shall not be greater than 0.4 seconds within a period of 0.4 seconds multiplied by the number of hopping channels employed.

**Test Procedure**

The transmitter output was connected to the spectrum analyzer through an attenuator. Set center frequency of spectrum analyzer=operating frequency with 1MHz RBW and 1MHz VBW, Span 0Hz.

**Test Configuration**



**Test Results**

Modulation	Packet	Burst time (ms)	Dwell time (s)	Limit (s)	Result
GFSK	DH1	0.39	0.125	0.40	Pass
	DH3	1.64	0.262		
	DH5	2.89	0.308		
π/4DQPSK	2-DH1	0.38	0.122	0.40	Pass
	2-DH3	1.64	0.262		
	2-DH5	2.88	0.307		
8DPSK	3-DH1	0.38	0.122	0.40	Pass
	3-DH3	1.64	0.262		
	3-DH5	2.88	0.307		

Note: We have tested all mode at high, middle and low channel, and recorded worst case at middle channel.

Dwell time = Pulse time (ms) × (1600 ÷ 2 ÷ 79) × 31.6 Second for DH1, 2-DH1, 3-DH1

Dwell time = Pulse time (ms) × (1600 ÷ 4 ÷ 79) × 31.6 Second for DH3, 2-DH3, 3-DH3

Dwell time = Pulse time (ms) × (1600 ÷ 6 ÷ 79) × 31.6 Second for DH5, 2-DH5, 3-DH5

Test plot as follows:

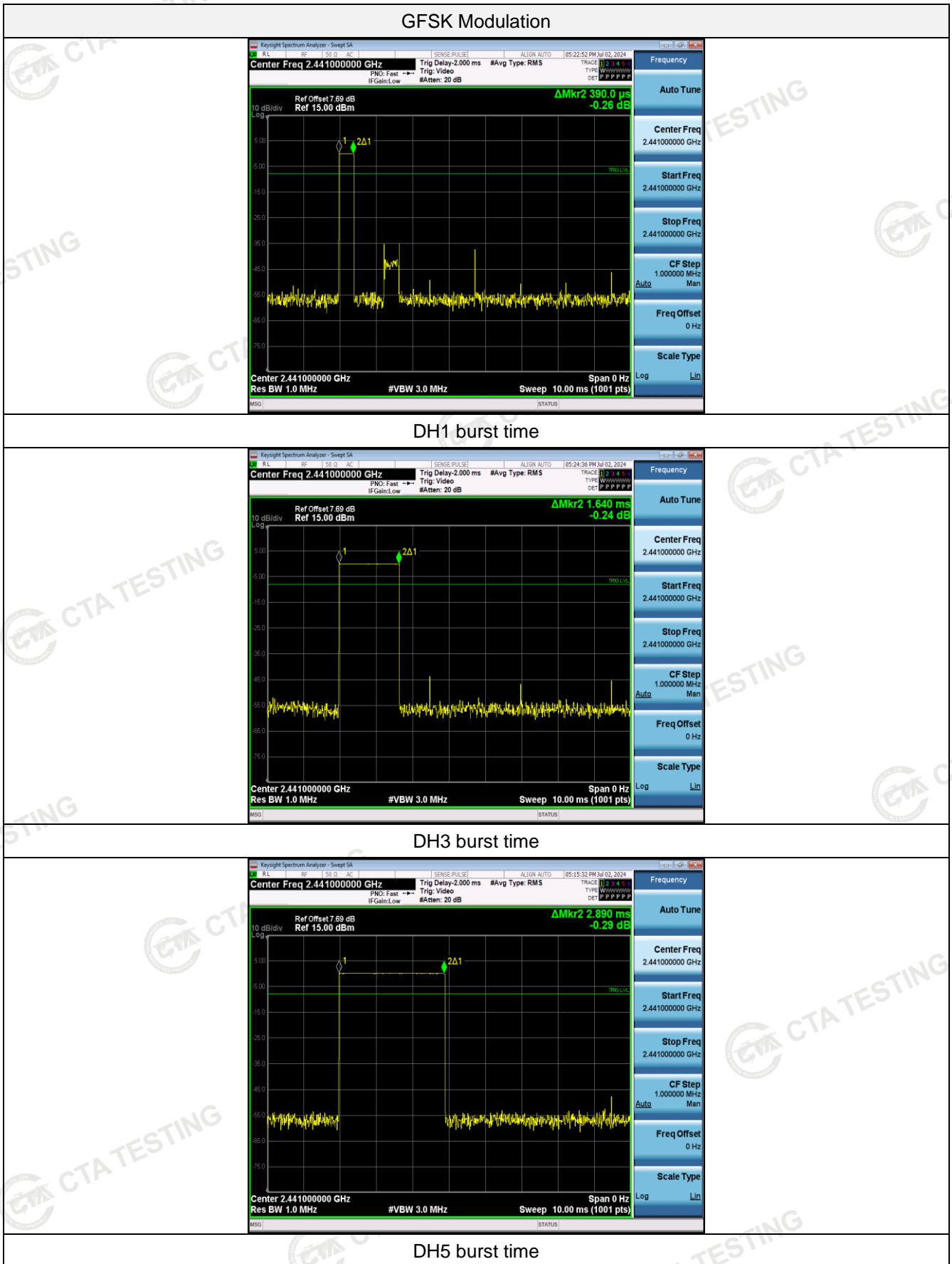

### $\pi/4$ DQPSK Modulation

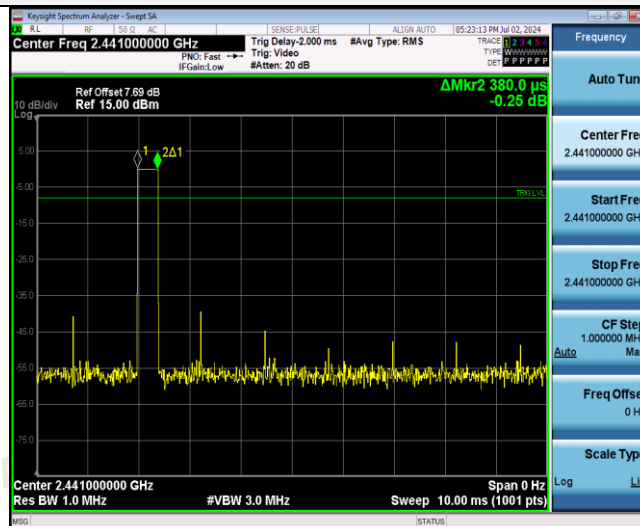

2-DH1 burst time

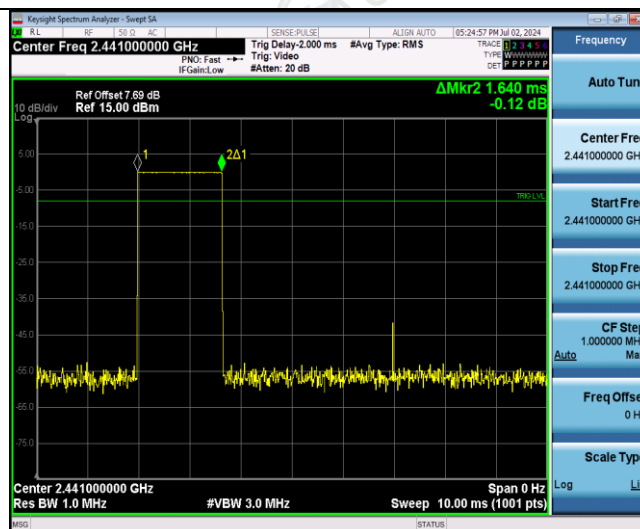

2-DH3 burst time

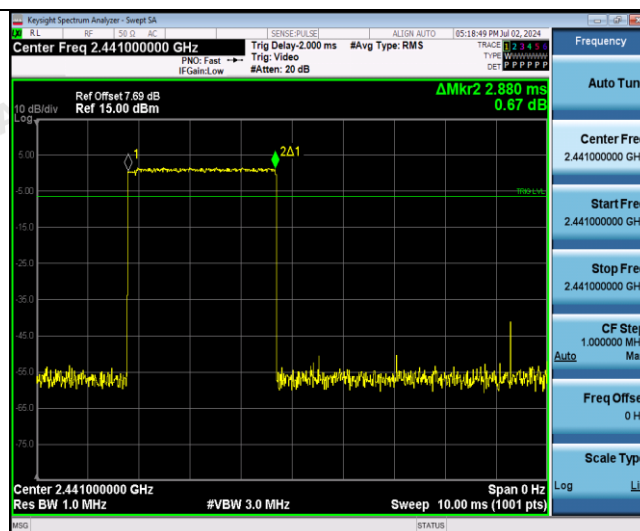

2-DH5 burst time

### 8DPSK Modulation

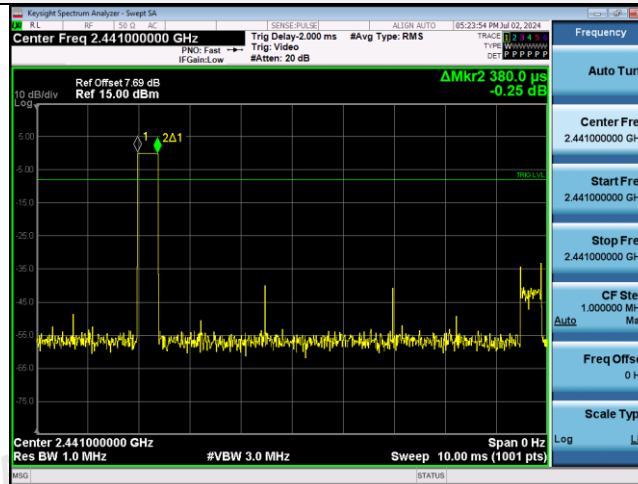

### 3-DH1 burst time

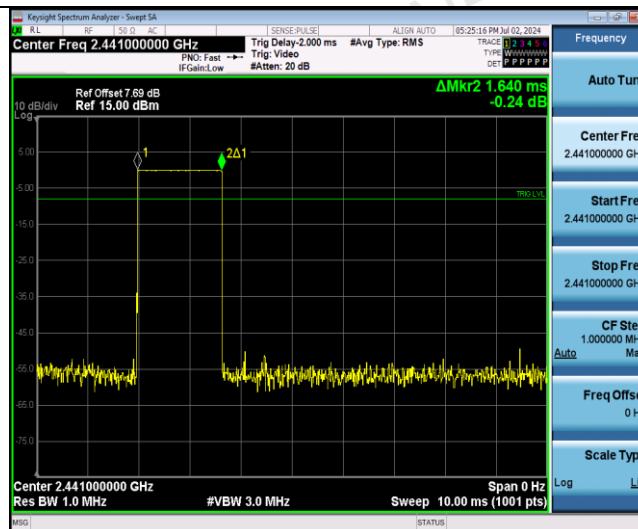

### 3-DH3 burst time

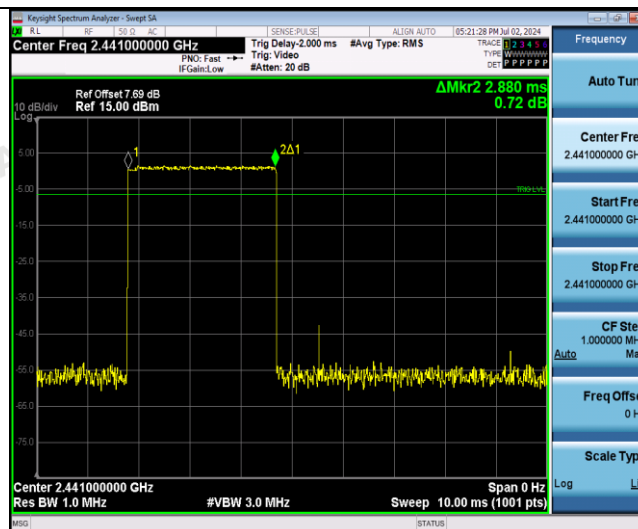

### 3-DH5 burst time



## 4.8 Out-of-band Emissions

### Limit

In any 100 kHz bandwidth outside the frequency band in which the spread spectrum or digitally modulated intentional radiator is operating, the radio frequency power that is produced by the intentional radiator shall be at least 20 dB below that in the 100 kHz bandwidth within the band that contains the highest level of the desired power, based on either an RF conducted or a radiated measurement, provided the transmitter demonstrates compliance with the peak conducted power limits. If the transmitter complies with the conducted power limits based on the use of RMS averaging over a time interval, as permitted under paragraph (b)(3) of this section, the attenuation required under this paragraph shall be 30 dB instead of 20 dB. Attenuation below the general limits specified in §15.209(a) is not required.

### Test Procedure

Connect the transmitter output to spectrum analyzer using a low loss RF cable, and set the spectrum analyzer to RBW=100 kHz, VBW= 300 kHz, peak detector, and max hold. Measurements utilizing these settings are made of the in-band reference level, bandedge and out-of-band emissions.

### Test Configuration

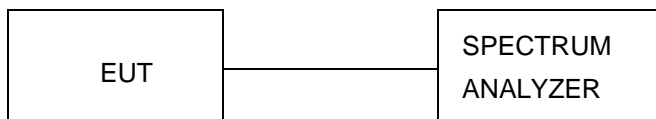

### Test Results

Remark: The measurement frequency range is from 30MHz to the 10th harmonic of the fundamental frequency. The lowest, middle and highest channels are tested to verify the spurious emissions and bandage measurement data.

We measured all conditions (DH1, DH3, DH5) and recorded worst case at DH5

Test plot as follows:

