

Dongguan Lixinwei Electronics Co., Ltd

Antenna Specification for Approval

Customer Name: 方珩电子

Address: _____

Product Name: 2.4G antenna

Part NO. : C113H-BT44-25-90R

Write By: Zhou Min

Issued Date: 2023-09-8

Customer:

R&D Dept	Business Dept	Approved By

Supplier

R&D Dept	Engineer Dept	Approval
Ni Sheng	Zhang Ming	xiong

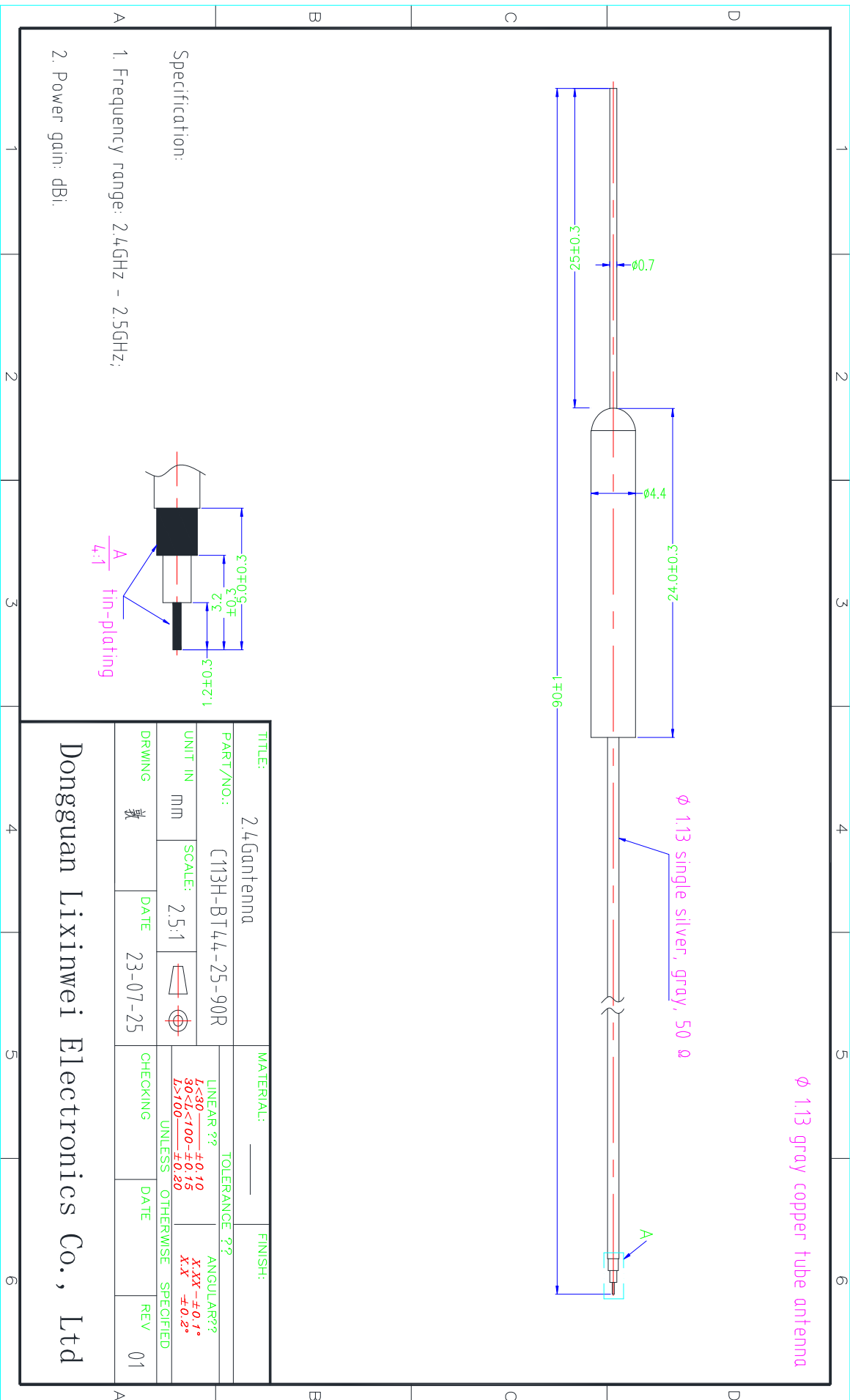

- Specification:
1. Frequency range: 2.4GHz - 2.5GHz;
 2. Power gain: dBi.

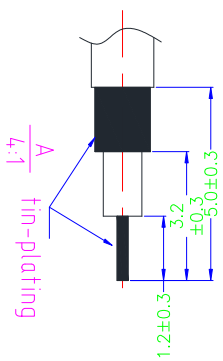

TITLE: 2.4Gantenna		MATERIAL: _____		FINISH: _____	
PART/NO.: C113H-BT44-25-90R		TOLERANCE ??			
UNIT IN mm	SCALE: 2.5:1	LINEAR ??	ANGULAR??		
		L<30 ±0.10	XXX ±0.1°		
		30<L<100 ±0.15	XX ±0.1°		
		L>100 ±0.20	XX ±0.2°		
DRAWING 数		DATE 23-07-25	CHECKING	DATE	REV 01
Dongguan Lixinwei Electronics Co., Ltd					

Product Specification

A. Electrical Characteristics

Frequency 2400MHz ~2500MHz

VSWR <2.0

Efficiency >65%

Impedance 50 Ohm

Polarization Line

Gain 1.97DBi

B. Material & Mechanical Characteristics

Material of Radiator Cu

Cable Type 1.13 黑色

Connector Type : IPEX1

Dimension

C. Environmental

Operation Temperature - 30 °C ~ + 80 °C

Storage Temperature - 30 °C ~ + 85 °C

Test Equipment & Conditions

1. Network Analyzers :

Agilent 8753D 5071B

2. Communications Test Set:

Agilent E5515C

3. 3D Chamber Test System

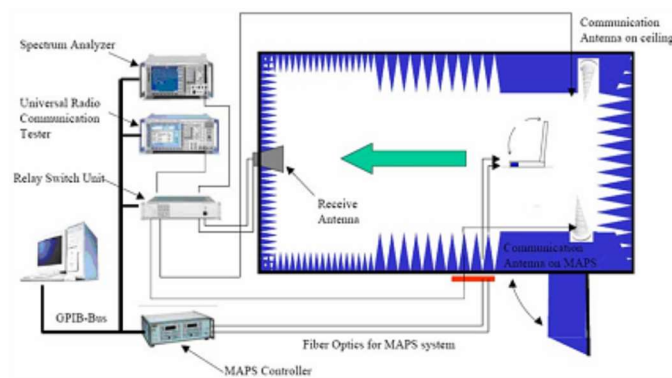

(Testing by 3D anechoic chamber)

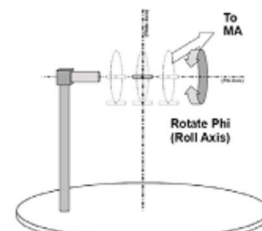

Phi axis test

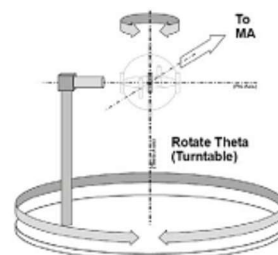

Theta axis test

Efficiency & Gain

Freq (MHz)	Effi (%)	Gain (dBi)
2400	57.97	1.4
2410	64.83	1.86
2420	54.67	1.8
2430	65.56	1.97
2440	56.69	1.51
2450	52.08	1.73
2460	51.84	1.86
2470	52.93	1.80
2480	52.46	1.78
2490	58.44	1.72
2500	57.45	1.33

S11

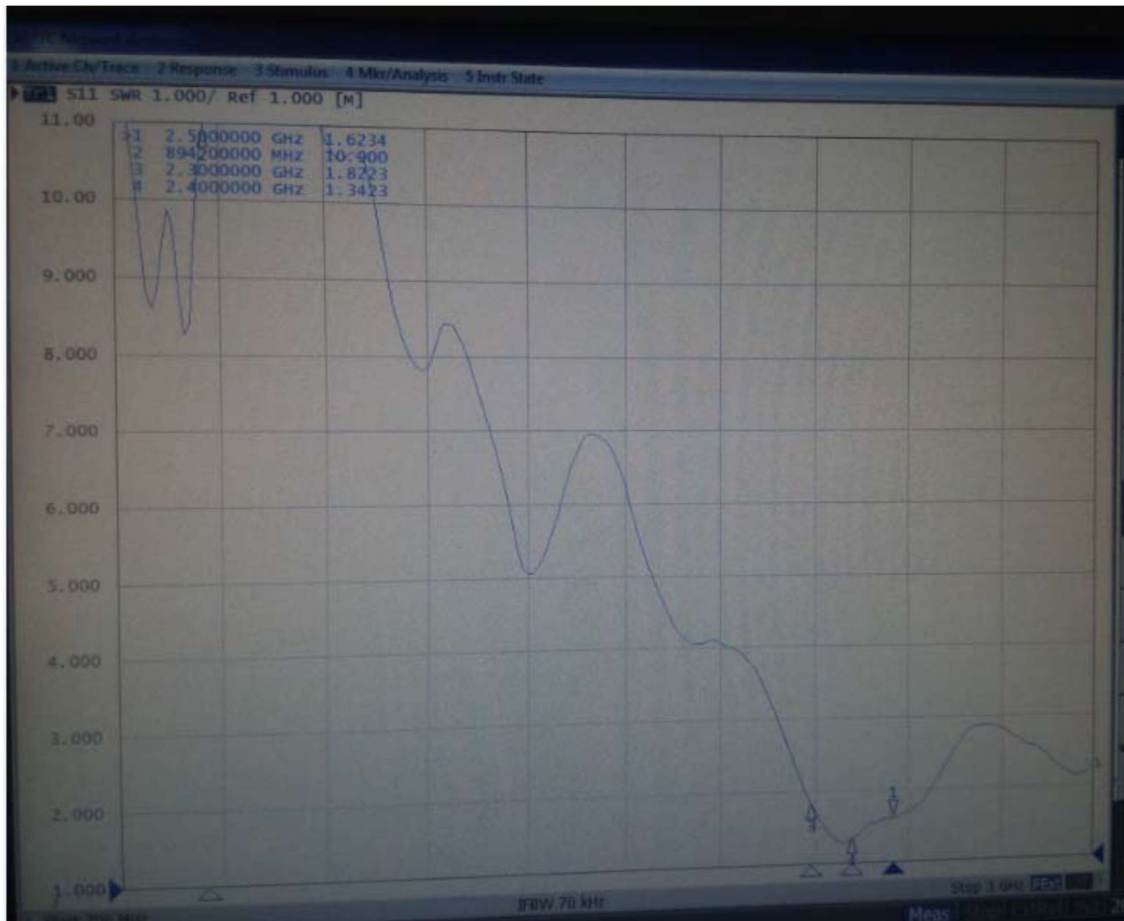

Radiation Pattern:

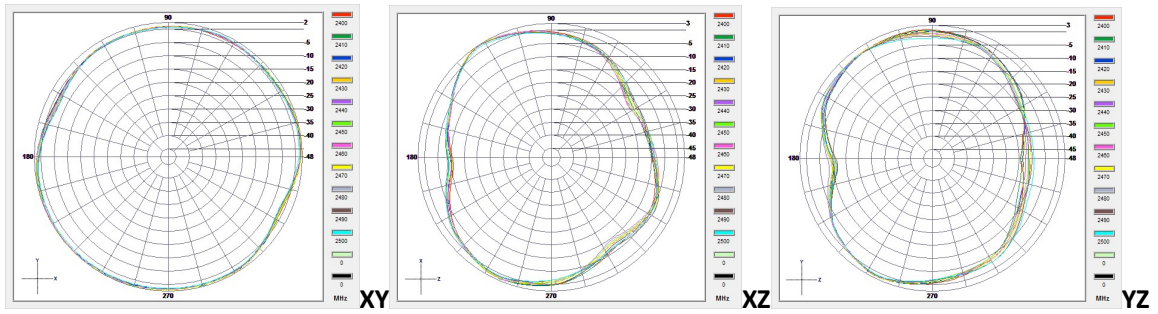

2400 2410 2420 2430 2440 2450 2460 2470 2480 2490 2500

