



深圳市迪比通通讯设备有限公司

Shenzhen DBT Telecommunication Technology CO.,LTD

深圳市南山区桃源街道南山云谷二期8栋505

505, Building 8, Nanshan Yungu Phase II, Taoyuan Street, Nanshan District, Shenzhen, China

天线测试报告

Antenna report

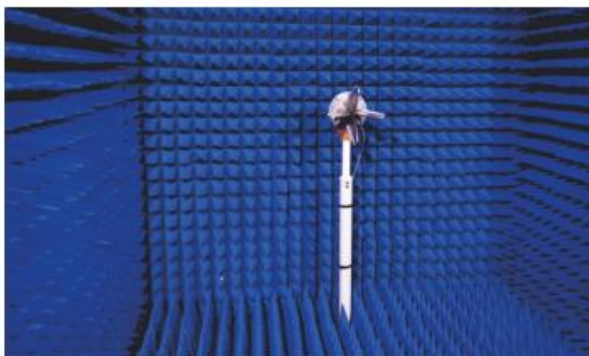

OTA-800

品牌：ETS ✓

频率范围：370MHz-8.5GHz

功能：无源、有源测试；G网、C网、2G/3G/4G，WIFI，BT等制式TRP、TIS测试。

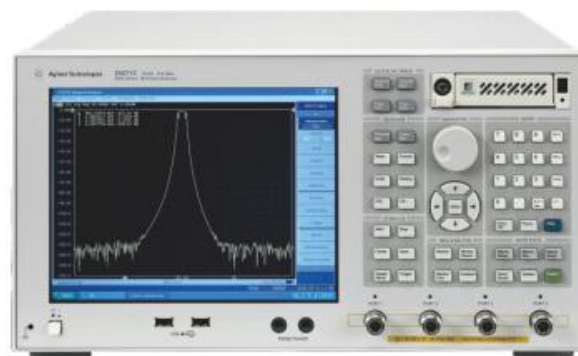

5071C

品牌：安捷伦 ✓

频率范围：9KHz-8.5GHz

功能：2G/3G/4G/BT/WIFI等天线综合无源测试。



8960

品牌：安捷伦

频率范围：292MHz-2700GHz

功能：满足2G/3G有源测试。



CMW500

品牌：罗德与施瓦茨

频率范围：70KHz-6GHz

功能：2G/3G/4G/BT/WIFI/NB-Lot等天线综合有源测试。

3.天线装配位置实物图

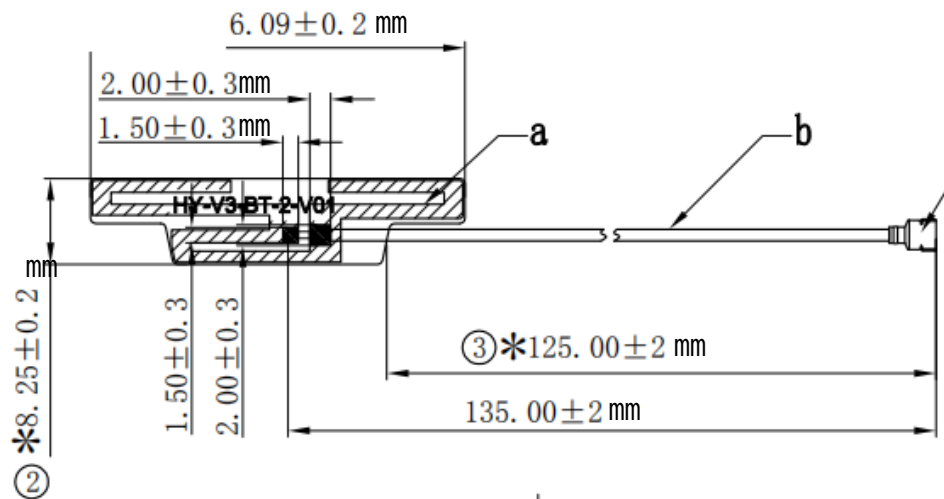

②

③

天线尺寸

4.电性能指标



电性能指标 Electrical Parameter		
频率范围(MHz)	Frequency Range (MHz)	2400~2500
电压驻波比	VSWR	≤7.0
输入阻抗(Ω)	Input Impedance(Ω)	50
增益(dBi)	Gain(dBi)	0.89
极化形式($^{\circ}$)	Polarization($^{\circ}$)	vertical
最大功率(W)	Max power(W)	10
天线类型	Antenna Type	FPC
工作温度($^{\circ}\text{C}$)	Working Temperature($^{\circ}\text{C}$)	-40~+80

5. 天线无源数据



6.天线增益/效率/3D苹果图

Freq (MHz)	Effi (%)	Gain (dBi)
2400	1.6	0.89
2410	1.36	0.87
2420	1.77	0.86
2430	1.45	0.85
2440	1.42	0.79
2450	1.18	0.78
2460	1.63	0.77
2470	1.01	0.76
2480	1	0.69
2490	0.73	0.61
2500	1.42	0.67

2400.000MHz

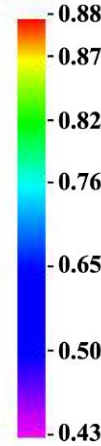
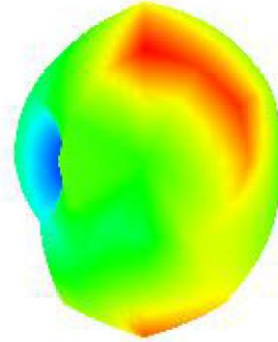

2450.000MHz

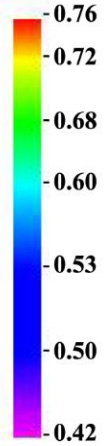
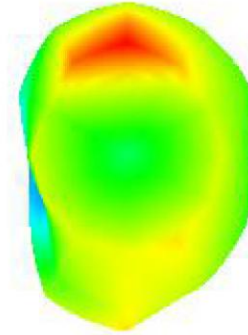

2500.000MHz

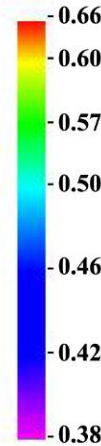
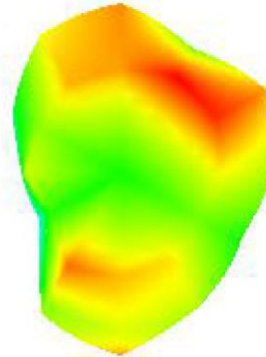

7.天线方向图

2400.000MHz H

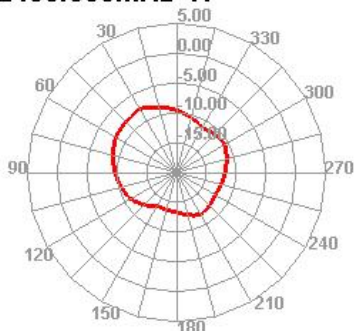

2400.000MHz E1

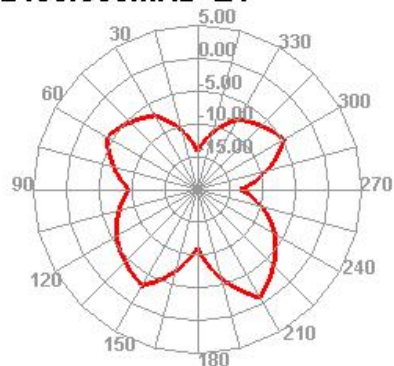

2400.000MHz E2

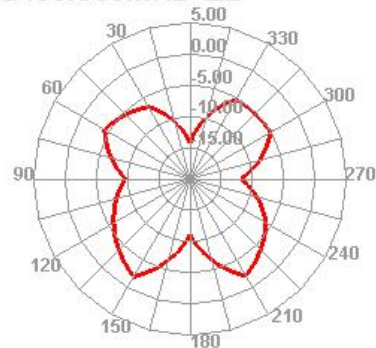

2450.000MHz H

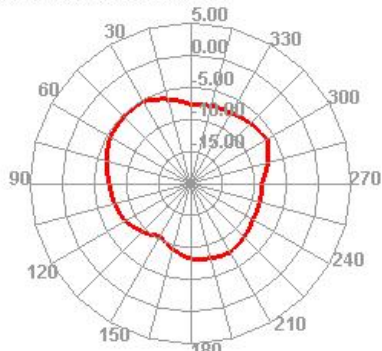

2450.000MHz E1

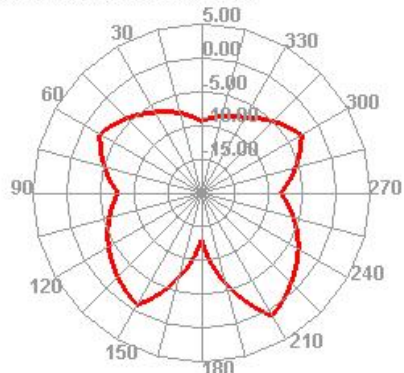

2450.000MHz E2

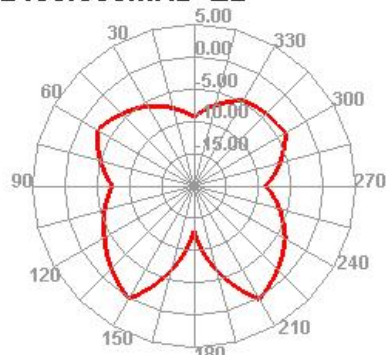

2500.000MHz H

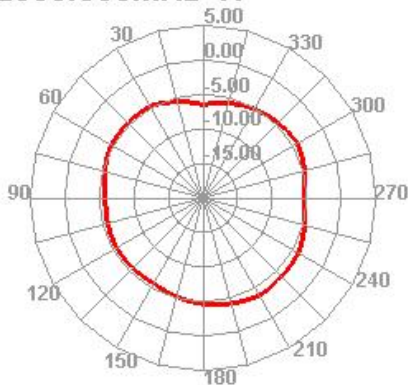

2500.000MHz E1

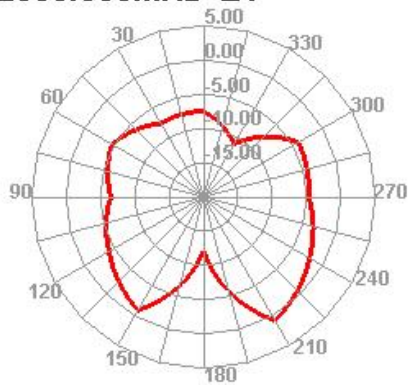

2500.000MHz E2

